

# FlashStack Data Center with VMware Horizon 7.12 and VMware vSphere 7.0 with 4<sup>th</sup> Generation Cisco UCS

Deployment Guide for Virtual Desktop Infrastructure Built on Cisco UCS B200 M5 and Cisco UCS Manager 4.0 with Pure Storage FlashArray//X70 R3Array, VMware Horizon 7.12, and VMware vSphere 7.0 Hypervisor Platform

Published: February 2021



In partnership with:



---

## About the Cisco Validated Design Program

The Cisco Validated Design (CVD) program consists of systems and solutions designed, tested, and documented to facilitate faster, more reliable, and more predictable customer deployments. For more information, go to:

<http://www.cisco.com/go/designzone>.

ALL DESIGNS, SPECIFICATIONS, STATEMENTS, INFORMATION, AND RECOMMENDATIONS (COLLECTIVELY, "DESIGNS") IN THIS MANUAL ARE PRESENTED "AS IS," WITH ALL FAULTS. CISCO AND ITS SUPPLIERS DISCLAIM ALL WARRANTIES, INCLUDING, WITHOUT LIMITATION, THE WARRANTY OF MERCHANTABILITY, FITNESS FOR A PARTICULAR PURPOSE AND NONINFRINGEMENT OR ARISING FROM A COURSE OF DEALING, USAGE, OR TRADE PRACTICE. IN NO EVENT SHALL CISCO OR ITS SUPPLIERS BE LIABLE FOR ANY INDIRECT, SPECIAL, CONSEQUENTIAL, OR INCIDENTAL DAMAGES, INCLUDING, WITHOUT LIMITATION, LOST PROFITS OR LOSS OR DAMAGE TO DATA ARISING OUT OF THE USE OR INABILITY TO USE THE DESIGNS, EVEN IF CISCO OR ITS SUPPLIERS HAVE BEEN ADVISED OF THE POSSIBILITY OF SUCH DAMAGES.

THE DESIGNS ARE SUBJECT TO CHANGE WITHOUT NOTICE. USERS ARE SOLELY RESPONSIBLE FOR THEIR APPLICATION OF THE DESIGNS. THE DESIGNS DO NOT CONSTITUTE THE TECHNICAL OR OTHER PROFESSIONAL ADVICE OF CISCO, ITS SUPPLIERS OR PARTNERS. USERS SHOULD CONSULT THEIR OWN TECHNICAL ADVISORS BEFORE IMPLEMENTING THE DESIGNS. RESULTS MAY VARY DEPENDING ON FACTORS NOT TESTED BY CISCO.

CCDE, CCENT, Cisco Eos, Cisco Lumin, Cisco Nexus, Cisco StadiumVision, Cisco TelePresence, Cisco WebEx, the Cisco logo, DCE, and Welcome to the Human Network are trademarks; Changing the Way We Work, Live, Play, and Learn and Cisco Store are service marks; and Access Registrar, Aironet, AsyncOS, Bringing the Meeting To You, Catalyst, CCDA, CCDP, CCIE, CCIP, CCNA, CCNP, CCSP, CCVP, Cisco, the Cisco Certified Inter-network Expert logo, Cisco IOS, Cisco Press, Cisco Systems, Cisco Systems Capital, the Cisco Systems logo, Cisco Unified Computing System (Cisco UCS), Cisco UCS B-Series Blade Servers, Cisco UCS C-Series Rack Servers, Cisco UCS S-Series Storage Servers, Cisco UCS Manager, Cisco UCS Management Software, Cisco Unified Fabric, Cisco Application Centric Infrastructure, Cisco Nexus 9000 Series, Cisco Nexus 7000 Series, Cisco Prime Data Center Network Manager, Cisco NX-OS Software, Cisco MDS Series, Cisco Unity, Collaboration Without Limitation, EtherFast, EtherSwitch, Event Center, Fast Step, Follow Me Browsing, FormShare, Giga-Drive, HomeLink, Internet Quotient, IOS, iPhone, iQuick Study, LightStream, Linksys, MediaTone, MeetingPlace, MeetingPlace Chime Sound, MGX, Networkers, Networking Academy, Network Registrar, PCNow, PIX, PowerPanels, ProConnect, ScriptShare, SenderBase, SMARTnet, Spectrum Expert, StackWise, The Fastest Way to Increase Your Internet Quotient, TransPath, WebEx, and the WebEx logo are registered trademarks of Cisco Systems, Inc. and/or its affiliates in the United States and certain other countries.

All other trademarks mentioned in this document or website are the property of their respective owners. The use of the word partner does not imply a partnership relationship between Cisco and any other company. (0809R)

© 2021 Cisco Systems, Inc. All rights reserved.

---

## Executive Summary

Cisco Validated Designs include systems and solutions that are designed, tested, and documented to facilitate and improve customer deployments. These designs incorporate a wide range of technologies and products into a portfolio of solutions that have been developed to address the business needs of customers. Cisco, Pure and VMware have partner to deliver this document, which serves as a specific step-by-step guide for implementing this solution. This Cisco Validated Design provides an efficient architectural design that is based on customer requirements. The solution that follows is a validated approach for deploying Cisco, Pure Storage, and VMware technologies as a shared, high performance, resilient, virtual desktop infrastructure.

This document provides a reference architecture and design guide for a 5000 to 6000 seat desktop workload end user computing environment on FlashStack Data Center with 4<sup>th</sup> Generation Cisco UCS and Pure Storage® FlashArray//X70 R3 with 100 percent DirectFlash Modules and DirectFlash Software. The solution includes VMware Horizon server-based RDS Windows Sever 2019 sessions, VMware Horizon persistent full clone Microsoft Windows 10 virtual desktops and VMware Horizon non-persistent instant-clone Microsoft Windows 10 virtual desktops on VMware vSphere ESXi 7.0 GA hypervisor.

The solution is a predesigned, best-practice data center architecture built on the FlashStack reference architecture. The FlashStack Data Center used in this validation includes Cisco Unified Computing System (Cisco UCS), the Cisco Nexus® 9000 family of switches, Cisco MDS 9000 family of Fibre Channel (FC) switches and Pure All-NVMe FlashArray//X system.

This solution is 100 percent virtualized on fifth generation Cisco UCS B200 M5 blade servers, booting VMware vSphere ESXi 7.0 GA through FC SAN from the FlashArray//X70 R3 storage array. Where applicable the document provides best practice recommendations and sizing guidelines for customer deployment of this solution.

The solution is fully capable of supporting hardware accelerated graphics workloads. The Cisco UCS B200 M5 server supports up to two NVIDIA P6 cards for high density, high-performance graphics workload support. See our Cisco Graphics White Paper for details about integrating NVIDIA GPU with VMware Horizon.

This solution provides an outstanding virtual desktop end-user experience as measured by the Login VSI 4.1.39.6 Knowledge Worker workload running in benchmark mode, providing a large-scale building block that can be replicated to confidently scale-out to tens of thousands of users.

---

## Solution Overview

### Introduction

The current industry trend in data center design is towards shared infrastructures. By using virtualization along with pre-validated IT platforms, enterprise customers have embarked on the journey to the cloud by moving away from application silos and toward shared infrastructure that can be quickly deployed, thereby increasing agility, and reducing costs. Cisco, Pure Storage, and VMware have partnered to deliver this Cisco Validated Design, which uses best of breed storage, server, and network components to serve as the foundation for desktop virtualization workloads, enabling efficient architectural designs that can be quickly and confidently deployed.

### Audience

The audience for this document includes, but is not limited to; sales engineers, field consultants, professional services, IT managers, partner engineers, and customers who want to take advantage of an infrastructure built to deliver IT efficiency and enable IT innovation.

### Purpose of this Document

This document provides a step-by-step design, configuration, and implementation guide for the Cisco Validated Design for a large-scale VMware Horizon 7.12 desktop workload solution with Pure Storage FlashArray//X array, Cisco UCS Blade Servers, Cisco Nexus 9000 series Ethernet switches and Cisco MDS 9100 series Multilayer Fibre channel switches.

### What's New in this Release?

This is the VMware Horizon 7.12 Virtual Desktop Infrastructure (VDI) deployment Cisco Validated Design with Cisco UCS 5<sup>th</sup> generation servers and Pure Storage FlashArray//X Series system.

It incorporates the following features:

- Cisco UCS B200 M5 blade servers with Intel Xeon® Gold 6230 CPU
- 64GB DDR4-2933-MHz memory
- Support for the Cisco UCS 4.1(2a) release
- Support for the latest release of Pure Storage FlashArray//X70 R3 hardware and Purity//FA v6.0.3
- Introducing FA//File capabilities
- VMware vSphere 7.0 GA Hypervisor
- VMware Horizon 7.12 Server 2019 RDS hosted server sessions
- VMware Horizon 7.12 non-persistent Instant Clone Windows 10 virtual machines
- VMware Horizon 7.12 persistent Full Clone Windows 10 virtual machines

The data center market segment is shifting toward heavily virtualized private, hybrid and public cloud computing models running on industry-standard systems. These environments require uniform design points that can be repeated for ease of management and scalability.



---

These factors have led to the need for predesigned computing, networking and storage building blocks optimized to lower the initial design cost, simplify management, and enable horizontal scalability and high levels of utilization.

The use cases include:

- Enterprise Data Center
- Service Provider Data Center
- Large Commercial Data Center

---

## Solution Summary

FlashStack provides a jointly supported solution by Cisco and Pure Storage, providing a carefully validated architecture built on superior compute, world class networking, and the leading innovations in all flash storage.



The portfolio of validated offerings from FlashStack includes but is not limited to the following:

- **Consistent performance:** FlashStack provides higher, more consistent performance than disk-based solutions and delivers a converged infrastructure based on all-flash that provides non-disruptive upgrades and scalability.
- **Cost savings:** FlashStack uses less power, cooling, and data center space when compared to legacy disk/hybrid storage. It provides industry-leading storage data reduction and exceptional storage density.
- **Simplicity:** FlashStack requires low ongoing maintenance and reduces operational overhead. It also scales simply and smoothly in step with business requirements.
- **Deployment choices:** It is available as a custom-built single unit from FlashStack partners, but organizations can also deploy using equipment from multiple sources, including equipment they already own.
- **Unique business model:** The Pure Storage Evergreen Storage Model enables companies to keep their storage investments forever, which means no more forklift upgrades and no more downtime.
- **Mission-critical resiliency:** FlashStack offers best in class performance by providing active-active resiliency, no single point of failure, and non-disruptive operations, enabling organizations to maximize productivity.

- **Support choices:** Focused, high-quality single-number reach for FlashStack support is available from FlashStack Authorized Support Partners. Single-number support is also available directly from Cisco Systems as part of the Cisco Solution Support for Data Center offering. Support for FlashStack components is also available from Cisco, VMware, and Pure Storage individually and leverages TSANet for resolution of support queries between vendors.

This Cisco Validated Design prescribes a defined set of hardware and software that serves as an integrated foundation for both VMware Horizon Microsoft Windows 10 virtual desktops and VMware Horizon RDS sessions based on Microsoft Server 2019.

The mixed workload solution includes Pure Storage FlashArray//X®, Cisco Nexus® and MDS networking, the Cisco Unified Computing System (Cisco UCS®), VMware Horizon and VMware vSphere® software in a single package. The design is space optimized such that the network, compute, and storage required can be housed in one data center rack. Switch port density enables the networking components to accommodate multiple compute and storage configurations of this kind.

The infrastructure is deployed to provide Fibre Channel-booted hosts with block-level access to shared storage. The reference architecture reinforces the "wire-once" strategy, because as additional storage is added to the architecture, no re-cabling is required from the hosts to the Cisco UCS fabric interconnect.

The combination of technologies from Cisco Systems, Inc., Pure Storage Inc., and VMware Inc. produced a highly efficient, robust, and affordable desktop virtualization solution for a hosted virtual desktop and hosted shared desktop mixed deployment supporting different use cases. Key components of this solution include the following:

- **More power, same size.** Cisco UCS B200 M5 half-width blade with dual 20-core 2.1 GHz Intel® Xeon® Scalable Family Gold (6230) processors and 768 GB of memory for VMware Horizon hosts supports more virtual desktop workloads than the previously released generation processors on the same hardware. The Intel 20-core 2.1 GHz Intel® Xeon® Gold Scalable Family (6230) processors used in this study provided a balance between increased per-blade capacity and cost.
- **Fault-tolerance with high availability built into the design.** The various designs are based on using one Unified Computing System chassis with multiple Cisco UCS B200 M5 blades for virtualized desktop and infrastructure workloads. The design provides N+1 server fault tolerance for hosted virtual desktops, hosted shared desktops and infrastructure services.
- **Stress-tested to the limits during aggressive boot scenario.** The servers hosting RDS sessions and VDI shared and statically assigned desktop environment booted and became available within very short time, providing our customers with an extremely fast, reliable cold-start desktop virtualization system.
- **Stress-tested to the limits during simulated login storms.** All simulated users logged in and started running workloads up to steady state in 48-minutes without overwhelming the processors, exhausting memory, or exhausting the storage subsystems, providing customers with a desktop virtualization system that can easily handle the most demanding login and startup storms.
- **Ultra-condensed computing for the data center.** The rack space required to support the system is less than a single 42U rack, conserving valuable data center floor space.
- **All Virtualized:** This Cisco Validated Design (CVD) presents a validated design that is 100 percent virtualized on VMware ESXi 7.0 GA. All of the virtual desktops, user data, profiles, and supporting infrastructure

---

components, including Active Directory, SQL Servers, VMware Horizon components, VDI desktops and RDS servers were hosted as virtual machines. This provides customers with complete flexibility for maintenance and capacity additions because the entire system runs on the FlashStack converged infrastructure with stateless Cisco UCS Blade servers and Pure FC storage.

- **Cisco maintains industry leadership** with the new Cisco UCS Manager 4.1(2a) software that simplifies scaling, guarantees consistency, and eases maintenance. Cisco's ongoing development efforts with Cisco UCS Manager (UCSM), Cisco UCS Central, Cisco UCS Director and Cisco Intersight ensure that customer environments are consistent locally, across Cisco UCS Domains and across the globe, our software suite offers increasingly simplified operational and deployment management, and it continues to widen the span of control for customer organizations' subject matter experts in compute, storage, and network.
- **Our 25G unified fabric story** gets additional validation on Cisco UCS 6400 Series Fabric Interconnects as Cisco runs more challenging workload testing, while maintaining unsurpassed user response times.
- **Cisco SAN architectural benefit** of the next-generation 32-Gb fabric switches address the requirement for highly scalable, virtualized, intelligent SAN infrastructure in current-generation data center environments.
- **Pure All-NVMe FlashArray//X70 R3 storage array** provides industry-leading storage solutions that efficiently handle the most demanding I/O bursts (for example, login storms), profile management, and user data management, deliver simple and flexible business continuance, and help reduce storage cost per desktop.
- **Pure All-NVMe FlashArray//X70 R3 storage array** provides a simple to understand storage architecture for hosting all user data components (virtual machines, profiles, user data) on the same storage array.
- **Pure Storage** software enables to seamlessly add, upgrade, or remove capacity and/or controllers from the infrastructure to meet the needs of the virtual desktops transparently.
- **Pure Storage Management UI** for VMware vSphere hypervisor has deep integrations with vSphere, providing easy-button automation for key storage tasks such as storage repository provisioning, storage resize, directly from vCenter.
- **VMware Horizon 7.** Latest and greatest virtual desktop and application product. VMware Horizon 7 follows a new unified product architecture that supports both hosted-shared desktops and applications (RDS) and complete virtual desktops (VDI). This new VMware Horizon release simplifies tasks associated with large-scale VDI management. This modular solution supports seamless delivery of Windows apps and desktops as the number of users increase. In addition, Horizon enhancements help to optimize performance and improve the user experience across a variety of endpoint device types, from workstations to mobile devices including laptops, tablets, and smartphones.
- **Optimized to achieve the best possible performance and scale.** For hosted shared desktop sessions, the best performance was achieved when the number of vCPUs assigned to the VMware 7 RDS virtual machines did not exceed the number of hyper-threaded (logical) cores available on the server. In other words, maximum performance is obtained when not overcommitting the CPU resources for the virtual machines running virtualized RDS systems.

- **Provisioning desktop machines made easy.** Remote Desktop Server (RDS) shared virtual machines were setup as Manual farms and VMware Horizon 7.12, Microsoft Windows 10 virtual machines were created for this solution using VMware pooled desktops.

## Cisco Desktop Virtualization Solutions: Data Center

### The Evolving Workplace

Today’s IT departments are facing a rapidly evolving workplace environment. The workforce is becoming increasingly diverse and geographically dispersed, including offshore contractors, distributed call center operations, knowledge and task workers, partners, consultants, and executives connecting from locations around the world at all times.

This workforce is also increasingly mobile, conducting business in traditional offices, conference rooms across the enterprise campus, home offices, on the road, in hotels, and at the local coffee shop. This workforce wants to use a growing array of client computing and mobile devices that they can choose based on personal preference.

These trends are increasing pressure on IT to ensure protection of corporate data and prevent data leakage or loss through any combination of user, endpoint device, and desktop access scenarios ([Figure 1](#)).

These challenges are compounded by desktop refresh cycles to accommodate aging PCs and bounded local storage and migration to new operating systems, specifically Microsoft Windows 10 and productivity tools, specifically Microsoft Office 2019.

Figure 1. Cisco Data Center Partner Collaboration

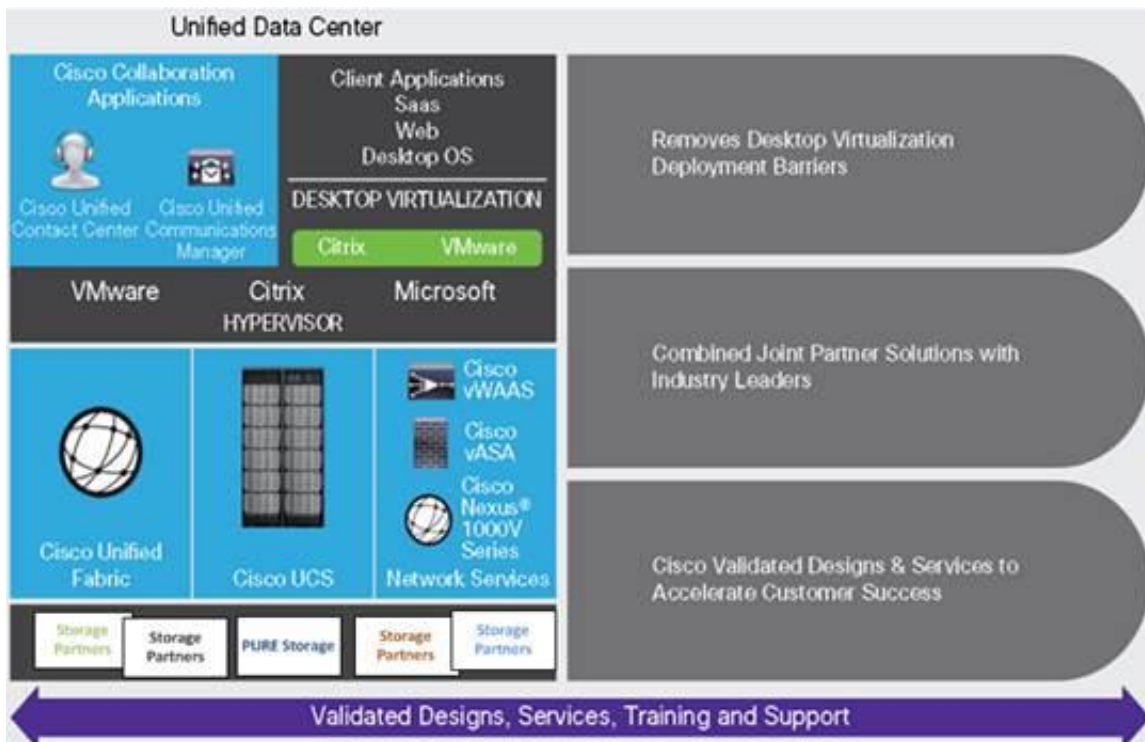



---

Some of the key drivers for desktop virtualization are increased data security and reduced TCO through increased control and reduced management costs.

## Cisco Desktop Virtualization Focus

Cisco focuses on three key elements to deliver the best desktop virtualization data center infrastructure: simplification, security, and scalability. The software combined with platform modularity provides a simplified, secure, and scalable desktop virtualization platform.

### Simplified

Cisco UCS provides a radical new approach to industry-standard computing and provides the core of the data center infrastructure for desktop virtualization. Among the many features and benefits of Cisco UCS are the drastic reduction in the number of servers needed and in the number of cables used per server, and the capability to rapidly deploy or re-provision servers through Cisco UCS service profiles. With fewer servers and cables to manage and with streamlined server and virtual desktop provisioning, operations are significantly simplified. Thousands of desktops can be provisioned in minutes with Cisco UCS Manager Service Profiles and Cisco storage partners' storage-based cloning. This approach accelerates the time to productivity for end users, improves business agility, and allows IT resources to be allocated to other tasks.

Cisco UCS Manager automates many mundane, error-prone data center operations such as configuration and provisioning of server, network, and storage access infrastructure. In addition, Cisco UCS B-Series Blade Servers and C-Series Rack Servers with large memory footprints enable high desktop density that helps reduce server infrastructure requirements.

Cisco Intersight is Cisco's systems management platform that delivers intuitive computing through cloud-powered intelligence. This platform offers a more intelligent level of management that enables IT organizations to analyze, simplify, and automate their environments in ways that were not possible with prior generations of tools. This capability empowers organizations to achieve significant savings in Total Cost of Ownership (TCO) and to deliver applications faster in support of new business initiatives. The advantages of the model-based management of the Cisco UCS® platform plus Cisco Intersight are extended to Cisco UCS servers and Cisco HyperFlex™, including Cisco HyperFlex Edge systems.

Simplification also leads to more successful desktop virtualization implementation. Cisco and its technology partners like VMware Technologies, and Pure Storage have developed integrated, validated architectures, including predefined converged architecture infrastructure packages such as FlashStack. Cisco Desktop Virtualization Solutions have been tested with VMware vSphere, VMware Horizon.

### Secure

Although virtual desktops are inherently more secure than their physical predecessors, they introduce new security challenges. Mission-critical web and application servers using a common infrastructure such as virtual desktops are now at a higher risk for security threats. Inter-virtual machine traffic now poses an important security consideration that IT managers need to address, especially in dynamic environments in which virtual machines, using VMware vMotion, move across the server infrastructure.

Desktop virtualization, therefore, significantly increases the need for virtual machine-level awareness of policy and security, especially given the dynamic and fluid nature of virtual machine mobility across an extended computing infrastructure. The ease with which new virtual desktops can proliferate magnifies the importance of a virtualization-aware network and security infrastructure. Cisco data center infrastructure (Cisco UCS and Cisco Nexus Family solutions) for desktop virtualization provides strong data center, network, and desktop security,

---

with comprehensive security from the desktop to the hypervisor. Security is enhanced with segmentation of virtual desktops, virtual machine-aware policies and administration, and network security across the LAN and WAN infrastructure.

### **Scalable**

Growth of a desktop virtualization solution is all but inevitable, so a solution must be able to scale, and scale predictably, with that growth. The Cisco Desktop Virtualization Solutions built on FlashStack Data Center infrastructure supports high virtual-desktop density (desktops per server), and additional servers and storage scale with near-linear performance. FlashStack Data Center provides a flexible platform for growth and improves business agility. Cisco UCS Manager Service Profiles allow on-demand desktop provisioning and make it just as easy to deploy dozens of desktops as it is to deploy thousands of desktops.

Cisco UCS servers provide near-linear performance and scale. Cisco UCS implements the patented Cisco Extended Memory Technology to offer large memory footprints with fewer sockets (with scalability to up to 3 terabyte (TB) of memory with 2- and 4-socket servers). Using unified fabric technology as a building block, Cisco UCS server aggregate bandwidth can scale to up to 40 Gb per server, and the northbound Cisco UCS fabric interconnect can output 3.82 terabits per second (Tbps) at line rate, helping prevent desktop virtualization I/O and memory bottlenecks. Cisco UCS, with its high-performance, low-latency unified fabric-based networking architecture, supports high volumes of virtual desktop traffic, including high-resolution video and communications traffic. In addition, Cisco storage partner Pure, helps maintain data availability and optimal performance during boot and login storms as part of the Cisco Desktop Virtualization Solutions. Recent Cisco Validated Designs for end user computing based on FlashStack solutions have demonstrated scalability and performance.

FlashStack data center provides an excellent platform for growth, with transparent scaling of server, network, and storage resources to support desktop virtualization, data center applications, and cloud computing.

### **Savings and Success**

The simplified, secure, scalable Cisco data center infrastructure for desktop virtualization solutions saves time and money compared to alternative approaches. Cisco UCS enables faster payback and ongoing savings (better ROI and lower TCO) and provides the industry's greatest virtual desktop density per server, reducing both capital expenditures (CapEx) and operating expenses (OpEx). The Cisco UCS architecture and Cisco Unified Fabric also enables much lower network infrastructure costs, with fewer cables per server and fewer ports required. In addition, storage tiering and deduplication technologies decrease storage costs, reducing desktop storage needs by up to 50 percent.

The simplified deployment of Cisco UCS for desktop virtualization accelerates the time to productivity and enhances business agility. IT staff and end users are more productive more quickly, and the business can respond to new opportunities quickly by deploying virtual desktops whenever and wherever they are needed. The high-performance Cisco systems and network deliver a near-native end-user experience, allowing users to be productive anytime and anywhere.

The ultimate measure of desktop virtualization for any organization is its efficiency and effectiveness in both the near term and the long term. The Cisco Desktop Virtualization Solutions are very efficient, allowing rapid deployment, requiring fewer devices and cables, and reducing costs. The solutions are also very effective, providing the services that end users need on their devices of choice while improving IT operations, control, and data security. Success is bolstered through Cisco's best-in-class partnerships with leaders in virtualization and storage, and through tested and validated designs and services to help customers throughout the solution lifecycle. Long-term success is enabled through the use of Cisco's scalable, flexible, and secure architecture as the platform for desktop virtualization.

---

## Physical Topology

### Compute Connectivity

Each compute chassis in the design is redundantly connected to the managing fabric interconnects with at least two ports per IOM. Ethernet traffic from the upstream network and Fibre Channel frames coming from the FlashArray are converged within the fabric interconnect to be both Ethernet and Fibre Channel over Ethernet and transmitted to the UCS servers through the IOM. These IOM connections from the Cisco UCS Fabric Interconnects to the IOMs are automatically configured as port channels by specifying a Chassis/FEX Discovery Policy within UCSM.

Each rack server in the design is redundantly connected to the managing fabric interconnects with at least one port to each FI. Ethernet traffic from the upstream network and Fibre Channel frames coming from the FlashArray are converged within the fabric interconnect to be both Ethernet and Fibre Channel over Ethernet and transmitted to the UCS server.

These connections from the 4<sup>th</sup> Gen UCS 6454 Fabric Interconnect to the 2408 IOM hosted within the chassis are shown in [Figure 2](#).

Figure 2. Compute Connectivity

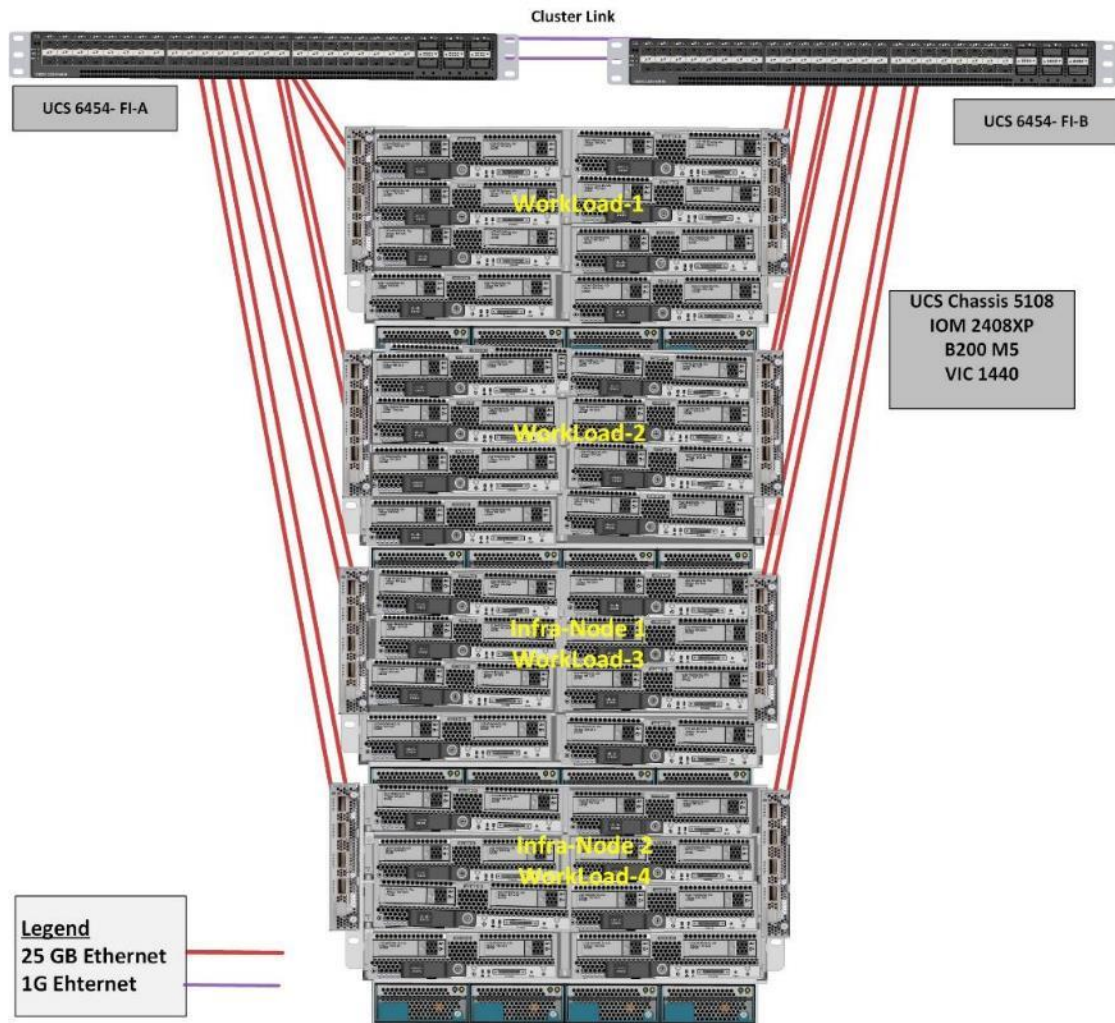

The 2408 IOM is shown with 2x25Gbe ports to deliver to the chassis, full population of the 2408 IOM can support 8x25Gbe ports, allowing for an aggregate of 200Gbe to the chassis.

### Network Connectivity

The layer 2 network connection to each Fabric Interconnect is implemented as Virtual Port Channels (vPC) from the upstream Nexus Switches. In the switching environment, the vPC provides the following benefits:

- Allows a single device to use a Port Channel across two upstream devices
- Eliminates Spanning Tree Protocol blocked ports and use all available uplink bandwidth
- Provides a loop-free topology
- Provides fast convergence if either one of the physical links or a device fails
- Helps ensure high availability of the network

The upstream network switches can connect to the Cisco UCS 6454 Fabric Interconnects using 10G, 25G, 40G, or 100G port speeds. In this design, the 100G ports from the 40/100G ports on the 6454 (1/49-54) were used for the virtual port channels.

**Figure 3. Network Connectivity**

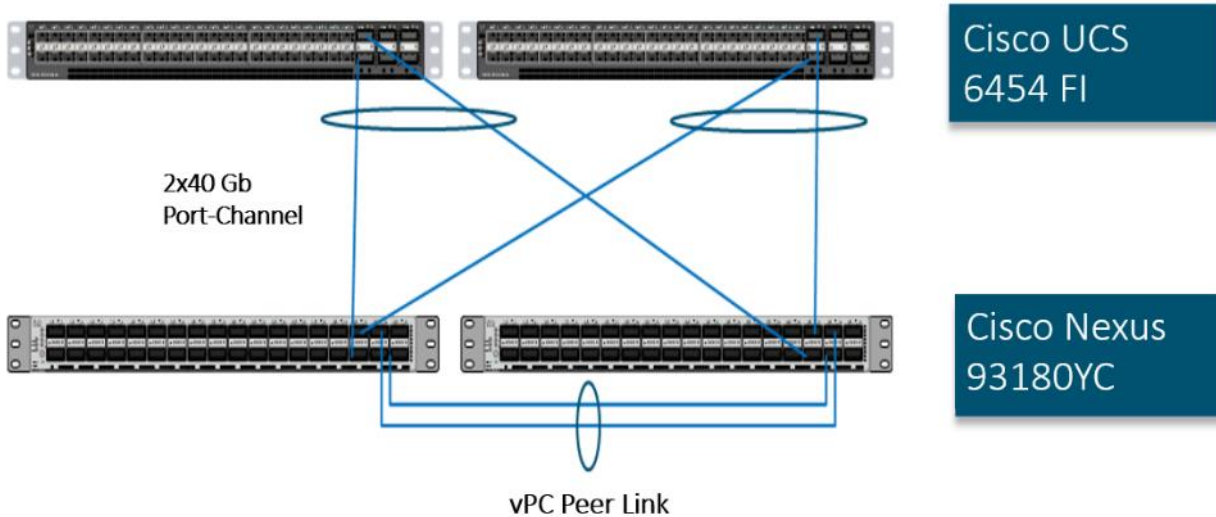

**Fibre Channel Storage Connectivity**

The Pure Storage FlashArray//X70 R3 platform is connected through both MDS 9132Ts to their respective Fabric Interconnects in a traditional air-gapped A/B fabric design. The Fabric Interconnects are configured in N-Port Virtualization (NPV) mode, known as FC end host mode in UCSM. The MDS has N-Port ID Virtualization (NPIV) enabled. This allows F-port channels to be used between the Fabric Interconnect and the MDS, providing the following benefits:

- Increased aggregate bandwidth between the fabric interconnect and the MDS
- Load balancing across the FC uplinks
- High availability in the event of a failure of one or more uplinks

**Figure 4. Fibre Channel Storage Connectivity**

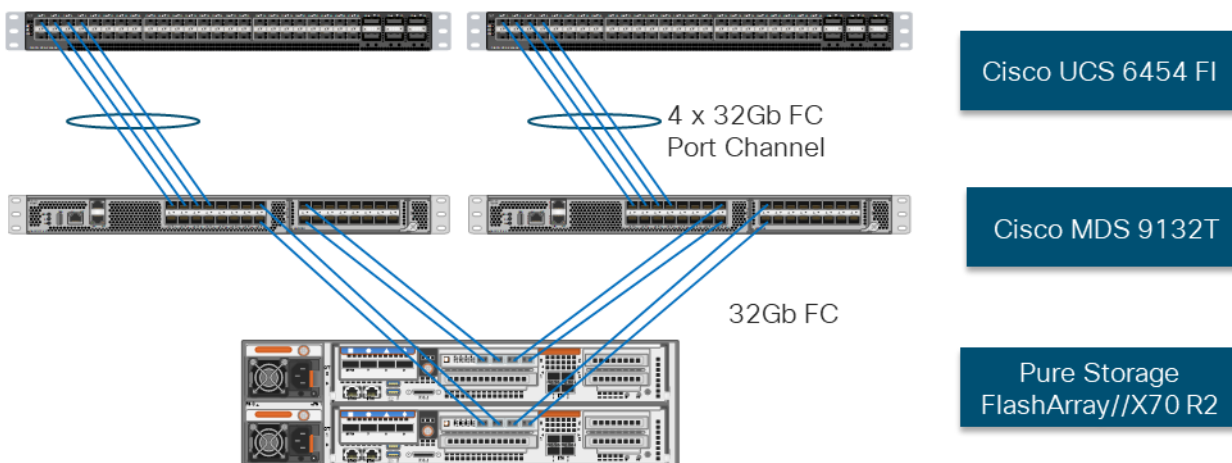



## End-to-End Physical Connectivity

### FC End-to-End Data Path

The FC end-to-end path in the design is a traditional air-gapped fabric with identical data path through each fabric as detailed below:

- Each Cisco UCS Server is equipped with a Cisco UCS VIC 1400 Series adapter
- In the Cisco B200 M5 server, a VIC 1440 provides 2x25Gbe to IOM A and 2x25Gbe to IOM B through the Cisco UCS Chassis 5108 chassis backplane
- Each IOM is connected to its respective Cisco UCS 6454 Fabric Interconnect using a port-channel for 4-8 links
- Each Cisco UCS 6454 FI connects to the MDS 9132T for the respective SAN fabric using an F-Port channel
- The Pure Storage FlashArray//X70 R3 is connected to both MDS 9132T switches to provide redundant paths through both fabrics

Figure 5. FC End-to-End Data Path

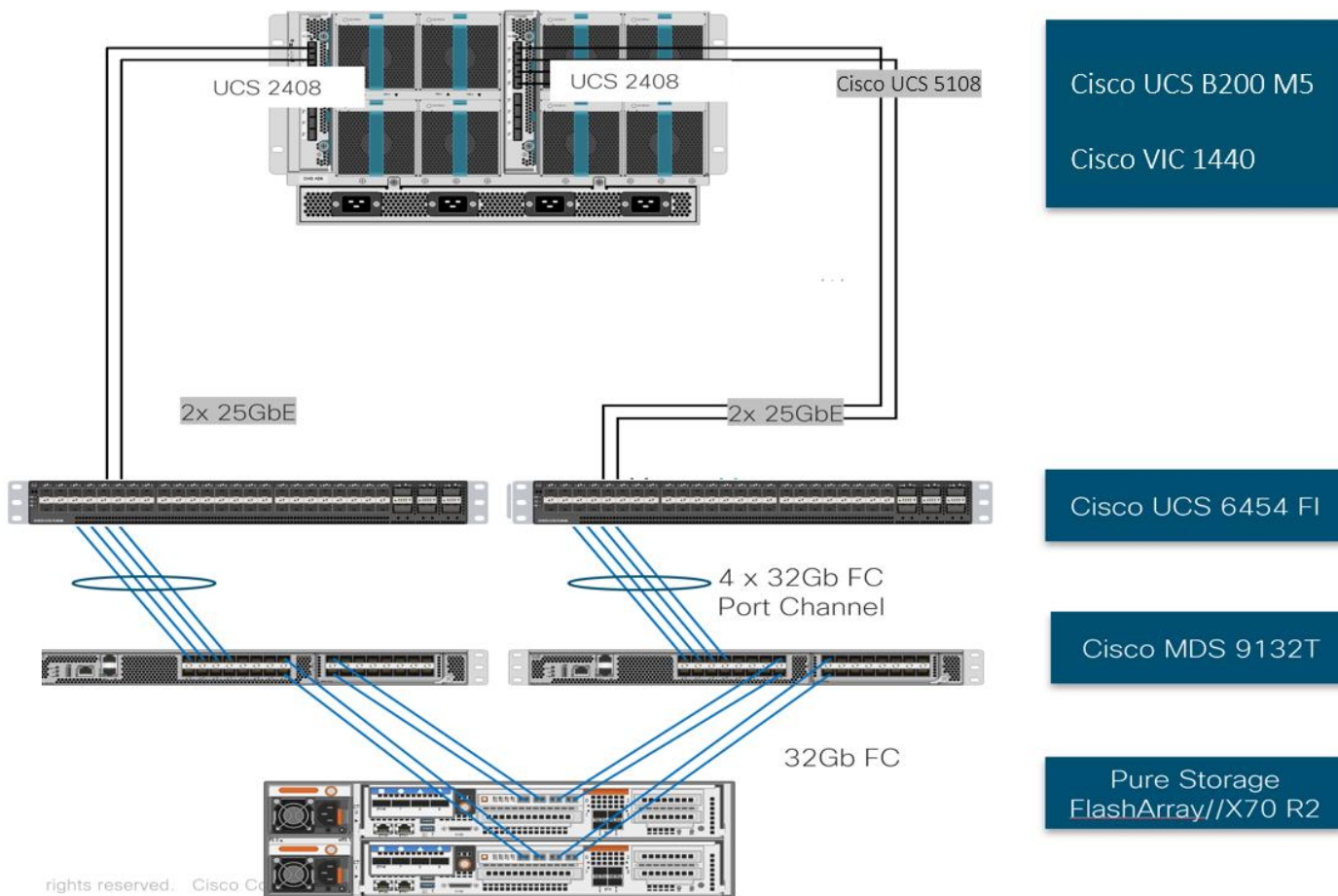

---

The components of this integrated architecture shown in [Figure 5](#) are:

- Cisco Nexus 93180YC-FX - 10/25/40/100Gbe capable, LAN connectivity to the Cisco UCS compute resources
- Cisco UCS 6454 Fabric Interconnect - Unified management of Cisco UCS compute, and the compute's access to storage and networks
- Cisco UCS B200 M5 - High powered blade server, optimized for virtual computing
- Cisco MDS 9132T - 32Gb Fibre Channel connectivity within the architecture, as well as interfacing to resources present in an existing data center
- Pure Storage FlashArray//X70 R3

### **High Scale RDS and VDI Workload Solution Reference Architecture**

[Figure 6](#) illustrates the FlashStack System architecture used in this Validated Design to support very high scale mixed desktop user workload. It follows Cisco configuration requirements to deliver highly available and scalable architecture.

Figure 6. FlashStack Solution Reference Architecture

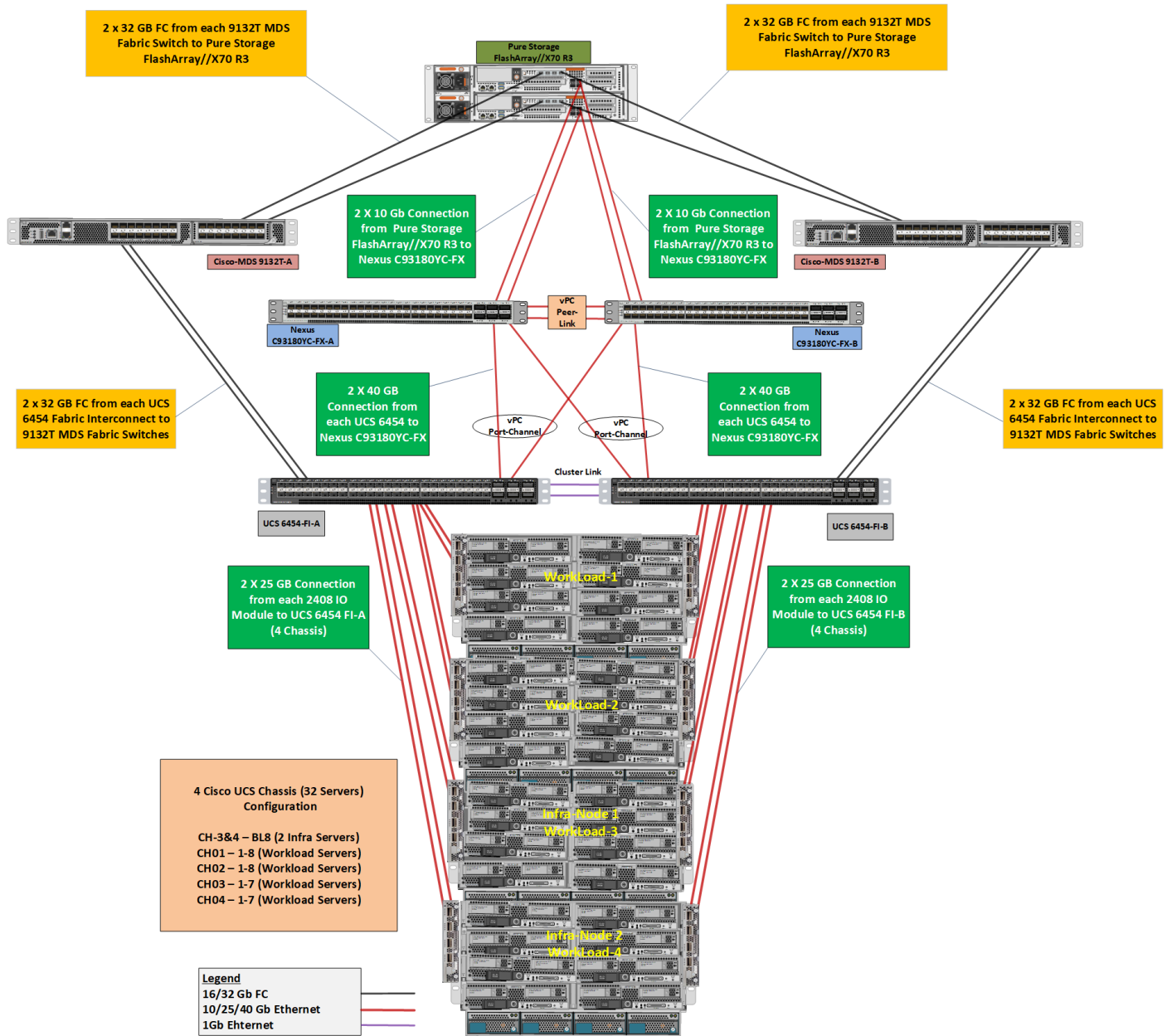

The reference hardware configuration includes:

- Two Cisco Nexus 93180YC-FX switches
- Two Cisco MDS 9132T 32-Gb Fibre Channel switches
- Two Cisco UCS 6454 Fabric Interconnects
- Four Cisco UCS 5108 Blade Chassis
- Two Cisco UCS B200 M5 Blade Servers (2 Server hosting Infrastructure virtual machines)

- 
- Thirty Cisco UCS B200 M5 Blade Servers (for workload)
  - One Pure Storage FlashArray//X70 R3 with All-NVMe DirectFlash Modules

For desktop virtualization, the deployment includes VMware Horizon 7.12 running on VMware vSphere ESXi 7.0 GA.

The design is intended to provide a large-scale building block for VMware Horizon desktops in the following ratios:

- 6000 Random RDS Windows 2019 user sessions with Office 2019 on 30 Cisco UCS Hosts
- 5000 Random Windows 10 Instant Clone Desktops with Office 2019 on 30 Cisco UCS Hosts
- 5000 Random Windows 10 Full Clone Desktops with Office 2019 on 30 Cisco UCS Hosts
- Mixed:
  - 2000 Random RDS Windows 2019 user sessions with Office 2019 (Full Clones) on 10 Cisco UCS Hosts
  - 1600 Random Windows 10 Instant Clone Desktops with Office 2019 on 10 Cisco UCS Hosts
  - 1600 Random Windows 10 Full Clone Desktops with Office 2019 on 10 Cisco UCS Hosts

This document guides you through the detailed steps for deploying the base architecture. This procedure explains everything from physical cabling to network, compute, and storage device configurations.

## What is FlashStack?

The [FlashStack](#) platform, developed by Cisco and Pure Storage, is a flexible, integrated infrastructure solution that delivers pre-validated storage, networking, and server technologies. Cisco and Pure Storage have carefully validated and verified the FlashStack solution architecture and its many use cases while creating a portfolio of detailed documentation, information, and references to assist customers in transforming their data centers to this shared infrastructure model.

FlashStack is a best practice data center architecture that includes the following components:

- Cisco Unified Computing System
- Cisco Nexus Switches
- Cisco MDS Switches
- Pure Storage FlashArray

**Figure 7. FlashStack Systems Components**

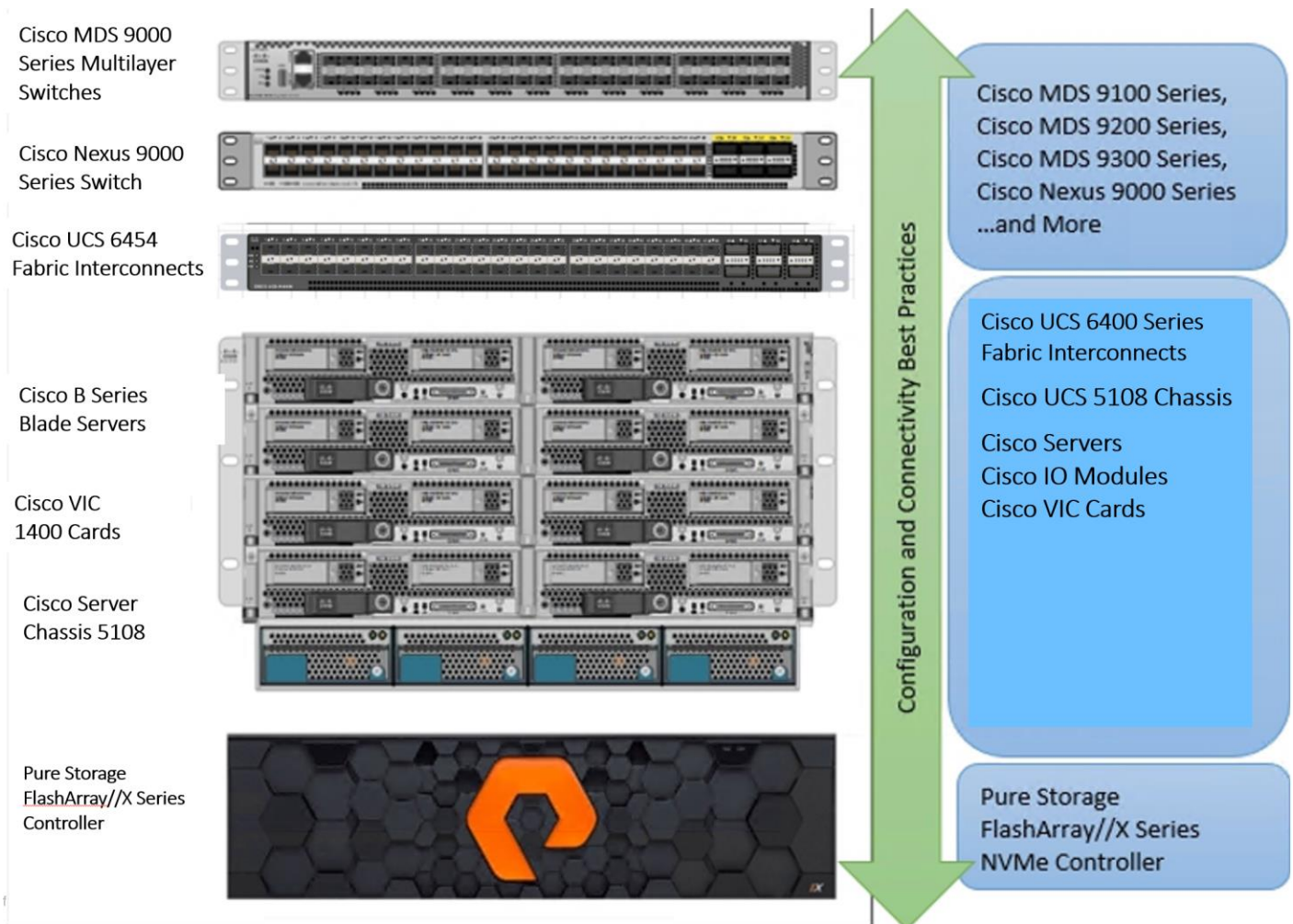

As shown in [Figure 7](#), these components are connected and configured according to best practices of both Cisco and Pure Storage and provide the ideal platform for running a variety of enterprise database workloads with confidence. FlashStack can scale up for greater performance and capacity (adding compute, network, or storage resources individually as needed), or it can scale out for environments that require multiple consistent deployments.

The reference architecture covered in this document leverages the Pure Storage FlashArray//X70 R3 Controller with NVMe based DirectFlash modules for Storage, Cisco UCS B200 M5 Blade Server for Compute, Cisco Nexus 9000, and Cisco MDS 9100 Series for the switching element and Cisco Fabric Interconnects 6300 Series for System Management. As shown in [Figure 7](#), FlashStack Architecture can maintain consistency at scale. Each of the component families shown in (Cisco UCS, Cisco Nexus, Cisco MDS, Cisco FI and Pure Storage) offers platform and resource options to scale the infrastructure up or down, while supporting the same features and functionality that are required under the configuration and connectivity best practices of FlashStack.



---

## FlashStack Solution Benefits

FlashStack provides a jointly supported solution by Cisco and Pure Storage. Bringing a carefully validated architecture built on superior compute, world-class networking, and the leading innovations in all flash storage. The portfolio of validated offerings from FlashStack includes but is not limited to the following:

- Consistent Performance and Scalability
  - Consistent sub-millisecond latency with 100 percent NVMe enterprise flash storage
  - Consolidate hundreds of enterprise-class applications in a single rack
  - Scalability through a design for hundreds of discrete servers and thousands of virtual machines, and the capability to scale I/O bandwidth to match demand without disruption
  - Repeatable growth through multiple FlashStack CI deployments
- Operational Simplicity
  - Fully tested, validated, and documented for rapid deployment
  - Reduced management complexity
  - No storage tuning or tiers necessary
  - 3x better data reduction without any performance impact
- Lowest TCO
  - Dramatic savings in power, cooling and space with Cisco UCS and 100 percent Flash
  - Industry leading data reduction
  - Free FlashArray controller upgrades every three years with Forever Flash™
- Mission Critical and Enterprise Grade Resiliency
  - Highly available architecture with no single point of failure
  - Non-disruptive operations with no downtime
  - Upgrade and expand without downtime or performance loss
  - Native data protection: snapshots and replication

Cisco and Pure Storage have also built a robust and experienced support team focused on FlashStack solutions, from customer account and technical sales representatives to professional services and technical support engineers. The support alliance between Pure Storage and Cisco gives customers and channel services partners direct access to technical experts who collaborate with cross vendors and have access to shared lab resources to resolve potential issues.

## What's New in this FlashStack Release

This CVD of the FlashStack release introduces new hardware with the Pure Storage FlashArray//X, that is 100 percent NVMe enterprise class all-flash array along with Cisco UCS B200 M5 Blade Servers featuring the Intel Xeon Scalable Family of CPUs. This is the second Oracle RAC Database deployment Cisco Validated Design with Pure Storage. It incorporates the following features:

- Pure Storage FlashArray//X70 R3 Purity//FA 6.0.3
- Cisco 4<sup>th</sup> Gen UCS 6454 with IOM 2408
- Cisco UCS Manager 4.1(2a)

- 
- VMware vSphere ESXi 7.0 GA Hypervisor
  - VMware Horizon 7.12
  - VMware DEM Enterprise 10.0

## Configuration Guidelines

This Cisco Validated Design provides the details to deploy a highly available 6000/5000/5000 seat RDS/VDI virtual desktop solution with VMware on a FlashStack Data Center architecture. Configuration guidelines are provided that refer the reader to which redundant component is being configured with each step.

Redundancy built-in the entire infrastructure is as follows:

- Storage Redundancy: FlashArray//X70 R3 Controller 0 and Controller 1
- Switching Redundancy: Cisco Nexus A and Cisco Nexus B
- SAN Switch redundancy: Cisco MDS A and Cisco MDS B
- Compute Redundancy: Cisco UCS 6454 FI- A and FI -B
- Compute Server redundancy: N+1
- Infrastructure Server redundancy: N+1

Additionally, this document explains the steps to provision multiple Cisco UCS hosts, and these are identified sequentially: VM-Host-Infra-01, VM-Host-Infra-02, VM-Host-RDSH-01, VM-Host-VDI-01 and so on. Finally, to indicate that you should include information pertinent to your environment in a given step, <text> appears as part of the command structure.

---

## Solution Components

This section describes the components used in the solution outlined in this solution.

### Cisco Unified Computing System

Cisco UCS Manager (UCSM) provides unified, embedded management of all software and hardware components of the Cisco Unified Computing System™ (Cisco UCS) through an intuitive GUI, a CLI, and an XML API. The manager provides a unified management domain with centralized management capabilities and can control multiple chassis and thousands of virtual machines.

Cisco UCS is a next-generation data center platform that unites computing, networking, and storage access. The platform, optimized for virtual environments, is designed using open industry-standard technologies and aims to reduce total cost of ownership (TCO) and increase business agility. The system integrates a low-latency, lossless 40 Gigabit Ethernet unified network fabric with enterprise-class, x86-architecture servers. It is an integrated, scalable, multi-chassis platform in which all resources participate in a unified management domain.

### Cisco Unified Computing System Components

The main components of Cisco UCS are:

- **Compute:** The system is based on an entirely new class of computing system that incorporates blade servers based on Intel® Xeon® Scalable Family processors.
- **Network:** The system is integrated on a low-latency, lossless, 25-Gbe unified network fabric. This network foundation consolidates LANs, SANs, and high-performance computing (HPC) networks, which are separate networks today. The unified fabric lowers costs by reducing the number of network adapters, switches, and cables needed, and by decreasing the power and cooling requirements.
- **Virtualization:** The system unleashes the full potential of virtualization by enhancing the scalability, performance, and operational control of virtual environments. Cisco security, policy enforcement, and diagnostic features are now extended into virtualized environments to better support changing business and IT requirements.
- **Storage access:** The system provides consolidated access to local storage, SAN storage, and network-attached storage (NAS) over the unified fabric. With storage access unified, Cisco UCS can access storage over Ethernet, Fibre Channel, Fibre Channel over Ethernet (FCoE), and Small Computer System Interface over IP (iSCSI) protocols. This capability provides customers with choice for storage access and investment protection. In addition, server administrators can pre-assign storage-access policies for system connectivity to storage resources, simplifying storage connectivity and management and helping increase productivity.
- **Management:** Cisco UCS uniquely integrates all system components, enabling the entire solution to be managed as a single entity by Cisco UCS Manager. Cisco UCS Manager has an intuitive GUI, a CLI, and a robust API for managing all system configuration processes and operations.

Figure 8. Cisco Data Center Overview

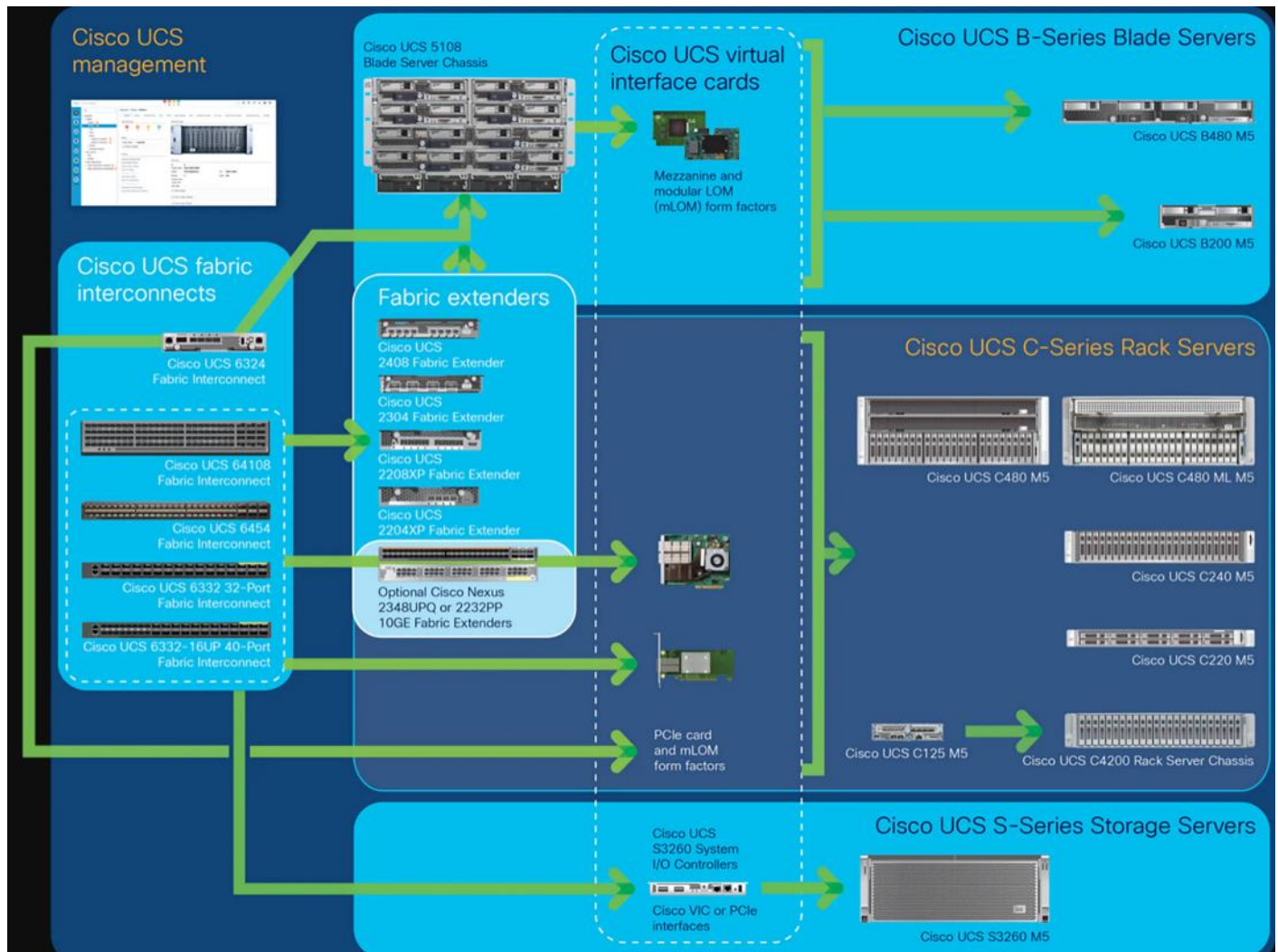

Cisco UCS is designed to deliver:

- Reduced TCO and increased business agility
- Increased IT staff productivity through just-in-time provisioning and mobility support
- A cohesive, integrated system that unifies the technology in the data center; the system is managed, serviced, and tested as a whole
- Scalability through a design for hundreds of discrete servers and thousands of virtual machines and the capability to scale I/O bandwidth to match demand
- Industry standards supported by a partner ecosystem of industry leaders

Cisco UCS Manager provides unified, embedded management of all software and hardware components of the Cisco Unified Computing System across multiple chassis, rack servers, and thousands of virtual machines. Cisco UCS Manager manages Cisco UCS as a single entity through an intuitive GUI, a CLI, or an XML API for comprehensive access to all Cisco UCS Manager Functions.

## Cisco UCS Fabric Interconnect

The Cisco UCS 6400 Series Fabric Interconnects are a core part of the Cisco Unified Computing System, providing both network connectivity and management capabilities for the system. The Cisco UCS 6400 Series offer line-rate, low-latency, lossless 10/25/40/100 Gigabit Ethernet, Fibre Channel over Ethernet (FCoE), and Fibre Channel functions.

The Cisco UCS 6400 Series provide the management and communication backbone for the Cisco UCS B-Series Blade Servers, UCS 5108 B-Series Server Chassis, UCS Managed C-Series Rack Servers, and UCS S-Series Storage Servers. All servers attached to a Cisco UCS 6400 Series Fabric Interconnect become part of a single, highly available management domain. In addition, by supporting a unified fabric, Cisco UCS 6400 Series Fabric Interconnect provides both the LAN and SAN connectivity for all servers within its domain.

From a networking perspective, the Cisco UCS 6400 Series use a cut-through architecture, supporting deterministic, low-latency, line-rate 10/25/40/100 Gigabit Ethernet ports, switching capacity of 3.82 Tbps for the 6454, 7.42 Tbps for the 64108, and 200 Gbe bandwidth between the Fabric Interconnect 6400 series and the IOM 2408 per 5108 blade chassis, independent of packet size and enabled services. The product family supports Cisco low-latency, lossless 10/25/40/100 Gigabit Ethernet unified network fabric capabilities, which increase the reliability, efficiency, and scalability of Ethernet networks. The fabric interconnect supports multiple traffic classes over a lossless Ethernet fabric from the server through the fabric interconnect. Significant TCO savings come from an FCoE-optimized server design in which Network Interface Cards (NICs), Host Bus Adapters (HBAs), cables, and switches can be consolidated.

Figure 9. Cisco UCS 6400 Series Fabric Interconnect - 6454 Front View



Figure 10. Cisco UCS 6400 Series Fabric Interconnect - 6454 Rear View



## Cisco UCS B200 M5 Blade Server

The Cisco UCS B200 M5 Blade Server ([Figure 11](#) and [Figure 12](#)) is a density-optimized, half-width blade server that supports two CPU sockets for Intel Xeon processor 6230 Gold series CPUs and up to 24 DDR4 DIMMs. It supports one modular LAN-on-motherboard (LOM) dedicated slot for a Cisco virtual interface card (VIC) and one mezzanine adapter. In additions, the Cisco UCS B200 M5 supports an optional storage module that accommodates up to two SAS or SATA hard disk drives (HDDs) or solid-state disk (SSD) drives. You can install up to eight Cisco UCS B200 M5 servers in a chassis, mixing them with other models of Cisco UCS blade servers in the chassis if desired.



Figure 11. Cisco UCS B200 M5 Front View



Figure 12. Cisco UCS B200 M5 Back View

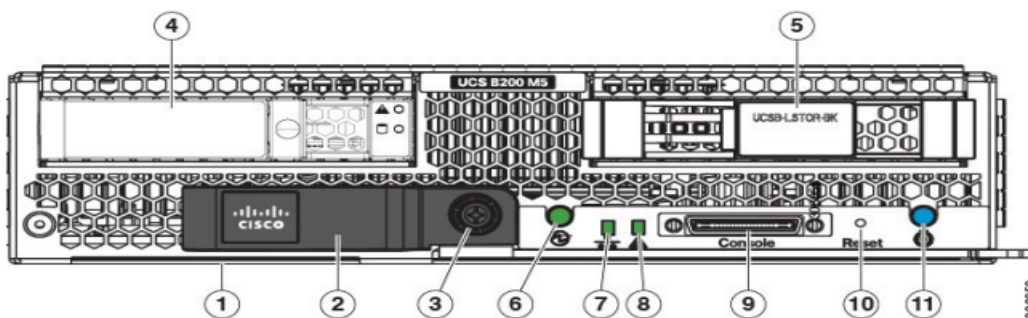

1	Asset pull tag Each server has a plastic tag that pulls out of the front panel. The tag contains the server serial number as well as the product ID (PID) and version ID (VID). The tag also allows you to add your own asset tracking label without interfering with the intended air flow.	7	Network link status
2	Blade ejector handle	8	Blade health LED
3	Ejector captive screw	9	Console connector <sup>1</sup>
4	Drive bay 1	10	Reset button access
5	Drive bay 2	11	Locator button and LED
6	Power button and LED		

**Notes:**

1. A KVM I/O Cable plugs into the console connector, it can be ordered as a spare. The KVM I/O Cable is included with every Cisco UCS 5100 Series blade server chassis accessory kit

Cisco UCS combines Cisco UCS B-Series Blade Servers and C-Series Rack Servers with networking and storage access into a single converged system with simplified management, greater cost efficiency and agility, and increased visibility and control. The Cisco UCS B200 M5 Blade Server is one of the newest servers in the Cisco UCS portfolio.

The Cisco UCS B200 M5 delivers performance, flexibility, and optimization for data centers and remote sites. This enterprise-class server offers market-leading performance, versatility, and density without compromise for workloads ranging from web infrastructure to distributed databases. The Cisco UCS B200 M5 can quickly deploy stateless physical and virtual workloads with the programmable ease of use of the Cisco UCS Manager software and simplified server access with Cisco® Single Connect technology. Based on the Intel Xeon® processor Gold 6230 product family, it offers up to 3 TB of memory using 128GB DIMMs, up to two disk drives, and up to 320

---

GB of I/O throughput. The Cisco UCS B200 M5 offers exceptional levels of performance, flexibility, and I/O throughput to run your most demanding applications.

In addition, Cisco UCS has the architectural advantage of not having to power and cool excess switches, NICs, and HBAs in each blade server chassis. With a larger power budget per blade server, it provides uncompromised expandability and capabilities, as in the new Cisco UCS B200 M5 server with its leading memory-slot capacity and drive capacity.

The Cisco UCS B200 M5 provides:

- Latest Intel® Xeon® Scalable processors with up to 28 cores per socket
- Up to 24 DDR4 DIMMs for improved performance
- Intel 3D XPoint-ready support, with built-in support for next-generation nonvolatile memory technology
- Two GPUs
- Two Small-Form-Factor (SFF) drives
- Two Secure Digital (SD) cards or M.2 SATA drives
- Up to 80 Gbe of I/O throughput

### **Main Features**

The Cisco UCS B200 M5 server is a half-width blade. Up to eight servers can reside in the 6-Rack-Unit (6RU) Cisco UCS 5108 Blade Server Chassis, offering one of the highest densities of servers per rack unit of blade chassis in the industry. You can configure the Cisco UCS B200 M5 to meet your local storage requirements without having to buy, power, and cool components that you do not need.

The Cisco UCS B200 M5 provides these main features:

- Up to two Intel Xeon Scalable CPUs with up to 28 cores per CPU
- 24 DIMM slots for industry-standard DDR4 memory at speeds up to 2666 MHz, with up to 3 TB of total memory when using 128-GB DIMMs
- Modular LAN On Motherboard (mLOM) card with Cisco UCS Virtual Interface Card (VIC) 1440 or 1340, a 2-port, 40 Gigabit Ethernet, Fibre Channel over Ethernet (FCoE)-capable mLOM mezzanine adapter
- Optional rear mezzanine VIC with two 40-Gbe unified I/O ports or two sets of 4 x 10-Gbe unified I/O ports, delivering 80 Gbe to the server; adapts to either 10- or 40-Gbe fabric connections
- Two optional, hot-pluggable, hard-disk drives (HDDs), solid-state drives (SSDs), or NVMe 2.5-inch drives with a choice of enterprise-class RAID or pass-through controllers
- Cisco FlexStorage local drive storage subsystem, which provides flexible boot and local storage capabilities and allows you to boot from dual, mirrored SD cards
- Support for up to two optional GPUs
- Support for up to one rear storage mezzanine card
- Support for one 16-GB internal flash USB drive

For more information about Cisco UCS B200 M5, see the [Cisco UCS B200 M5 Blade Server Specs sheet](#).

**Table 1. Ordering Information**

Part Number	Description
UCSB-B200-M5	Cisco UCS B200 M5 Blade w/o CPU, mem, HDD, mezz
UCSB-B200-M5-U	Cisco UCS B200 M5 Blade w/o CPU, mem, HDD, mezz (UPG)
UCSB-B200-M5-CH	Cisco UCS B200 M5 Blade w/o CPU, mem, HDD, mezz, Drive bays, HS

### Cisco UCS VIC1440 Converged Network Adapter

The Cisco UCS VIC 1440 ([Figure 13](#)) is a single-port 40-Gbe or 4x10-Gbe Ethernet/FCoE capable modular LAN On Motherboard (mLOM) designed exclusively for the M5 generation of Cisco UCS B-Series Blade Servers. When used in combination with an optional port expander, the Cisco UCS VIC 1440 capabilities are enabled for two ports of 40-Gbe Ethernet. The Cisco UCS VIC 1440 enables a policy-based, stateless, agile server infrastructure that can present to the host PCIe standards-compliant interfaces that can be dynamically configured as either NICs or HBAs.

**Figure 13. Cisco UCS VIC 1440**

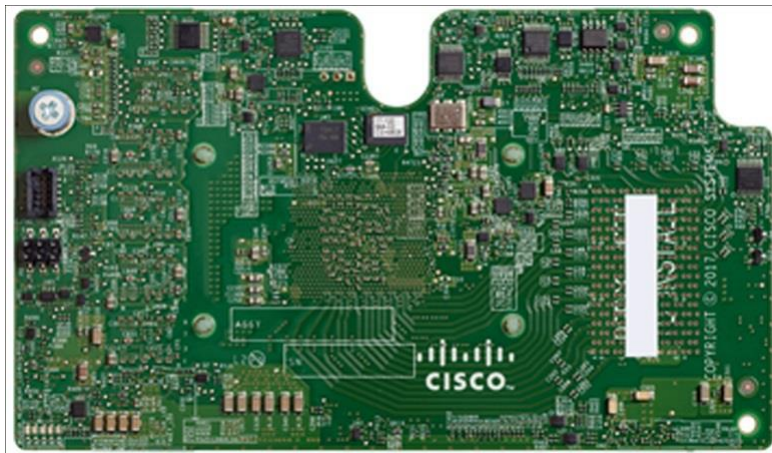

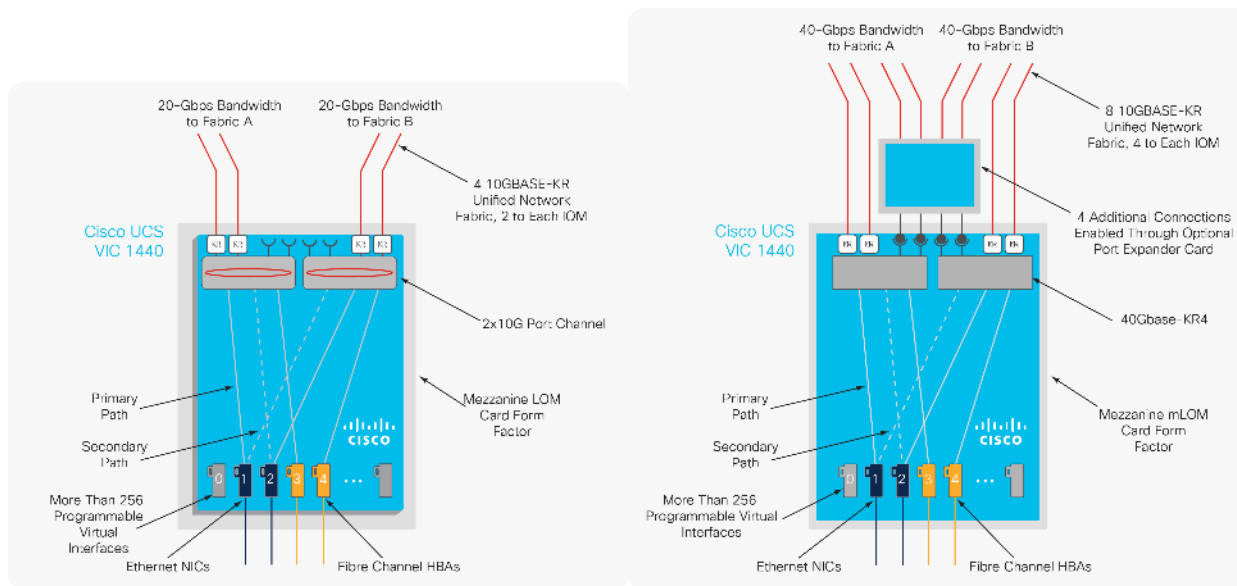

**Figure 13** illustrates the Cisco UCS VIC 1440 Virtual Interface Cards Deployed in the Cisco UCS B-Series B200 M5 Blade Servers.

## Cisco Switching

### Cisco Nexus 93180YC-FX Switches

The 93180YC-EX Switch provides a flexible line-rate Layer 2 and Layer 3 feature set in a compact form factor. Designed with Cisco Cloud Scale technology, it supports highly scalable cloud architectures. With the option to operate in Cisco NX-OS or Application Centric Infrastructure (ACI) mode, it can be deployed across enterprise, service provider, and Web 2.0 data centers.

- Architectural Flexibility
  - Includes top-of-rack or middle-of-row fiber-based server access connectivity for traditional and leaf-spine architectures
  - Leaf node support for Cisco ACI architecture is provided in the roadmap
  - Increase scale and simplify management through Cisco Nexus 2000 Fabric Extender support
- Feature Rich
  - Enhanced Cisco NX-OS Software is designed for performance, resiliency, scalability, manageability, and programmability
  - ACI-ready infrastructure helps users take advantage of automated policy-based systems management
  - Virtual Extensible LAN (VXLAN) routing provides network services
  - Rich traffic flow telemetry with line-rate data collection
  - Real-time buffer utilization per port and per queue, for monitoring traffic micro-bursts and application traffic patterns
- Highly Available and Efficient Design
  - High-density, non-blocking architecture

- Easily deployed into either a hot-aisle and cold-aisle configuration
- Redundant, hot-swappable power supplies and fan trays
- Simplified Operations
  - Power-On Auto Provisioning (POAP) support allows for simplified software upgrades and configuration file installation
  - An intelligent API offers switch management through remote procedure calls (RPCs, JSON, or XML) over a HTTP/HTTPS infrastructure
  - Python Scripting for programmatic access to the switch command-line interface (CLI)
  - Hot and cold patching, and online diagnostics
- Investment Protection

A Cisco 40 Gbe [bidirectional transceiver](#) allows reuse of an existing 10 Gigabit Ethernet multimode cabling plant for 40 Gigabit Ethernet Support for 1 Gbe and 10 Gbe access connectivity for data centers migrating access switching infrastructure to faster speed. The following is supported:

- 1.8 Tbps of bandwidth in a 1 RU form factor
- 48 fixed 1/10/25-Gbe SFP+ ports
- 6 fixed 40/100-Gbe QSFP+ for uplink connectivity
- Latency of less than 2 microseconds
- Front-to-back or back-to-front airflow configurations
- 1+1 redundant hot-swappable 80 Plus Platinum-certified power supplies
- Hot swappable 3+1 redundant fan trays

**Figure 14. Cisco Nexus 93180YC-EX Switch**



### Cisco MDS 9132T 32-Gb Fiber Channel Switch

The next-generation Cisco® MDS 9132T 32-Gb 32-Port Fibre Channel Switch ([Figure 15](#)) provides high-speed Fibre Channel connectivity from the server rack to the SAN core. It empowers small, midsize, and large enterprises that are rapidly deploying cloud-scale applications using extremely dense virtualized servers, providing the dual benefits of greater bandwidth and consolidation.

Small-scale SAN architectures can be built from the foundation using this low-cost, low-power, non-blocking, line-rate, and low-latency, bi-directional airflow capable, fixed standalone SAN switch connecting both storage and host ports.

Medium-size to large-scale SAN architectures built with SAN core directors can expand 32-Gb connectivity to the server rack using these switches either in switch mode or Network Port Virtualization (NPV) mode.

Additionally, investing in this switch for the lower-speed (4- or 8- or 16-Gb) server rack gives you the option to upgrade to 32-Gb server connectivity in the future using the 32-Gb Host Bus Adapter (HBA) that are available today. The Cisco® MDS 9132T 32-Gb 32-Port Fibre Channel switch also provides unmatched flexibility through a unique port expansion module (Figure 16. ) that provides a robust cost-effective, field swappable, port up-grade option.

This switch also offers state-of-the-art SAN analytics and telemetry capabilities that have been built into this next-generation hardware platform. This new state-of-the-art technology couples the next-generation port ASIC with a fully dedicated Network Processing Unit designed to complete analytics calculations in real time. The telemetry data extracted from the inspection of the frame headers are calculated on board (within the switch) and, using an industry-leading open format, can be streamed to any analytics-visualization platform. This switch also includes a dedicated 10/100/1000BASE-T telemetry port to maximize data delivery to any telemetry receiver including Cisco Data Center Network Manager.

**Figure 15. Cisco 9132T 32-Gb MDS Fibre Channel Switch**



**Figure 16. Cisco MDS 9132T 32-Gb 16-Port Fibre Channel Port Expansion Module**



- Features
  - High performance: MDS 9132T architecture, with chip-integrated nonblocking arbitration, provides consistent 32-Gb low-latency performance across all traffic conditions for every Fibre Channel port on the switch.
  - Capital Expenditure (CapEx) savings: The 32-Gb ports allow users to deploy them on existing 16- or 8-Gb transceivers, reducing initial CapEx with an option to upgrade to 32-Gb transceivers and adapters in the future.
  - High availability: MDS 9132T switches continue to provide the same outstanding availability and reliability as the previous-generation Cisco MDS 9000 Family switches by providing optional redundancy on all major components such as the power supply and fan. Dual power supplies also facilitate redundant power grids.
  - Pay-as-you-grow: The MDS 9132T Fibre Channel switch provides an option to deploy as few as eight 32-Gb Fibre Channel ports in the entry-level variant, which can grow by 8 ports to 16 ports, and thereafter with a port expansion module with sixteen 32-Gb ports, to up to 32 ports. This approach results in lower initial investment and power consumption for entry-level configurations of up to 16 ports compared to a fully loaded switch. Upgrading through an expansion module also reduces the overhead of



---

managing multiple instances of port activation licenses on the switch. This unique combination of port upgrade options allow four possible configurations of 8 ports, 16 ports, 24 ports and 32 ports.

- Next-generation Application-Specific Integrated Circuit (ASIC): The MDS 9132T Fibre Channel switch is powered by the same high-performance 32-Gb Cisco ASIC with an integrated network processor that powers the Cisco MDS 9700 48-Port 32-Gb Fibre Channel Switching Module. Among all the advanced features that this ASIC enables, one of the most notable is inspection of Fibre Channel and Small Computer System Interface (SCSI) headers at wire speed on every flow in the smallest form-factor Fibre Channel switch without the need for any external taps or appliances. The recorded flows can be analyzed on the switch and also exported using a dedicated 10/100/1000BASE-T port for telemetry and analytics purposes.
- Intelligent network services: Slow-drain detection and isolation, VSAN technology, Access Control Lists (ACLs) for hardware-based intelligent frame processing, smartzoning and fabric wide Quality of Service (QoS) enable migration from SAN islands to enterprise-wide storage networks. Traffic encryption is optionally available to meet stringent security requirements.
- Sophisticated diagnostics: The MDS 9132T provides intelligent diagnostics tools such as Inter-Switch Link (ISL) diagnostics, read diagnostic parameters, protocol decoding, network analysis tools, and integrated Cisco Call Home capability for greater reliability, faster problem resolution, and reduced service costs.
- Virtual machine awareness: The MDS 9132T provides visibility into all virtual machines logged into the fabric. This feature is available through HBAs capable of priority tagging the Virtual Machine Identifier (VMID) on every FC frame. Virtual machine awareness can be extended to intelligent fabric services such as analytics[1] to visualize performance of every flow originating from each virtual machine in the fabric.
- Programmable fabric: The MDS 9132T provides powerful Representational State Transfer (REST) and Cisco NX-API capabilities to enable flexible and rapid programming of utilities for the SAN as well as polling point-in-time telemetry data from any external tool.
- Single-pane management: The MDS 9132T can be provisioned, managed, monitored, and troubleshot using Cisco Data Center Network Manager (DCNM), which currently manages the entire suite of Cisco data center products.
- Self-contained advanced anticounterfeiting technology: The MDS 9132T uses on-board hardware that protects the entire system from malicious attacks by securing access to critical components such as the bootloader, system image loader and Joint Test Action Group (JTAG) interface.

## Purity for FlashArray

The essential element of every FlashArray is the Purity Operating Environment software. Purity implements advanced data reduction, storage management, and flash management features, enabling organizations to enjoy Tier 1 data services for all workloads, proven 99.9999% availability over multiple years (inclusive of maintenance and generational upgrades), completely non-disruptive operations, 2X better data reduction versus alternative all-flash solutions, and - with FlashArray//X - the power and efficiency of DirectFlash™.



Moreover, Purity includes enterprise-grade data security, modern data protection options, and complete business continuity and global disaster recovery through ActiveCluster multi-site stretch cluster and ActiveDR\* for continuous replication with near zero RPO. All these features are included with every array.

### FlashArray File Services

Pure Storage acquired Compuverde last year, and they've been busy at work integrating this technology into the Purity//FA operating system. They emphasize the "integrating", because they didn't just take the existing product, drop it onto a FlashArray system, and run it on top of Purity. Instead, they incorporated key parts of it into Purity to give you the advantages of native files alongside blocks.

The SMB and NFS protocols bring consolidated storage to the Purity//FA operating system, complementing its block capabilities, while the file system offers features like directory snapshots and directory-level performance and space monitoring. For the purposes of this reference architecture, we will be focusing on using File Services for User Profile management.

Figure 17. FlashArray//X Specifications



	<b>CAPACITY</b>	<b>PHYSICAL</b>
<b>//X10</b>	Up to 73TB / 66.2TiB effective capacity** Up to 22TB / 19.2TiB raw capacity†	3U; 640 – 845 Watts (nominal – peak) 95 lbs (43.1 kg) fully loaded; 5.12" x 18.94" x 29.72"
<b>//X20</b>	Up to 314TB / 285.4TiB effective capacity** Up to 94TB / 88TiB raw capacity†	3U; 741 – 973 Watts (nominal – peak) 95 lbs (43.1 kg) fully loaded; 5.12" x 18.94" x 29.72"
<b>//X50</b>	Up to 663TB / 602.9TiB effective capacity** Up to 185TB / 171TiB raw capacity†	3U; 868 – 1114 Watts (nominal – peak) 95 lbs (43.1 kg) fully loaded; 5.12" x 18.94" x 29.72"
<b>//X70</b>	Up to 2286TB / 2078.9TiB effective capacity** Up to 622TB / 544.2TiB raw capacity†	3U; 1084 – 1344 Watts (nominal – peak) 97 lbs (44.0 kg) fully loaded; 5.12" x 18.94" x 29.72"
<b>//X90</b>	Up to 3.3PB / 3003.1TiB effective capacity** Up to 878TB / 768.3TiB raw capacity†	3U – 6U; 1160 – 1446 Watts (nominal – peak) 97 lbs (44 kg) fully loaded; 5.12" x 18.94" x 29.72"
<b>DirectFlash Shelf</b>	Up to 1.9PB effective capacity** Up to 512TB / 448.2TiB raw capacity	3U; 460 – 500 Watts (nominal – peak) 87.7 lbs (39.8kg) fully loaded; 5.12" x 18.94" x 29.72"

## //X Connectivity

<b>ONBOARD PARTS (PER CONTROLLER)</b>	<b>HOST I/O CARDS (3 SLOTS/CONTROLLER)</b>	
<ul style="list-style-type: none"> <li>• 2 × 1/10/25Gb Ethernet</li> <li>• 2 × 1/10/25Gb Ethernet Replication</li> <li>• 2 × 1Gb Management Ports</li> </ul>	<ul style="list-style-type: none"> <li>• 2-port 10GBase-T Ethernet</li> <li>• 2-port 1/10/25Gb Ethernet</li> <li>• 2-port 40Gb Ethernet</li> </ul>	<ul style="list-style-type: none"> <li>• 2-port 25/50Gb NVMe/RoCE</li> <li>• 2-port 16/32Gb Fibre Channel (NVMe-oF Ready)</li> <li>• 4-port 16/32Gb Fibre Channel (NVMe-oF Ready)</li> </ul>

\*\* Effective capacity assumes HA, RAID, and metadata overhead, GB-to-GiB conversion, and includes the benefit of data reduction with always-on inline deduplication, compression, and pattern removal. Average data reduction is calculated at 5-to-1 and does not include thin provisioning or snapshots.

† Array accepts Pure Storage DirectFlash Shelf and/or Pure Storage SAS-based expansion shelf.

## Evergreen™ Storage

Customers can deploy storage once and enjoy a subscription to continuous innovation through Pure's Evergreen Storage ownership model: expand and improve performance, capacity, density, and/or features for 10 years or more – all without downtime, performance impact, or data migrations. Pure has disrupted the industry's 3-5-year rip-and-replace cycle by engineering compatibility for future technologies right into its products, notably nondisruptive capability to upgrade from //M to //X with NVMe, DirectMemory, and NVMe-oF capability.

## Pure1®

Pure1, our cloud-based management, analytics, and support platform, expands the self-managing, plug-n-play design of Pure all-flash arrays with the machine learning predictive analytics and continuous scanning of Pure1 Meta™ to enable an effortless, worry-free data platform.

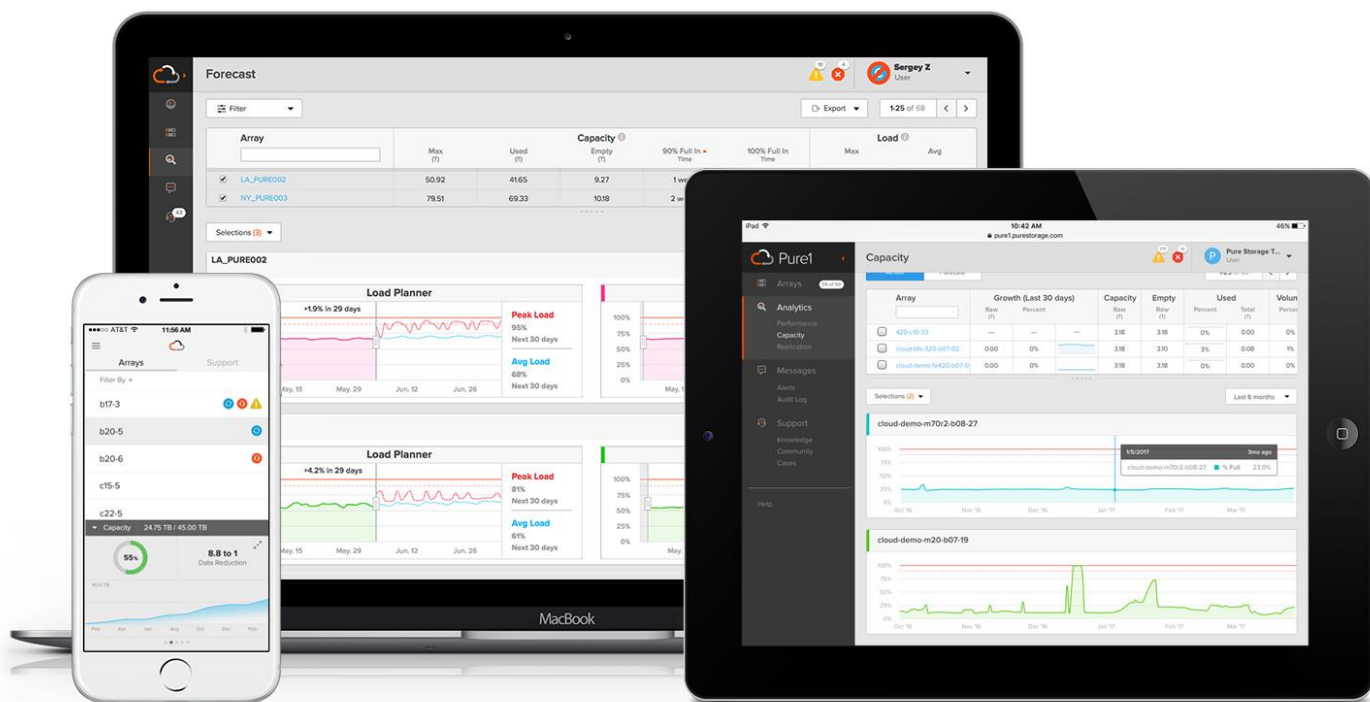

## Pure1 Manage

In the Cloud IT operating model, installing, and deploying management software is an oxymoron: you simply log-in. Pure1 Manage is SaaS-based, allowing you to manage your array from any browser or from the Pure1 Mobile App – with nothing extra to purchase, deploy, or maintain. From a single dashboard you can manage all your arrays, with full visibility on the health and performance of your storage.

## Pure1 Analyze

Pure1 Analyze delivers true performance forecasting – giving customers complete visibility into the performance and capacity needs of their arrays – now and in the future. Performance forecasting enables intelligent consolidation and unprecedented workload optimization.

## Pure1 Support

Pure combines an ultra-proactive support team with the predictive intelligence of Pure1 Meta to deliver unrivaled support that's a key component in our proven FlashArray 99.9999% availability. Customers are often surprised and delighted when we fix issues they did not even know existed.

## Pure1 META

The foundation of Pure1 services, Pure1 Meta is global intelligence built from a massive collection of storage array health and performance data. By continuously scanning call-home telemetry from Pure's installed base, Pure1 Meta uses machine learning predictive analytics to help resolve potential issues and optimize workloads. The result is both a white glove customer support experience and breakthrough capabilities like accurate performance forecasting.

Meta is always expanding and refining what it knows about array performance and health, moving the Data Platform toward a future of self-driving storage.

## Pure1 VM Analytics

Pure1 helps you narrow down the troubleshooting steps in your virtualized environment. VM Analytics provides you with a visual representation of the IO path from the VM all the way through to the FlashArray. Other tools and features guide you through identifying where an issue might be occurring in order to help eliminate potential candidates for a problem.

VM Analytics doesn't only help when there's a problem. The visualization allows you to identify which volumes and arrays particular applications are running on. This brings the whole environment into a more manageable domain.

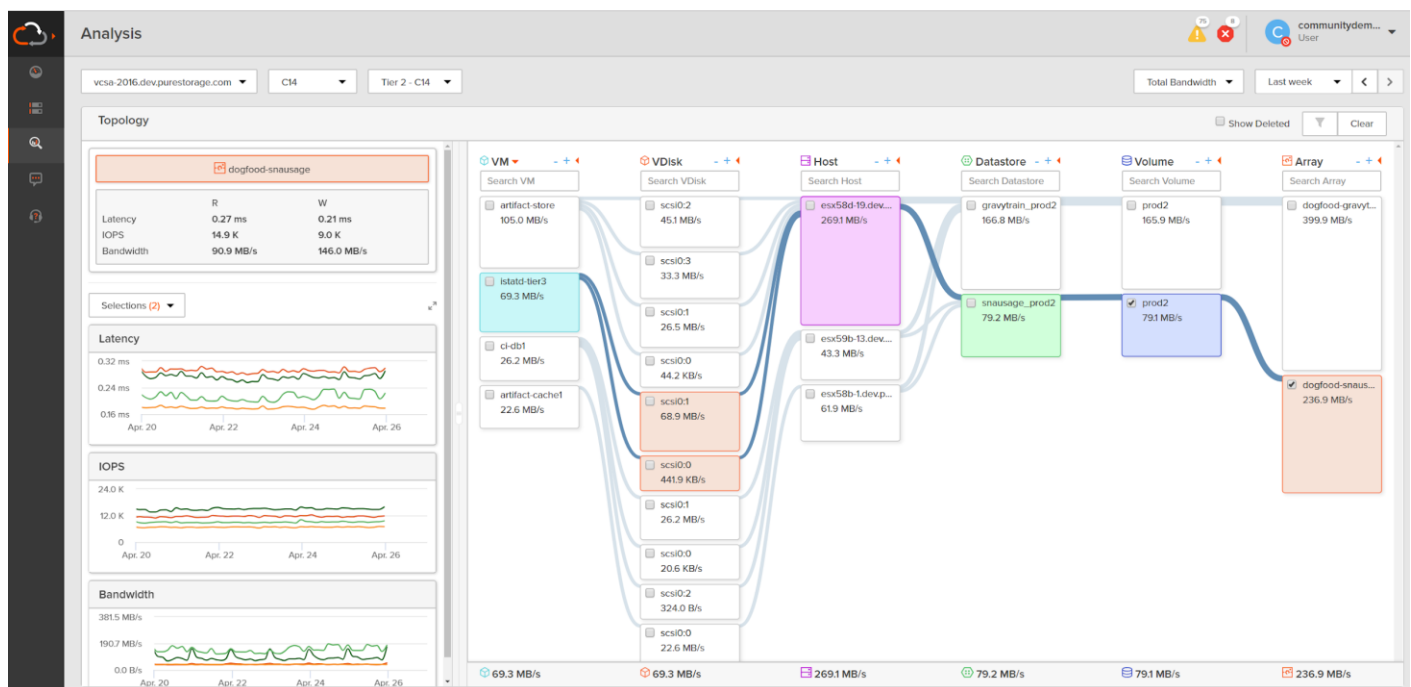

## Hypervisor

This Cisco Validated Design includes VMware vSphere ESXi 7.0 GA.



---

## VMware vSphere 7.0

VMware provides virtualization software. VMware's enterprise software hypervisors for servers VMware vSphere ESX, vSphere ESXi, and vSphere—are bare-metal hypervisors that run directly on server hardware without requiring an additional underlying operating system. VMware vCenter Server for vSphere provides central management and complete control and visibility into clusters, hosts, virtual machines, storage, networking, and other critical elements of your virtual infrastructure.

vSphere 7 is the latest major vSphere release from VMware. vSphere 7 has been rearchitected with native Kubernetes to enable IT Admins to use vCenter Server® to operate Kubernetes clusters through namespaces. VMware vSphere with Tanzu allows IT Admins to operate with their existing skillset and deliver a self-service access to infrastructure for the Dev Ops teams; while providing observability and troubleshooting for Kubernetes workloads. vSphere 7 provides an enterprise platform for both traditional applications as well as modern applications – so customers and partners can deliver a developer-ready infrastructure, scale without compromise and simplify operations.

**Deliver Developer-ready Infrastructure:** IT teams can use existing vSphere environments to set up an Enterprise-grade Kubernetes infrastructure at a rapid pace (within one hour), while enabling enterprise-class governance, reliability, and security. After this one-time setup, vSphere with Tanzu enables a simple, fast, and self-service provisioning of Tanzu Kubernetes clusters within a few minutes<sup>1</sup>. Aligning DevOps teams and IT teams is critical to the success of modern application development; to bring efficiency, scale and security to Kubernetes deployments and operations. vSphere with Tanzu brings agile cloud operations to the IT admin to enable this transition into the role of Cloud Admin or SRE by delivering agility in day-to-day IT operations related to Kubernetes infrastructure.

**Scale Without Compromise:** vSphere can scale your infrastructure to meet the demands of high-performance applications and memory intensive databases including SAP HANA and Epic Caché Operational Database to name a few. With vSphere 7, a vSphere cluster can now support 50 percent more hosts compared to previous releases.

**Simplify Operations:** Simplified operations are delivered through key capabilities of vSphere 7 including elastic AI/ML infrastructure for sharing resources, simplified lifecycle management and intrinsic security across your hybrid cloud infrastructure.

The key features and capabilities are as follows:

- **TKG Service<sup>2</sup>:** Run the Tanzu Kubernetes Grid Service directly on vSphere to simplify operation of Kubernetes on-premises by putting cloud native constructs at the IT Admin's fingertips. TKG allows IT admins to manage consistent, compliant, and conformant Kubernetes, while providing developers self-service access to infrastructure. vSphere with Tanzu enables a simple, fast, and self-service provisioning of Tanzu Kubernetes clusters within a few minutes<sup>1</sup>
- **Drop-in to Existing Infrastructure<sup>2</sup>:** Quickly deploy Kubernetes workloads on existing infrastructure with enterprise-grade governance, reliability, and security. Leverage existing networking infrastructure (or BYO networking) using vSphere Distributed Switch's (VDS) centralized interface to configure, monitor and administer switching access for VMs and Kubernetes workloads. Deploy existing block and file storage infrastructure (BYO storage) for containerized workloads. Choose your own L4 load balancing solution using HAProxy (commercial support offered directly by HAProxy) for Tanzu Kubernetes clusters.

- Application focused management<sup>2</sup>: Kubernetes makes vSphere better by providing DevOps teams (Platform Operators and SREs) with self-service access to infrastructure through Kubernetes APIs. vSphere makes Kubernetes better by empowering IT admins to use vCenter Server skills/tools to operate modern applications, alongside VMs, using namespaces as a unit of management. This is referred to as 'application focused management'. Using application focused management, IT admins can use vCenter Server to observe and troubleshoot Tanzu Kubernetes clusters alongside VMs, implement role-based access and allocate capacity to developer teams.
- Monster VMs: Deliver industry leading scale through Monster VMs designed for SAP HANA and Epic Cache Operational Database. Improve performance and scale for Monster VMs to support your large scale up environments. Scale up to 24TB memory and support up to 768 vCPUs through Monster VMs, leaving other hypervisor vendors far behind in the category. Speed-up the ESXi scheduler and co-scheduling logic for large VMs using selective latency sensitivity setting for workloads, removal of bottlenecks in vCPU sleep/wakeup paths and a reduced memory overhead.
- Cluster scale enhancements: Expand the number of hosts per cluster by 50% to support a total of 96 hosts per cluster, compared to previous releases.
- vLCM enhancements: Simplify software upgrades, patching, and firmware updates for vSphere, vSAN and NSX-T with a single tool. vLCM will also monitor for desired image compliance continuously and enable simple remediation in the event of any compliance drift.
- vSphere Ideas<sup>®</sup>: Submit feature requests right from the vSphere Client UI, track the status of the feature requests and look at all the other feature requests submitted by other users to vote for them, through the Ideas portal.
- vCenter connect<sup>®</sup>: Manage on-premises and off-premises (cloud providers) vCenter Servers in a single interface using the any to any vCenter connect capability

Additional information about VMware vSphere 7 can be found [here](#).

## Desktop Broker

This Cisco Validated Design includes VMware Horizon 7.12.

### VMware Horizon Version 7

Enterprise IT organizations are tasked with the challenge of provisioning Microsoft Windows apps and desktops while managing cost, centralizing control, and enforcing corporate security policy. Deploying Windows apps to users in any location, regardless of the device type and available network bandwidth, enables a mobile workforce that can improve productivity. With VMware Horizon 7, IT can effectively control app and desktop provisioning while securing data assets and lowering capital and operating expenses.

### VMware Horizon

VMware Horizon desktop virtualization solutions built on a unified architecture, so they are simple to manage and flexible enough to meet the needs of all your organization's users. You use the same architecture and management tools to manage public, private, and hybrid cloud deployments as you do for on premises deployments

VMware Horizon Virtual machines and RDSH known as server-based hosted sessions: These are applications hosted from Microsoft Windows servers to any type of device, including Windows PCs, Macs, smartphones, and tablets. Some VMware editions include technologies that further optimize the experience of using Windows applications on a mobile device by automatically translating native mobile-device display, navigation, and controls

---

to Windows applications; enhancing performance over mobile networks; and enabling developers to optimize any custom Windows application for any mobile environment.

VMware Horizon RDSH session users also known as server-hosted desktops: These are inexpensive, locked-down Windows virtual desktops hosted from Windows server operating systems. They are well suited for users, such as call center employees, who perform a standard set of tasks.

### **Advantages of Using VMware Horizon**

VMware Horizon 7 provides the following new features and enhancements:

- Instant Clones
  - A new type of desktop virtual machines that can be provisioned significantly faster than the traditional Composer linked clones.
- A fully functional desktop can be provisioned in two seconds or less.
  - Recreating a desktop pool with a new OS image can be accomplished in a fraction of the time it takes a Composer desktop pool because the parent image can be prepared well ahead of the scheduled time of pool recreation.
- Clones are automatically rebalanced across available datastores.
- View storage accelerator is automatically enabled.
- VMware Blast Extreme
  - VMware Blast Extreme is now fully supported on the Horizon platform.
  - Administrators can select the VMware Blast display protocol as the default or available protocol for pools, farms, and entitlements.
  - End users can select the VMware Blast display protocol when connecting to remote desktops and applications.
- VMware Blast Extreme features include:
  - TCP and UDP transport support
  - H.264 support for the best performance across more devices
  - Reduced device power consumption for longer battery life
  - NVIDIA GRID acceleration for more graphical workloads per server, better performance, and a superior remote user experience
- True SSO
  - For VMware Identity Manager integration, True SSO streamlines the end-to-end login experience. After users log in to VMware Identity Manager using a smart card or an RSA SecurID or RADIUS token, users are not required to also enter Active Directory credentials in order to use a remote desktop or application.
  - Uses a short-lived Horizon virtual certificate to enable a password-free Windows login.
  - Supports using either a native Horizon Client or HTML Access.
  - System health status for True SSO appears in the Horizon Administrator dashboard.

- Can be used in a single domain, in a single forest with multiple domains, and in a multiple-forest, multiple-domain setup.
- Smart Policies
  - Control of the clipboard cut-and-paste, client drive redirection, USB redirection, and virtual printing desktop features through defined policies.
  - PCoIP session control through PCoIP profiles.
  - Conditional policies based on user location, desktop tagging, pool name, and Horizon Client registry values.
- Configure the clipboard memory size for VMware Blast and PCoIP sessions
  - Horizon administrators can configure the server clipboard memory size by setting GPOs for VMware Blast and PCoIP sessions. Horizon Client 4.1 users on Windows, Linux, and Mac OS X systems can configure the client clipboard memory size. The effective memory size is the lesser of the server and client clipboard memory size values.
- VMware Blast network recovery enhancements
  - Network recovery is now supported for VMware Blast sessions initiated from iOS, Android, Mac OS X, Linux, and Chrome OS clients. Previously, network recovery was supported only for Windows client sessions. If you lose your network connection unexpectedly during a VMware Blast session, Horizon Client attempts to reconnect to the network and you can continue to use your remote desktop or application. The network recovery feature also supports IP roaming, which means you can resume your VMware Blast session after switching to a WiFi network.
- Configure Horizon Administrator to not remember the login name
  - Horizon administrators can configure not to display the Remember user name check box and therefore not remember the administrator's login name.
- Allow Mac OS X users to save credentials
  - Horizon administrators can configure Connection Server to allow Horizon Client Mac OS X systems to remember a user's user name, password, and domain information. If users choose to have their credentials saved, the credentials are added to the login fields in Horizon Client on subsequent connections.
- Microsoft Windows 10
  - Windows 10 is supported as a desktop guest operating system
  - Horizon Client runs on Windows 10
  - Smart card is supported on Windows 10
  - The Horizon User Profile Migration tool migrates Windows 7, 8/8.1, Server 2008 R2, or Server 2012 R2 user profiles to Windows 10 user profiles.
- RDS Desktops and Hosted Apps
  - **View Composer.** View Composer and linked clones provide automated and efficient management of RDS server farms.
  - **Graphics Support.** Existing 3D vDGA and GRID vGPU graphics solutions on VDI desktops have been extended to RDS hosts, enabling graphics-intensive applications to run on RDS desktops and Hosted Apps.

- **Enhanced Load Balancing.** A new capability provides load balancing of server farm applications based on memory and CPU resources.
- **One-Way AD Trusts.** One-way AD trust domains are now supported. This feature enables environments with limited trust relationships between domains without requiring Horizon Connection Server to be in an external domain.
- Cloud Pod Architecture (CPA) Enhancements
  - Hosted App Support. Support for application remoting allows applications to be launched using global entitlements across a pod federation.
  - HTML Access (Blast) Support. Users can use HTML Access to connect to remote desktops and applications in a Cloud Pod Architecture deployment.
- Access Point Integration
  - Access Point is a hardened Linux-based virtual appliance that protects virtual desktop and application resources to allow secure remote access from the Internet. Access Point provides a new authenticating DMZ gateway to Horizon Connection Server. Smart card support on Access Point is available as a Tech Preview. Security server will continue to be available as an alternative configuration. For more information, see [Deploying and Configuring Access Point](#).
- FIPS
  - Install-time FIPS mode allows customers with high security requirements to deploy Horizon 6.
- Graphics Enhancements
  - AMD vDGA enables vDGA pass-through graphics for AMD graphics hardware.
  - 4K resolution monitors (3840x2160) are supported.
- Horizon Administrator Enhancements
  - Horizon Administrator shows additional licensing information, including license key, named user and concurrent connection user count.
  - Pool creation is streamlined by letting Horizon administrators to clone existing pools.
- Additional Features
  - Support for IPv6 with VMware Blast Extreme on security servers.
  - Horizon Administrator security protection layer. See VMware Knowledge Base (KB) article 2144303 for more information:  
[https://kb.vmware.com/selfservice/microsites/search.do?language=en\\_US&cmd=displayKC&externalId=2144303](https://kb.vmware.com/selfservice/microsites/search.do?language=en_US&cmd=displayKC&externalId=2144303)
  - Protection against inadvertent pool deletion.
  - RDS per-device licensing improvements.
  - Support for Intel vDGA.
  - Support for AMD Multiuser GPU Using vDGA.
  - More resilient upgrades.
  - Display scaling for Windows Horizon Clients.
  - DPI scaling is supported if it is set at the system level and the scaling level is greater than 100.



---

## What are VMware RDS Hosted Sessions?

The following describes the VMware RDS Hosted Sessions:

- An RDS host is a server computer that hosts applications and desktop sessions for remote access. An RDS host can be a virtual machine or a physical server.
- An RDS host has the Microsoft Remote Desktop Services role, the Microsoft Remote Desktop Session Host service, and Horizon Agent installed. Remote Desktop Services was previously known as Terminal Services. The Remote Desktop Session Host service allows a server to host applications and remote desktop sessions. With Horizon Agent installed on an RDS host, users can connect to applications and desktop sessions by using the display protocol PCoIP or Blast Extreme. Both protocols provide an optimized user experience for the delivery of remote content, including images, audio, and video.
- The performance of an RDS host depends on many factors. For information on how to tune the performance of different versions of Windows Server, see <http://msdn.microsoft.com/library/windows/hardware/gg463392.aspx>.
- Horizon 7 supports at most one desktop session and one application session per user on an RDS host.

When users submit print jobs concurrently from RDS desktops or applications that are hosted on the same RDS host, the ThinPrint server on the RDS host processes the print requests serially rather than in parallel. This can cause a delay for some users. Note that the print server does not wait for a print job to complete before processing the next one. Print jobs that are sent to different printers will print in parallel.

If a user launches an application and also an RDS desktop, and both are hosted on the same RDS host, they share the same user profile. If the user launches an application from the desktop, conflicts may result if both applications try to access or modify the same parts of the user profile, and one of the applications may fail to run properly.

The process of setting up applications or RDS desktops for remote access involves the following task:

- Installing Applications

If you plan to create application pools, you must install the applications on the RDS hosts. If you want Horizon 7 to automatically display the list of installed applications, you must install the applications so that they are available to all users from the Start menu. You can install an application at any time before you create the application pool. If you plan to manually specify an application, you can install the application at any time, either before or after creating an application pool.



**IMPORTANT:** When you install an application, you must install it on all the RDS hosts in a farm and in the same location on each RDS host. If you do not, a health warning will appear on the View Administrator dashboard. In such a situation, if you create an application pool, users might encounter an error when they try to run the application.

When you create an application pool, Horizon 7 automatically displays the applications that are available to all users rather than individual users from the Start menu on all of the RDS hosts in a farm. You can choose any applications from that list. In addition, you can manually specify an application that is not available to all users from the Start menu. There is no limit on the number of applications that you can install on an RDS host.

---

---

## Farms, RDS Hosts, Desktop, and Application Pools

With VMware Horizon, you can create desktop and application pools to give users remote access to virtual machine-based desktops, session-based desktops, physical computers, and applications. Horizon takes advantage of Microsoft Remote Desktop Services (RDS) and VMware PC-over-IP (PCoIP) technologies to provide high-quality remote access to users.

### RDS Hosts

RDS hosts are server computers that have Windows Remote Desktop Services and View Agent installed. These servers host applications and desktop sessions that users can access remotely. To use RDS desktop pools or applications, your end users must have access to Horizon Client 3.0 or later software.

### Desktop Pools

There are three types of desktop pools: automated, manual, and RDS. Automated desktop pools use a vCenter Server virtual machine template or snapshot to create a pool of identical virtual machines. Manual desktop pools are a collection of existing vCenter Server virtual machines, physical computers, or third-party virtual machines. In automated or manual pools, each machine is available for one user to access remotely at a time. RDS desktop pools are not a collection of machines, but instead, provide users with desktop sessions on RDS hosts. Multiple users can have desktop sessions on an RDS host simultaneously.

### Application Pools

Application pools let you deliver applications to many users. The applications in application pools run on a farm of RDS hosts.

### Farms

Farms are collections of RDS hosts and facilitate the management of those hosts. Farms can have a variable number of RDS hosts and provide a common set of applications or RDS desktops to users. When you create an RDS desktop pool or an application pool, you must specify a farm. The RDS hosts in the farm provide desktop and application sessions to users.

Some of the latest VMware Horizon features and enhancements are:

- Flash Redirection

You can compile a black list to ensure that the URLs specified in the list will not be able to redirect Flash content. You must enable the GPO setting `FlashMMRUriListEnableType` to use either a white list or black list.

- Horizon Agent Policy Settings

The `VMwareAgentCIT` policy setting enables remote connections to Internet Explorer to use the Client's IP address instead of the IP address of the remote desktop machine.

The `FlashMMRUriListEnableType` and `FlashMMRUriList` policy settings specify and control the white list or black list that enables or disables the list of URLs from using Flash Redirection.

- Horizon PowerCLI

---

View PowerCLI is deprecated. Horizon PowerCLI replaces View PowerCLI and includes cmdlets that you can use with VMware PowerCLI.

For more information about Horizon PowerCLI cmdlets, read the *VMware PowerCLI Cmdlets Reference*.

For information on the API specifications to create advanced functions and scripts to use with Horizon PowerCLI, see the API Reference at the [VMware Developer Center](#)

For more information on sample scripts that you can use to create your own Horizon PowerCLI scripts, see the [Horizon PowerCLI community on GitHub](#).

- Horizon 7 for Linux desktops enhancements
  - **UDP based Blast Extreme connectivity**

User Datagram Protocol (UDP) is enabled by default in both the client and the agent. Note that Transmission Control Protocol (TCP) connectivity will have a better performance than UDP on the Local Area Network (LAN). UDP will have better performance than TCP over Wide Area Network (WAN). If you are on a LAN, disable the UDP feature to switch to using TCP to get better connectivity performance.
  - **KDE support**

K Desktop Environment (KDE) support is now also available on CentOS 7, RHEL 7, Ubuntu 14.04, Ubuntu 16.04, and SLED 11 SP4 platforms.
  - **MATE support**

MATE desktop environment is supported on Ubuntu 14.04 and 16.04 virtual machines.
  - **Hardware H.264 Encoder**

The hardware H.264 encoder is now available and used when the vGPU is configured with the NVIDIA graphics card that has the NVIDIA driver 384 series or later installed on it.
  - **Additional platforms support**

RHEL 7.4 x64 and CentOS 7.4 x64 are now supported.
  - Remote Desktop Operating System
  - Windows 10 version 1607 Long-Term Servicing Branch (LTSB)
  - Windows Server 2016

## Horizon Agent

- HTML5 Multimedia Redirection

You can install the HTML5 Multimedia Redirection feature by selecting the HTML5 Multimedia Redirection custom setup option in the Horizon Agent installer. With HTML5 Multimedia Redirection, if an end user uses the Chrome browser, HTML5 multimedia content is sent from the remote desktop to the client system, reducing the load on the ESXi host. The client system plays the multimedia content, and the user has a better audio and video experience.
- SHA-256 support

Horizon Agent has been updated to support the SHA-256 cryptographic hash algorithm. SHA-256 is also supported in Horizon Client 4.6 and Horizon 7 version 7.2 and later.
- Improved USB redirection with User Environment Manager

---

The default User Environment Manager timeout value has been increased. This change makes sure that the USB redirection smart policy takes effect even when the login process takes a long time. With Horizon Client 4.6, the User Environment Manager timeout value is configured only on the agent and is sent from the agent to the client.

You can now bypass User Environment Manager control of USB redirection by setting a registry key on the agent machine. This change helps ensure that smart card SSO works on Teradici zero clients.

- Composer

For enhanced security, you can enable the digest access authentication method for Composer.

- Persona Management

Persona Management supports guest operating systems that use the "v6" version of the user profile.

You can use the migration tool to migrate the "v2" and "v5" user profiles versions to the "v6" user profile version. The tool is installed with the Persona binary file.

## Horizon Connection Server Enhanced Features

- Horizon Help Desk Tool

- View application and process names and resource use within a virtual or published desktop to identify which applications and process are using up machine resources.
- View event log information about the user's activities.
- View updated metrics such as Horizon Client version and the Blast protocol.
- View additional session metrics such as the VM information, CPU, or memory usage.

You can assign predefined administrator roles to Horizon Help Desk Tool administrators to delegate the troubleshooting tasks between administrator users. You can also create custom roles and add privileges based on the predefined administrator roles.

You can verify the product license key for Horizon Help Desk Tool and apply a valid license.

- Monitoring

If the event database shuts down, Horizon Administrator maintains an audit trail of the events that occur before and after the event database shutdown.

- Instant Clones

You can create dedicated instant-clone desktop pools.

Windows Server operating systems are supported for instant clones in this release. For an updated list of supported Windows Server operating systems, see the VMware Knowledge Base (KB) article [2150295](#).

You can copy, paste, or enter the path for the AD tree in the AD container field when you create an instant-clone desktop pool.

If there are no internal VMs in all four internal folders created in vSphere Web Client, these folders are unprotected, and you can delete these folders.

You can use the enhanced instant-clone maintenance utility `lcUnprotect.cmd` to unprotect or delete template, replica, or parent VMs or folders from vSphere hosts.

---

Instant clones are compatible with Storage DRS (sDRS). Therefore, instant clones can reside in a datastore that is part of an sDRS cluster.

- Cloud Pod Architecture
  - The total session limit is increased to 140,000.
  - The site limit is increased to 7.

You can configure Windows Start menu shortcuts for global entitlements. When an entitled user connects to a Connection Server instance in the pod federation, Horizon Client for Windows places these shortcuts in the Start menu on the user's Windows client device.

- Published Desktops and Application Pools

You can restrict access to entitled desktop pools, application pools, global entitlements, and global application entitlements from certain client computers.

You can configure Windows start menu shortcuts for entitled desktop and application pools. When an entitled user connects to a Connection Server instance, Horizon Client for Windows places these shortcuts in the Start menu on the user's Windows client device.

- Virtual Desktops and Desktop Pools

Blast Extreme provides network continuity during momentary network loss on Windows clients.

Performance counters displayed using PerfMon on Windows agents for Blast session, imaging, audio, CDR, USB, and virtual printing provide an accurate representation of the current state of the system that also updates at a constant rate.

- Customer Experience Improvement Program

Details regarding the data collected through CEIP and the purposes for which it is used by VMware are set forth at the [Trust Assurance Center](#).

- Security

With the USB over Session Enhancement SDK feature, you do not need to open TCP port 32111 for USB traffic in a DMZ-based security server deployment. This feature is supported for both virtual desktops and published desktops on RDS hosts.

- Database Support

The Always On Availability Groups feature for Microsoft SQL Server 2014 is supported in this release of Horizon 7. For more information, refer to the [Release Notes](#).

## Supported Windows Operating Systems

Horizon 7 version 7.10 supports the following [Windows 10](#) operating systems:

- Win 10 1607 LTSB (Enterprise)
- Win 10 1703 CBB / Semi-Annual Channel (broad deployment) (Enterprise, Professional, Education)
- Win 10 1709 Semi-Annual Channel (broad deployment) (Enterprise, Professional, Education)
- Windows 10 1809 LTSC (Enterprise)



- Windows 10 1903 SAC (Pro, Education, Enterprise)
- Windows 10 1909 SAC (Pro, Education, Enterprise)

For the complete list of supported Windows on Horizon including all VDI (Full Clones, Linked, and Instant clones) click the following links: <https://kb.vmware.com/s/article/2149393> and [https://kb.vmware.com/s/article/2150295?r=2&Quarterback.validateRoute=1&KM\\_Utility.getArticleData=1&KM\\_Utility.getGUser=1&KM\\_Utility.getArticleLanguage=2&KM\\_Utility.getArticle=1](https://kb.vmware.com/s/article/2150295?r=2&Quarterback.validateRoute=1&KM_Utility.getArticleData=1&KM_Utility.getGUser=1&KM_Utility.getArticleLanguage=2&KM_Utility.getArticle=1)

---

 Windows 10 version 1809 being used in this solution.

---

Figure 18. Logical Architecture of VMware Horizon

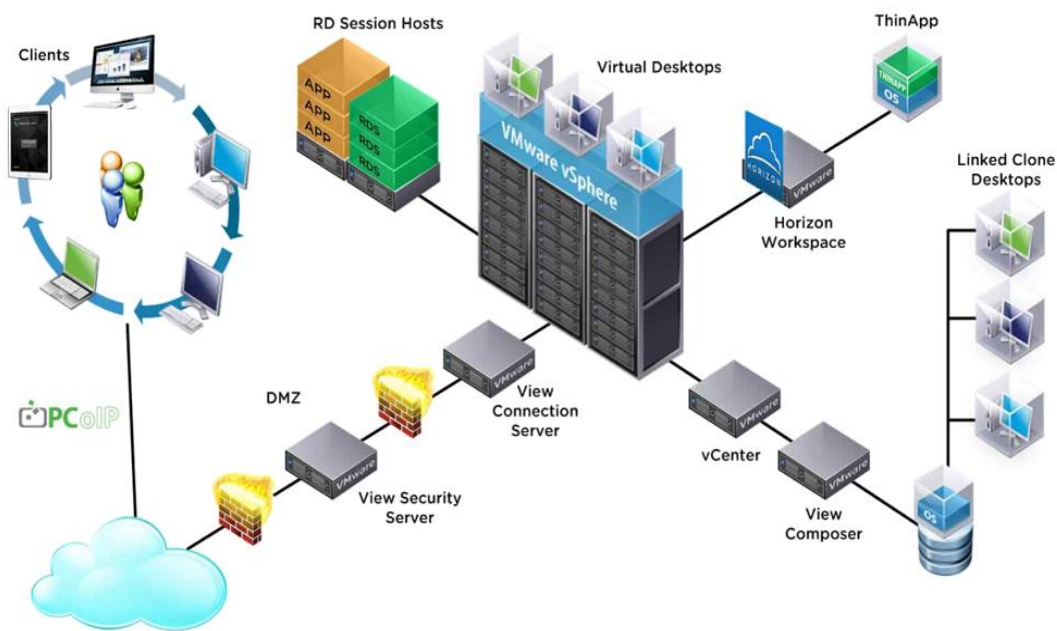

### VMware Horizon Composer

VMware Horizon Composer is a feature in Horizon that gives administrators the ability to manage virtual machine pools or the desktop pools that share a common [virtual disk](#). An administrator can update the [master image](#), then all desktops using [linked clones](#) of that master image can also be patched. Updating the master image will patch the cloned desktops of the users without touching their applications, data, or settings.

The VMware View Composer pooled desktops solution’s infrastructure is based on software-streaming technology. After installing and configuring the composed pooled desktops, a single shared disk image (Master Image) is taken a snapshot of the OS and application image, and then storing that snapshot file accessible to host(s).

Figure 19. VMware Horizon Composer

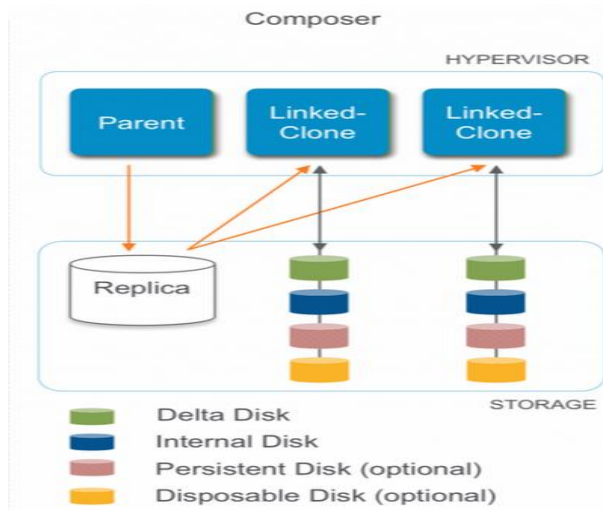

### Desktop Virtualization Design Fundamentals

An ever growing and diverse base of user devices, complexity in management of traditional desktops, security, and even Bring Your Own (BYO) device to work programs are prime reasons for moving to a virtual desktop solution.

### VMware Horizon Design Fundamentals

VMware Horizon 7 integrates Remote Desktop Server Hosted sessions users and VDI desktop virtualization technologies into a unified architecture that enables a scalable, simple, efficient, mixed users and manageable solution for delivering Windows applications and desktops as a service.

Users can select applications from an easy-to-use “store” that is accessible from tablets, smartphones, PCs, Macs, and thin clients. VMware Horizon delivers a native touch-optimized experience via PCoIP or Blast Extreme high-definition performance, even over mobile networks.

### Horizon VDI Pool and RDSH Servers Pool

Collections of identical Virtual Machines (VMs) or physical computers are managed as a single entity called a Desktop Pool. In this CVD, VM provisioning relies on VMware View Composer aligning with VMware Horizon Connection Server with vCenter Server components. In this CVD, machines in the Pools are configured to run either a Windows Server 2019 OS (for RDS Hosted shared sessions) and a Windows 10 Desktop OS (for pooled VDI desktops).

Figure 20. VMware Horizon Design Overview

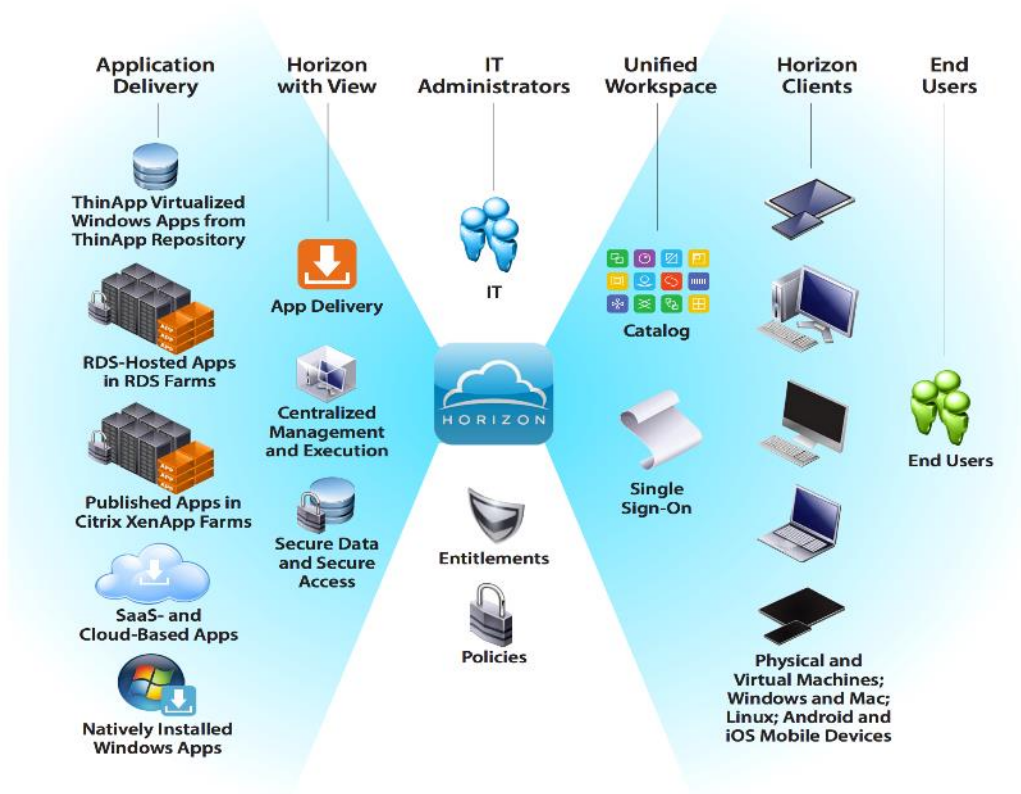
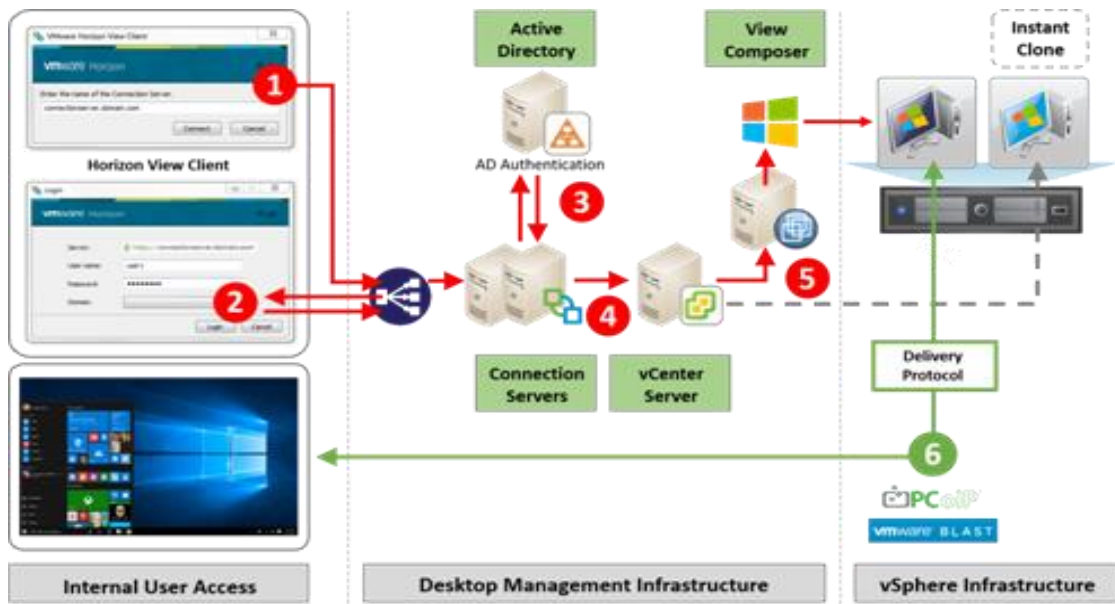

Figure 21. Horizon VDI and RDSH Desktop Delivery Based on Display Protocol (PCoIP/Blast/RDP)



---

## Architecture and Design Considerations for Desktop Virtualization

There are many reasons to consider a virtual desktop solution such as an ever growing and diverse base of user devices, complexity in management of traditional desktops, security, and even Bring Your Own Device (BYOD) to work programs. The first step in designing a virtual desktop solution is to understand the user community and the type of tasks that are required to successfully execute their role. The following user classifications are provided:

- Knowledge Workers today do not just work in their offices all day – they attend meetings, visit branch offices, work from home, and even coffee shops. These anywhere workers expect access to all of their same applications and data wherever they are.
- External Contractors are increasingly part of your everyday business. They need access to certain portions of your applications and data, yet administrators still have little control over the devices they use and the locations they work from. Consequently, IT is stuck making trade-offs on the cost of providing these workers a device vs. the security risk of allowing them access from their own devices.
- Task Workers perform a set of well-defined tasks. These workers access a small set of applications and have limited requirements from their PCs. However, since these workers are interacting with your customers, partners, and employees, they have access to your most critical data.
- Mobile Workers need access to their virtual desktop from everywhere, regardless of their ability to connect to a network. In addition, these workers expect the ability to personalize their PCs, by installing their own applications and storing their own data, such as photos and music, on these devices.
- Shared Workstation users are often found in state-of-the-art university and business computer labs, conference rooms or training centers. Shared workstation environments have the constant requirement to re-provision desktops with the latest operating systems and applications as the needs of the organization change, tops the list.

After the user classifications have been identified and the business requirements for each user classification have been defined, it becomes essential to evaluate the types of virtual desktops that are needed based on user requirements. There are essentially five potential desktops environments for each user:

- Traditional PC: A traditional PC is what typically constitutes a desktop environment: physical device with a locally installed operating system.
- Remoted Desktop Server Hosted Sessions: A hosted, server-based desktop is a desktop where the user interacts through a delivery protocol. With hosted, server-based desktops, a single installed instance of a server operating system, such as Microsoft Windows Server 2019, is shared by multiple users simultaneously. Each user receives a desktop "session" and works in an isolated memory space. Remoted Desktop Server Hosted Server sessions: A hosted virtual desktop is a virtual desktop running on a virtualization layer (ESX). The user does not work with and sit in front of the desktop, but instead the user interacts through a delivery protocol.
- Published Applications: Published applications run entirely on the VMware RDS server virtual machines and the user interacts through a delivery protocol. With published applications, a single installed instance of an application, such as Microsoft Office, is shared by multiple users simultaneously. Each user receives an application "session" and works in an isolated memory space.

- 
- **Streamed Applications:** Streamed desktops and applications run entirely on the user's local client device and are sent from a server on demand. The user interacts with the application or desktop directly, but the resources may only be available while they are connected to the network.
  - **Local Virtual Desktop:** A local virtual desktop is a desktop running entirely on the user's local device and continues to operate when disconnected from the network. In this case, the user's local device is used as a type 1 hypervisor and is synced with the data center when the device is connected to the network.
  - For the purposes of the validation represented in this document, both VMware VDI desktops and VMware RDS server sessions were validated. Each of the sections provides some fundamental design decisions for this environment.

## Understanding Applications and Data

When the desktop user groups and sub-groups have been identified, the next task is to catalog group application and data requirements. This can be one of the most time-consuming processes in the VDI planning exercise but is essential for the VDI project's success. If the applications and data are not identified and co-located, performance will be negatively affected.

The process of analyzing the variety of application and data pairs for an organization will likely be complicated by the inclusion of cloud applications, for example, Salesforce.com. This application and data analysis is beyond the scope of this Cisco Validated Design but should not be omitted from the planning process. There are a variety of third-party tools available to assist organizations with this crucial exercise.

## Project Planning and Solution Sizing Sample Questions

Now that user groups, their applications and their data requirements are understood, some key project and solution sizing questions may be considered.

General project questions should be addressed at the outset, including:

- Has a VDI pilot plan been created based on the business analysis of the desktop groups, applications, and data?
- Is there infrastructure and budget in place to run the pilot program?
- Are the required skill sets to execute the VDI project available? Can we hire or contract for them?
- Do we have end user experience performance metrics identified for each desktop sub-group?
- How will we measure success or failure?
- What is the future implication of success or failure?

Below is a short, non-exhaustive list of sizing questions that should be addressed for each user sub-group:

- What is the desktop OS planned? Windows 8 or Windows 10?
- 32 bit or 64 bit desktop OS?
- How many virtual desktops will be deployed in the pilot? In production? All Windows 8/10?
- How much memory per target desktop group desktop?
- Are there any rich media, Flash, or graphics-intensive workloads?

- 
- Are there any applications installed? What application delivery methods will be used, Installed, Streamed, Layered, Hosted, or Local?
  - What is the desktop OS planned for RDS Server Roles? Windows server 2016 or Server 2019?
  - Will VMware Horizon Composer or Instant Clones or another method be used for virtual desktop deployment?
  - What is the hypervisor for the solution?
  - What is the storage configuration in the existing environment?
  - Are there sufficient IOPS available for the write-intensive VDI workload?
  - Will there be storage dedicated and tuned for VDI service?
  - Is there a voice component to the desktop?
  - Is there a 3<sup>rd</sup> party graphics component?
  - Is anti-virus a part of the image?
  - What is the SQL server version for database? SQL server 2016 or 2019?
  - Is user profile management (for example, non-roaming profile based) part of the solution?
  - What is the fault tolerance, failover, disaster recovery plan?
  - Are there additional desktop sub-group specific questions?

## Hypervisor Selection

VMware vSphere has been identified the hypervisor for both RDS Sessions and VDI based desktops:

- VMware vSphere: VMware vSphere comprises the management infrastructure or virtual center server software and the hypervisor software that virtualizes the hardware resources on the servers. It offers features like Distributed Resource Scheduler, vMotion, high availability, Storage vMotion, VMFS, and a multi-pathing storage layer. More information on vSphere can be obtained at the [VMware web site](#).



For this CVD, the hypervisor used was VMware vSphere 7.0 GA.

---



Server OS and Desktop OS Machines configured in this CVD to support Remoted Desktop Server Hosted (RDSH) shared sessions and Virtual Desktops (both non-persistent and persistent).

---

## Storage Considerations

### Boot from SAN

When utilizing Cisco UCS Server technology, it is recommended to configure Boot from SAN and store the boot partitions on remote storage, this enabled architects and administrators to take full advantage of the stateless nature of service profiles for hardware flexibility across lifecycle management of server hardware generational



changes, Operating Systems/Hypervisors, and overall portability of server identity. Boot from SAN also removes the need to populate local server storage creating more administrative overhead.

## Pure Storage FlashArray Considerations

---



**Make sure Each FlashArray Controller is connected to BOTH storage fabrics (A/B).**

---

Within Purity, it's best practice to map Hosts to Host Groups and then Host Groups to Volumes, this ensures the Volume is presented on the same LUN ID to all hosts and allows for simplified management of ESXi Clusters across multiple nodes.

How big should a Volume be? With the Purity Operating Environment, we remove the complexities of aggregates, RAID groups, and so on. When managing storage, you just create a volume based on the size required, availability and performance are taken care of through RAID-HD and DirectFlash Software. As an administrator you can create 1 10TB volume or 10 1TB Volumes and their performance/availability will be the same, so instead of creating volumes for availability or performance you can think about recoverability, manageability, and administrative considerations. For example, what data do I want to present to this application or what data do I want to store together so I can replicate it to another site/system/cloud, and so on.

### Port Connectivity

10/25/40Gbe connectivity support – while both 10 and 25 Gbe is provided through 2 onboard NICs on each FlashArray controller, if more interfaces are required or if 40Gbe connectivity is also required, then make sure to provision for additional NICs have been included in the original FlashArray BOM.

16/32Gb Fiber Channel support (N-2 support) – Pure Storage offer up to 32Gb FC support on the latest FlashArray//X series arrays. Always make sure the correct number of HBAs and the speed of SFPs are included in the original FlashArray BOM.

### Oversubscription

To reduce the impact of an outage or maintenance scheduled downtime it is good practice when designing fabrics to provide oversubscription of bandwidth, this enables a similar performance profile during component failure and protects workloads from being impacted by a reduced number of paths during a component failure or maintenance event. Oversubscription can be achieved by increasing the number of physically cabled connections between storage and compute. These connections can then be utilized to deliver performance and reduced latency to the underlying workloads running on the solution.

### Topology

When configuring your SAN, it's important to remember that the more hops you have, the more latency you will see. For best performance, the ideal topology is a "Flat Fabric" where the FlashArray is only one hop away from any applications being hosted on it.

### VMware Virtual Volumes Considerations

vCenters that are in Enhanced Linked Mode will each be able to communicate with the same FlashArray, however vCenters that are not in Enhanced Linked Mode must use CA-Signed Certificates using the same FlashArray. If multiple vCenters need to use the same FlashArray for vVols, they should be configured in Enhanced Linked Mode.

---

Ensure that the Config vVol is either part of an existing FlashArray Protection Group, Storage Policy that includes snapshots, or manual snapshots of the Config vVol are taken. This will help with the VM recovery process if the VM is deleted.

There are some FlashArray limits on Volume Connections per Host, Volume Count, and Snapshot Count. For more information about FlashArray limits review the following:  
[https://support.purestorage.com/FlashArray/PurityFA/General\\_Troubleshooting/Pure\\_Storage\\_FlashArray\\_Limits](https://support.purestorage.com/FlashArray/PurityFA/General_Troubleshooting/Pure_Storage_FlashArray_Limits)

When a Storage Policy is applied to a vVol VM, the volumes associated with that VM are added to the designated protection group when applying the policy to the VM. If replication is part of the policy, be mindful of the amount of VMs using that storage policy and replication group. A large amount of VMs with a high change rate could cause replication to miss its schedule due to increased replication bandwidth and time needed to complete the scheduled snapshot. Pure Storage recommends vVol VMs that have Storage Policies applied be balanced between protection groups.

### **Pure Storage FlashArray Best Practices for VMware vSphere 7.0**

The following Pure Storage best practices for VMware vSphere should be followed as part of a design:

- FlashArray Volumes are automatically presented to VMware vSphere using the Round Robin Path Selection Policy (PSP) and appropriate vendor Storage Array Type Plugin (SATP) for vSphere 7.0.
- vSphere 7.0 also uses the Latency SATP that was introduced in vSphere 6.7U1 (This replaces the I/O Operations Limit of 1 SATP, which was the default from vSphere 6.5U1).
- When using iSCSI connected FlashArray volumes, it is recommended to set DelayedAck to false (disabled) and LoginTimeout to 30 seconds. Jumbo Frames are optional when using iSCSI.
- In vSphere 6.x, if hosts have any VMFS-5 volumes, change EnableBlockDelete to enabled. If it is all VMFS-6, this change is not needed.
- For VMFS-5, Run UNMAP frequently.
- For VMFS-6, keep automatic UNMAP enabled.
- DataMover.HardwareAcceleratedMove, DataMover.HardwareAcceleratedInit, and VMFS3.HardwareAcceleratedLocking should all be enabled.
- Ensure all ESXi hosts are connected to both FlashArray controllers. A minimum of two paths to each. Aim for total redundancy.
- Install VMware tools or Open VM tools whenever possible.
- Queue depths should be left at the default. Changing queue depths on the ESXi host is a tweak and should only be examined if a performance problem (high latency) is observed.
- When mounting snapshots, use the ESXi resignature option and avoid force-mounting.
- Configure Host Groups on the FlashArray identically to clusters in vSphere. For example, if a cluster has four hosts in it, create a corresponding Host Group on the relevant FlashArray with exactly those four hosts—no more, no less.
- When possible, use Paravirtual SCSI adapters for virtual machines.

- Atomic Test and Set (ATS) is required on all Pure Storage volumes. This is a default configuration, and no changes should normally be needed.
- UseATSFoHBOonVMFS5 should be enabled. This was introduced in vSphere 5.5 U2 and is enabled by default. It is NOT required though.

For more information about the VMware vSphere Pure Storage FlashArray Best Practices, see:

[https://support.purestorage.com/Solutions/VMware\\_Platform\\_Guide/001VMwareBestPractices/hhhWeb\\_Guide%3A\\_FlashArray\\_VMware\\_Best\\_Practices](https://support.purestorage.com/Solutions/VMware_Platform_Guide/001VMwareBestPractices/hhhWeb_Guide%3A_FlashArray_VMware_Best_Practices)

### **Pure Storage FlashArray Best Practices for VMware Virtual Volumes (vVols)**

Along with the Pure Storage Best Practices for VMware vSphere, the following should be considered as part of a design that includes the implementation of vVols as part of the solution:

- Create a Local FlashArray Array Admin user to register the storage provider with vs using the local pu-reuser account, v vols-admin for example.
- Use the Round Robin pathing policy (default) for the Protocol Endpoint.
- Use the Pure Storage Plugin for the vSphere Client to register the FlashArray storage provider and mount the vVols Datastore if possible.
- If manually registering the storage providers, Register both controllers' storage providers with CT0.ETH0 and CT1.ETH0. It is supported to use Eth1 if a customer certificate is used.
- If manually mounting the vVol datastore, you will need to connect the protocol endpoint.
- A single PE should be enough for the design utilizing the default device queue depth for the PE.
- Keep VM Templates on vVols when deploying new vVol VMs from a template.
- When resizing a VM's VMDK that resides on a vVol, complete the task from vSphere Client and not the FlashArray GUI.
- vCenter Server should not reside on a vVol
- All ESXi Hosts, vCenter Server and FlashArray should have the same NTP Server synchronization configuration and be configured to send their logs to a syslog target.

For more information about vVols Best practices, refer to the following quick reference:

[https://support.purestorage.com/Solutions/VMware\\_Platform\\_Guide/Quick\\_Reference\\_by\\_VMware\\_Product\\_and\\_Integration/Virtual\\_Volumes\\_Quick\\_Reference](https://support.purestorage.com/Solutions/VMware_Platform_Guide/Quick_Reference_by_VMware_Product_and_Integration/Virtual_Volumes_Quick_Reference)

## **VMware Horizon Design Fundamentals**

### **Design a VMware Horizon Environment for a Mixed Workload**

With VMware Horizon 7 the method you choose to provide applications or desktops to users depends on the types of applications and desktops you are hosting and available system resources, as well as the types of users and user experience you want to provide.

**Table 2. Designing a VMware Horizon Environment**

Server OS machines	<p>You want: Inexpensive server-based delivery to minimize the cost of delivering applications to a large number of users, while providing a secure, high-definition user experience.</p> <p>Your users: Perform well-defined tasks and do not require personalization or offline access to applications. Users may include task workers such as call center operators and retail workers, or users that share workstations.</p> <p>Application types: Any application.</p>
Desktop OS machines	<p>You want: A client-based application delivery solution that is secure, provides centralized management, and supports a large number of users per host server (or hypervisor), while providing users with applications that display seamlessly in high-definition.</p> <p>Your users: Are internal, external contractors, third-party collaborators, and other provisional team members. Users do not require off-line access to hosted applications.</p> <p>Application types: Applications that might not work well with other applications or might interact with the operating system, such as .NET framework. These types of applications are ideal for hosting on virtual machines.</p> <p>Applications running on older operating systems such as Windows XP or Windows Vista, and older architectures, such as 32-bit or 16-bit. By isolating each application on its own virtual machine, if one machine fails, it does not impact other users.</p>
Remote PC Access	<p>You want: Employees with secure remote access to a physical computer without using a VPN. For example, the user may be accessing their physical desktop PC from home or through a public WIFI hotspot. Depending upon the location, you may want to restrict the ability to print or copy and paste outside of the desktop. This method enables BYO device support without migrating desktop images into the datacenter.</p> <p>Your users: Employees or contractors that have the option to work from home but need access to specific software or data on their corporate desktops to perform their jobs remotely.</p> <p>Host: The same as Desktop OS machines.</p> <p>Application types: Applications that are delivered from an office computer and display seamlessly in high definition on the remote user's device.</p>

For the Cisco Validated Design described in this document, a Remote Desktop Server Hosted sessions (RDSH) using RDS based Server OS and VMware Horizon pooled Instant and Full Clone Virtual Machine Desktops using VDI based desktop OS machines were configured and tested.

The mixed workload test case consisted of a combination of all use cases. The following sections discuss design decisions relative to the VMware Horizon deployment, including the CVD test environment.

---

## Deployment Hardware and Software

### Products Deployed

The architecture deployed is highly modular. While each customer's environment might vary in its exact configuration, the reference architecture contained in this document once built, can easily be scaled as requirements, and demands change. This includes scaling both up (adding additional resources within a Cisco UCS Domain) and out (adding additional Cisco UCS Domains and Pure Storage FlashArrays).

The FlashStack Data Center solution includes Cisco networking, Cisco UCS and Pure Storage FlashArray//X70 R3, which efficiently fit into a single data center rack, including the access layer network switches.

This CVD details the deployment of up to 6000 users for HSD and 5000 VDI users VMware Horizon desktop workload featuring the following software:

- VMware vSphere 7.0 GA Hypervisor
- Microsoft SQL Server 2019
- Microsoft Windows Server 2019 and Windows 10 64-bit virtual machine Operating Systems
- VMware Horizon 7.12 Remote Desktops (RDSH) provisioned as Full Clones
- VMware Horizon 7.12 Non-Persistent Virtual Desktops (VDI) provisioned as Instant Clones
- VMware Horizon 7.12 Persistent Virtual Desktops (VDI) provisioned as Full Clones
- VMware Dynamic Environment Manager 10.0

Figure 22. Virtual Desktop Workload Reference Architecture on FlashStack

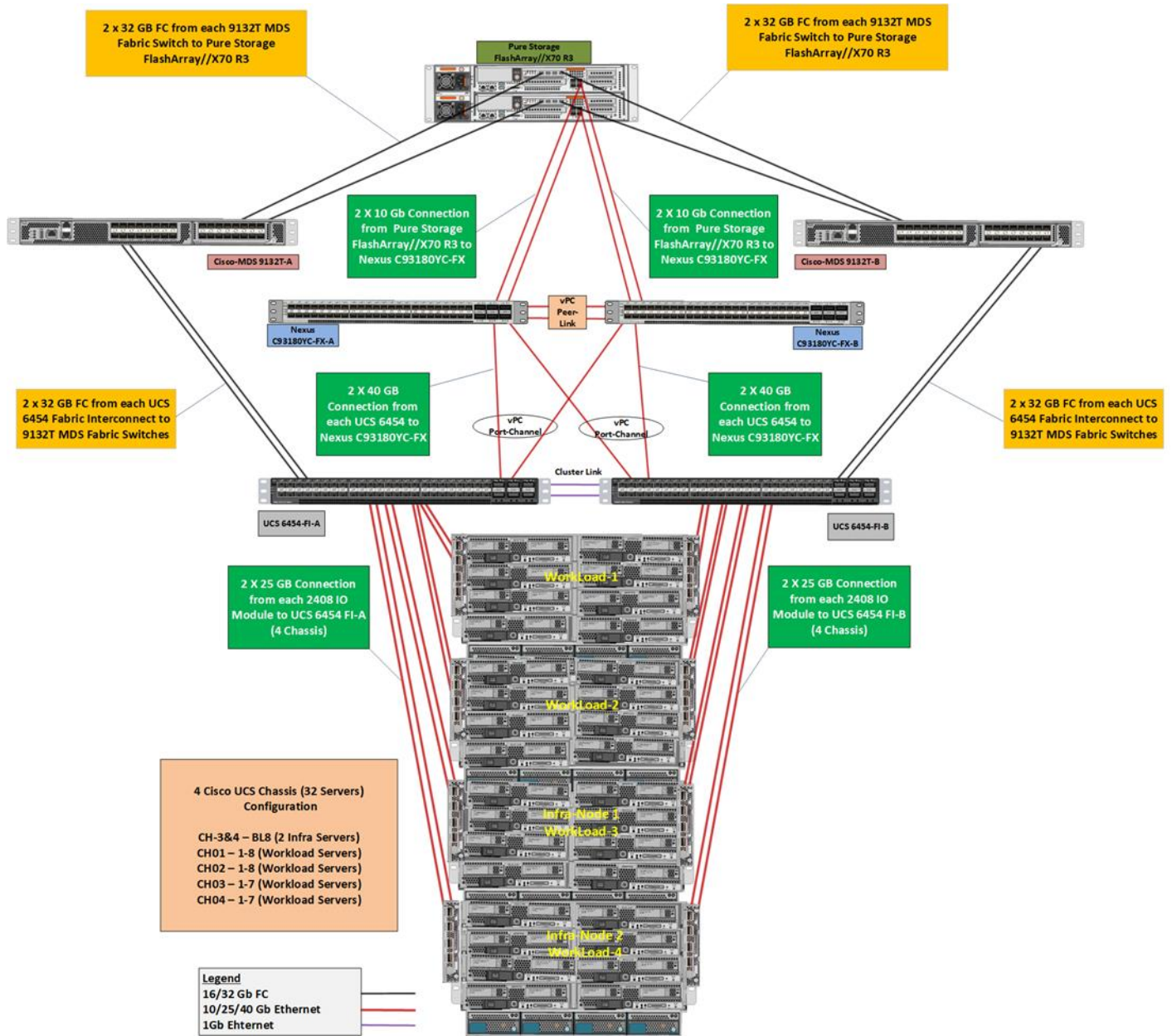

Figure 22 details the physical hardware and cabling deployed to enable this solution:

- Two Cisco Nexus 93180YC-FX Layer 2 Access Switches.
- Two Cisco MDS 9132T 32-Gb Fibre Channel Switches.
- Four Cisco UCS 5108 Blade Server Chassis with two Cisco UCS-IOM-2408 IO Modules.
- Two Cisco UCS B200 M5 Blade Servers with Intel® Xeon® Silver 4210 2.2-GHz 10-core processors, 384GB 2933MHz RAM, and one Cisco VIC1440 mezzanine card for the hosted infrastructure, providing N+1 server fault tolerance.



- Thirty Cisco UCS B200 M5 Blade Servers with Intel® Xeon® Gold 6230 2.1-GHz 20-core processors, 768GB 2933MHz RAM, and one Cisco VIC1440 mezzanine card, providing N+1 server fault tolerance.
- Pure Storage FlashArray//X70 R3 with dual redundant controllers, with Twenty 1.92TB DirectFlash NVMe drives.



The LoginVSI Test infrastructure is not a part of this solution. The Pure FlashArray//X70 R3 configuration is detailed later in this document.

## Software Revisions

[Table 3](#) lists the software versions of the primary products installed in the environment.

**Table 3. Software and Firmware Versions**

Vendor	Product / Component	Version / Build / Code
Cisco	UCS Component Firmware	4.1(2a) bundle release
Cisco	UCS Manager	4.1(2a) bundle release
Cisco	UCS B200 M5 Blades	4.1(2a) bundle release
Cisco	VIC 1440	4.1(2a) bundle release
Pure Storage	FlashArray//X70 R3	Purity//FA v6.0.3
VMware	vCenter Server Appliance	7.0.0.10400
VMware	vSphere 7. 0 GA	7.0.0.15843807
VMware	Horizon Connection Server	7.12.0.15770369
VMware	Dynamic Environment Manger Enterprise	10.0.0.945
VMware	Horizon Agent	7.12
VMware	Tools	11.0.5.15389592

## Logical Architecture

The logical architecture of the validated solution which is designed to support up to 6000 users within a single 42u rack containing 32 blades in 4 chassis, with physical redundancy for the blade servers for each workload type is illustrated in [Figure 23](#).

**Figure 23. Logical Architecture Overview**

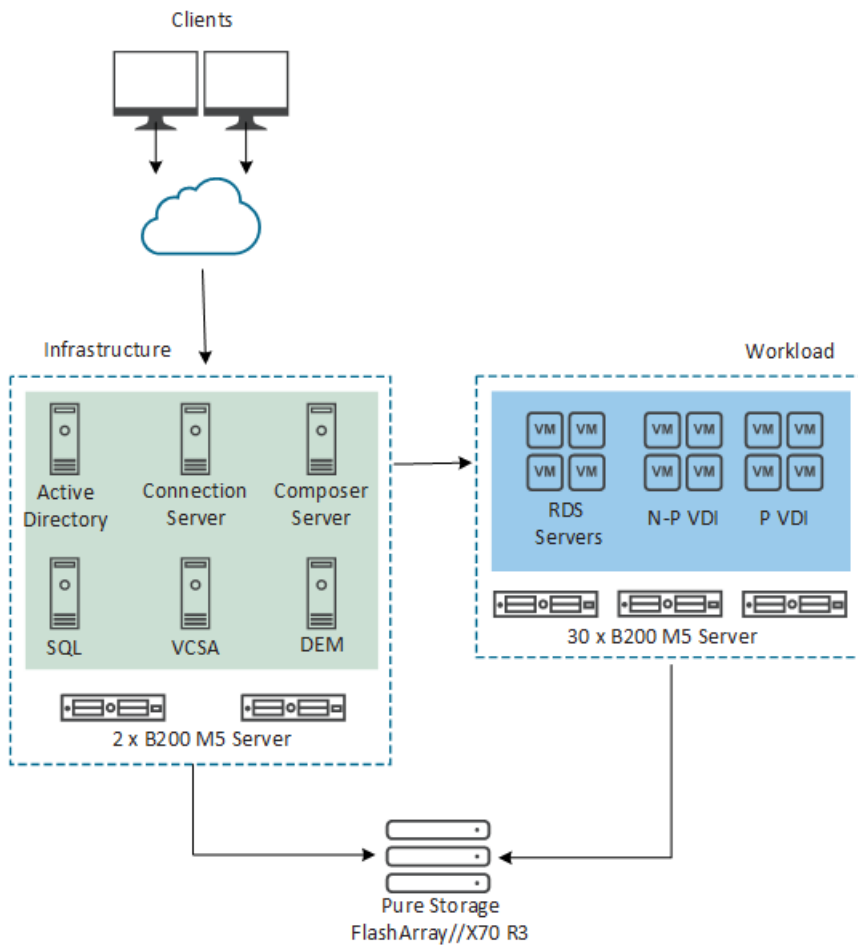

## Configuration Guidelines

The VMware Horizon solution described in this document provides details for configuring a fully redundant, high-availability configuration. Configuration guidelines are provided that refer to which redundant component is being configured with each step, whether that be A or B. For example, Nexus A and Nexus B identify the pair of Cisco Nexus switches that are configured. The Cisco UCS Fabric Interconnects are configured similarly.



This document is intended to allow the reader to configure the VMware Horizon 7.12 customer environment as a stand-alone solution.

## VLANs

The VLAN configuration recommended for the environment includes a total of six VLANs as outlined in [Table 4](#).

**Table 4. VLANs Configured in this Study**

VLAN Name	VLAN ID	VLAN Purpose
Default	1	Native VLAN

VLAN Name	VLAN ID	VLAN Purpose
In-Band-Mgmt	70	In-Band management interfaces
Infra-Mgmt	71	Infrastructure Virtual Machines
VCC/VM-Network	72	RDSH, VDI Persistent and Non-Persistent
vMotion	73	VMware vMotion
OOB-Mgmt	164	Out of Band management interfaces

## VSANs

Two virtual SANs configured for communications and fault tolerance in this design as outlined in [Table 5](#).

**Table 5. VSANs Configured in this Study**

VSAN Name	VSAN ID	Purpose
VSAN 100	100	VSAN for Primary SAN communication
VSAN 101	101	VSAN for Secondary SAN communication

---

## Solution Configuration

This section details the configuration and tuning that was performed on the individual components to produce a complete, validated solution.

### Solution Cabling

The following sections detail the physical connectivity configuration of the FlashStack VMware Horizon environment.

The information provided in this section is a reference for cabling the physical equipment in this Cisco Validated Design environment. To simplify cabling requirements, the tables include both local and remote device and port locations.

The tables in this section contain the details for the prescribed and supported configuration of the Pure Storage FlashArray//X70 R3 storage array to the Cisco 6454 Fabric Interconnects through Cisco MDS 9132T 32-Gb FC switches.



This document assumes that out-of-band management ports are plugged into an existing management infrastructure at the deployment site. These interfaces will be used in various configuration steps.

---



Be sure to follow the cabling directions in this section. Failure to do so will result in necessary changes to the deployment procedures that follow because specific port locations are mentioned.

---

[Figure 24](#) shows a cabling diagram for a configuration using the Cisco Nexus 9000, Cisco MDS 9100 Series, and Pure Storage FlashArray//X70 R3 array.

Figure 24. FlashStack Solution Cabling Diagram

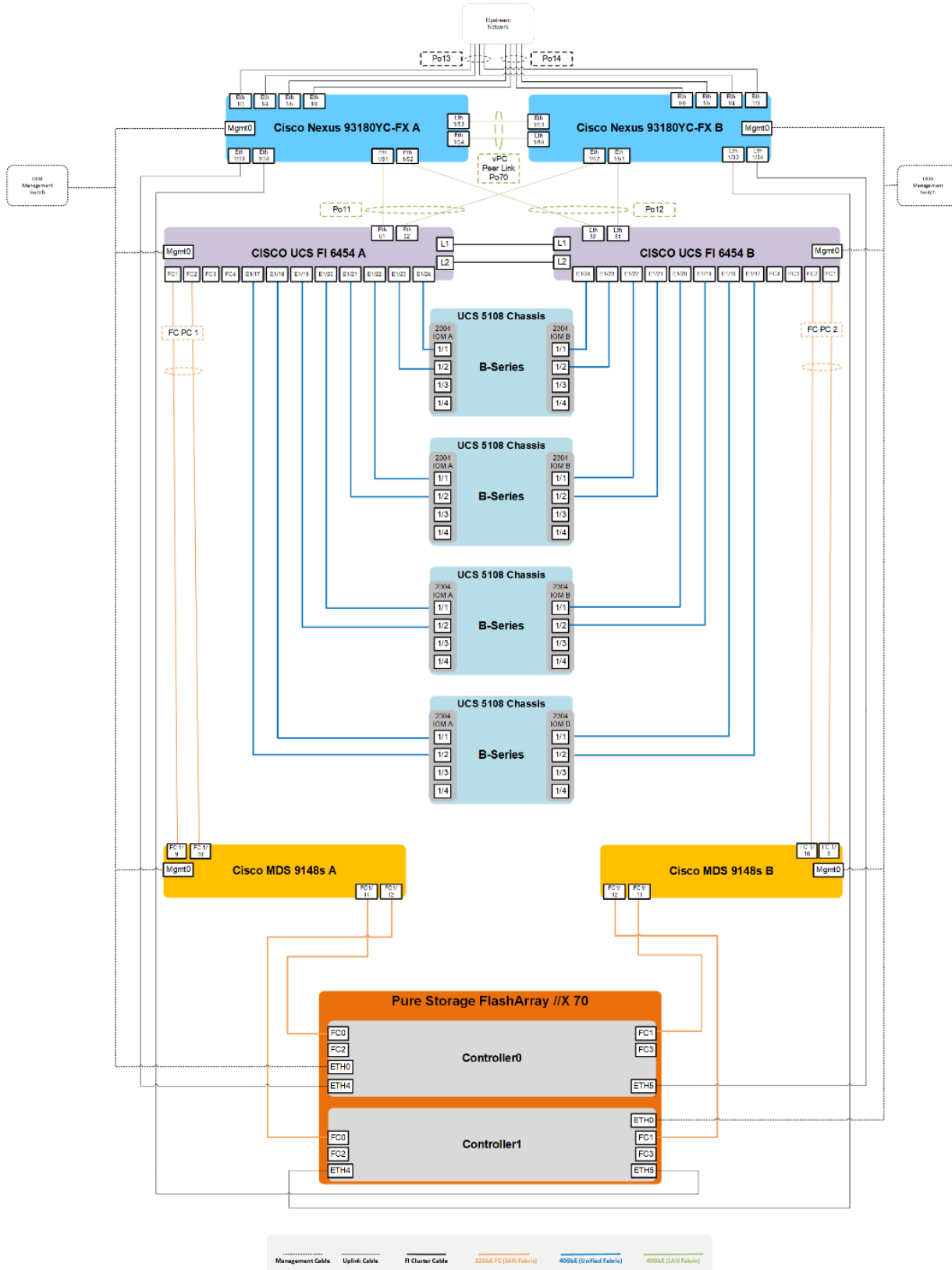

---

## Cisco Unified Computing System Base Configuration

This section details the Cisco UCS configuration that was done as part of the infrastructure build out. The racking, power, and installation of the chassis are described in the [Cisco UCS Manager Getting Started Guide](#) and it is beyond the scope of this document. For more information about each step, refer to the following document, [Cisco UCS Manager - Configuration Guides](#).

### Cisco UCS Manager Software Version 4.1(2a)

This document assumes you are using Cisco UCS Manager Software version 4.1(2a). To upgrade the Cisco UCS Manager software and the Cisco UCS 6454 Fabric Interconnect software to a higher version of the firmware, refer to [Cisco UCS Manager Install and Upgrade Guides](#).

### Configure Fabric Interconnects at Console

To configure the fabric Interconnects, follow these steps:

1. Connect a console cable to the console port on what will become the primary fabric interconnect.
2. If the fabric interconnect was previously deployed and you want to erase it to redeploy, follow these steps:
  - a. Login with the existing user name and password.

```
# connect local-mgmt
# erase config
# yes (to confirm)
```
3. After the fabric interconnect restarts, the out-of-box first time installation prompt appears, type “console” and press Enter.
4. Follow the [Initial Configuration](#) steps as outlined in [Cisco UCS Manager Getting Started Guide](#). When configured, log into UCSM IP Address through Web interface to perform base Cisco UCS configuration.

### Configure Fabric Interconnects for a Cluster Setup

To configure the Cisco UCS Fabric Interconnects, follow these steps:

1. Verify the following physical connections on the fabric interconnect:
  - a. The management Ethernet port (mgmt0) is connected to an external hub, switch, or router
  - b. The L1 ports on both fabric interconnects are directly connected to each other
  - c. The L2 ports on both fabric interconnects are directly connected to each other
2. Connect to the console port on the first Fabric Interconnect.
3. Review the settings on the console. Answer yes to Apply and Save the configuration.
4. Wait for the login prompt to make sure the configuration has been saved to Fabric Interconnect A.
5. Connect the console port on the second Fabric Interconnect, configure secondary FI.



Figure 25. Initial Setup of Cisco UCS Manager on Primary Fabric Interconnect

```
Enter the configuration method. (console/gui) ? console
Enter the setup mode; setup newly or restore from backup. (setup/restore) ? setup
You have chosen to setup a new Fabric interconnect. Continue? (y/n): y
Enforce strong password? (y/n) [y]: n
Enter the password for "admin":
Confirm the password for "admin":
Is this Fabric interconnect part of a cluster(select 'no' for standalone)? (yes/no) [n]: yes
Enter the switch fabric (A/B) []: A
Enter the system name: VCC-AAD17
Physical Switch Mgmt0 IP address : 10.29.164.246
Physical Switch Mgmt0 IPv4 netmask : 255.255.255.0
IPv4 address of the default gateway : 10.29.164.1
Cluster IPv4 address : 10.29.164.245
Configure the DNS Server IP address? (yes/no) [n]:
Configure the default domain name? (yes/no) [n]:
Join centralized management environment (UCS Central)? (yes/no) [n]:
Following configurations will be applied:
Switch Fabric=A
System Name=VCC-AAD17
Enforced Strong Password=no
Physical Switch Mgmt0 IP Address=10.29.164.246
Physical Switch Mgmt0 IP Netmask=255.255.255.0
Default Gateway=10.29.164.1
Ipv6 value=0
Cluster Enabled=yes
Cluster IP Address=10.29.164.245
NOTE: Cluster IP will be configured only after both Fabric Interconnects are initialized.
UCSM will be functional only after peer FI is configured in clustering mode.
Apply and save the configuration (select 'no' if you want to re-enter)? (yes/no): yes
Applying configuration. Please wait.
Configuration file - Ok
Cisco UCS 6300 Series Fabric Interconnect
VCC-AAD17-A login: █
```

**Figure 26. Initial Setup of Cisco UCS Manager on Secondary Fabric Interconnect**

```
Enter the configuration method. (console/gui) ? console
Installer has detected the presence of a peer Fabric interconnect. This Fabric interconnect will be added to the cluster. Continue (y/n) ? y
Enter the admin password of the peer Fabric interconnect:
Connecting to peer Fabric interconnect... done
Retrieving config from peer Fabric interconnect... done
Peer Fabric interconnect Mgmt0 IPv4 Address: 10.29.164.246
Peer Fabric interconnect Mgmt0 IPv4 Netmask: 255.255.255.0
Cluster IPv4 address      : 10.29.164.245

Peer FI is IPv4 Cluster enabled. Please Provide Local Fabric Interconnect Mgmt0 IPv4 Address
Physical Switch Mgmt0 IP address : 10.29.164.247

Apply and save the configuration (select 'no' if you want to re-enter)? (yes/no): yes
Applying configuration. Please wait.

Fri Feb 16 18:53:15 UTC 2018
Configuration file - Ok

Cisco UCS 6300 Series Fabric Interconnect
VCC-AAD17-B login:
```

To log into the Cisco Unified Computing System (Cisco UCS) environment, follow these steps:

1. Open a web browser and navigate to the Cisco UCS Fabric Interconnect cluster address configured above.
2. Click the Launch UCS Manager link to download the Cisco UCS Manager software. If prompted, accept the security certificates.

**Figure 27. Cisco UCS Manager Web Interface**

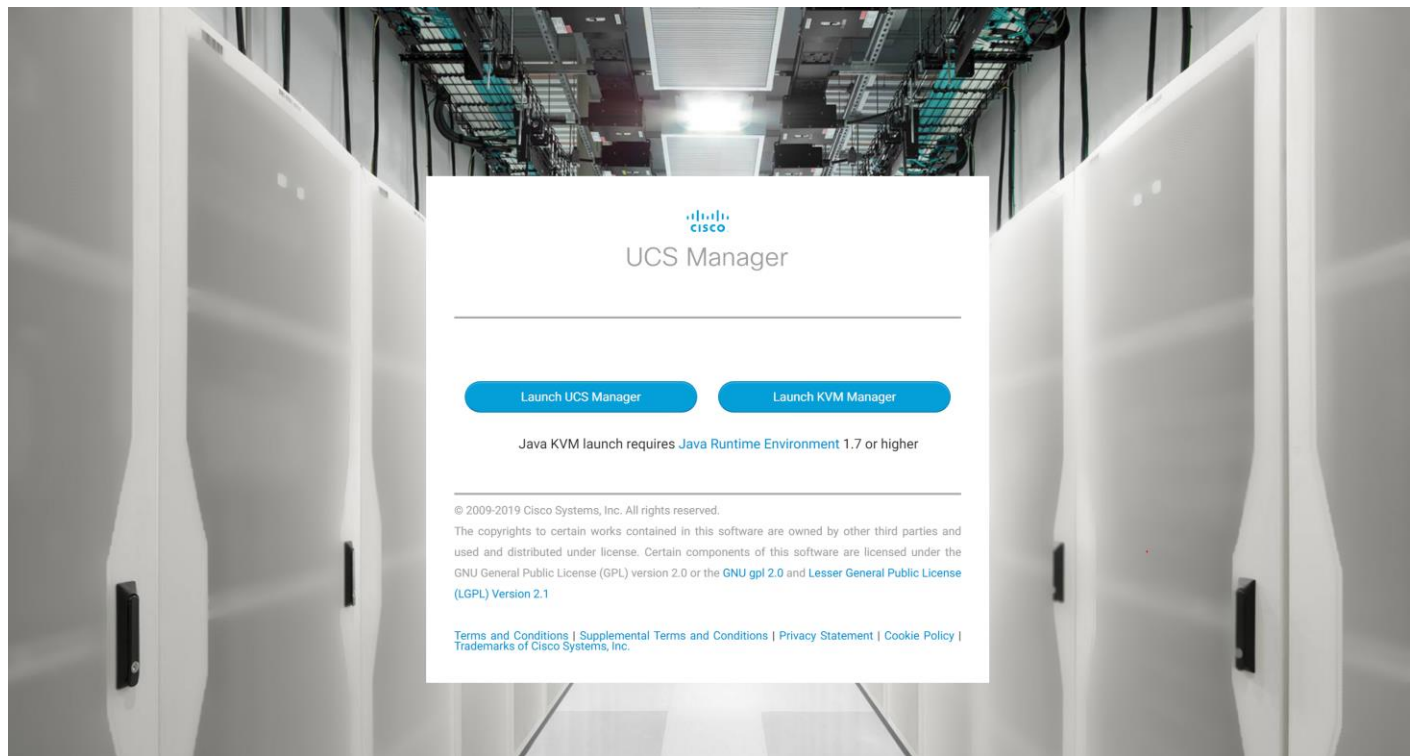

3. When prompted, enter the user name and password enter the password. Click Log In to login to Cisco UCS Manager.

**Figure 28. Cisco UCS Manager Web Interface after Login**

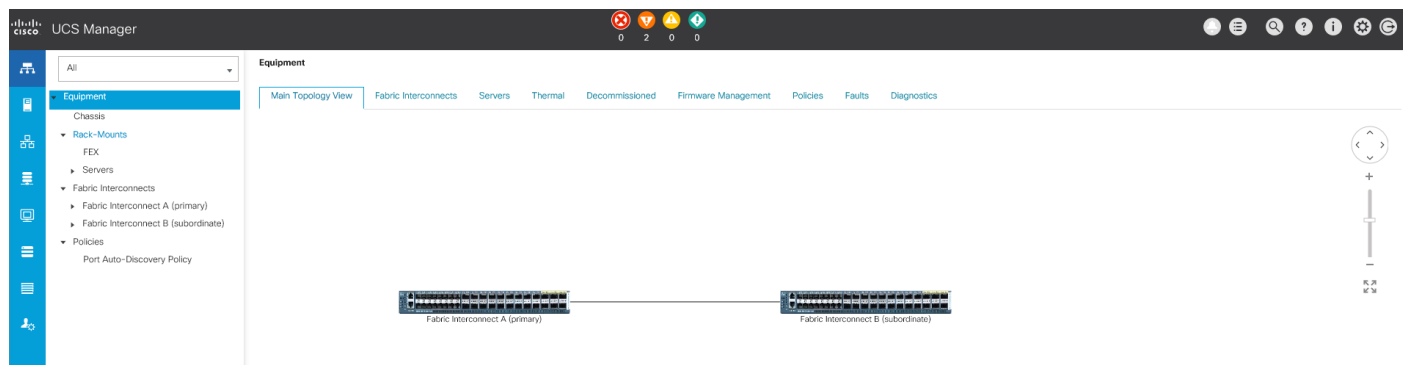

## Configure Base Cisco Unified Computing System

The following are the high-level steps involved for a Cisco UCS configuration:

- Configure Fabric Interconnects for a Cluster Setup
- Set Fabric Interconnects to Fibre Channel End Host Mode
- Synchronize Cisco UCS to NTP
- Configure Fabric Interconnects for Chassis and Blade Discovery
  - Configure Global Policies
  - Configure Server Ports
- Configure LAN and SAN on Cisco UCS Manager
  - Configure Ethernet LAN Uplink Ports
  - Create Uplink Port Channels to Cisco Nexus Switches
  - Configure FC SAN Uplink Ports
  - Configure VLAN
  - Configure VSAN
- Configure IP, UUID, Server, MAC, WWNN and WWPN Pools
  - IP Pool Creation
  - UUID Suffix Pool Creation
  - Server Pool Creation
  - MAC Pool Creation
- WWNN and WWPN Pool Creation
- Set Jumbo Frames in both the Cisco Fabric Interconnect
- Configure Server BIOS Policy
- Create Adapter Policy
- Configure Update Default Maintenance Policy
- Configure vNIC and vHBA Template

- Create Server Boot Policy for SAN Boot

Details for each step are discussed in the following sections.

### Synchronize Cisco UCSM to NTP

To synchronize the Cisco UCS environment to the NTP server, follow these steps:

1. In Cisco UCS Manager, in the navigation pane, click the Admin tab.
2. Select All > Time zone Management.
3. In the Properties pane, select the appropriate time zone in the Time zone menu.
4. Click Save Changes and then click OK.
5. Click Add NTP Server.

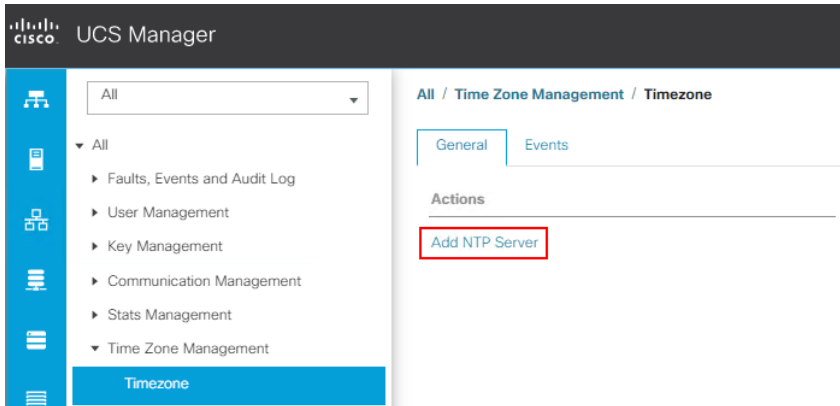

6. Enter the NTP server IP address and click OK.

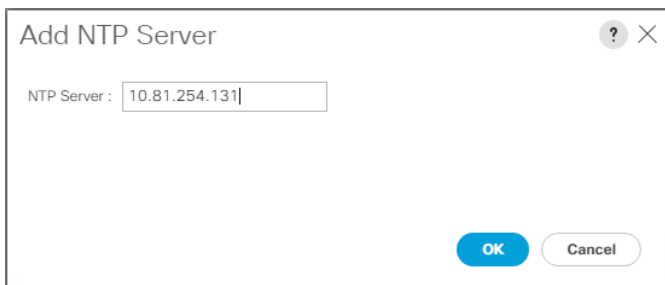

7. Click OK to finish.

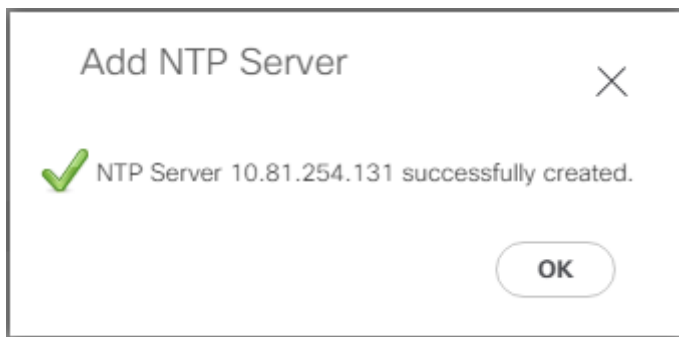

8. Repeat steps 1-7 to configure additional NTP servers.
9. Click Save Changes.

**Figure 29. Synchronize Cisco UCS Manager to NTP**

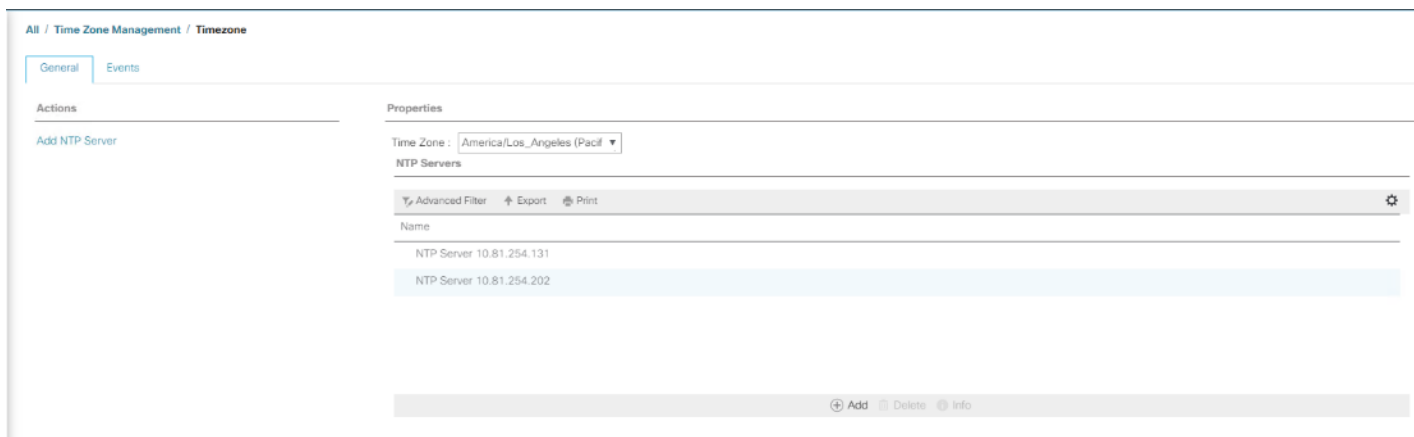

## Configure Fabric Interconnects for Chassis and Blade Discovery

Cisco UCS 6454 Fabric Interconnects are configured for redundancy. It provides resiliency in case of failures. The first step is to establish connectivity between blades and Fabric Interconnects.

### Configure Global Policies

The chassis discovery policy determines how the system reacts when you add a new chassis. We recommend using the platform max value as shown. Using platform max helps ensure that Cisco UCS Manager uses the maximum number of IOM uplinks available.

To configure global policies, follow these steps:

1. In Cisco UCS Manager, go to Equipment > Policies (right pane) > Global Policies > Chassis/FEX Discovery Policies. As shown in the screenshot below, for Action select “Platform Max” from the drop-down list and set Link Grouping to Port Channel.
2. Click Save Changes.
3. Click OK.

Figure 30. UCS Global Policy

The screenshot shows the UCSM interface for configuring global policies. The top navigation bar includes 'Equipment' and 'Policies'. Under 'Policies', the 'Global Policies' sub-tab is selected. The configuration is organized into several sections:

- Chassis/FEX Discovery Policy:** Action is set to 'Platform Max' (dropdown); Link Grouping Preference has radio buttons for 'None' and 'Port Channel'.
- Rack Server Discovery Policy:** Action has radio buttons for 'Immediate' (selected) and 'User Acknowledged'; Scrub Policy is set to '<not set>' (dropdown).
- Rack Management Connection Policy:** Action has radio buttons for 'Auto Acknowledged' (selected) and 'User Acknowledged'.
- Power Policy:** Redundancy has radio buttons for 'Non Redundant', 'N+1' (selected), and 'Grid'.
- MAC Address Table Aging:** Aging Time has radio buttons for 'Never', 'Mode Default' (selected), and 'other'.
- Global Power Allocation Policy:** Allocation Method has radio buttons for 'Manual Blade Level Cap' and 'Policy Driven Chassis Group Cap' (selected).
- Firmware Auto Sync Server Policy:** Sync State has radio buttons for 'No Actions' (selected) and 'User Acknowledge'.

At the bottom right, there are two buttons: 'Save Changes' (highlighted in blue) and 'Reset Values'.

### Fabric Ports: Discrete versus Port Channel Mode

[Figure 31](#) illustrates the advantage of Discrete Vs Port-Channel mode in UCSM.



Figure 31. Port Channel versus Discrete Mode

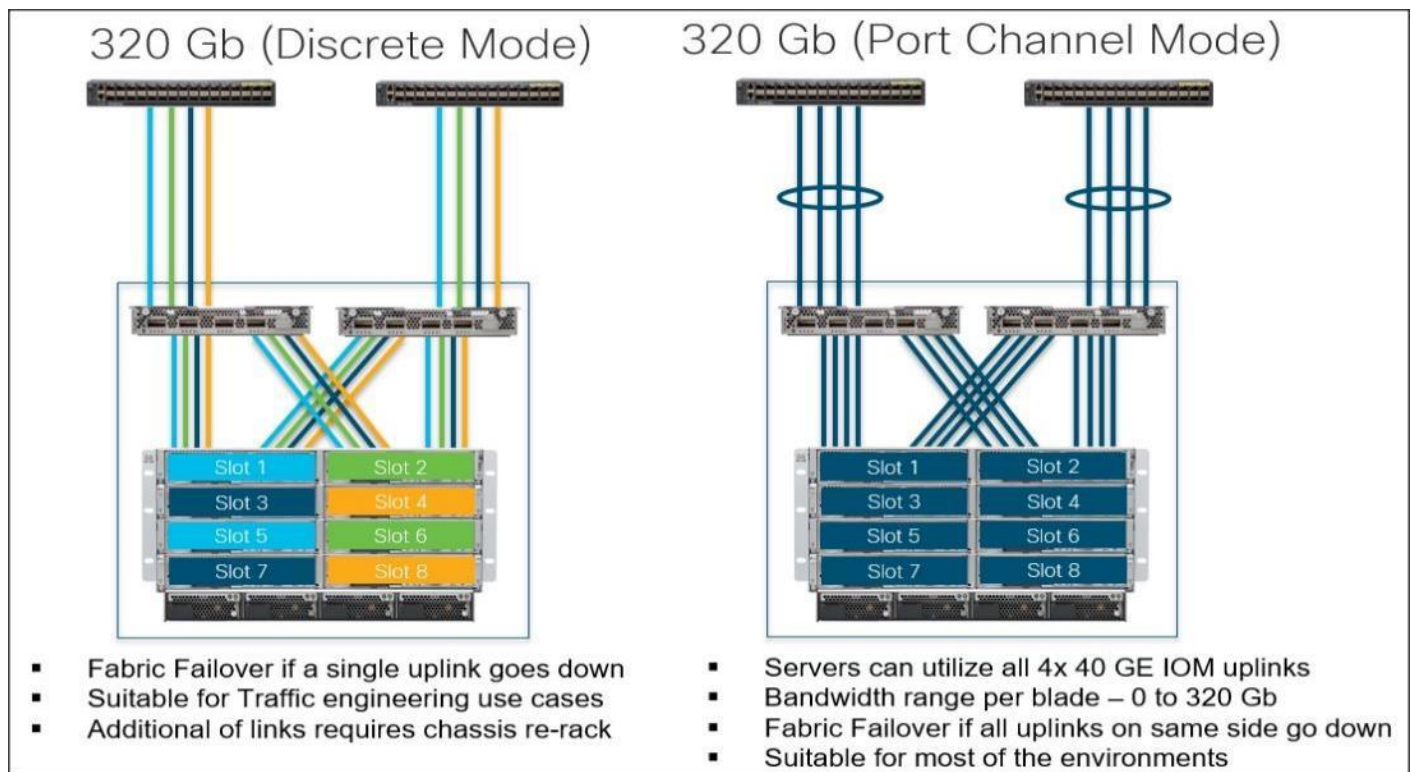

### Set Fabric Interconnects to Fibre Channel End Host Mode

In order to configure the FC Uplink ports connected to the Cisco UCS MDS 9132T 32-Gb FC switch, set the Fabric Interconnects to the Fibre Channel End Host Mode. Verify that the fabric interconnects are operating in “FC End-Host Mode.”

Fabric Interconnects

- Fabric Interconnects
  - Fabric Interconnect A (primary)
  - Fabric Interconnect B (subordinate)
- Disable Ports
  - Set Ethernet End-Host Mode
  - Set Ethernet Switching Mode
  - Set FC End-Host Mode**
  - Set FC Switching Mode
- Activate Firmware
- Management Interfaces
- Turn on Locator LED

Fabric Interconnects / Fabric Interconnect A (primary)

General | Physical Ports | Fans | PSUs | Physical Di

**Fault Summary**

0 0 0

Operable

OK

End Host

End Host

ode: Off

de: Off

Actions



The fabric interconnect automatically reboots if switched to operational mode; perform this task on one FI first, wait for the FI to come up and repeat this process on the second FI.

## Configure FC SAN Uplink Ports

To configure Fibre Channel Uplink ports, follow these steps:

1. Go to Equipment > Fabric Interconnects > Fabric Interconnect A > General tab > Actions pane, click Configure Unified Ports.

Equipment / Fabric Interconnects / Fabric Interconnect A (subordinate)

General Physical Ports Fans PSUs Physical Display FSM Neighbors Faults Events Statistics

Status

Overall Status : **Operable**  
Thermal : **OK**  
Ethernet Mode : **End Host**  
FC Mode : **End Host**  
Admin Evac Mode : **Off**  
Oper Evac Mode : **Off**

Actions

- Configure Evacuation
- Configure Unified Ports**
- Internal Fabric Manager
- LAN Uplinks Manager
- NAS Appliance Manager
- SAN Uplinks Manager
- SAN Storage Manager
- Enable Ports ▼
- Disable Ports ▼
- Set Ethernet End-Host Mode
- Set Ethernet Switching Mode
- Set FC End-Host Mode
- Set FC Switching Mode
- Activate Firmware
- Management Interfaces
- Turn off Locator LED

Properties

Name : **A**  
Product Name : **Cisco UCS 6454**  
Vendor : **Cisco Systems, Inc.**  
Revision : **0**  
Available Memory :  
Locator LED : **On**

PID : **UCS-FI-6454**  
Serial : **FDO22241ZLJ**  
Total Memory : **62.761 (GB)**

Part Details  
Local Storage Information  
Access  
High Availability Details  
VLAN Port Count  
FC Zone Count

Firmware

Boot-loader Version : **v05.40(01/17/2020)**  
Kernel Version : **7.0(3)N2(4.12a)**  
System Version : **7.0(3)N2(4.12a)**  
Service Pack Version : **4.1(2)SP0(Default)**  
Package Version : **4.1(2a)A**  
Startup Kernel Version : **7.0(3)N2(4.12a)**  
Activate Status : **Ready**

2. Click Yes to confirm in the pop-up window.

Configure Unified Ports

**Warning** The Configure Unified Ports wizard allows you to change the port mode from Ethernet to Fibre Channel or FC to Ethernet. Changing the port mode on either module causes an interruption in data traffic because changes to the fixed module require a reboot of the fabric interconnect and changes on an expansion module require a reboot of that module. Are you sure you want to launch this wizard and reboot the modules associated with any reconfigured ports?

Yes No

3. Move the slider to the right.
4. Click OK.



Ports to the right of the slider will become FC ports. For our study, we configured the first four ports (Ports are configured in sets of 4 ports) on the FI as FC Uplink ports.



Applying this configuration will cause the immediate reboot of the fabric interconnect and/or the expansion module(s).

Configure Unified Ports

Instructions

The position of the slider determines the type of the ports.  
All the ports to the left of the slider are Fibre Channel ports (Purple), while the ports to the right are Ethernet ports (Blue).

Port	Transport	If Role or Port Channel Membership	Desired If Role
FC Port 1	fc	FC Uplink	
FC Port 2	fc	FC Uplink	
FC Port 3	fc	FC Uplink	
FC Port 4	fc	FC Uplink	
Port 5	ether	Unconfigured	
Port 6	ether	Unconfigured	
Port 7	ether	Unconfigured	
Port 8	ether	Unconfigured	
Port 9	ether	Unconfigured	
Port 10	ether	Unconfigured	
Port 11	ether	Unconfigured	
Port 12	ether	Unconfigured	
Port 13	ether	Unconfigured	
Port 14	ether	Unconfigured	
Port 15	ether	Unconfigured	
Port 16	ether	Unconfigured	

OK Cancel

5. Click Yes to apply the changes.

Configure Unified Ports

Applying this configuration will cause the **immediate reboot** of Fabric Interconnect and/or Expansion Module(s), because changes to the fixed module require a reboot of the Fabric Interconnect and changes on an Expansion Module require a reboot of that module. Are you sure you want to apply the changes?

Yes No

6. Click OK to proceed.

Configure Unified Ports

Successfully configured ports.

OK

7. After the FI reboot, your FC Ports configuration will look like [Figure 32](#).

8. Repeat steps 1-7 on Fabric Interconnect B.

**Figure 32. FC Uplink Ports on Fabric Interconnect A**

Slot	Port ID	WWPN	If Role	If Type	Overall Status	Admin State
1	1	20:01:00:3A:9C:0E:33:20	Network	Physical	↑ Up	↑ Enabled
1	2	20:02:00:3A:9C:0E:33:20	Network	Physical	↑ Up	↑ Enabled
1	3	20:03:00:3A:9C:0E:33:20	Network	Physical	↑ Up	↑ Enabled
1	4	20:04:00:3A:9C:0E:33:20	Network	Physical	↑ Up	↑ Enabled

### Configure Server Ports

Configure the server ports to initiate chassis and blade discovery. To configure server ports, follow these steps:

1. Go to Equipment > Fabric Interconnects > Fabric Interconnect A > Fixed Module > Ethernet Ports.
2. Select the ports (for this solution ports are 17-24) which are connected to the Cisco IO Modules of the two B-Series 5108 Chassis.
3. Right-click and select “Configure as Server Port.”

**Figure 33. Configure Server Port on Cisco UCS Manager Fabric Interconnect for Chassis/Server Discovery**

Slot	Aggr. Port ID	Port ID	MAC	If Role	If Type	Overall Status	Admin State	Peer
1	0	17	00:3A:9C:0E:33:38	Unconfigured	Physical	↓ Admin Down	↓ Disabled	
1	0	18	00:3A:9C:0E:33:39	Unconfigured	Physical	↓ Admin Down	↓ Disabled	
1	0	19	00:3A:9C:0E:33:3A	Unconfigured	Physical	↓ Admin Down	↓ Disabled	
1	0	20	00:3A:9C:0E:33:3B	Unconfigured	Physical	↓ Admin Down	↓ Disabled	
1	0	21	00:3A:9C:0E:33:3C	Unconfigured	Physical	↓ Admin Down	↓ Disabled	
1	0	22	00:3A:9C:0E:33:3D	Unconfigured	Physical	↓ Admin Down	↓ Disabled	
1	0	23	00:3A:9C:0E:33:3E	Unconfigured	Physical	↓ Admin Down	↓ Disabled	
1	0	24	00:3A:9C:0E:33:3F	Unconfigured	Physical	↓ Admin Down	↓ Disabled	
1	0	25	00:3A:9C:0E:33:40	Unconfigured	Physical	↓ Sfp Not Present	↓ Disabled	
1	0	26	00:3A:9C:0E:33:41	Unconfigured	Physical	↓ Sfp Not Present	↓ Disabled	
1	0	27	00:3A:9C:0E:33:42	Unconfigured	Physical	↓ Sfp Not Present	↓ Disabled	
1	0	28	00:3A:9C:0E:33:43	Unconfigured	Physical	↓ Sfp Not Present	↓ Disabled	
1	0	29	00:3A:9C:0E:33:44	Unconfigured	Physical	↓ Sfp Not Present	↓ Disabled	

4. Click Yes to confirm and click OK.
5. Repeat steps 1-4 to configure the Server Port on Fabric Interconnect B.

When configured, the server port will look like [Figure 34](#) on both Fabric Interconnects.

**Figure 34. Server Ports on Fabric Interconnect A**

Slot	Aggr. Port ID	Port ID	MAC	If Role	If Type	Overall Status	Admin State	Peer
1	0	17	00:3A:9C:0E:33:38	Server	Physical	Up	Enabled	sys/chassis-1/slot-2/fabri...
1	0	18	00:3A:9C:0E:33:39	Server	Physical	Up	Enabled	sys/chassis-1/slot-2/fabri...
1	0	19	00:3A:9C:0E:33:3A	Server	Physical	Up	Enabled	sys/chassis-2/slot-2/fabri...
1	0	20	00:3A:9C:0E:33:3B	Server	Physical	Up	Enabled	sys/chassis-2/slot-2/fabri...
1	0	21	00:3A:9C:0E:33:3C	Server	Physical	Up	Enabled	sys/chassis-3/slot-2/fabri...
1	0	22	00:3A:9C:0E:33:3D	Server	Physical	Up	Enabled	sys/chassis-3/slot-2/fabri...
1	0	23	00:3A:9C:0E:33:3E	Server	Physical	Up	Enabled	sys/chassis-4/slot-2/fabri...
1	0	24	00:3A:9C:0E:33:3F	Server	Physical	Link Up	Enabled	sys/chassis-4/slot-2/fabri...
1	0	25	00:3A:9C:0E:33:40	Unconfigured	Physical	Stp Not Present	Disabled	
1	0	26	00:3A:9C:0E:33:41	Unconfigured	Physical	Stp Not Present	Disabled	
1	0	27	00:3A:9C:0E:33:42	Unconfigured	Physical	Stp Not Present	Disabled	
1	0	28	00:3A:9C:0E:33:43	Unconfigured	Physical	Stp Not Present	Disabled	
1	0	29	00:3A:9C:0E:33:44	Unconfigured	Physical	Stp Not Present	Disabled	

- After configuring Server Ports, acknowledge both the Chassis. Go to Equipment > Chassis > Chassis 1 > General > Actions > select “Acknowledge Chassis”. Similarly, acknowledge the chassis 2-4.
- After acknowledging both the chassis, re-acknowledge all the servers placed in the chassis. Go to Equipment > Chassis 1 > Servers > Server 1 > General > Actions > select Server Maintenance > select option “Re-acknowledge” and click OK. Repeat this process to re-acknowledge all eight Servers.
- When the acknowledgement of the Servers is completed, verify the Port-channel of Internal LAN. Go to the LAN tab > Internal LAN > Internal Fabric A > Port Channels as shown in [Figure 35](#).

**Figure 35. Internal LAN Port Channels**

Name	Slot ID	Port ID	Aggr. Port ID	Peer Slot ID	Peer Port ID	Fabric ID	Peer
Eth Interface 1/17	1	17	0	2	1	A	sys/switch-A/access-eth/rep...
Eth Interface 1/18	1	18	0	2	5	A	sys/switch-A/access-eth/rep...

### Configure Ethernet LAN Uplink Ports

To configure network ports that are used to uplink the Fabric Interconnects to the Cisco Nexus switches, follow these steps:

- In Cisco UCS Manager, in the navigation pane, click the Equipment tab.
- Select Equipment > Fabric Interconnects > Fabric Interconnect A > Fixed Module.
- Expand Ethernet Ports.

- Select ports (for this solution ports are 49–50) that are connected to the Nexus switches, right-click them, and select Configure as Network Port.

**Figure 36. Network Uplink Port Configuration on Fabric Interconnect Configuration**

Name	Slot	Port ID	MAC	If Role	If Type	Overall Status	Admin State
Port 35	1	35	00:3A:9C:0E:33:4A	Unconfigured	Physical	Sfp Not Present	Disabled
Port 36	1	36	00:3A:9C:0E:33:4B	Unconfigured	Physical	Sfp Not Present	Disabled
Port 37	1	37	00:3A:9C:0E:33:4C	Unconfigured	Physical	Sfp Not Present	Disabled
Port 38	1	38	00:3A:9C:0E:33:4D	Unconfigured	Physical	Sfp Not Present	Disabled
Port 39	1	39	00:3A:9C:0E:33:4E	Unconfigured	Physical	Sfp Not Present	Disabled
Port 40	1	40	00:3A:9C:0E:33:4F	Unconfigured	Physical	Sfp Not Present	Disabled
Port 41	1	41	00:3A:9C:0E:33:50	Unconfigured	Physical	Sfp Not Present	Disabled
Port 42	1	42	00:3A:9C:0E:33:51	Unconfigured	Physical	Sfp Not Present	Disabled
Port 43	1	43	00:3A:9C:0E:33:52	Unconfigured	Physical	Sfp Not Present	Disabled
Port 44	1	44	00:3A:9C:0E:33:53	Unconfigured	Physical	Sfp Not Present	Disabled
Port 45	1	45	00:3A:9C:0E:33:54	Unconfigured	Physical	Sfp Not Present	Disabled
Port 46	1	46	00:3A:9C:0E:33:55	Unconfigured	Physical	Sfp Not Present	Disabled
Port 47	1	47	00:3A:9C:0E:33:56	Unconfigured	Physical	Sfp Not Present	Disabled
Port 48	1	48	00:3A:9C:0E:33:57	Unconfigured	Physical	Sfp Not Present	Disabled
Port 49	1	49	00:3A:9C:0E:33:58	Unconfigured	Physical	Admin Down	Disabled
Port 50	1	50	00:3A:9C:0E:33:5C	Unconfigured	Physical	Admin Down	Disabled
Port 51	1	51	00:3A:9C:0E:33:60	Unconfigured	Physical	Sfp Not Present	Disabled
Port 52	1	52	00:3A:9C:0E:33:64	Unconfigured	Physical	Sfp Not Present	Disabled
Port 53	1	53	00:3A:9C:0E:33:68	Unconfigured	Physical	Sfp Not Present	Disabled
Port 54	1	54	00:3A:9C:0E:33:6C	Unconfigured	Physical	Sfp Not Present	Disabled

- Click Yes to confirm ports and click OK.
- Verify the Ports connected to Cisco Nexus upstream switches are now configured as network ports.
- Repeat steps 1-6 for Fabric Interconnect B. The screenshot below shows the network uplink ports for Fabric A.

**Figure 37. Network Uplink Port on Fabric Interconnect**

Name	Slot	Port ID	MAC	If Role	If Type	Overall Status	Admin State
Port 37	1	37	00:3A:9C:0E:33:4C	Unconfigured	Physical	Sfp Not Present	Disabled
Port 38	1	38	00:3A:9C:0E:33:4D	Unconfigured	Physical	Sfp Not Present	Disabled
Port 39	1	39	00:3A:9C:0E:33:4E	Unconfigured	Physical	Sfp Not Present	Disabled
Port 40	1	40	00:3A:9C:0E:33:4F	Unconfigured	Physical	Sfp Not Present	Disabled
Port 41	1	41	00:3A:9C:0E:33:50	Unconfigured	Physical	Sfp Not Present	Disabled
Port 42	1	42	00:3A:9C:0E:33:51	Unconfigured	Physical	Sfp Not Present	Disabled
Port 43	1	43	00:3A:9C:0E:33:52	Unconfigured	Physical	Sfp Not Present	Disabled
Port 44	1	44	00:3A:9C:0E:33:53	Unconfigured	Physical	Sfp Not Present	Disabled
Port 45	1	45	00:3A:9C:0E:33:54	Unconfigured	Physical	Sfp Not Present	Disabled
Port 46	1	46	00:3A:9C:0E:33:55	Unconfigured	Physical	Sfp Not Present	Disabled
Port 47	1	47	00:3A:9C:0E:33:56	Unconfigured	Physical	Sfp Not Present	Disabled
Port 48	1	48	00:3A:9C:0E:33:57	Unconfigured	Physical	Sfp Not Present	Disabled
Port 49	1	49	00:3A:9C:0E:33:58	Network	Physical	Up	Enabled
Port 50	1	50	00:3A:9C:0E:33:5C	Network	Physical	Up	Enabled

You have now created two uplink ports on each Fabric Interconnect as shown above. These ports will be used to create Virtual Port Channel in the next section.



## Create Uplink Port Channels to Cisco Nexus Switches

In this procedure, two port channels were created one from Fabric A to both Cisco Nexus 93180YC-FX switches and one from Fabric B to both Cisco Nexus 93180YC-FX switches. To configure the necessary port channels in the Cisco UCS environment, follow these steps:

1. In Cisco UCS Manager, click the LAN tab in the navigation pane.
2. Click LAN > LAN Cloud > Fabric A.
3. Right-click Port Channels.
4. Select Create Port Channel.

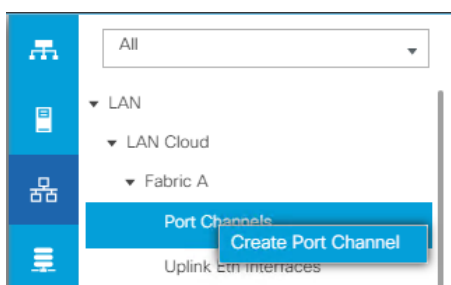

5. Enter 11 as the unique ID of the port channel and name of the port channel.

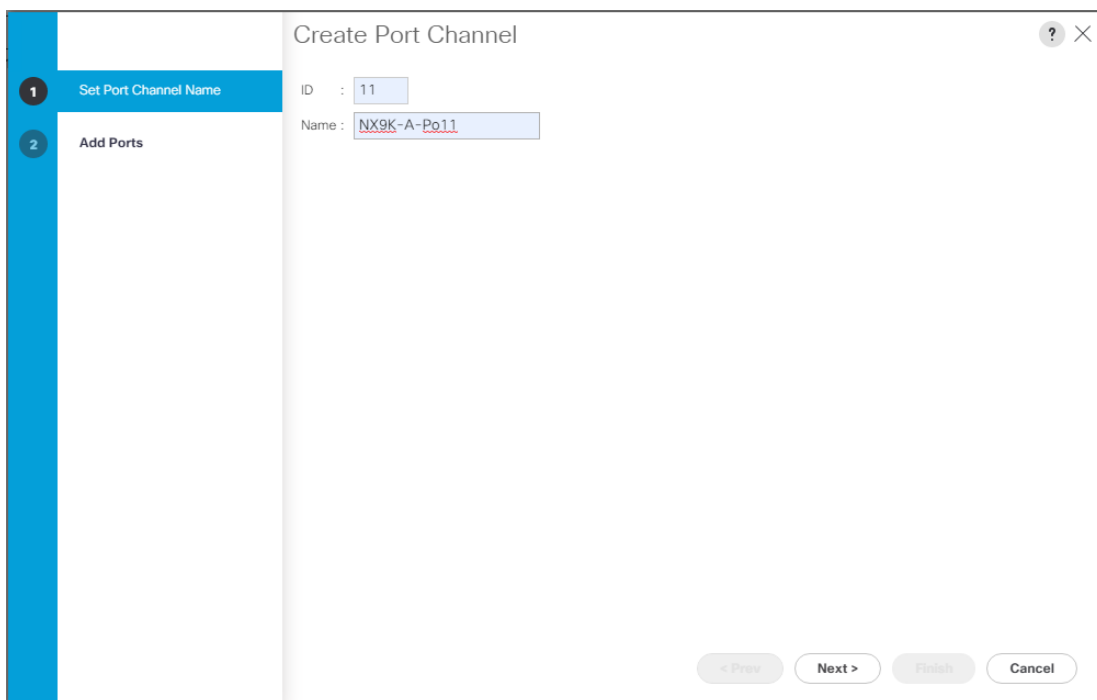

6. Click Next.
7. Select Ethernet ports 49-50 for the port channel.

Create Port Channel

1 Set Port Channel Name

2 Add Ports

Ports			
Slot ID	Aggr. Po...	Port	MAC
1	0	49	00:3A:9...
1	0	50	00:3A:9...

>>  
<<

Ports in the port channel			
Slot ID	Aggr. Po...	Port	MAC
No data available			

< Prev   Next >   **Finish**   Cancel

8. Click Finish.

Create Port Channel

1 Set Port Channel Name

2 Add Ports

Ports			
Slot ID	Aggr. Po...	Port	MAC
No data available			

>>  
<<

Ports in the port channel			
Slot ID	Aggr. Po...	Port	MAC
1	0	49	00:3A:9...
1	0	50	00:3A:9...

< Prev   Next >   **Finish**   Cancel

9. Click OK.

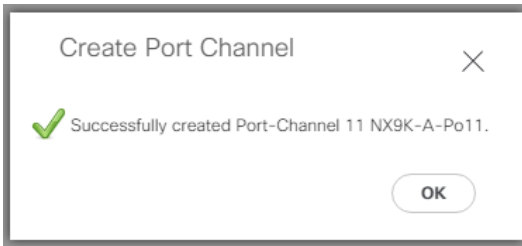

10. Repeat steps 1-9 for the Port Channel configuration on FI-B.

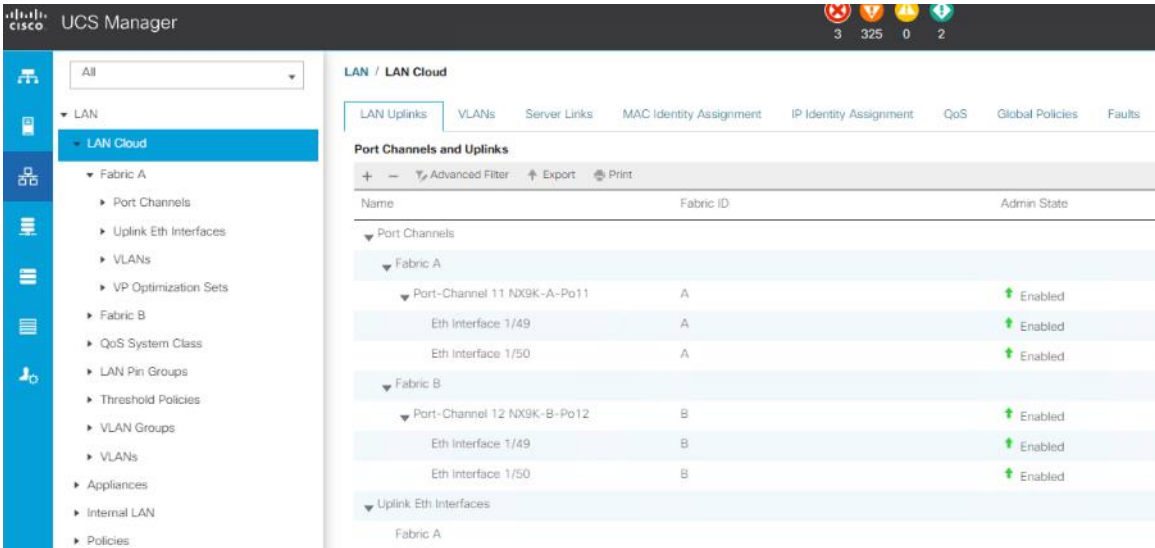

### Configure VLAN

To configure the necessary virtual local area networks (VLANs) for the Cisco UCS environment, follow these steps:

1. In Cisco UCS Manager, click the LAN tab in the navigation pane.
2. Click LAN > LAN Cloud.
3. Right-click VLANs.
4. Select Create VLANs.
5. Enter InBand-Mgmt as the name of the VLAN to be used for Public Network Traffic.
6. Keep the Common/Global option selected for the scope of the VLAN.
7. Enter 70 as the ID of the VLAN ID.
8. Keep the Sharing Type as None.
9. Click OK.

### Create VLANs

VLAN Name/Prefix :

Multicast Policy Name :  [Create Multicast Policy](#)

Common/Global
  Fabric A
  Fabric B
  Both Fabrics Configured Differently

You are creating global VLANs that map to the same VLAN IDs in all available fabrics. Enter the range of VLAN IDs.(e.g. "2009-2019", "29,35,40-45", "23", "23,34-45")

VLAN IDs :

Sharing Type :  None  Primary  Isolated  Community

10. Repeat steps 1-9 to create required VLANs. Figure 38. shows the VLANs configured for this solution.

**Figure 38. VLANs Configured for this Solution**

Name	ID	Type	Transport	Native	VLAN Sharing
VLAN default (1)	1	Lan	Ether	Yes	None
VLAN InBand-Mgmt (70)	70	Lan	Ether	No	None
VLAN Infra-Mgmt (71)	71	Lan	Ether	No	None
VLAN Launcher (76)	76	Lan	Ether	No	None
VLAN VM-Network (72)	72	Lan	Ether	No	None
VLAN vMotion (73)	73	Lan	Ether	No	None



**IMPORTANT!** Create both VLANs with global access across both fabric interconnects. This makes sure the VLAN identity is maintained across the fabric interconnects in case of a NIC failover.

## Configure VSAN

To configure the necessary virtual storage area networks (VSANs) for the Cisco UCS environment, follow these steps:

1. In Cisco UCS Manager, click the SAN tab in the navigation pane.
2. Select SAN > SAN Cloud.
3. Under VSANs, right-click VSANs.
4. Select Create VSANs.

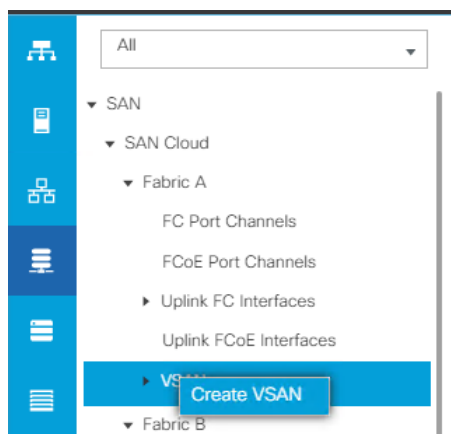

5. Enter the name of the VSAN, such as FlashStack-A.



In this solution, we created two VSANs; VSAN FlashStack-A 100 on the Cisco UCS Fabric A and VSAN FlashStack-B 101 on the Cisco UCS Fabric B for SAN Boot and Storage Access.

---

6. Select Disabled for FC Zoning



In this solution we used two Cisco MDS 9132T 32-Gb switches that provide Fibre Channel zoning.

---

7. Select Fabric A for the scope of the VSAN:
  - a. Enter 100 as VSAN ID and FCoE VLAN ID.
  - b. Click OK.

## Create VSAN ? X

Name :

---

**FC Zoning Settings**

FC Zoning :  Disabled  Enabled

Do **NOT** enable local zoning if fabric interconnect is connected to an upstream FC/FCoE switch.

Common/Global  Fabric A  Fabric B  Both Fabrics Configured Differently

You are creating a local VSAN in fabric A that maps to a VSAN ID that exists only in fabric A. A VLAN can be used to carry FCoE traffic and can be mapped to this VSAN.

Enter the VSAN ID that maps to this VSAN. Enter the VLAN ID that maps to this VSAN.

VSAN ID :  FCoE VLAN :

OK
Cancel

8. Repeat steps 1-7 to create the VSANs necessary for this solution.

[Figure 39](#) shows VSAN 100 and 101 configured for this solution.

**Figure 39. VSANs Configured for this Solution**

Name	ID	Fabric ID	If Type	If Role	Transport	FCoE VLAN ID	Operational State
▼ Fabric A							
▼ VSANs							
VSAN FlashStack-A (100)	100	A	Virtual	Network	Fc	100	OK
▼ Fabric B							
▼ VSANs							
VSAN FlashStack-B (101)	101	B	Virtual	Network	Fc	101	OK
▼ VSAN default (1)							
VSAN default (1)	1	Dual	Virtual	Network	Fc	4048	OK

### Create New Sub-Organization

To configure the necessary Sub-Organization for the Cisco UCS environment, follow these steps:

1. In Cisco UCS Manager, click the Servers tab in the navigation pane.
2. Select root > Sub-Organization.
3. Right-click Sub-Organization.

4. Enter the name of the Sub-Organization.

5. Click OK.

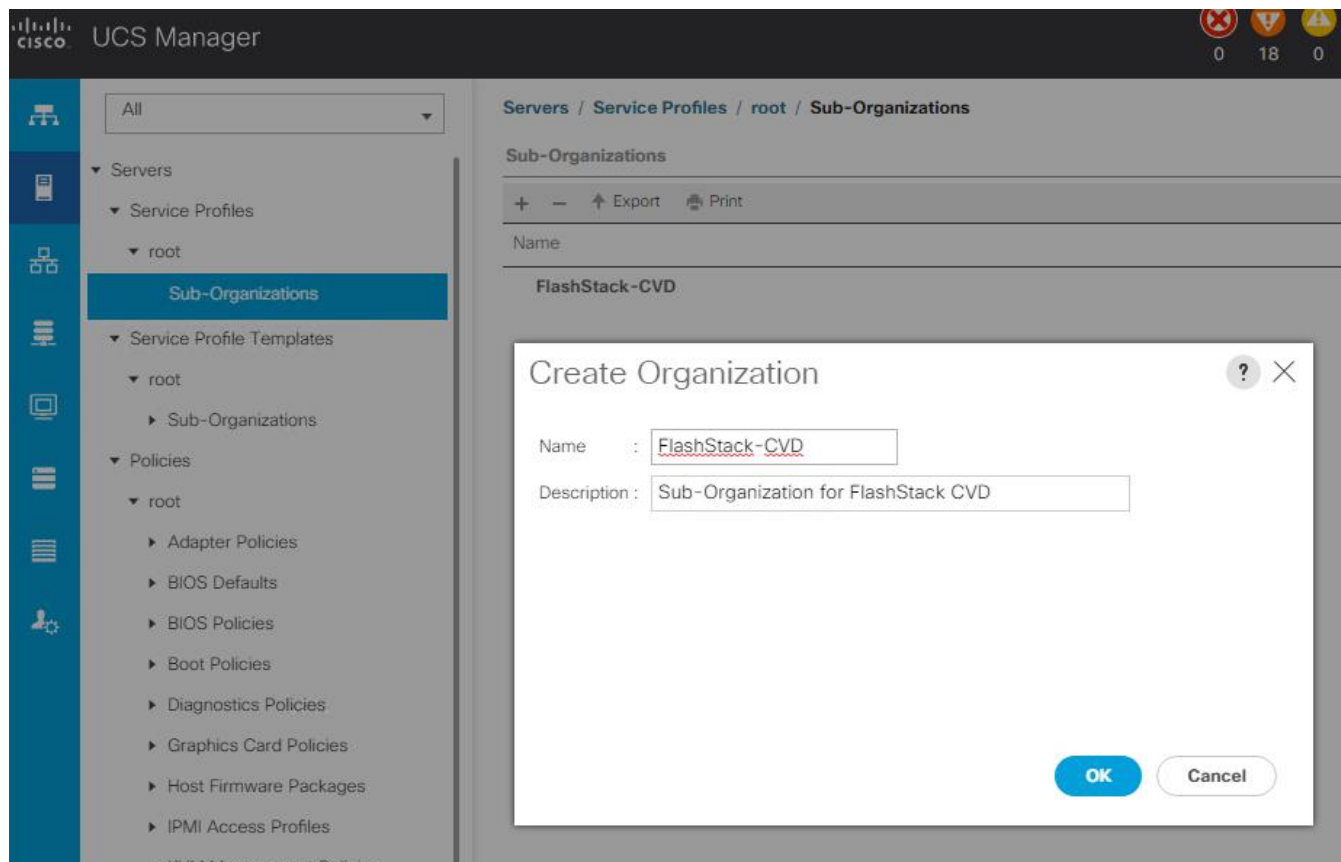

You will create pools and policies required for this solution under the newly created “FlashStack-CVD” sub-organization.

## Configure IP, UUID, Server, MAC, WWNN, and WWPN Pools

### IP Pool Creation

An IP address pool on the out of band management network must be created to facilitate KVM access to each compute node in the Cisco UCS domain. To create a block of IP addresses for server KVM access in the Cisco UCS environment, follow these steps:

1. In Cisco UCS Manager, in the navigation pane, click the LAN tab.
2. Click Pools > root > Sub-Organizations > FlashStack-CVD > IP Pools > click Create IP Pool.
3. Select the option Sequential to assign IP in sequential order then click Next.



**Create IP Pool** [?] [X]

1 Define Name and Description

2 Add IPv4 Blocks

3 Add IPv6 Blocks

Name : FlashStack-KVMPool

Description :

Assignment Order :  Default  Sequential

4. Click Add IPv4 Block.

5. Enter the starting IP address of the block and the number of IP addresses required, and the subnet and gateway information as shown below.

**Create IP Pool** [?] [X]

1 Define Name and Description

2 Add IPv4 Blocks

3 Add IPv6 Blocks

Name : [10.29.164.166]

Secondary DNS : 0.0.0.0

**Create Block of IPv4 Addresses** [?] [X]

From : 10.29.164.166 Size : 32

Subnet Mask : 255.255.255.0 Default Gateway : 10.29.164.1

Primary DNS : 0.0.0.0 Secondary DNS : 0.0.0.0

OK Cancel

+ Add - Delete

### UUID Suffix Pool Creation

To configure the necessary universally unique identifier (UUID) suffix pool for the Cisco UCS environment, follow these steps:

1. In Cisco UCS Manager, click the Servers tab in the navigation pane.
2. Click Pools > root > Sub-Organization > FlashStack-CVD.
3. Right-click UUID Suffix Pools and then select Create UUID Suffix Pool.
4. Enter the name of the UUID name.
5. Optional: Enter a description for the UUID pool.
6. Keep the prefix at the derived option and select Sequential in as Assignment Order then click Next.

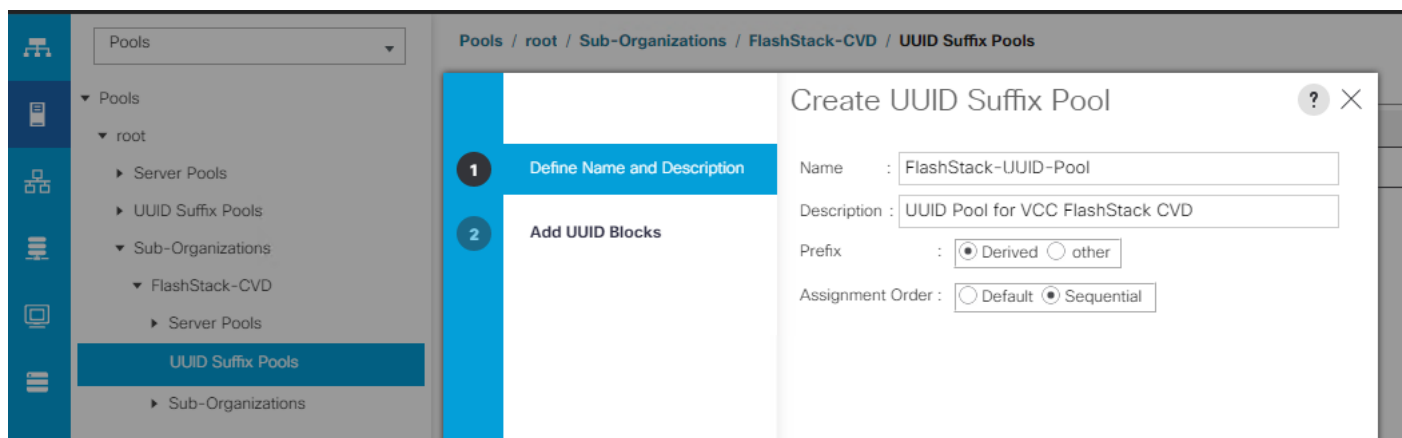

7. Click Add to add a block of UUIDs.
8. Create a starting point UUID as per your environment.
9. Specify a size for the UUID block that is sufficient to support the available blade or server resources.



### Server Pool Creation

To configure the necessary server pool for the Cisco UCS environment, follow these steps:



Consider creating unique server pools to achieve the granularity that is required in your environment.

1. In Cisco UCS Manager, click the Servers tab in the navigation pane.
2. Click Pools > root > Sub-Organization > FlashStack-CVD > right-click Server Pools > Select Create Server Pool.
3. Enter name of the server pool.
4. Optional: Enter a description for the server pool then click Next.

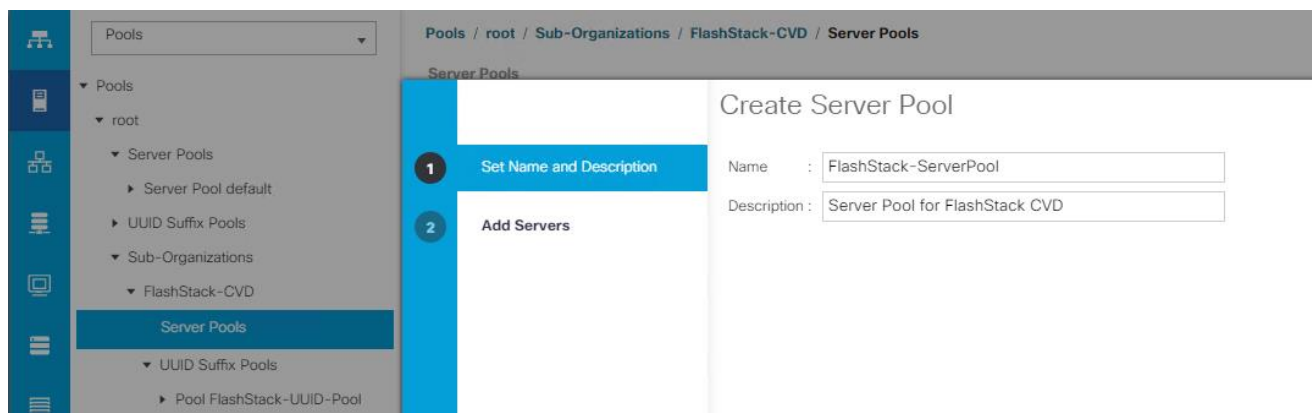

5. Select servers to be used for the deployment and click > to add them to the server pool. In our case we added thirty servers in this server pool.

6. Click Finish and then click OK.

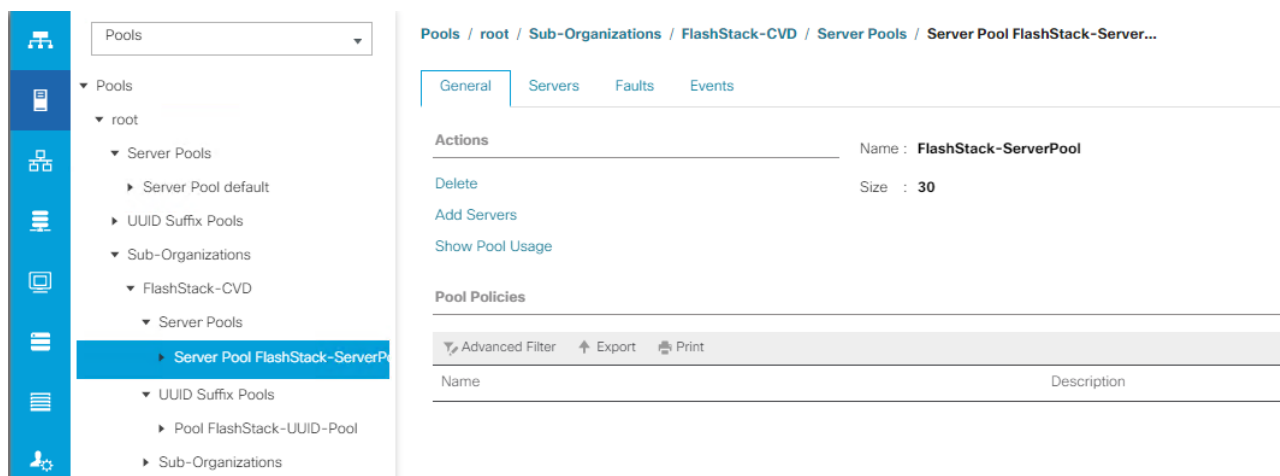

## MAC Pool Creation

To configure the necessary MAC address pools for the Cisco UCS environment, follow these steps:

1. In Cisco UCS Manager, click the LAN tab in the navigation pane.
2. Click Pools > root > Sub-Organization > FlashStack > right-click MAC Pools under the root organization.
3. Click Create MAC Pool to create the MAC address pool.
4. Enter name for MAC pool. Select Assignment Order as “Sequential.”
5. Enter the seed MAC address and provide the number of MAC addresses to be provisioned.
6. Click OK and then click Finish.
7. In the confirmation message, click OK.

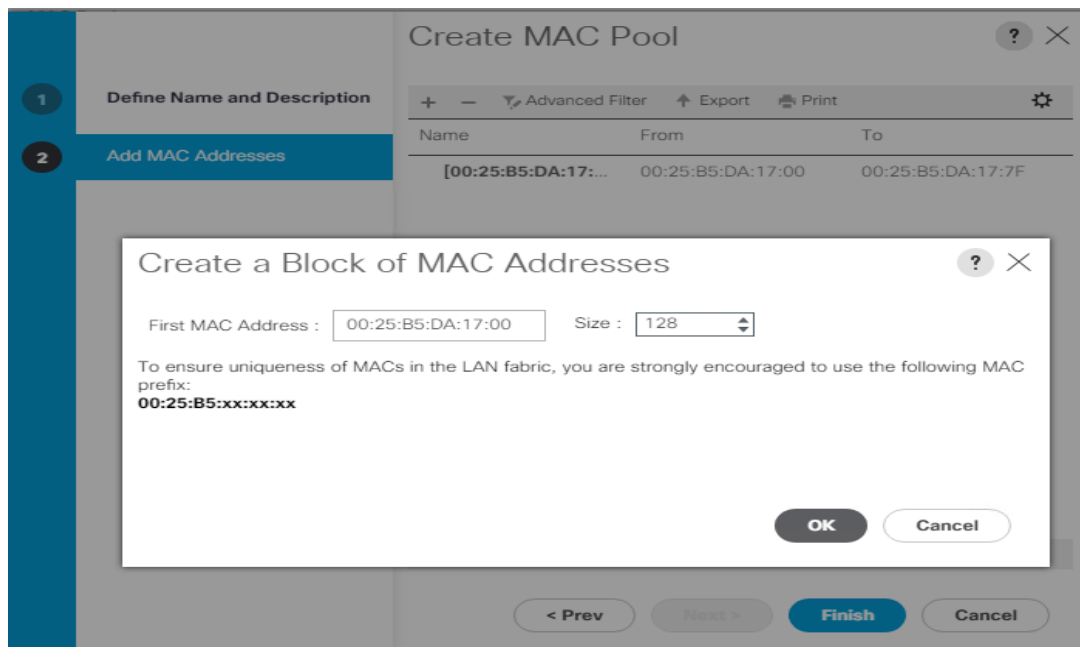

8. Create MAC Pool B and assign unique MAC Addresses as shown below.

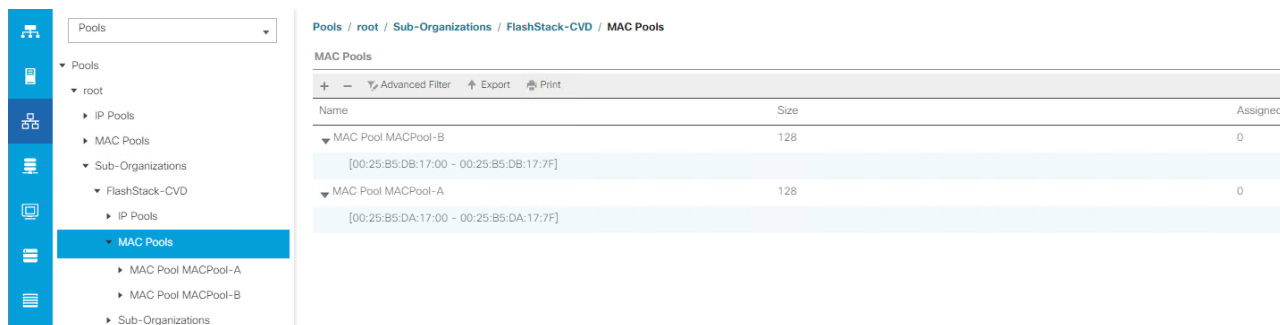

### WWNN and WWPN Pool Creation

To configure the necessary WWNN pools for the Cisco UCS environment, follow these steps:

1. In Cisco UCS Manager, click the SAN tab in the navigation pane.
2. Click Pools > Root > Sub-Organization > FlashStack-CVD > WWNN Pools > right-click WWNN Pools > select Create WWNN Pool.
3. Assign name and Assignment Order as sequential.
4. Click Next and then click Add to add block of Ports.
5. Enter Block for WWN and size of WWNN Pool as shown below.

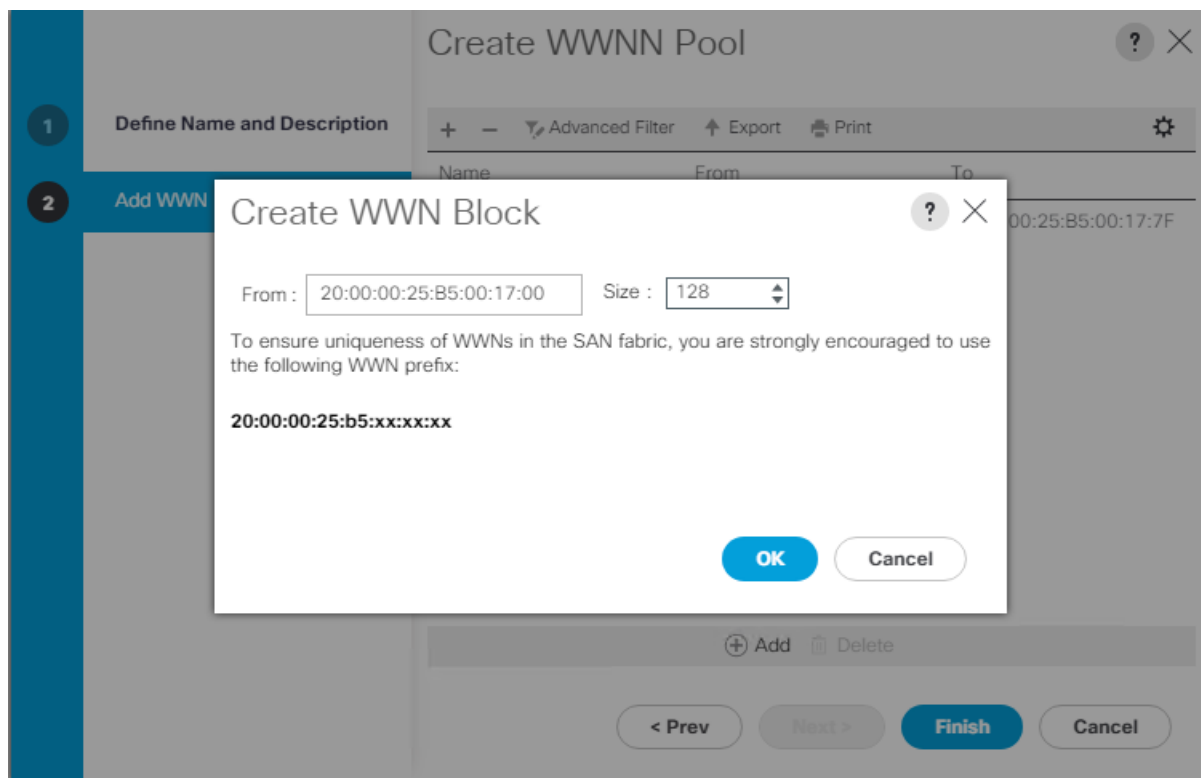

6. Click OK and then click Finish.

To configure the necessary WWPN pools for the Cisco UCS environment, follow these steps:



We created two WWPN as WWPN-A Pool and WWPN-B as World Wide Port Name as shown below. These WWNN and WWPN entries will be used to access storage through SAN configuration.

1. In Cisco UCS Manager, click the SAN tab in the navigation pane.
2. Select Pools > Root > WWPN Pools > right-click WWPN Pools > select Create WWPN Pool.
3. Assign name and Assignment Order as sequential.
4. Click Next and then click Add to add block of Ports.
5. Enter Block for WWN and size.
6. Click OK and then click Finish.

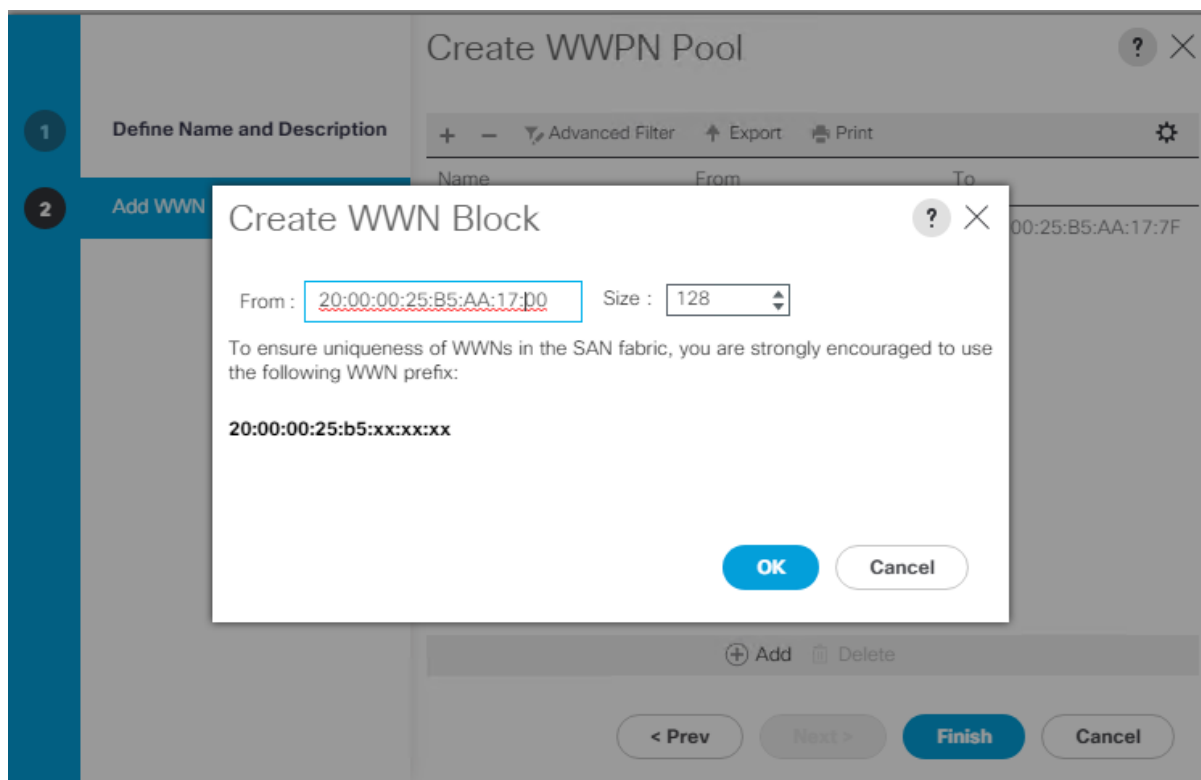

7. Configure the WWPN-B Pool and assign the unique block IDs as shown below.

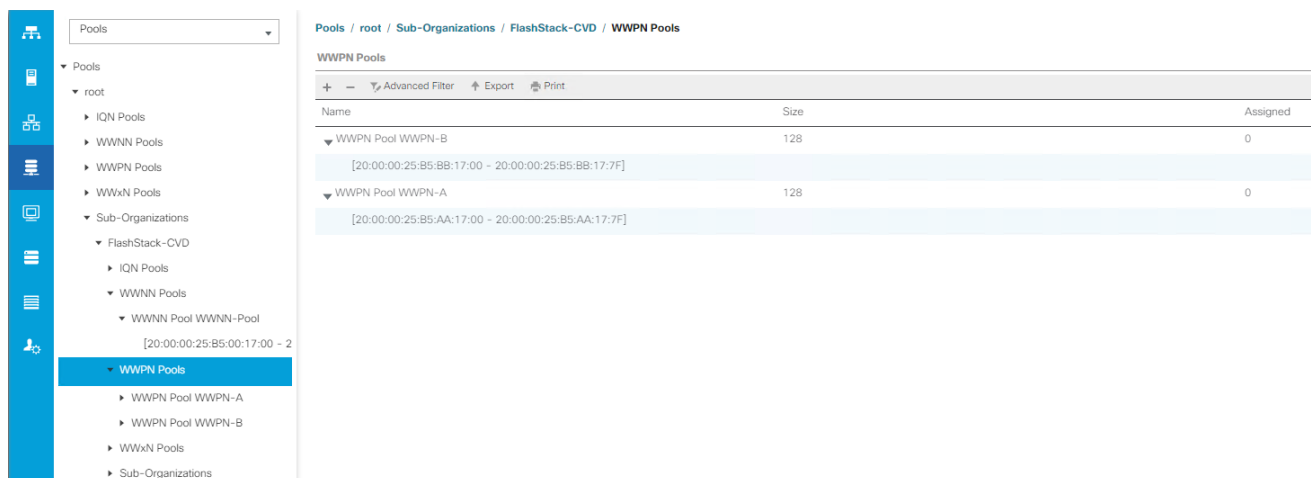

### Set Jumbo Frames in both the Cisco Fabric Interconnect

To configure jumbo frames and enable quality of service in the Cisco UCS fabric, follow these steps:

1. In Cisco UCS Manager, click the LAN tab in the navigation pane.
2. Select LAN > LAN Cloud > QoS System Class.
3. In the right pane, click the General tab.

4. On the Best Effort row, enter 9216 in the box under the MTU column.
5. Click Save Changes.
6. Click OK.

The screenshot shows the 'LAN Cloud / QoS System Class' configuration page. The 'General' tab is active. The 'Properties' section contains a table with the following data:

Priority	Enabled	CoS	Packet Drop	Weight	Weight (%)	MTU	Multicast Optimized
Platinum	<input type="checkbox"/>	5	<input type="checkbox"/>	10	N/A	normal	<input type="checkbox"/>
Gold	<input type="checkbox"/>	4	<input checked="" type="checkbox"/>	9	N/A	normal	<input type="checkbox"/>
Silver	<input type="checkbox"/>	2	<input checked="" type="checkbox"/>	8	N/A	normal	<input type="checkbox"/>
Bronze	<input type="checkbox"/>	1	<input checked="" type="checkbox"/>	7	N/A	normal	<input type="checkbox"/>
Best Effort	<input checked="" type="checkbox"/>	Any	<input checked="" type="checkbox"/>	5	50	9216	<input type="checkbox"/>
Fibre Channel	<input checked="" type="checkbox"/>	3	<input type="checkbox"/>	5	50	fc	N/A

## Create Host Firmware Package

Firmware management policies allow the administrator to select the corresponding packages for a given server configuration. These policies often include packages for adapter, BIOS, board controller, FC adapters, host bus adapter (HBA) option ROM, and storage controller properties.

To create a firmware management policy for a given server configuration in the Cisco UCS environment, follow these steps:

1. In Cisco UCS Manager, click the Servers tab in the navigation pane.
2. Select root > Sub-Organization > FlashStack-CVD > Host Firmware Packages.
3. Right-click Host Firmware Packages.
4. Select Create Host Firmware Package.
5. Enter name of the host firmware package.
6. Leave Simple selected.
7. Select the version 4.1(2a) for both the Blade Package.
8. Click OK to create the host firmware package.



### Create Host Firmware Package ? X

Name :

Description :

How would you like to configure the Host Firmware Package?

Simple  Advanced

Blade Package :

Rack Package :

Service Pack :

**The images from Service Pack will take precedence over the images from Blade or Rack Package**

Excluded Components:

Adapter  
 BIOS  
 Board Controller  
 CIMC  
 FC Adapters  
 Flex Flash Controller  
 GPUs  
 HBA Option ROM  
 Host NIC  
 Host NIC Option ROM  
 Local Disk  
 NVME Mswitch Firmware  
 PSU  
 Red Switch Firmware

## Create Server Pool Policy

### Create Server Pools Policy

Creating the server pool policy requires you to create the Server Pool Policy and Server Pool Qualification Policy.

To create a Server Pools Policy, follow these steps:

1. In Cisco UCS Manager, click the Servers tab in the navigation pane.
2. Click Pools > root > Sub-Organization > FlashStack-CVD > Server Pools.
3. Right-click Server Pools Select Create Server Pools Policy; Enter Policy name.
4. Select server from left pane to add as pooled server.



In our case, we created two server pools policies. For the “VDI-CVD01” policy, we added Servers as Chassis 1 Slot 1-8 and Chassis 3 Slot 1-8 and for the “VDI-CVD02” policy, we added Chassis 2 Slot 1-8 and Chassis 4 Slot 1-8.

Pools / root / Sub-Organizations / FlashStack-CVD / Server Pools

Server Pools

Name	Size	Assigned
Server Pool VCC-CVD01	16	16
Server Pool VCC-CVD02	16	16

### Create Server Pool Policy Qualifications

To create a Server Pool Policy Qualification Policy complete following steps:

1. In Cisco UCS Manager, click the Servers tab in the navigation pane.
2. Click Pools > root > Sub-Organization > FlashStack-CVD > Server Pool Policy Qualification.
3. Right-click Server Pools Select Create Server Pool Policy Qualification; Enter Policy name.
4. Select Chassis/Server Qualification from left pane to add in Qualifications.
5. Click Add or OK to either Add more servers to existing policy to Finish creation of Policy.

### Create Server Pool Policy Qualification

**Naming**

Name : VCC-CVD01-Qual

Description :

This server pool policy qualification will apply to new or re-discovered servers. Existing servers are not qualified until they are re-discovered

**Actions**

- Create Adapter Qualifications
- Create Chassis/Server Qualifications**
- Create Memory Qualifications
- Create CPU/Cores Qualifications
- Create Storage Qualifications
- Create Server PID Qualifications
- Create Power Group Qualifications
- Create Rack Qualifications

**Qualifications**

Name	Max	Model	From	To	Architec...	Speed	Stepping	Power G...
Chassis id range [1 - 1]			1	1				

⊕ Add   ⊗ Delete   ⓘ Info



In our case, we created two server pools policies. For the “VDI-CVD01” policy, we added Servers as Chassis 1 Slot 1-8 and Chassis 3 Slot 1-8 and for the “VDI-CVD02” policy, we added Chassis 2 Slot 1-8 and Chassis 4 Slot 1-8.

Policies / root / Sub-Organizations / FlashStack-CVD / Server Pool Policy Qualifications

#### Server Pool Policy Qualifications

Name	Max	Model	From	To
▼ VCC-CVD01-Qual				
Chassis id range [1 - 1]			1	1
Chassis id range [3 - 3]			3	3
▼ VCC-CVD02-Qual				
Chassis id range [2 - 2]			2	2
Chassis id range [4 - 4]			4	4

To create a Server Pool Policy, follow these steps:

1. In Cisco UCS Manager, click the Servers tab in the navigation pane.
2. Click Pools > root > Sub-Organization > FlashStack-CVD > Server Pool Policies.
3. Right-click Server Pool Policies and Select Create Server Pool Policy; Enter Policy name.
4. Select Target Pool and Qualification from the drop-down list.
5. Click OK.

### Create Server Pool Policy ? ×

Name :

Description :

Target Pool :

Qualification :



We created two Server Pool Policies to associate with the Service Profile Templates “VDI-CVD01” and “VDI-CVD02” as described in this section.

## Create Network Control Policy for Cisco Discovery Protocol

To create a network control policy that enables Cisco Discovery Protocol (CDP) on virtual network ports, follow these steps:

1. In Cisco UCS Manager, click the LAN tab in the navigation pane.
2. Click Policies > root > Sub-Organization > FlashStack-CVD > Network Control Policies.
3. Right-click Network Control Policies.
4. Click Create Network Control Policy.
5. Enter policy name.
6. Select the Enabled option for “CDP.”
7. Click OK to create the network control policy.

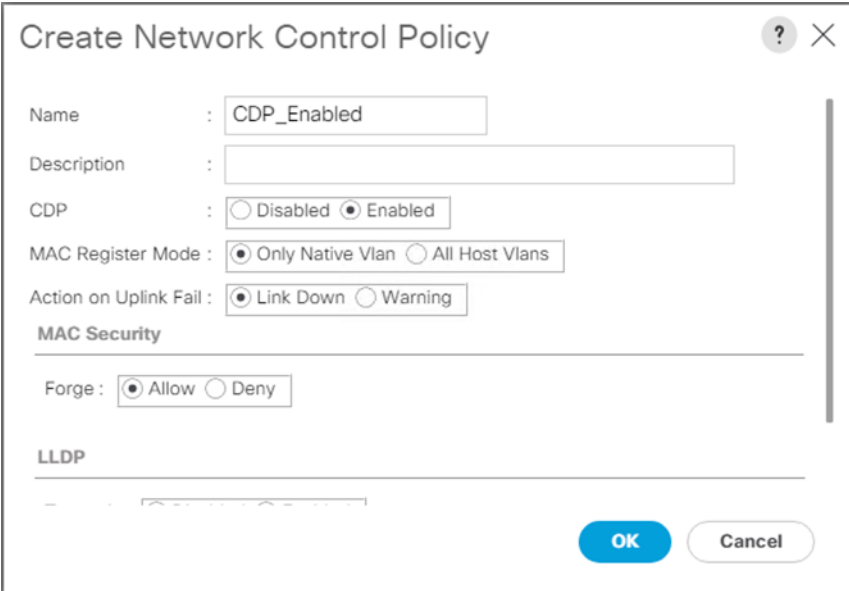

The screenshot shows a dialog box titled "Create Network Control Policy" with a question mark icon and a close button (X) in the top right corner. The dialog contains the following fields and options:

- Name: CDP\_Enabled
- Description: (empty text box)
- CDP:  Disabled  Enabled
- MAC Register Mode:  Only Native Vlan  All Host Vlans
- Action on Uplink Fail:  Link Down  Warning
- MAC Security section:
  - Forge:  Allow  Deny
- LLDP section:
  - (empty text box)

At the bottom of the dialog, there are two buttons: "OK" (blue) and "Cancel" (white with blue border).

## Create Power Control Policy

To create a power control policy for the Cisco UCS environment, follow these steps:

1. In Cisco UCS Manager, click the Servers tab in the navigation pane.
2. Click Policies > root > Sub-Organization > FlashStack-CVD > Power Control Policies.
3. Right-click Power Control Policies.
4. Click Create Power Control Policy.
5. Select Fan Speed Policy as “Max Power.”

6. Enter NoPowerCap as the power control policy name.
7. Change the power capping setting to No Cap.
8. Click OK to create the power control policy.

### Create Power Control Policy

Name :

Description :

Fan Speed Policy :

**Power Capping**

If you choose **cap**, the server is allocated a certain amount of power based on its priority within its power group. Priority values range from 1 to 10, with 1 being the highest priority. If you choose **no-cap**, the server is exempt from all power capping.

No Cap  cap

Cisco UCS Manager only enforces power capping when the servers in a power group require more power than is currently available. With sufficient power, all servers run at full capacity regardless of their priority.

### Create Server BIOS Policy

To create a server BIOS policy for the Cisco UCS environment, follow these steps:

1. In Cisco UCS Manager, click the Servers tab in the navigation pane.
2. Click Policies > root > Sub-Organization > FlashStack-CVD > BIOS Policies.
3. Right-click BIOS Policies.
4. Click Create BIOS Policy.
5. Enter B200-M5-BIOS as the BIOS policy name.
6. Click OK to create policy.”

**Create BIOS Policy** ? X

Name : B200M5-BIOS

Description :

Reboot on BIOS Settings Change :

OK Cancel

7. Leave all BIOS Settings as “Platform Default.”

### **Configure Maintenance Policy**

To update the default Maintenance Policy, follow these steps:

1. In Cisco UCS Manager, click the Servers tab in the navigation pane.
2. Click Policies > root > Sub-Organization > FlashStack-CVD > Maintenance Policies.
3. Right-click Maintenance Policies to create a new policy.
4. Enter name for Maintenance Policy
5. Change the Reboot Policy to User Ack.
6. Click Save Changes.
7. Click OK to accept the change.

#### Actions

Delete  
Show Policy Usage  
Use Global

#### Properties

Name : **UserAck**  
Description :   
Owner : **Local**  
Soft Shutdown Timer : 150 Secs  
Storage Config. Deployment Policy :  Immediate  User Ack  
Reboot Policy :  Immediate  User Ack  Timer Automatic  
 On Next Boot (Apply pending changes at next reboot.)

## Create vNIC Templates

To create multiple virtual network interface card (vNIC) templates for the Cisco UCS environment, follow these steps:

1. In Cisco UCS Manager, click the LAN tab in the navigation pane.
2. Click Policies > root > Sub-Organization > FlashStack-CVD > vNIC Template.
3. Right-click vNIC Templates.
4. Click Create vNIC Template.
5. Enter name for vNIC template.
6. Keep Fabric A selected. Do not select the Enable Failover checkbox.
7. For Redundancy Type, Select "Primary Template."
8. Select Updating Template as the Template Type.
9. Under VLANs, select the checkboxes for desired VLANs to add as part of the vNIC Template.
10. Set Native-VLAN as the native VLAN.
11. For MTU, enter 9000.
12. In the MAC Pool list, select MAC Pool configure for Fabric A.
13. In the Network Control Policy list, select CDP\_Enabled.
14. Click OK to create the vNIC template.



## Create vNIC Template



If **VM** is selected, a port profile by the same name will be created.  
If a port profile of the same name exists, and updating template is selected, it will be overwritten

Template Type :  Initial Template  Updating Template

VLANs | VLAN Groups

Advanced Filter | Export | Print

Select	Name	Native VLAN
<input checked="" type="checkbox"/>	default	<input checked="" type="radio"/>
<input checked="" type="checkbox"/>	InBand-Mgmt	<input type="radio"/>
<input checked="" type="checkbox"/>	Infra-Mgmt	<input type="radio"/>
<input checked="" type="checkbox"/>	Launcher	<input type="radio"/>
<input checked="" type="checkbox"/>	VM-Network	<input type="radio"/>
<input checked="" type="checkbox"/>	vMotion	<input type="radio"/>

### Create VLAN

CDN Source :  vNIC Name  User Defined

MTU : 9000

MAC Pool : MACPool-A(128/128)

QoS Policy : <not set>

Network Control Policy : CDP\_Enabled

Pin Group : <not set>

Stats Threshold Policy : default

### Connection Policies

OK Cancel

- Repeat steps 1-14 to create a vNIC Template for Fabric B. For Peer redundancy Template Select "vNIC-Template-A" created in the previous step.

## Create vNIC Template ? X

Name :

Description :

Fabric ID :  Fabric A  Fabric B  Enable Failover

**Redundancy**

---

Redundancy Type :  No Redundancy  Primary Template  Secondary Template

Peer Redundancy Template :

**Target**

Adapter

VM

**Warning**

If **VM** is selected, a port profile by the same name will be created.  
 If a port profile of the same name exists, and updating template is selected, it will be overwritten

Template Type :  Initial Template  Updating Template

**VLANs** | VLAN Groups

Advanced Filter | Export | Print ⚙

Select	Name	Native VLAN
<input checked="" type="checkbox"/>	default	<input checked="" type="radio"/>
<input checked="" type="checkbox"/>	InBand-Mgmt	<input type="radio"/>
<input checked="" type="checkbox"/>	Infra-Mgmt	<input type="radio"/>
<input checked="" type="checkbox"/>	Launcher	<input type="radio"/>

16. Verify that vNIC-Template-A Peer Redundancy Template is set to “vNIC-Template-B.”

**Create vHBA Templates**

To create multiple virtual host bus adapter (vHBA) templates for the Cisco UCS environment, follow these steps:

1. In Cisco UCS Manager, click the SAN tab in the navigation pane.

2. Click Policies > root > Sub-Organization > FlashStack-CVD > vHBA Template.
3. Right-click vHBA Templates.
4. Click Create vHBA Template.
5. Enter vHBA-A as the vHBA template name.
6. Keep Fabric A selected.
7. Select VSAN created for Fabric A from the drop-down list.
8. Change to Updating Template.
9. For Max Data Field keep 2048.
10. Select WWPN Pool for Fabric A (created earlier) for our WWPN Pool.
11. Leave the remaining fields as is.
12. Click OK.

## Create vHBA Template



Name : vHBA-A

Description :

Fabric ID :  A  B

**Redundancy**

---

Redundancy Type :  No Redundancy  Primary Template  Secondary Template

Select VSAN : FlashStack-A [Create VSAN](#)

Template Type :  Initial Template  Updating Template

Max Data Field Size : 2048

WWPN Pool : WWPN-A(128/128) ▼

QoS Policy : <not set> ▼

Pin Group : <not set> ▼

Stats Threshold Policy : default ▼

OK

Cancel

---

13. Repeat steps 1-12 to create a vHBA Template for Fabric B.

### Create Server Boot Policy for SAN Boot

All Cisco UCS B200 M5 Blade Servers for the workload and the two Infrastructure servers were set to boot from SAN for this Cisco Validated Design as part of the Service Profile template. The benefits of booting from SAN are numerous; disaster recovery, lower cooling, and power requirements for each server since a local drive is not required, and better performance, to name just a few.



We strongly recommend using “Boot from SAN” to realize the full benefits of Cisco UCS stateless computing features, such as service profile mobility.



This process applies to a Cisco UCS environment in which the storage SAN ports are configured as explained in the following section.



A Local disk configuration for the Cisco UCS is necessary if the servers in the environments have a local disk.

---

To configure Local disk policy, follow these steps:

1. Go to tab Servers > Policies > root > Sub-Organization > FlashStack-CVD > right-click Local Disk Configuration Policy > Enter “SAN-Boot” as the local disk configuration policy name and change the mode to “No Local Storage.”
2. Click OK to create the policy.

### Create Local Disk Configuration Policy ? X

Name :

Description :

Mode :

---

**FlexFlash**

FlexFlash State :  Disable  Enable

If **FlexFlash State** is disabled, SD cards will become unavailable immediately. Please ensure SD cards are not in use before disabling the FlexFlash State.

FlexFlash RAID Reporting State :  Disable  Enable

FlexFlash Removable State :  Yes  No  No Change

If **FlexFlash Removable State** is changed, SD cards will become unavailable temporarily. Please ensure SD cards are not in use before changing the FlexFlash Removable State.

As shown in the screenshot below, the Pure Storage FlashArray have four active FC connections that pair with the Cisco MDS 9132T 32-Gb switches. Two FC ports are connected to Cisco MDS-A and the other Two FC ports are connected to Cisco MDS-B Switches. All FC ports are 32 Gb/s. The SAN Port CT0.FC0 of Pure Storage FlashArray Controller 0 is connected to Cisco MDS Switch A and SAN port CT0.FC2 is connected to MDS Switch B. The SAN Port CT1.FC0 of Pure Storage FlashArray Controller 1 is connected to Cisco MDS Switch A and SAN port CT1.FC2 connected to MDS Switch B.

Array Ports							
FC Port	Name	Speed	Fallover	FC Port	Name	Speed	Fallover
CT0.FC0	52-4A-93:71:56:84:09:00	32 Gb/s		CT1.FC0	52-4A-93:71:56:84:09:10	32 Gb/s	
CT0.FC1	52-4A-93:71:56:84:09:01	0		CT1.FC1	52-4A-93:71:56:84:09:11	0	
CT0.FC2	52-4A-93:71:56:84:09:02	32 Gb/s		CT1.FC2	52-4A-93:71:56:84:09:12	32 Gb/s	
CT0.FC3	52-4A-93:71:56:84:09:03	0		CT1.FC3	52-4A-93:71:56:84:09:13	0	
CT0.FC8	52-4A-93:71:56:84:09:08	0		CT1.FC8	52-4A-93:71:56:84:09:18	0	
CT0.FC9	52-4A-93:71:56:84:09:09	0		CT1.FC9	52-4A-93:71:56:84:09:19	0	

### Create SAN Policy A

The SAN-A boot policy configures the SAN Primary's primary-target to be port CT0.FC0 on the Pure Storage cluster and SAN Primary's secondary-target to be port CT1.FC0 on the Pure Storage cluster. Similarly, the SAN Secondary's primary-target should be port CT1.FC2 on the Pure Storage cluster and SAN Secondary's secondary-target should be port CT0.FC2 on the Pure Storage cluster.

Log into the storage controller and verify all the port information is correct. This information can be found in the Pure Storage GUI under System > Connections > Target Ports.

You have to create a SAN Primary (hba0) and a SAN Secondary (hba1) in SAN-A Boot Policy by entering WWPN of Pure Storage FC Ports as explained in the following section.

To create Boot Policies for the Cisco UCS environments, follow these steps:

1. Go to Cisco UCS Manager and then go to Servers > Policies > root > Sub Organization > FlashStack-CVD > Boot Policies. Right-click and select Create Boot Policy.
2. Enter SAN-A as the name of the boot policy.

### Create Boot Policy

Name : SAN-A

Description :

Reboot on Boot Order Change :

Enforce vNIC/vHBA/iSCSI Name :

Boot Mode :  Legacy  Uefi

**WARNINGS:**  
The type (primary/secondary) does not indicate a boot order presence.  
The effective order of boot devices within the same device class (LAN/Storage/iSCSI) is determined by PCIe bus scan order.  
If **Enforce vNIC/vHBA/iSCSI Name** is selected and the vNIC/vHBA/iSCSI does not exist, a config error will be reported.  
If it is not selected, the vNICs/vHBAs are selected if they exist, otherwise the vNIC/vHBA with the lowest PCIe bus scan order is used.

+ Local Devices

+ CIMC Mounted vMedia

+ vNICs

+ vHBAs

+ iSCSI vNICs

+ EFI Shell

Name	Order	vNIC/vH...	Type	LUN Na...	WWN	Slot Nu...	Boot Na...	Boot Path	Descripti...
No data available									

↑ Move Up ↓ Move Down Delete

Set Uefi Boot Parameters

OK Cancel

3. Expand the Local Devices drop-down list and Choose Add CD/DVD.

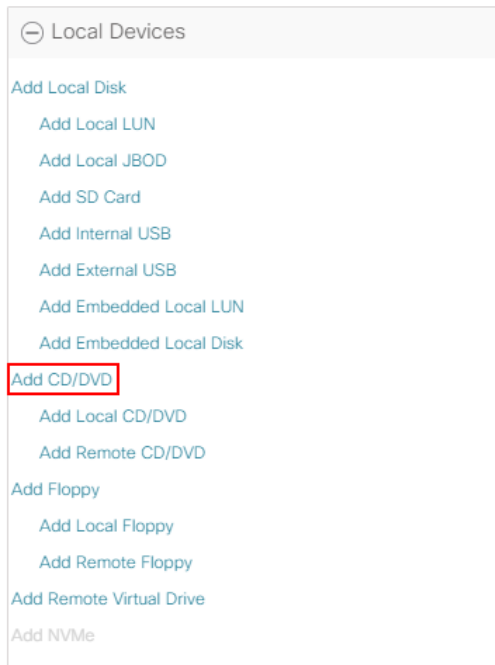

4. Expand the vHBAs drop-down list and Choose Add SAN Boot.

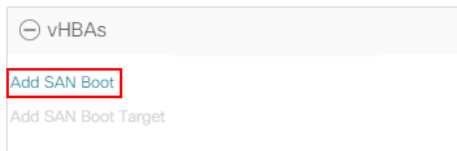

The SAN boot paths and targets will include primary and secondary options in order to maximize resiliency and number of paths.

5. In the Add SAN Boot dialog box, for Type select “Primary” and name vHBA as “vHBA0”. Click OK to add SAN Boot.

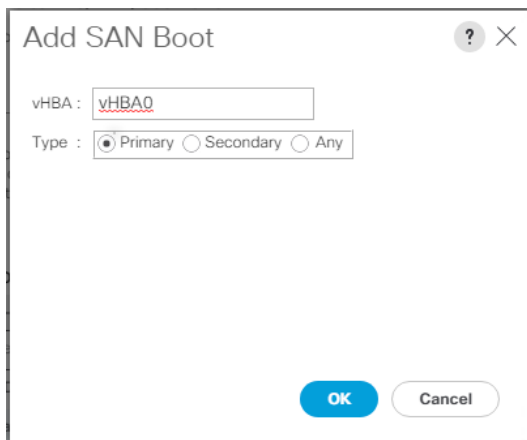

6. Select add SAN Boot Target.



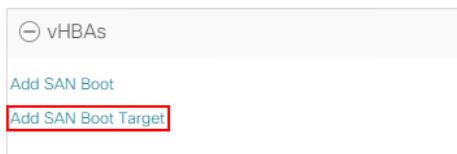

7. Keep **1** as the value for Boot Target LUN. Enter the WWPN for FC port CT0.FC0 of Pure Storage and add SAN Boot Primary Target.

A screenshot of the "Add SAN Boot Target" dialog box. It has a title bar with a question mark and a close button. The fields are: "Boot Target LUN" with the value "1"; "Boot Target WWPN" with the value "52:4A:93:71:56:84:09:00" (highlighted with a blue box); and "Type" with radio buttons for "Primary" (selected) and "Secondary". At the bottom are "OK" and "Cancel" buttons.

8. Add a secondary SAN Boot target into same hba0, enter the boot target LUN as **1** and WWPN for FC port CT1.FC0 of Pure Storage, and add SAN Boot Secondary Target.

A screenshot of the "Add SAN Boot Target" dialog box. It has a title bar with a question mark and a close button. The fields are: "Boot Target LUN" with the value "1"; "Boot Target WWPN" with the value "52:4A:93:71:56:84:09:10" (highlighted with a blue box); and "Type" with radio buttons for "Primary" and "Secondary" (selected). At the bottom are "OK" and "Cancel" buttons.

9. From the vHBA drop-down list and choose Add SAN Boot. In the Add SAN Boot dialog box, enter "vHBA1" in the vHBA field. Click OK to SAN Boot, then choose Add SAN Boot Target.

**Add SAN Boot** ? X

vHBA :

Type :  Primary  Secondary  Any

**OK** **Cancel**

10. Keep **1** as the value for the Boot Target LUN. Enter the WWPN for FC port CT1.FC2 of Pure Storage and add SAN Boot Primary Target.

**Add SAN Boot Target** ? X

Boot Target LUN :

Boot Target WWPN :

Type :  Primary  Secondary

**OK** **Cancel**

11. Add a secondary SAN Boot target into same vHBA1 and enter the boot target LUN as **1** and WWPN for FC port CT0.FC2 of Pure Storage and add SAN Boot Secondary Target.

### Add SAN Boot Target

Boot Target LUN :

Boot Target WWPN :

Type :  Primary  Secondary

12. Click Save Changes.

Servers / Policies / root / Sub-Organizations / FlashStack-CVD / Boot Policies / Boot Policy SAN-A

General Events

**Actions**

Delete  
Show Policy Usage  
Use Global

**Properties**

Name : SAN-A  
Description :  
Owner : Local  
Reboot on Boot Order Change :   
Enforce vNIC/vHBA/SCSI Name :   
Boot Mode :  Legacy  Uefi

**Warning**

The type (primary/secondary) does not indicate a boot order preference.  
The effective order of boot devices within the same device class (LAN/Storage/SCSI) is determined by PCIe bus scan order.  
If **Enforce vNIC/vHBA/SCSI Name** is selected and the vNIC/vHBA/SCSI does not exist, a config error will be reported.  
If it is not selected, the vNICs/vHBAs are selected if they exist, otherwise the vNIC/vHBA with the lowest PCIe bus scan order is used.

**Boot Order**

Name	Order	vNIC/vHBA/SCSI	Type	LUN Name	WWN	Slot Number	Boot Name	Boot Path	Description
CD/DVD	1								
San	2								

13. After creating the FC boot policy, you can view the boot order in the Cisco UCS Manager GUI. To view the boot order, navigate to Servers > Policies > Boot Policies. Click Boot Policy SAN-Boot-A to view the boot order in the right pane of the Cisco UCS Manager as shown below:

Boot Policies		Events			
		Advanced Filter	Export	Print	
Name	Order	vNIC/vHBA/iSCSI...	Type	LUN Name	WWN
▼ Boot Policy SAN-A					
CD/DVD	1				
▼ San					
▼ SAN Primary		vHBA0	Primary		
SAN Target Primary			Primary	1	52:4A:93:71:56:84:09:00
SAN Target Secondary			Secondary	1	52:4A:93:71:56:84:09:10
▼ SAN Secondary		vHBA1	Secondary		
SAN Target Primary			Primary	1	52:4A:93:71:56:84:09:12
SAN Target Secondary			Secondary	1	52:4A:93:71:56:84:09:02

### Create SAN Policy B

The SAN-B boot policy configures the SAN Primary's primary-target to be port CT0.FC6 on the Pure Storage cluster and SAN Primary's secondary-target to be port CT1.FC6 on the Pure Storage cluster. Similarly, the SAN Secondary's primary-target should be port CT1.FC0 on the Pure Storage cluster and SAN Secondary's secondary-target should be port CT0.FC0 on the Pure Storage cluster.

Log into the storage controller and verify all the port information is correct. This information can be found in the Pure Storage GUI under System > Connections > Target Ports.

You have to create SAN Primary (vHBA1) and SAN Secondary (vHBA0) in SAN-B Boot Policy by entering WWPN of Pure Storage FC Ports as explained in the following section.

To create boot policies for the Cisco UCS environments, follow these steps:

1. Go to Cisco UCS Manager and then go to tab Servers > Policies > root > Sub Organization > FlashStack-CVD > Boot Policies.
2. Right-click and select Create Boot Policy. Enter SAN-B as the name of the boot policy.

### Create Boot Policy ? X

Name :

Description :

Reboot on Boot Order Change :

Enforce vNIC/vHBA/iSCSI Name :

Boot Mode :  Legacy  Uefi

**WARNINGS:**  
 The type (primary/secondary) does not indicate a boot order presence.  
 The effective order of boot devices within the same device class (LAN/Storage/iSCSI) is determined by PCIe bus scan order.  
 If **Enforce vNIC/vHBA/iSCSI Name** is selected and the vNIC/vHBA/iSCSI does not exist, a config error will be reported.  
 If it is not selected, the vNICs/vHBAs are selected if they exist, otherwise the vNIC/vHBA with the lowest PCIe bus scan order is used.

- 
- 
- 
- 
- 
-

**Boot Order**

+ - Advanced Filter Export Print ⚙

Name	Order	vNIC/vH...	Type	LUN Na...	WWN	Slot Nu...	Boot Na...	Boot Path	Descripti...
No data available									

- Expand the Local Devices drop-down list and Choose Add CD/DVD. Expand the vHBAs drop-down list and choose Add SAN Boot.



The SAN boot paths and targets include primary and secondary options in order to maximize resiliency and number of paths.

- In the Add SAN Boot dialog box, for Type select “Primary” and name vHBA as “vHBA0.” Click OK to add SAN Boot.

Add SAN Boot

vHBA :

Type :  Primary  Secondary  Any

OK Cancel

5. Select Add SAN Boot Target to enter WWPN address of storage port. Keep 1 as the value for Boot Target LUN. Enter the WWPN for FC port CT0.FC2 of Pure Storage and add SAN Boot Primary Target.

Add SAN Boot Target

Boot Target LUN :

Boot Target WWPN :

Type :  Primary  Secondary

OK Cancel

6. Add the secondary SAN Boot target into the same hba0; enter boot target LUN as 1 and WWPN for FC port CT0.FC0 of Pure Storage and add SAN Boot Secondary Target.

**Add SAN Boot Target** ? X

Boot Target LUN : 1

Boot Target WWPN : 52:4A:93:71:56:84:09:00

Type :  Primary  Secondary

OK Cancel

7. From the vHBA drop-down list, choose Add SAN Boot. In the Add SAN Boot dialog box, enter " hba1 " in the vHBA field. Click OK to SAN Boot, then choose Add SAN Boot Target.

**Add SAN Boot** ? X

vHBA : vHBA0

Type :  Primary  Secondary  Any

OK Cancel

8. Keep 1 as the value for Boot Target LUN. Enter the WWPN for FC port CT0.FC1 of Pure Storage and Add SAN Boot Primary Target.



The screenshot shows a dialog box titled "Add SAN Boot Target" with a question mark icon and a close button (X) in the top right corner. The dialog contains three input fields: "Boot Target LUN" with the value "1", "Boot Target WWPN" with the value "52:4A:93:71:56:84:09:02" (which is underlined in red), and "Type" with radio buttons for "Primary" (selected) and "Secondary". At the bottom right, there are two buttons: "OK" (blue) and "Cancel" (white with a grey border).

9. Add secondary SAN Boot target into same hba1 and enter boot target LUN as 1 and WWPN for FC port CT1.FC1 of Pure Storage and add SAN Boot Secondary Target.

The screenshot shows a dialog box titled "Add SAN Boot Target" with a question mark icon and a close button (X) in the top right corner. The dialog contains three input fields: "Boot Target LUN" with the value "1", "Boot Target WWPN" with the value "52:4A:93:71:56:84:09:12", and "Type" with radio buttons for "Primary" and "Secondary" (selected). At the bottom right, there are two buttons: "OK" (blue) and "Cancel" (white with a grey border).

10. Click OK.

### Create Boot Policy

Name : SAN-B

Description :

Reboot on Boot Order Change :

Enforce vNIC/vHBA/iSCSI Name :

Boot Mode :  Legacy  Uefi

**WARNINGS:**  
 The type (primary/secondary) does not indicate a boot order presence.  
 The effective order of boot devices within the same device class (LAN/Storage/iSCSI) is determined by PCIe bus scan order.  
 If **Enforce vNIC/vHBA/iSCSI Name** is selected and the vNIC/vHBA/iSCSI does not exist, a config error will be reported.  
 If it is not selected, the vNICs/vHBAs are selected if they exist, otherwise the vNIC/vHBA with the lowest PCIe bus scan order is used.

- Local Devices
- CIMC Mounted vMedia
- vNICs
- vHBAs
  - Add SAN Boot
  - Add SAN Boot Target
- iSCSI vNICs
- EFI Shell

**Boot Order**

Name	Or...	vNIC/...	Type	LUN ...	WWN	Slot N...	Boot ...	Boot ...	Descri...
CD/DVD	1								
▶ San	2								

11. After creating the FC boot policies, you can view the boot order in the Cisco UCS Manager GUI. To view the boot order, navigate to Servers > Policies > Boot Policies. Click Boot Policy SAN-Boot-B to view the boot order in the right pane of the Cisco UCS Manager as shown below:

Servers / Policies / root / Sub-Organizations / FlashStack-CVD / Boot Policies

Boot Policies Events

+ - Advanced Filter Export Print

Name	Order	vNIC/vHBA/iSCSI vNIC	Type	LUN Name	WWN
▶ Boot Policy SAN-A					
▼ Boot Policy SAN-B					
CD/DVD	1				
▼ San	2				
▼ SAN Primary		vHBA1	Primary		
SAN Target Primary			Primary	1	52:4A:93:71:56:84:09:10
SAN Target Secondary			Secondary	1	52:4A:93:71:56:84:09:00
▼ SAN Secondary		vHBA0	Secondary		
SAN Target Primary			Primary	1	52:4A:93:71:56:84:09:02
SAN Target Secondary			Secondary	1	52:4A:93:71:56:84:09:12



For this solution, we created two Boot Policy as “SAN-A” and “SAN-B”. For 32 Cisco UCS B200 M5 blade servers, you will assign the first 16 Service Profiles with SAN-A to the first 16 servers and the remaining 16 Service Profiles with SAN-B to the remaining 16 servers as explained in the following section.

## Configure and Create a Service Profile Template

Service profile templates enable policy-based server management that helps ensure consistent server resource provisioning suitable to meet predefined workload needs.

You will create two Service Profile templates; the first Service profile template “VDI-CVD01” uses the boot policy “SAN-A” and the second Service profile template “VDI-CVD02” uses the boot policy “SAN-B” to utilize all the FC ports from Pure Storage for high-availability in case any FC links go down.

You will create the first VDI-CVD01 as explained in the following section.

### Create Service Profile Template

To create a service profile template, follow these steps:

1. In the Cisco UCS Manager, go to Servers > Service Profile Templates > root Sub Organization > FlashStack-CVD > and right-click Create Service Profile Template.
2. Enter the Service Profile Template name, select the UUID Pool that was previously created, and click Next.

**Create Service Profile Template** ? X

You must enter a name for the service profile template and specify the template type. You can also specify how a UUID will be assigned to this template and enter a description.

Name :

The template will be created in the following organization. Its name must be unique within this organization.  
Where : **org-root/org-FlashStack-CVD**

The template will be created in the following organization. Its name must be unique within this organization.

Type :  Initial Template  Updating Template

Specify how the UUID will be assigned to the server associated with the service generated by this template.  
UUID

UUID Assignment:

The UUID will be assigned from the selected pool.  
The available/total UUIDs are displayed after the pool name.

3. Select Local Disk Configuration Policy to SAN-Boot as No Local Storage.

**Create Service Profile Template** ? X

Optionally specify or create a Storage Profile, and select a local disk configuration policy.

Specific Storage Profile    Storage Profile Policy    **Local Disk Configuration Policy**

Local Storage:

[Create Local Disk Configuration Policy](#)

Mode : **Any Configuration**  
Protect Configuration : **Yes**

If **Protect Configuration** is set, the local disk configuration is preserved if the service profile is disassociated with the server. In that case, a configuration error will be raised when a new service profile is associated with that server if the local disk configuration in that profile is different.

**FlexFlash**

FlexFlash State : **Disable**

If **FlexFlash State** is disabled, SD cards will become unavailable immediately.  
Please ensure SD cards are not in use before disabling the FlexFlash State.

FlexFlash RAID Reporting State : **Disable**

4. In the networking window, select Expert and click Add to create vNICs. Add one or more vNICs that the server should use to connect to the LAN.
5. Now there are two vNICs in the create vNIC menu; you provided a name for the first vNIC as “eth0” and the second vNIC as “eth1.”
6. Select vNIC-Template-A for the vNIC Template and select VMware for the Adapter Policy as shown below.

## Create vNIC



Name :

Use vNIC Template :

Redundancy Pair :

Peer Name :

vNIC Template :

[Create vNIC Template](#)

### Adapter Performance Profile

Adapter Policy :

[Create Ethernet Adapter Policy](#)

7. Select vNIC-Template-B for the vNIC Template, created with the name eth1. Select VMware for the vNIC "eth1" for the Adapter Policy.



eth0 and eth1 vNICs are created so that the servers can connect to the LAN.

8. When the vNICs are created, you need to create vHBAs. Click Next.
9. In the SAN Connectivity menu, select Expert to configure as SAN connectivity. Select WWNN (World Wide Node Name) pool, which you previously created. Click Add to add vHBAs.

### Create Service Profile Template

Optionally specify disk policies and SAN configuration information.

How would you like to configure SAN connectivity?

Simple  Expert  No vHBAs  Use Connectivity Policy

A server is identified on a SAN by its World Wide Node Name (WWNN). Specify how the system should assign a WWNN to the server associated with this profile.

World Wide Node Name

WWNN Assignment:

The WWNN will be assigned from the selected pool.  
The available/total WWNNs are displayed after the pool name.

Name	WWPN
	No data available

The following four HBAs were created:

- vHBA0 using vHBA Template vHBA-A
- vHBA1 using vHBA Template vHBA-B
- vHBA2 using vHBA Template vHBA-A
- vHBA3 using vHBA Template vHBA-B

Figure 40. vHBA0

## Create vHBA



Name : vHBA0

Use vHBA Template :

Redundancy Pair :

vHBA Template : vHBA-A ▼

Peer Name :

[Create vHBA Template](#)

### Adapter Performance Profile

Adapter Policy : VMWare ▼

[Create Fibre Channel Adapter Policy](#)

Figure 41. vHBA1

## Modify vHBA



Name : vHBA1

Use vHBA Template :

[Create vHBA Template](#)

vHBA Template : vHBA-B ▼

### Adapter Performance Profile

Adapter Policy : VMWare ▼

[Create Fibre Channel Adapter Policy](#)

Figure 42. All vHBAs

**Create Service Profile Template** [?] [X]

Optionally specify disk policies and SAN configuration information.

---

WWNN Assignment:

The WWNN will be assigned from the selected pool.  
The available/total WWNNs are displayed after the pool name.

---

Name	WWPN
▶ vHBA vHBA3	Derived
▶ vHBA vHBA2	Derived
▶ vHBA vHBA1	Derived
▶ vHBA vHBA0	Derived

[Delete] [Add] [Modify]

[< Prev] [Next >] [Finish] [Cancel]

10. Skip zoning. For this FlashStack Configuration, the Cisco MDS 9132T 32-Gb is used for zoning.

11. Select the default option Let System Perform Placement in the Placement Selection menu.

**Create Service Profile Template** [?] [X]

Specify how vNICs and vHBAs are placed on physical network adapters

vNIC/vHBA Placement specifies how vNICs and vHBAs are placed on physical network adapters (mezzanine) in a server hardware configuration independent way.

Select Placement:  [Create Placement Policy]

System will perform automatic placement of vNICs and vHBAs based on PCI order.

Name	Address	Order
vHBA vHBA0	Derived	1
vHBA vHBA1	Derived	2
vHBA vHBA2	Derived	3
vHBA vHBA3	Derived	4
vNIC eth0	Derived	5
vNIC eth1	Derived	6

↑ Move Up ↓ Move Down [Delete] [Reorder] [Modify]

12. For the Server Boot Policy, select SAN-A, which you previously created.

**1** Identify Service Profile Template

**2** Storage Provisioning

**3** Networking

**4** SAN Connectivity

**5** Zoning

**6** vNIC/vHBA Placement

**7** vMedia Policy

**8** Server Boot Order

**9** Maintenance Policy

**10** Server Assignment

**11** Operational Policies

### Create Service Profile Template

Optionally specify the boot policy for this service profile template.

Select a boot policy.

Boot Policy: **SAN-A** [Create Boot Policy](#)

Name : **SAN-A**  
 Description :  
 Reboot on Boot Order Change : **No**  
 Enforce vNIC/vHBA/iSCSI Name : **Yes**  
 Boot Mode : **Legacy**

**WARNINGS:**  
 The type (primary/secondary) does not indicate a boot order presence.  
 The effective order of boot devices within the same device class (LAN/Storage/iSCSI) is determined by PCIe bus scan order.  
 If **Enforce vNIC/vHBA/iSCSI Name** is selected and the vNIC/vHBA/iSCSI does not exist, a config error will be reported.  
 If it is not selected, the vNICs/vHBAs are selected if they exist, otherwise the vNIC/vHBA with the lowest PCIe bus scan order is used.

**Boot Order**

Name	Order	vNIC/vH...	Type	WWN	LUN Name	Slot Num...	Boot Name	Boot Path	Description
▼ San	2								
▶ SAN Primary		vHBA0	Primary						
▶ SAN Second...		vHBA1	Secondary						
Remote CD/DVD	1								

[Create iSCSI vNIC](#) [Set iSCSI Boot Parameters](#) [Set UEFI Boot Parameters](#)

[< Prev](#) [Next >](#) [Finish](#) [Cancel](#)

The default setting was retained for the remaining maintenance and assignment policies in the configuration. However, they may vary from site-to-site depending on workloads, best practices, and policies. For example, we created a maintenance policy, BIOS policy, Power Policy, as detailed below.

13. Select UserAck maintenance policy, which requires user acknowledgement prior rebooting server when making changes to policy or pool configuration tied to a service profile.

### Create Service Profile Template

Specify how disruptive changes such as reboots, network interruptions, and firmware upgrades should be applied to the server associated with this service profile.

⊖ Maintenance Policy

Select a maintenance policy to include with this service profile or create a new maintenance policy that will be accessible to all service profiles.

Maintenance Policy: **UserAck** [Create Maintenance Policy](#)

Name : **UserAck**  
 Description :  
 Soft Shutdown Timer : **150 Secs**  
 Storage Config. Deployment Policy : **User Ack**  
 Reboot Policy : **User Ack**



14. Select Server Pool policy to automatically assign service profile to a server that meets the requirement for server qualification based on the pool configuration.
15. On the same page; you can configure “Host firmware Package Policy” which helps to keep the firmware in sync when associated to server.

**Create Service Profile Template** ? X

Optionally specify a server pool for this service profile template.

You can select a server pool you want to associate with this service profile template.

Pool Assignment:  [Create Server Pool](#)

Select the power state to be applied when this profile is associated with the server.

Up  Down

The service profile template is not automatically associated with a server. Either select a server from the list or associate the service profile manually later.

**Firmware Management (BIOS, Disk Controller, Adapter)**

If you select a host firmware policy for this service profile, the profile will update the firmware on the server that it is associated with. Otherwise the system uses the firmware already installed on the associated server.

Host Firmware Package:  [Create Host Firmware Package](#)

16. On the Operational Policy page, we configured BIOS policy for B200 M5 blade server, Power Control Policy with “NoPowerCap” for maximum performance and Graphics Card Policy for B200 M5 server configured with NVidia P6 GPU card.

**Create Service Profile Template** ? X

Optionally specify information that affects how the system operates.

**BIOS Configuration**  
 If you want to override the default BIOS settings, select a BIOS policy that will be associated with this service profile  
 BIOS Policy : B200-M5-BIOS ▾

**External IPMI Management Configuration**

**Management IP Address**

**Monitoring Configuration (Thresholds)**

**Power Control Policy Configuration**  
 Power control policy determines power allocation for a server in a given power group.  
 Power Control Policy : NoPowerCap ▾ [Create Power Control Policy](#)

**Scrub Policy**

**KVM Management Policy**

**Graphics Card Policy**

< Prev
Next >
Finish
Cancel

17. Click Next and then click Finish to create service profile template as “VDI-CVD01.”

### Clone Service Profile Template

To clone the Service Profile template, follow these steps:

1. In the Cisco UCS Manager, go to Servers > Service Profile Templates > root > Sub Organization > FlashStack-CVD > Service Template VDI-CVD01 and right-click Create a Clone as shown below.

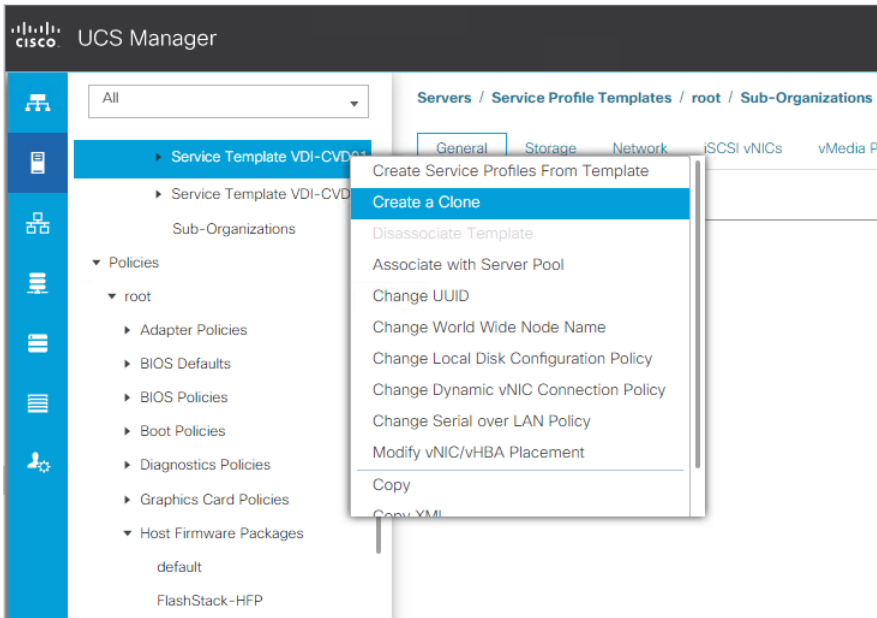

2. Enter name to create Clone from existing Service Profile template. Click OK.

Create Clone From VDI-CVD01 ✕

Clone Name :

Org :



This VDI-CVD02 service profile template will be used to create the remaining sixteen service profiles for VDI workload and Infrastructure server02.

3. To change boot order from SAN-A to SAN-B for VDI-CVD02, click Cloned Service Profile template > Select Boot Order tab. Click Modify Boot Policy.

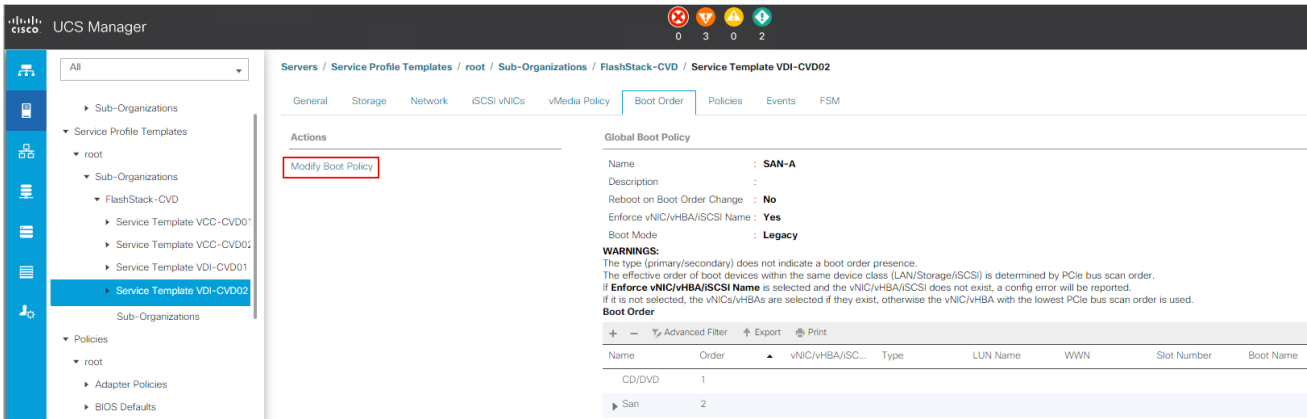

4. From the drop-down list, for the Boot Policy, select SAN-B and click OK.

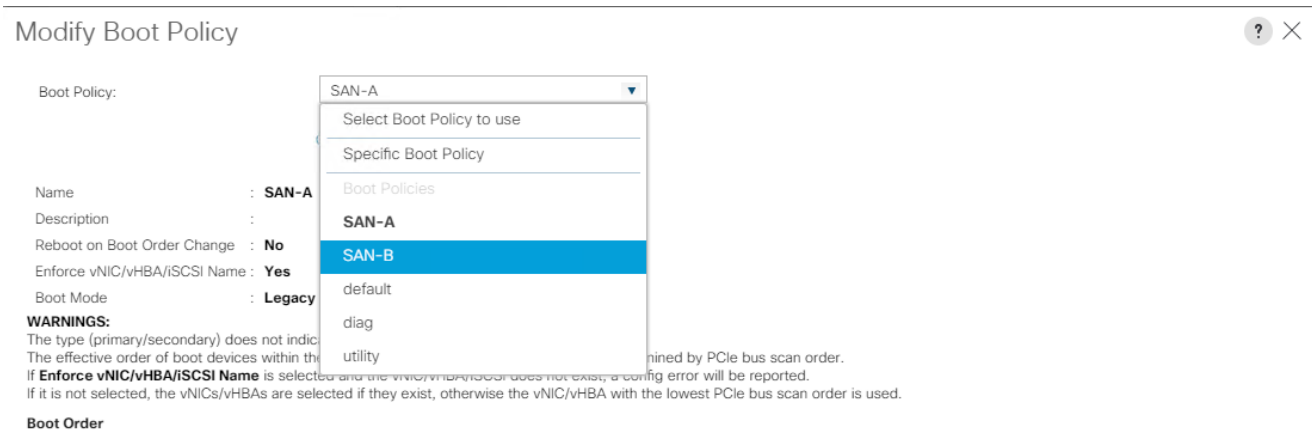

You have now created the Service Profile template “VDI-CVD01” and “VDI-CVD02” with each having four vHBAs and two vNICs.

## Create Service Profiles from Template and Associate to Servers

### Create Service Profiles from Template

You will create 16 service profiles from the VDI-CVD01 template and 16 service profiles from the VDI-CVD02 template as explained in the following sections.

For the first 15 workload nodes and infrastructure node 01, you will create 16 service profiles from the template VDI-CVD01. The remaining 15 workload nodes and infrastructure node 02, will require creating another 16 service profiles from the template VDI-CVD02.”

To create first four Service Profiles from Template, follow these steps:

1. Go to the Servers tab > Service Profiles > root > Sub-Organization > FlashStack-CVD and right-click Create Service Profiles from Template.

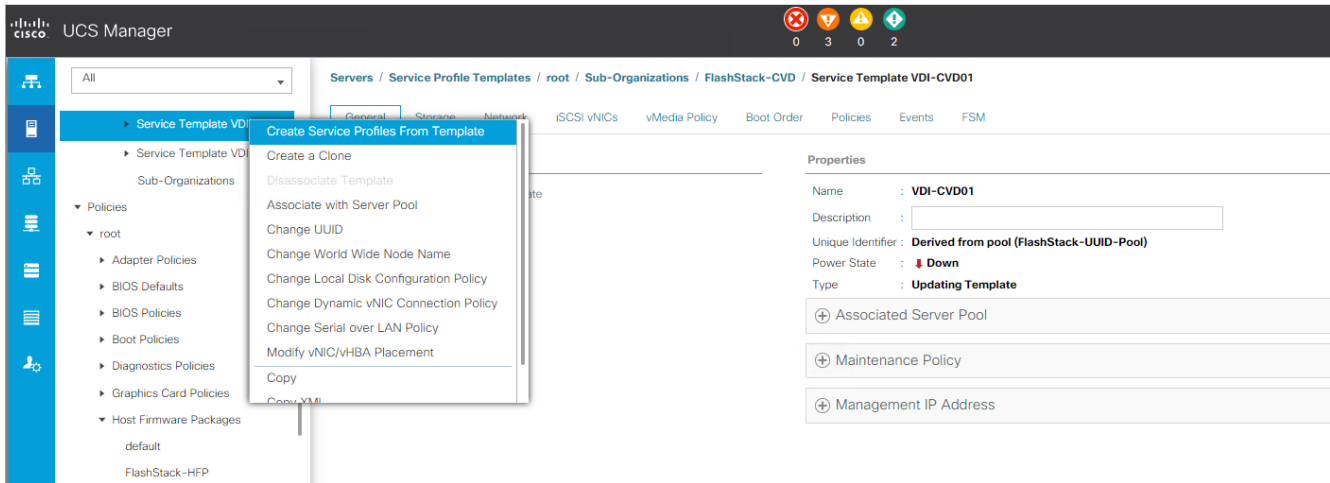

2. Select “VDI-CVD01” for the Service profile template which you created earlier and name the service profile “VDI-HostX.” To create four service profiles, enter 16 for the Number of Instances, as 16 as shown below. This process will create service profiles “VDI-HOST1”, “VDI-HOST2”, .... and “VDI-HOST16.”

## Create Service Profiles From Template ? X

Naming Prefix :

Name Suffix Starting Number :

Number of Instances :

3. Create the remaining four Service Profiles “VDI-HOST17”, “VDI-HOST18”, .... and “VDI-HOST32” from Template “VDI-CVD02.”

When the service profiles are created, the association of Service Profile starts automatically to servers based on the Server Pool Policies.

4. Rename the Service Profiles on Chassis 3/8 as VDI-Infra01 and Service Profile on Chassis 4/8 as VDI-Infra02. Rename rest as necessary to have VDI-Host1to VDI-Host30.
5. Service Profile association can be verified in Cisco UCS Manager > Servers > Service Profiles. Different tabs can provide details on Service profile association based on Server Pools Policy, Service Profile Template to which Service Profile is tied to, and so on.

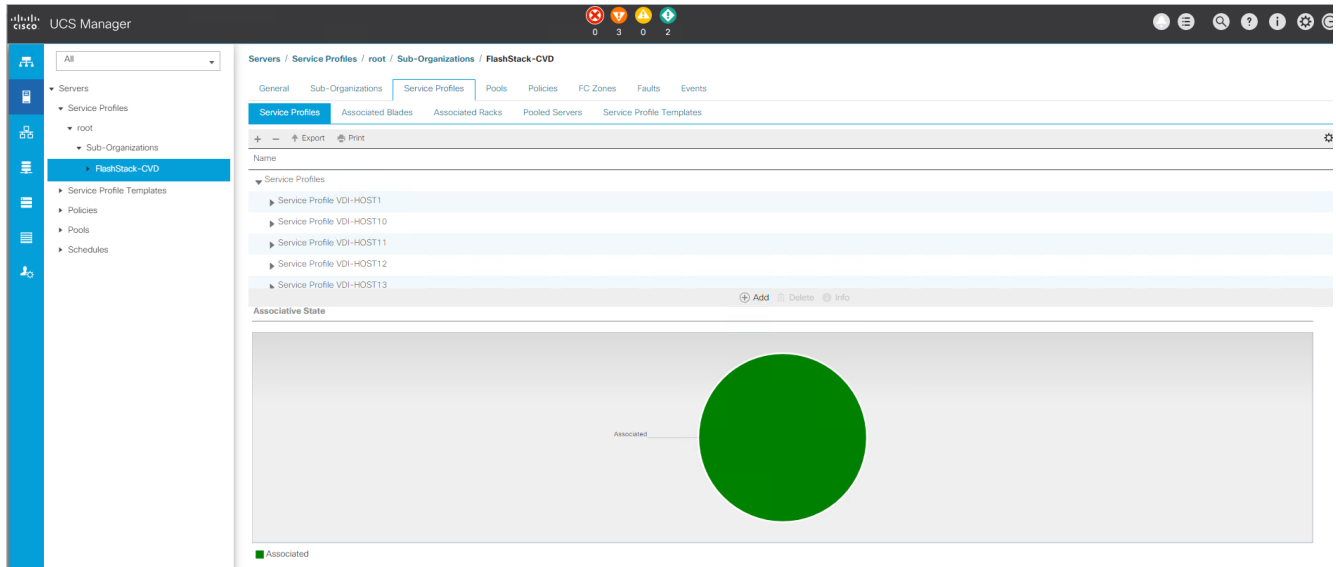

## Configure Cisco Nexus 93180YC-FX Switches

The following section details the steps for the Nexus 93180YC-FX switch configuration.

### Configure Global Settings for Cisco Nexus A and Cisco Nexus B

To set global configuration, follow these steps on both Nexus switches:

1. Log in as admin user into the Nexus Switch A and run the following commands to set global configurations and jumbo frames in QoS:

```
conf terminal
policy-map type network-qos jumbo
class type network-qos class-default
mtu 9216
exit
class type network-qos class-fcoe
pause no-drop
mtu 2158
exit
exit
system qos
service-policy type network-qos jumbo
exit
copy running-config startup-config
```

2. Log in as admin user into the Nexus Switch B and run the same above commands to set global configurations and jumbo frames in QoS.

## Configure VLANs for Cisco Nexus A and Cisco Nexus B Switches

To create the necessary virtual local area networks (VLANs), follow these steps on both Nexus switches. We created VLAN 70, 71, 72, 73 and 76.

1. Log in as admin user into the Nexus Switch A.

2. Create VLAN 70:

```
config terminal
VLAN 70
name InBand-Mgmt
no shutdown
exit
copy running-config startup-config
```

3. Log in as admin user into the Nexus Switch B and create VLANs.

## Virtual Port Channel (vPC) Summary for Data and Storage Network

In the Cisco Nexus 93180YC-FX switch topology, a single vPC feature is enabled to provide HA, faster convergence in the event of a failure, and greater throughput. Cisco Nexus 93180YC-FX vPC configurations with the vPC domains and corresponding vPC names and IDs for Oracle Database Servers is listed in [Table 6](#).

**Table 6. vPC Summary**

vPC Domain	vPC Name	vPC ID
70	Peer-Link	1
70	vPC Port-Channel to FI-A	11
70	vPC Port-Channel to FI-B	12

As listed in [Table 6](#), a single vPC domain with Domain ID 70 is created across two Cisco Nexus 93180YC-FX member switches to define vPC members to carry specific VLAN network traffic. In this topology, we defined a total number of 3 vPCs:

- vPC ID 1 is defined as Peer link communication between two Nexus switches in Fabric A and B.
- vPC IDs 11 and 12 are defined for traffic from Cisco UCS fabric interconnects.

## Cisco Nexus 93180YC-FX Switch Cabling Details

The following tables list the cabling information.

**Table 7. Cisco Nexus 93180YC-FX-A Cabling Information**

Local Device	Local Port	Connection	Remote Device	Remote Port
Cisco Nexus 93180YC-FX	Eth1/51	40Gbe	Cisco UCS fabric interconnect B	Eth1/49

Local Device	Local Port	Connection	Remote Device	Remote Port
Switch A	Eth1/52	40Gbe	Cisco UCS fabric interconnect A	Eth1/49
	Eth1/53	40Gbe	Cisco Nexus 93180YC-FX B	Eth1/53
	Eth1/54	40Gbe	Cisco Nexus 93180YC-FX B	Eth1/54
	MGMT0	1Gbe	Gbe management switch	Any

**Table 8. Cisco Nexus 93180YC-FX-B Cabling Information**

Local Device	Local Port	Connection	Remote Device	Remote Port
Cisco Nexus 93180YC-FX Switch B	Eth1/51	40Gbe	Cisco UCS fabric interconnect B	Eth1/50
	Eth1/52	40Gbe	Cisco UCS fabric interconnect A	Eth1/50
	Eth1/53	40Gbe	Cisco Nexus 93180YC-FX A	Eth1/53
	Eth1/54	40Gbe	Cisco Nexus 93180YC-FX A	Eth1/54
	MGMT0	Gbe	Gbe management switch	Any

### Cisco UCS Fabric Interconnect 6454 Cabling

The following tables list the FI 6454 cabling information.

**Table 9. Cisco UCS Fabric Interconnect (FI) A Cabling Information**

Local Device	Local Port	Connection	Remote Device	Remote Port
Cisco UCS FI-6454-A	FC 1/1	32G FC	Cisco MDS 9132T 32-Gb-A	FC 1/13
	FC 1/2	32G FC	Cisco MDS 9132T 32-Gb-A	FC 1/14
	Eth1/17-24	40Gbe	UCS 5108 Chassis IOM-A Chassis 1-4	IO Module Port1-2
	Eth1/49	40Gbe	Cisco Nexus 93180YC-FX Switch A	Eth1/52
	Eth1/50	40Gbe	Cisco Nexus 93180YC-FX Switch B	Eth1/52
	Mgmt 0	1Gbe	Management Switch	Any
	L1	1Gbe	Cisco UCS FI - A	L1



Local Device	Local Port	Connection	Remote Device	Remote Port
	L2	1Gbe	Cisco UCS FI - B	L2

**Table 10. Cisco UCS Fabric Interconnect (FI) B Cabling Information**

Local Device	Local Port	Connection	Remote Device	Remote Port
Cisco UCS FI-6454-B	FC 1/1	32Gb FC	Cisco MDS 9132T 32-Gb-B	FC 1/13
	FC 1/2	32Gb FC	Cisco MDS 9132T 32-Gb-B	FC 1/14
	Eth1/17-24	40Gbe	UCS 5108 Chassis IOM-B Chassis 1-4	IO Module Port1-2
	Eth1/49	40Gbe	Cisco Nexus 93180YC-FX Switch A	Eth1/51
	Eth1/50	40Gbe	Cisco Nexus 93180YC-FX Switch B	Eth1/51
	Mgmt 0	1Gbe	Management Switch	Any
	L1	1Gbe	Cisco UCS FI - A	L1
	L2	1Gbe	Cisco UCS FI - B	L2

### Create vPC Peer-Link Between the Two Nexus Switches

To create the vPC Peer-Link, follow these steps:

1. Log in as “admin” user into the Nexus Switch A.



For vPC 1 as Peer-link, we used interfaces 53-54 for Peer-Link. You may choose the appropriate number of ports for your needs.

To create the necessary port channels between devices, follow these steps on both Nexus switches:

```

config terminal
feature vpc
feature lacp
vpc domain 1
peer-keepalive destination 10.29.164.234 source 10.29.164.233
exit
interface port-channel 70
description VPC peer-link

```

```
switchport mode trunk
switchport trunk allowed VLAN 1,70-76
spanning-tree port type network
vpc peer-link
exit
interface Ethernet1/53
description vPC-PeerLink
switchport mode trunk
switchport trunk allowed VLAN 1,70-76
channel-group 70 mode active
no shutdown
exit
interface Ethernet1/54
description vPC-PeerLink
switchport mode trunk
switchport trunk allowed VLAN 1,70-76
channel-group 70 mode active
no shutdown
exit
copy running-config startup-config
```

2. Log in as admin user into the Nexus Switch B and repeat the above steps to configure second Nexus switch.



**Make sure to change the peer-keepalive destination and source IP address appropriately for Nexus Switch B.**

---

### **Create vPC Configuration Between Nexus 93180YC-FX and Fabric Interconnects**

Create and configure vPC 11 and 12 for data network between the Nexus switches and fabric interconnects.

To create the necessary port channels between devices, follow these steps on both Nexus switches:

1. Log in as admin user into Nexus Switch A and enter the following:

```
config terminal

interface port-channel11
description FI-A-Uplink
switchport mode trunk
switchport trunk allowed VLAN 1,70-76
spanning-tree port type edge trunk
```

```
vpc 11
no shutdown
exit
interface port-channel12
description FI-B-Uplink
switchport mode trunk
switchport trunk allowed VLAN 1,70-76
spanning-tree port type edge trunk
vpc 12
no shutdown
exit
interface Ethernet1/51
description FI-A-Uplink
switch mode trunk
switchport trunk allowed vlan 1,70-76
spanning-tree port type edge trunk
mtu 9216
channel-group 11 mode active
no shutdown
exit
interface Ethernet1/52
description FI-B-Uplink
switch mode trunk
switchport trunk allowed vlan 1,70-76
spanning-tree port type edge trunk
mtu 9216
channel-group 12 mode active
no shutdown
exit
copy running-config startup-config
```

2. Log in as admin user into the Nexus Switch B and complete the following for the second switch configuration:

```
config Terminal
interface port-channel11
description FI-A-Uplink
switchport mode trunk
```

```
switchport trunk allowed VLAN 1,70-76
spanning-tree port type edge trunk
vpc 11
no shutdown
exit
interface port-channel12
description FI-B-Uplink
switchport mode trunk
switchport trunk allowed VLAN 1,70-76
spanning-tree port type edge trunk
vpc 12
no shutdown
exit
interface Ethernet1/51
description FI-A-Uplink
switch mode trunk
switchport trunk allowed vlan 1,70-76
spanning-tree port type edge trunk
mtu 9216
channel-group 11 mode active
no shutdown
exit
interface Ethernet1/52
description FI-B-Uplink
switch mode trunk
switchport trunk allowed vlan 1,70-76
spanning-tree port type edge trunk
mtu 9216
channel-group 12 mode active
no shutdown
exit
copy running-config startup-config
```

**Verify All vPC Status is Up on Both Cisco Nexus Switches**

[Figure 43](#) shows the verification of the vPC status on both Cisco Nexus Switches.

**Figure 43. vPC Description for Cisco Nexus Switch A and B**

```

AAD17-NX9K-A# sh vpc brief
Legend:          (*) - local vPC is down, forwarding via vPC peer-link

vPC domain id      : 70
Peer status        : peer adjacency formed ok
vPC keep-alive status : peer is alive
Configuration consistency status : success
Per-vlan consistency status : success
Type-2 consistency status : success
vPC role           : primary
Number of vPCs configured : 4
Peer Gateway       : Disabled
Dual-active excluded VLANs : -
Graceful Consistency Check : Enabled
Auto-recovery status : Disabled
Delay-restore status : Timer is off.(timeout = 30s)
Delay-restore SVI status : Timer is off.(timeout = 10s)
Operational Layer3 Peer-router : Disabled

vPC Peer-Link status
-----
id  Port  Status Active vlans
-----
1   Po70  up    1,70-76

vPC status
-----
Id  Port  Status Consistency Reason      Active vlans
-----
11  Po11  up    success success                1,70-76
12  Po12  up    success success                1,70-76
13  Po13  up    success success                1,70-76
14  Po14  up    success success                1,70-76
    
```

```

AAD17-NX9K-B# sh vpc brief
Legend:          (*) - local vPC is down, forwarding via vPC peer-link

vPC domain id      : 70
Peer status        : peer adjacency formed ok
vPC keep-alive status : peer is alive
Configuration consistency status : success
Per-vlan consistency status : success
Type-2 consistency status : success
vPC role           : secondary
Number of vPCs configured : 4
Peer Gateway       : Disabled
Dual-active excluded VLANs : -
Graceful Consistency Check : Enabled
Auto-recovery status : Disabled
Delay-restore status : Timer is off.(timeout = 30s)
Delay-restore SVI status : Timer is off.(timeout = 10s)
Operational Layer3 Peer-router : Disabled

vPC Peer-Link status
-----
id  Port  Status Active vlans
-----
1   Po70  up    1,70-76

vPC status
-----
Id  Port  Status Consistency Reason      Active vlans
-----
11  Po11  up    success success                1,70-76
12  Po12  up    success success                1,70-76
13  Po13  up    success success                1,70-76
14  Po14  up    success success                1,70-76
    
```

## Cisco MDS 9132T 32-Gb FC Switch Configuration

Figure 24 illustrates the cable connectivity between the Cisco MDS 9132T 32-Gb switch and the Cisco 6454 Fabric Interconnects and Pure Storage FlashArray//X70 R3 storage.



We used two 32Gb FC connections from each fabric interconnect to each MDS switch and two 32Gb FC connections from each Pure Storage FlashArray//X70 R3 array controller to each MDS switch.

**Table 11. Cisco MDS 9132T-A Cabling Information**

Local Device	Local Port	Connection	Remote Device	Remote Port
Cisco MDS 9132T-A	FC1/9	32Gb FC	Pure Storage FlashArray//X70 R3 Controller 0	CT0.FC0
	FC1/10	32Gb FC	Pure Storage FlashArray//X70 R3 Controller 1	CT1.FC0
	FC1/13	32Gb FC	Cisco 6454 Fabric Interconnect-A	FC1/1
	FC1/14	32Gb FC	Cisco 6454 Fabric Interconnect-A	FC1/2

**Table 12. Cisco MDS 9132T-B Cabling Information**

Local Device	Local Port	Connection	Remote Device	Remote Port
Cisco MDS 9132T-B	FC1/9	32Gb FC	Pure Storage FlashArray//X70 R3 Controller 0	CT0.FC2
	FC1/10	32Gb FC	Pure Storage FlashArray//X70 R3 Controller 1	CT1.FC2
	FC1/13	32Gb FC	Cisco 6454 Fabric Interconnect-B	FC1/1

Local Device	Local Port	Connection	Remote Device	Remote Port
	FC1/14	32Gb FC	Cisco 6454 Fabric Interconnect-B	FC1/2

### Pure Storage FlashArray//X70 R3 to MDS SAN Fabric Connectivity

#### Pure Storage FlashArray//X70 R3 to MDS A and B Switches using VSAN 100 for Fabric A and VSAN 101 Configured for Fabric B

In this solution, two ports (ports FC1/9 and FC1/10) of MDS Switch A and two ports (ports FC1/9 and FC1/10) of MDS Switch B are connected to Pure Storage System as listed in [Table 13](#). All ports connected to the Pure Storage Array carry 32 Gb/s FC Traffic.

**Table 13. MDS 9132T 32-Gb switch Port Connection to Pure Storage System**

Local Device	Local Port	Connection	Remote Device	Remote Port
MDS Switch A	FC1/9	32Gb FC	Pure Storage FlashArray//X70 R3 Controller 0	CT0.FC0
	FC1/10	32Gb FC	Pure Storage FlashArray//X70 R3 Controller 1	CT1.FC0
MDS Switch B	FC1/9	32Gb FC	Pure Storage FlashArray//X70 R3 Controller 0	CT0.FC2
	FC1/10	32Gb FC	Pure Storage FlashArray//X70 R3 Controller 1	CT1.FC2

### Configure Feature for MDS Switch A and MDS Switch B

To set feature on MDS Switches, follow these steps on both MDS switches:

1. Log in as admin user into MDS Switch A:

```
config terminal
feature npiv
feature telnet
switchname FlashStack-MDS-A
copy running-config startup-config
```

2. Log in as admin user into MDS Switch B. Repeat the steps above on MDS Switch B.

### Configure VSANs for MDS Switch A and MDS Switch B

To create VSANs, follow these steps:

3. Log in as admin user into MDS Switch A. Create VSAN 100 for Storage Traffic:

```
config terminal
VSAN database
```

```

vsan 100
vsan 100 interface fc 1/9-16
exit
interface fc 1/9-16
switchport trunk allowed vsan 100
switchport trunk mode off
port-license acquire
no shutdown
exit
copy running-config startup-config

```

#### 4. Log in as admin user into MDS Switch B. Create VSAN 101 for Storage Traffic:

```

config terminal
VSAN database
vsan 101
vsan 101 interface fc 1/9-16
exit
interface fc 1/9-16
switchport trunk allowed vsan 101
switchport trunk mode off
port-license acquire
no shutdown
exit
copy running-config startup-config

```

#### Add FC Uplink Ports to Corresponding VSAN on Fabric Interconnect

To add the FC Ports to the corresponding VSAN, follow these steps:

1. In Cisco UCS Manager, in the Equipment tab, select Fabric Interconnects > Fabric Interconnect A > Physical Ports > FC Ports.

The screenshot shows the Cisco UCS Manager interface for Fabric Interconnect A (subordinate). The 'Physical Ports' tab is selected, and the 'FC Ports' sub-tab is active. A table lists the configured FC ports with their respective details.

Name	Slot	Port ID	WWPN	If Role	If Type	Overall Status	Admin State
FC Port 1	1	1	20:01:00:3A:9C:0E:33:20	Network	Physical	Up	Enabled
FC Port 2	1	2	20:02:00:3A:9C:0E:33:20	Network	Physical	Up	Enabled

2. From the drop-down list double-click FC Port 1 and select VSAN 100.

Figure 44. VSAN Assignment on FC Uplink Ports to MDS Switch

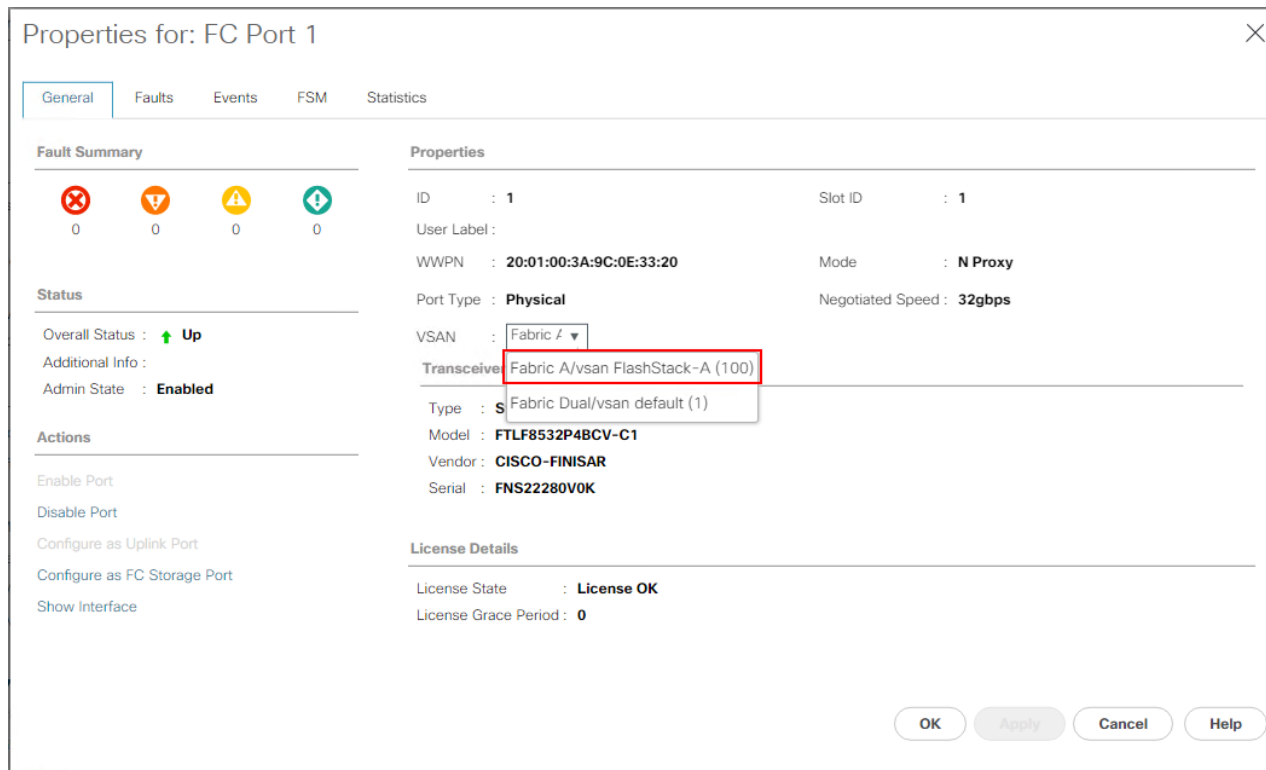

3. Repeat these steps to Add FC Port 1-4 to VSAN 100 on Fabric A and FC Port 1-4 to VSAN 101 on Fabric B.

### Create and Configure Fiber Channel Zoning

This procedure sets up the Fibre Channel connections between the Cisco MDS 9132T 32-Gb switches, the Cisco UCS Fabric Interconnects, and the Pure Storage FlashArray systems.



Before you configure the zoning details, decide how many paths are needed for each LUN and extract the WWPN numbers for each of the HBAs from each server. We used 4 HBAs for each Server. Two HBAs (HBA0 and HBA2) are connected to MDS Switch-A and other two HBAs (HBA1 and HBA3) are connected to MDS Switch-B.

To create and configure the fiber channel zoning, follow these steps:

1. Log into the Cisco UCS Manager and go to Servers > Service Profiles > Sub-Organizations > FlashStack-CVD > VDI-HostX, then click the Storage tab and HBA's tab to get the WWPN of HBA's as shown in the screenshot below. Repeat for all the configured host profiles.



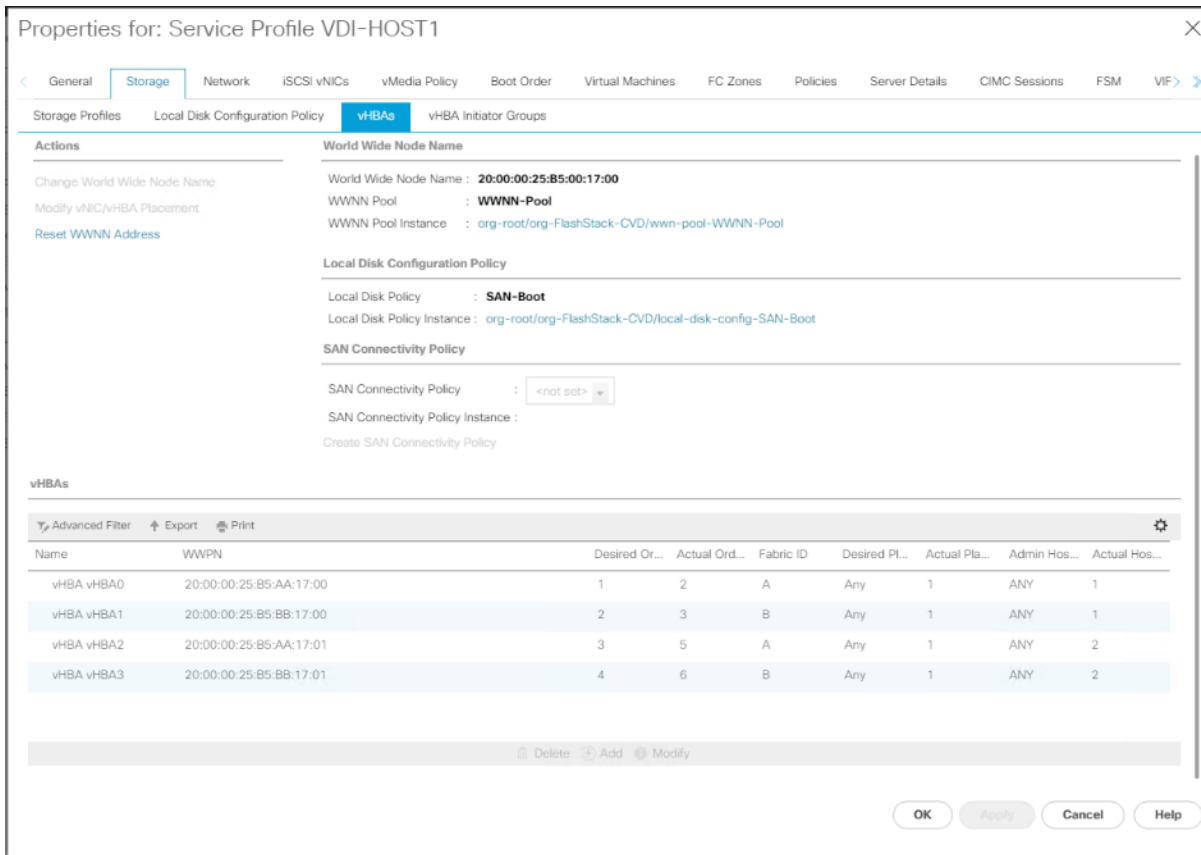

2. Connect to the Pure Storage System Health and go to the Connections tab and extract the WWPN of FC Ports connected to the Cisco MDS Switches from Array Ports section. We have connected 4 FC ports from Pure Storage System to Cisco MDS Switches. FC ports CT0.FC0, CT1.FC0 are connected to MDS Switch-A and similarly FC ports CT1.FC2, CT0.FC2 are connected to MDS Switch-B.

FC Port	Name	Speed	Fallover	FC Port	Name	Speed	Fallover
CT0.FC0	52:4A:93:71:56:84:09:00	32 Gb/s		CT1.FC0	52:4A:93:71:56:84:09:10	32 Gb/s	
CT0.FC1	52:4A:93:71:56:84:09:01	0		CT1.FC1	52:4A:93:71:56:84:09:11	0	
CT0.FC2	52:4A:93:71:56:84:09:02	32 Gb/s		CT1.FC2	52:4A:93:71:56:84:09:12	32 Gb/s	
CT0.FC3	52:4A:93:71:56:84:09:03	0		CT1.FC3	52:4A:93:71:56:84:09:13	0	
CT0.FC8	52:4A:93:71:56:84:09:08	0		CT1.FC8	52:4A:93:71:56:84:09:18	0	
CT0.FC9	52:4A:93:71:56:84:09:09	0		CT1.FC9	52:4A:93:71:56:84:09:19	0	

## Create Device Aliases for Fiber Channel Zoning

### Cisco MDS Switch A

To configure device aliases and zones for the SAN boot paths as well as the datapaths of MDS switch A, follow these steps:

1. Log in as admin user and run the following commands:

```
configure terminal
device-alias database
```

```
device-alias name VDI-Host01-HBA0 pwwn 20:00:00:25:B5:AA:17:00
device-alias name VDI-Host01-HBA2 pwwn 20:00:00:25:B5:AA:17:01
device-alias name X70R3-CT0-FC0 pwwn 52:4A:93:71:56:84:09:00
device-alias name X70R3-CT1-FC0 pwwn 52:4A:93:71:56:84:09:10
exit
device-alias commit
```

### **Cisco MDS Switch B**

To configure device aliases and zones for the SAN boot paths as well as datapaths of MDS switch B, follow this step:

1. Log in as admin user and run the following commands:

```
configure terminal
device-alias database
device-alias name VDI-Host01-HBA1 pwwn 20:00:00:25:B5:AA:17:00
device-alias name VDI-Host01-HBA3 pwwn 20:00:00:25:B5:AA:17:01
device-alias name X70R3-CT0-FC2 pwwn 52:4A:93:71:56:84:09:02
device-alias name X70R3-CT1-FC2 pwwn 52:4A:93:71:56:84:09:12
exit
device-alias commit
```

### **Create Fiber Channel Zoning**

#### **Cisco MDS Switch A**

To configure zones for the MDS switch A, follow these steps to create a zone for each server service profile:

1. Log in as admin user and create the zone as shown below:

```
configure terminal
zone name FlaskStack-VCC-CVD-WLHost01 vsan 100
    member pwwn 52:4A:93:71:56:84:09:00
    member pwwn 52:4A:93:71:56:84:09:10
    member pwwn 20:00:00:25:b5:aa:17:00
    member pwwn 20:00:00:25:b5:aa:17:01
```

2. After the zone for the Cisco UCS service profile has been created, create the zone set and add the created zones as members:

```
configure terminal
zoneset name FlashStack-VDI-CVD vsan 100
member FlaskStack-VDI-CVD-Host01
```

### 3. Activate the zone set by running following commands:

```
zoneset activate name FlashStack-VDI-CVD vsan 100
exit
copy running-config startup-config
```

#### **Cisco MDS Switch B**

To configure zones for the MDS switch B, follow these steps to create a zone for each server service profile:

#### 1. Log in as admin user and create the zone as shown below:

```
configure terminal
zone name FlaskStack-VCC-CVD-WLHost01 vsan 101
    member pwnn 20:00:00:25:b5:bb:17:00
    member pwnn 20:00:00:25:b5:bb:17:01
    member pwnn 52:4a:93:71:56:84:09:02
    member pwnn 52:4a:93:71:56:84:09:12
```

#### 2. After the zone for the Cisco UCS service profile has been created, create the zone set and add the necessary members:

```
zoneset name FlashStack-VDI-CVD vsan 101
member FlaskStack-VDI-CVD-Host01
```

#### 3. Activate the zone set by running following commands:

```
zoneset activate name FlashStack-VDI-CVD vsan 101
exit
copy running-config startup-config
```

## **Configure Pure Storage FlashArray//X70 R3**

The design goal of the reference architecture is to best represent a real-world environment as closely as possible. The approach included the features of Cisco UCS to rapidly deploy stateless servers and use Pure Storage FlashArray's boot LUNs to provision the ESXi on top of Cisco UCS. Zoning was performed on the Cisco MDS 9132T 32-Gb switches to enable the initiators discover the targets during boot process.

A Service Profile was created within Cisco UCS Manager to deploy the thirty-two servers quickly with a standard configuration. SAN boot volumes for these servers were hosted on the same Pure Storage FlashArray//X70 R3. Once the stateless servers were provisioned, following process was performed to enable rapid deployment of thirty-two Blade Servers.

Each Blade Server has dedicated single LUN to install operating system and all the thirty-two Blade Servers configured to boot from SAN. For this solution, we have installed vSphere ESXi 7.0 GA Cisco Custom ISO on this LUNs to create solution.

Using logical servers that are disassociated from the physical hardware removes many limiting constraints around how servers are provisioned. Cisco UCS Service Profiles contain values for a server's property settings,

---

including virtual network interface cards (vNICs), MAC addresses, boot policies, firmware policies, fabric connectivity, external management, and HA information. The service profiles represent all the attributes of a logical server in Cisco UCS model. By abstracting these settings from the physical server into a Cisco Service Profile, the Service Profile can then be deployed to any physical compute hardware within the Cisco UCS domain. Furthermore, Service Profiles can, at any time, be migrated from one physical server to another. Furthermore, Cisco is the only hardware provider to offer a truly unified management platform, with Cisco UCS Service Profiles and hardware abstraction capabilities extending to both blade and rack servers.

In addition to the service profiles, the use of Pure Storage's FlashArray's with SAN boot policy provides the following benefits:

- Scalability - Rapid deployment of new servers to the environment in a very few steps.
- Manageability - Enables seamless hardware maintenance and upgrades without any restrictions. This is a huge benefit in comparison to another appliance model like Exadata.
- Flexibility - Easy to repurpose physical servers for different applications and services as needed.
- Availability - Hardware failures are not impactful and critical. In rare case of a server failure, it is easier to associate the logical service profile to another healthy physical server to reduce the impact.

## **Configure Host, WWNs, and Volume Connectivity with FlashArray Management Tools**

### **Configure Host**

Before using a boot volume (LUN) by a Cisco UCS Blade Server, a host representing this blade server must be defined on Pure Storage FlashArray. To set up a host, follow these steps:

1. Log into Pure Storage FlashArray Management interface.
2. Click the Storage tab.
3. Click the + sign in the Hosts section and select Create Host.

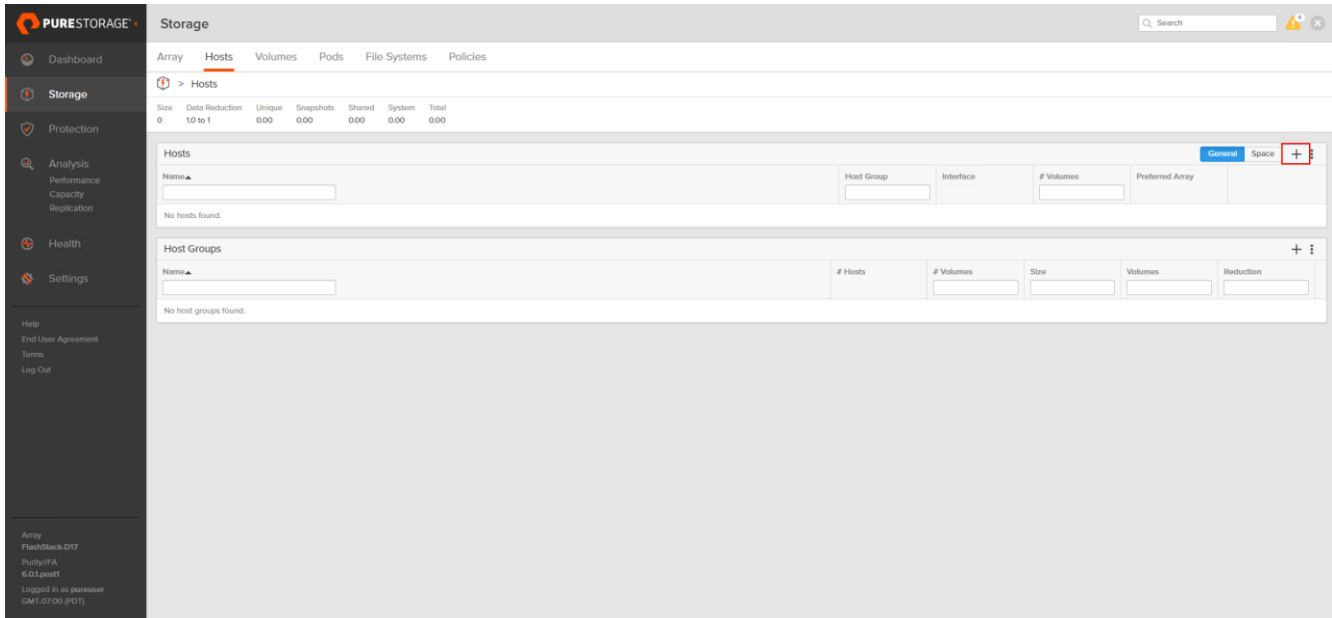

4. Select Create Multiple to create a Host entries under the Hosts category.

### Create Host

**Name**

5. Enter the required information and click Create.

### Create Multiple Hosts

**Name**

**Start Number**

**Count**

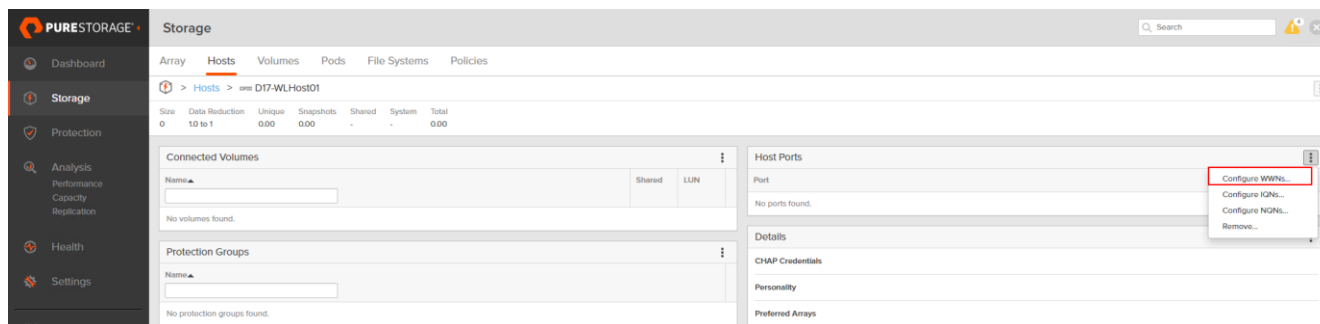

**Number of Digits**

6. Select one of the newly created hosts, in Host Ports section from the drop-down list select “Configure WWNs.”

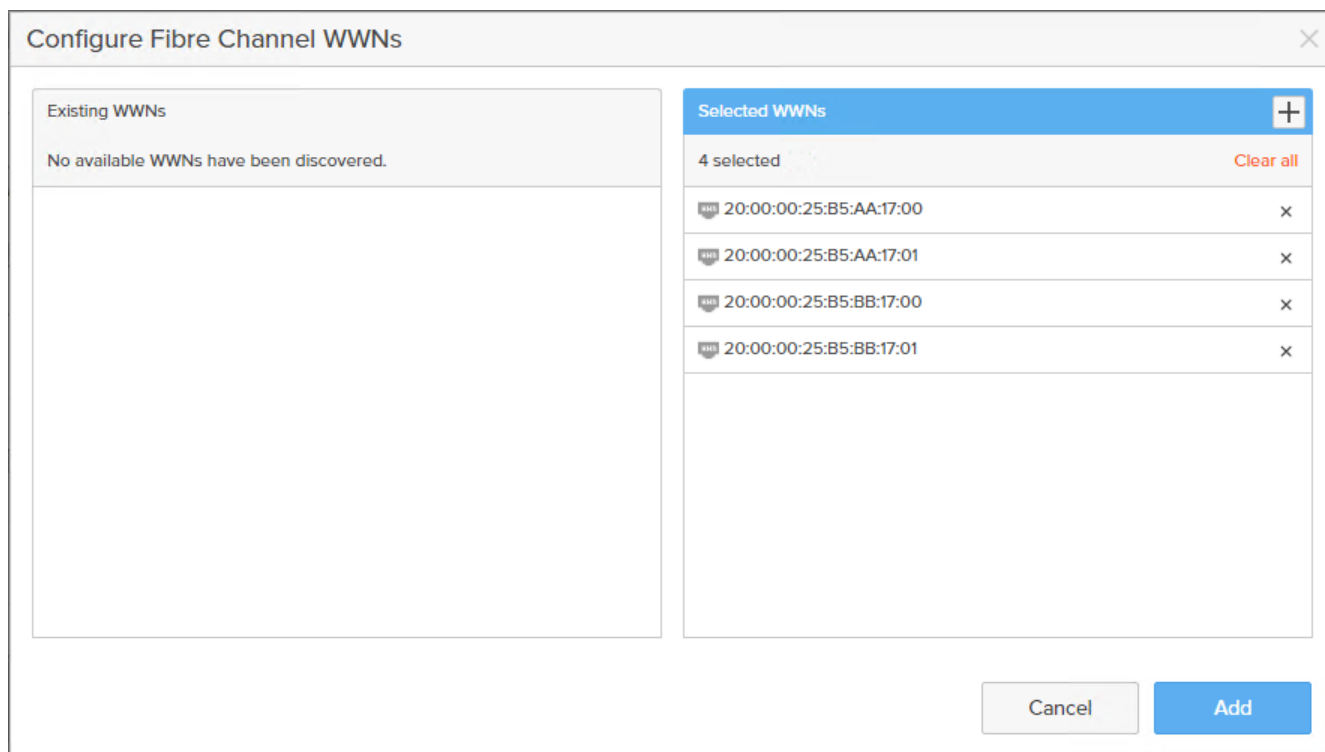

7. Select the list of WWNs that belongs to the host in the next window and click Add.



-  Make sure the zoning has been setup to include the WWNs details of the initiators along with the target, without which the SAN boot will not work.
-  WWNs will appear only if the appropriate FC connections were made and the zones were setup on the underlying FC switch.
-  Alternatively, the WWN can be added manually by clicking the + in the Selected WWNs section and manually inputting the blade’s WWNs.

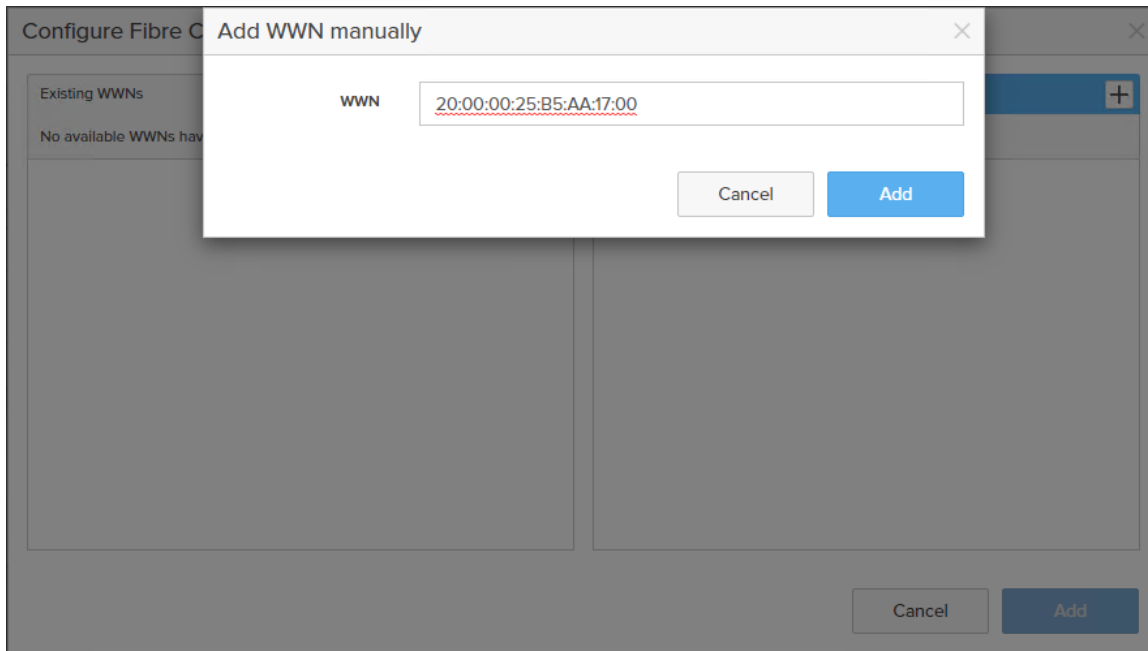

### Configure Volume Connectivity

To configure a volume and volume connectivity, follow these steps:

1. Click the Storage tab.
2. Click the + sign in the Volumes section and click Create Volume.

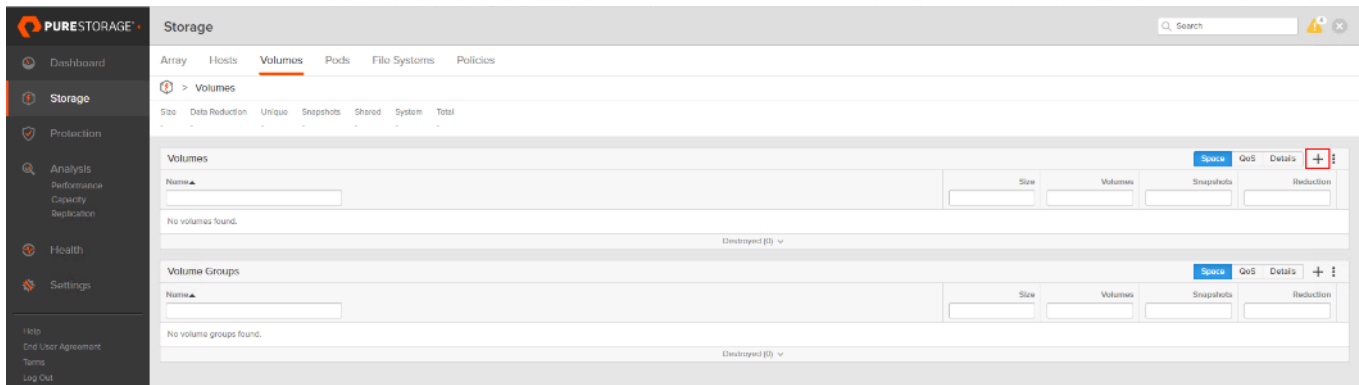

3. Select Create Multiple to open Create Multiple Volumes wizard.

**Create Volume** [X]

Pod or Volume Group: none

Name: Letters, Numbers, -

Provisioned Size: Positive numbers [G]

QoS Configuration (Optional) ▾

[Create Multiple...] [Cancel] [Create]

4. Provide the common name of the volume, size, choose the size type (KB, MB, GB, TB, PB) and click Create to create volumes.

**Create Multiple Volumes** [X]

Pod or Volume Group: none

Name: D17-WLHost

Provisioned Size: 20 [G]

Start Number: 1

Count: 30

Number of Digits: 2

QoS Configuration (Optional) ▾

[Create Single...] [Cancel] [Create]

5. Select one of the hosts and in Connected Volumes section from the drop-down list select Connect.



The screenshot shows the Pure Storage web interface. The main navigation menu on the left includes Dashboard, Storage, Protection, Analysis, Health, and Settings. The main content area is titled 'Storage' and shows the configuration for host 'D17-WLHost01'. There are tabs for Array, Hosts, Volumes, Pods, File Systems, and Policies. A summary table shows metrics like Size, Data Reduction, Unique, Snapshots, Shared, System, and Total. Below this are sections for Connected Volumes, Protection Groups, Host Ports, and Details. The 'Connected Volumes' section has a 'Connect...' button highlighted with a red box. The 'Host Ports' section shows three ports with their respective IP addresses and MAC addresses.

6. In the Connect Volumes to Host wizard select the volume configured for ESXi installation, click Connect.

The screenshot shows the 'Connect Volumes to Host' wizard. It has two main panels: 'Existing Volumes' and 'Selected Volumes'. The 'Existing Volumes' panel shows a list of volumes from D17-WLHost01 to D17-WLHost10. 'D17-WLHost01' is selected with a blue checkmark. The 'Selected Volumes' panel shows 'D17-WLHost01' selected. Below the panels is a 'LUN' field set to '1'. At the bottom right, there are 'Cancel' and 'Connect' buttons. The 'Connect' button is highlighted in blue.



Make sure the SAN Boot Volumes has the LUN ID “1” since this is important while configuring Boot from SAN. You will also configure the LUN ID as “1” when configuring Boot from SAN policy in Cisco UCS Manager.



More LUNs can be connected by adding a connection to existing or new volume(s) to an existing node.

## Configure File Services

FA File services can be activated by Pure Storage Technical Services (Support). Please refer to [FA File Services Support Matrix](#) to verify that your hardware offers support for running File Services.



Currently all FA File services activations require Pure Storage Product Management approval. Customers can work with their local account representatives to obtain approval to activate File Services.

## Create Virtual Interface(s)

The VIF provides high-availability network access across 2 physical Ethernet ports per array controller. Each VIF requires 2 physical ports per controller. Any physical ethernet port can be used with the restriction that any port that is in use by management services, a bond, or subnet configuration cannot be part of a VIF. For the maximum number of VIFs supported, please see the FA File Services Limits KB.



VIFs created by CLI over SSH, configured and enabled via Management Console. Account with administrator privileges is required.

To create File Virtual Interface, follow these steps:

1. Connect to the array via SSH.
2. Run the following syntax to create the VIF on the array:

```
purenetwork create vif --subinterfacelist ct0.ethX,ct1.ethX,ct0.ethY,ct1.ethY <name of interface>
```

## Configure and Enable the Virtual Interface for File Services

To configure and enable the virtual interface, follow these steps:

1. Connect to the array GUI.
2. Navigate to Settings > Network.
3. Locate the File VIF in the interface list and click the edit icon.

1500

filevif

True

ds,file

ct1.eth4, ct0.eth4

ct1.eth5, ct0.eth5



4. In the Edit Interface dialog turn on the Enabled option, provide the IP Address, Netmask, and Gateway used by the interface. Click Save.

**Edit Network Interface**

Name: filevif

Enabled:

Address: 10.10.71.50

Netmask: 255.255.255.0

Gateway: 10.10.71.1

MAC: 7a:ac:28:86:bd:06

MTU: 1500

Service(s): ds,file

Cancel Save

5. Scroll to the bottom of the Network tab and click the edit icon for DNS Settings.

DNS Settings 

6. In the Edit DNS Settings dialog, enter desired values for Domain and DNS server IPs. Click Save.

**Edit DNS**

Domain: vccfslab.local

DNS 1: 10.10.71.11

DNS 2:

DNS 3:

Cancel Save



More than one DNS server can be configured with the caveat that all DNS servers must have a record for Directory Service servers such as LDAP or Microsoft Active Directory.

### Create Active Directory Account for the Array

To create the Active Directory Account, follow these steps:

1. Navigate to Settings > Access > Active Directory Accounts.
2. To open the Create Dialog, click the + icon.

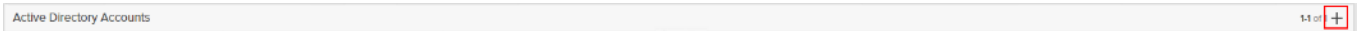

3. Enter the following information:
  - a. Name = Array management name for this AD account
  - b. Domain = AD domain name
  - c. Computer Name = Computer Object name within AD
  - d. User = Domain user that can create computer objects and join to the domain.
  - e. Password = Users password for the above domain user
4. Click Create to finalize AD account creation.

Name	<input type="text" value="purefile"/>
Domain	<input type="text" value="vccfslab.local"/>
Computer Name	<input type="text" value="purefile"/>
Kerberos Server	<input type="text"/>
Directory Server	<input type="text"/>
User	<input type="text" value="administrator@vccfslab.local"/>
Password	<input type="password" value="....."/>

### Create a File System and Shared Directory

To create a file system and shared directory, follow these steps:

1. Navigate to Storage > File Systems.

2. Click the + icon.

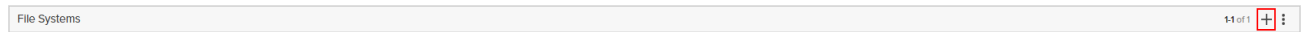

3. In Create File System enter a file system name and click Create.

A dialog box titled 'Create File System' with a close button (X) in the top right corner. It contains a single text input field labeled 'Name' with the value 'vdi'. At the bottom right, there are two buttons: 'Cancel' and 'Create'.

4. Navigate to Storage > File Systems > Directories.

5. Click the + icon.

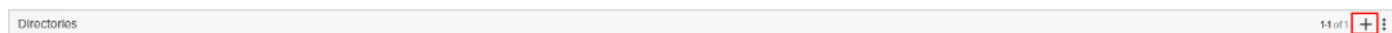

6. In Create Directory pop-up dialog enter Select a file system from the drop-down list, enter the desired management name of the directory, and enter the directory path in the file system. (for example, dir or /dir, for sub-level directories /dir/subdir or /dir/subdir/subdir1 can be used). Click Create.

A dialog box titled 'Create Directory' with a close button (X) in the top right corner. It contains three text input fields: 'File System' with 'vdi', 'Name' with 'root', and 'Path' with '/'. At the bottom right, there are two buttons: 'Cancel' and 'Create'.

Polices for exports/shares/snapshots can only be attached to managed directories at the file system root or 1 level deep (/ and /dir in the example above). Space and performance metrics can be seen at all levels of managed directories.

7. Navigate to Storage > Policies.

8. Click the + icon.

- In the Create Export Policy pop-up choose SMB from the Type drop-down and enter a name for the policy. Click Create.

### Create Export Policy

Type

Name

Enabled

- Select Created Policy and click the + icon.

- Complete the Client filter for read-write access and click Add to complete the rule creation.

### Add Rule for Policy 'smb'

Client

Hostname, IPv4 or IPv4 mask. e.g., \*, \*.cs.foo.edu, 192.168.255.255, or 192.168.10.0/24

Access  no-anonymous-access  anonymous-access

Encryption  optional-smb-encryption  smb-encryption

- Attach the export policy(s) to a managed directory. Click the + icon.

- Select a managed directory from the drop-down list, enter a share/export name, and click Create.

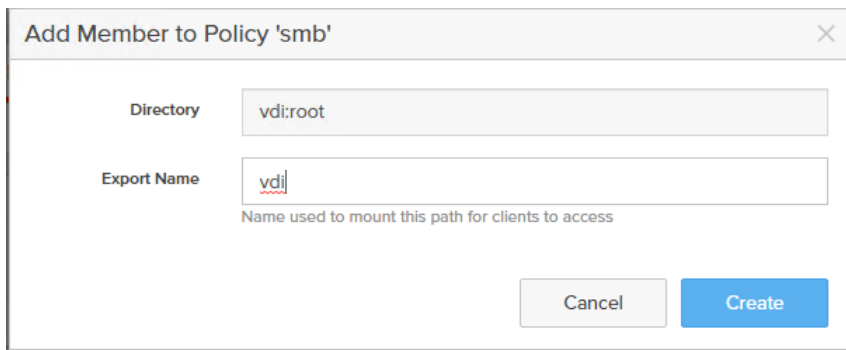

14. Verify access to the created share from the Windows client.

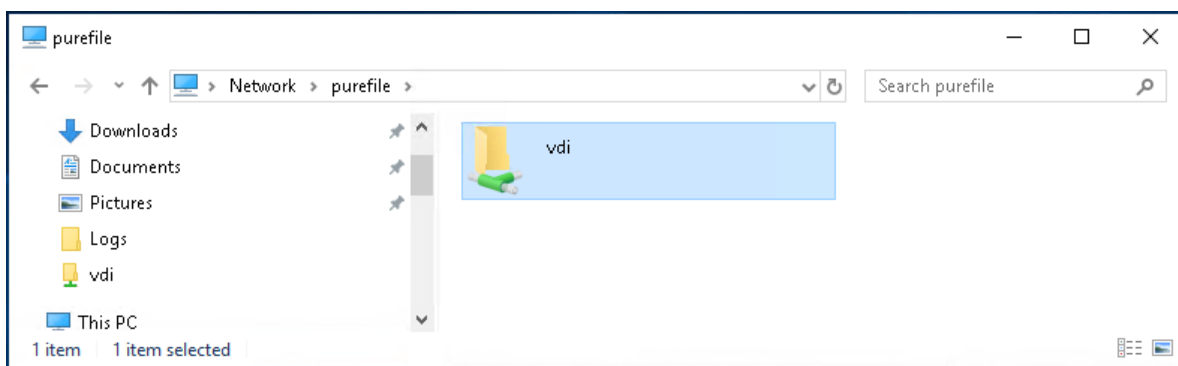

## Install and Configure VMware ESXi 7.0

This section explains how to install VMware ESXi 7.0 GA in an environment.

There are several methods to install ESXi in a VMware environment. These procedures focus on how to use the built-in keyboard, video, mouse (KVM) console and virtual media features in Cisco UCS Manager to map remote installation media to individual servers and install ESXi on boot logical unit number (LUN). Upon completion of steps outlined here, ESXi hosts will be booted from their corresponding SAN Boot LUNs.

### Download Cisco Custom Image for VMware vSphere ESXi 7.0

To download the Cisco Custom Image for VMware ESXi 7.0 GA, from the [VMware vSphere Hypervisor 7.0 GA](#) page click the "Custom ISOs" tab.

### Install VMware vSphere ESXi 7.0

To install VMware vSphere ESXi hypervisor on Cisco UCS Server, follow these steps:

1. In the Cisco UCS Manager navigation pane, click the Equipment tab.
2. Under Servers > Service Profiles> VDI-Host1
3. Right-click on VDI-Host1 and select KVM Console.
4. Click Activate Virtual Devices and then select CD/DVD.



5. Mount the ESXi ISO image.

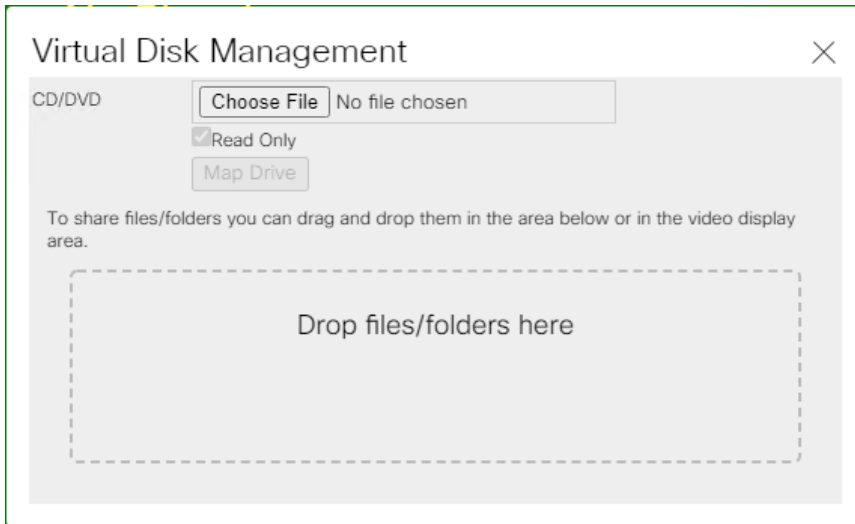

6. Boot into ESXi installer and follow the prompts to complete installing VMware vSphere ESXi hypervisor.

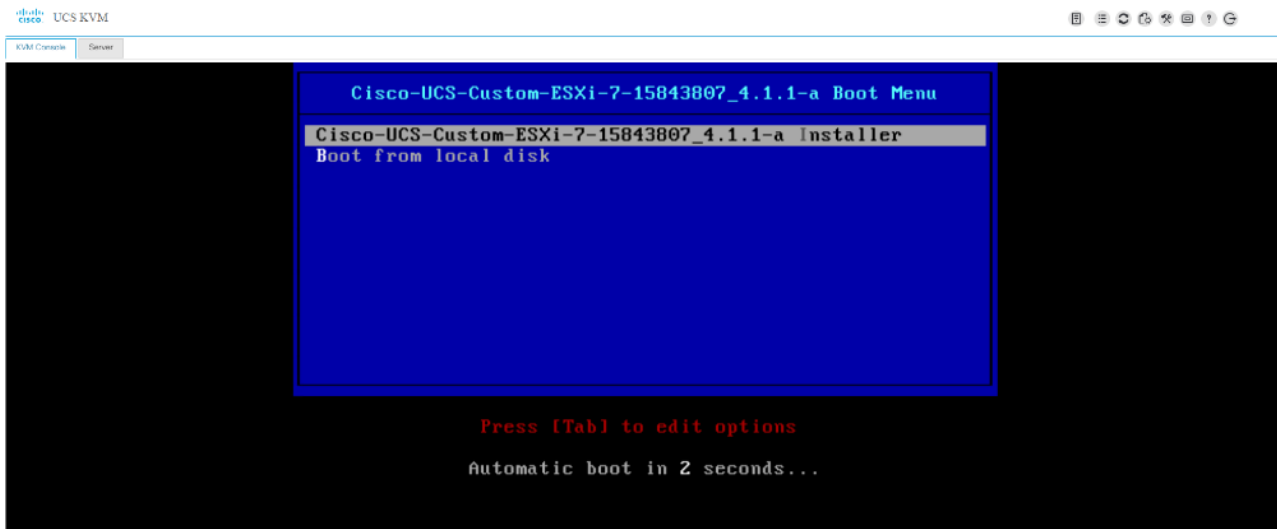

7. When selecting a storage device to install ESXi, select Remote LUN provisioned through Pure Storage Administrative console and access through FC connection.



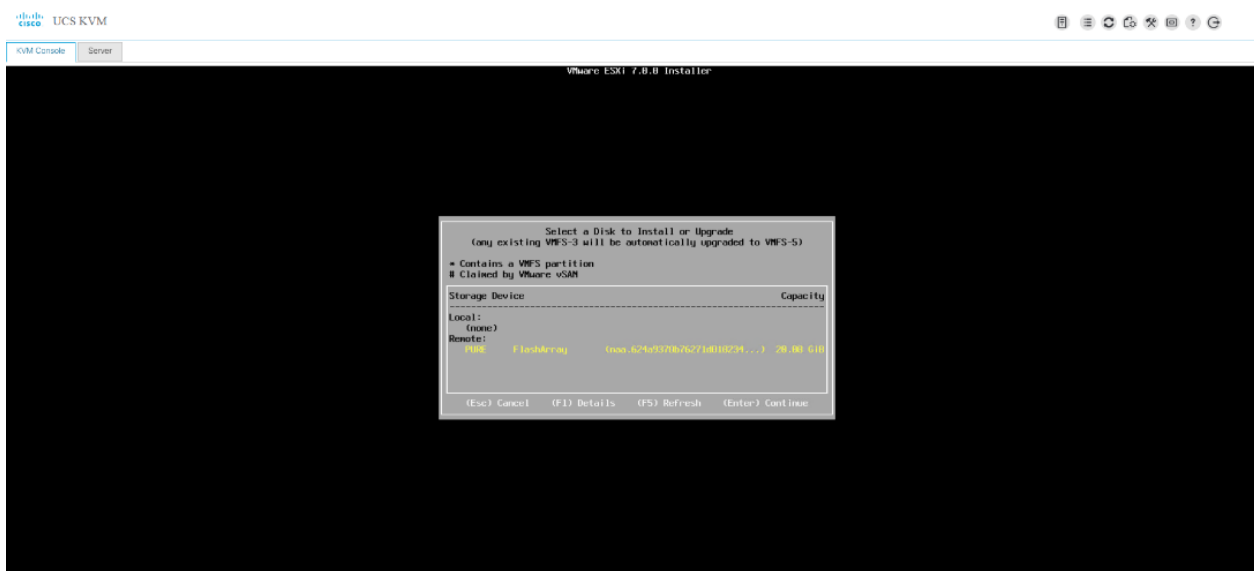

## Set Up Management Networking for ESXi Hosts

Adding a management network for each VMware host is necessary for managing the host and connection to vCenter Server. Please select the IP address that can communicate with existing or new vCenter Server.

To configure the ESXi host with access to the management network, follow these steps:

1. After the server has finished rebooting, press F2 to enter in to configuration wizard for ESXi Hypervisor.
2. Log in as root and enter the corresponding password.
3. Select the Configure the Management Network option and press Enter.
4. Select the VLAN (Optional) option and press Enter. Enter the VLAN In-Band management ID and press Enter.
5. From the Configure Management Network menu, select "IP Configuration" and press Enter.
6. Select "Set Static IP Address and Network Configuration" option by using the space bar. Enter the IP address to manage the first ESXi host. Enter the subnet mask for the first ESXi host. Enter the default gateway for the first ESXi host. Press Enter to accept the changes to the IP configuration.
7. IPv6 Configuration is set to automatic.
8. Select the DNS Configuration option and press Enter.
9. Enter the IP address of the primary and secondary DNS server. Enter Hostname
10. Enter DNS Suffixes.



Since the IP address is assigned manually, the DNS information must also be entered manually.



The steps provided vary based on the configuration. Please make the necessary changes according to your configuration.

Figure 45. Sample ESXi Configure Management Network

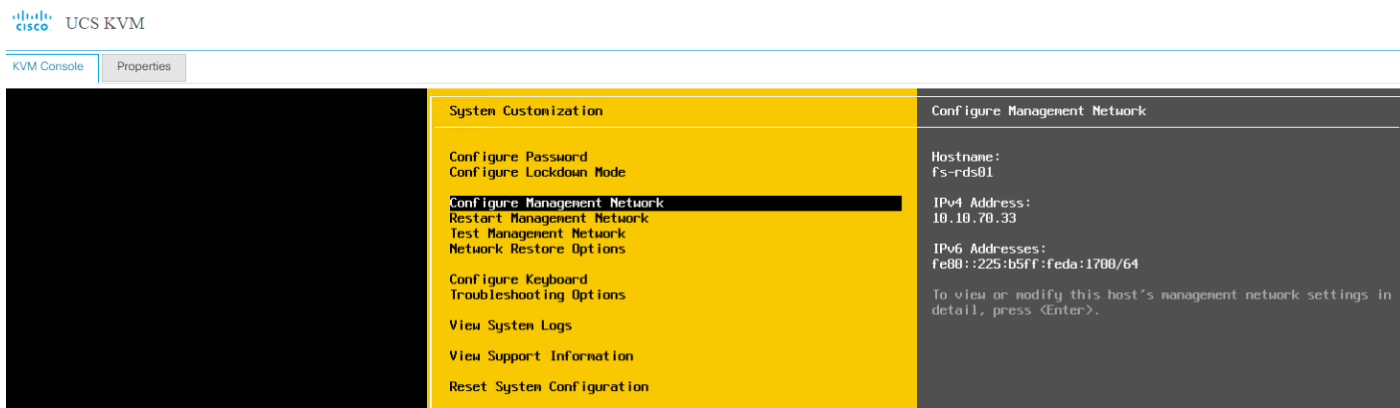

### Update Cisco VIC Drivers for ESXi

When ESXi is installed from Cisco Custom ISO, you might have to update the Cisco VIC drivers for VMware ESXi Hypervisor to match the current [Cisco Hardware and Software Interoperability Matrix](#).



In this Validated Design the following drivers were used:

- Cisco-nenic- 1.0.33.0
- Cisco-nfnic- 4.0.0.56

To update the Cisco VIC drivers for ESXi, follow these steps:

1. Log into your VMware Account to download required drivers for FNIC and NENIC as per the recommendation.
2. Enable SSH on ESXi to run following commands:

```
esxcli software vib update -d /path/offline-bundle.zip
```

### VMware Clusters

The following VMware Clusters were configured to support the solution and testing environment:

- FlashStack-Datacenter: Pure Storage FlashArray//X70 R3 with Cisco UCS
- Infrastructure Cluster: Infrastructure virtual machines (vCenter, Active Directory, DNS, DHCP, SQL Server, VMware Connection Servers, and other common services)
- VDI: Virtual Desktop or RDS Server workload
- VDI1: Virtual Desktop or RDS Server workload
- VDI2: Virtual Desktop or RDS Server workload

- Login VSI Cluster: The Login VSI launcher infrastructure was connected using the same set of switches but hosted on separate SAN storage and servers

**Figure 46. VMware vSphere WebUI Reporting Cluster Configuration for this Validated Design**

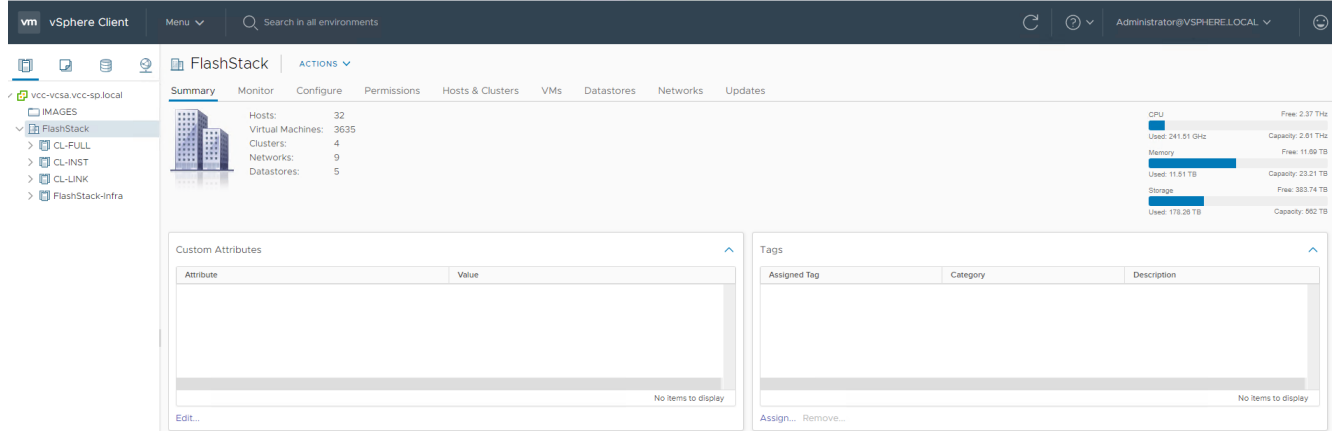

## Build the Virtual Machines and Environment for Workload Testing

### Prerequisites

Create all necessary DHCP scopes for the environment and set the Scope Options.

**Figure 47. Example of the DHCP Scopes used in this CVD**

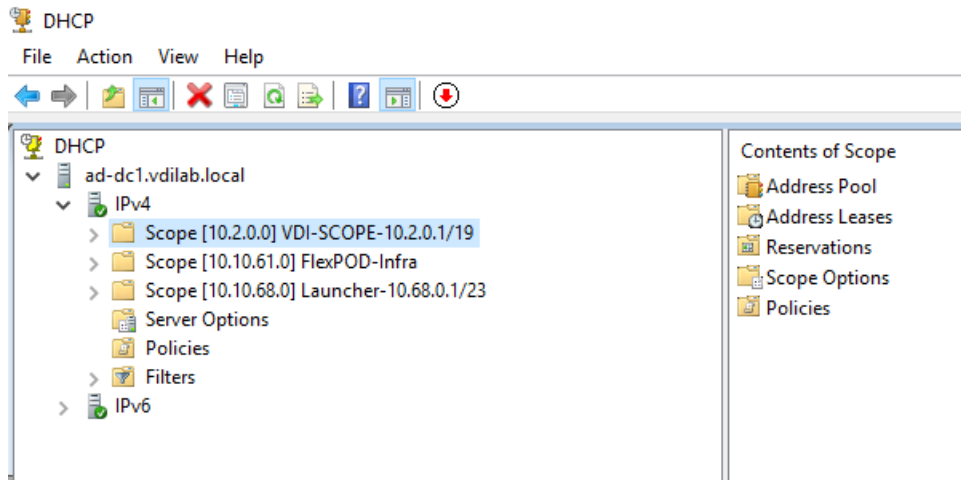

### Software Infrastructure Configuration

This section explains how to configure the software infrastructure components that comprise this solution.

Install and configure the infrastructure virtual machines by following the process listed in [Table 14](#).

**Table 14. Test Infrastructure Virtual Machine Configuration**

Configuration	Microsoft Active Directory DCs Virtual Machines	vCenter Server Appliance Virtual Machine
---------------	--	---

Operating system	Microsoft Windows Server 2019	VCSA – SUSE Linux
Virtual CPU amount	2	24
Memory amount	8 GB	48 GB
Network	VMXNET3 Infra	VMXNET3 OOB-Mgmt
Disk size	40 GB	2 TB (across 13 VMDKs)
Configuration	Microsoft SQL Server Virtual Machine	Vmware Connection Servers Virtual Machines
Operating system	Microsoft Windows Server 2019 Microsoft SQL Server 2016 SP1	Microsoft Windows Server 2019
Virtual CPU amount	4	10
Memory amount	16GB	16 GB
Network	VMXNET3 Infra	VMXNET3 Infra
Disk-1 (OS) size	40 GB	40 GB
Disk-2 size	100 GB SQL Databases\Logs	-

### Prepare the Master Targets

This section provides guidance regarding creating the golden (or master) images for the environment. Virtual machines for the master targets must first be installed with the software components needed to build the golden images. Additionally, all available patches as of August 30, 2019 for the Microsoft operating systems, SQL server and Microsoft Office 2019 were installed.

To prepare the master virtual machines, there are three major steps: installing Operating System and VMware tools, installing application software, and installing the VMware Horizon Agent.



For this CVD, the images contain the basics needed to run the Login VSI workload.

The master target VDI and RDS virtual machines were configured as listed in [Table 15](#).

**Table 15. VDI and RDS Virtual Machines Configurations**

Configuration	VDI Virtual Machines	RDS Virtual Machines
Operating system	Microsoft Windows 10 64-bit	Microsoft Windows Server 2019
Virtual CPU amount	2	10
Memory amount	3.5 GB reserve for all guest memory	32 GB reserve for all guest memory
Network	VMXNET3 VDI	VMXNET3 VDI
vDisk size	32 GB	40 GB
Additional software used for testing	Microsoft Office 2019 Login VSI 4.1.25 (Knowledge Worker Workload)	Microsoft Office 2019 Login VSI 4.1.25 (Knowledge Worker Workload)



RDS Server Roles need to be deployed on the RDS Master image.

### VMware Horizon Agent Installation

To install the VMware Horizon Agent, follow these steps:

1. Download VMware-Horizon-Agent-x86\_64-7.12.0-15805436 version.
2. Click the VMware Horizon Agent installer.

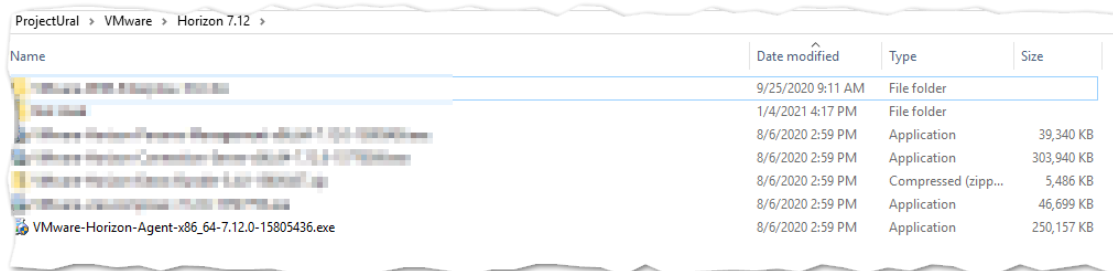

3. Click Next.

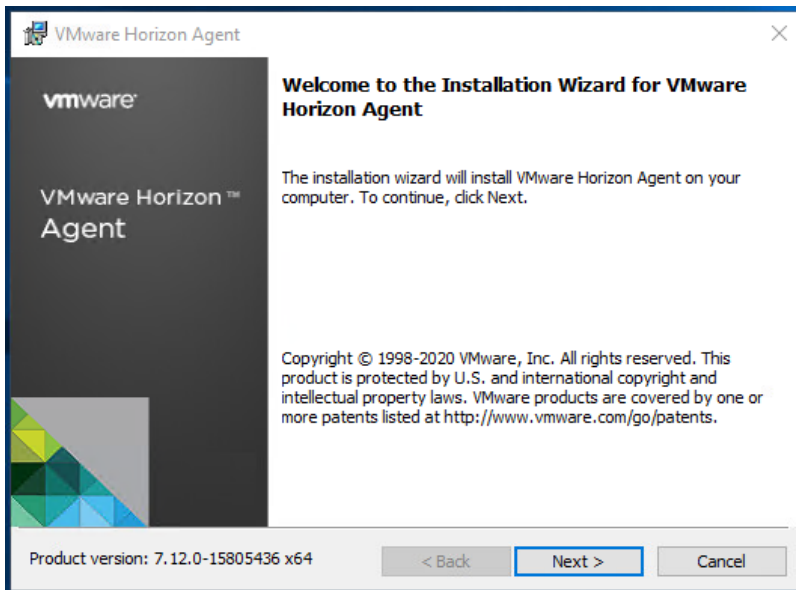

4. Accept the license agreement and click Next.

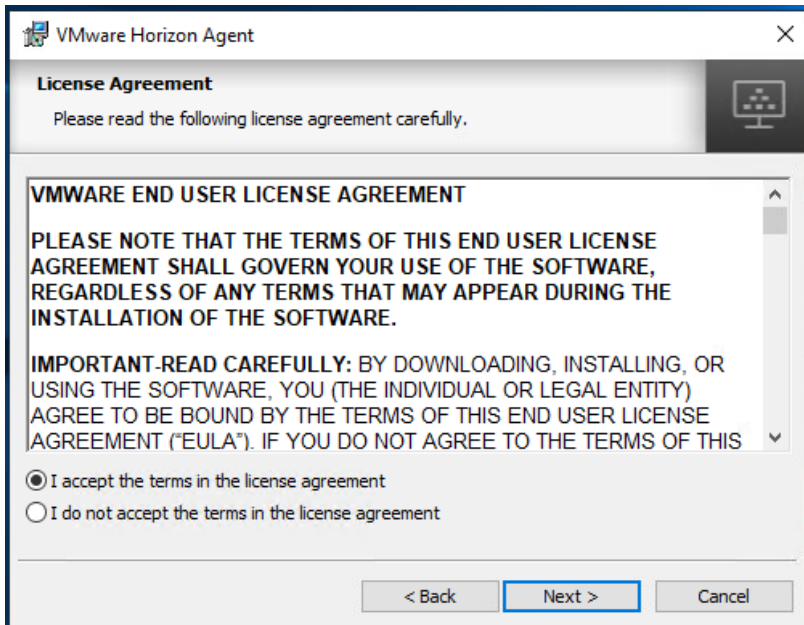

5. Select the default IPV4 and click Next.

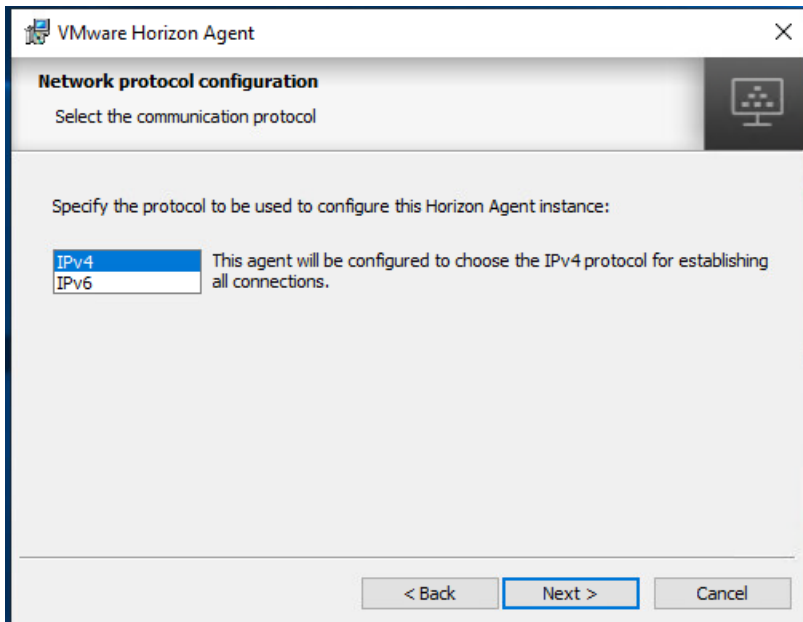

6. During the installation on the Windows 2019 Server select RDS Mode for the agent installation.

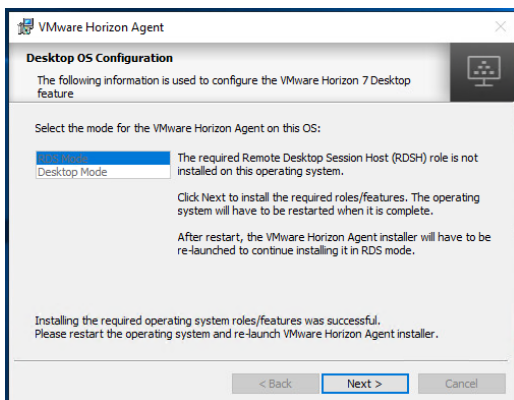

7. Select the features to install.

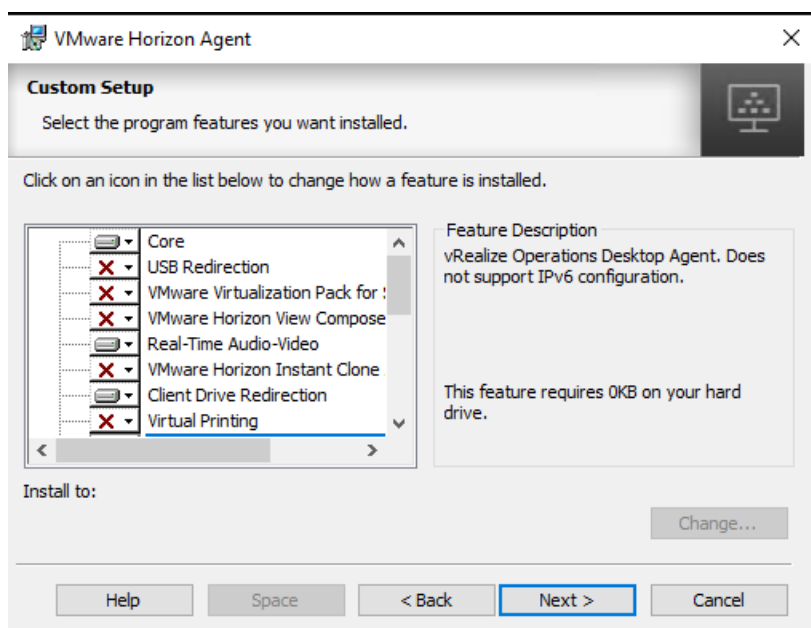

8. Click Finish to complete the Horizon Agent installation on the Master image.

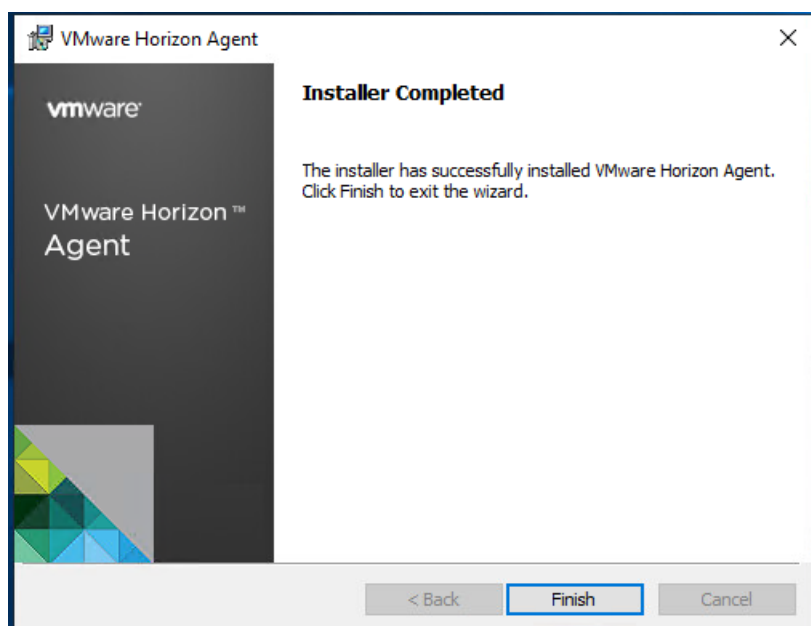

### VMware Dynamic Environment Manager Enterprise (DEM) Setup

To install the VMware DEM on the master image, follow these steps:

1. Download VMware Dynamic Environment Manager Enterprise 10.0-GA version.
2. Click the VMware Dynamic Environment Manager installer for your OS architecture.



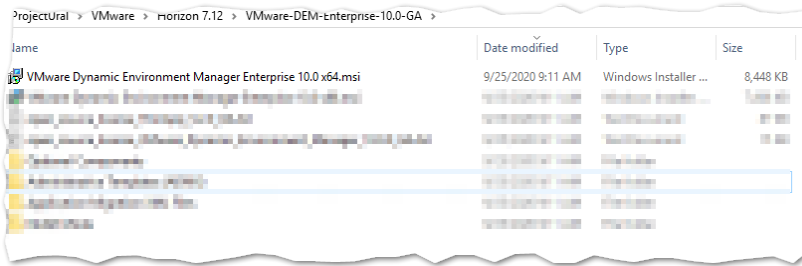

3. Click Next.

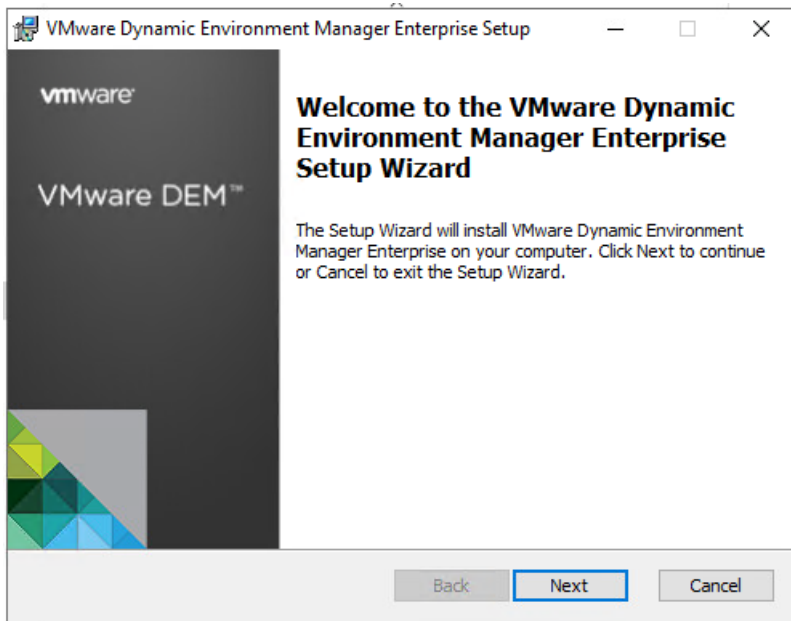

4. Read and accept the End User License Agreement and click Next.

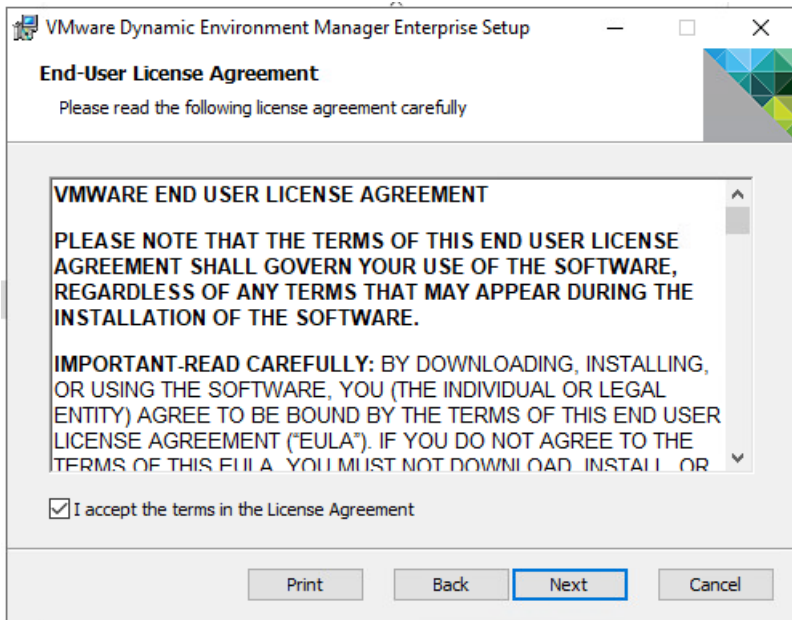

5. Select the destination folder where you want to install the application and click Next.



As a best practice, install VMware Dynamic Environment Manager in the default folder.

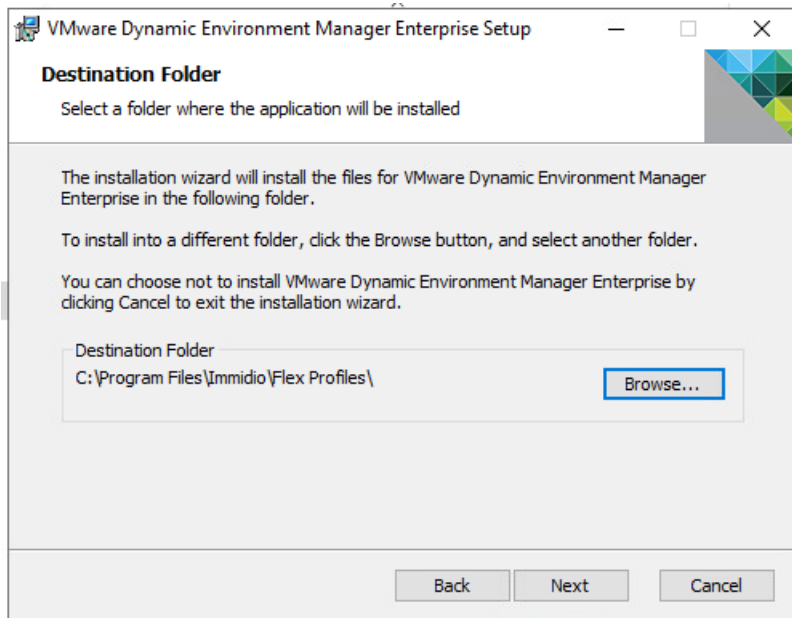

6. Select the Custom installation option for VMware Dynamic Environment Manager.

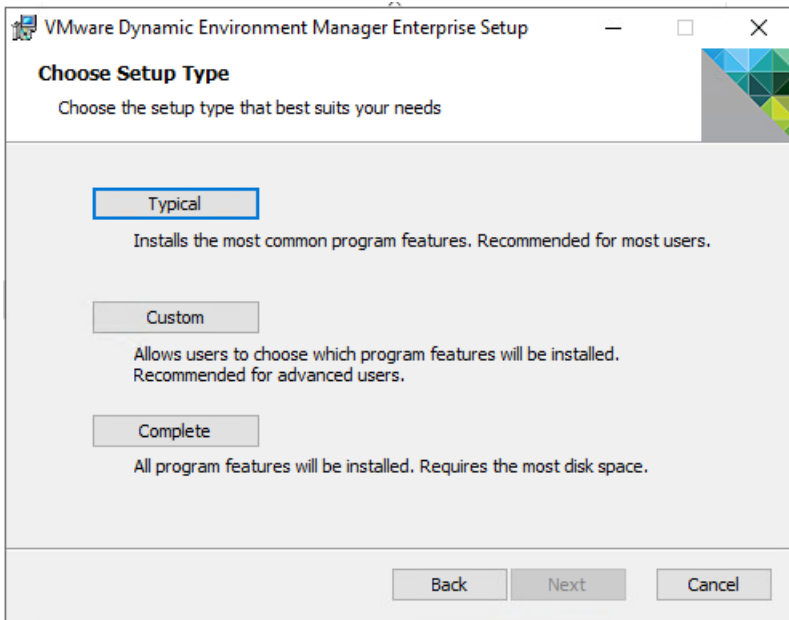

7. Manually select components to install.

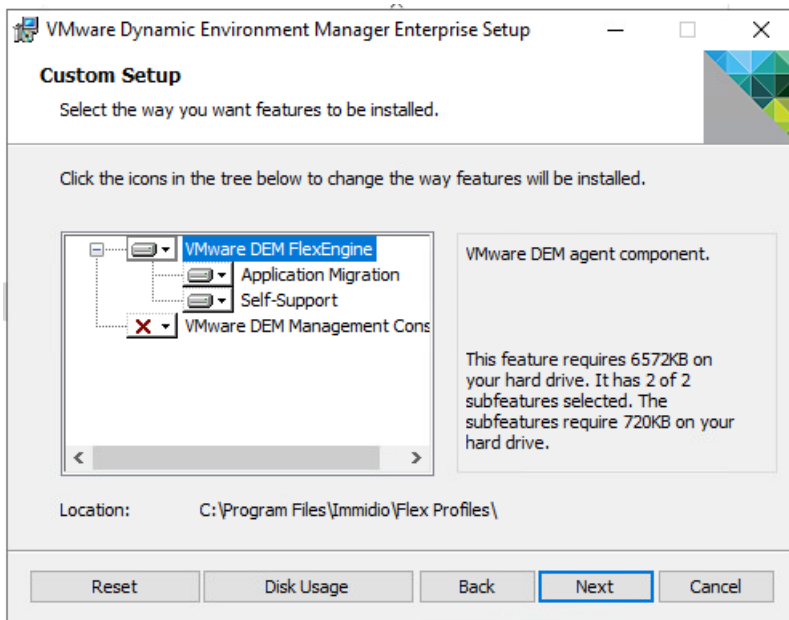

8. Click Next.

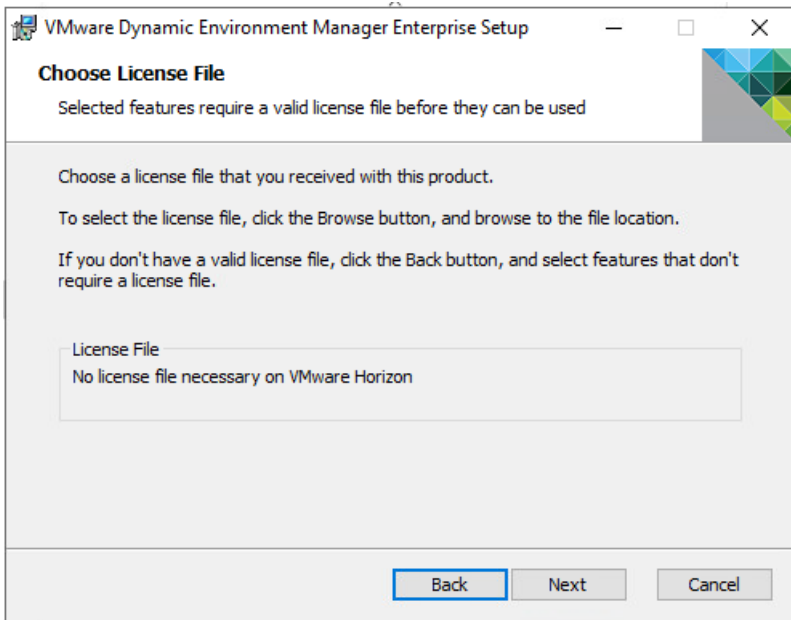

9. Click Install.

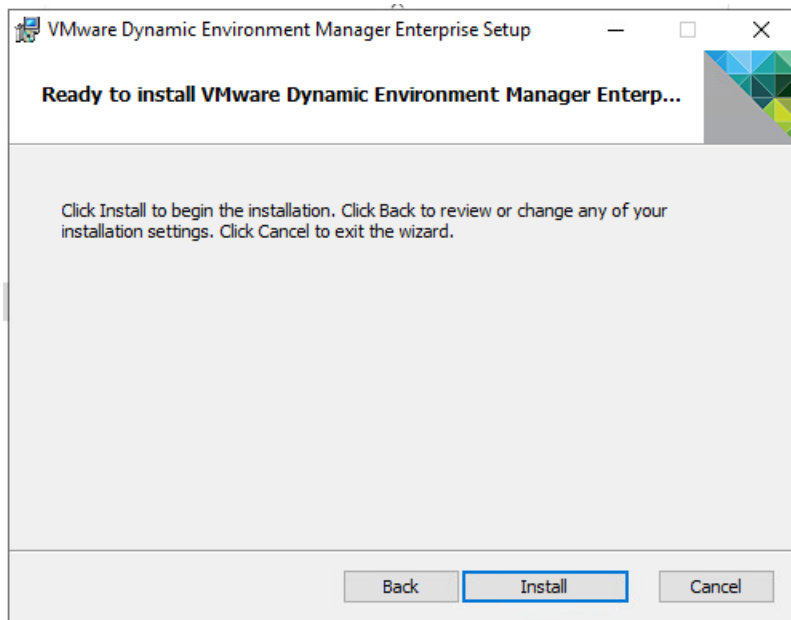

10. After the installation is complete, click Finish.

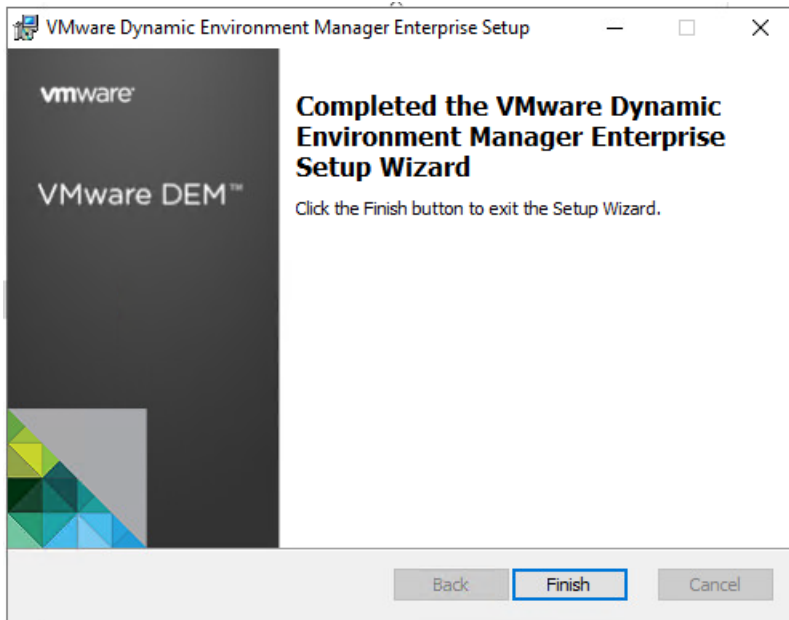

## Install and Configure VMware Horizon Components

This section details the installation of the VMware core components of the Horizon Connection Server and Replica Servers. This CVD installs 1 VMware Horizon Connection server and 3 VMware Horizon Replica Servers to support Remote Desktop Server Hosted sessions (RDSH), non-persistent virtual desktops (VDI) instant clones, and persistent virtual desktops (VDI) full clones based on the best practices from VMware. For information about sizing limits, see [VMware Horizon View 7 sizing limits and recommendations](#).

### VMware Horizon Connection Server Configuration

To configure the VMware View Connection Server, follow these steps:

1. Download the Horizon Connection server installer from VMware and click Install on the Connection Server Windows Server Image. In this study, we used version Connection Server 7.12.0 build15770369. For the download, see [Download VMware Horizon 7.12](#).
2. Click the Connection Server installer based on your Operating System.

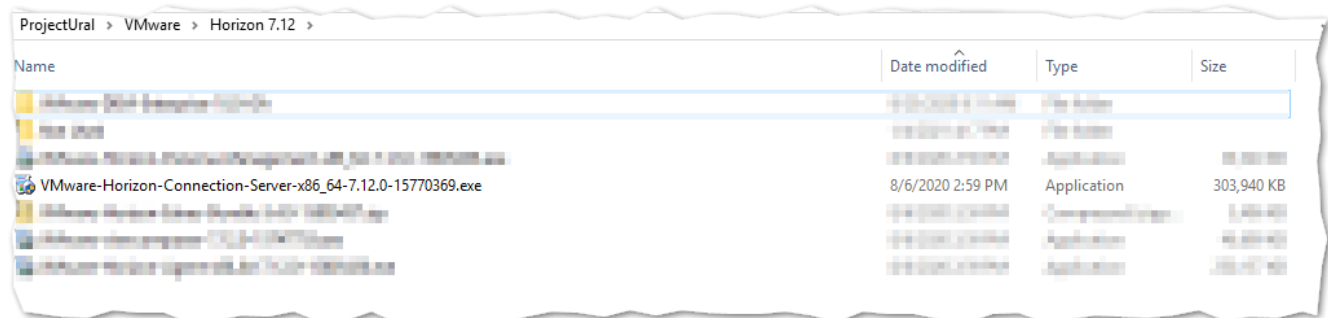

3. Click Next.

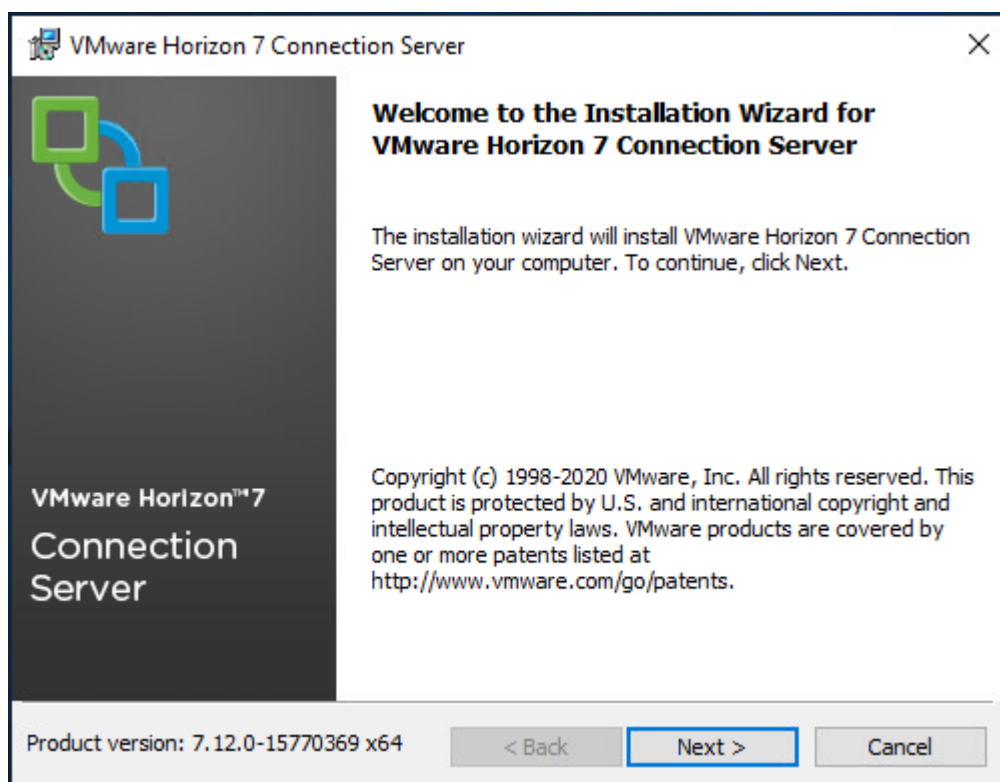

4. Read and accept the End User License Agreement and click Next.

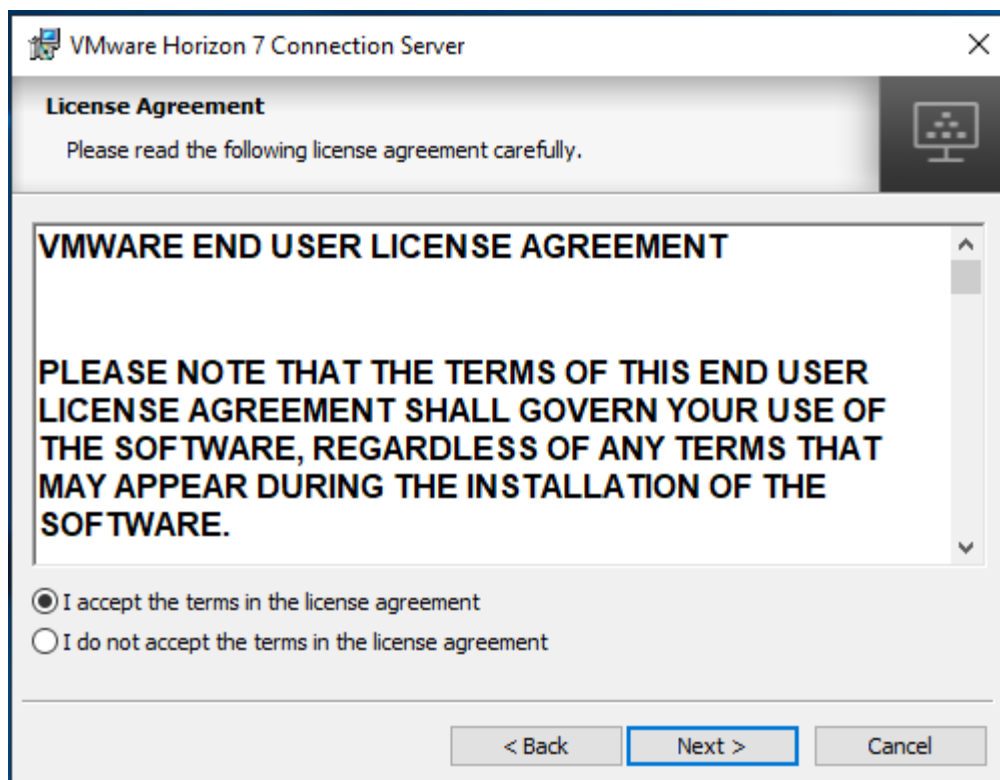

5. Select the destination folder where you want to install the application and click Next.

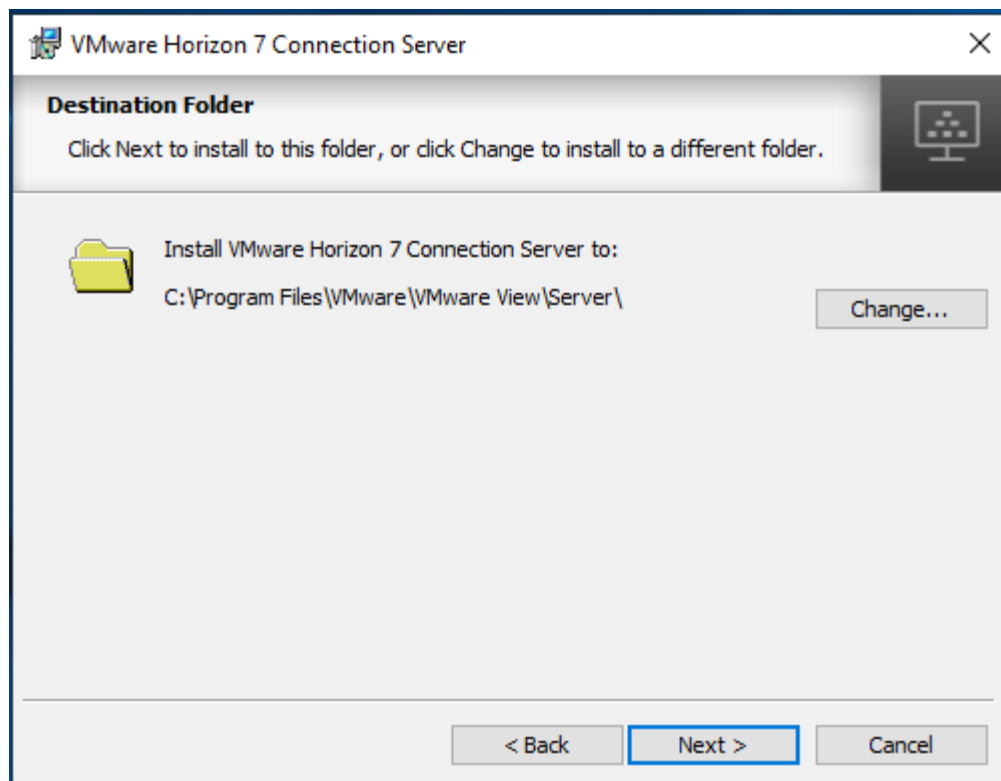

6. Select the Standard Server and IPv4 for the IP protocol version.

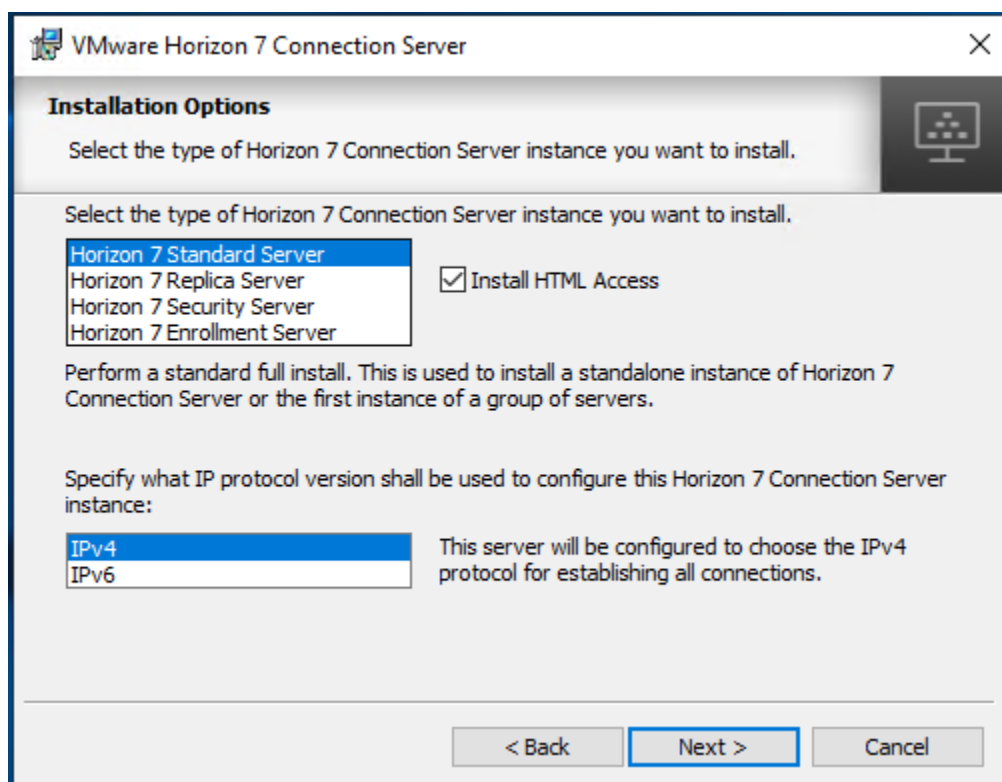

7. Select Configure Windows Firewall automatically. Click Next.

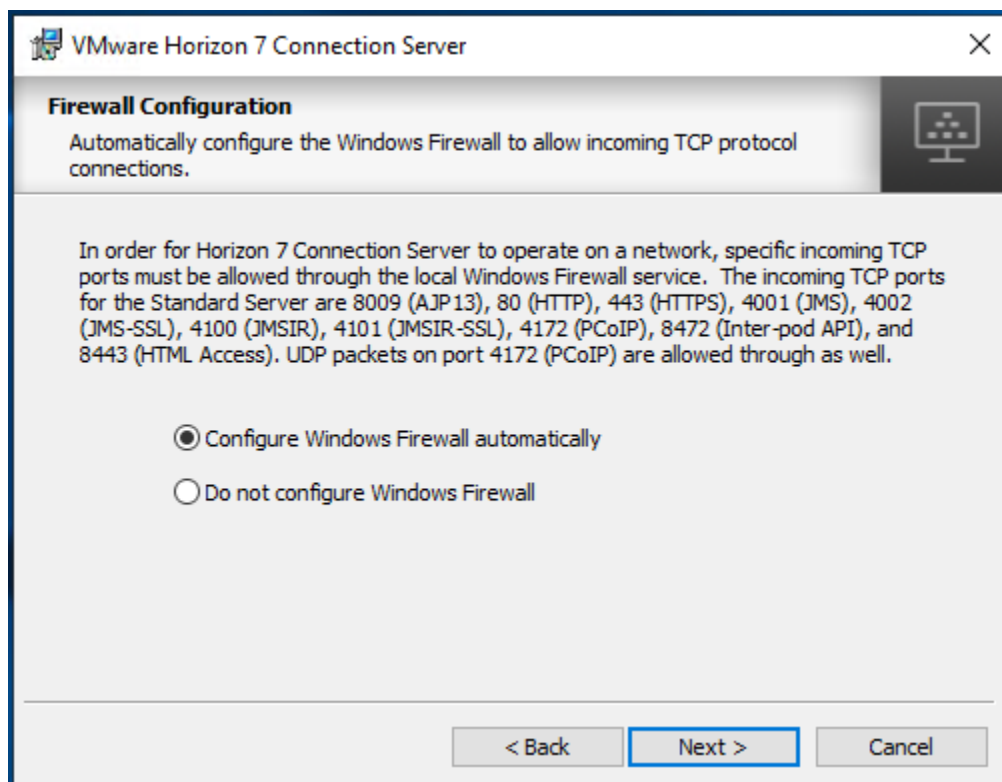



8. Authorize Domain Admins to be VMware Horizon administrators.

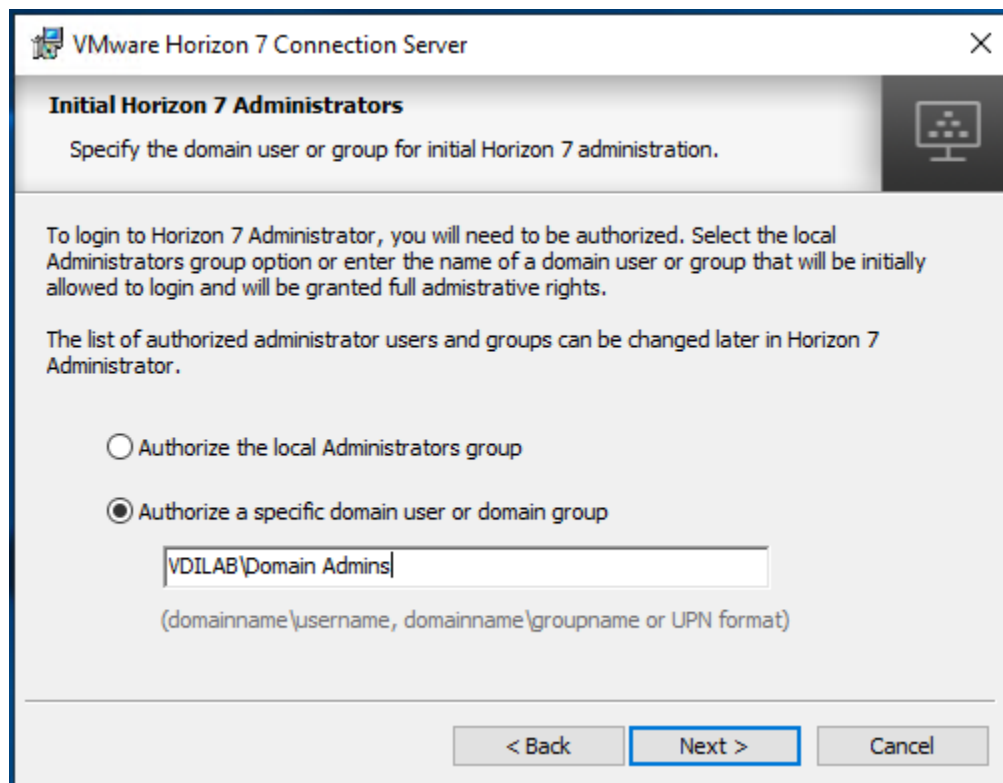

9. (Optional) Join Customer Experience Program.

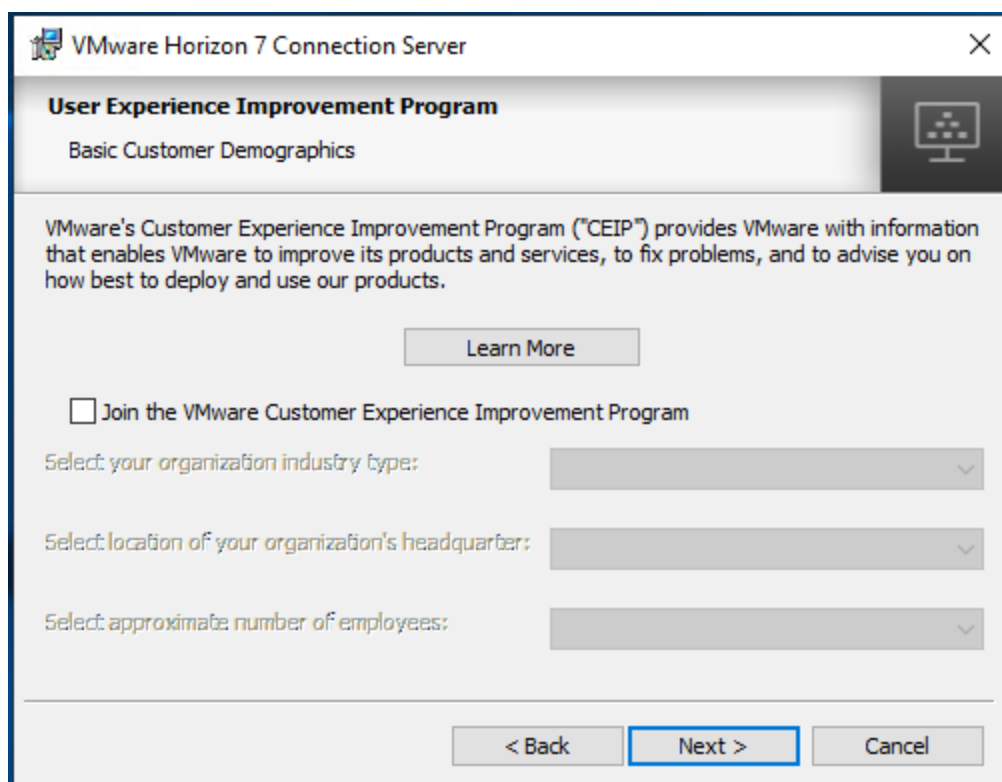

10. Click Install to begin installation.

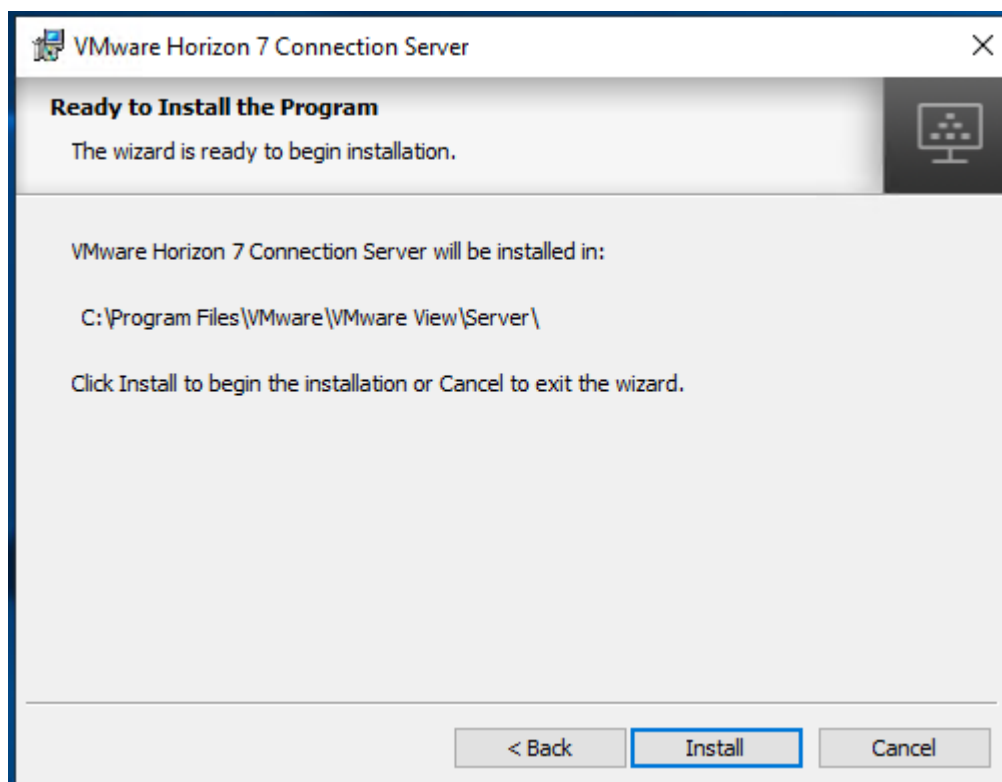

11. After Horizon Connection Server installation is complete, click Finish.

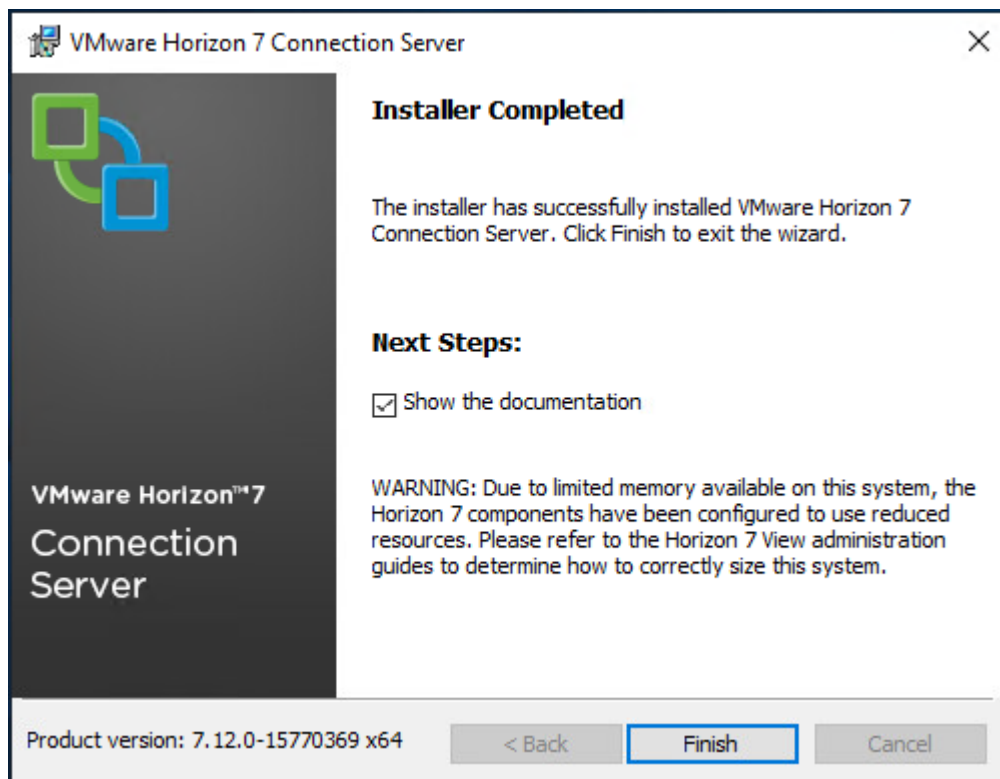

### Install VMware Horizon Replica Server

To install the VMware Horizon Replica Server, follow these steps:

1. Click the Connection Server installer based on your Operating System.

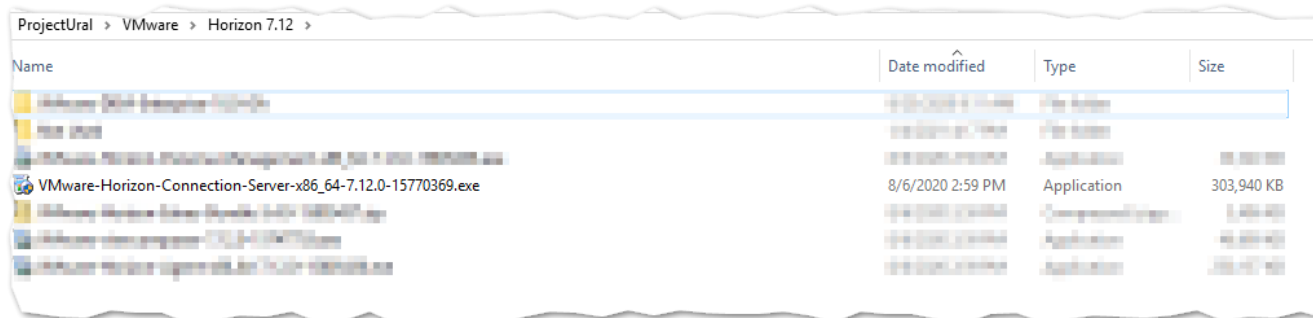

2. Click Next.

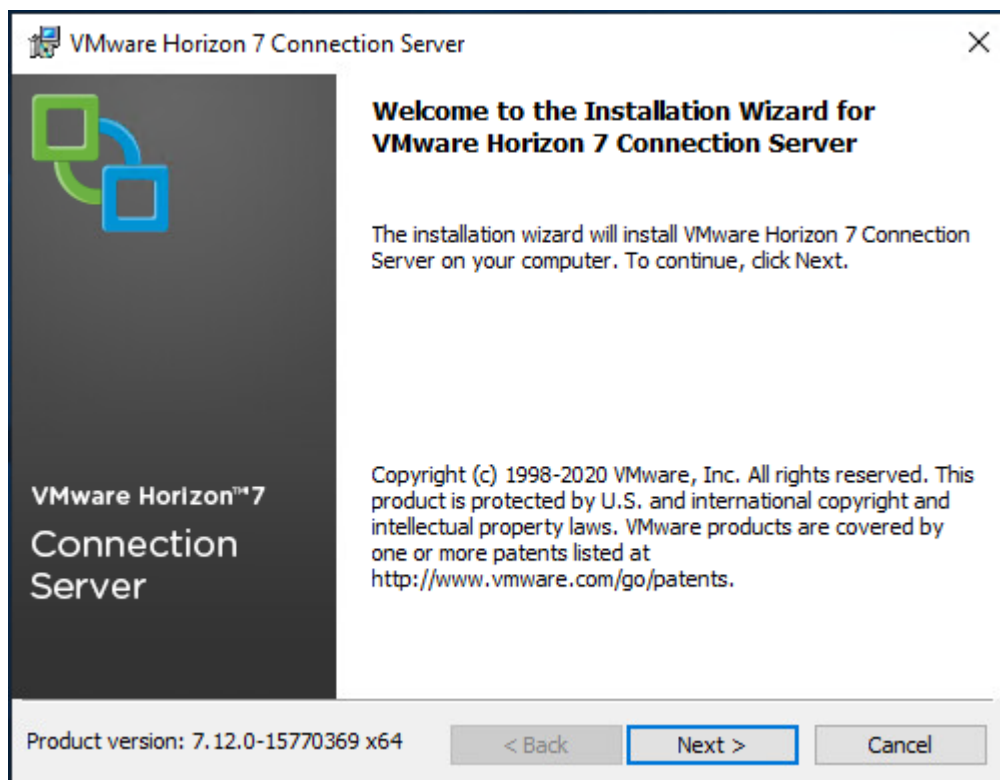

3. Read and accept the End User License Agreement and click Next.

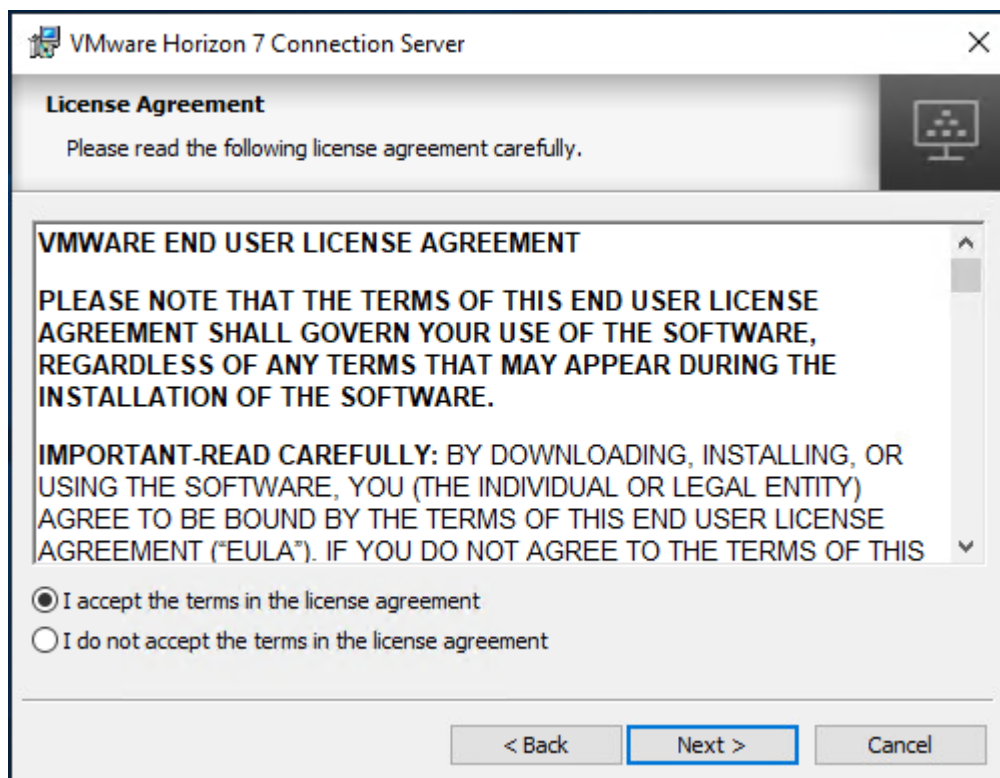

4. Select the destination folder where you want to install the application and click Next.

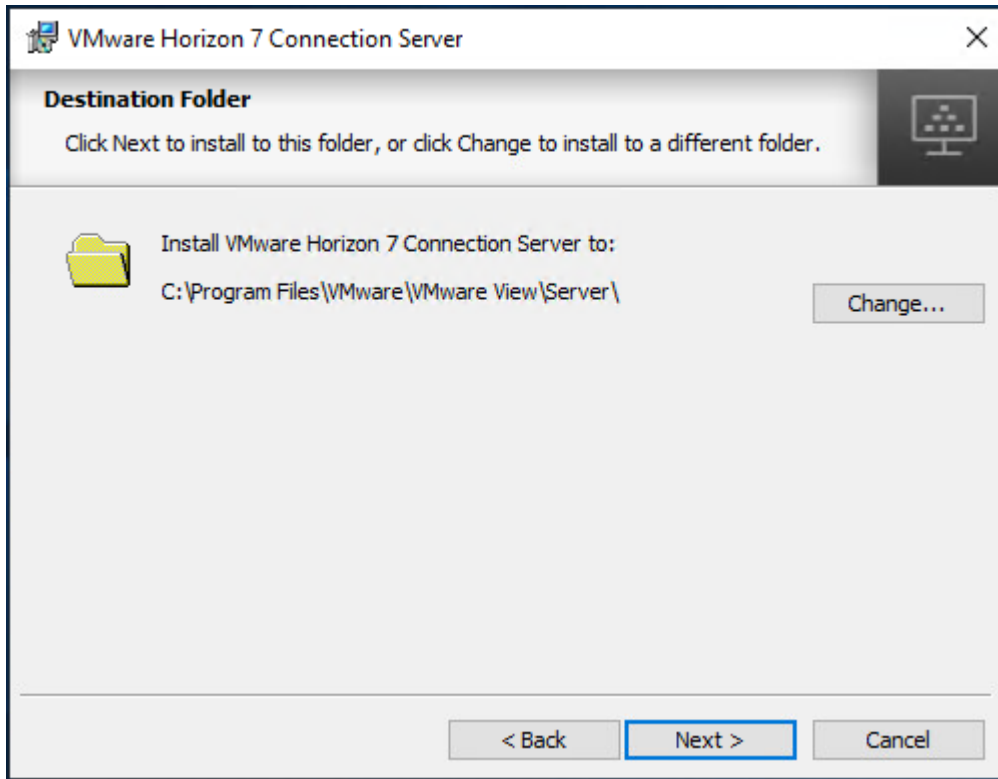

5. Select the Replica Server and IPv4 for the IP protocol version.

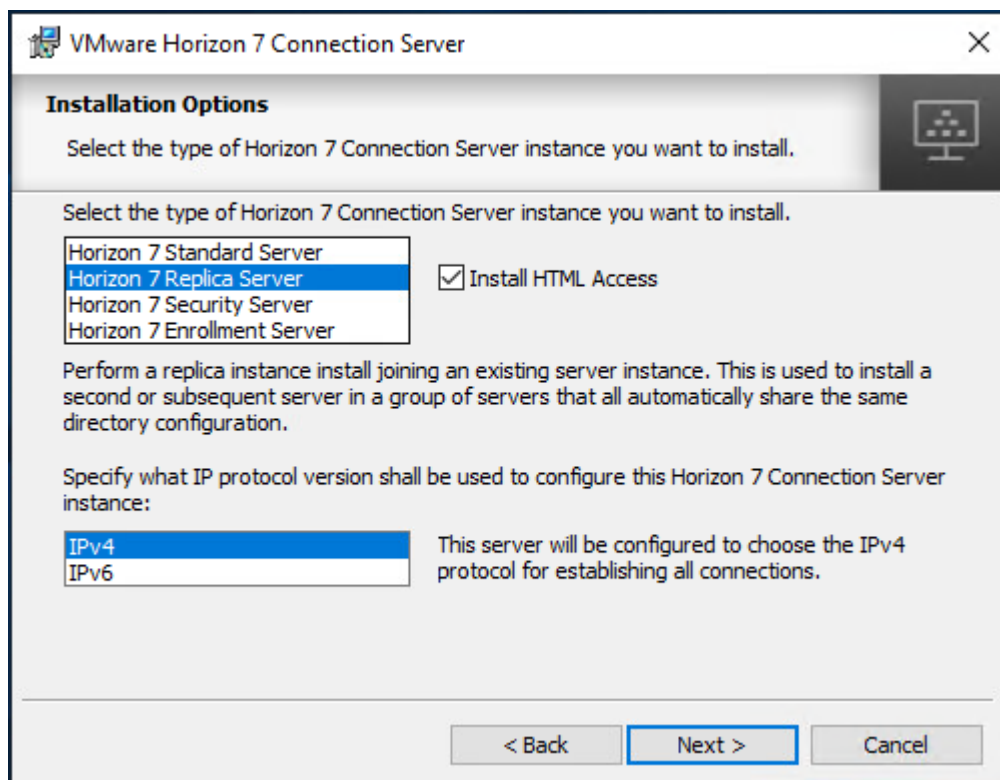

6. Provide existing Standard View Connection Server's FQDN or IP address and click Next.

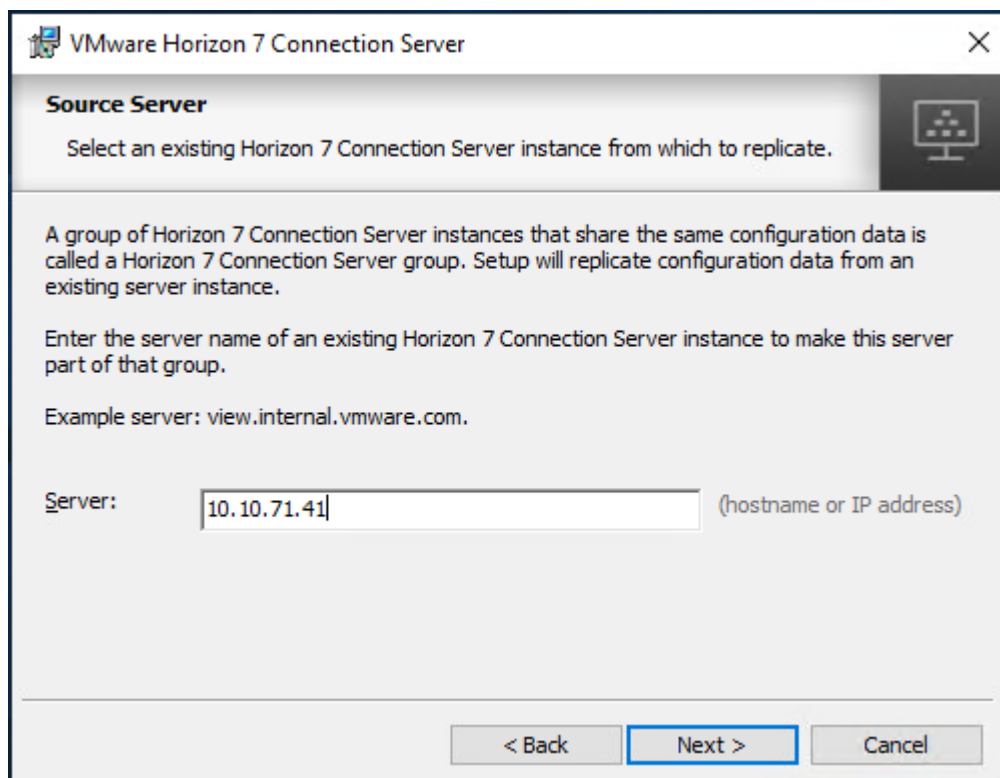

7. Select Configure the Windows Firewall automatically.

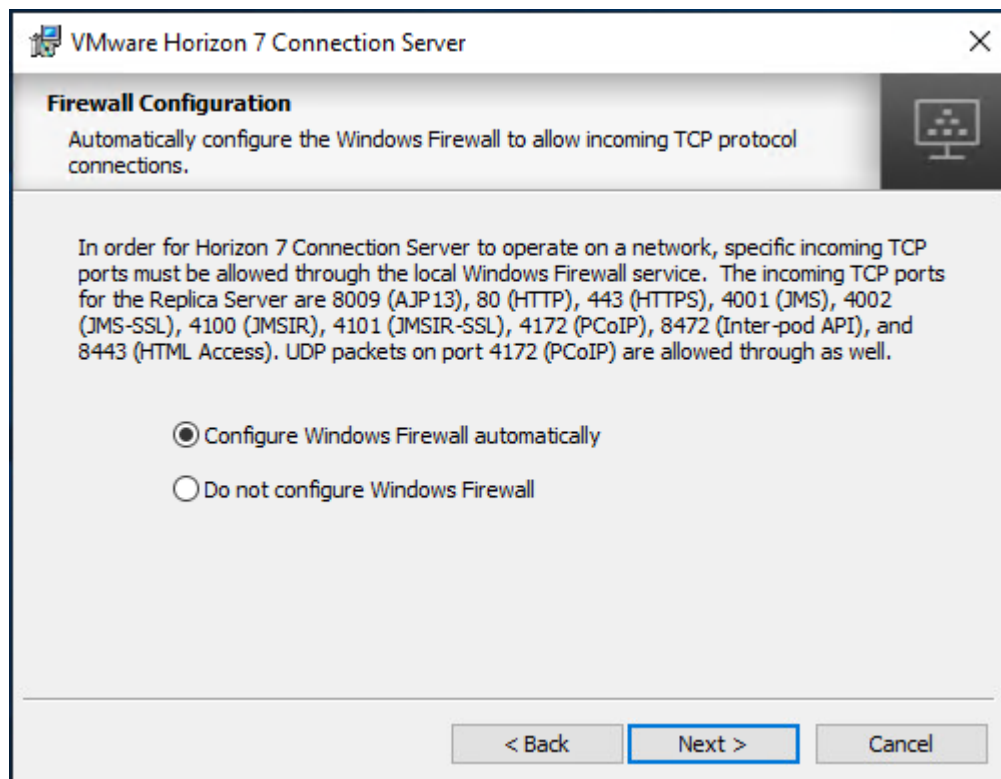

8. Click Install to begin the installation process.

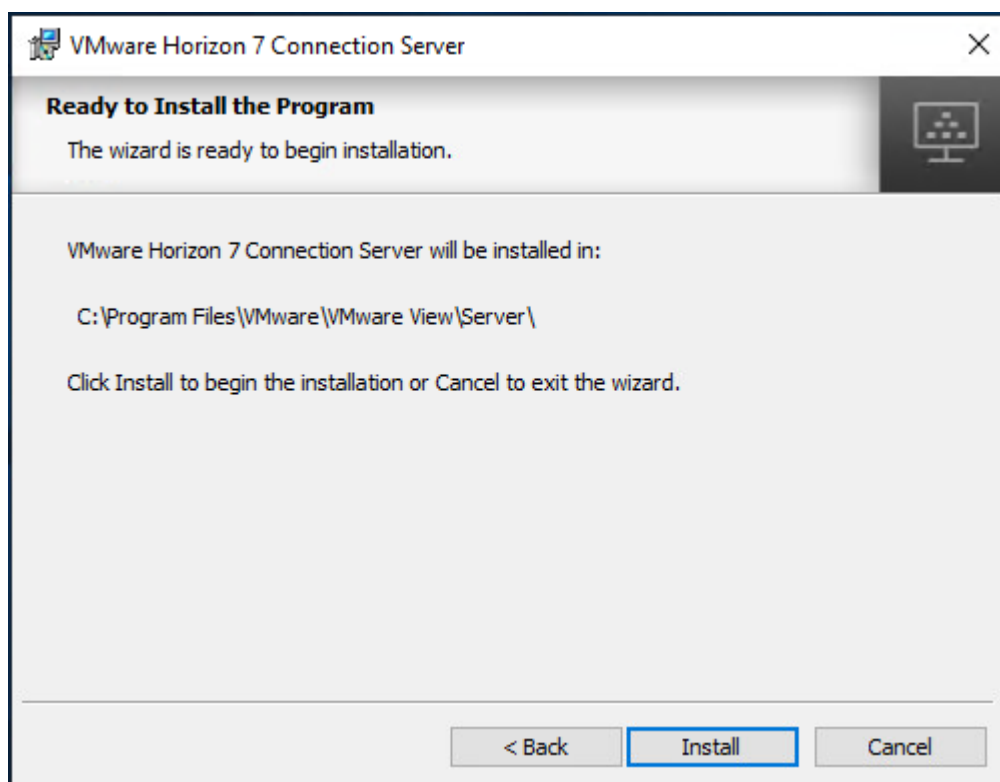

9. After installation is complete, click Finish.

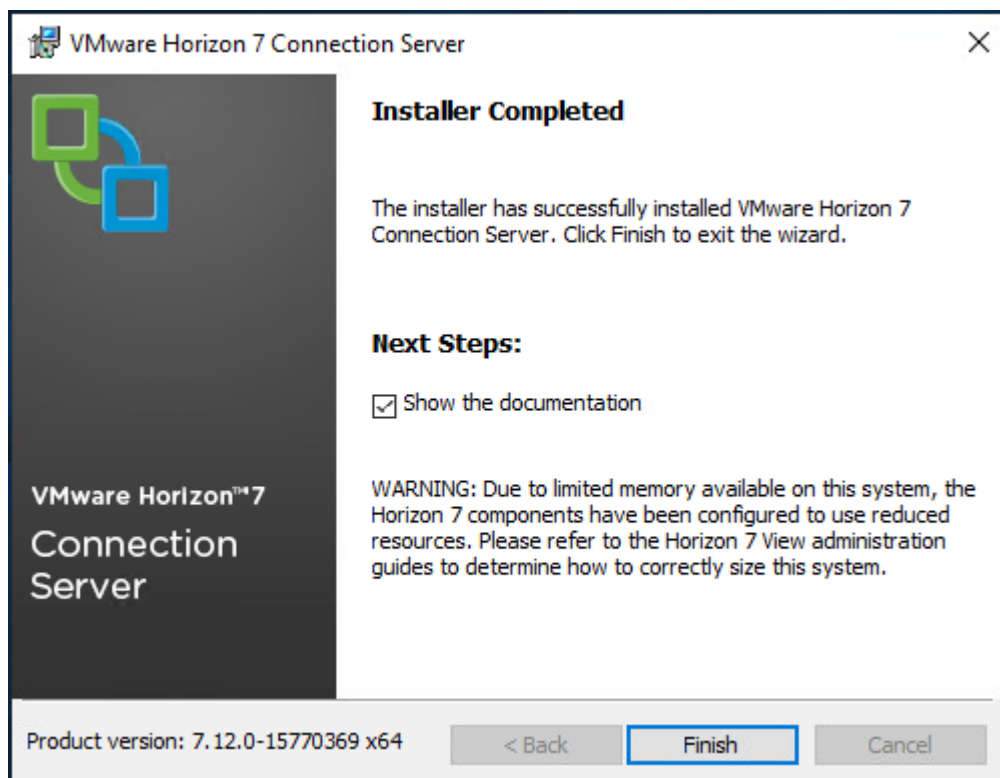



## VMware Horizon Desktop Configuration

Management of the desktops, application pools and farms is accomplished in VMware Horizon Console (HTML5) or Horizon Administrator (Flex). We used Horizon Console to administer VMware Horizon environment in this validated design.



VMware recommends using Horizon Console, an HTML5 based interface with enhanced security, capabilities, and performance.

To create the VMware Horizon Desktop Initial configuration, follow these steps:

1. Log into Horizon Console 7.12 via a web browser using Address or FQDN>/admin/#/login.

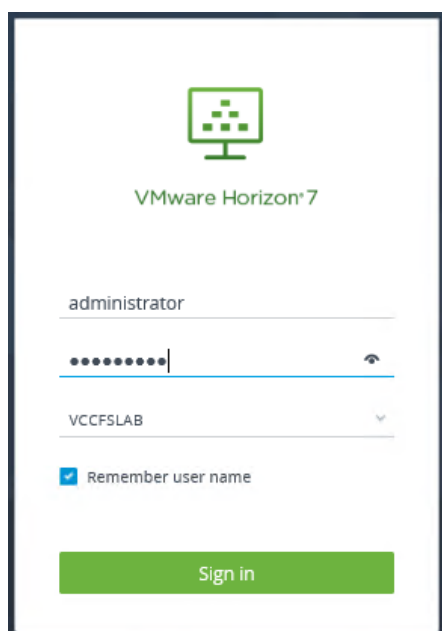

2. In Horizon Console, expand Settings and click Servers.

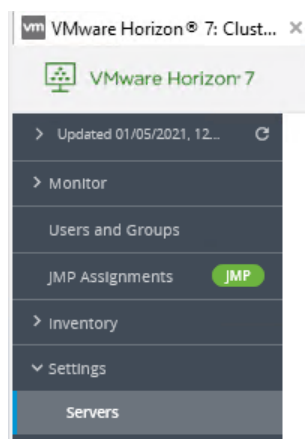

3. Select the vCenter Servers tab and click Add.

## Servers

vCenter Servers   Gateways   Connection Servers

Add

Edit

Remove

Disable Provisioning

Enable Provisioning

4. Provide Server Address (IP or FQDN) and credentials that Horizon will use to login to vCenter, then click Next.

### Add vCenter Server

- 1 vCenter Information
- 2 Horizon Composer
- 3 Storage
- 4 Ready to Complete

\* Server address ⓘ

\* User Name

\* Password

Description

\* Port

VMware Cloud On AWS ⓘ

#### Advanced Settings

Specify the concurrent operation limits. ⓘ

\* Max concurrent vCenter provisioning operations

Cancel   Previous   Next

5. If you see a message regarding an invalid certificate, click View Certificate.

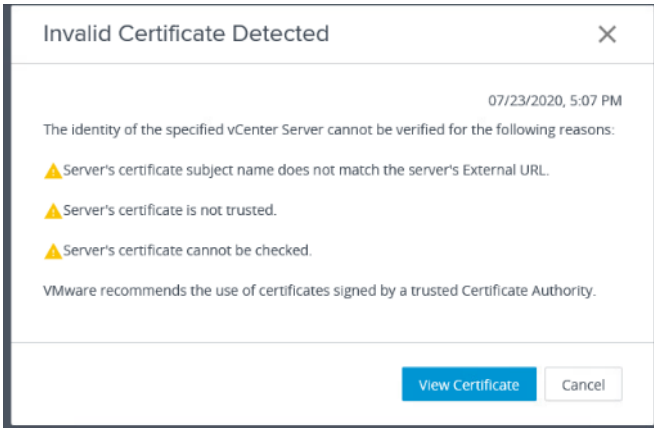

6. Click Accept.

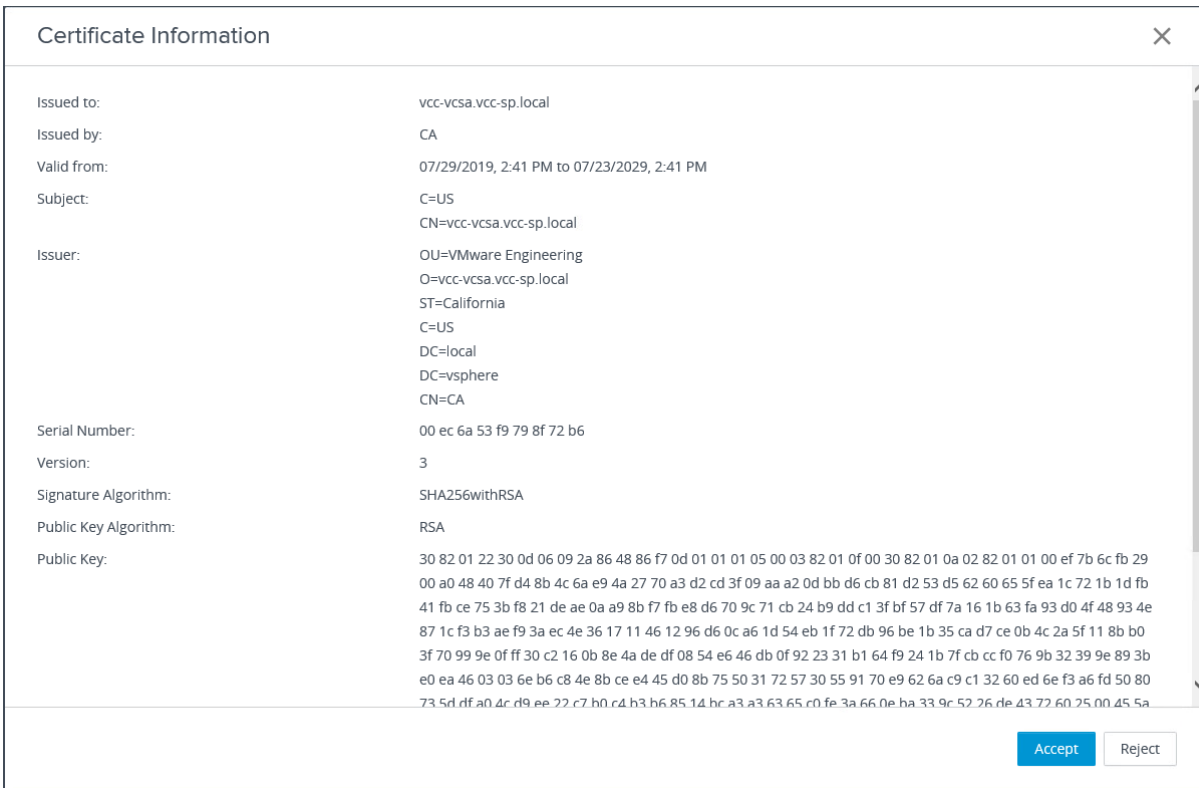

7. No Composer was used in this validated design. Select Do not use Horizon Composer and click Next.

### Add vCenter Server

- ✓ vCenter Information
- 2 Horizon Composer
- 3 Storage
- 4 Ready to Complete

#### View Composer Settings

Do not use Horizon Composer

Horizon Composer co-installed with vCenter Server  
Choose this if Horizon Composer is installed on the same server as vCenter

\* Port: 18443

Standalone Horizon Composer Server  
Choose this if Horizon Composer is installed on a separate server from vCenter

\* Server address:

\* User Name:

\* Password:

\* Port: 18443

Cancel Previous Next

8. Select Reclaim VM disk space and Enable Horizon Storage Accelerator with cache size of 1024MB.

### Add vCenter Server

- ✓ vCenter Information
- ✓ Horizon Composer
- 3 Storage
- 4 Ready to Complete

#### Storage Settings

Reclaim VM disk space

Enable Horizon Storage Accelerator

Default host cache size:  MB  
Cache must be between 100 MB and 2,048 MB

#### Hosts

Show all hosts

Edit cache size

Host	Cache Size(MB)
/FlashStack/host/10.10.70.33/10.10.70.33	Default
/FlashStack/host/10.10.70.34/10.10.70.34	Default
/FlashStack/host/FlashStack-Infra/10.10.70.31	Default

Cancel Previous Next

9. Review the information you provided and click Submit.

Configuration Item	Value
vCenter Server	10.10.70.29
User Name	administrator@vsphere.local
Password	*****
Description	
Server Port	443
VMware Cloud On AWS	No
Max Provision	50
Max Power	50
Max Horizon Composer Operations	12
Max Horizon Composer Provision	20
Max Instant Clone Engine Provision	20
Horizon Composer State	Do not use Horizon Composer

### Create VDI Instant Clone Desktop Pool

To create a VDI Instant Clone Desktop Pool, follow these steps:

1. In Horizon Console on the left plane, expand Inventory, select Desktops. Click Add.

ID	Display name	Type	Source	User Assign...	vCenter Ser...	Entitled	Application...	Enabled	App Shortcuts	Sessions
No records available										

2. Select Type of Desktop pool to be created. Click Next

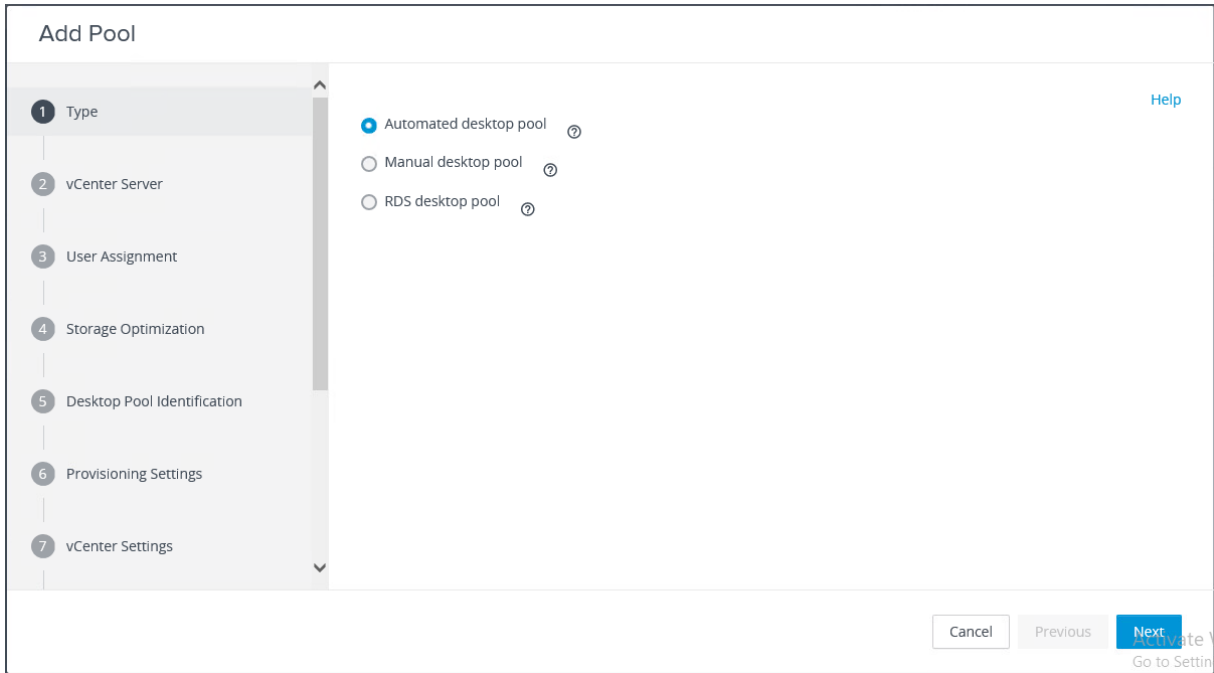

3. Choose provisioning type for the desktops in the pool (we created Instant Clones and Full Virtual Machines pools in this design). Click Next.

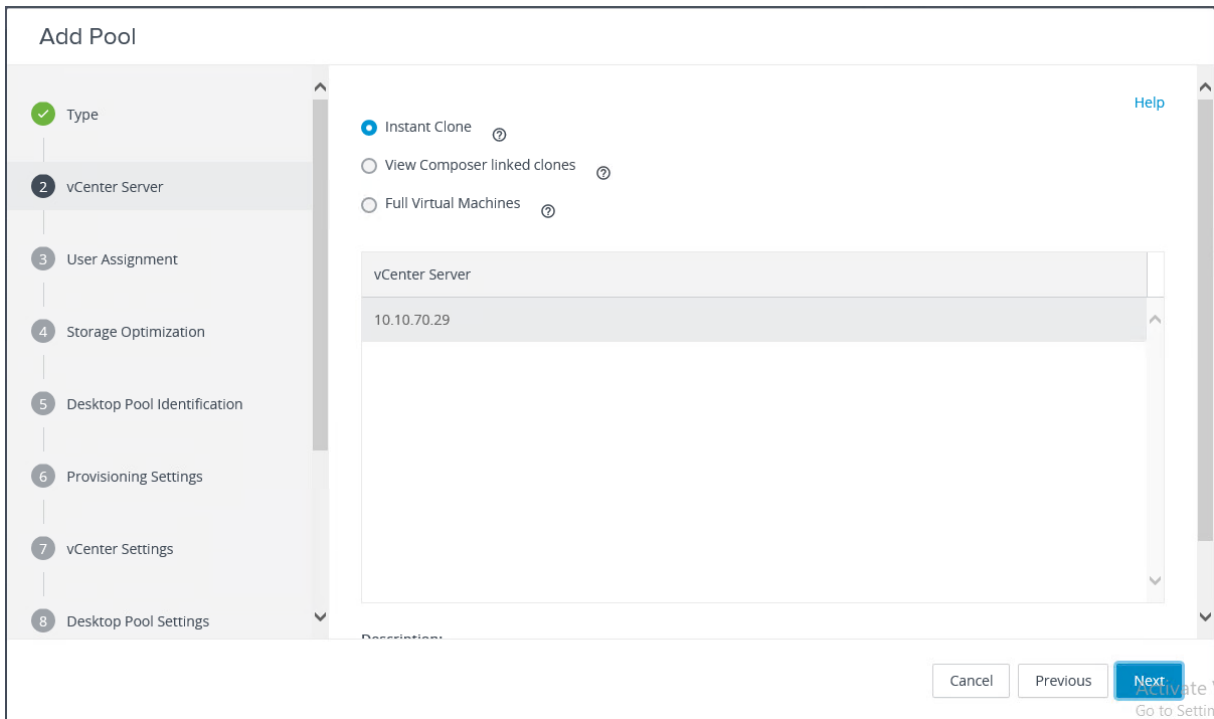

4. Select the User assignment to be used by the desktop pool. Click Next.

The screenshot shows the 'Add Pool' wizard at step 3, 'User Assignment'. The left sidebar lists steps 1 through 8, with 'User Assignment' highlighted. The main content area shows two radio button options: 'Floating' (selected) and 'Dedicated'. Below these is a checked checkbox for 'Enable automatic assignment'. At the bottom right, there are 'Cancel', 'Previous', and 'Next' buttons, with 'Next' highlighted in blue. A 'Help' link is visible in the top right corner.

5. Select the required option for Storage Policy Management. Click Next.

The screenshot shows the 'Add Pool' wizard at step 4, 'Storage Optimization'. The left sidebar lists steps 1 through 8, with 'Storage Optimization' highlighted. The main content area is titled 'Storage Policy Management' and shows two radio button options: 'Use VMware Virtual SAN' (selected) and 'Do not use VMware Virtual SAN'. Below these is a warning message: 'Virtual SAN is not available because no Virtual SAN datastores are configured.' and a checkbox for 'Use separate datastores for replica and OS disks'. At the bottom right, there are 'Cancel', 'Previous', and 'Next' buttons, with 'Next' highlighted in blue. A 'Help' link is visible in the top right corner.

6. Provide Desktop Pool ID and virtual display name. Click Next.

Add Pool - W10-INST

Help

- Type
- vCenter Server
- User Assignment
- Storage Optimization
- 5 Desktop Pool Identification**
- 6 Provisioning Settings
- 7 vCenter Settings
- 8 Desktop Pool Settings

\* ID: ⓘ  
W10-INST

Display name: ⓘ  
W10-INST

Access group: ⓘ  
/

Description:

Cancel Previous **Next** Go to Settings

7. Provide the naming pattern and the number of desktops to be provisioned. Click Next.



In this validated design we used:  
Single Server pool - 186  
Cluster pool - 1674



**Add Pool - W10-INST**

- Type
- vCenter Server
- User Assignment
- Storage Optimization
- Desktop Pool Identification
- 6 Provisioning Settings**
- 7 vCenter Settings
- 8 Desktop Pool Settings

**Basic**

Enable provisioning

Stop provisioning on error

**Virtual Machine Naming** ⓘ

\* Naming Pattern:

W10-INST-

**Provision Machines**

Machines on demand

Min number of machines: 1

All machines up-front

**Desktop Pool Sizing**

\* Max number of machines:

180

\* Number of spare (powered on) machines:

Cancel Previous **Next** Activate Go to Settings

8. Provide the parent VM, snapshot and host/cluster info, and data store information for the virtual machines to create. Click Next.

**Add Pool - W10-INST**

- Type
- vCenter Server
- User Assignment
- Storage Optimization
- Desktop Pool Identification
- Provisioning Settings
- 7 vCenter Settings**
- 8 Desktop Pool Settings

/07242020 Browse...

**Virtual Machine Location**

**VM Folder Location:**

/FlashStack/vm Browse...

**Resource Settings**

**Cluster:**

/FlashStack/host/VM-INST Browse...

**Resource pool:**

/FlashStack/host/VM-INST/Resources Browse...

**Datastores:**

1 selected Browse...

**Network:**

1 selected, Available Ports: 5 Browse...

Cancel Previous **Next** Activate Go to Settings

9. Configure the State and Session Type for Desktop Pool Settings. Click Next.

**Add Pool - W10-INST**

Storage Optimization ✓

Desktop Pool Identification ✓

Provisioning Settings ✓

vCenter Settings ✓

**8 Desktop Pool Settings**

9 Remote Display Settings

10 Guest Customization

11 Ready to Complete

State: Enabled

Connection Server restrictions: None

Category Folder: None

Session Types: Desktop ⓘ

Automatically logoff after disconnect: Never

Allow users to restart/reset their machines: No

Allow users to initiate separate sessions from different client devices: No ⓘ

Cancel Previous **Next** Go to Settings

10. Configure the Remote Display Protocol. Click Next.

**Add Pool - W10-INST**

Storage Optimization ✓

Desktop Pool Identification ✓

Provisioning Settings ✓

vCenter Settings ✓

Desktop Pool Settings ✓

**9 Remote Display Settings**

10 Guest Customization

11 Ready to Complete

**Remote Display Protocol**

Default display protocol: VMware Blast

Allow users to choose protocol: Yes

3D Renderer: Manage using vSphere Client ⓘ

HTML Access:  Enabled ⓘ  
Requires installation of HTML Access.

Allow Session Collaboration:  Enabled ⓘ  
Requires VMware Blast Protocol.

Cancel Previous **Next** Go to Settings

11. Select the AD Container for desktops to place in a Domain Controller computer location.

## Add Pool - W10-INST

Storage Optimization

Desktop Pool Identification

Provisioning Settings

vCenter Settings

Desktop Pool Settings

Remote Display Settings

10 Guest Customization

Domain: vccfsiab.local(administrator)

\* AD Container: OU=WIN10,OU=HORIZION,OU=Target,OU=Computers,OU=LoginVSI

Allow reuse of pre-existing computer accounts ?

Image Publish Computer Account: ?

Use ClonePrep

Power-off script name: ?

Power-off script parameters:

12. Review all the deployment specifications and click Finish to complete the deployment.

13. Select Entitle users after this wizard finishes, to enable desktop user group/users to access this pool.

### Create VDI Full Clone Desktop Pool

To create a VDI Full Clone Desktop Pool, follow these steps:

1. Select Type of Desktop pool to be created. Click Next.

The screenshot shows the 'Add Pool' wizard interface. On the left, a vertical navigation pane lists 11 steps: 1. Type, 2. vCenter Server, 3. User Assignment, 4. Storage Optimization, 5. Desktop Pool ID, 6. Provisioning Settings, 7. vCenter Settings, 8. Desktop Pool Settings, 9. Remote Display Settings, 10. Guest Customization, and 11. Ready to Complete. Step 1 is highlighted. The main area displays three radio button options: 'Automated Desktop Pool' (selected), 'Manual Desktop Pool', and 'RDS Desktop Pool'. Each option has a help icon. At the bottom right, there are three buttons: 'Cancel', 'Previous', and 'Next'.

2. Choose the provisioning type for the desktops in the pool (we created Instant Clones and Full Virtual Machines pools in this design). Click Next.

**Add Pool**

1 Type

2 vCenter Server

3 User Assignment

4 Storage Optimization

5 Desktop Pool ID

6 Provisioning Settings

7 vCenter Settings

8 Desktop Pool Settings

9 Remote Display Settings

10 Advanced Storage Options

11 Guest Customization

12 Ready to Complete

Instant Clone ⓘ

View Composer Linked Clones ⓘ

Full Virtual Machines ⓘ

vCenter Server

10.10.70.29

Description

Cancel Previous Next

3. Select the User assignment to be used by the desktop pool. Click Next.

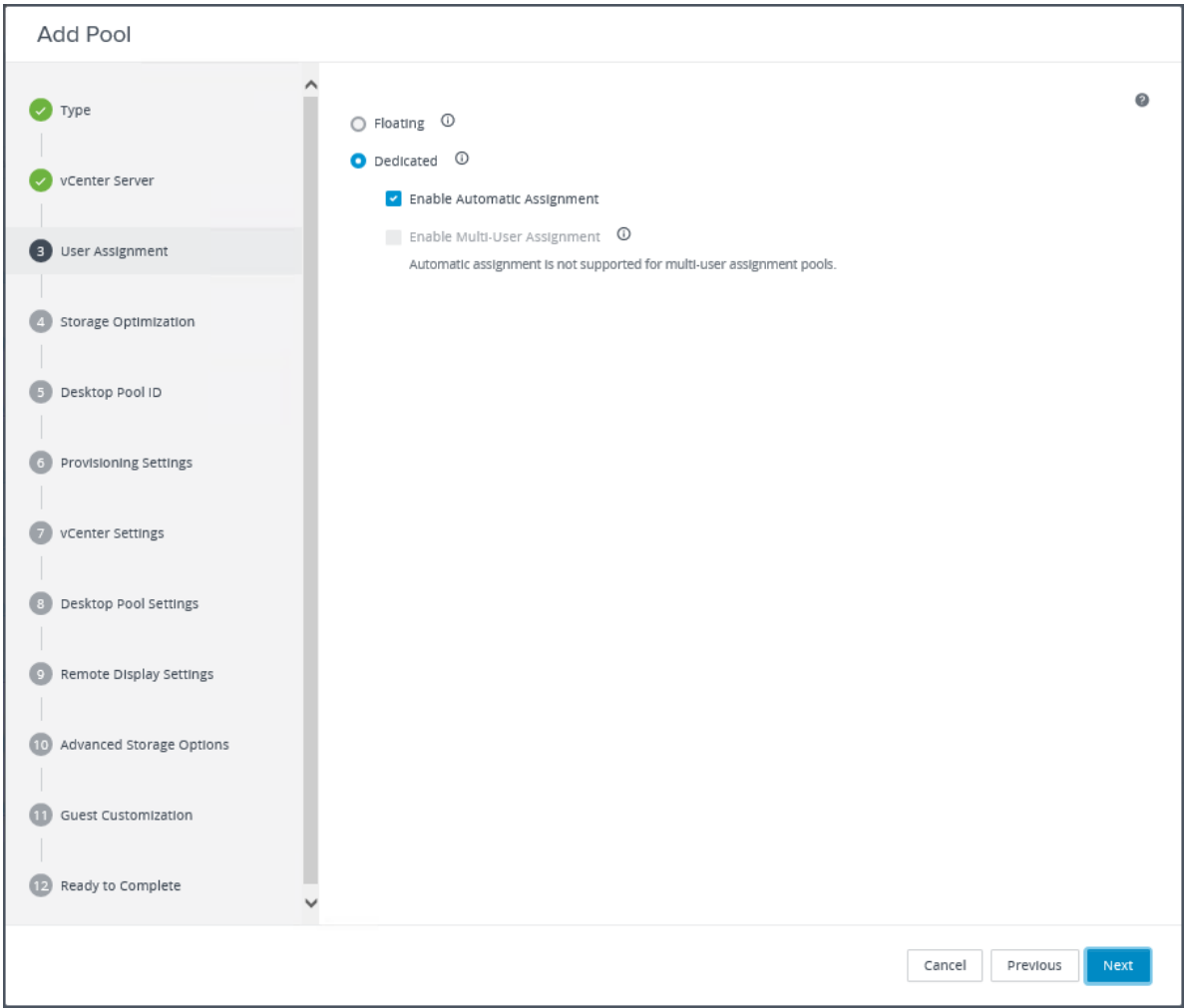

4. On Storage Optimization screen click Next.

**Add Pool**

- ✓ Type
- ✓ vCenter Server
- ✓ User Assignment
- 4 Storage Optimization**
- 5 Desktop Pool ID
- 6 Provisioning Settings
- 7 vCenter Settings
- 8 Desktop Pool Settings
- 9 Remote Display Settings
- 10 Advanced Storage Options
- 11 Guest Customization
- 12 Ready to Complete

### Storage Policy Management ⓘ

Use VMware Virtual SAN

Do not use VMware Virtual SAN

▲ Virtual SAN is not available because no Virtual SAN datastores are configured.

Cancel Previous **Next**

5. Provide the Desktop Pool ID and Display Name. Click Next.

### Add Pool - W10-FULL

- ✓ Type
- ✓ vCenter Server
- ✓ User Assignment
- ✓ Storage Optimization
- 5 Desktop Pool ID**
- 6 Provisioning Settings
- 7 vCenter Settings
- 8 Desktop Pool Settings
- 9 Remote Display Settings
- 10 Advanced Storage Options
- 11 Guest Customization
- 12 Ready to Complete

• ID ⓘ

Display Name ⓘ

Access Group ⓘ

Description

Cancel Previous **Next**

6. Provide the naming pattern and the number of desktops to be provisioned. Click Next.



In this validated design for VDI pools we used:  
Single Server pool - 186  
Cluster pool - 1674



### Add Pool - W10\_FULL

- ✔ Type
- ✔ vCenter Server
- ✔ User Assignment
- ✔ Storage Optimization
- ✔ Desktop Pool ID
- 6 Provisioning Settings
- 7 vCenter Settings
- 8 Desktop Pool Settings
- 9 Remote Display Settings
- 10 Advanced Storage Options
- 11 Guest Customization
- 12 Ready to Complete

**Basic**

Enable Provisioning

Stop Provisioning on Error

---

**Virtual Machine Naming** ⓘ

Specify Names Manually

0 names entered Enter Names

Start machines in maintenance mode

# Unassigned Machines Kept Powered On

Use a Naming Pattern ⓘ

\* Naming Pattern

---

**Provision Machines**

Machines on Demand

Min Number of Machines

All Machines Up-Front

---

**Desktop Pool Sizing**

\* Max Number of Machines

\* Number of Spare (Powered On) Machines

Cancel
Previous
Next

7. Provide the parent VM, snapshot and host/cluster info, data store information for the virtual machines to create.



A single datastore was used per 10 host pools.

Add Pool - W10\_FULL

- Type
- vCenter Server
- User Assignment
- Storage Optimization
- Desktop Pool ID
- Provisioning Settings
- 7 vCenter Settings**
- 8 Desktop Pool Settings
- 9 Remote Display Settings
- 10 Advanced Storage Options
- 11 Guest Customization
- 12 Ready to Complete

**Virtual Machine Template**

\* Template  
/FlashStack/vm/W10-FULL/W10-FC-Base

**Virtual Machine Location**

\* VM Folder Location  
/FlashStack/vm

**Resource Settings**

\* Host or Cluster  
/FlashStack/host/CL-FULL

\* Resource Pool  
/FlashStack/host/CL-FULL/Resources

\* Datastores  
1 selected

8. Configure Desktop Pool settings.

### Add Pool - W10\_FULL

- Type
- vCenter Server
- User Assignment
- Storage Optimization
- Desktop Pool ID
- Provisioning Settings
- vCenter Settings
- 8 Desktop Pool Settings**
- 9 Remote Display Settings
- 10 Advanced Storage Options
- 11 Guest Customization
- 12 Ready to Complete

State: Enabled

Connection Server Restrictions: None

Category Folder: None

Session Types: Desktop

Remote Machine Power Policy: Take no power action

Automatically Logoff After Disconnect: Never

Allow Users to Restart/Reset Their Machines: No

Display Assigned Machine Name

9. Provide the customizations to be used during the desktop deployment.



PCoIP Display protocol was used for the VDI pools in the this validated design.

### Add Pool - W10\_FULL

- Type
- vCenter Server
- User Assignment
- Storage Optimization
- Desktop Pool ID
- Provisioning Settings
- vCenter Settings
- Desktop Pool Settings
- 9 Remote Display Settings**
- 10 Advanced Storage Options
- 11 Guest Customization
- 12 Ready to Complete

#### Remote Display Protocol

Default Display Protocol  
PCoIP

Allow Users to Choose Protocol  
Yes

3D Renderer  
Disabled

VRAM Size  
96 MB  
More VRAM can improve 3D performance.

Max number of monitors  
2

Max Resolution of Any One Monitor  
1920x1200

HTML Access  Enabled

Requires installation of HTML Access.

Allow Session Collaboration  Enabled

Requires VMware Blast Protocol.

Cancel Previous **Next**

10. Configure Advanced Storage Options. Click Next.

### Add Pool - W10\_FULL

- Type
- vCenter Server
- User Assignment
- Storage Optimization
- Desktop Pool ID
- Provisioning Settings
- vCenter Settings
- Desktop Pool Settings
- Remote Display Settings
- 10 Advanced Storage Options**
- 11 Guest Customization
- 12 Ready to Complete

#### Advanced Storage Options ⓘ

The following features are recommended based on your resource selection. Options that are not supported by the selected hardware are disabled.

Use View Storage Accelerator

Regenerate Storage Accelerator After  
 Days

#### Blackout Times

Storage accelerator regeneration and VM disk space reclamation do not occur during blackout times. The same blackout policy applies to both operations.

Day	Time
No records available.	

Transparent Page Sharing Scope

11. Select the VM Customization Specification to be used during deployment. Click Next.

### Add Pool - W10\_FULL

- Type
- vCenter Server
- User Assignment
- Storage Optimization
- Desktop Pool ID
- Provisioning Settings
- vCenter Settings
- Desktop Pool Settings
- Remote Display Settings
- Advanced Storage Options
- 11 Guest Customization**
- 12 Ready to Complete

None - Customization will be done manually

Do not Power on Virtual Machines After Creation

Use this customization specification

Allow Reuse of Pre-Existing Computer Accounts

Name	Guest OS	Description
Infra	Windows	
Win10-FC	Windows	Full Clone desktops
windows	Windows	
WS2019	Windows	

Cancel Previous **Next**

12. Review all the deployment specifications and click Submit to complete the deployment.

### Add Pool - W10\_FULL

- ✔ Type
- ✔ vCenter Server
- ✔ User Assignment
- ✔ Storage Optimization
- ✔ Desktop Pool ID
- ✔ Provisioning Settings
- ✔ vCenter Settings
- ✔ Desktop Pool Settings
- ✔ Remote Display Settings
- ✔ Advanced Storage Options
- ✔ Guest Customization
- 12 Ready to Complete

Entitle Users After Adding Pool
 ?

Type	Automated Desktop Pool
User Assignment	Dedicated Assignment
Assign on First Login	Yes
Enable Multi-User Assignment	No
vCenter Server	10.10.70.29
Unique ID	W10_FULL
Description	-
Display Name	W10-FULL
Access Group	/
Desktop Pool State	Enabled
Session Types	Desktop
Display Assigned Machine Name	No
Remote Machine Power Policy	Take no power action
Automatically Logoff After Disconnect	Never
Connection Server Restrictions	None
Category Folder	None

## Create RDSH Farm and Pool

It is recommended to create a RDSH Farm first with specifications set for RDS Server VMs and deploying a number of RDS servers required for users.



Full Clones provisioned with PowerCLI were used for RDS Virtual Machines.

## Create RDS Farm

To create the RDSH Farm and Pool, follow these steps:

1. Select the FARM when creating the RDS Pool.



You can entitle the user access at the RDS Pool level for RDS users/groups who can access the RDS VMs.

2. Select Type of the Farm. We used Manual Farm of the previously provisioned virtual machines for the RDS desktops in this design. Click Next.

The screenshot shows a wizard titled "Add Farm" with a progress indicator on the left side. The progress indicator consists of five steps: 1. Type, 2. Identification and Settings, 3. Load Balancing Settings, 4. Select RDS Hosts, and 5. Ready to Complete. Step 1 is currently active. In the main content area, there are two radio button options: "Automated Farm" (unselected) and "Manual Farm" (selected). Both options have a help icon to their right. At the bottom right of the wizard, there are three buttons: "Cancel", "Previous" (disabled), and "Next" (active).

3. Provide ID and Description for RDS FARM. Select the Display Protocol which is required for users to connect to the RDS Sessions. Click Next.



### Add Farm - RDS-2

- 1 Type
- 2 Identification and Settings
- 3 Load Balancing Settings
- 4 Select RDS Hosts
- 5 Ready to Complete

\* ID  
RDS-2

Description

Access Group  
/

Farm Settings

Default Display Protocol ⓘ  
Microsoft RDP

Allow Users to Choose Protocol  
Yes

Pre-launch Session Timeout (Applications Only) ⓘ  
After 10 minutes

Empty Session Timeout (Applications Only) ⓘ  
After 1 minutes

Cancel Previous Next

4. Select Load Balancing Settings. Click Next.

### Add Farm - RDS-2

- 1 Type
- 2 Identification and Settings
- 3 Load Balancing Settings
- 4 Select RDS Hosts
- 5 Ready to Complete

Use Custom Script  Enabled ⓘ

Include Session Count  Enabled ⓘ

\* CPU Usage Threshold ⓘ

\* Memory Usage Threshold ⓘ

\* Disk Queue Length Threshold ⓘ

\* Disk Read Latency Threshold ⓘ

\* Disk Write Latency Threshold ⓘ

Cancel Previous Next

5. Select previously created virtual machine to be used as RDS host. Click Next.

The screenshot shows the 'Add Farm - RDS-2' wizard. On the left, a progress bar indicates the current step is '4 Select RDS Hosts'. The main area is titled 'Select RDS hosts to add to the farm RDS-2' and contains a table with the following data:

<input type="checkbox"/>	DNS Name	Type	Max Number of Conne...	Status
<input type="checkbox"/>	w2019-fc.vccfslab.local	Windows Server 2016	1	Agent Unreachable
<input checked="" type="checkbox"/>	w2019-rds.vccfslab.local	Windows Server 2016	150	Available
<input type="checkbox"/>	win- qeui0v6f6ak.vccfslab.loc al	Windows Server 2016	30	Agent Unreachable

At the bottom right, there are three buttons: 'Cancel', 'Previous', and 'Next'.

6. Review Farm information and click Submit to complete the RDS Farm creation.

### Add Farm - RDS-2

- ✔ Type
- ✔ Identification and Settings
- ✔ Load Balancing Settings
- ✔ Select RDS Hosts
- 5 Ready to Complete

ID	RDS-2
Description	-
Access Group	/
<hr/>	
<b>Farm Settings</b>	
Default Display Protocol	Microsoft RDP
Allow Users to Choose Protocol	Yes
Pre-launch Session Timeout (Applications Only)	10 minutes
Empty Session Timeout (Applications Only)	1 minute
When Timeout Occurs	Disconnect
Logoff Disconnected Sessions	Never
Allow HTML Access to Desktops and Applications on this Farm	Disabled
Allow Session Collaboration	Disabled

Cancel
Previous
Submit

### Create RDS Pool

When the RDS FARM is created, you need to create an RDS pool to absorb the RDS VMS FARM into the Pool for further managing the RDS pool. To create c RDS pool, follow these steps:

1. Select type as RDS Desktop Pool.

**Add Pool**

1 Type

2 Desktop Pool ID

3 Desktop Pool Settings

4 Select RDS Farms

5 Ready to Complete

Automated Desktop Pool ⓘ

Manual Desktop Pool ⓘ

RDS Desktop Pool ⓘ

Cancel Previous Next

2. Provide an ID and Display Name for the Pool. Click Next.

**Add Pool - RDSPool**

1 Type

2 Desktop Pool ID

3 Desktop Pool Settings

4 Select RDS Farms

5 Ready to Complete

ID 

RDSPool

Display Name 

RDSPool

Description

Cancel Previous **Next**

3. Leave the default settings for the Desktop Pool Settings. Click Next.

### Add Pool - RDSPool

- ✓ Type
- ✓ Desktop Pool ID
- 3 Desktop Pool Settings
- 4 Select RDS Farms
- 5 Ready to Complete

State ?  
Enabled

Connection Server Restrictions  
None

Category Folder  
None

Client Restrictions  Enabled

Allow Users to Initiate separate Desktop sessions from different client devices (desktops only)  
No ?

4. Select the RDS Farm. Select the farm which was already created for this desktop pool. Click Next.

### Add Pool - RDSPool

Progress: Type, Desktop Pool ID, Desktop Pool Settings, **4 Select RDS Farms**, 5 Ready to Complete

Create a new RDS farm  
 Select an RDS farm for this desktop pool

Filter

Farm ID	Description	RDS Hosts	Max Number of Co...	Status
RDS2019		2	2	Farm disabled

Buttons: Cancel, Previous, Next

5. Review the RDS Pool deployment specifications and click Finish to complete the RDS pool deployment.

### Add Pool - RDSPool

- ✓ Type
- ✓ Desktop Pool ID
- ✓ Desktop Pool Settings
- ✓ Select RDS Farms
- 5 Ready to Complete

Entitle Users After Adding Pool

Type	RDS Desktop Pool
Unique ID	RDSPool
Description	-
Display Name	RDSPool
Desktop Pool State	Enabled
Client Restrictions	No
Connection Server Restrictions	None
Category Folder	None
Allow Users to initiate separate Desktop sessions from different client devices (desktops only)	No
RDS Farm	RDS2019
Number of RDS Hosts in the Farm	2

6. Select Entitle users after this wizard finishes, to enable desktop user group/users to access this pool.

### Configure User Profile Management

Profile management provides an easy, reliable, and high-performance way to manage user personalization settings in virtualized or physical Windows environments. It requires minimal infrastructure and administration and provides users with fast logons and logoffs. A Windows user profile is a collection of folders, files, registry settings, and configuration settings that define the environment for a user who logs on with a particular user account. These settings may be customizable by the user, depending on the administrative configuration. Examples of settings that can be customized are:

- Desktop settings such as wallpaper and screen saver
- Shortcuts and Start menu setting
- Internet Explorer Favorites and Home Page
- Microsoft Outlook signature
- Printers



Some user settings and data can be redirected by means of folder redirection. However, if folder redirection is not used these settings are stored within the user profile.

The first stage in planning a profile management deployment is to decide on a set of policy settings that together form a suitable configuration for your environment and users. The automatic configuration feature simplifies some of this decision-making for VMware Horizon desktop deployments. Screenshots of the User Profile Management interfaces that establish policies for this CVD's RDS and VDI users (for testing purposes) are shown below. Basic profile management policy settings are documented here.

### Initial Configuration (Easy Start)

To perform an initial configuration of Dynamic Environment Manager, follow these steps:

1. Launch the DEM Management Console from the Start Menu.

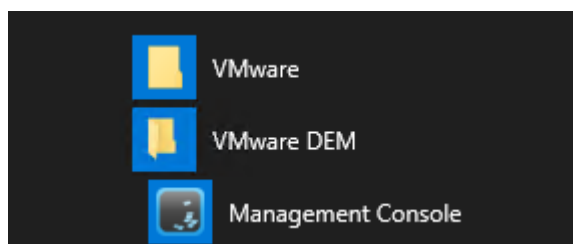

2. Enter the path to the DEM configuration share and click OK.



In this validated design the DEM configuration and user profiles were stored on the share hosted by Pure Storage FlashArray//X70 R3.

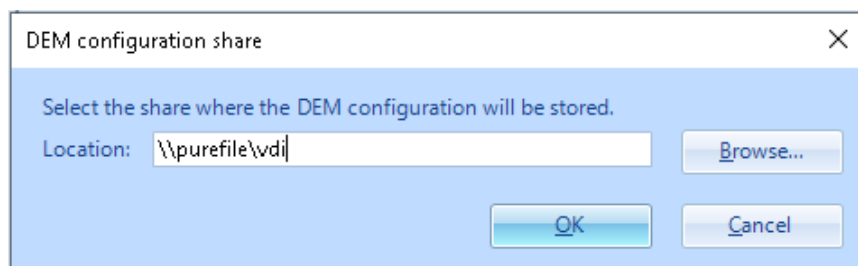

3. Leave the defaults and click OK.

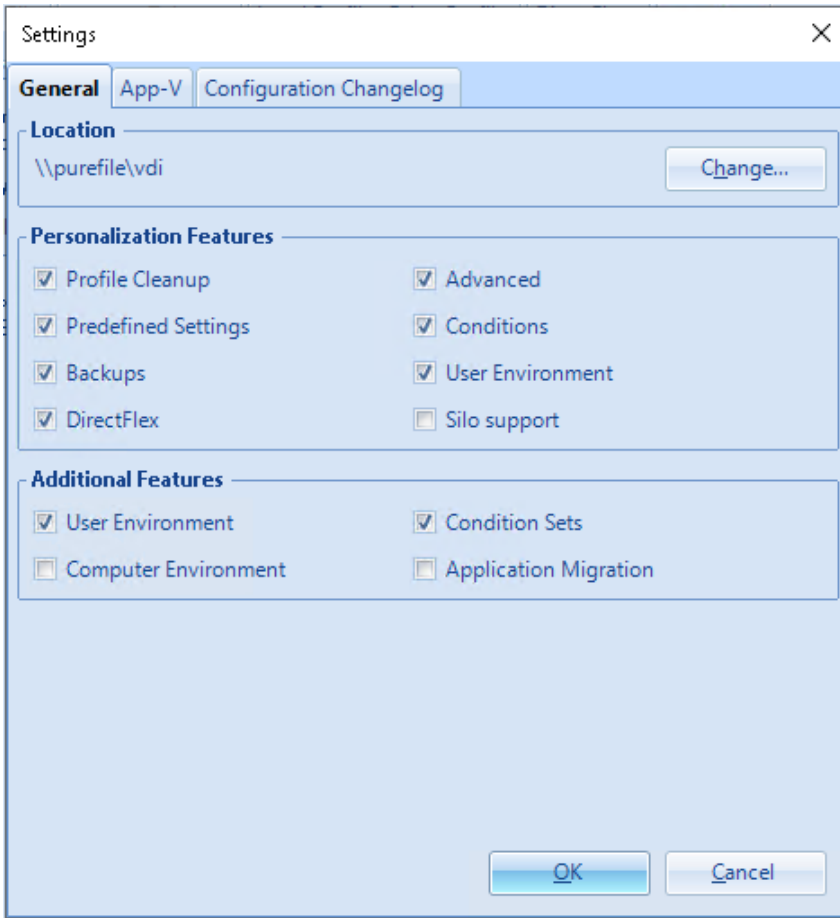

4. On Personalization tab of the Management Console, click Easy Start.

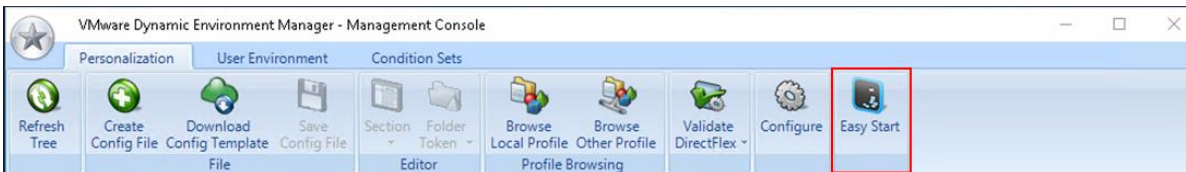

5. Select your Office version and click OK.

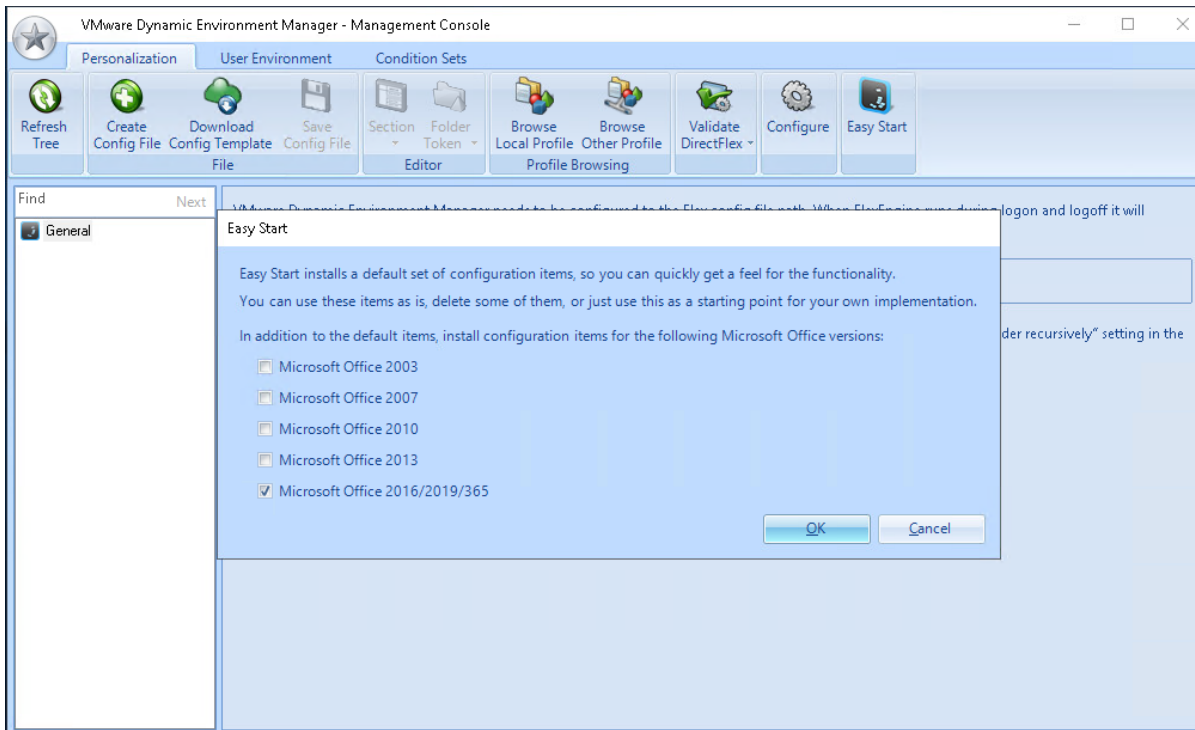

6. When configuration items successfully installed click OK.

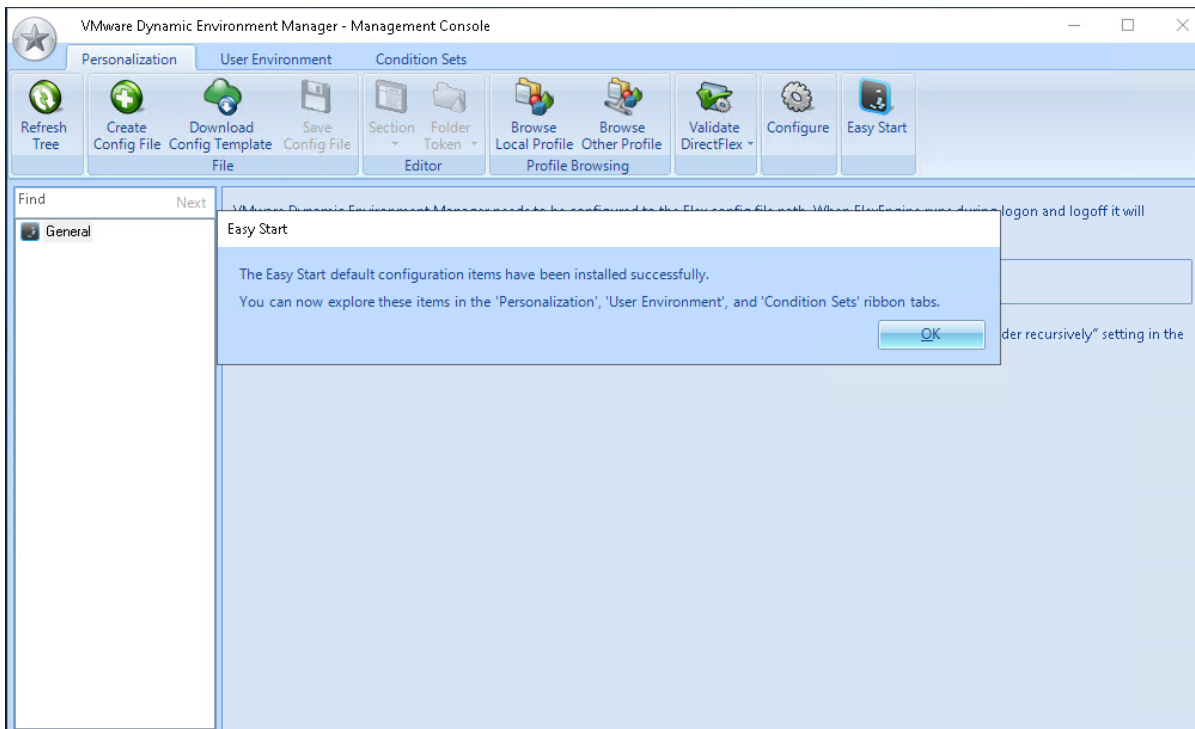

7. Click Personalization tab, click + Create Config File, select Use a Windows Common Setting and click Next.

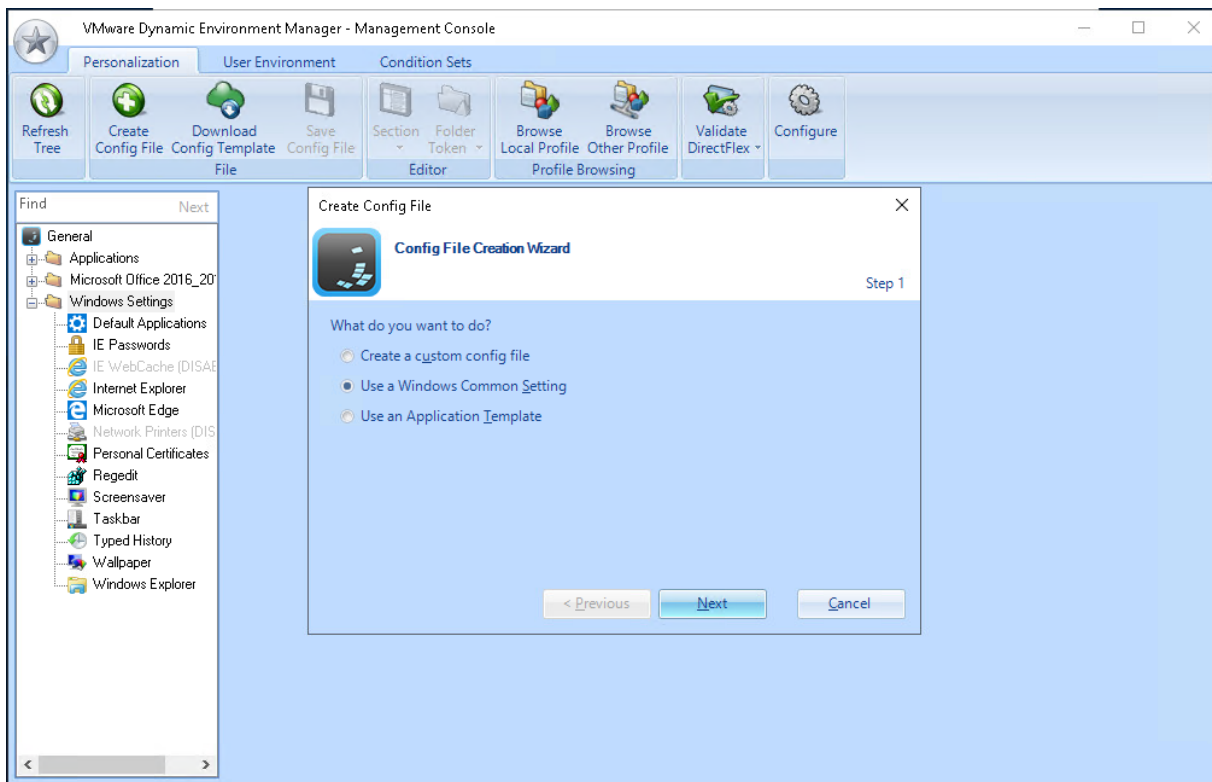

8. Select Windows 10 Start Menu - Windows 10 Version 1703 and higher and click Next.

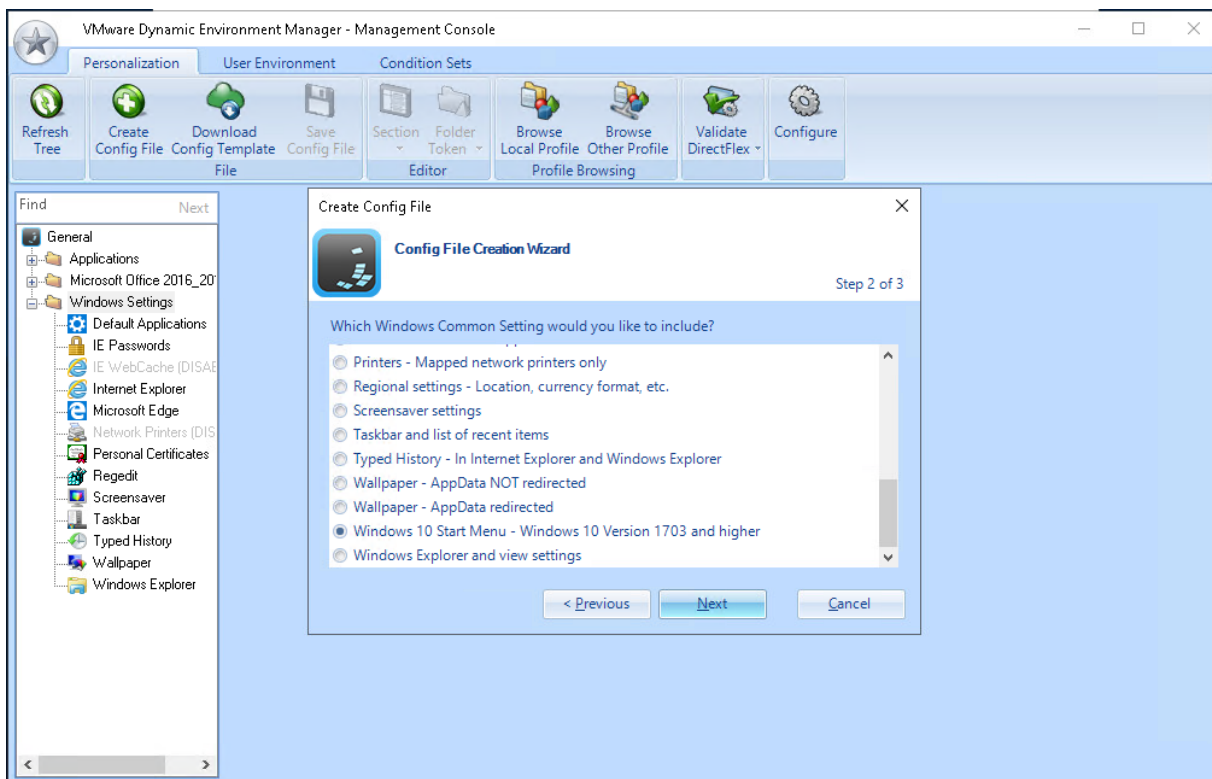

9. Enter a file name and click Finish to create configuration.

## Install and Configure NVIDIA P6 Card

This section focuses on installing and configuring the NVIDIA P6 cards with the Cisco UCS B200 M5 servers to deploy vGPU enabled virtual desktops.

### Physical Installation of P6 Card into Cisco UCS B200 M5 Server

The NVIDIA P6 graphics processing unit (GPU) card provides graphics and computing capabilities to the server. There are two supported versions of the NVIDIA P6 GPU card:

- UCSB-GPU-P6-F can be installed only in the front mezzanine slot of the server



No front mezzanine cards can be installed when the server has CPUs greater than 165 W.

- UCSB-GPU-P6-R can be installed only in the rear mezzanine slot (slot 2) of the server.

[Figure 48](#) illustrates the installed NVIDIA P6 GPU in the front and rear mezzanine slots.

**Figure 48. NVIDIA GPU Installed in the Front and Rear Mezzanine Slots**

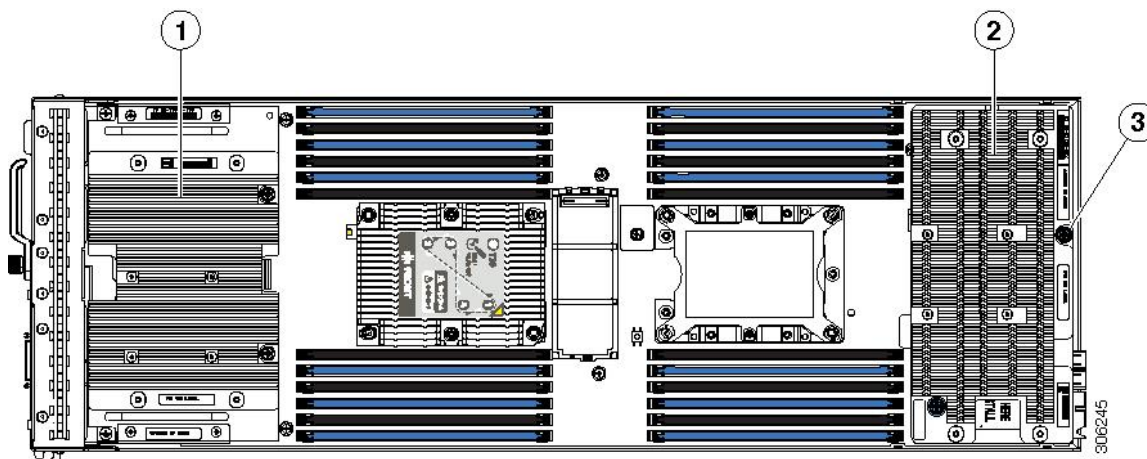

1	Front GPU	2	Rear GPU
3	Custom standoff screw	-	

### Install an NVIDIA GPU Card in the Front of the Server

[Figure 49](#) illustrates the front NVIDIA P6 GPU (UCSB-GPU-P6-F).

**Figure 49. NVIDIA P6 GPU That Installs in the Front of the Server**

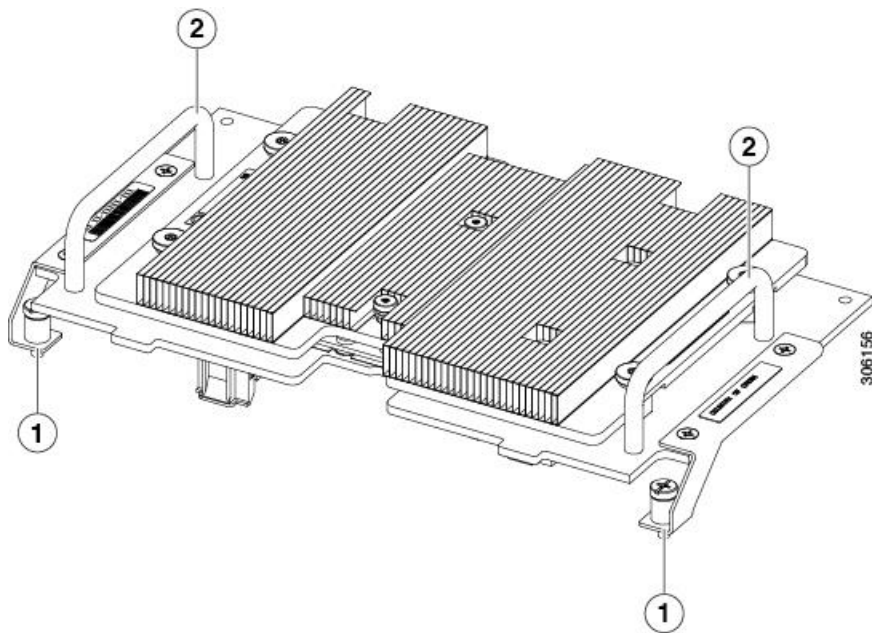

1	Leg with thumb screw that attaches to the server motherboard at the front	2	Handle to press down on when installing the GPU
---	---	---	---

**Figure 50. Top-Down View of the NVIDIA P6 GPU for the Front of the Server**

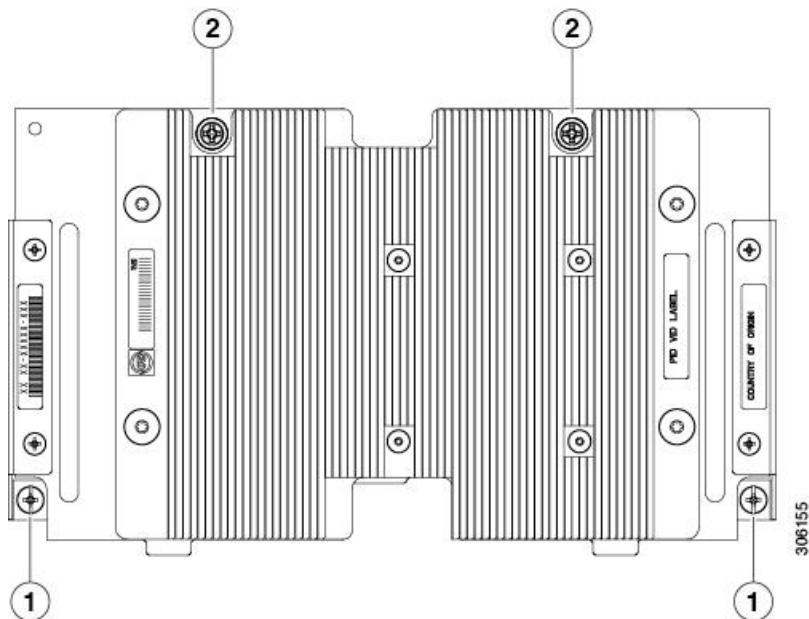

1	Leg with thumb screw that attaches to the server motherboard	2	Thumb screw that attaches to a standoff below
---	--	---	---

To install the NVIDIA GPU, follow these steps:



---

Before installing the NVIDIA P6 GPU (UCSB-GPU-P6-F) in the front mezzanine slot you need to upgrade the Cisco UCS domain that the GPU will be installed into to a version of Cisco UCS Manager that supports this card. Refer to the latest version of the Release Notes for Cisco UCS Software at the following URL for information about supported hardware: <http://www.cisco.com/c/en/us/support/servers-unified-computing/ucs-manager/products-release-notes-list.html>. Remove the front mezzanine storage module if it is present. You cannot use the storage module in the front mezzanine slot when the NVIDIA P6 GPU is installed in the front of the server.

---

1. Position the GPU in the correct orientation to the front of the server (callout 1) as shown in [Figure 51](#).
2. Install the GPU into the server. Press down on the handles (callout 5) to firmly secure the GPU.
3. Tighten the thumb screws (callout 3) at the back of the GPU with the standoffs (callout 4) on the motherboard.
4. Tighten the thumb screws on the legs (callout 2) to the motherboard.
5. Install the drive blanking panels.



Figure 51. Installing the NVIDIA GPU in the Front of the Server

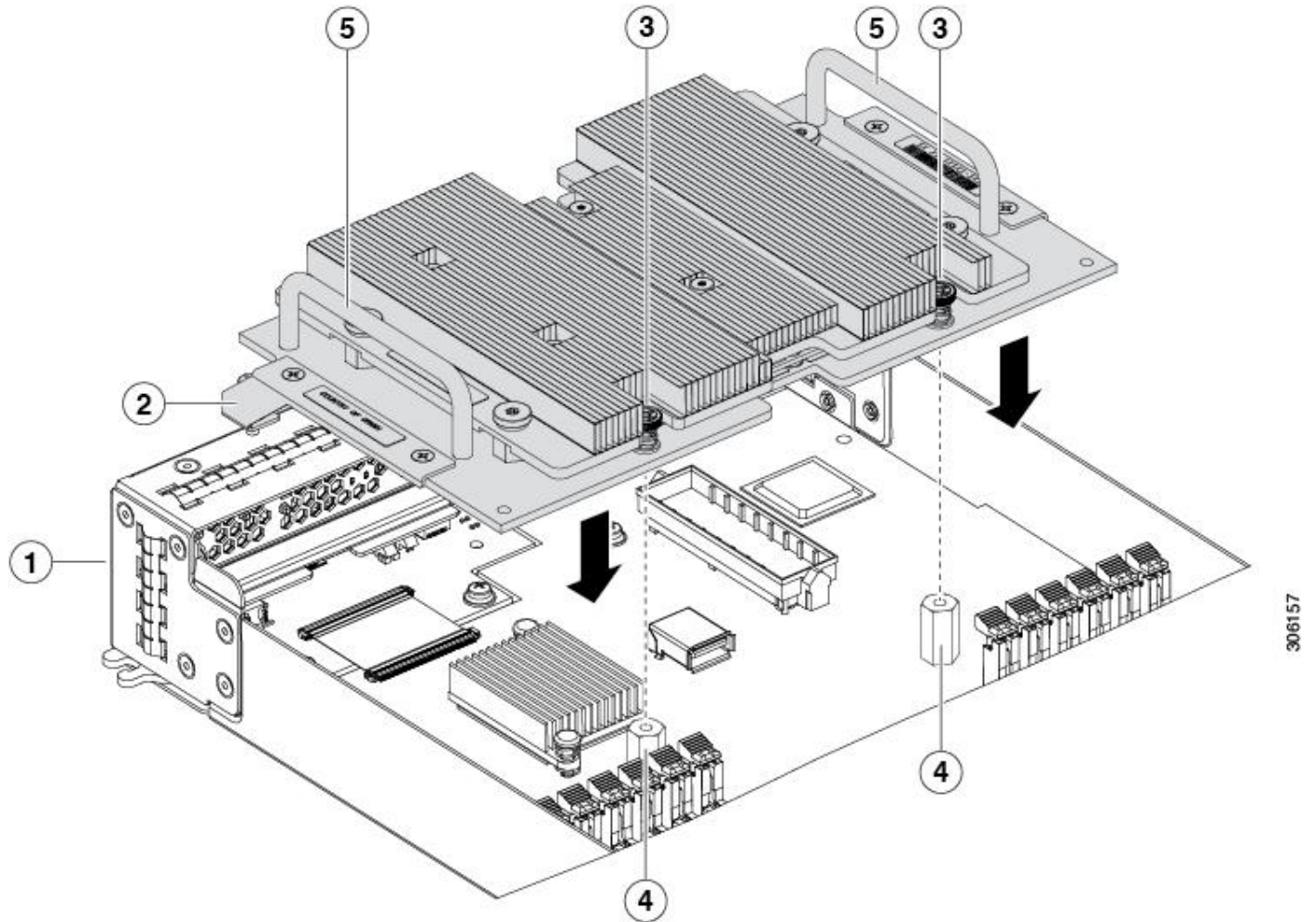

1	Front of the server	2	Leg with thumb screw that attaches to the motherboard
3	Thumbscrew to attach to standoff below	4	Standoff on the motherboard
5	Handle to press down on to firmly install the GPU	-	

### Install an NVIDIA GPU Card in the Rear of the Server

If you are installing the UCSB-GPU-P6-R to a server in the field, the option kit comes with the GPU itself (GPU and heatsink), a T-shaped installation wrench, and a custom standoff to support and attach the GPU to the motherboard. [Figure 52](#) shows the three components of the option kit.



Figure 52. NVIDIA P6 GPU (UCSB-GPU-P6-R) Option Kit

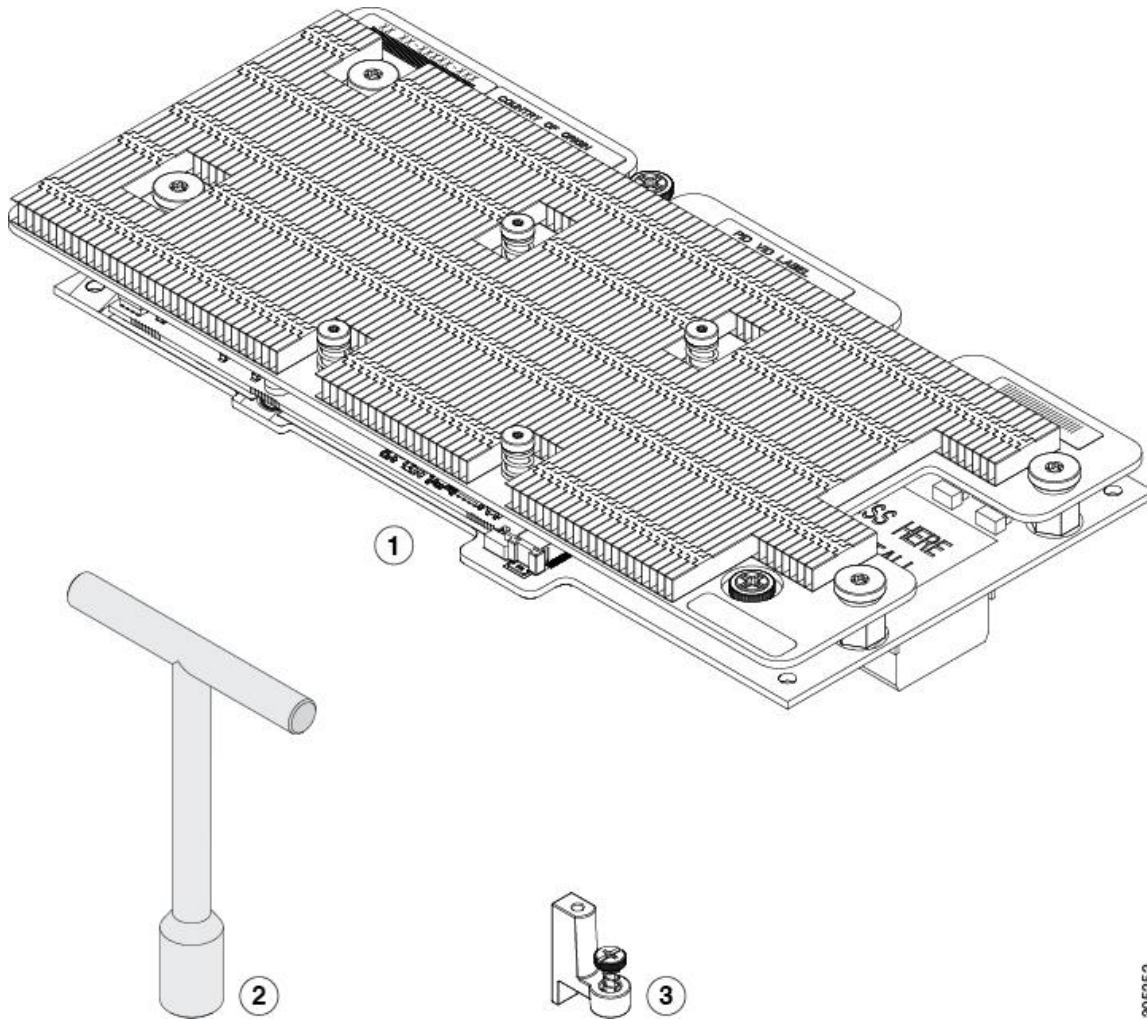

1	NVIDIA P6 GPU (CPU and heatsink)	2	T-shaped wrench
3	Custom standoff	-	



Before installing the NVIDIA P6 GPU (UCSB-GPU-P6-R) in the rear mezzanine slot, you need to Upgrade the Cisco UCS domain that the GPU will be installed into to a version of Cisco UCS Manager that supports this card. Refer to the latest version of the *Release Notes for Cisco UCS Software* at the following URL for information about supported hardware: <http://www.cisco.com/c/en/us/support/servers-unified-computing/ucs-manager/products-release-notes-list.html>. Remove any other card, such as a VIC 1480, VIC 1380, or VIC port expander card from the rear mezzanine slot. You cannot use any other card in the rear mezzanine slot when the NVIDIA P6 GPU is installed.

To install an NVIDIA GPU Card in the rear of the server, follow these steps:

1. Use the T-shaped wrench that comes with the GPU to remove the existing standoff at the back end of the motherboard.

2. Install the custom standoff in the same location at the back end of the motherboard.
3. Position the GPU over the connector on the motherboard and align all the captive screws to the standoff posts (callout 1).
4. Tighten the captive screws (callout 2).

**Figure 53. Installing the NVIDIA P6 GPU in the Rear Mezzanine Slot**

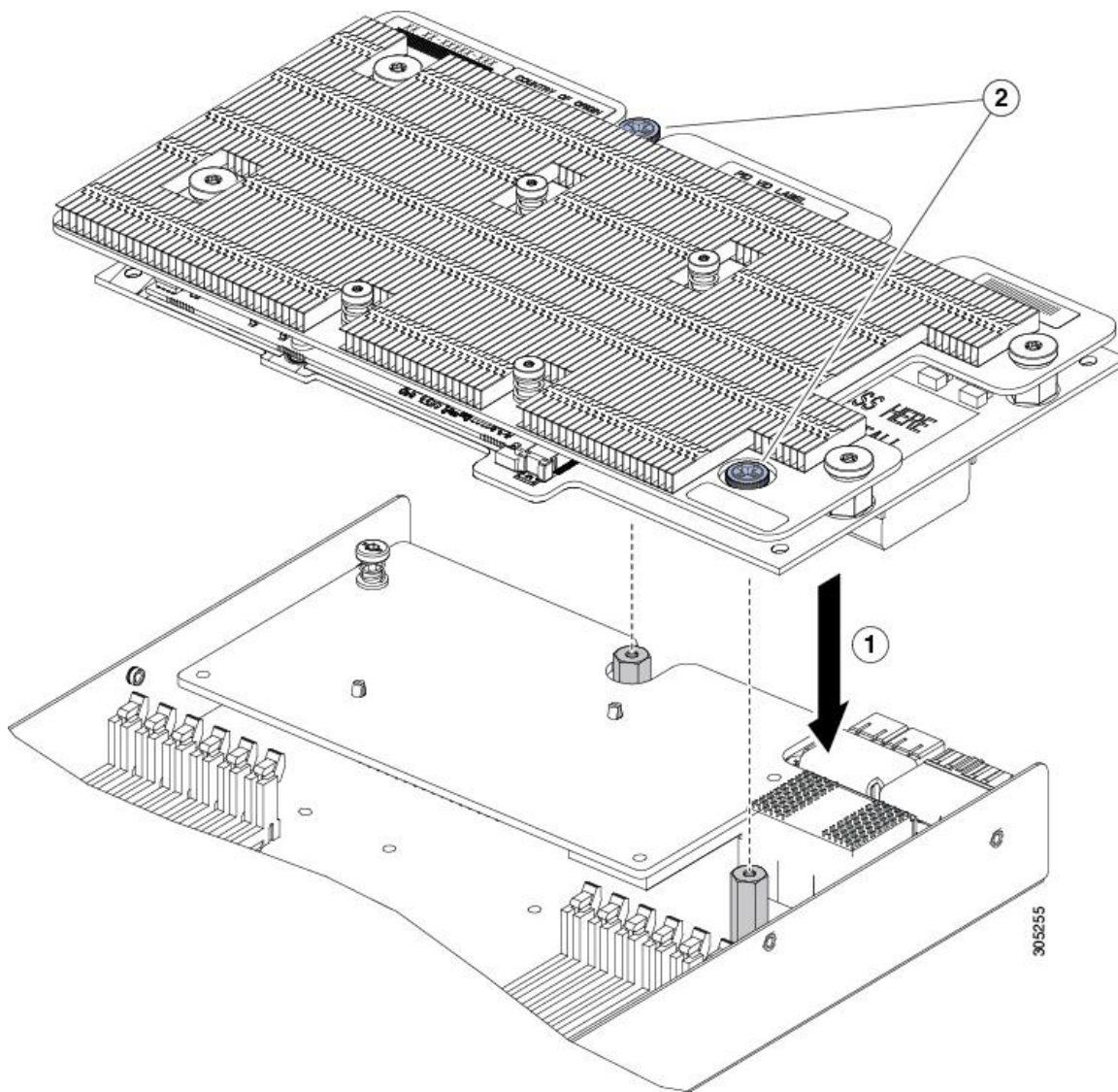

### **Install the NVIDIA VMware VIB Driver**

To install the NVIDIA VMware VIB driver, follow these steps:

1. From the Cisco UCS Manager, verify the GPU card has been properly installed.

Equipment / Chassis / Chassis 1 / Servers / Server 4

General Inventory Virtual Machines Installed Firmware CIMC Sessions SEL Logs VIF Paths Health Diagnostics Faults Events FSM Statistics Temperatures Power

Motherboard CIMC CPUs GPUs Memory Adapters HBAs NICs iSCSI vNICs Security Storage Persistent Memory

Advanced Filter Export Print

Name	ID	Model	Serial	Mode
Graphics Card 3	3	UCSB-GPU-P6-F	FCH2123745Y	Graphics

- Download the NVIDIA GRID GPU driver pack for VMware vSphere ESXi 7.0.
- Upload the NVIDIA driver (vSphere Installation Bundle [VIB] file) to the /tmp directory on the ESXi host using a tool such as WinSCP. (Shared storage is preferred if you are installing drivers on multiple servers or using the VMware Update Manager.)
- Log in as root to the vSphere console through SSH using a tool such as Putty.



The ESXi host must be in maintenance mode for you to install the VIB module. To place the host in maintenance mode, use the command `esxcli system maintenanceMode set -enable true`.

- Enter the following command to install the NVIDIA vGPU drivers:

```
esxcli software vib install --no-sig-check -v /<path>/<filename>.VIB
```

The command should return output similar to that shown here:

```
# esxcli software vib install --no-sig-check -v /tmp/NVIDIA_bootbank_NVIDIA-
VMware_ESXi_7.0_Host_Driver_450.102-10EM.700.0.0.15525992.vib
Installation Result
  Message: Operation finished successfully.
  Reboot Required: false
  VIBs Installed: NVIDIA_bootbank_NVIDIA-VMware_ESXi_7.0_Host_Driver_450.102-10EM.700.0.0.15525992
  VIBs Removed:
  VIBs Skipped:
```



VIBs Skipped: although the display shows “Reboot Required: false,” a reboot is necessary for the VIB file to load and for xorg to start.

- Exit the ESXi host from maintenance mode and reboot the host by using the vSphere Web Client or by entering the following commands:

```
#esxcli system maintenanceMode set -e false
#reboot
```

- After the host reboots successfully, verify that the kernel module has loaded successfully using the following command:

```
#esxcli software vib list | grep -i nvidia
```

The command should return output similar to that shown here:

```
# esxcli software vib list | grep -i nvidia
```

```
NVIDIA-VMware_ESXi_7.0_Host_Driver 450.102-1OEM.700.0.0.15525992 NVIDIA VMwareAccepted
2021-01-14
```



See the VMware knowledge base article for information about removing any existing NVIDIA drivers before installing new drivers:  
[http://kb.vmware.com/selfservice/microsites/search.do?language=en\\_US&cmd=displayKC&externalId=2033434](http://kb.vmware.com/selfservice/microsites/search.do?language=en_US&cmd=displayKC&externalId=2033434).

8. Confirm GRID GPU detection on the ESXi host. To determine the status of the GPU card's CPU, the card's memory, and the amount of disk space remaining on the card, enter the following command:

```
#nvidia-smi
```

The command should return output similar to that shown in [Figure 54](#), depending on the card used in your environment.

**Figure 54. VMware ESX SSH Console Report for GPU P6 Card Detection on Cisco UCS B200 M5 Blade Server**

```
[root@D17-WLHost10:~] nvidia-smi
Thu Jan 14 23:15:11 2021
+-----+
| NVIDIA-SMI 450.102      Driver Version: 450.102      CUDA Version: N/A      |
+-----+-----+-----+-----+
| GPU Name      Persistence-M| Bus-Id        Disp.A | Volatile Uncorr. ECC | | |
| Fan  Temp  Perf  Pwr:Usage/Cap|      Memory-Usage | GPU-Util  Compute M. |
|               |              |          |              |      |
+-----+-----+-----+-----+
| 0  Tesla P6    On         | 00000000:18:00.0 Off  |      Off      | | |
| N/A   35C    P8     10W /  90W |  50MiB / 16383MiB |      0%      Default  |
|               |              |          |              |      |
+-----+-----+-----+-----+
| Processes:                                             GPU Memory |
|  GPU   GI    CI          PID    Type   Process name          Usage   |
+-----+-----+-----+-----+
|  0     N/A  N/A     2101104    G     Xorg                   5MiB   |
+-----+-----+-----+-----+
```



The NVIDIA system management interface (SMI) also allows GPU monitoring using the following command: `nvidia-smi -l` (this command adds a loop, automatically refreshing the display).

### Configure a Virtual Machine with a vGPU

To create the virtual machine that you will use as the VDI base image, follow these steps:

1. Using the vSphere Client, select the ESXi host and click the Configure tab. From the list of options at the left, choose Hardware > Graphics > Host Graphics. Click Edit. Select Shared Direct “Vendor shared passthrough graphics” and click OK. Reboot the system to make the changes effective.

Figure 55. Edit Host Graphics Settings

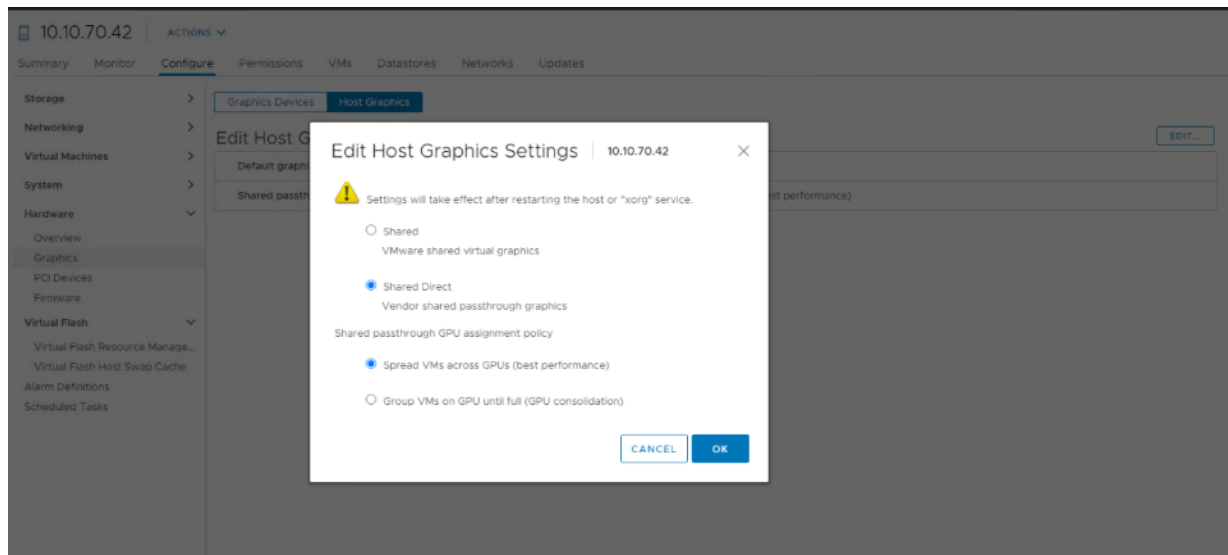

- Using the vSphere Client, create a new virtual machine. To do this, right-click a host or cluster and choose New Virtual Machine. Work through the New Virtual Machine wizard. Unless another configuration is specified, select the configuration settings appropriate for your environment.

Figure 56. New Virtual Machine Wizard in VMware vSphere Client

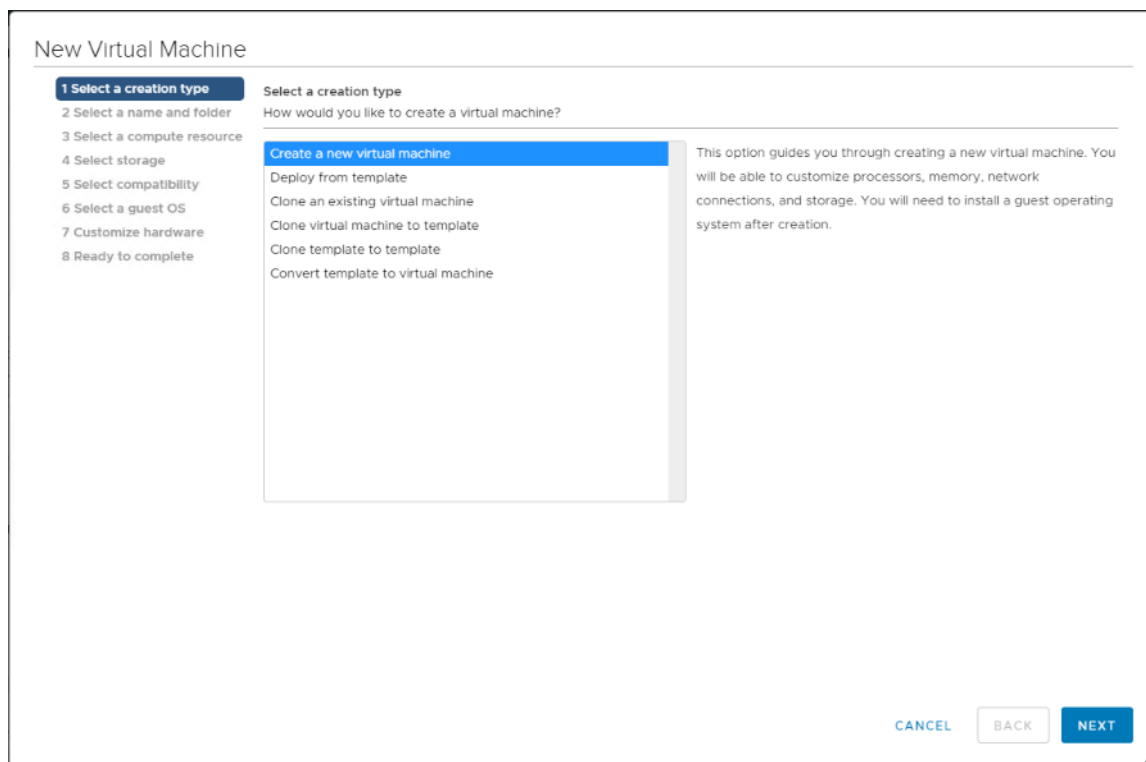

- Choose “ESXi 6.0 and later” from the “Compatible with” drop-down list to use the latest features, including the mapping of shared PCI devices, which is required for the vGPU feature.



This solution uses “ESXi 7.0 and later,” which provides the latest features available in ESXi 7.0 and virtual machine hardware Version 17.

Figure 57. Selecting Virtual Machine Hardware Version 17

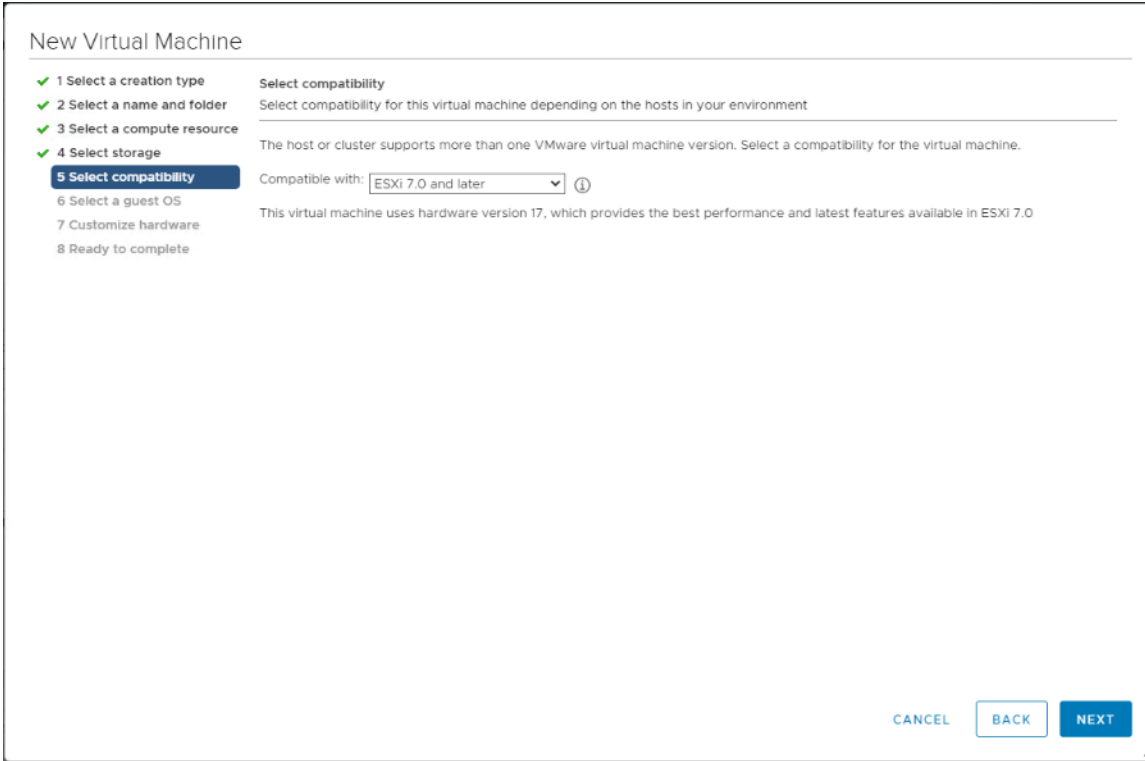

- To customize the hardware of the new virtual machine, add a new PCI device, select the appropriate GPU profile, and reserve all virtual machine memory.



If you are creating a new virtual machine and using the vSphere Client's virtual machine console functions, the mouse will not be usable in the virtual machine until after both the operating system and VMware Tools have been installed. If you cannot use the traditional vSphere Client to connect to the virtual machine, do not enable the NVIDIA GRID vGPU at this time.

Figure 58. Adding a PCI Device to the Virtual Machine to attach the GPU Profile

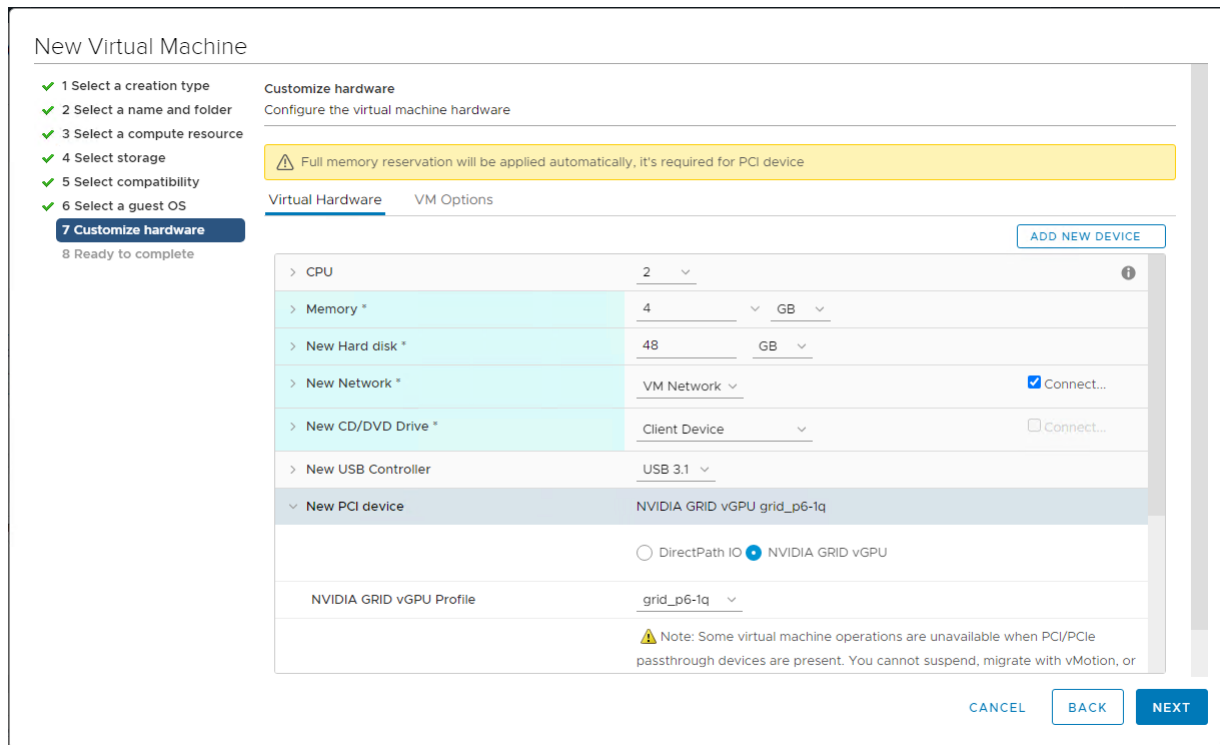

5. A virtual machine with a vGPU assigned will not start if ECC is enabled. If this is the case, as a workaround disable ECC by entering the following commands:

```
# nvidia-smi -e 0
```



Use **-i** to target a specific GPU. If two cards are installed in a server, run the command twice as shown in the example here, where **0** and **1** each specify a GPU card.

6. Install and configure Microsoft Windows on the virtual machine:
  - a. Configure the virtual machine with the appropriate amount of vCPU and RAM according to the GPU profile selected.
  - b. Install VMware Tools.
  - c. Join the virtual machine to the Microsoft Active Directory domain.
  - d. Choose "Allow remote connections to this computer" on the Windows System Properties menu.
  - e. Install VMware Horizon Agent with appropriate settings. Enable the remote desktop capability if prompted to do so.
  - f. Install Horizon Direct Connection agent.
  - g. Optimize the Windows OS. [VMware OSOT](#), the optimization tool, includes customizable templates to enable or disable Windows system services and features using VMware recommendations and best practices across multiple systems. Because most Windows system services are enabled by default, the optimization tool can be used to easily disable unnecessary services and features to improve performance.



- h. Restart the Windows OS when prompted to do so.

### Install the GPU Drivers Inside Windows Virtual Machine

---



It is important to note that the drivers installed with the Windows VDI desktop must match the version that accompanies the driver for the ESXi host. So, if you downgrade or upgrade the ESXi host vib, you must do the same with the NVIDIA driver in your Windows master image.



In this design we used ESXi Host Driver version 450.102 and 452.77 for the Windows VDI image. These drivers come in the same download package from NVIDIA.

---

To install the GPU drivers, follow these steps:

1. Copy the Microsoft Windows drivers from the NVIDIA GRID vGPU driver pack downloaded earlier to the master virtual machine.
2. Copy the 32- or 64-bit NVIDIA Windows driver from the vGPU driver pack to the desktop virtual machine and run setup.exe.

Figure 59. NVIDIA Driver Pack

Name	Date modified	Type	Size
Display.Driver	1/15/2021 11:01 AM	File folder	
Display.Nview	1/15/2021 11:01 AM	File folder	
MSVCRT	1/15/2021 11:01 AM	File folder	
NVI2	1/15/2021 11:01 AM	File folder	
NVWMI	1/15/2021 11:01 AM	File folder	
EULA	7/4/2018 12:40 AM	Text Document	48 KB
setup.cfg	12/29/2020 3:25 AM	CFG File	13 KB
setup	1/5/2021 5:53 AM	Application	503 KB



The vGPU host driver and guest driver versions need to match. **Do not** attempt to use a newer guest driver with an older vGPU host driver or an older guest driver with a newer vGPU host driver. In addition, the vGPU driver from NVIDIA is a different driver than the GPU pass-through driver.

---

3. Agree to the NVIDIA software license.



Figure 60. Agreeing to the NVIDIA Software License



4. Install the graphics drivers using the Express or Custom option. After the installation has completed successfully, restart the virtual machine.



Make sure that remote desktop connections are enabled. After this step, console access may not be available for the virtual machine when you connect from a vSphere Client.

Figure 61. Selecting the Express or Custom Installation Option



Figure 62. Components Installed During NVIDIA Graphics Driver Custom Installation Process

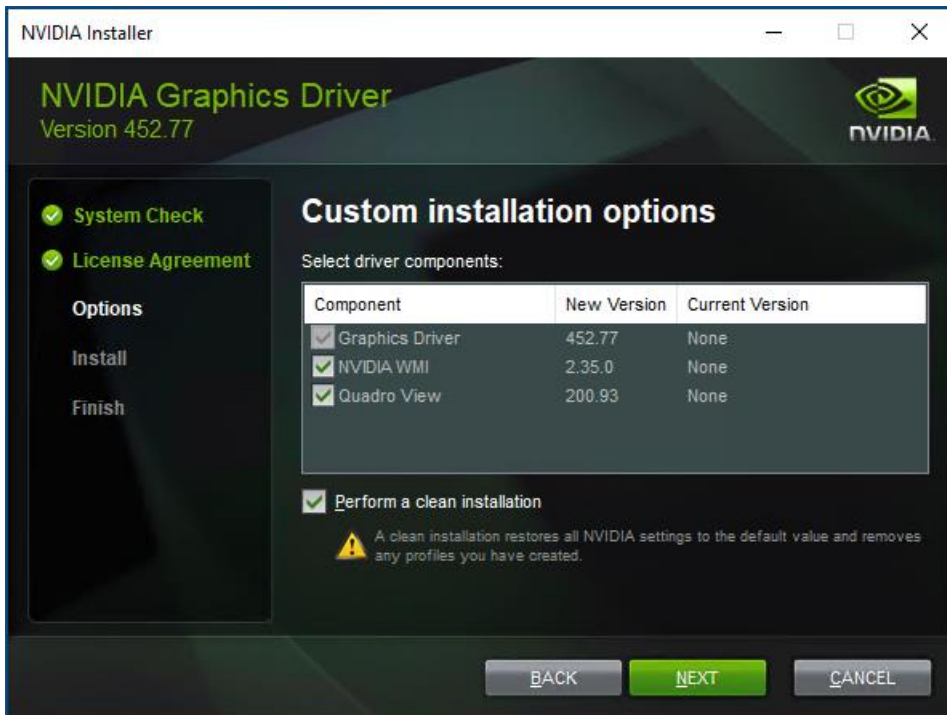
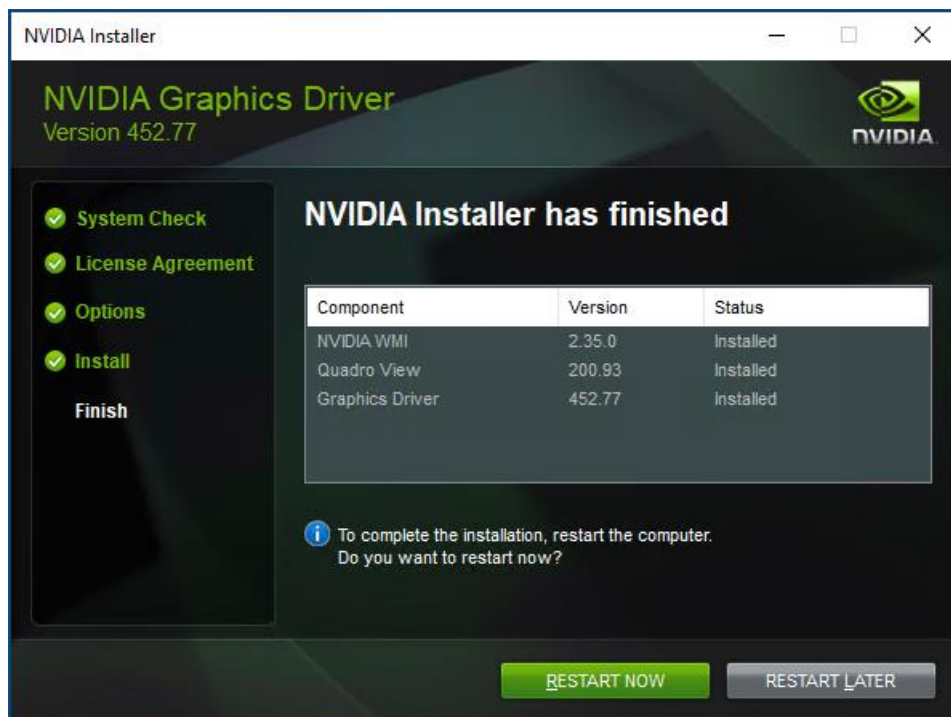

Figure 63. Restarting the Virtual Machine



### Configure NVIDIA Grid License Server on Virtual Machine

When the License server is properly installed, you must point the master image to the license server so the virtual machines with vGPUs can obtain a license. To do so, follow these steps:

1. In the Windows Control Panel, double-click the NVidia Control Panel.



2. In the Control Panel, enter the IP or FQDN of the Grid License Server. You will receive a result similar to the one shown below.

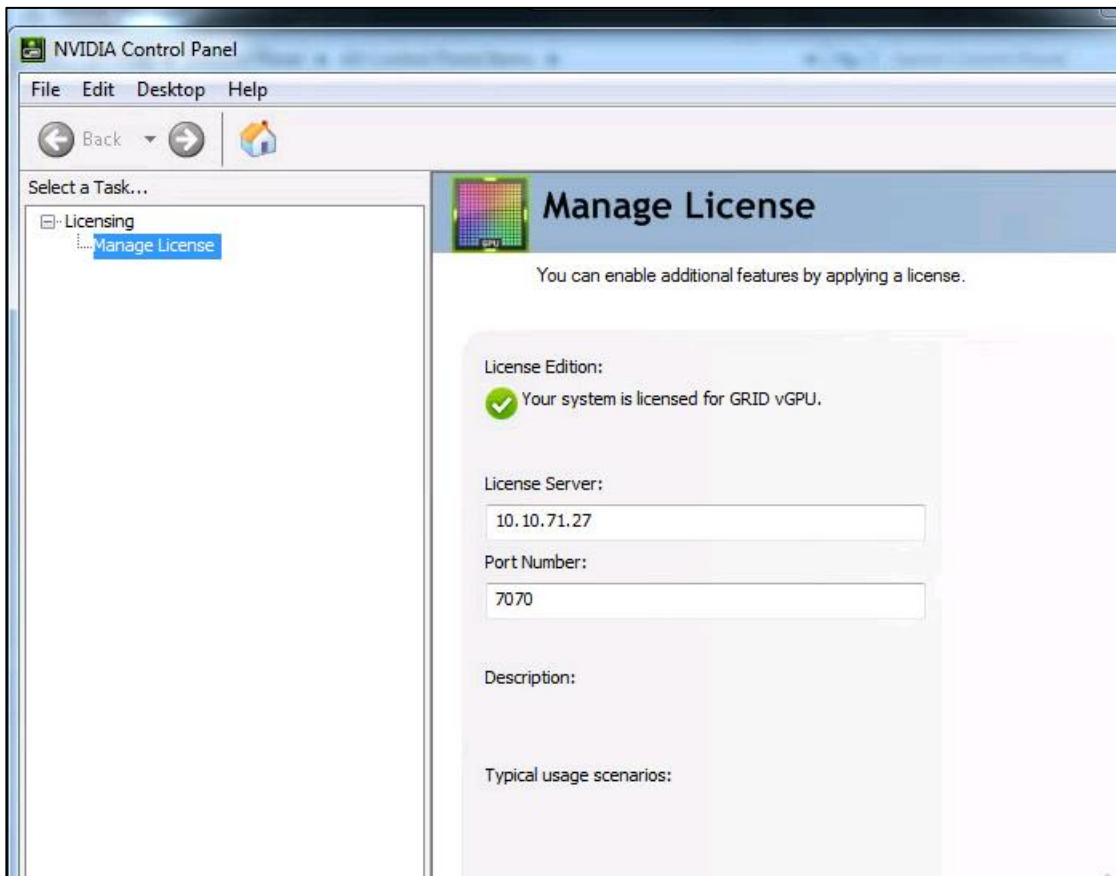

## Cisco Intersight Cloud Based Management

[Cisco Intersight](#) is Cisco's new systems management platform that delivers intuitive computing through cloud-powered intelligence. This platform offers a more intelligent level of management that enables IT organizations to analyze, simplify, and automate their environments in ways that were not possible with prior generations of tools. This capability empowers organizations to achieve significant savings in Total Cost of Ownership (TCO) and to deliver applications faster, so they can support new business initiatives. The advantages of the model-based management of the Cisco UCS platform plus Cisco Intersight are extended to Cisco UCS servers.

The Cisco UCS platform uses model-based management to provision servers and the associated storage and fabric automatically, regardless of form factor. Cisco Intersight works in conjunction with Cisco UCS Manager and the Cisco® Integrated Management Controller (IMC). By simply associating a model-based configuration with a resource through service profiles, your IT staff can consistently align policy, server personality, and workloads. These policies can be created once and used by IT staff with minimal effort to deploy servers. The result is improved productivity and compliance and lower risk of failures due to inconsistent configuration.

Cisco Intersight will be integrated with data center, hybrid cloud platforms, and services to securely deploy and manage infrastructure resources across data center and edge environments. In addition, Cisco will provide future integrations to third-party operations tools to allow customers to use their existing solutions more effectively.

Figure 64. Example of User-Customizable Cisco Intersight Dashboard for FlexPod UCS Domain

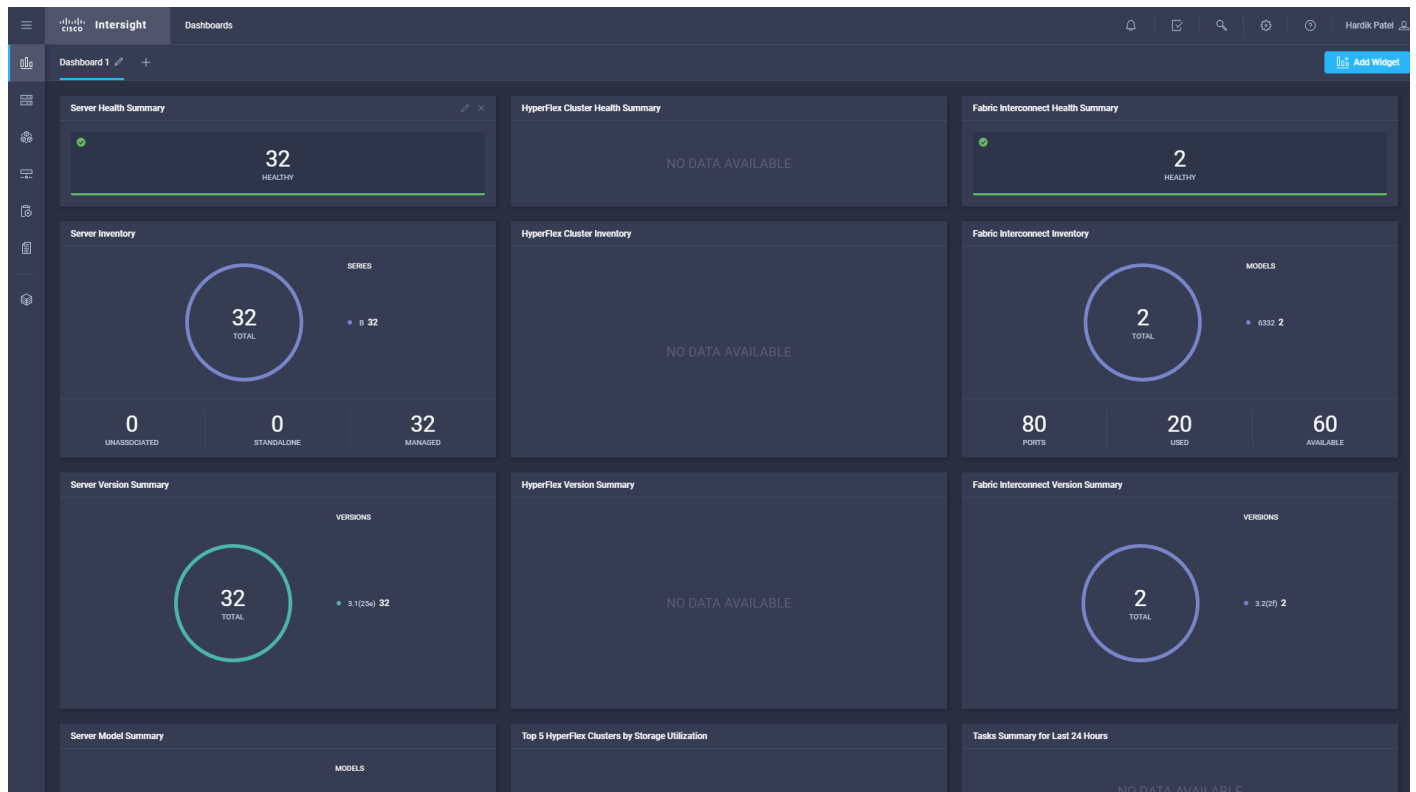
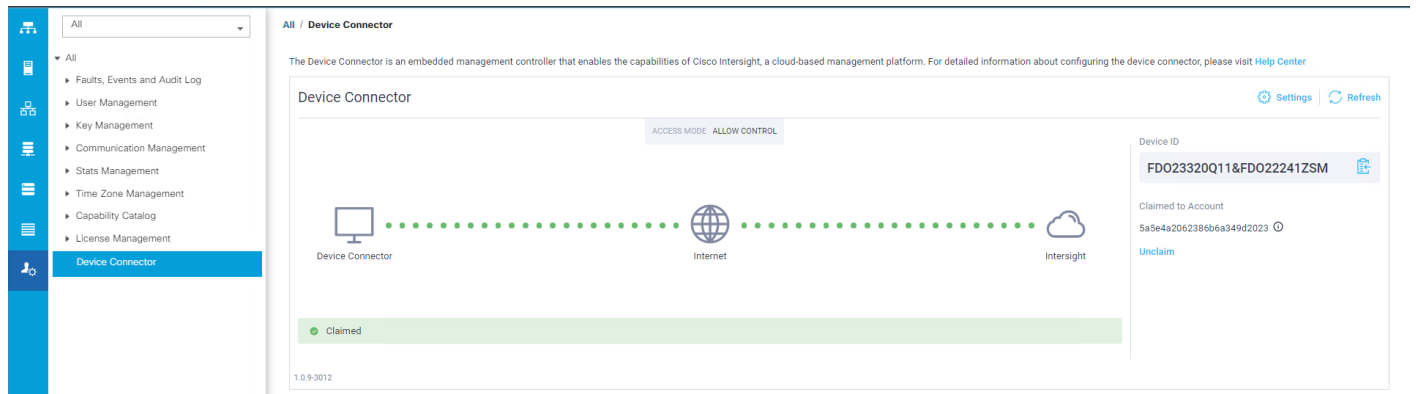

Figure 65. Cisco UCSM Device Connector Example



## Cisco Intersight Licensing Tiers - Features



Base	Essentials	Advantage	Premier	
<ul style="list-style-type: none"> <li>- SaaS only</li> <li>- No cost for UCS and HyperFlex systems</li> <li>- Global monitoring of health and inventory status</li> <li>- User customizable dashboard</li> <li>- Tagging and basic search</li> <li>- Context launch of element managers (UCS Manager, IMC, HyperFlex Connect, and UCS Director)</li> <li>- Simplified Cisco HyperFlex installation and upgrades</li> <li>- Connected TAC: Log Collection, Open Case, Contract Status</li> <li>- Role Based Access Control, Single Sign-On (SAML), Multi-Factor Authentication</li> </ul>	<ul style="list-style-type: none"> <li>- All the features of Base</li> <li>- SaaS and Virtual Appliance</li> <li>- Advanced global search and detailed inventory</li> <li>- Server HCL compliance check with driver Recommendations</li> <li>- Virtual Keyboard-Video-Mouse (vKVM)</li> <li>- ServiceNow Integration</li> <li>- Cisco Intersight Mobile App</li> <li>- HX Storage Capacity Planning (n Tech Preview)</li> <li>- Cisco Standalone UCS C-Series management (M4 and later)</li> <li>- Policy-based configuration with Profiles</li> <li>- Firmware and server actions (Power On/Off, reboot, etc)</li> <li>- Includes UCS Central and IMC Supervisor</li> </ul>	<ul style="list-style-type: none"> <li>- All the features of Essentials</li> <li>- SaaS and Virtual Appliance</li> <li>- Tunneled Virtual Keyboard-Video-Mouse (vKVM) (Target Q1,CY2020)</li> <li>- Storage Widget for Pure Storage (Target Q1,CY2020)</li> <li>- Storage Inventory Status for Pure: Capacity and Utilization Storage (Target Q1,CY2020)</li> <li>- Multi-Domain Inventory correlation: Server, Virtualization, Storage (GA: Target Q1,CY2020)</li> <li>- OS Install (n Tech Preview , GA: Target Q1,CY2020)</li> <li>- HX Edge + SD-WAN (Tech Preview Target Q1,CY2020)</li> </ul>	<ul style="list-style-type: none"> <li>- All the features of Advantage</li> <li>- SaaS and Virtual Appliance</li> <li>- Includes UCS Director</li> <li>- Storage Automation with Pure Storage (Target Q1CY2020)</li> <li>- VM Automation (Target Q1,CY2020)</li> <li>- Workflow Designer (Tech Preview Target Target Q1,CY2020)</li> </ul>	<p><b>Pure Storage Integration Requirements:</b></p> <p><b>Advantage</b> Storage Widgets and Inventory Status (Capacity/Utilization).</p> <p><b>Premier</b> Storage Automation.</p>

## Test Setup, Configuration, and Load Recommendation

In this solution, we tested a single Cisco UCS B200 M5 blade to validate against the performance of one blade and thirty B200 M5 blades across four chassis to illustrate linear scalability for each workload use case studied.

### Cisco UCS Test Configuration for Single Blade Scalability

This test case validates Recommended Maximum Workload per host server using VMware Horizon 7.12 with 224 RDS sessions, 186 VDI Non-Persistent sessions, and 186 VDI Persistent sessions.

Figure 66. Test Configuration for Single Server Scalability VMware Horizon 7.12 VDI (Persistent) Full Clones

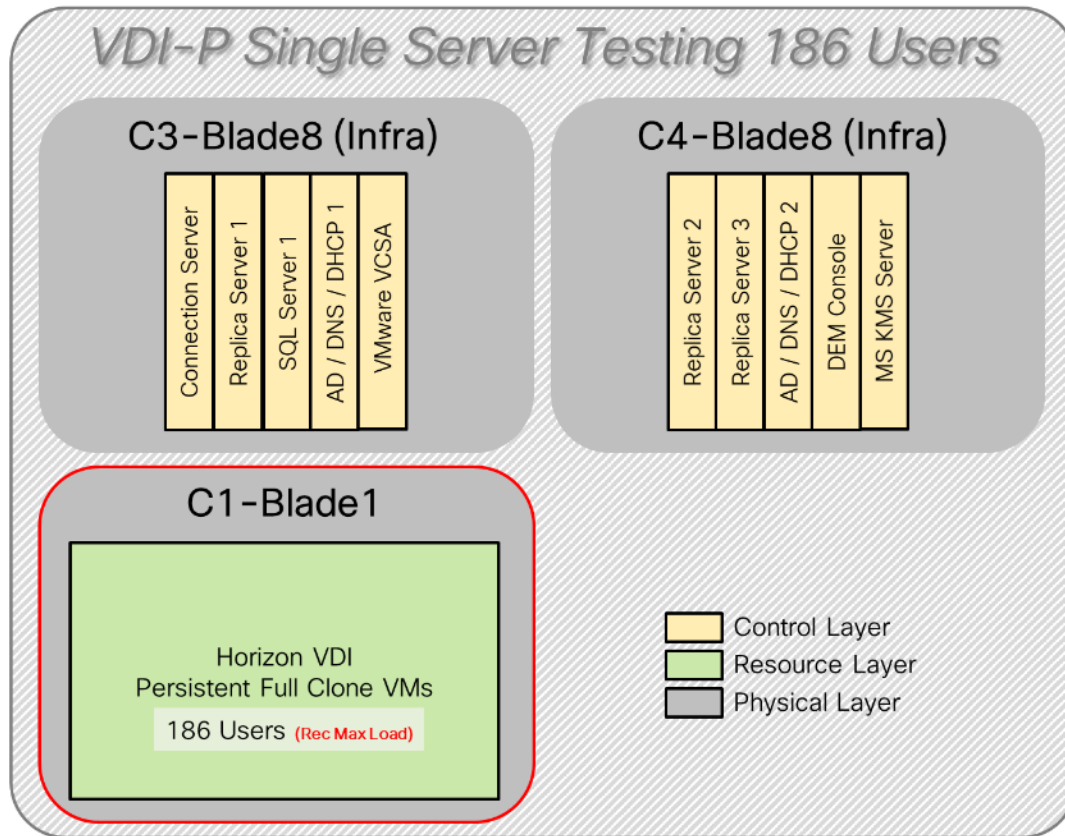



Figure 67. Test configuration for Single Server Scalability VMware Horizon 7.12 VDI (Non-Persistent) Instant Clones

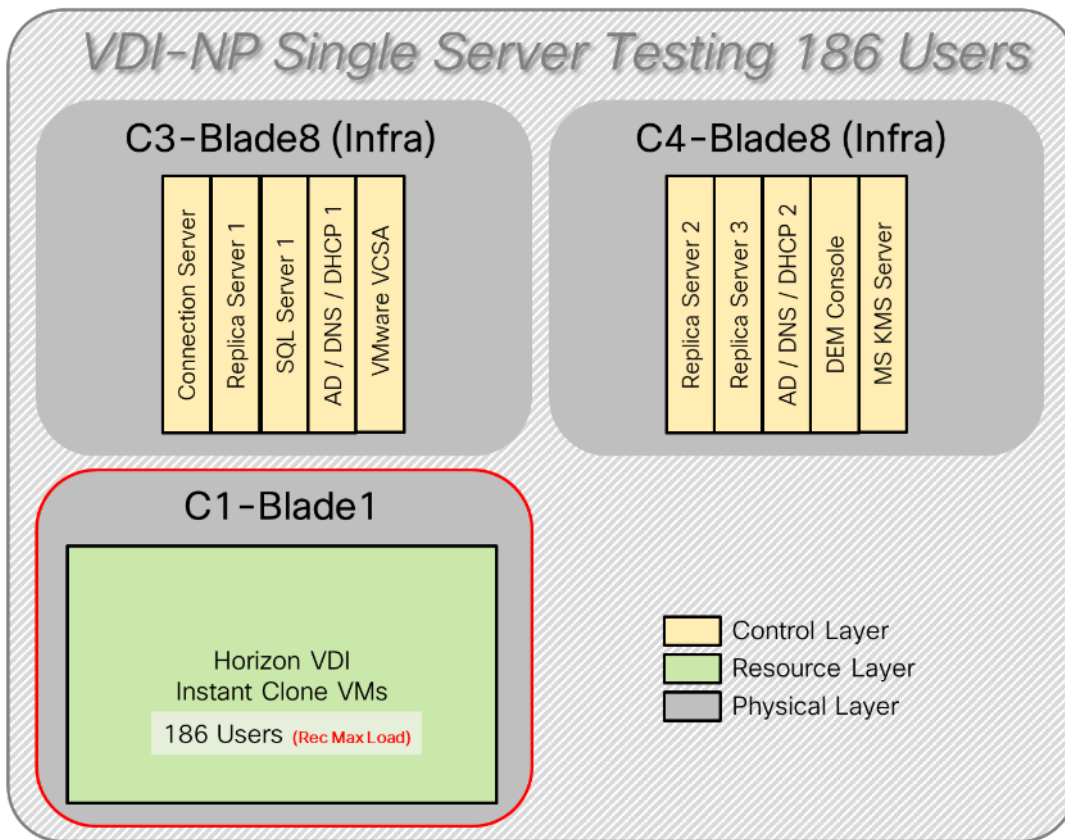
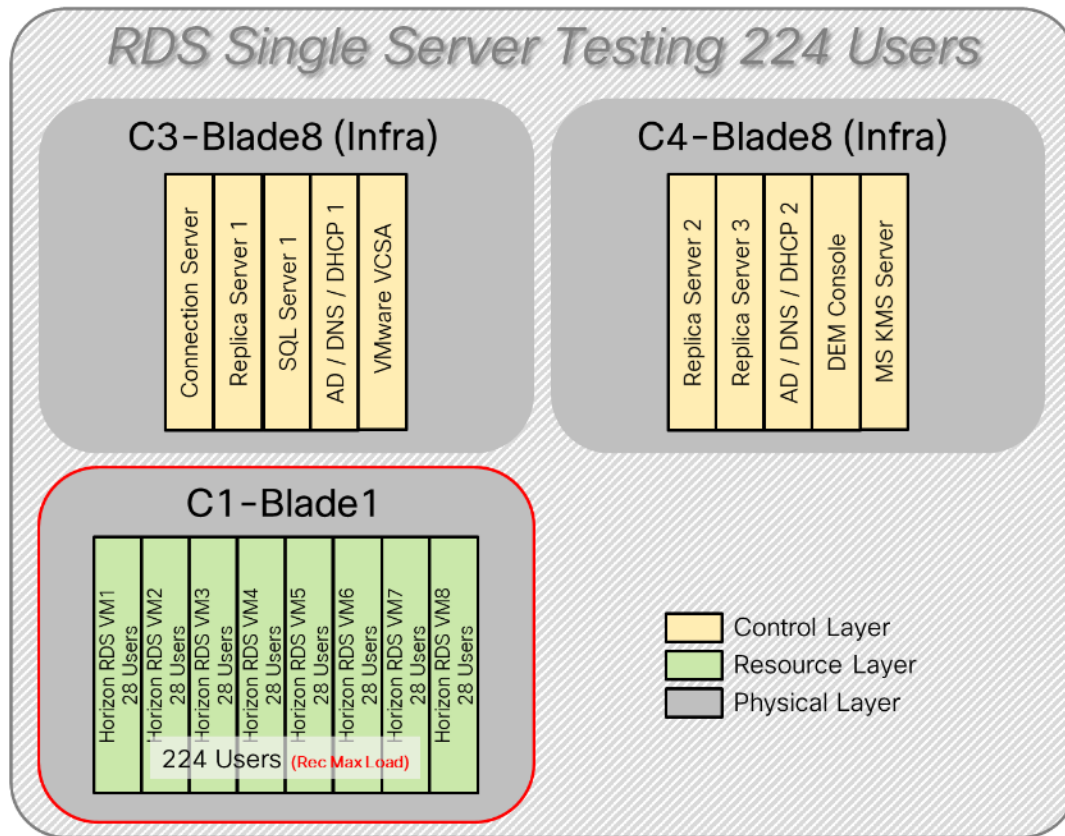



Figure 68. Test configuration for Single Server Scalability VMware Horizon 7.12 RDS Full Clones



Hardware components:

- Cisco UCS 5108 Blade Server Chassis
- 2 Cisco UCS 6454 4<sup>th</sup> Gen Fabric Interconnects
- 2 (Infrastructure Hosts) Cisco UCS B200 M5 Blade servers with Intel Xeon Silver 4210 2.20-GHz 10-core processors, 384GB 2933MHz RAM for all host blades
- 1 (RDS/VDI Host) Cisco UCS B200 M5 Blade Servers with Intel Xeon Gold 6230 2.1-GHz 20-core processors, 768GB 2933MHz RAM for all host blades
- Cisco VIC 1440 CNA (1 per blade)
- 2 Cisco Nexus 93180YC-FX Access Switches
- 2 Cisco MDS 9132T 32-Gb 32-Port Fibre Channel Switches
- Pure Storage FlashArray//X70 R3 with dual redundant controllers, with Twenty 1.92TB DirectFlash NVMe drives

Software components:

- Cisco UCS firmware 4.1(2a)
- Pure Storage Purity//FA 6.0.3

- VMware ESXi 7.0 GA for host blades
- VMware Horizon 7.12 VDI Desktops and RDSH Desktops
- VMware DEM Enterprise 10
- Microsoft SQL Server 2019
- Microsoft Windows 10 64 bit (1909), 2vCPU, 3 GB RAM, 40 GB HDD (master)
- Microsoft Windows Server 2019 (1809), 8vCPU, 32GB RAM, 60 GB vDisk (master)
- Microsoft Office 2019
- Login VSI 4.1.39 Knowledge Worker Workload (Benchmark Mode)

### Cisco UCS Test Configuration for Cluster Scale Testing

This test case validates three workload clusters of ten blades using VMware Horizon 7.12 with 2016 RDS sessions, 1674 VDI Non-Persistent sessions, and 1674 VDI Persistent sessions. Server N+1 fault tolerance is factored into this test scenario for each workload and infrastructure cluster.

Figure 69. Test Configuration for Cluster Scalability VMware Horizon 7.12 VDI (Persistent) Full Clones

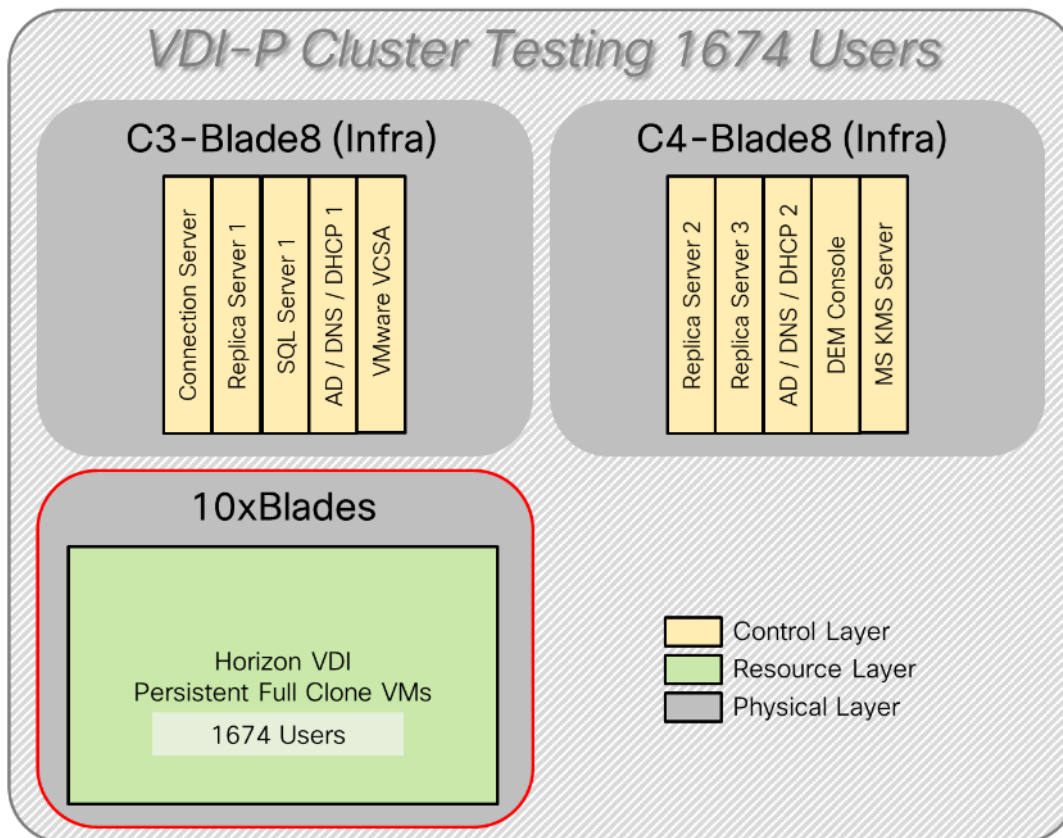

Figure 70. Test Configuration for Cluster Scalability VMware Horizon 7.12 VDI (Non-Persistent) Instant Clones

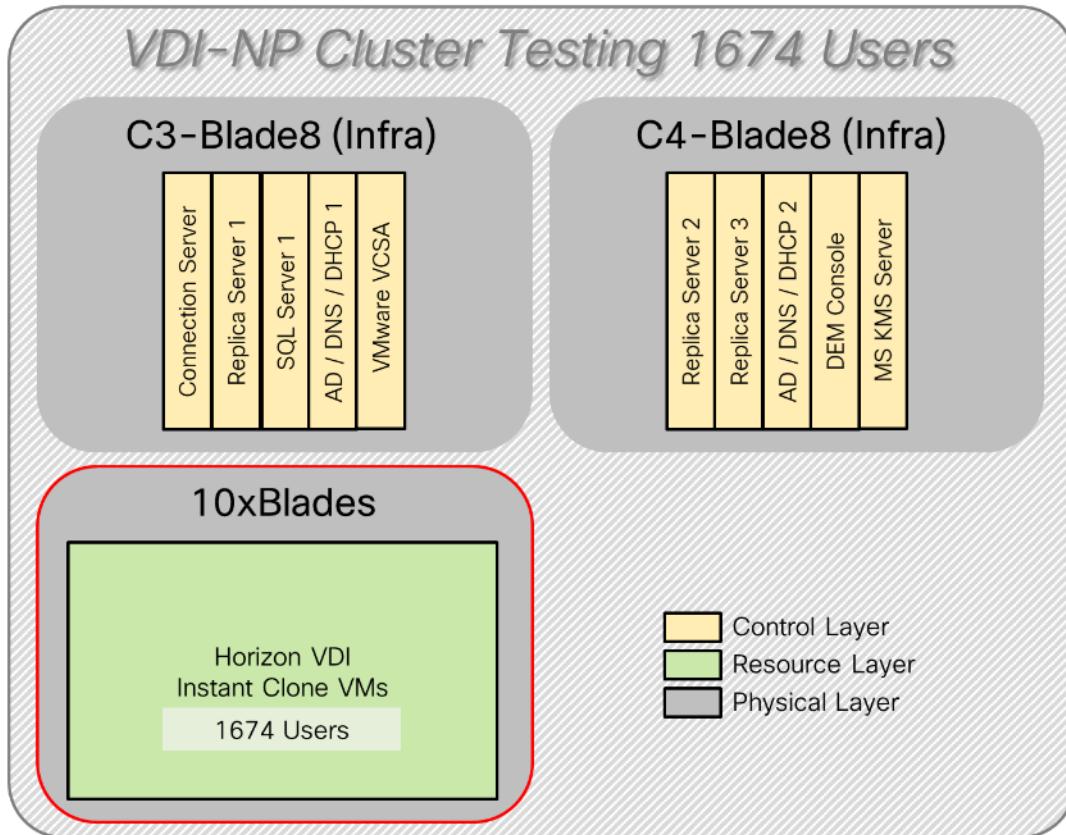
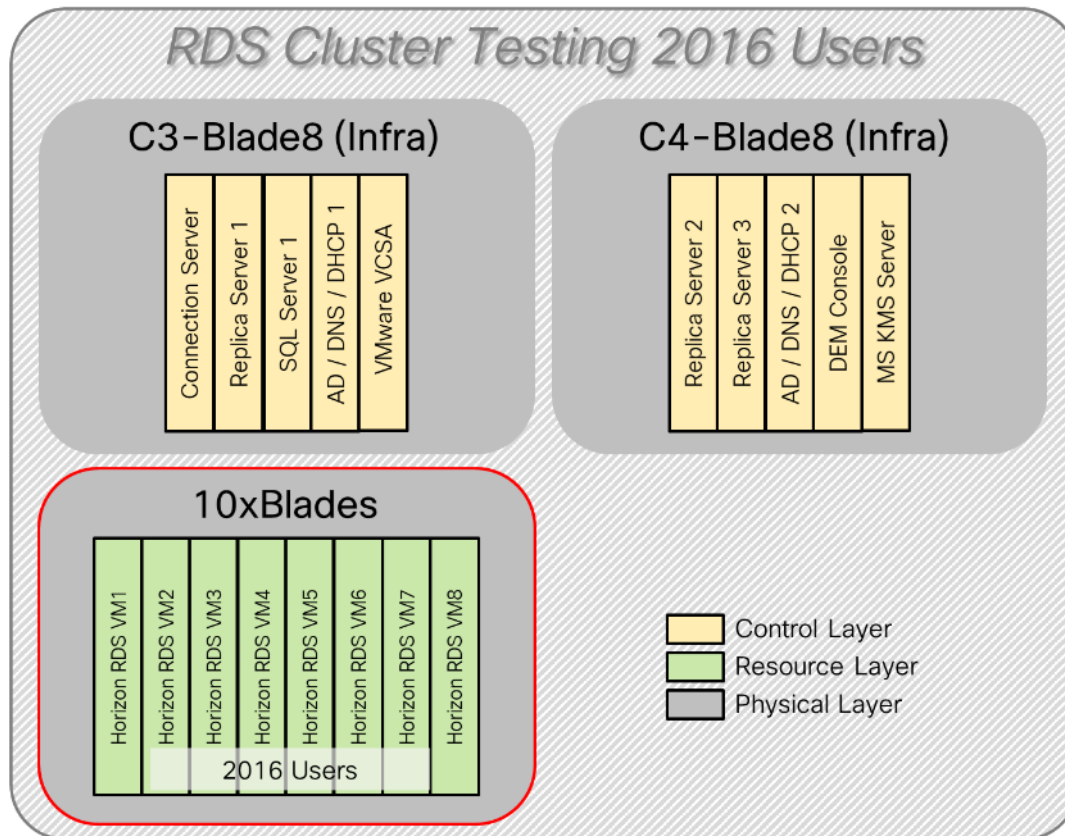

Figure 71. Test Configuration for Single Server Scalability VMware Horizon 7.12 RDS Full Clones



Hardware components:

- Cisco UCS 5108 Blade Server Chassis
- 2 Cisco UCS 6454 4<sup>th</sup> Gen Fabric Interconnects
- 2 (Infrastructure Hosts) Cisco UCS B200 M5 Blade servers with Intel Xeon Silver 4210 2.20-GHz 10-core processors, 384GB 2933MHz RAM for all host blades
- 10 (RDS/VDI Host) Cisco UCS B200 M5 Blade Servers with Intel Xeon Gold 6230 2.1-GHz 20-core processors, 768GB 2933MHz RAM for all host blades
- Cisco VIC 1440 CNA (1 per blade)
- 2 Cisco Nexus 93180YC-FX Access Switches
- 2 Cisco MDS 9132T 32-Gb 32-Port Fibre Channel Switches
- Pure Storage FlashArray//X70 R3 with dual redundant controllers, with Twenty 1.92TB DirectFlash NVMe drives

Software components:

- Cisco UCS firmware 4.1(2a)
- Pure Storage Purity//FA 6.0.3

- 
- VMware ESXi 7.0 GA for host blades
  - VMware Horizon 7.12 VDI Desktops and RDSH Desktops
  - VMware DEM Enterprise 10
  - Microsoft SQL Server 2019
  - Microsoft Windows 10 64 bit (1909), 2vCPU, 3 GB RAM, 40 GB HDD (master)
  - Microsoft Windows Server 2019 (1809), 8vCPU, 32GB RAM, 60 GB vDisk (master)
  - Microsoft Office 2019
  - Login VSI 4.1.39 Knowledge Worker Workload (Benchmark Mode)

### **Cisco UCS Test Configuration for Full Scale Testing**

These test cases validate thirty blades in three clusters of three distinct workloads and a mixed workload using VMware Horizon 7.12 with:

- 6048 Non-Persistent RDS sessions (Full clones).
- 5022 Persistent VDI sessions (Full clones).
- 5022 Non-Persistent VDI sessions (Instant clones).
- 2015 RDS sessions, 1674 VDI Non-Persistent sessions, and 1674 VDI Persistent sessions for a total sum of 5363 users

Server N+1 fault tolerance is factored into this solution for each cluster/workload.

Figure 72. Test Configuration for Full Scale VMware Horizon 7.12 VDI (Persistent) Full Clones

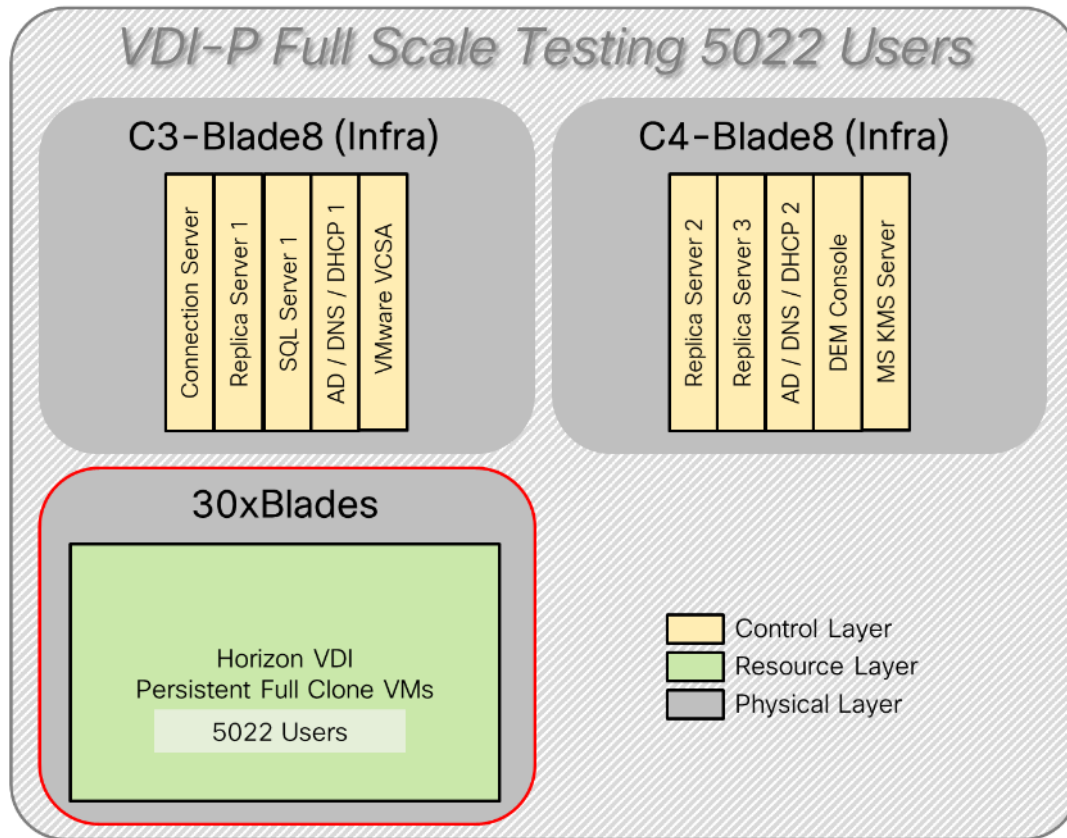



Figure 73. Test Configuration for Full Scale VMware Horizon 7.12 VDI (Non-Persistent) Instant Clones

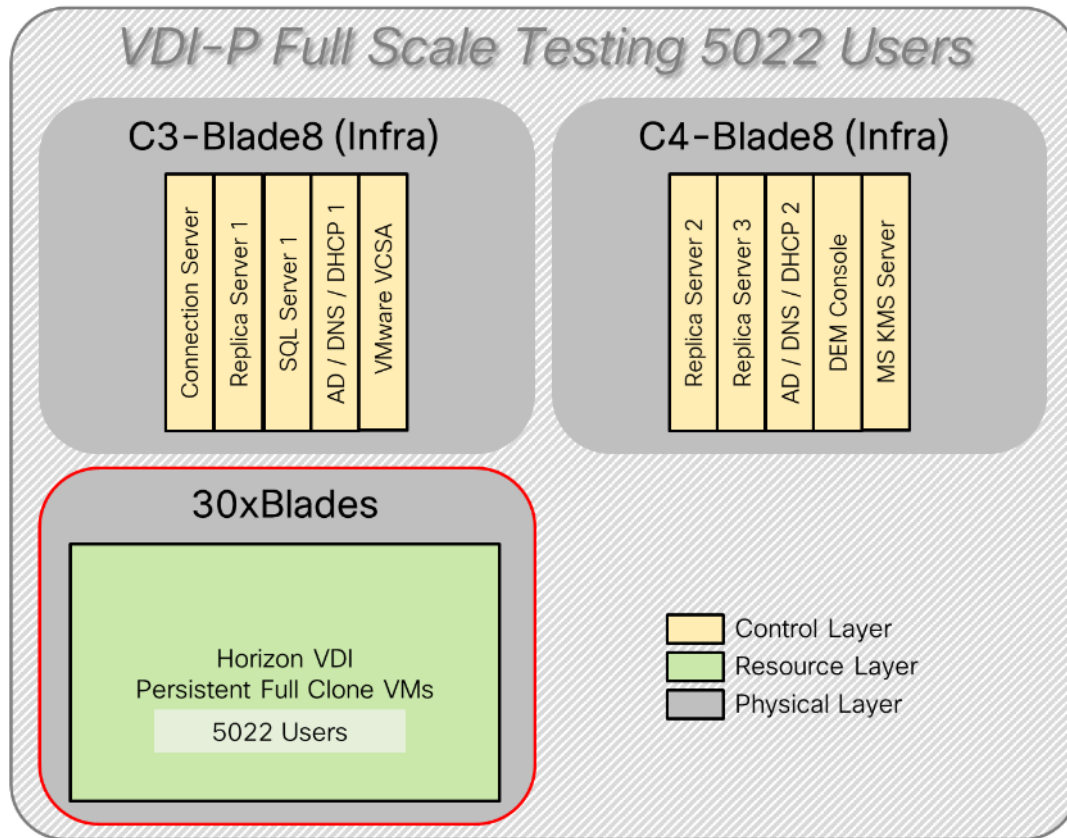

Figure 74. Test Configuration for Full Scale VMware Horizon 7.12 RDS Full Clones

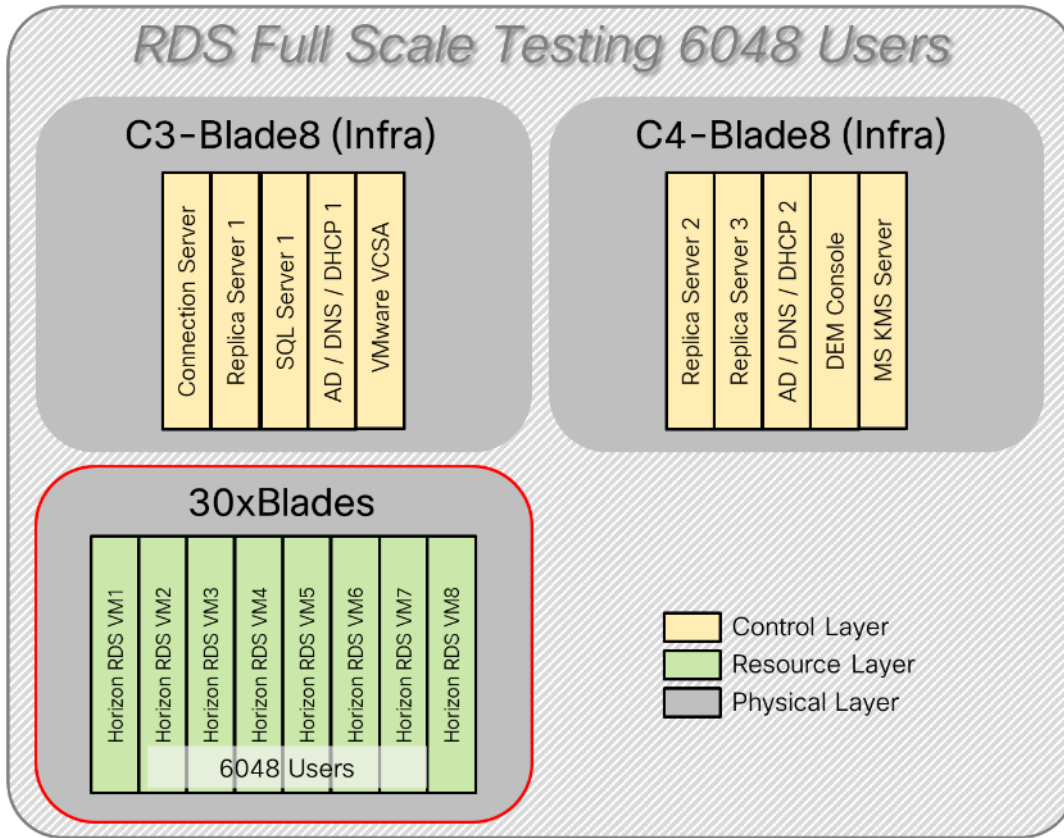
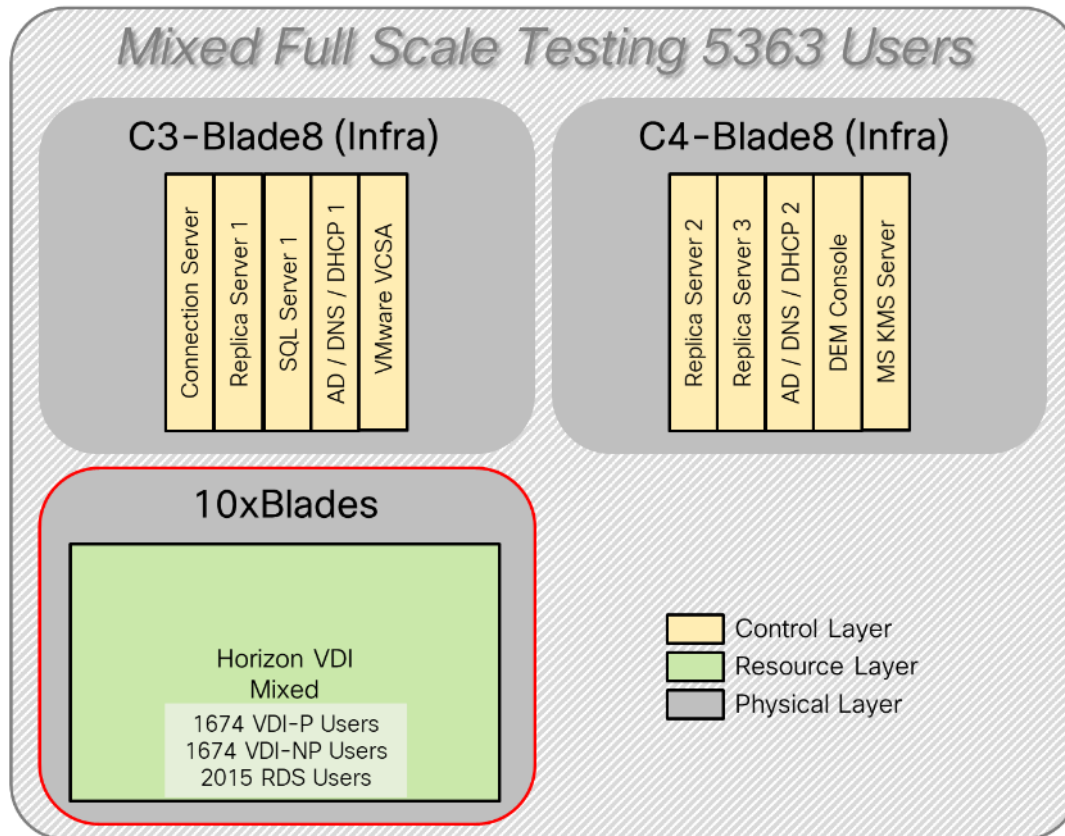



Figure 75. Test Configuration for Full Scale VMware Horizon 7.12 Mixed Workloads



Hardware components:

- Cisco UCS 5108 Blade Server Chassis
- 2 Cisco UCS 6454 4<sup>th</sup> Gen Fabric Interconnects
- 2 (Infrastructure Hosts) Cisco UCS B200 M5 Blade servers with Intel Xeon Silver 4210 2.20-GHz 10-core processors, 384GB 2933MHz RAM for all host blades
- 30 (RDS/VDI Host) Cisco UCS B200 M5 Blade Servers with Intel Xeon Gold 6230 2.1-GHz 20-core processors, 768GB 2933MHz RAM for all host blades
- Cisco VIC 1440 CNA (1 per blade)
- 2 Cisco Nexus 93180YC-FX Access Switches
- 2 Cisco MDS 9132T 32-Gb 32-Port Fibre Channel Switches
- Pure Storage FlashArray//X70 R3 with dual redundant controllers, with Twenty 1.92TB DirectFlash NVMe drives

Software components:

- Cisco UCS firmware 4.1(2a)
- Pure Storage Purity//FA 6.0.3

- 
- VMware ESXi 7.0 GA for host blades
  - VMware Horizon 7.12 VDI Desktops and RDSH Desktops
  - VMware DEM Enterprise 10
  - Microsoft SQL Server 2019
  - Microsoft Windows 10 64 bit (1909), 2vCPU, 3 GB RAM, 40 GB HDD (master)
  - Microsoft Windows Server 2019 (1809), 8vCPU, 32GB RAM, 60 GB vDisk (master)
  - Microsoft Office 2019
  - Login VSI 4.1.39 Knowledge Worker Workload (Benchmark Mode)

---

## Test Methodology and Success Criteria

All validation testing was conducted on-site within the Cisco labs in San Jose, California.

The testing results focused on the entire process of the virtual desktop lifecycle by capturing metrics during the desktop boot-up, user logon and virtual desktop acquisition (also referred to as ramp-up,) user workload execution (also referred to as steady state), and user logoff for the RDSH/VDI Session under test.

Test metrics were gathered from the virtual desktop, storage, and load generation software to assess the overall success of an individual test cycle. Each test cycle was not considered passing unless all of the planned test users completed the ramp-up and steady state phases (described below) and unless all metrics were within the permissible thresholds as noted as success criteria.

Three successfully completed test cycles were conducted for each hardware configuration and results were found to be relatively consistent from one test to the next.

You can obtain additional information and a free test license from <http://www.loginvsi.com>

## Test Procedure

The following protocol was used for each test cycle in this study to ensure consistent results.

### Pre-Test Setup for Single and Multi-Blade Testing

All virtual machines were shut down utilizing the VMware Horizon Console and vCenter.

All Launchers for the test were shut down. They were then restarted in groups of 10 each minute until the required number of launchers was running with the Login VSI Agent at a “waiting for test to start” state.

All VMware ESXi VDI host blades to be tested were restarted prior to each test cycle.

### Test Run Protocol

To simulate severe, real-world environments, Cisco requires the log-on and start-work sequence, known as Ramp Up, to complete in 48 minutes. For testing where the user session count exceeds 1000 users, we will now deem the test run successful with up to 1% session failure rate.

In addition, Cisco requires that the Login VSI Benchmark method is used for all single server and scale testing. This assures that our tests represent real-world scenarios. For each of the three consecutive runs on single server tests, the same process was followed. To do so, follow these steps:

1. Time 0:00:00 Start PerfMon/Esxtop Logging on the following systems:
  - a. Infrastructure and VDI Host Blades used in the test run
  - b. vCenter used in the test run
  - c. All Infrastructure virtual machines used in test run (AD, SQL, brokers, image mgmt., etc.)
2. Time 0:00:10 Start Storage Partner Performance Logging on Storage System.
3. Time 0:05: Boot Virtual Desktops/RDS Virtual Machines using View Connection server.



---

The boot rate should be around 10-12 virtual machines per minute per server.

---

4. Time 0:06 First machines boot.
5. Time 0:30 Single Server or Scale target number of desktop virtual machines booted on 1 or more blades.



---

No more than 30 minutes for boot up of all virtual desktops is allowed.

---

6. Time 0:35 Single Server or Scale target number of desktop virtual machines desktops available on View Connection Server.
7. Virtual machine settling time.



---

No more than 60 Minutes of rest time is allowed after the last desktop is registered on the XD Studio or available in View Connection Server dashboard. Typically, a 30-45-minute rest period is sufficient.

---

8. Time 1:35 Start Login VSI 4.1.x Office Worker Benchmark Mode Test, setting auto-logoff time at 15 minutes, with Single Server or Scale target number of desktop virtual machines utilizing sufficient number of Launchers (at 20-25 sessions/Launcher).
9. Time 2:23 Single Server or Scale target number of desktop virtual machines desktops launched (48 minute benchmark launch rate).
10. Time 2:25 All launched sessions must become active. id test run within this window.
11. Time 2:40 Login VSI Test Ends (based on Auto Logoff 15 minutes period designated above).
  - a. Time 2:55 All active sessions logged off.
  - b. Time 2:57 All logging terminated; Test complete.
  - c. Time 3:15 Copy all log files off to archive; Set virtual desktops to maintenance mode through broker; Shutdown all Windows machines.
  - d. Time 3:30 Reboot all hypervisor hosts.
  - e. Time 3:45 Ready for the new test sequence.

### Success Criteria

Our pass criteria for this testing is as follows:

Cisco will run tests at a session count level that effectively utilizes the blade capacity measured by CPU utilization, memory utilization, storage utilization, and network utilization. We will use Login VSI to launch version 4.1.x Office Worker workloads. The number of launched sessions must equal active sessions within two minutes of the last session launched in a test as observed on the VSI Management console.

The VMware Horizon Console be monitored throughout the steady state to make sure of the following:

- All running sessions report In Use throughout the steady state

- No sessions move to unregistered, unavailable or available state at any time during steady state

Within 20 minutes of the end of the test, all sessions on all launchers must have logged out automatically and the Login VSI Agent must have shut down. Stuck sessions define a test failure condition.

Cisco requires three consecutive runs with results within +/-1% variability to pass the Cisco Validated Design performance criteria. For white papers written by partners, two consecutive runs within +/-1% variability are accepted. (All test data from partner run testing must be supplied along with the proposed white paper.)

We will publish Cisco Validated Designs with our recommended workload following the process above and will note that we did not reach a VSImax dynamic in our testing. FlashStack Data Center with Cisco UCS and VMware Horizon 7.12 on VMware ESXi 7.0 GA Test Results.

The purpose of this testing is to provide the data needed to validate VMware Horizon Remote Desktop Sessions (RDS) and VMware Horizon Virtual Desktop (VDI) instant-clones and VMware Horizon Virtual Desktop (VDI) full-clones models using ESXi and vCenter to virtualize Microsoft Windows 10 desktops and Microsoft Windows Server 2019 sessions on Cisco UCS B200 M5 Blade Servers using the Pure Storage FlashArray//X70 R3 storage system.

The information contained in this section provides data points that a customer may reference in designing their own implementations. These validation results are an example of what is possible under the specific environment conditions outlined here, and do not represent the full characterization of VMware products.

Four test sequences, each containing three consecutive test runs generating the same result, were performed to establish single blade performance and multi-blade, linear scalability.

### **VSImax 4.1.x Description**

The philosophy behind Login VSI is different from conventional benchmarks. In general, most system benchmarks are steady state benchmarks. These benchmarks execute one or multiple processes, and the measured execution time is the outcome of the test. Simply put: the faster the execution time or the bigger the throughput, the faster the system is according to the benchmark.

Login VSI is different in approach. Login VSI is not primarily designed to be a steady state benchmark (however, if needed, Login VSI can act like one). Login VSI was designed to perform benchmarks for HSD or VDI workloads through system saturation. Login VSI loads the system with simulated user workloads using well known desktop applications like Microsoft Office, Internet Explorer, and Adobe PDF reader. By gradually increasing the amount of simulated users, the system will eventually be saturated. Once the system is saturated, the response time of the applications will increase significantly. This latency in application response times show a clear indication whether the system is (close to being) overloaded. As a result, by nearly overloading a system it is possible to find out what its true maximum user capacity is.

After a test is performed, the response times can be analyzed to calculate the maximum active session/desktop capacity. Within Login VSI this is calculated as VSImax. When the system is coming closer to its saturation point, response times will rise. When reviewing the average response time, it will be clear the response times escalate at saturation point.

This VSImax is the "Virtual Session Index (VSI)". With Virtual Desktop Infrastructure (VDI) and Terminal Services (RDS) workloads this is valid and useful information. This index simplifies comparisons and makes it possible to understand the true impact of configuration changes on hypervisor host or guest level.

---

## Server-Side Response Time Measurements

It is important to understand why specific Login VSI design choices have been made. An important design choice is to execute the workload directly on the target system within the session instead of using remote sessions. The scripts simulating the workloads are performed by an engine that executes workload scripts on every target system and are initiated at logon within the simulated user's desktop session context.

An alternative to the Login VSI method would be to generate user actions client side through the remoting protocol. These methods are always specific to a product and vendor dependent. More importantly, some protocols simply do not have a method to script user actions client side.

For Login VSI, the choice has been made to execute the scripts completely server side. This is the only practical and platform independent solution, for a benchmark like Login VSI.

### Calculating VSImax v4.1.x

The simulated desktop workload is scripted in a 48 minute loop when a simulated Login VSI user is logged on, performing generic Office worker activities. After the loop is finished it will restart automatically. Within each loop, the response times of sixteen specific operations are measured in a regular interval: sixteen times in within each loop. The response times of these five operations are used to determine VSImax.

The five operations from which the response times are measured are:

- Notepad File Open (NFO)

Loading and initiating VSINotepad.exe and opening the openfile dialog. This operation is handled by the OS and by the VSINotepad.exe itself through execution. This operation seems almost instant from an end-user's point of view.

- Notepad Start Load (NSLD)

Loading and initiating VSINotepad.exe and opening a file. This operation is also handled by the OS and by the VSINotepad.exe itself through execution. This operation seems almost instant from an end-user's point of view.

- Zip High Compression (ZHC)

This action copy's a random file and compresses it (with 7zip) with high compression enabled. The compression will very briefly spike CPU and disk IO.

- Zip Low Compression (ZLC)

This action copy's a random file and compresses it (with 7zip) with low compression enabled. The compression will very briefly disk IO and creates some load on the CPU.

- CPU

Calculates a large array of random data and spikes the CPU for a short period of time.

These measured operations within Login VSI do hit considerably different subsystems such as CPU (user and kernel), Memory, Disk, the OS in general, the application itself, print, GDI, and so on. These operations are specifically short by nature. When such operations become consistently long: the system is saturated because of excessive queuing on any kind of resource. As a result, the average response times will then escalate. This ef-

fect is clearly visible to end-users. If such operations consistently consume multiple seconds the user will regard the system as slow and unresponsive.

**Figure 76. Sample of a VSI Max Response Time Graph, Representing a Normal Test**

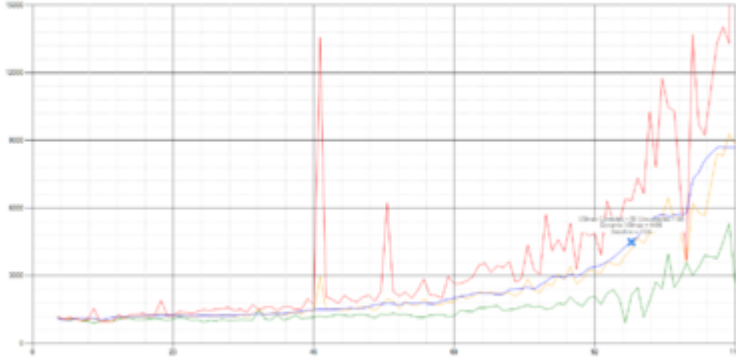

**Figure 77. Sample of a VSI Test Response Time Graph with a Performance Issue**

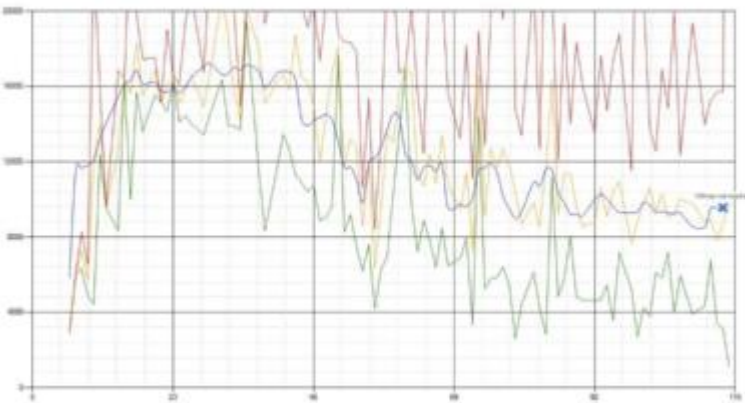

When the test is finished, VSI<sub>max</sub> can be calculated. When the system is not saturated, and it could complete the full test without exceeding the average response time latency threshold, VSI<sub>max</sub> is not reached and the amount of sessions ran successfully.

The response times are very different per measurement type, for instance Zip with compression can be around 2800 ms, while the Zip action without compression can only take 75ms. These response times of these actions are weighted before they are added to the total. This ensures that each activity has an equal impact on the total response time.

In comparison to previous VSI<sub>max</sub> models, this weighting much better represents system performance. All actions have very similar weight in the VSI<sub>max</sub> total. The following weighting of the response times is applied.

The following actions are part of the VSI<sub>max</sub> v4.1.x calculation and are weighted as follows (US notation):

- Notepad File Open (NFO): 0.75
- Notepad Start Load (NSLD): 0.2
- Zip High Compression (ZHC): 0.125

- Zip Low Compression (ZLC): 0.2
- CPU: 0.75

This weighting is applied on the baseline and normal Login VSI response times.

With the introduction of Login VSI 4.1.x, we also created a new method to calculate the basephase of an environment. With the new workloads (Taskworker, Powerworker, and so on) enabling 'basephase' for a more reliable baseline has become obsolete. The calculation is explained below. In total the 15 lowest VSI response time samples are taken from the entire test; the lowest 2 samples are removed. and the 13 remaining samples are averaged. The result is the Baseline. To summarize:

- Take the lowest 15 samples of the complete test
- From those 15 samples remove the lowest 2
- Average the 13 results that are left is the baseline

The VSImax average response time in Login VSI 4.1.x is calculated on the number of active users that are logged on the system.

Always a 5 Login VSI response time samples are averaged + 40 percent of the number of “active” sessions. For example, if the active sessions are 60, then latest 5 + 24 (=40 percent of 60) = 31 response time measurement is used for the average calculation.

To remove noise (accidental spikes) from the calculation, the top 5 percent and bottom 5 percent of the VSI response time samples are removed from the average calculation, with a minimum of 1 top and 1 bottom sample. As a result, with 60 active users, the last 31 VSI response time sample are taken. From those 31 samples, the top 2 samples are removed, and the lowest 2 results are removed (5 percent of 31 = 1.55, rounded to 2). At 60 users the average is then calculated over the 27 remaining results.

VSImax v4.1.x is reached when the VSImax + a 1000 ms latency threshold is not reached by the average VSI response time result. Depending on the tested system, VSImax response time can grow 2 - 3x the baseline average. In end-user computing, a 3x increase in response time in comparison to the baseline is typically regarded as the maximum performance degradation to be considered acceptable.

In VSImax v4.1.x this latency threshold is fixed to 1000ms, this allows better and fairer comparisons between two different systems, especially when they have different baseline results. Ultimately, in VSImax v4.1.x, the performance of the system is not decided by the total average response time, but by the latency is has under load. For all systems, this is now 1000ms (weighted).

The threshold for the total response time is: average weighted baseline response time + 1000ms.

When the system has a weighted baseline response time average of 1500ms, the maximum average response time may not be greater than 2500ms (1500+1000). If the average baseline is 3000 the maximum average response time may not be greater than 4000ms (3000+1000).

When the threshold is not exceeded by the average VSI response time during the test, VSImax is not hit and the number of sessions ran successfully. This approach is fundamentally different in comparison to previous VSImax methods, as it was always required to saturate the system beyond VSImax threshold.



Lastly, VSImax v4.1.x is now always reported with the average baseline VSI response time result. For example: “The VSImax v4.1.x was 125 with a baseline of 1526ms”. This helps considerably in the comparison of systems and gives a more complete understanding of the system. The baseline performance helps to understand the best performance the system can give to an individual user. VSImax indicates what the total user capacity is for the system. These two are not automatically connected and related:

When a server with a very fast dual core CPU, running at 3.6 GHz, is compared to a 10 core CPU, running at 2,26 GHz, the dual core machine will give an individual user better performance than the 10 core machine. This is indicated by the baseline VSI response time. The lower this score is, the better performance an individual user can expect.

However, the server with the slower 10 core CPU will easily have a larger capacity than the faster dual core system. This is indicated by VSImax v4.1.x, and the higher VSImax is, the larger overall user capacity can be expected.

With Login VSI 4.1.x a new VSImax method is introduced: VSImax v4.1.x. This methodology gives much better insight into system performance and scales to extremely large systems.

### Single-Server Recommended Maximum Workload

For both the VMware Horizon 7.12 Virtual Desktop and VMware Horizon 7.12 Remote Desktop Service Hosts (RDSH) use cases, a recommended maximum workload was determined by the Login VSI Knowledge Worker Workload in VSI Benchmark Mode end user experience measurements and blade server operating parameters.

This recommended maximum workload approach allows you to determine the server N+1 fault tolerance load the blade can successfully support in the event of a server outage for maintenance or upgrade.

Our recommendation is that the Login VSI Average Response and VSI Index Average should not exceed the Baseline plus 2000 milliseconds to ensure that end user experience is outstanding. Additionally, during steady state, the processor utilization should average no more than 90-95 percent.



**Memory should never be oversubscribed for Desktop Virtualization workloads.**

**Table 16. Phases of Test Runs**

Test Phase	Description
Boot	Start all RDS and VDI virtual machines at the same time
Idle	The rest time after the last desktop is registered on the XD Studio. (typically, a 30-45 minute, <60 min)
Logon	The Login VSI phase of the test is where sessions are launched and start executing the workload over a 48 minutes duration
Steady state	The steady state phase is where all users are logged in and performing various workload tasks such as using Microsoft Office, Web browsing, PDF printing, playing videos, and compressing files (typically for the 15-minute duration)
Logoff	Sessions finish executing the Login VSI workload and logoff

## Test Results

### Single-Server Recommended Maximum Workload Testing

This section shows the key performance metrics that were captured on the Cisco UCS host blades during the single server testing to determine the Recommended Maximum Workload per host server. The single server testing comprised of following three tests:

- 186 VDI Persistent sessions.
- 186 VDI Non-Persistent sessions
- 224 HSD sessions

### Single-Server Recommended Maximum Workload for RDS with 224 Users

The recommended maximum workload for a Cisco UCS B200 M5 blade server with dual Intel Xeon Gold 6230 2.10-GHz 20-core processors, 768GB 2933MHz RAM is 224 RDS Windows Server 2019 sessions. Each dedicated blade server ran 8 Windows Server 2019 Virtual Machines. Each virtual server was configured with 10 vCPUs and 32GB RAM.

LoginVSI data is as follows:

**Figure 78. Single Server Recommended Maximum Workload | Horizon 7.10 RDS | VSI Score**

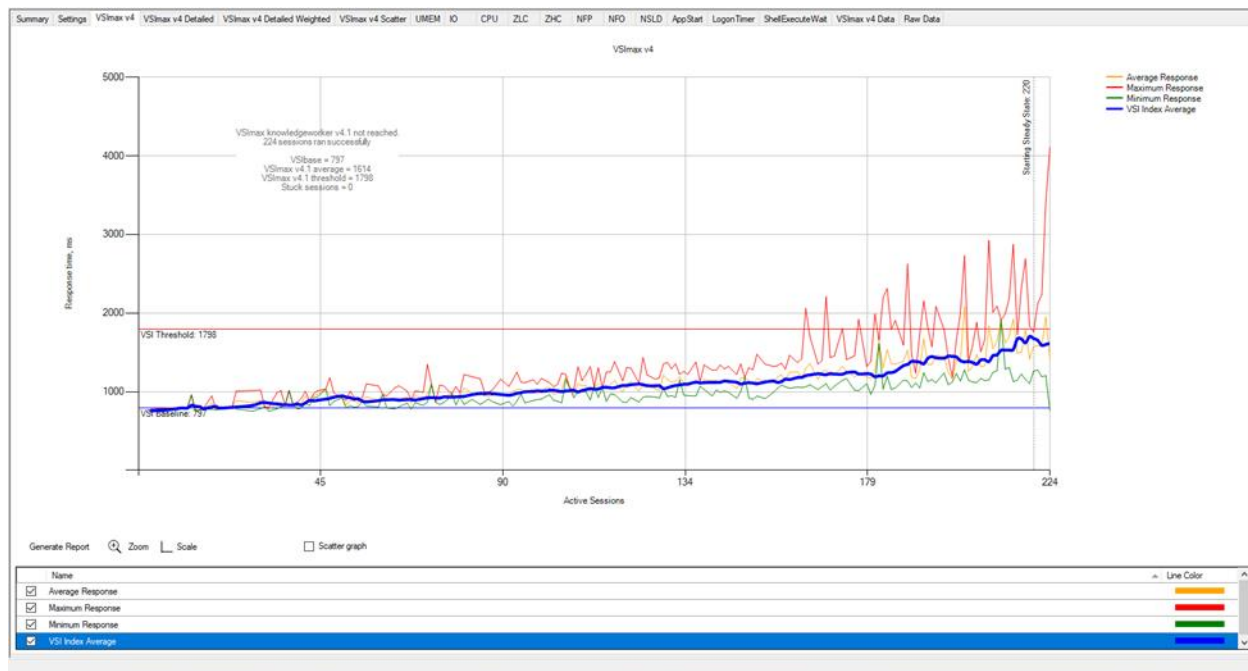

Performance data for the server running the workload is as follows:

Figure 79. Single Server Recommended Maximum Workload | Horizon 7.10 RDS | Host CPU Utilization

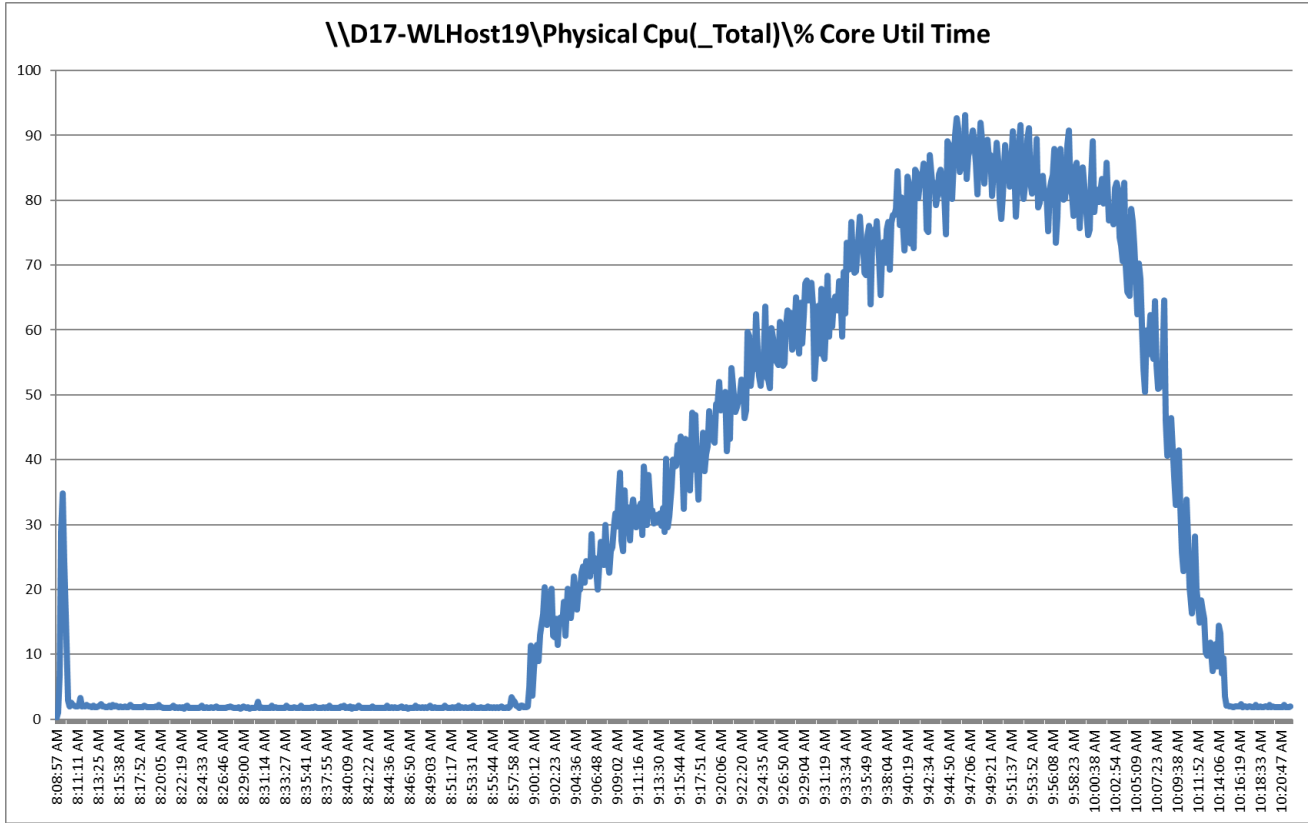

Figure 80. Single Server Recommended Maximum Workload | Horizon 7.10 RDS | Host Memory Utilization

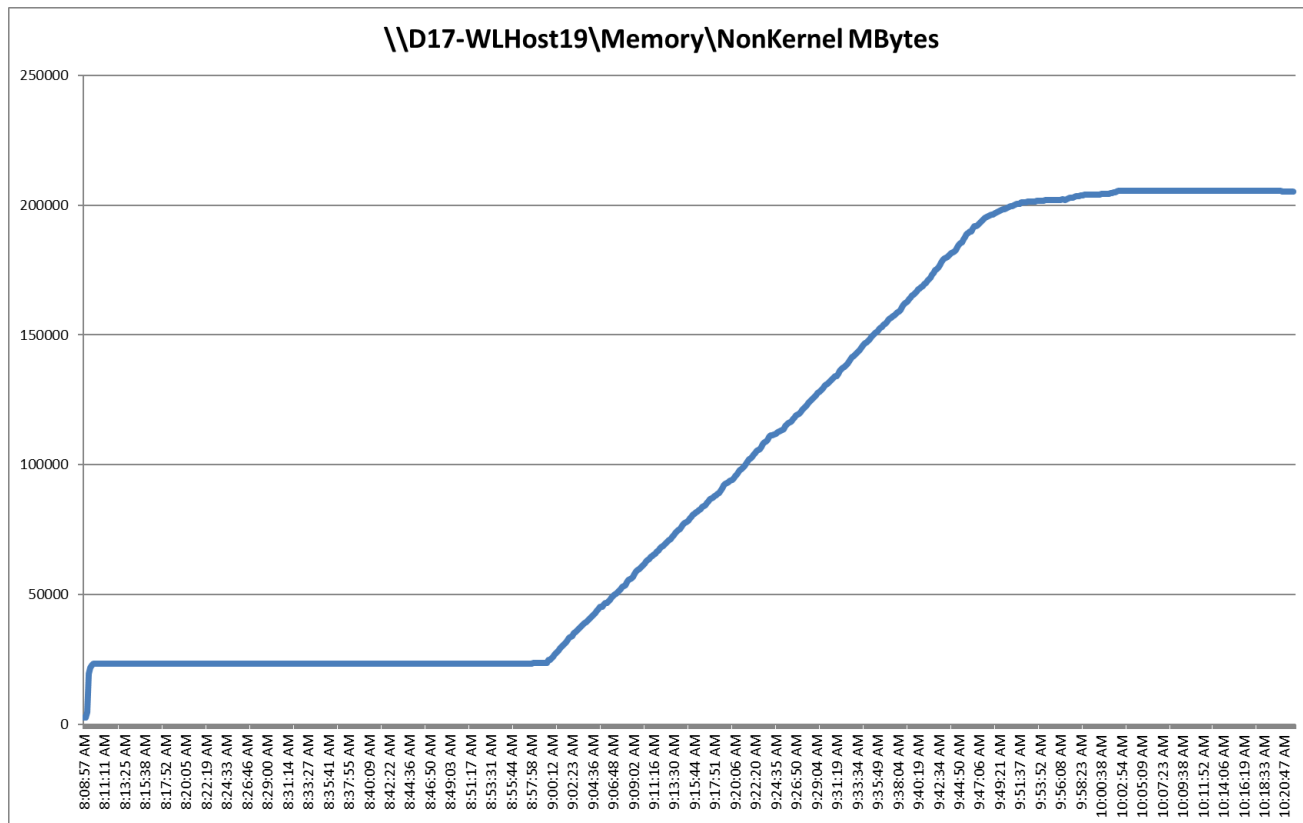
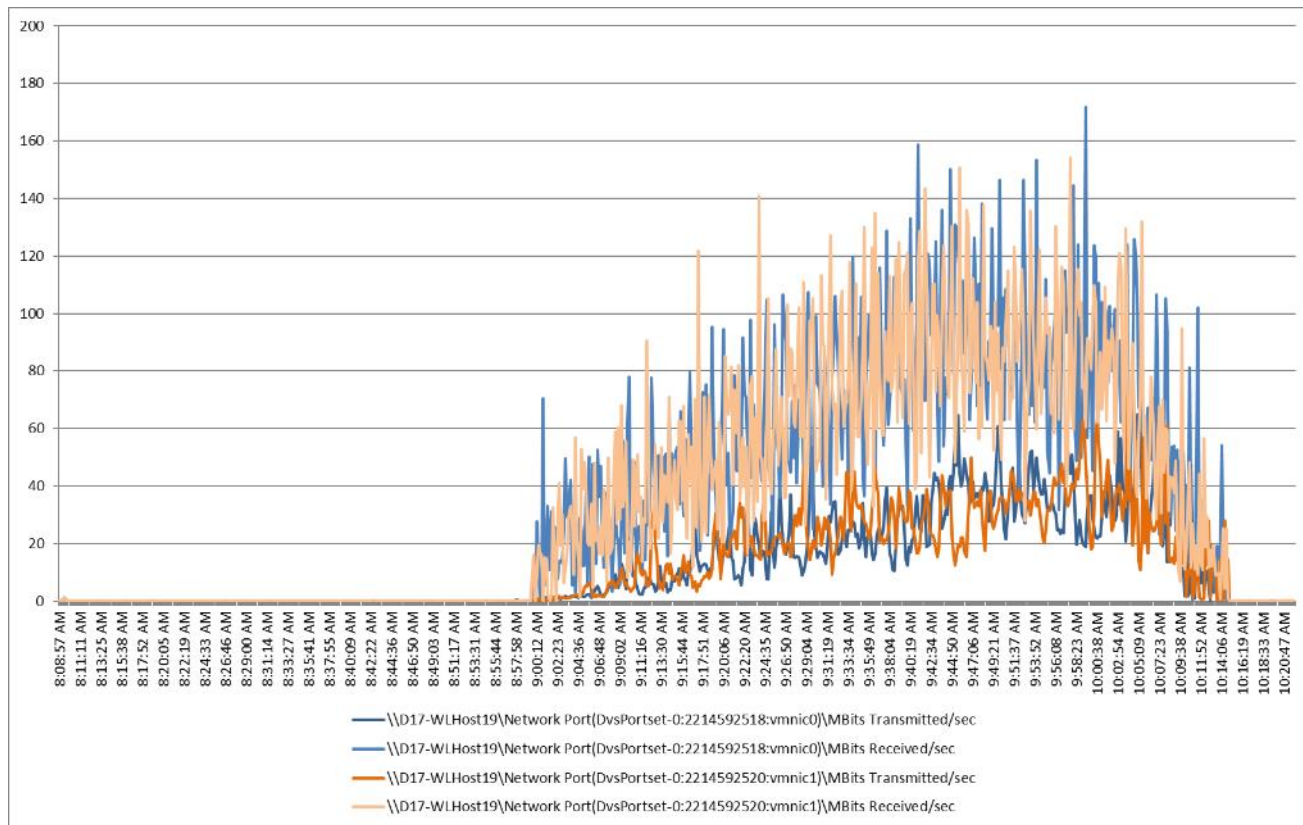
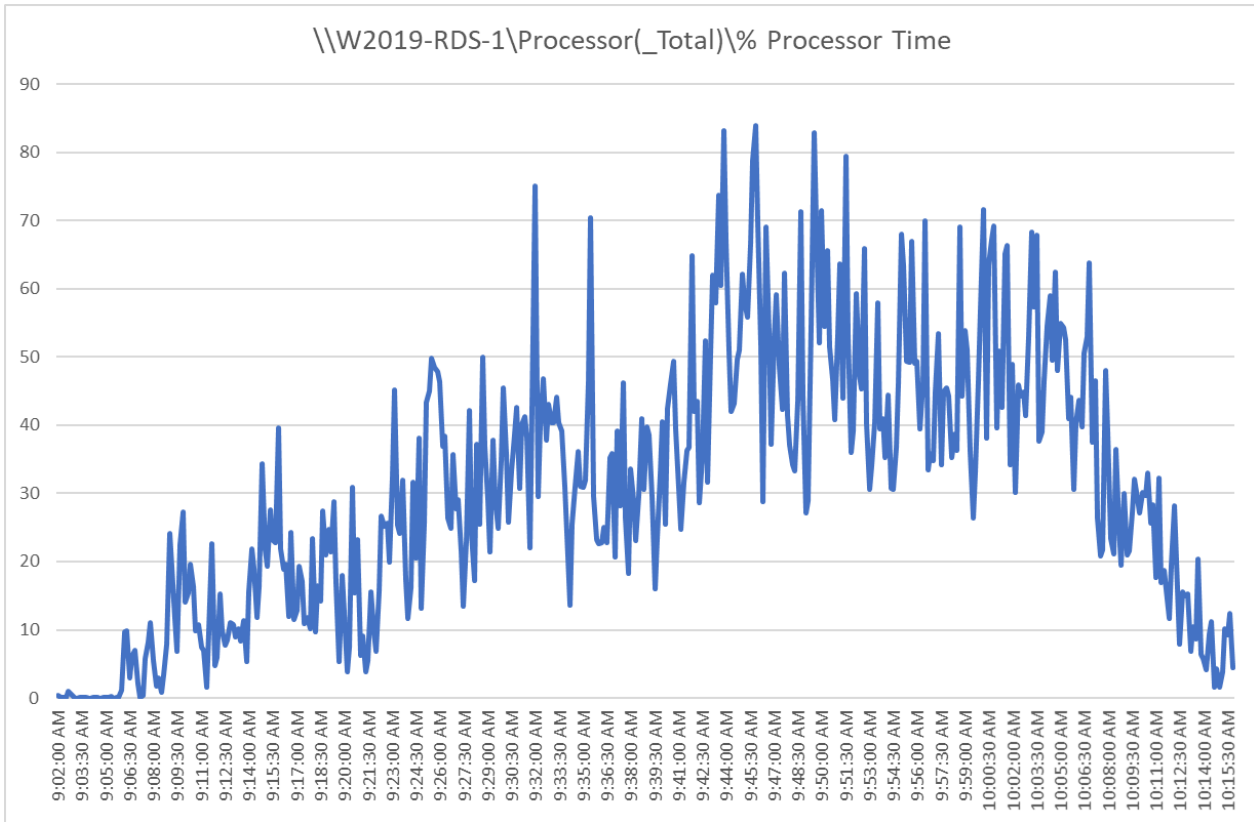

Figure 81. Single Server | Horizon 7.10 RDS | Host Network Utilization



Performance data for the RDS Virtual Machine running the workload is as follows:

Figure 82. Single Server Recommended Maximum Workload | Horizon 7.12 RDS | Virtual Machine CPU Utilization



**Figure 83. Single Server Recommended Maximum Workload | Horizon 7.12 RDS | Virtual Machine Memory Utilization**

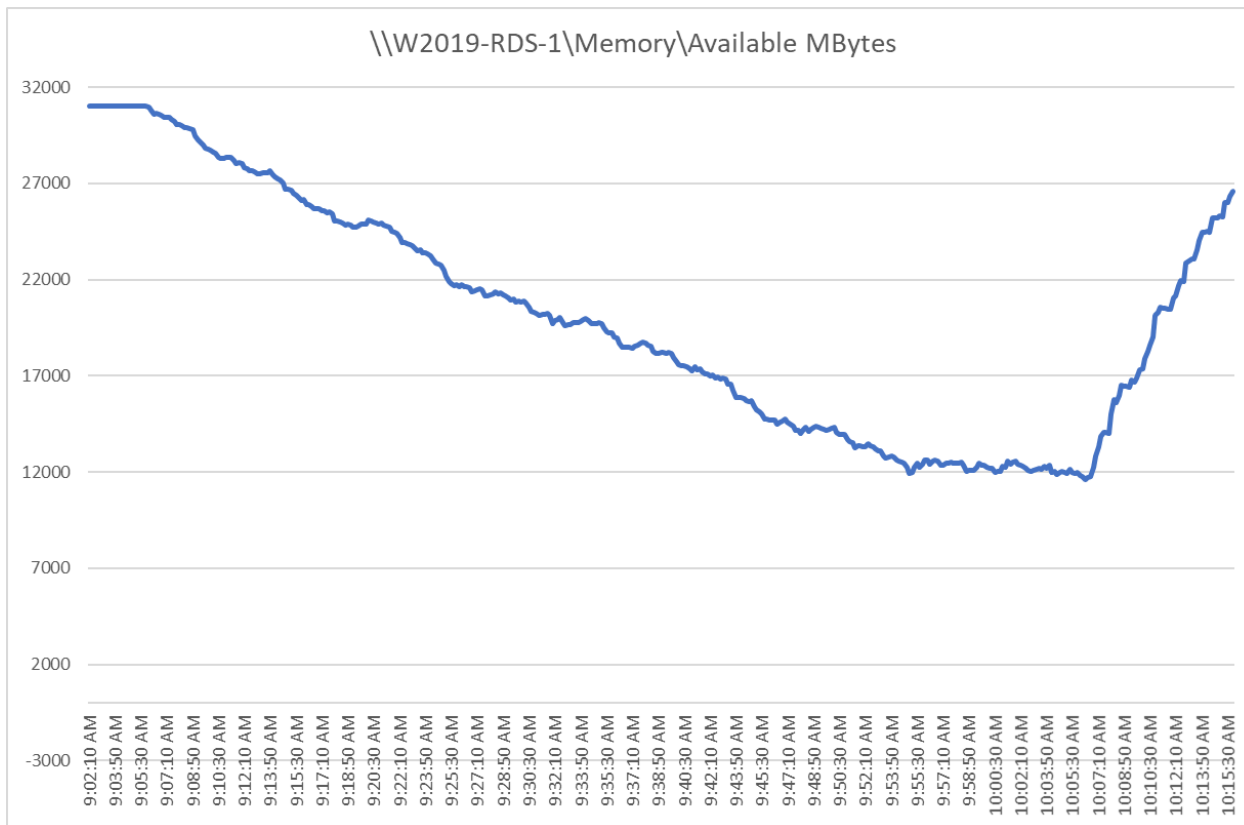

**Single-Server Recommended Maximum Workload for VDI Non-Persistent with 186 Users**

The recommended maximum workload for a Cisco UCS B200 M5 blade server with dual Intel Xeon Gold 6230 2.10-GHz 20-core processors, 768GB 2933MHz RAM is 186 Windows 10 64-bit VDI non-persistent instant clone virtual machines with 2 vCPU and 3.5 GB RAM.

Login VSI performance data is as follows:

**Figure 84. Single Server | Horizon 7.12 VDI-NP | VSI Score**

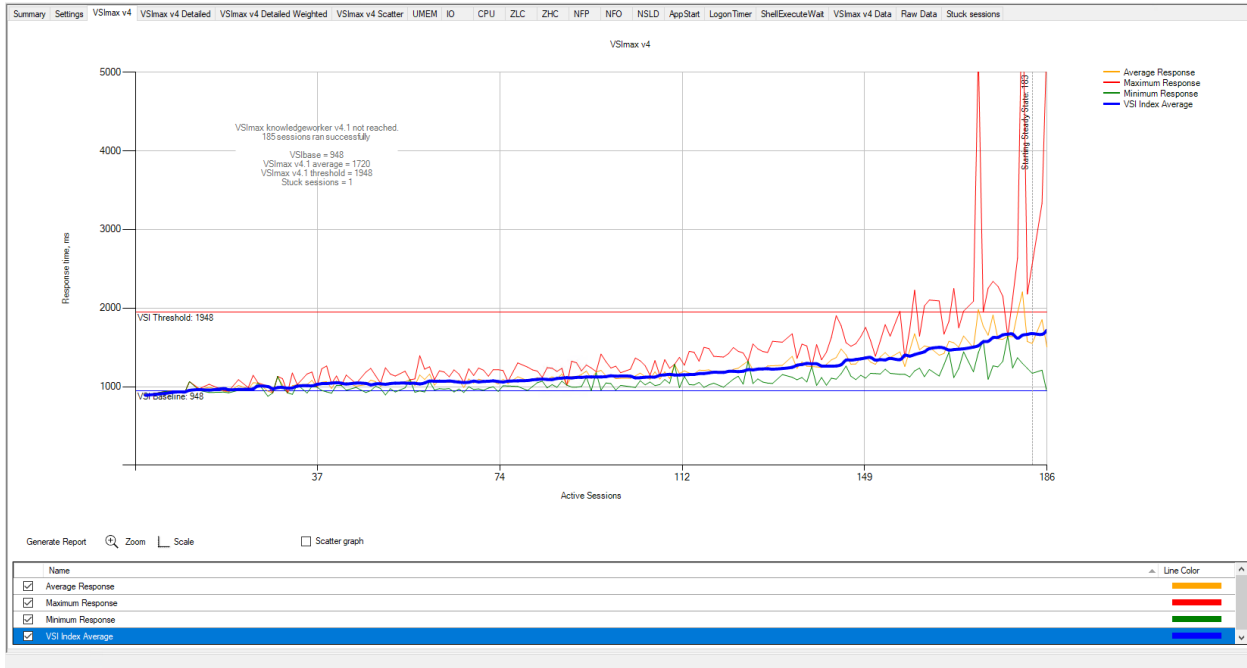

Performance data for the server running the workload is as follows:



Figure 85. Single Server | Horizon 7.12 VDI-NP | Host CPU Utilization

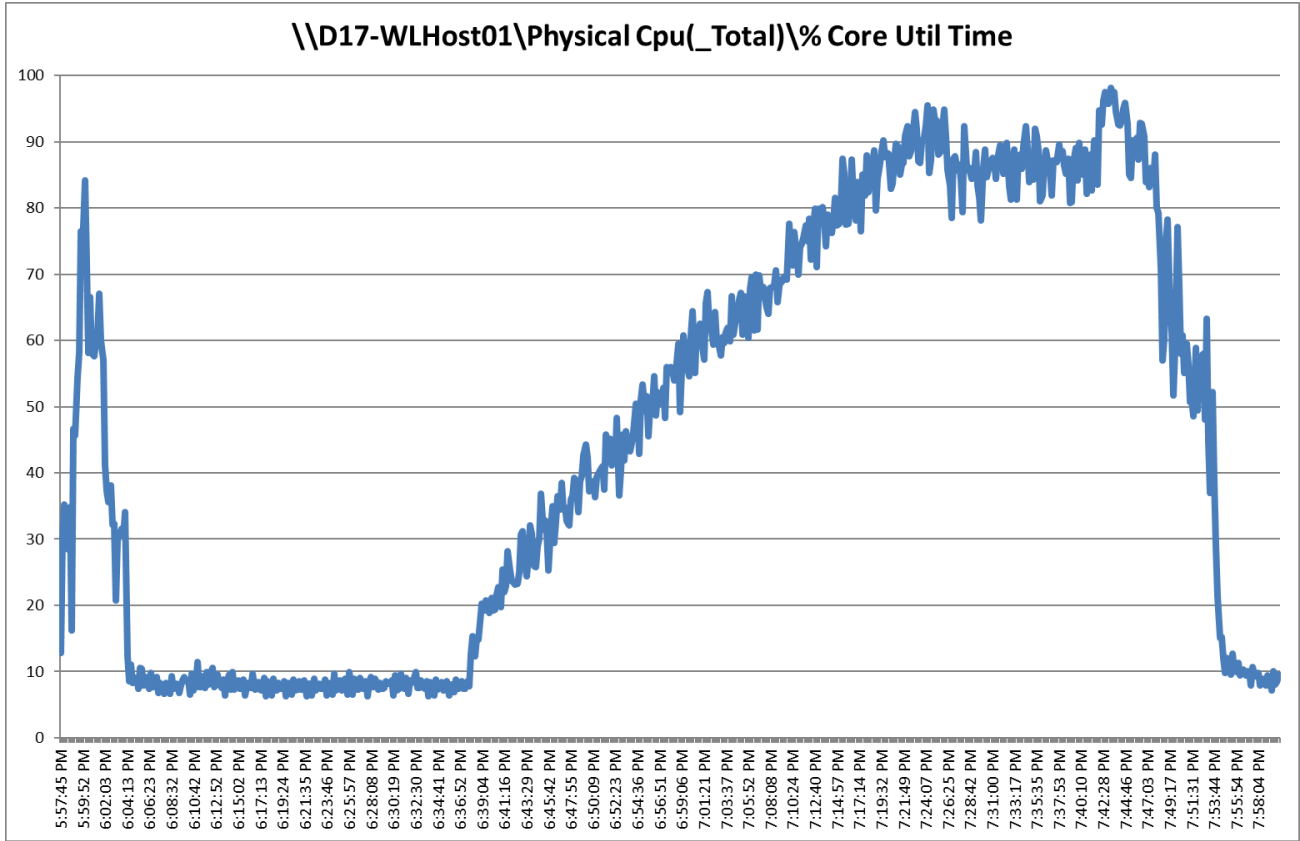
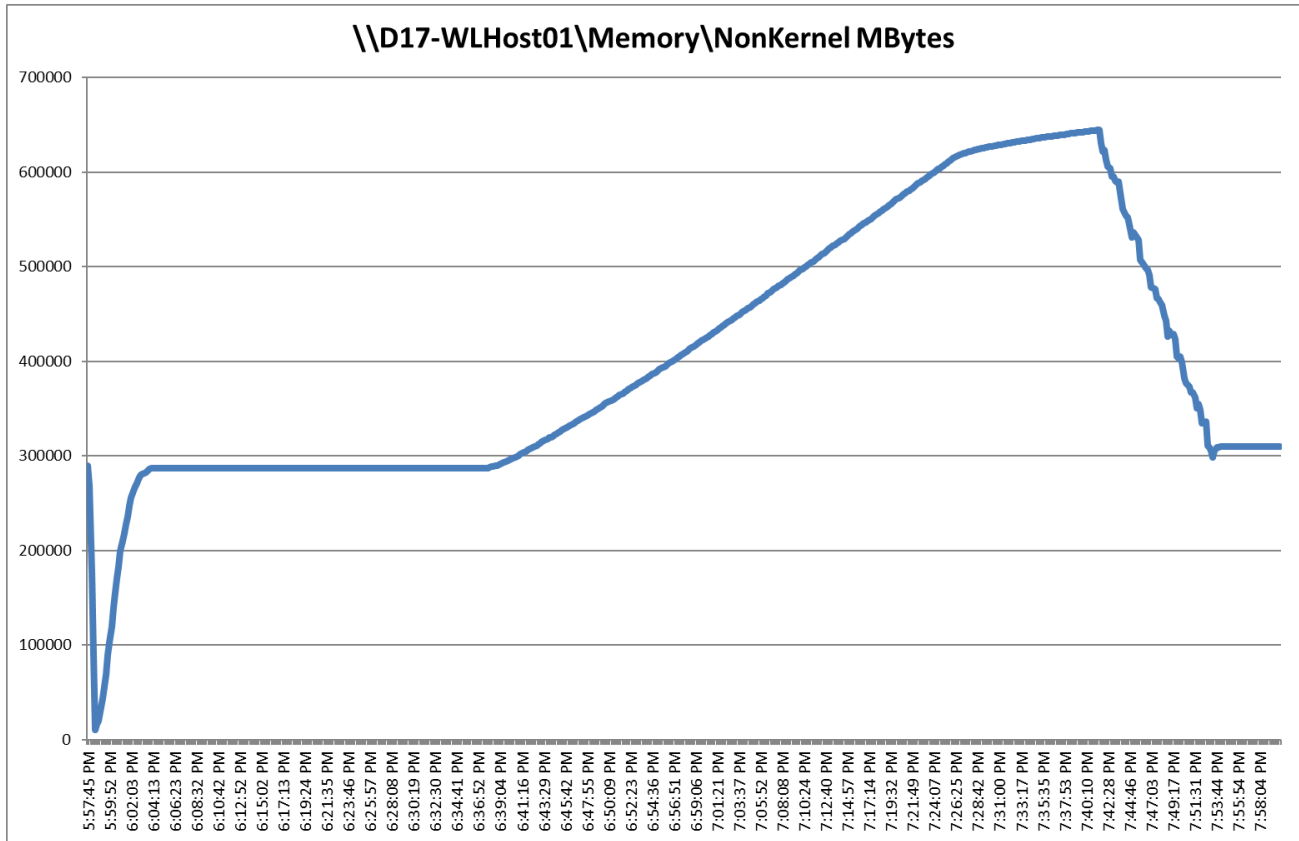
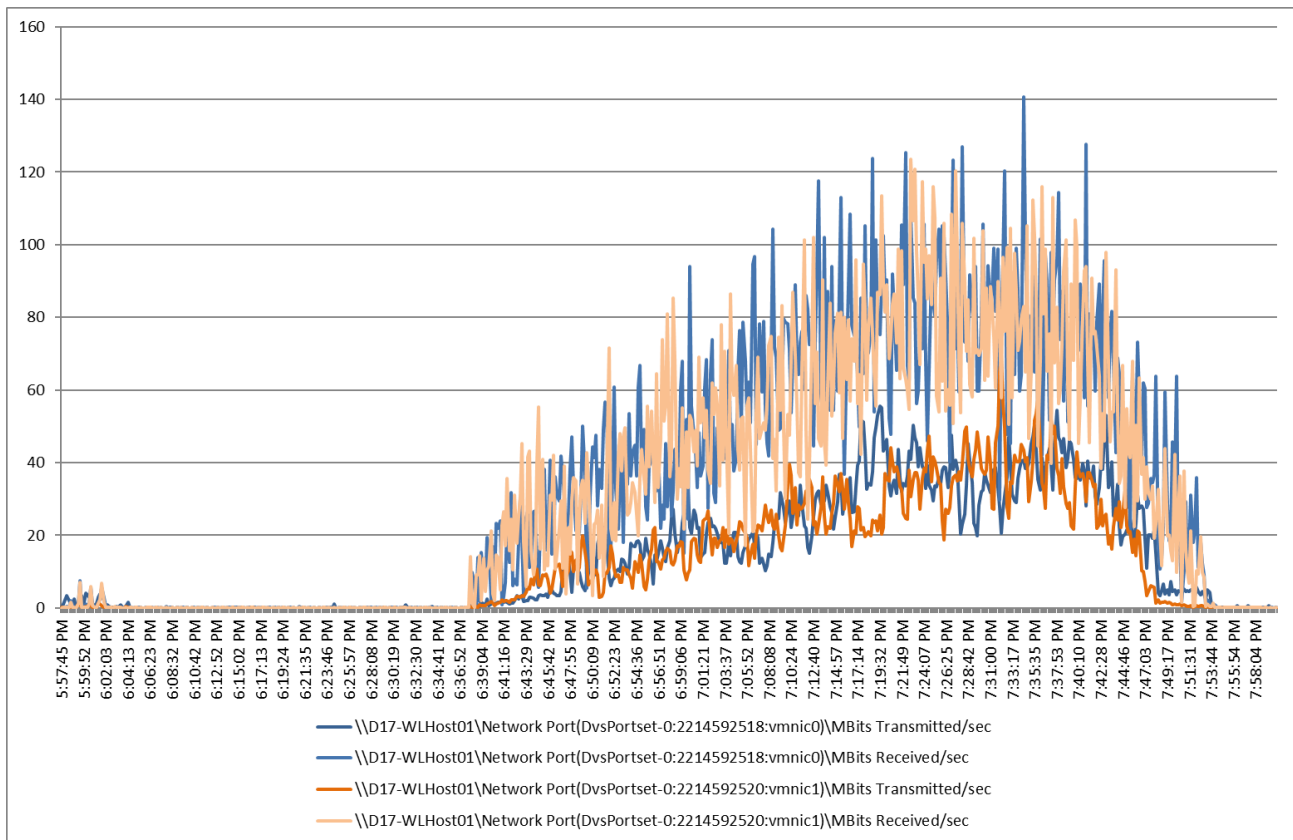

Figure 86. Single Server | Horizon 7.12 VDI-NP | Host Memory Utilization



**Figure 87. Single Server | Horizon 7.12 VDI-NP | Host Network Utilization**



**Single-Server Recommended Maximum Workload for VDI Persistent with 186 Users**

The recommended maximum workload for a Cisco UCS B200 M5 blade server with dual Intel Xeon Gold 6230 2.10-GHz 20-core processors, 768GB 2933MHz RAM is 186 Windows 10 64-bit VDI persistent virtual machines with 2 vCPU and 3.5GB RAM.

Login VSI performance data is as follows:

**Figure 88. Single Server | Horizon 7.12 VDI-P | VSI Score**

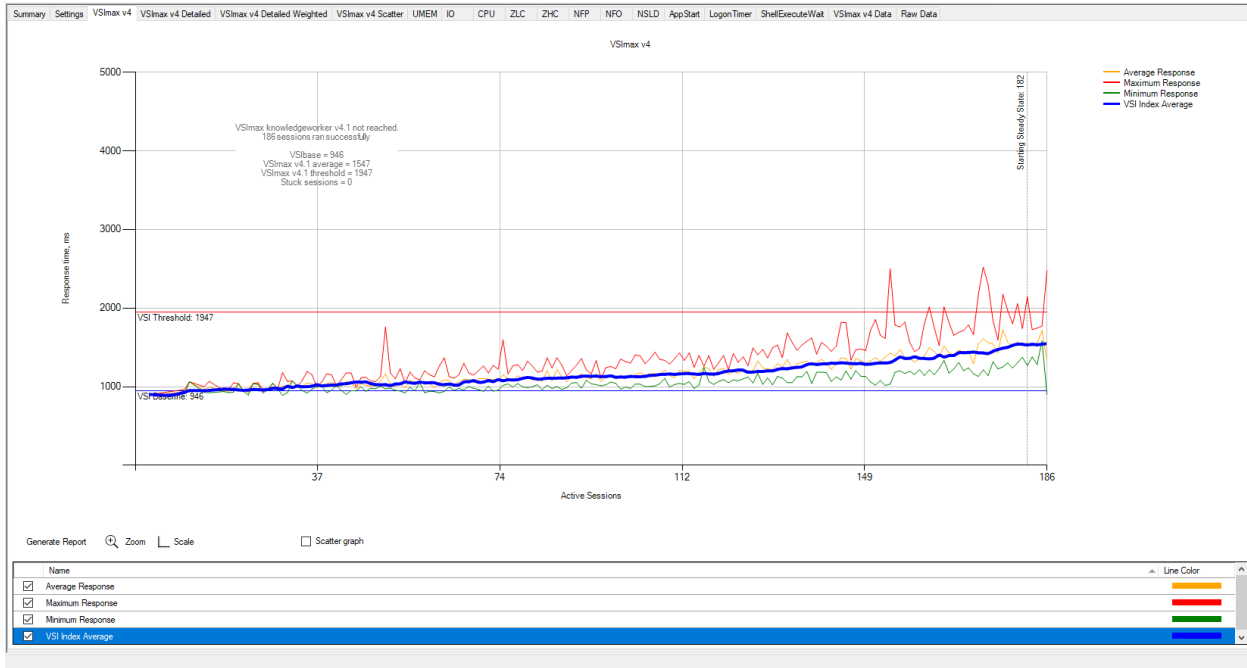

Performance data for the server running the workload is as follows:

**Figure 89. Single Server Recommended Maximum Workload | Horizon 7.12 VDI-P | Host CPU Utilization**

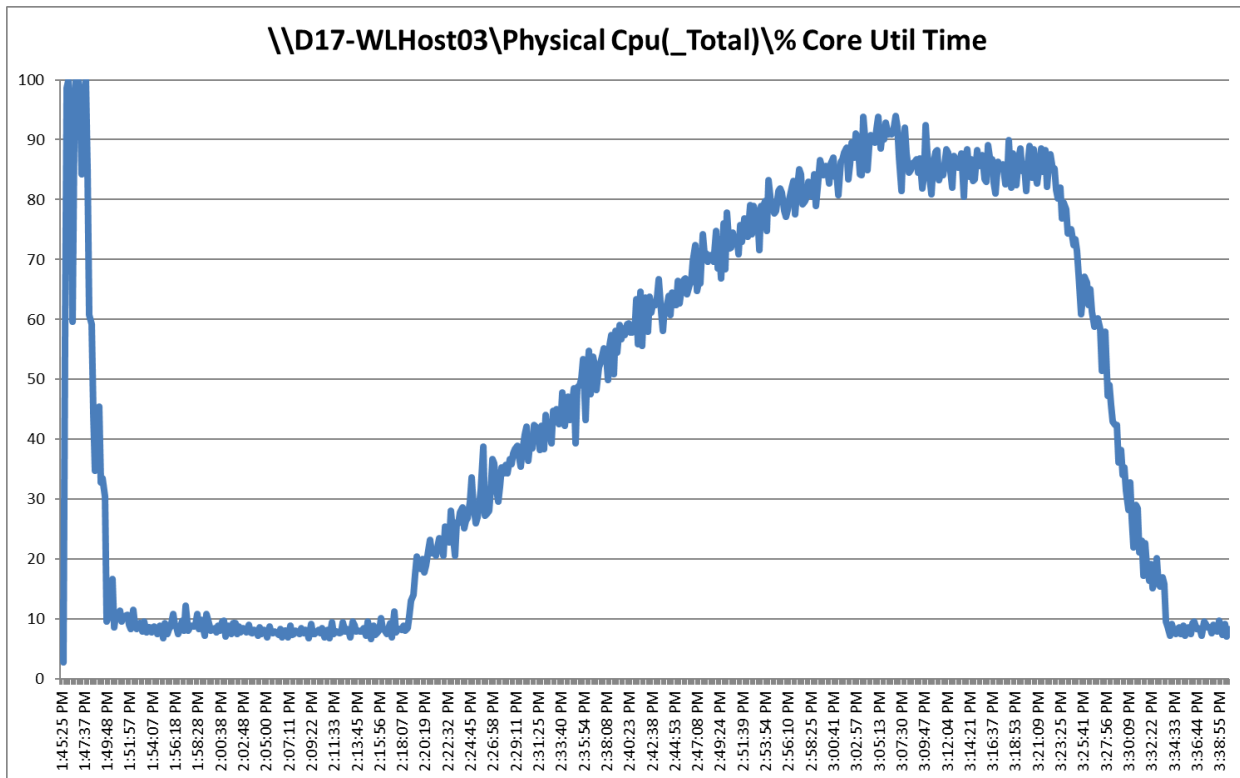

Figure 90. Single Server Recommended Maximum Workload | Horizon 7.12 VDI-P | Host Memory Utilization

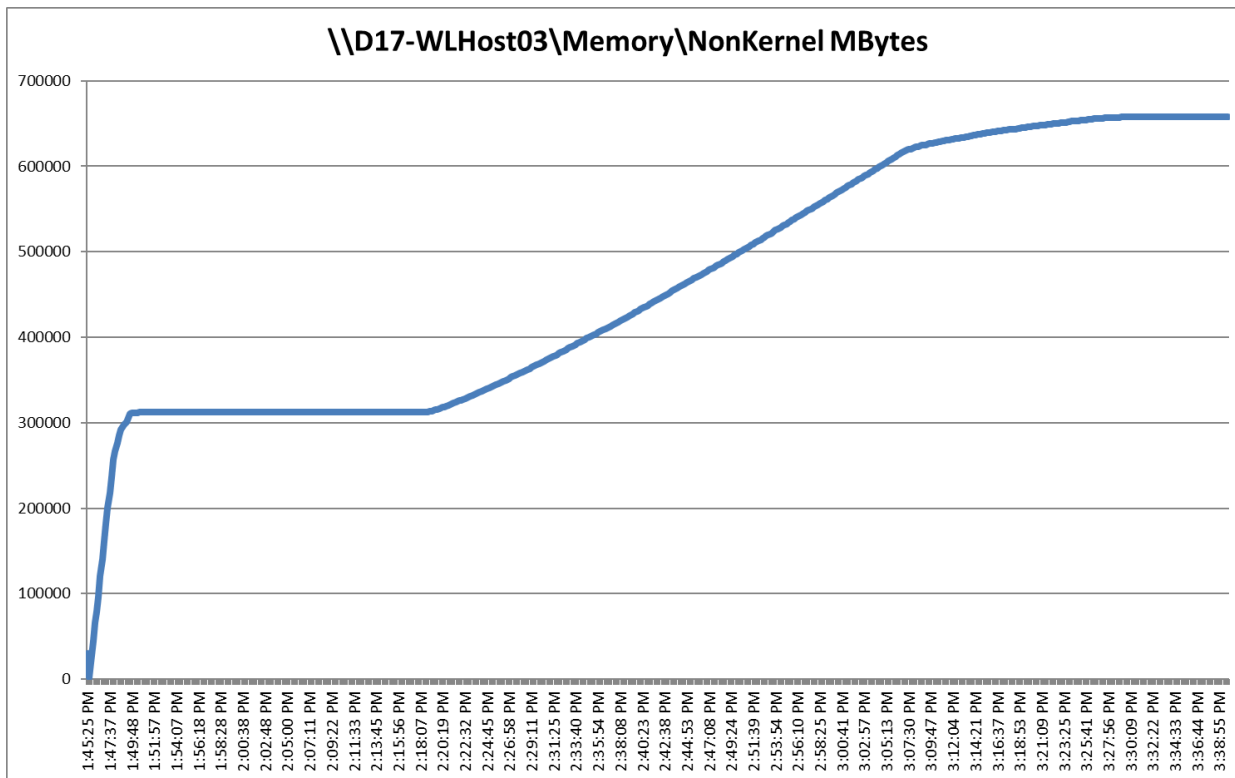
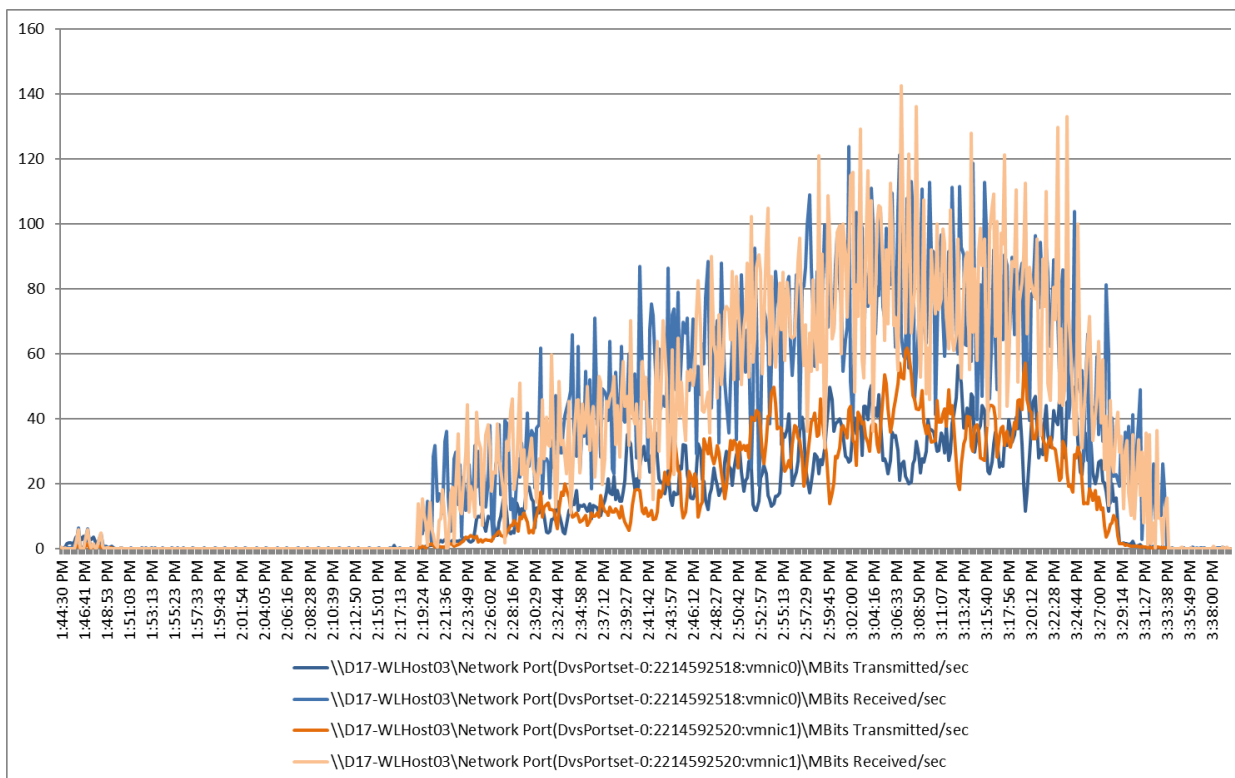

Figure 91. Single Server | Horizon 7.12 VDI-P | Host Network Utilization



## Cluster Recommended Maximum Workload Testing

This section shows the key performance metrics that were captured on the Cisco UCS host blades during the cluster testing to determine the per host server workload in the N+1 environment. The cluster testing comprised of three tests: 2016 RDS sessions, 1674 VDI Non-Persistent sessions, and 1674 VDI Persistent sessions.

### Cluster Workload Testing with 2016 RDS Users

The cluster testing was comprised of 2016 RDS sessions using 10 workload blades.

As per the Cisco Test Protocol for VDI solutions, all sessions were launched within 48 minutes (using the official Knowledge Worker Workload in VSI Benchmark Mode) and all launched sessions became active within two minutes subsequent to the last logged in session.

The configured system efficiently and effectively delivered the following results:

**Figure 92. Ten Node Cluster | 2016 RDS Users | VSI Score**

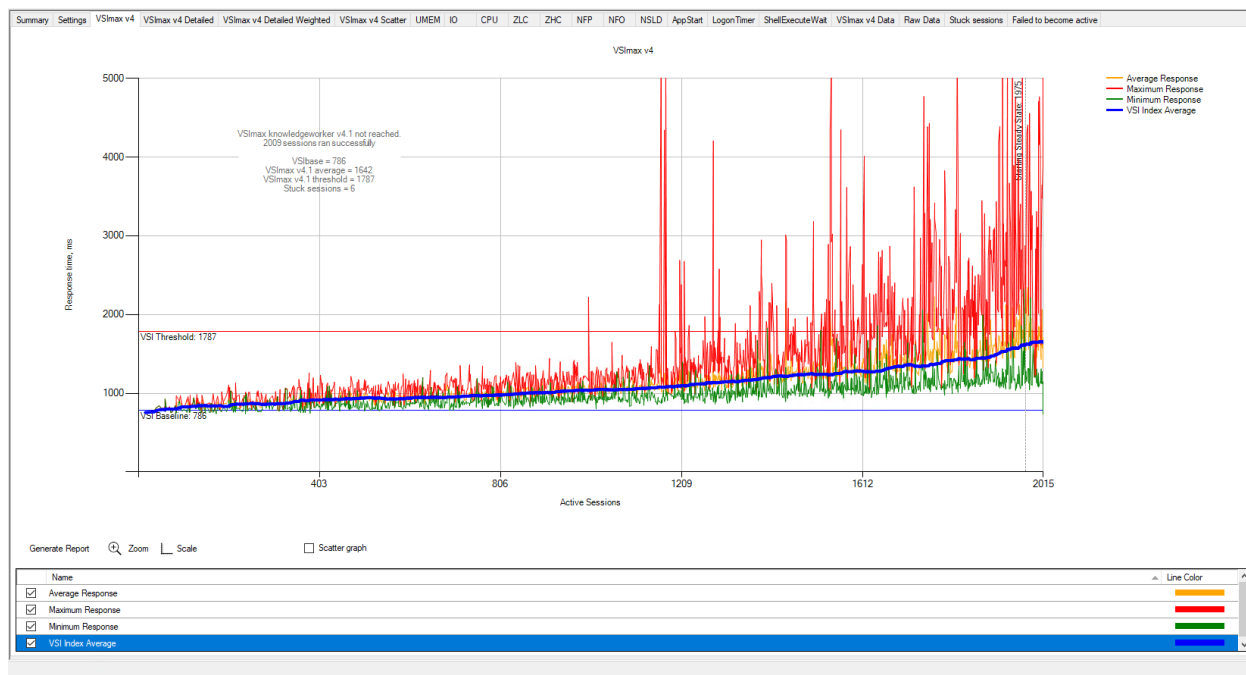

Performance data for the server running the workload is as follows:

Figure 93. Cluster | 2016 RDS Users | 10 RDS Hosts | Host CPU Utilization

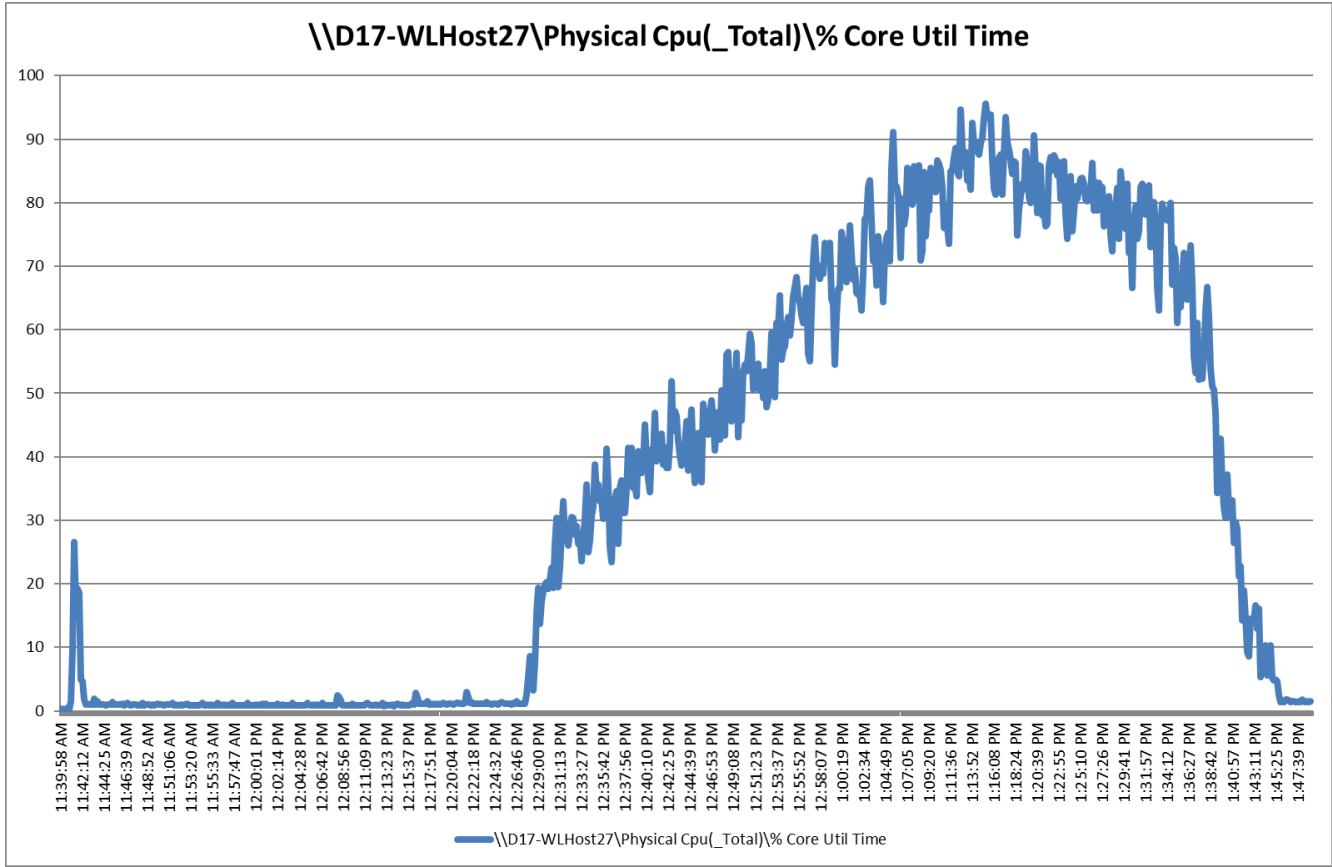
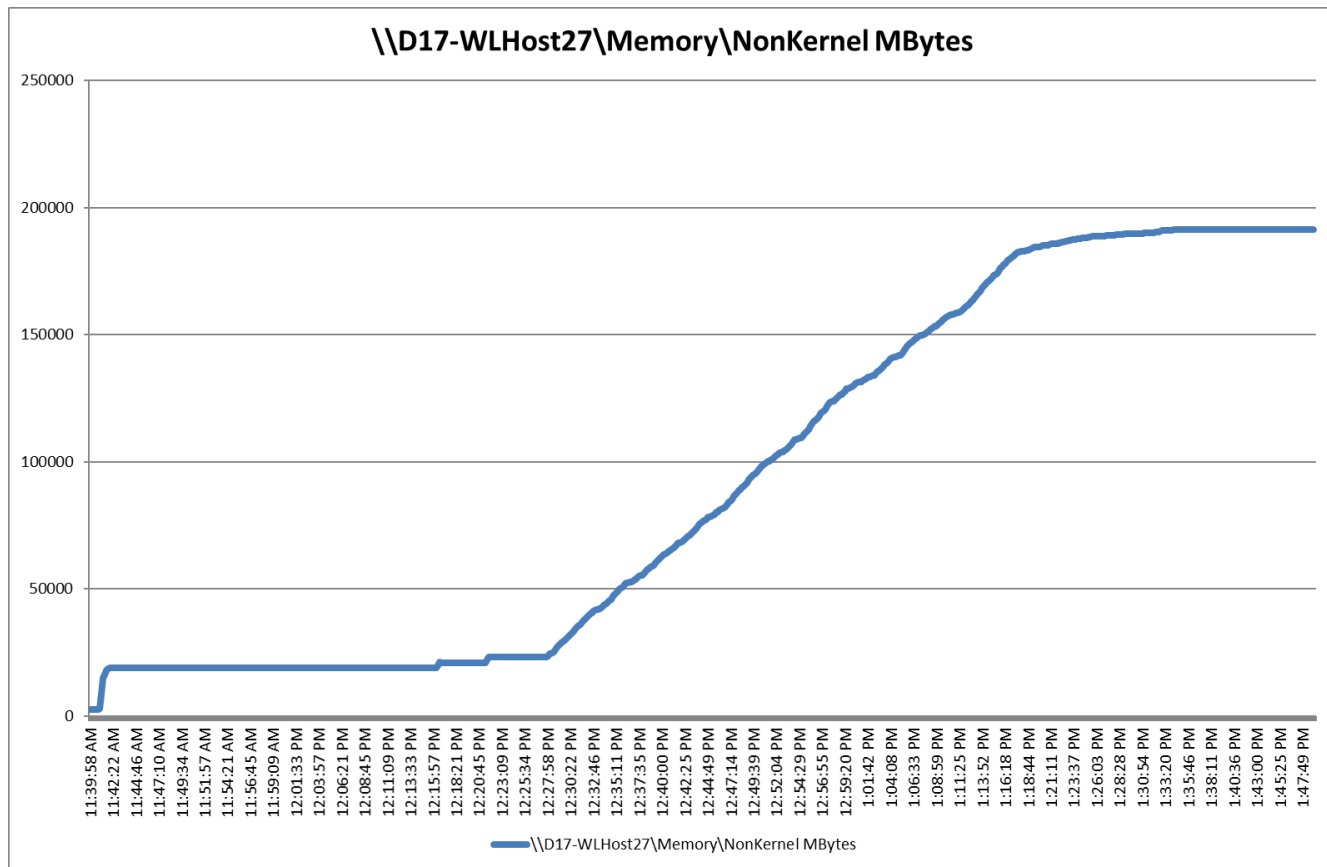
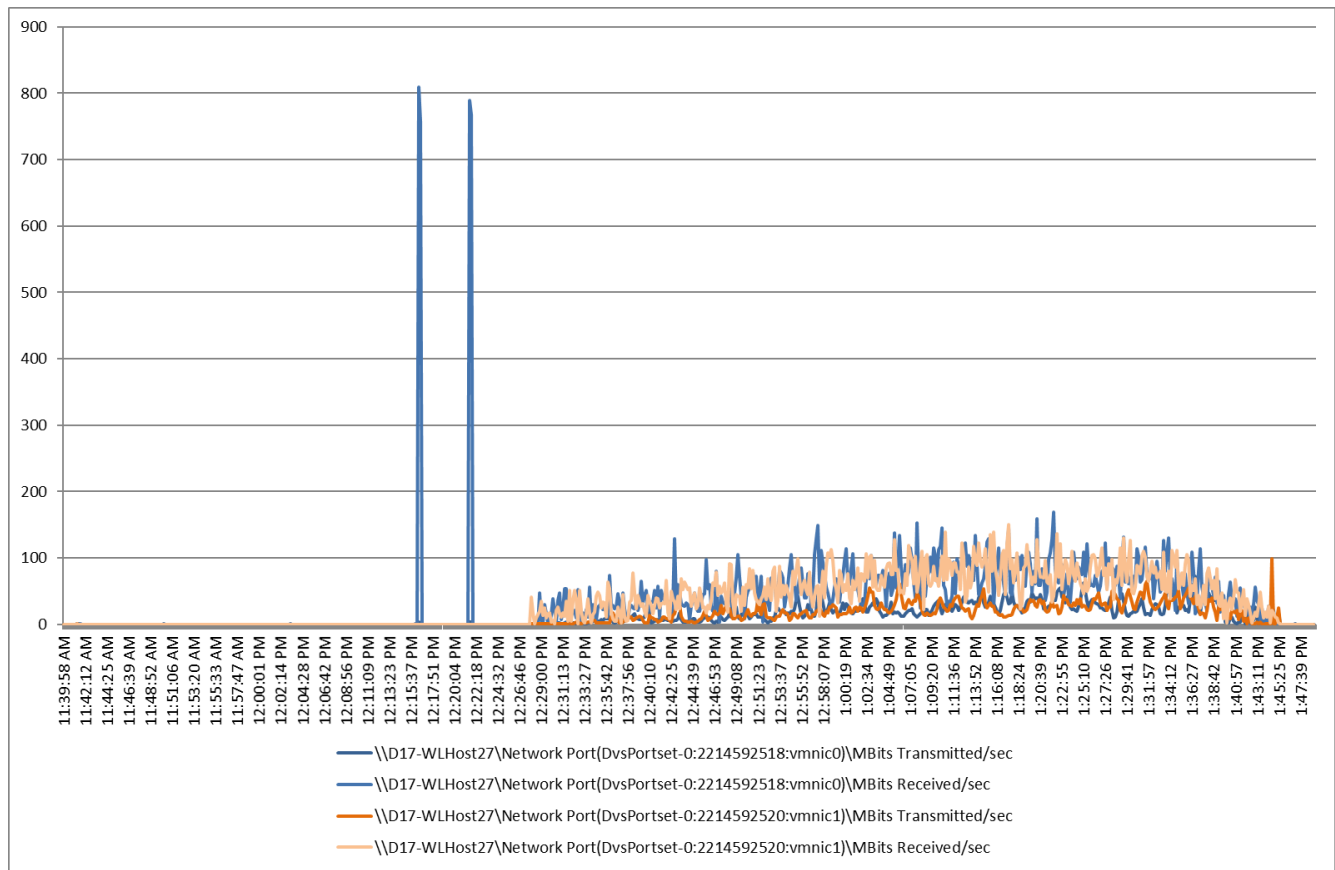

Figure 94. Cluster | 2016 RDS Users | 10 RDS Hosts | Host Memory Utilization





**Figure 95. Cluster | 2016 RDS Users | 10 RDS Hosts | Host System Uplink Network Utilization**



### Cluster Workload Testing with 1674 Non-Persistent Desktop Users

This section describes the key performance metrics that were captured on the Cisco UCS, Pure Storage FlashArray array, and Infrastructure virtual machines during the non-persistent desktop testing. The cluster testing comprised of 1674 VDI non-persistent desktop sessions using 10 workload blades.

The workload for the test is 1674 VDI non-persistent desktop users. To achieve the target, sessions were launched against all workload clusters concurrently. As per the Cisco Test Protocol for VDI solutions, all sessions were launched within 48 minutes (using the official Knowledge Worker Workload in VSI Benchmark Mode) and all launched sessions became active within two minutes subsequent to the last logged in session.

The configured system efficiently and effectively delivered the following results:

**Figure 96. Cluster | 1674 VDI-NP Users | VSI Score**

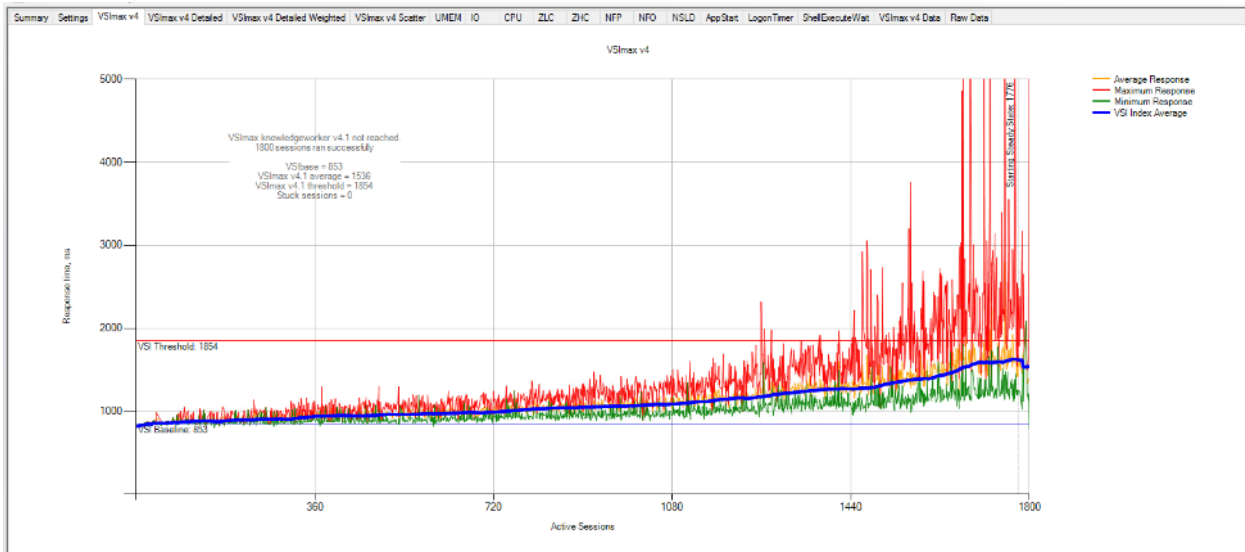

**Figure 97. Cluster | 1674 VDI-NP Users | Non-Persistent Hosts | Host CPU Utilization**

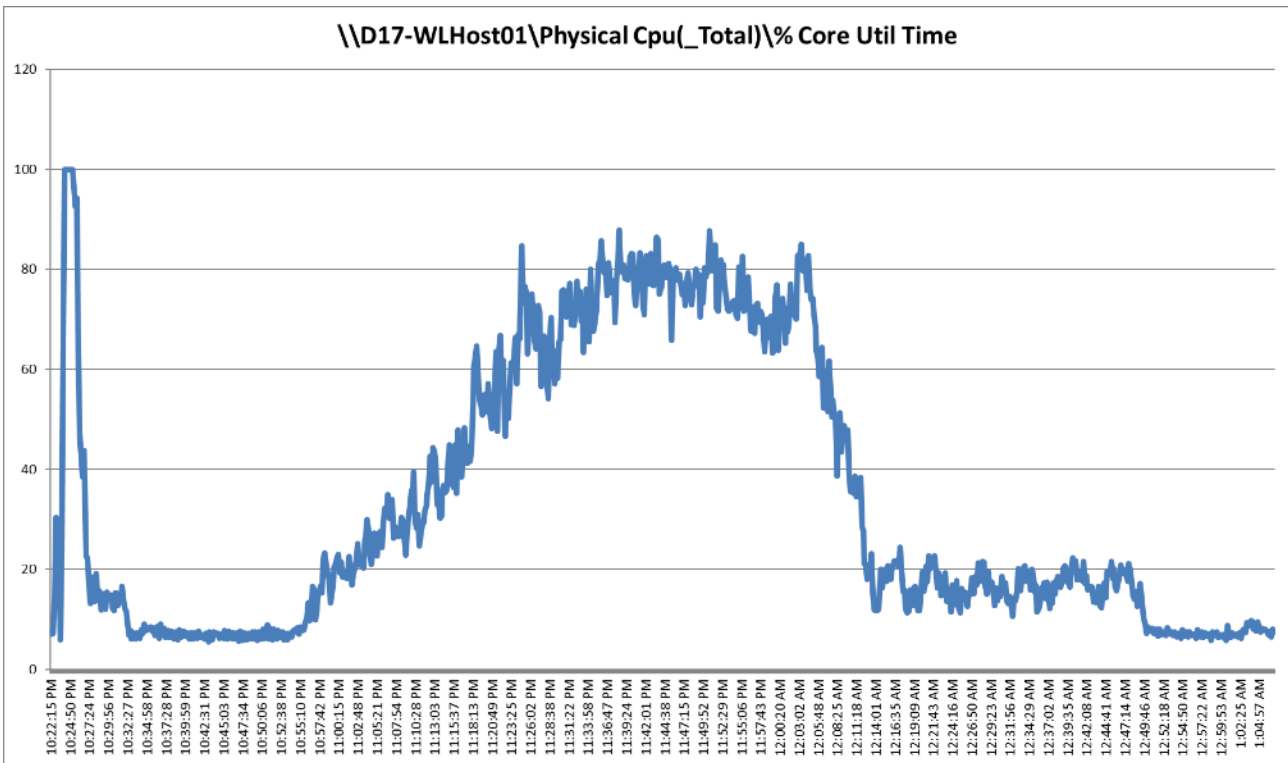

Figure 98. Cluster | 1674 VDI-NP Users | Non-Persistent Hosts | Host Memory Utilization

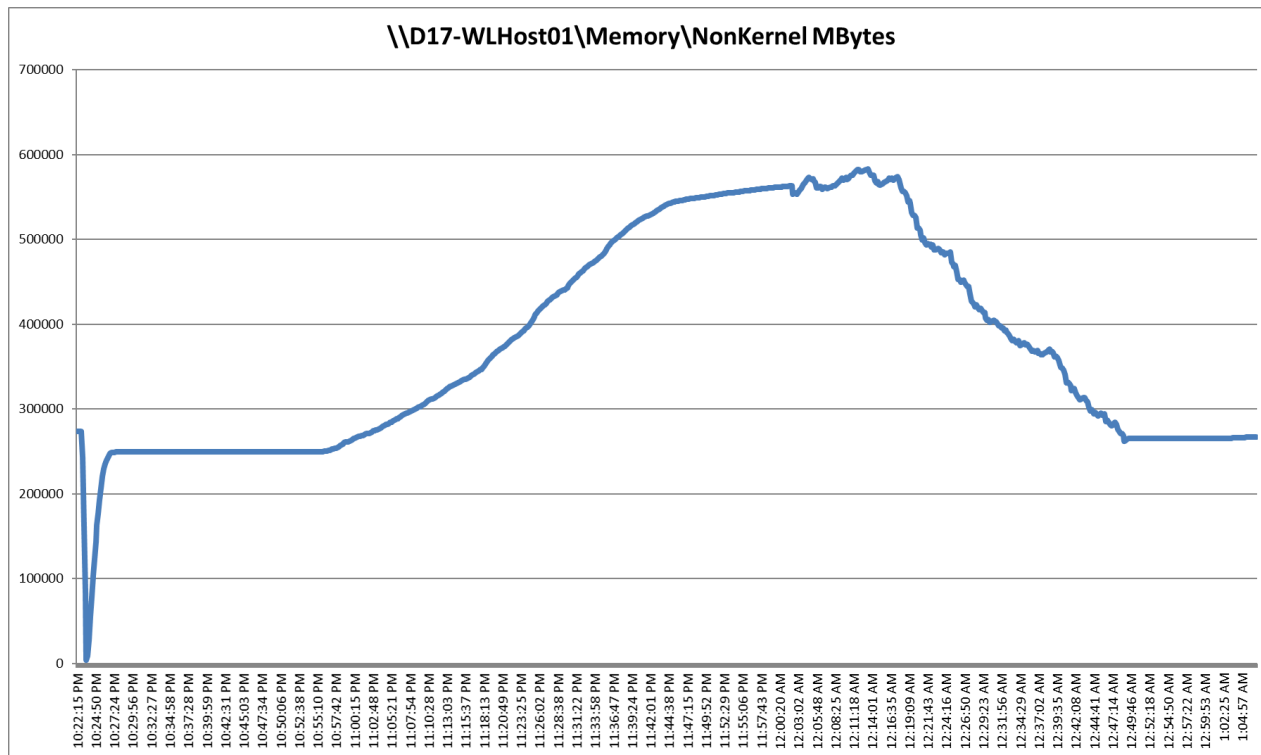
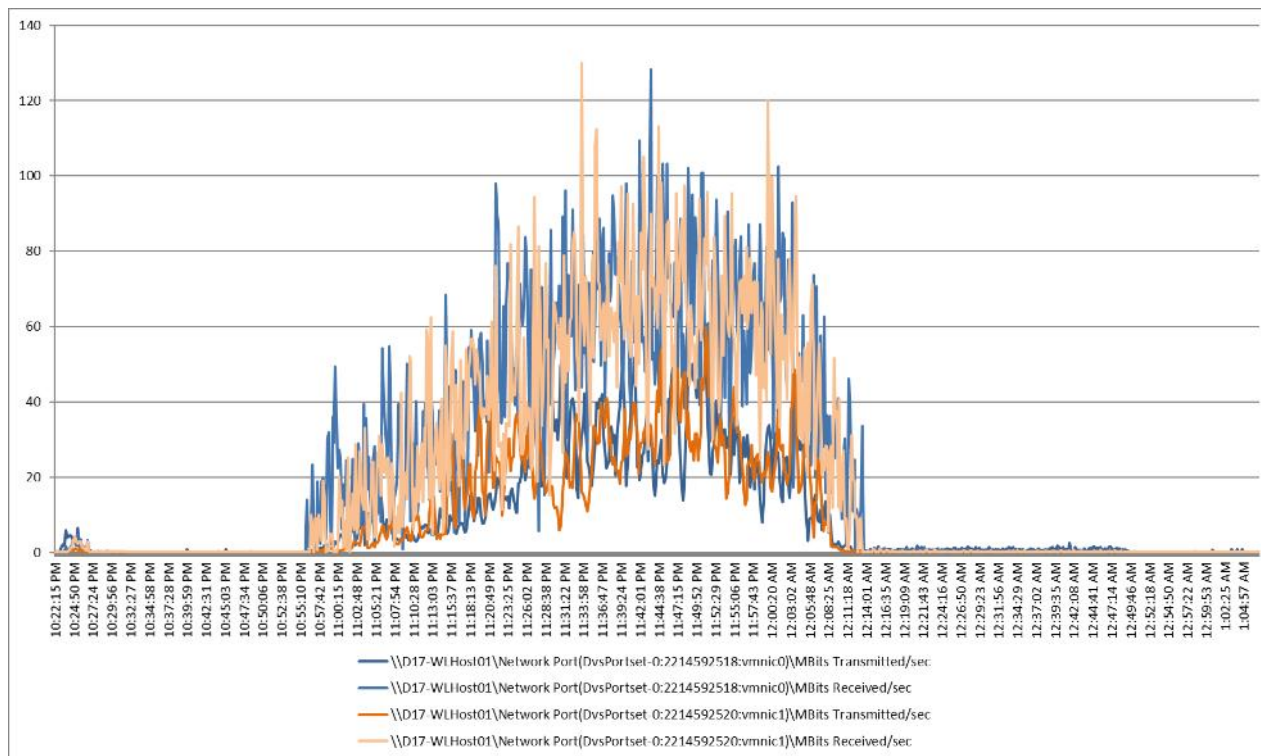

Figure 99. Cluster | 1674 VDI-NP Users | Non-Persistent Hosts | Host Network Utilization



## Cluster Workload Testing with 1674 Persistent Desktop Users

This section describes the key performance metrics that were captured on the Cisco UCS, Pure Storage FlashArray array, and Infrastructure virtual machines during the persistent desktop testing. The cluster testing with comprised of 1674 VDI Persistent desktop sessions using 10 workload blades.

The workload for the test is 1674 VDI persistent desktop users. To achieve the target, sessions were launched against all workload clusters concurrently. As per the Cisco Test Protocol for VDI solutions, all sessions were launched within 48 minutes (using the official Knowledge Worker Workload in VSI Benchmark Mode) and all launched sessions became active within two minutes subsequent to the last logged in session.

The configured system efficiently and effectively delivered the following results:

**Figure 100. Cluster | 1674 VDI-P Users | VSI Score**

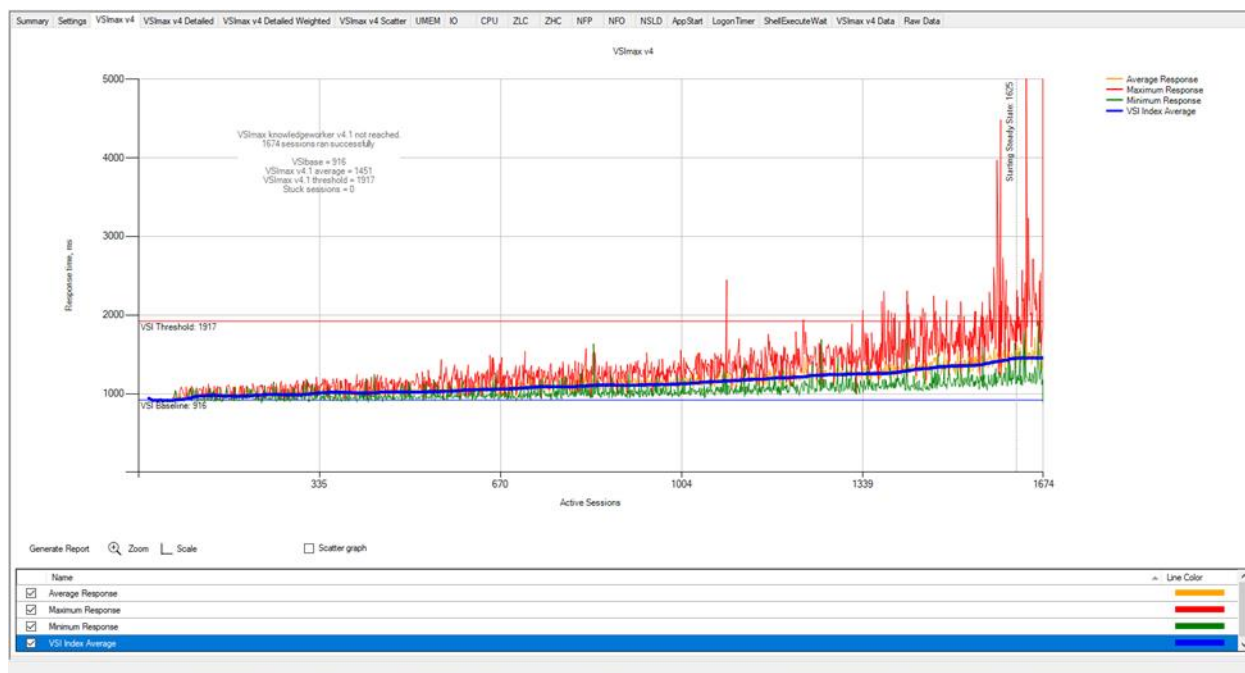

Figure 101. Cluster | 1674 VDI-P Users | Persistent Hosts | Host CPU Utilization

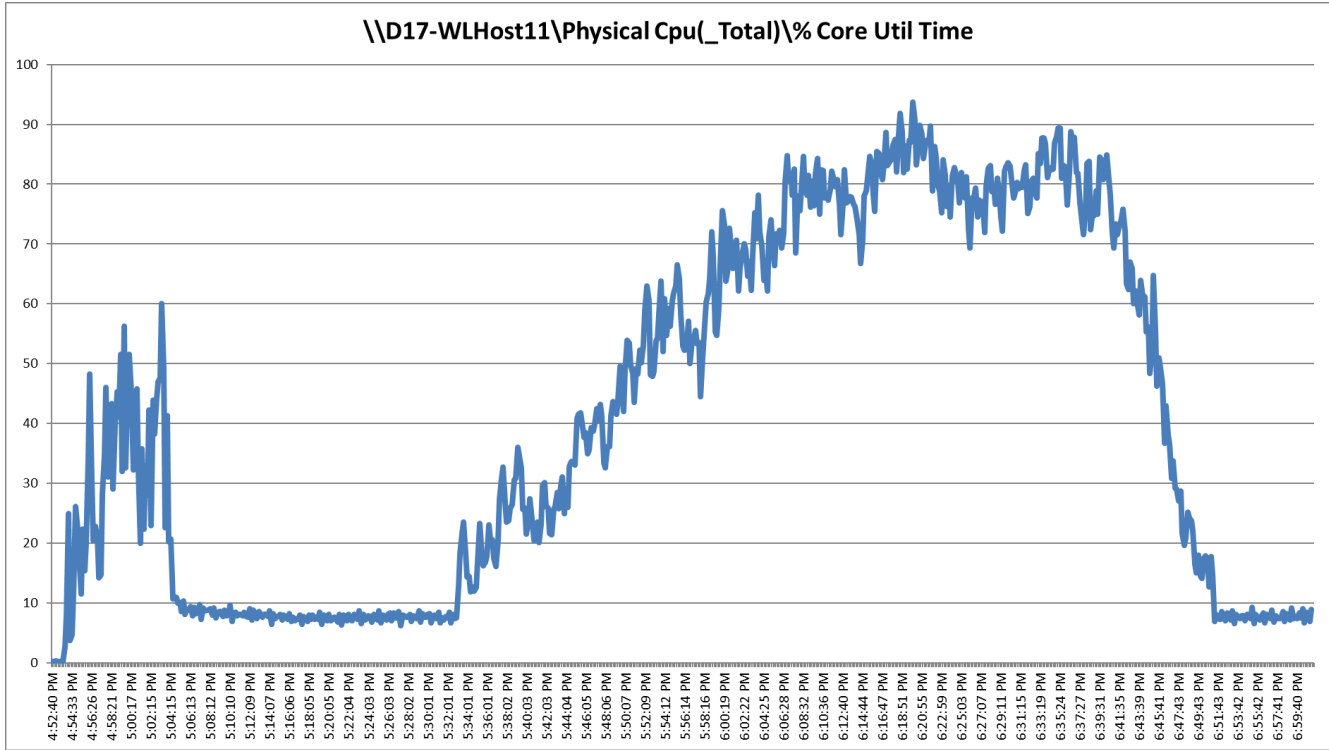
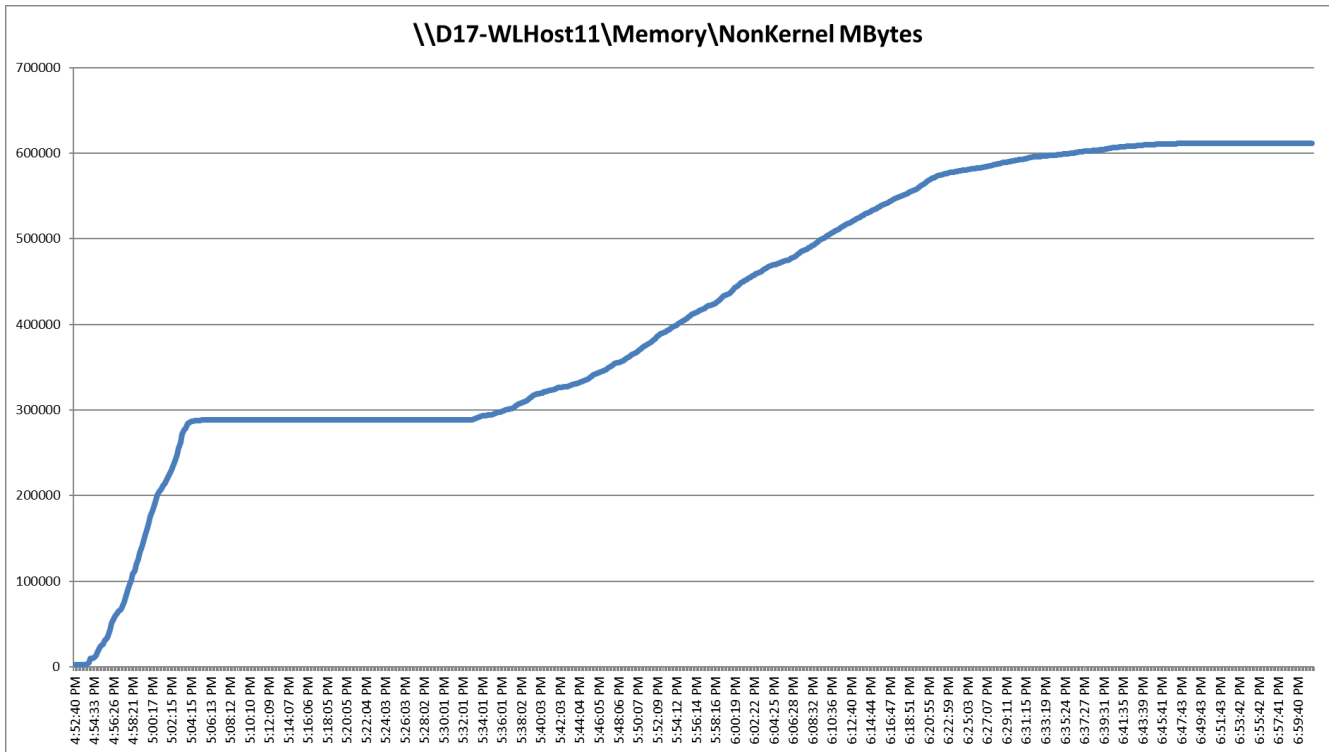
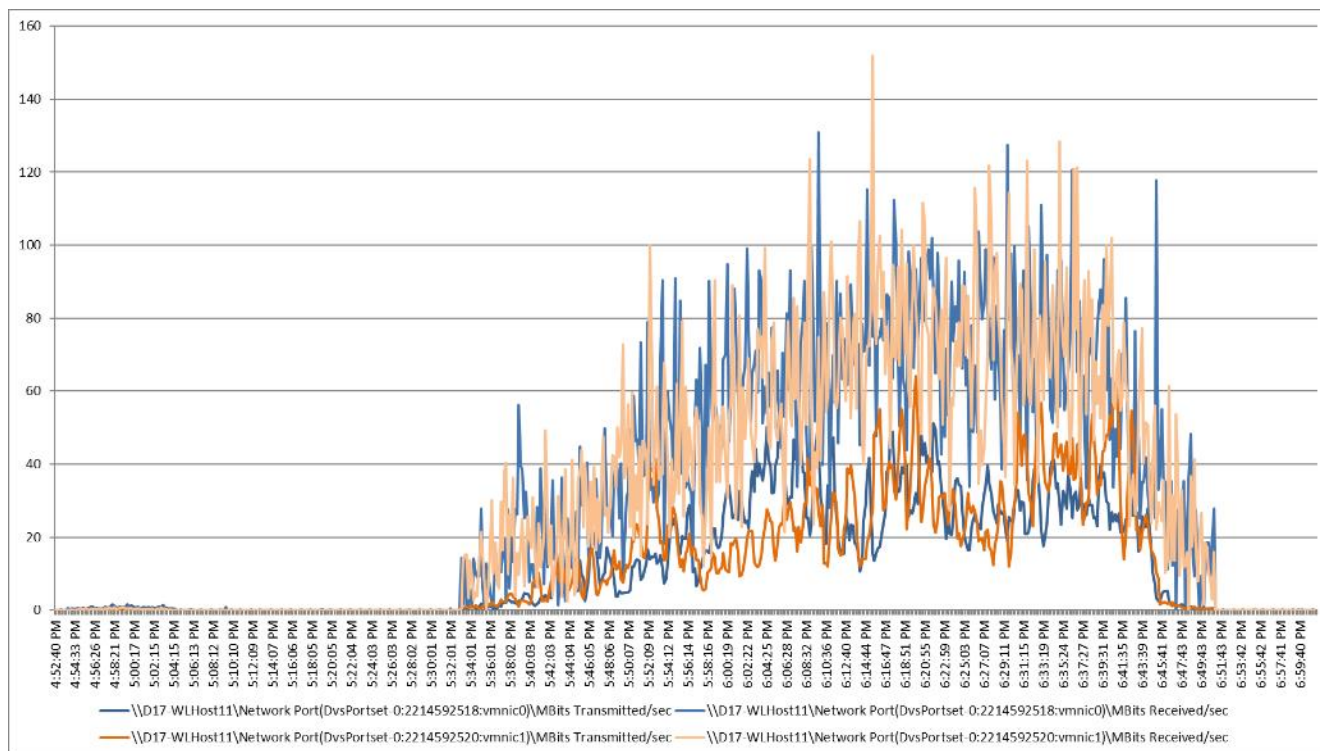

Figure 102. Cluster | 1674 VDI-P Users | Persistent Hosts | Host Memory Utilization



**Figure 103. Cluster | 1800 VDI-P Users | Persistent Hosts | Host Network Utilization**



## Full Scale Workload Testing

This section describes the key performance metrics that were captured on the Cisco UCS, during the full-scale testing. Full Scale testing Was done with following Workloads using 30 Hosts (configured in three 10 Host Pools) for workload and 2 hosts for Infrastructure VMs:

- RDS Test -6048 sessions
- VDI Non-Persistent Desktop test- 5022 users
- VDI Persistent Desktop test- 5022 users
- Mixed Test - 5363 users

To achieve the target, sessions were launched against each workload set at a time. As per the Cisco Test Protocol for VDI solutions, all sessions were launched within 48 minutes (using the official Knowledge Worker Workload in VSI Benchmark Mode) and all launched sessions became active within two minutes subsequent to the last logged in session.

### Full Scale Workload Testing with 6048 RDS Users

This section describes the key performance metrics that were captured on the Cisco UCS and Pure Storage FlashArray//X70 R3 array, during the RDS full-scale testing with 6048 Desktop Sessions using 30 blades (configured in three 10 Host Pools).

The RDS workload for the solution is 6048 users. To achieve the target, sessions were launched against all workload clusters concurrently. As per the Cisco Test Protocol for VDI solutions, all sessions were launched

within 48 minutes (using the official Knowledge Worker Workload in VSI Benchmark Mode) and all launched sessions became active within two minutes subsequent to the last logged in session.

**Figure 104. Full Scale 6048 RDS Sessions Test - Workload Distribution**

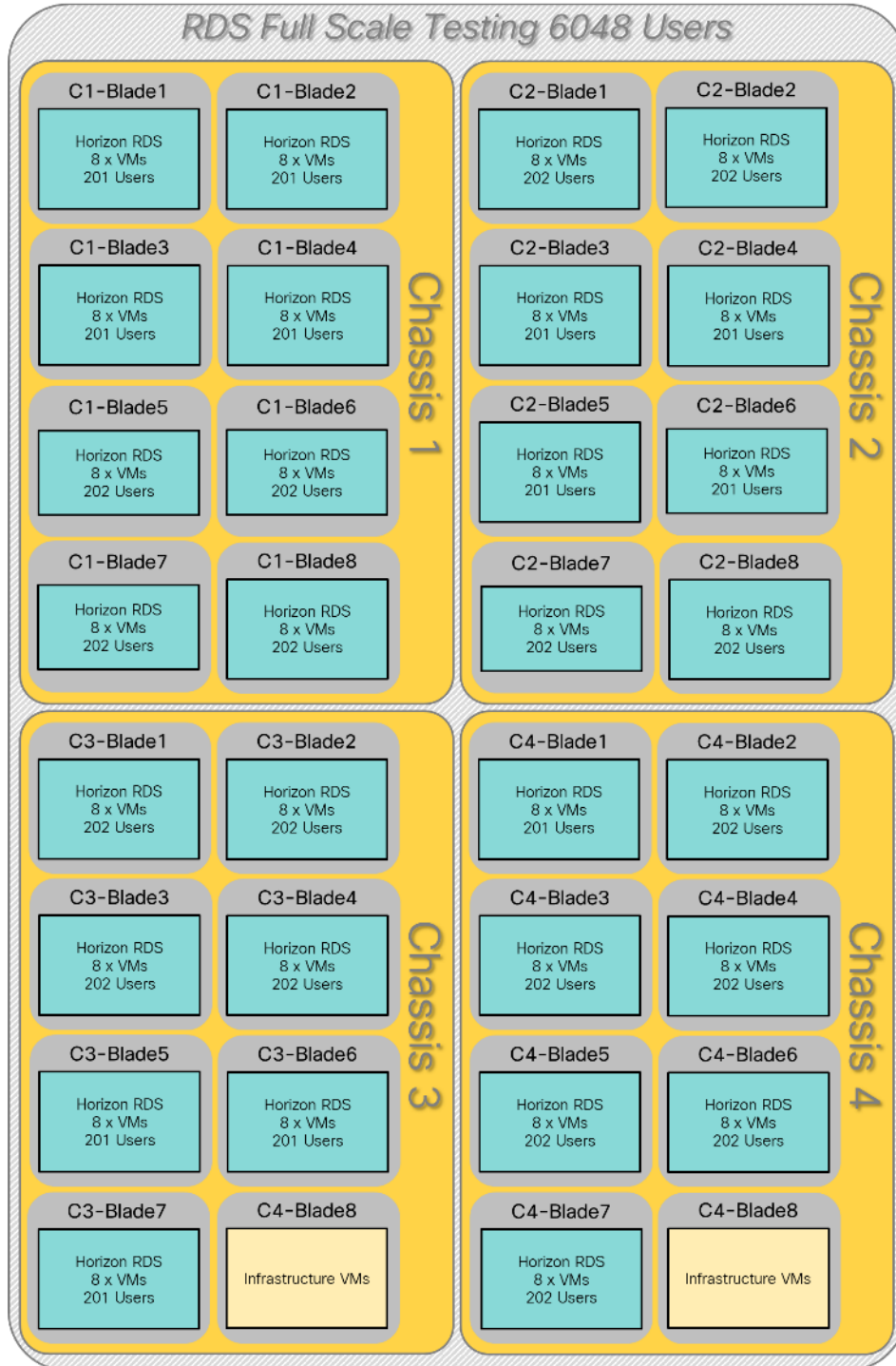

The configured system efficiently and effectively delivered the following results:



Figure 105. Full Scale | 6048 Users | Win 2019 HSD | VSI Score

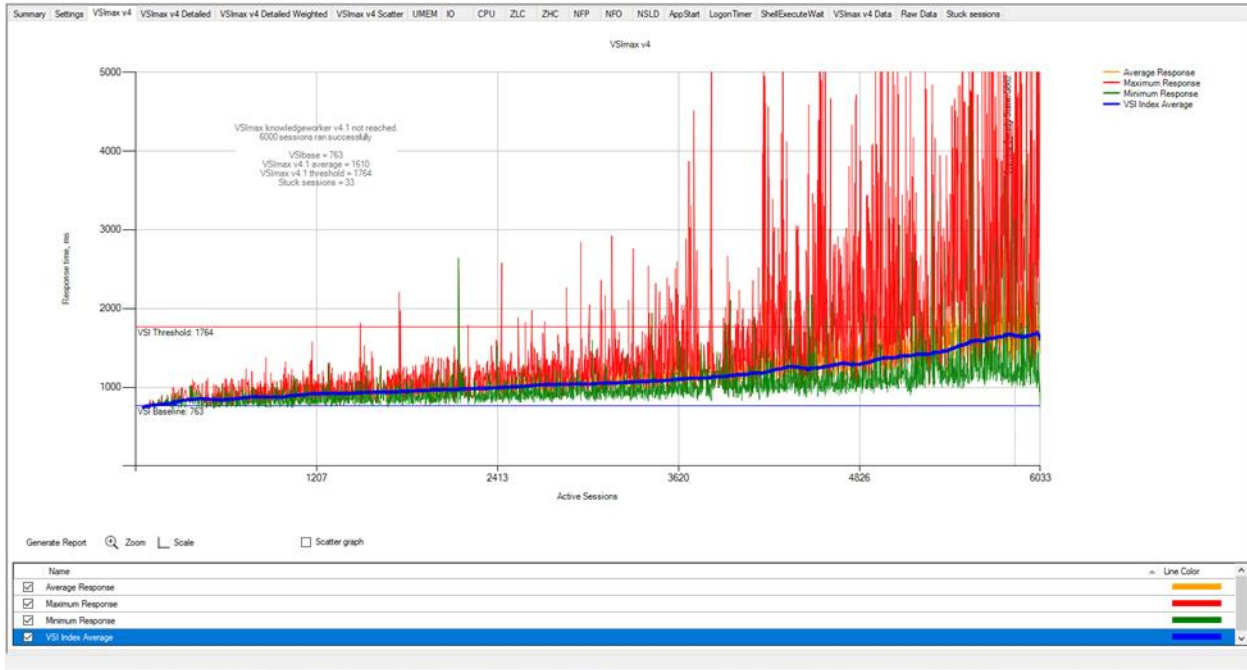

Figure 106. Full Scale | 6048 Users | Win 2019 RDS Hosts | Host CPU Utilization

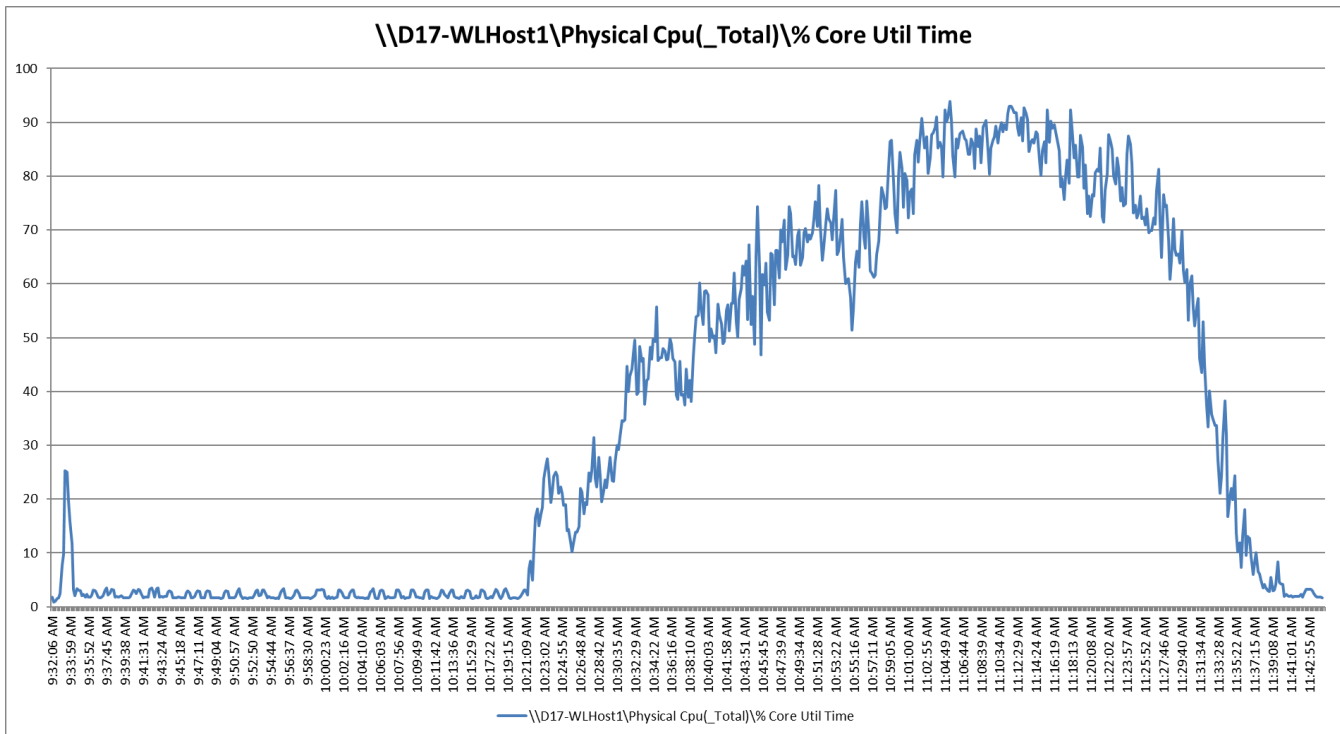



Figure 107. Full Scale | 6048 Users | Win 2019 RDS Hosts | Host Memory Utilization

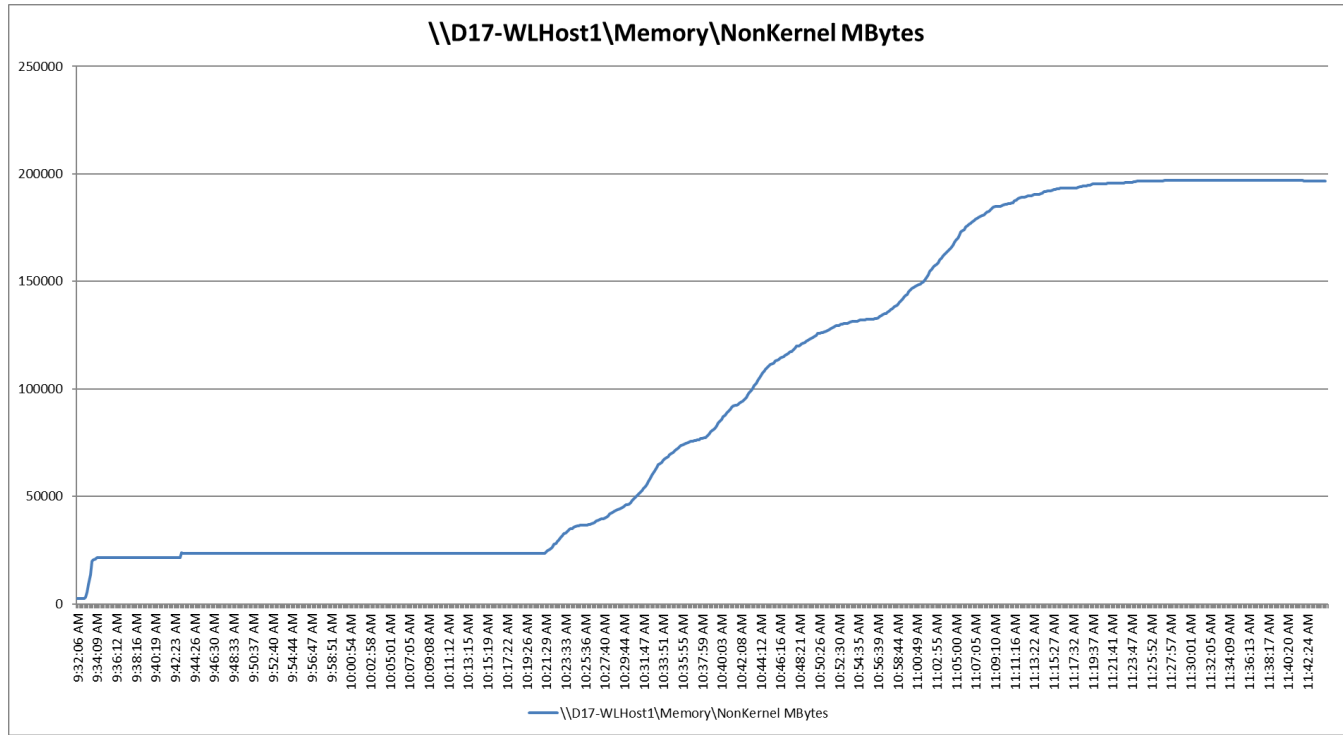
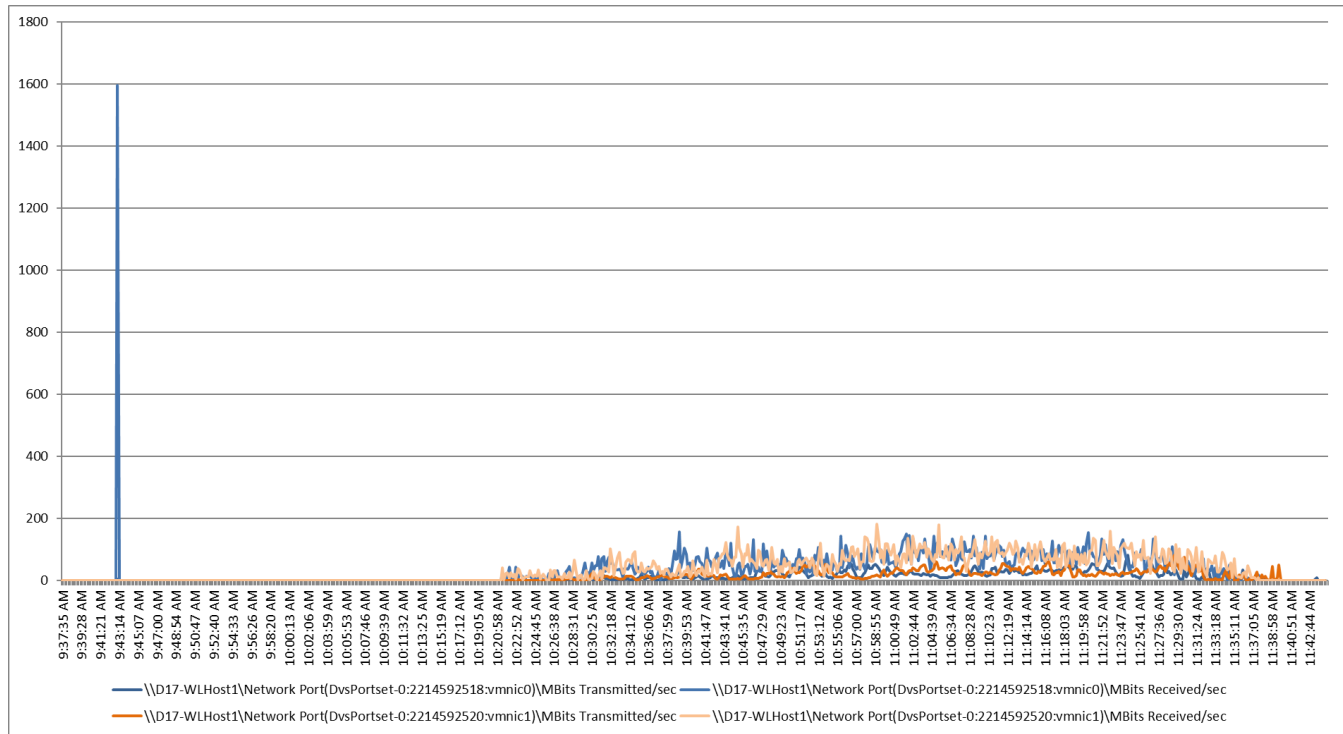

Figure 108. Full Scale | 6048 Users | Win 2019 RDS Hosts | Host Network Utilization



Pure Storage FlashArray//X70 R3 Storage System Graph for 6048 Users RDS Workload Test

Figure 109. Full Scale | 6048 Users | Win 2019 RDS Hosts | Pure Storage FlashArray//X70 R3 System Latency Chart

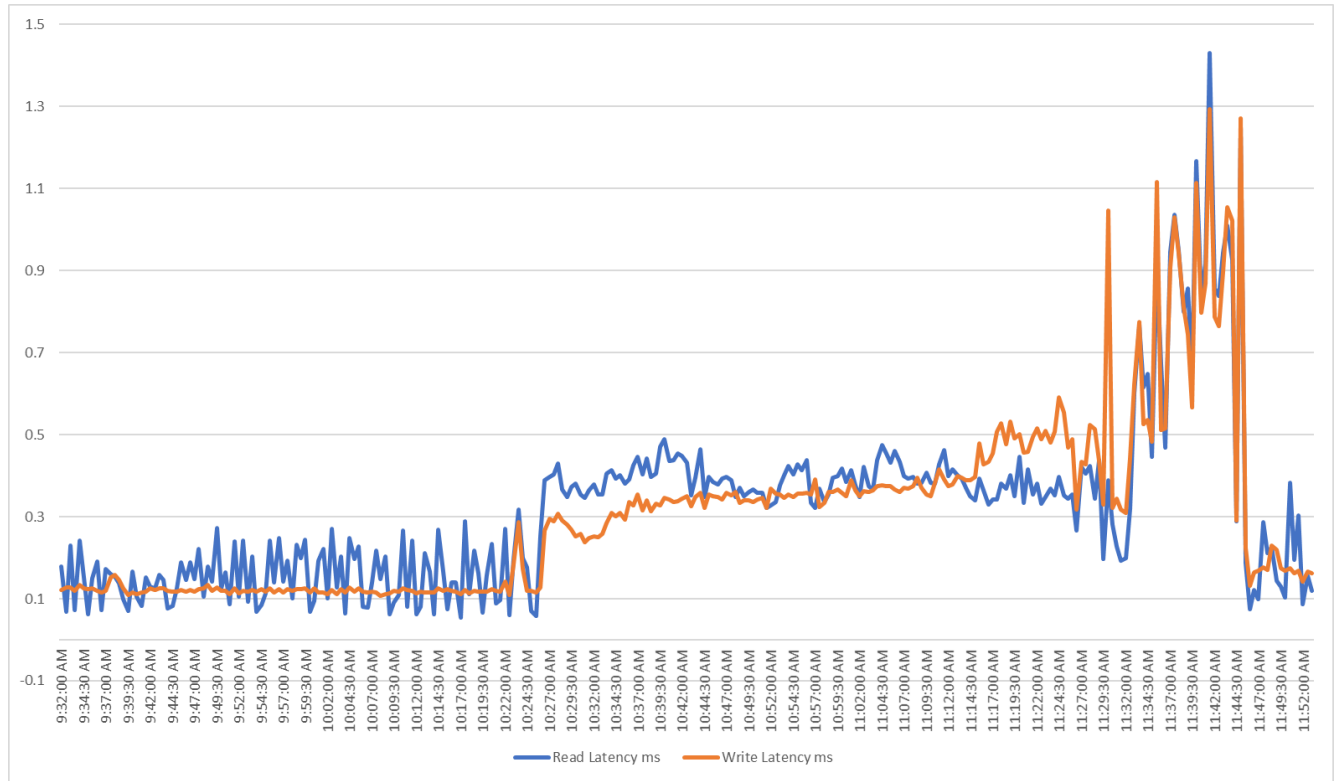
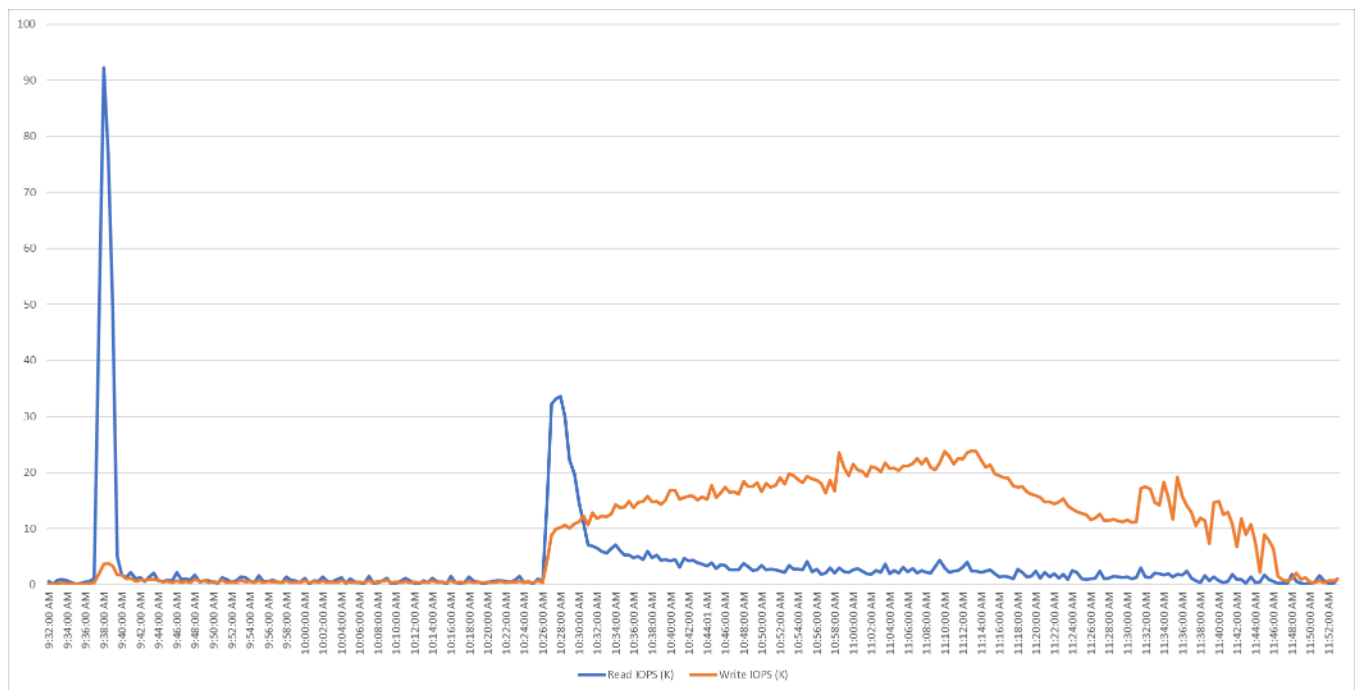
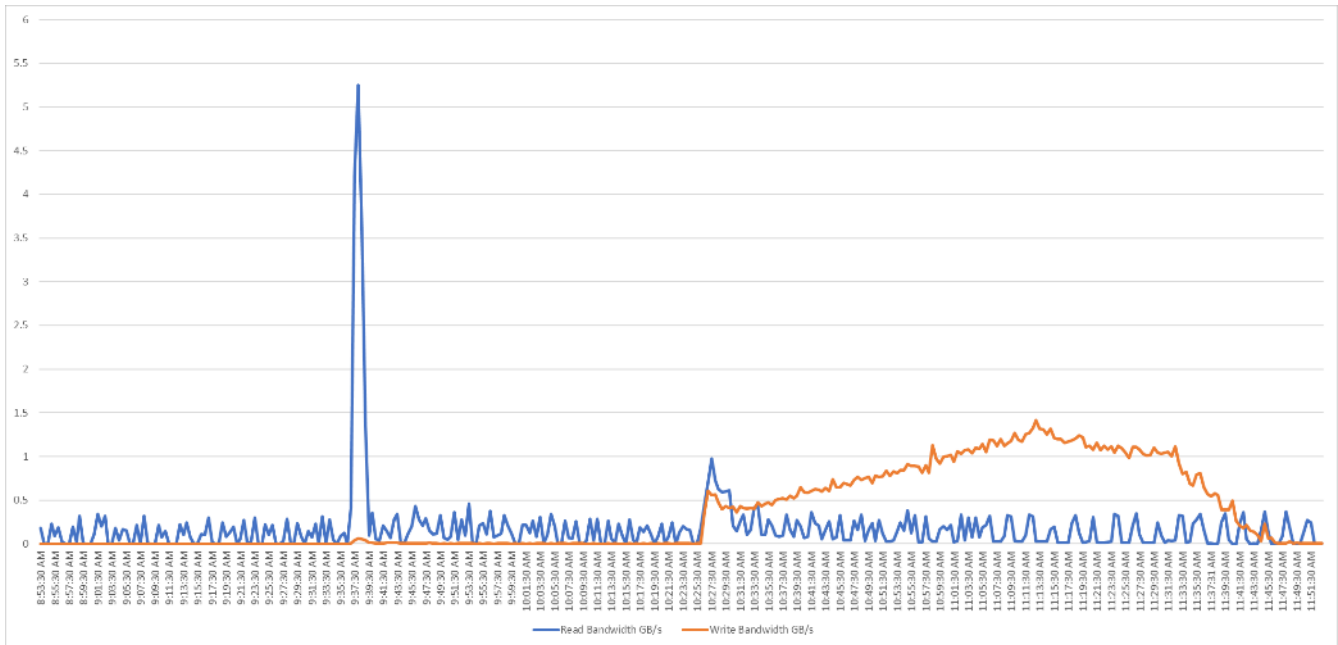

Figure 110. Full Scale | 6048 Users | Win 2019 RDS Hosts | Pure Storage FlashArray//X70 R3 System IOPS Chart



**Figure 111. Full Scale | 6048 Users | Win 2019 RDS Hosts | Pure Storage FlashArray//X70 R3 System Bandwidth Chart**



**Figure 112. Full Scale | 6048 Users | Win 2019 RDS Hosts | FlashArray//X70 R3 System Performance Chart**

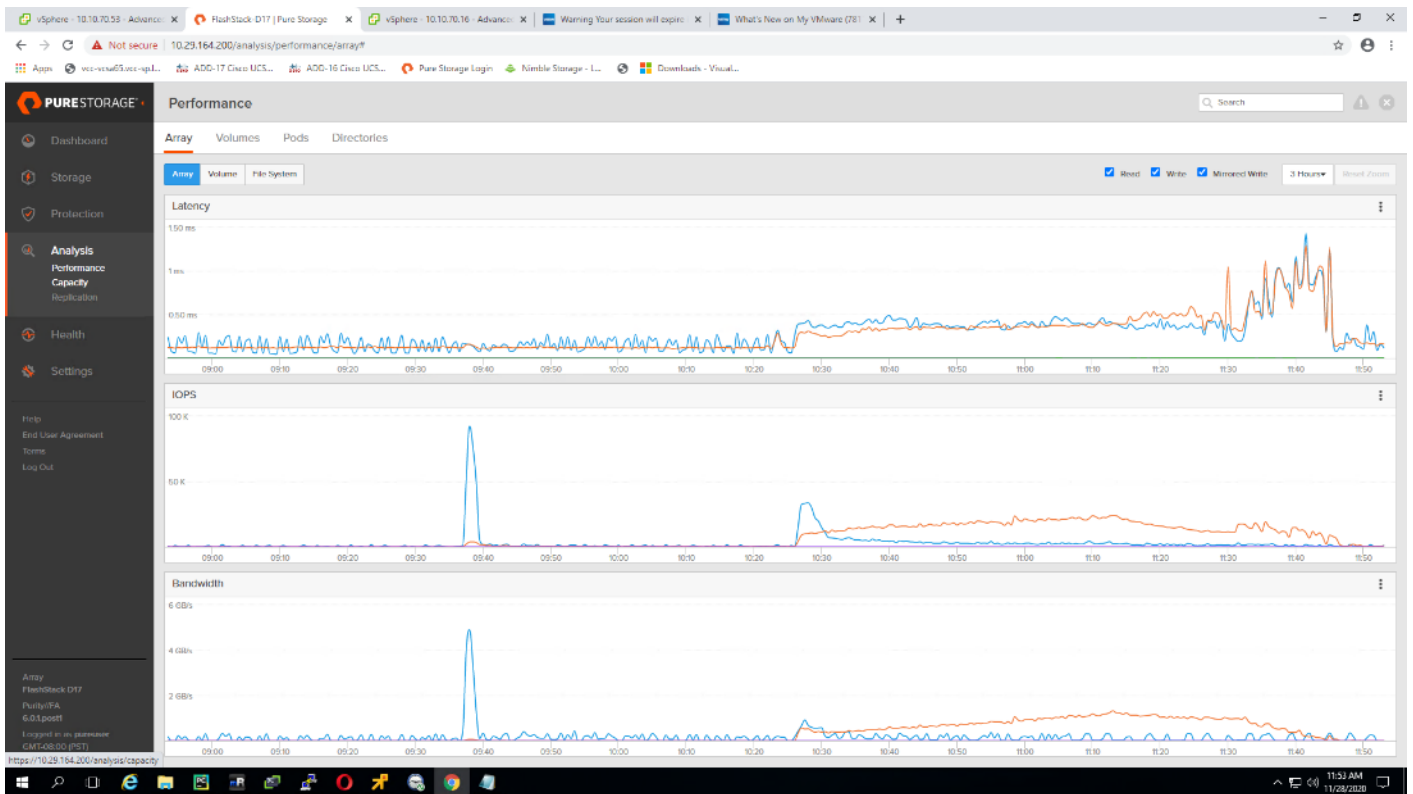

---

## **Full Scale Workload Testing with 5022 VDI Non-Persistent Users**

This section describes the key performance metrics that were captured on the Cisco UCS and Pure Storage FlashArray//X70 R3 array during the persistent desktop full-scale testing with 5022 VDI Non-Persistent desktops using 30 blades (configured in three 10 Host Pools).

The workload for the test is 5022 Non-Persistent VDI users. To achieve the target, sessions were launched against all workload clusters concurrently. As per the Cisco Test Protocol for VDI solutions, all sessions were launched within 48 minutes (using the official Knowledge Worker Workload in VSI Benchmark Mode) and all launched sessions became active within two minutes subsequent to the last logged in session.

Figure 113. Full Scale 5022 User Non-Persistent VDI Test - Workload Distribution

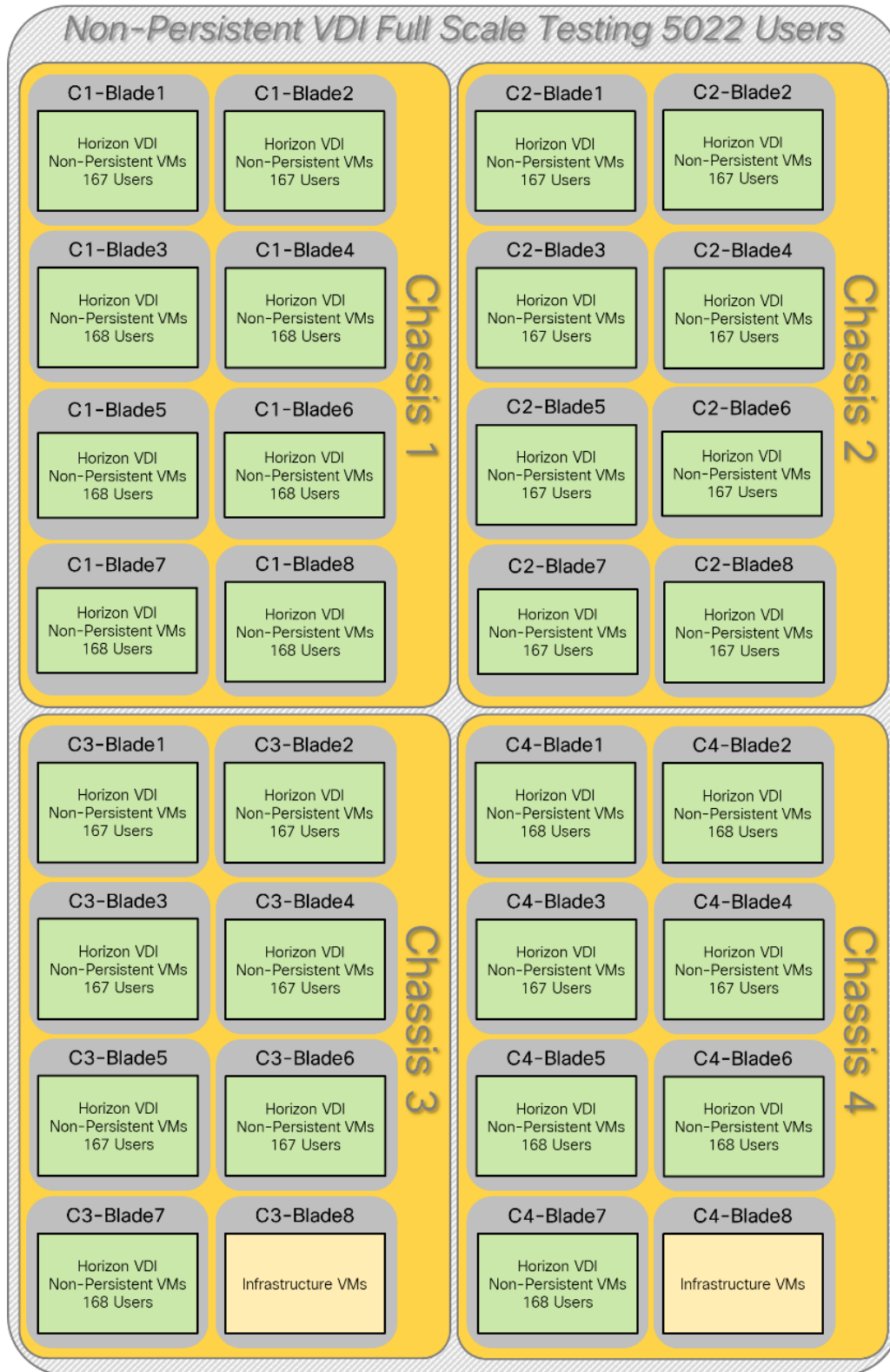

The configured system efficiently and effectively delivered the following results:

**Figure 114. Full Scale | 5500 Users | Win10 Non-Persistent Desktop | VSI Score**

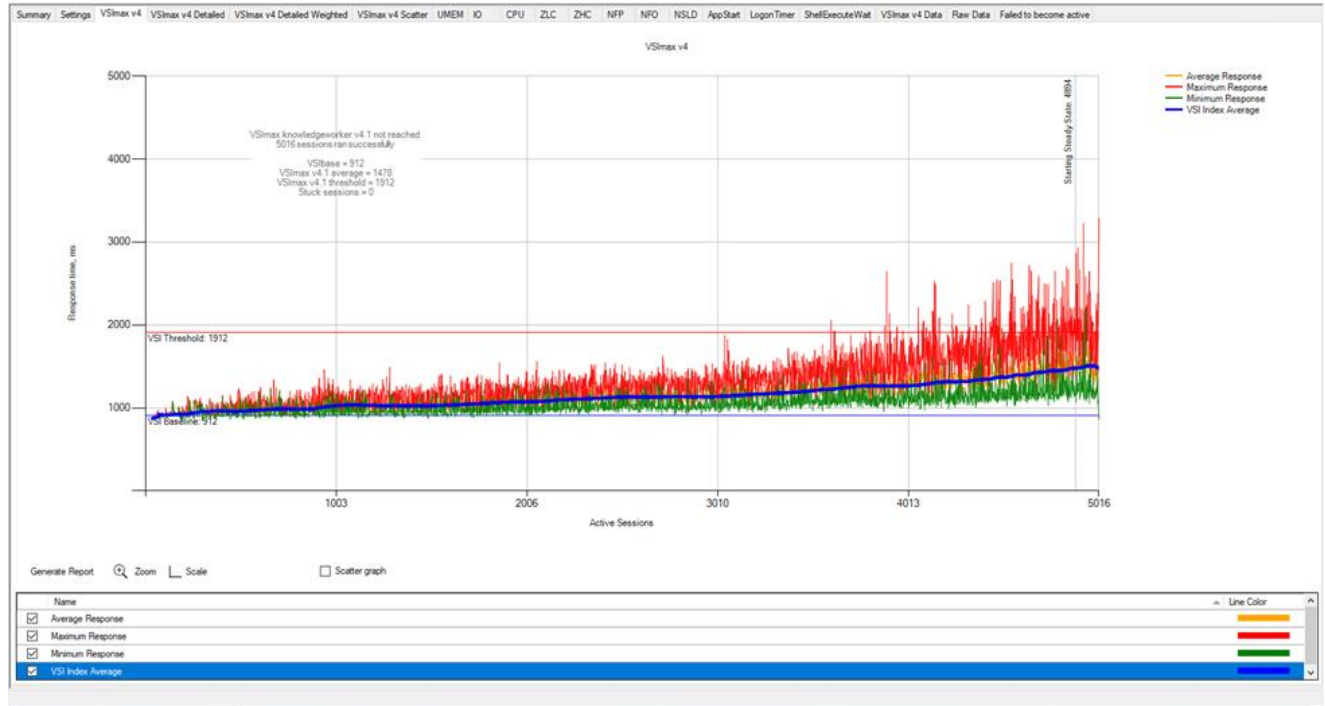

**Figure 115. Full Scale | 5022 Users | VDI Non-Persistent VM Hosts | Host CPU Utilization**

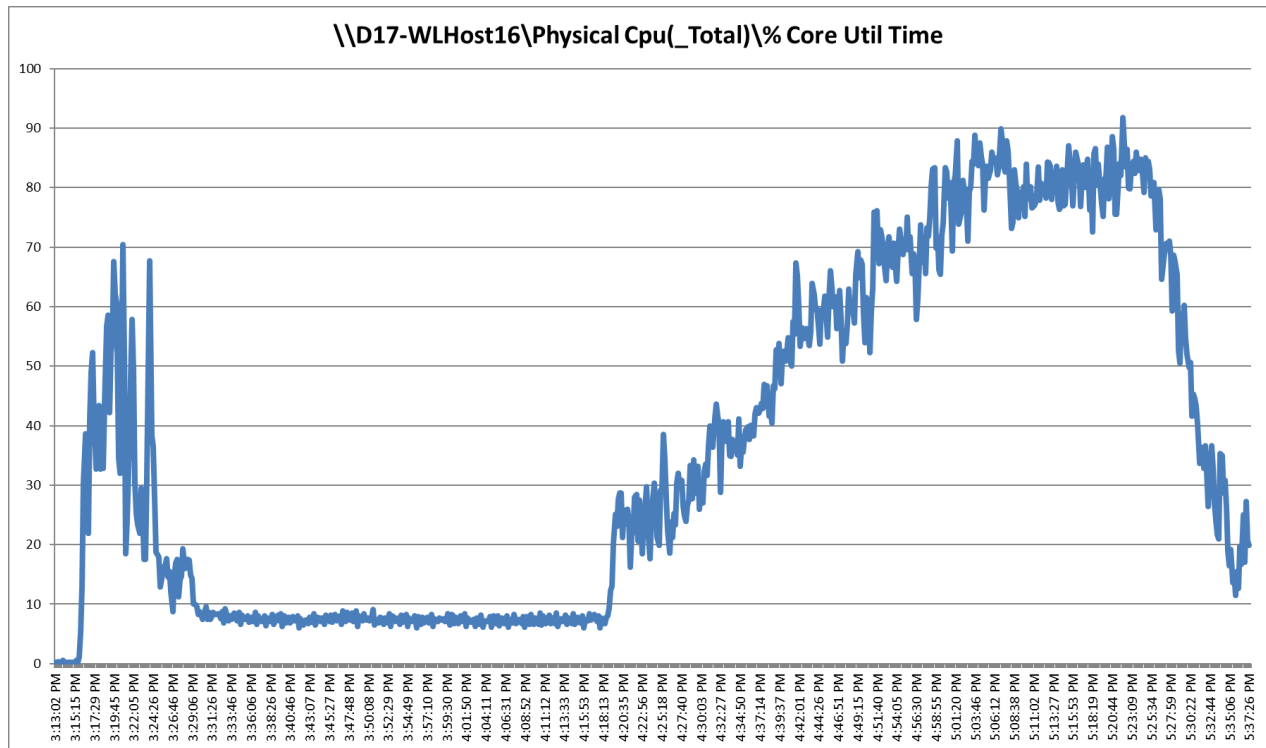

Figure 116. Full Scale | 5022 Users | VDI Non-Persistent Hosts | Host Memory Utilization

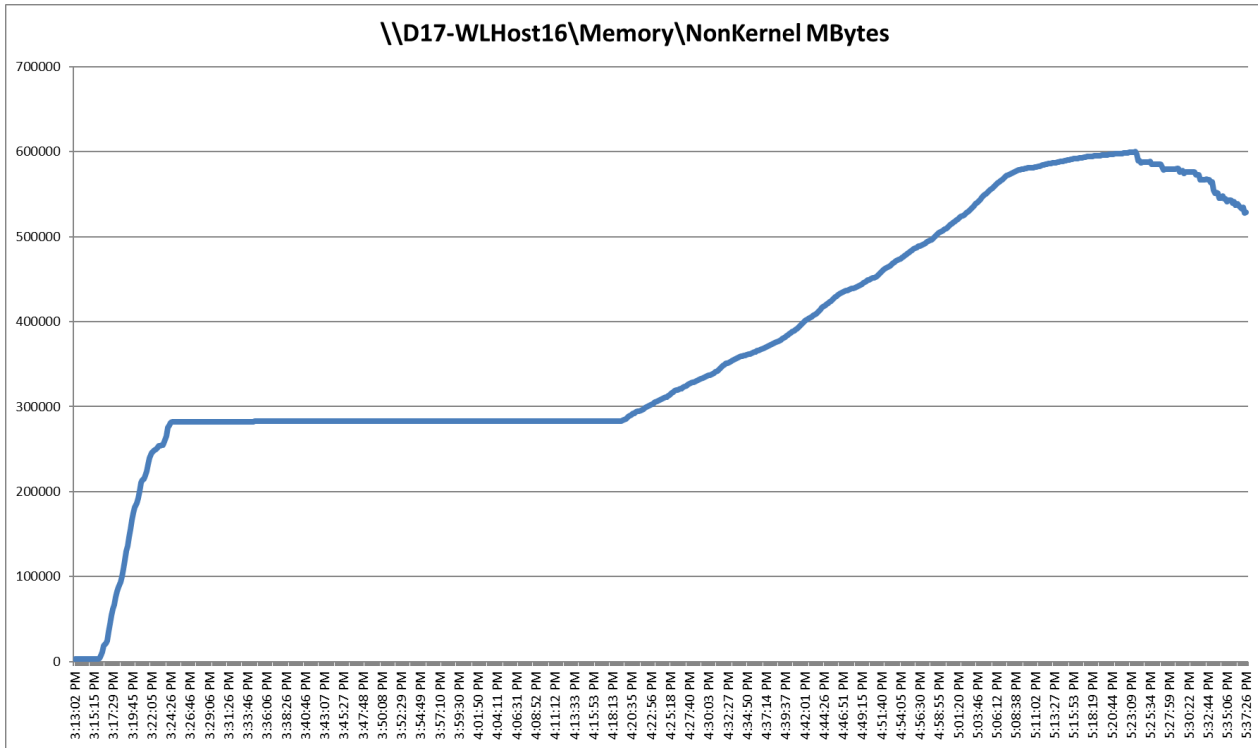
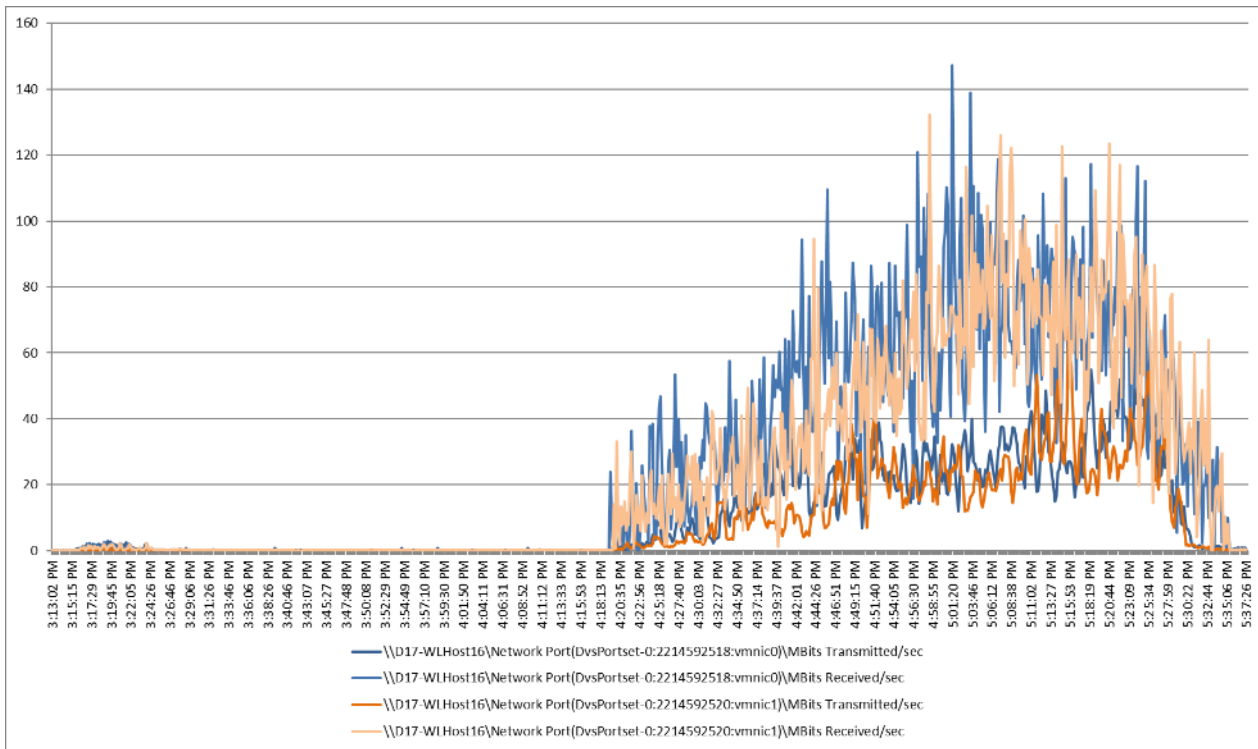

Figure 117. Full Scale | 5022 Users | VDI Non-Persistent Hosts | Host Network Utilization



## Pure Storage FlashArray//X70 R3 Storage System Graph for 5500 Non-Persistent Workload Test

Figure 118. Full Scale | 5022 Users | VDI Non-Persistent VM Hosts | Pure Storage FlashArray//X70 R3 System Latency Chart

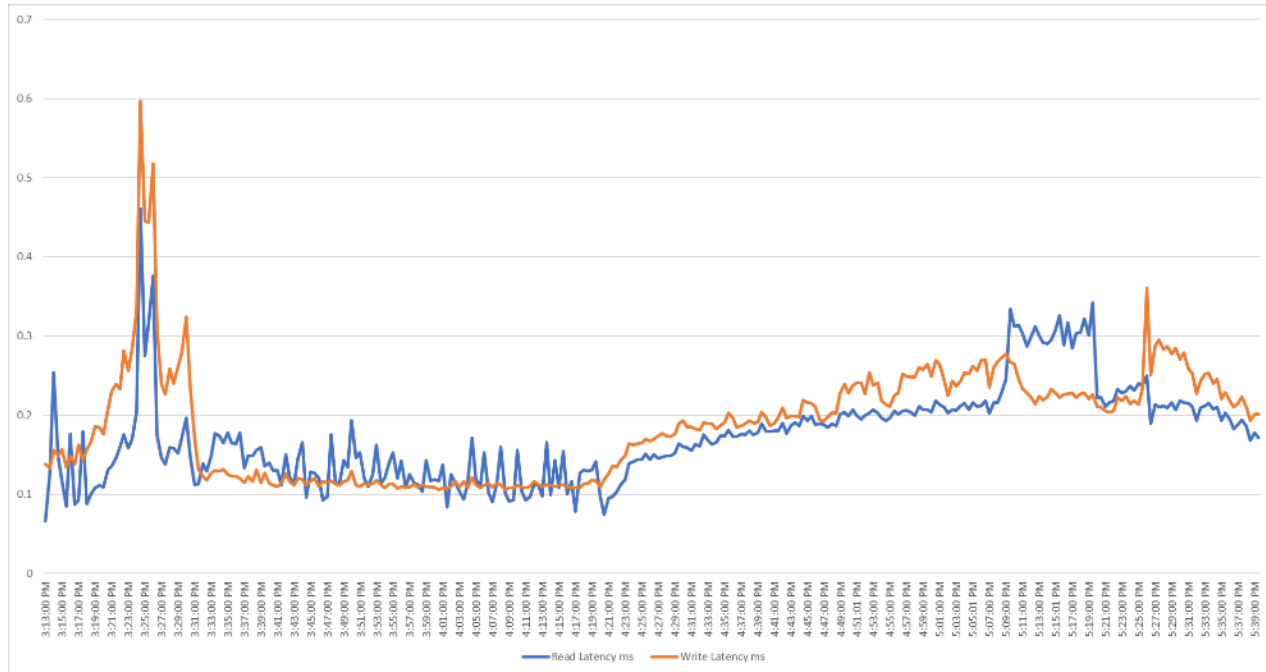
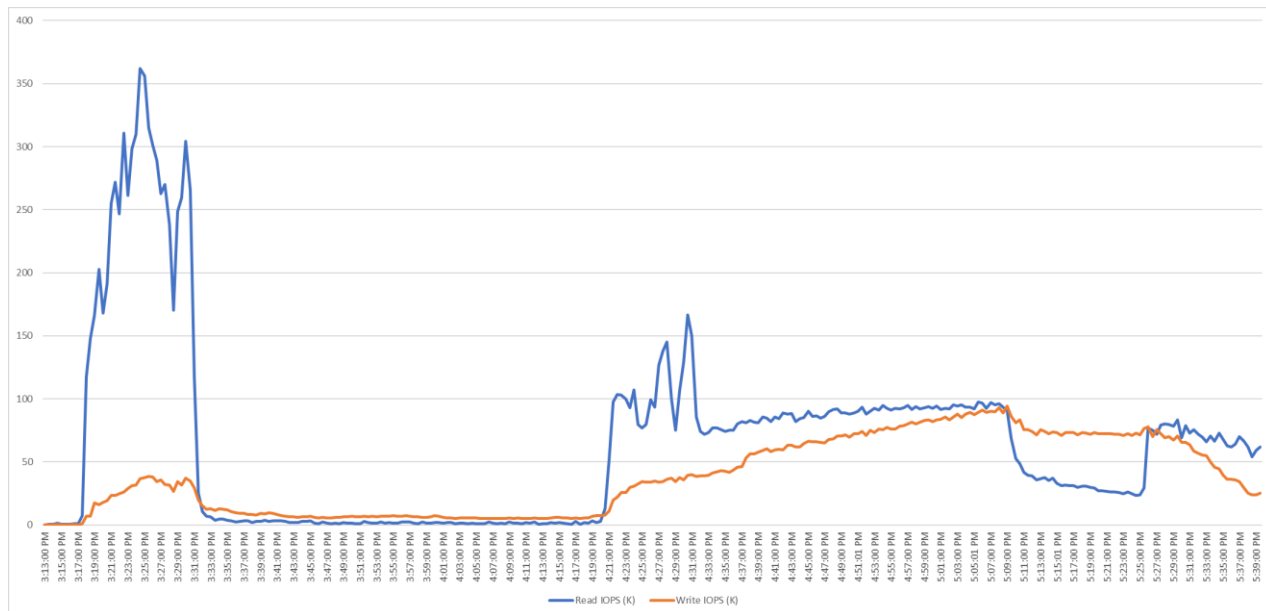
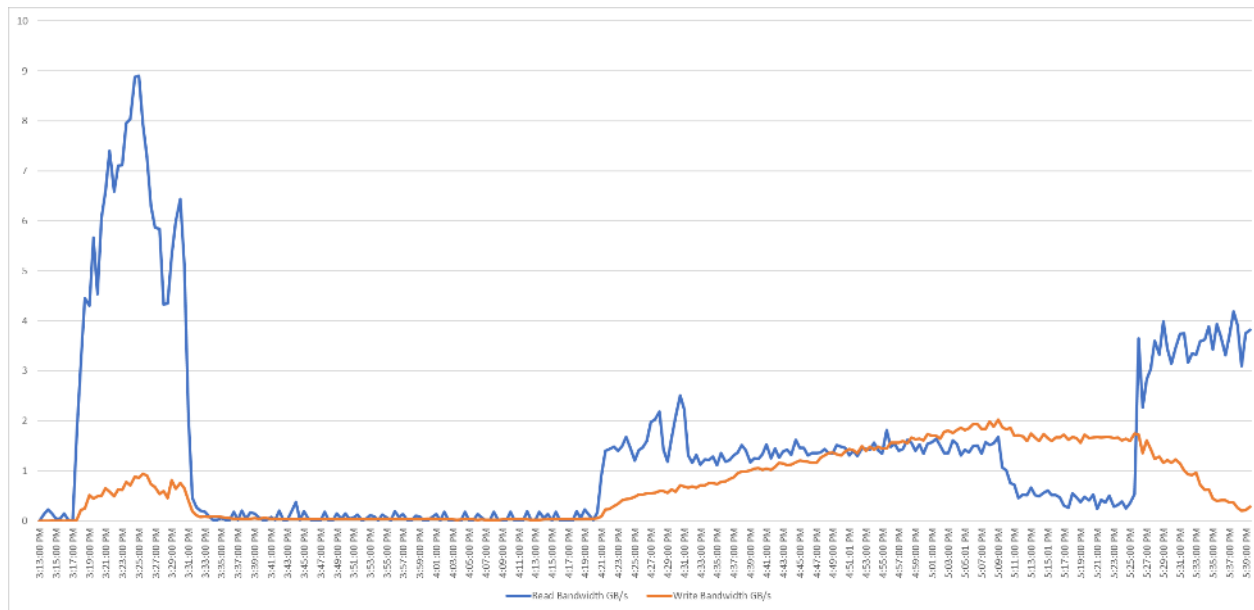

Figure 119. Full Scale | 5022 Users | VDI Non-Persistent VM Hosts | FlashArray//X70 R3 System IOPS Chart

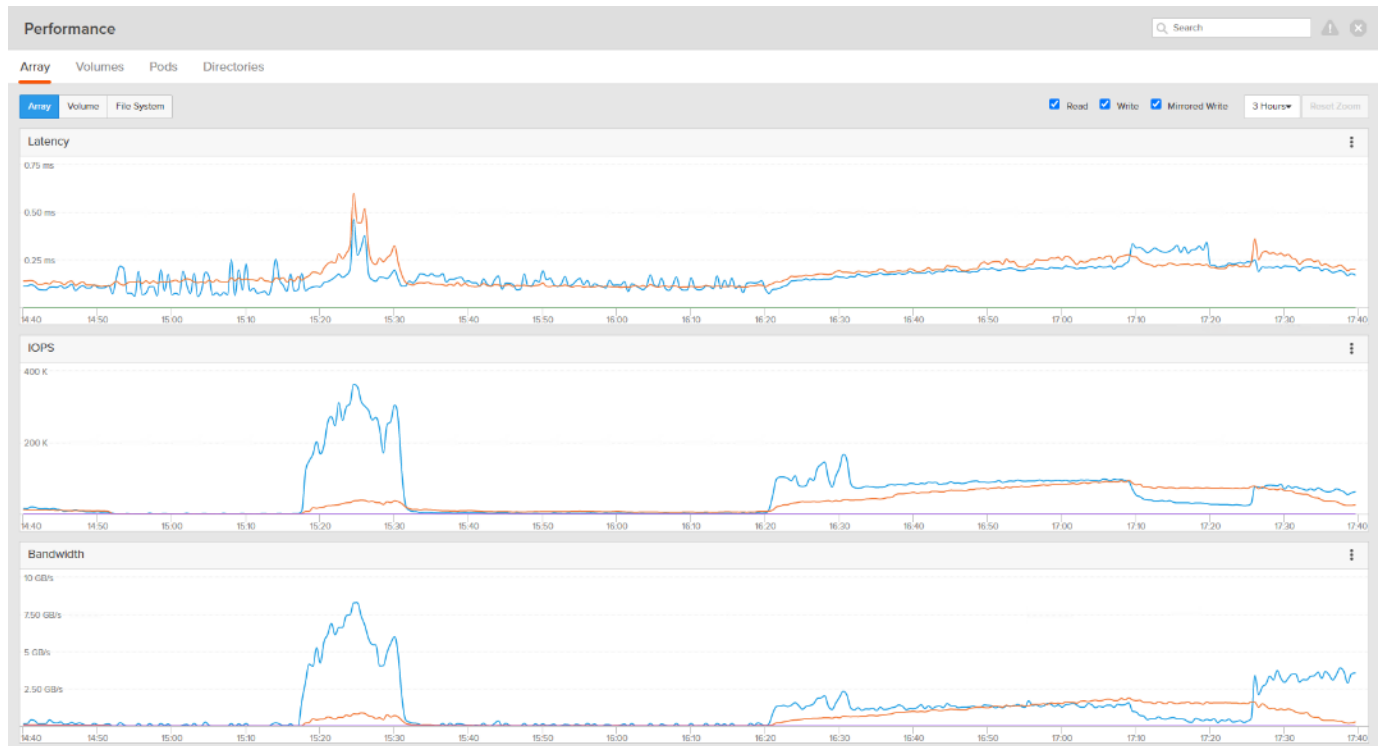



**Figure 120. Full Scale | 5022 Users | VDI Non-Persistent VM Hosts | FlashArray//X70 R3 System Bandwidth Chart**



**Figure 121. Full Scale | 5022 Users | VDI Non-Persistent VM Hosts | FlashArray//X70 R3 Performance Chart**



### Full Scale Workload Testing with 5022 VDI Persistent Users

This section describes the key performance metrics that were captured on the Cisco UCS and Pure Storage FlashArray during the persistent desktop full-scale testing with 5022 VDI Persistent desktops using 30 blades (configured in three 10 Host Pools).

The workload for the test is 5022 persistent VDI users. To achieve the target, sessions were launched against all workload clusters concurrently. As per the Cisco Test Protocol for VDI solutions, all sessions were launched within 48 minutes (using the official Knowledge Worker Workload in VSI Benchmark Mode) and all launched sessions became active within two minutes subsequent to the last logged in session.

**Figure 122. Full Scale VDI Persistent Test - Workload Distribution**

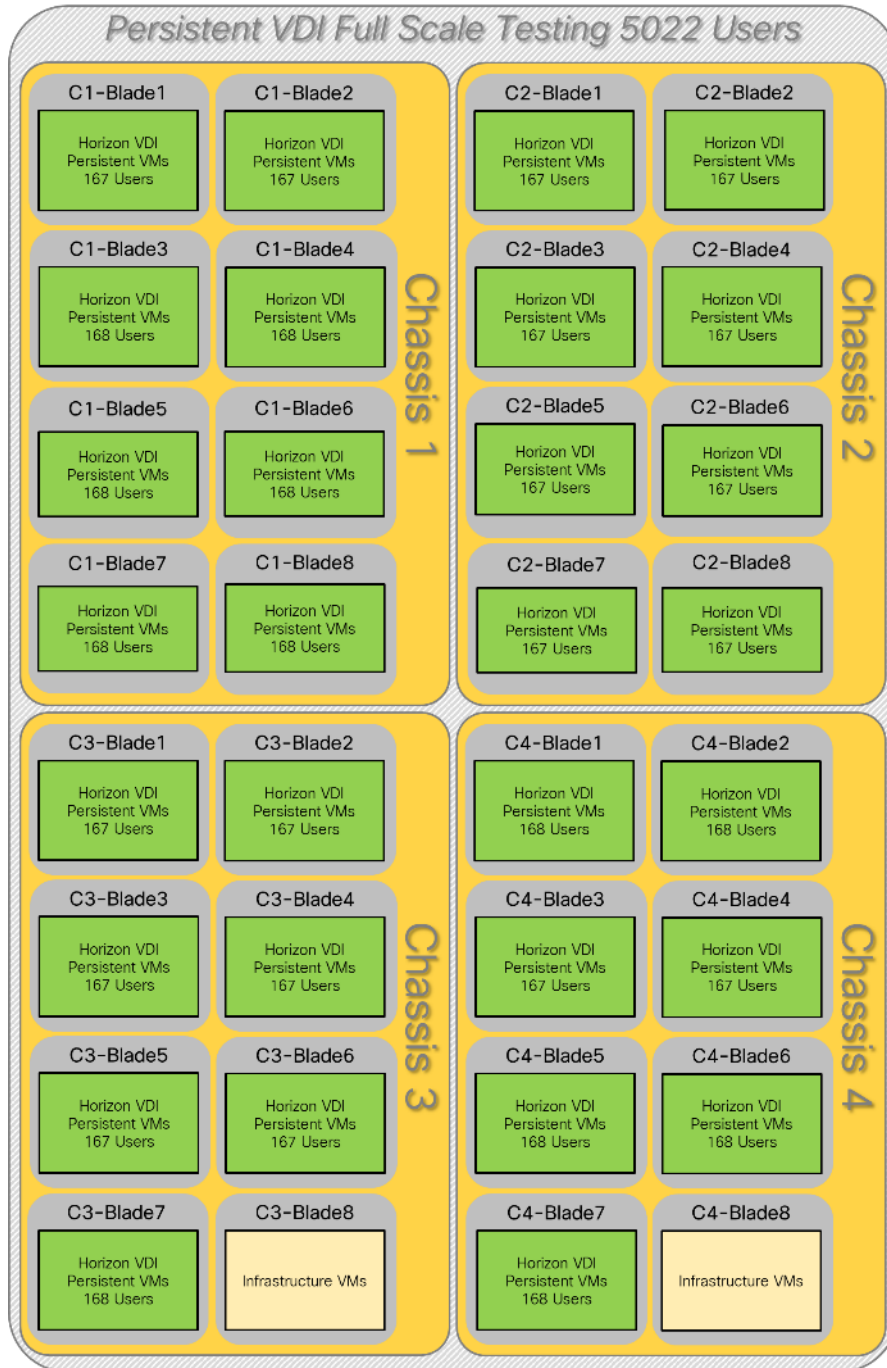

The configured system efficiently and effectively delivered the following results:

**Figure 123. Full Scale | 5022 Users | Win10 Persistent Desktop | VSI Score**

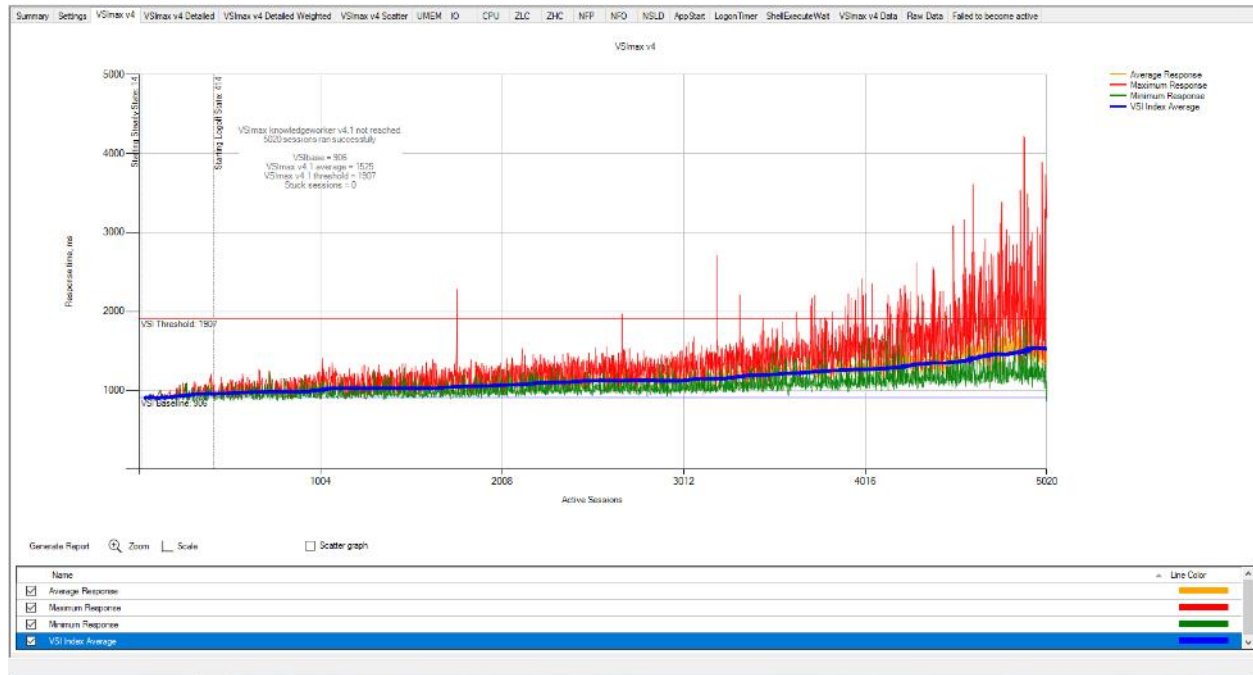

**Figure 124. Full Scale | 5022 Users | VDI Persistent VM Host | Host CPU Utilization**

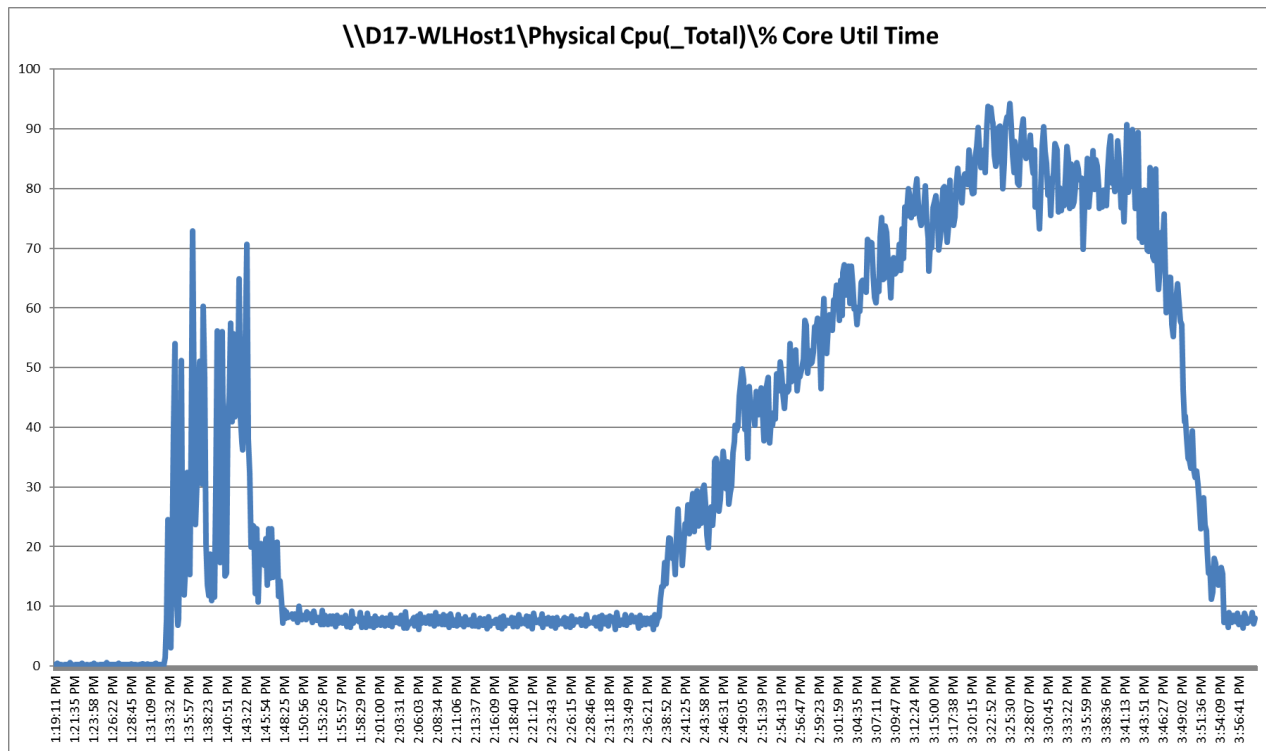

Figure 125. Full Scale | 5022 Users | VDI Persistent VM Hosts | Host Memory Utilization

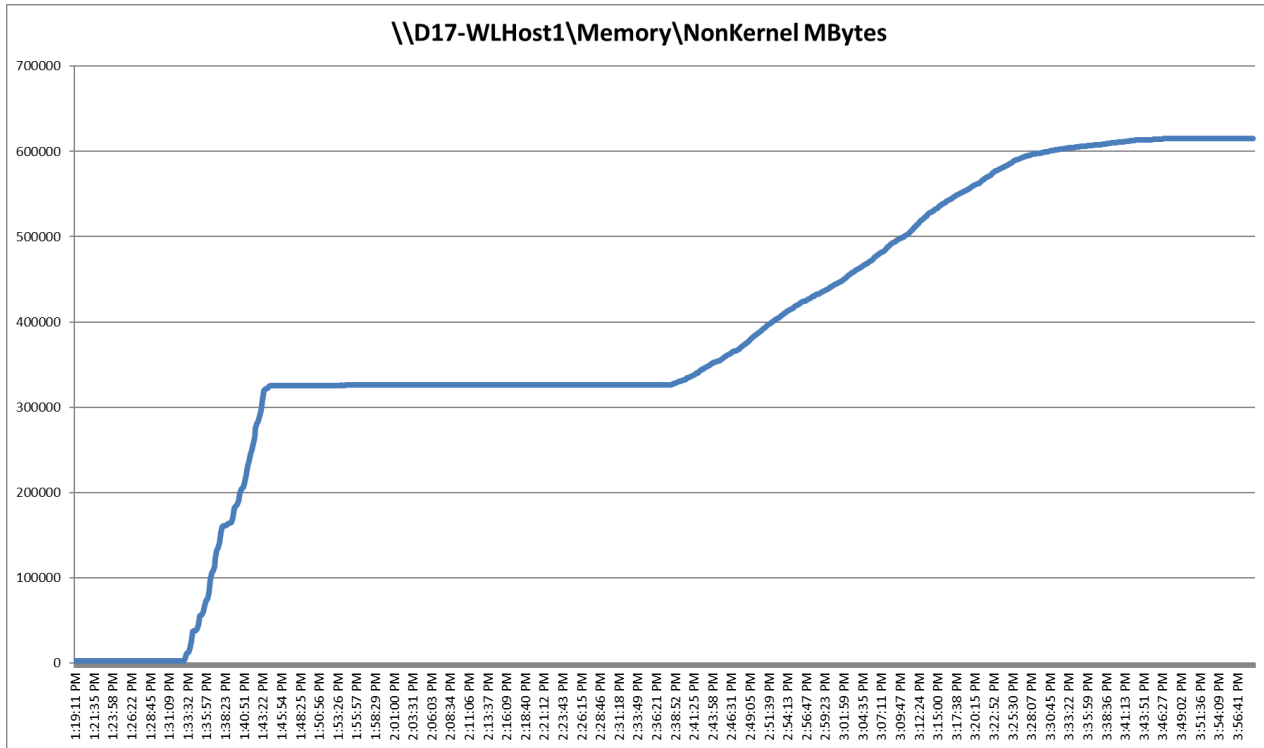
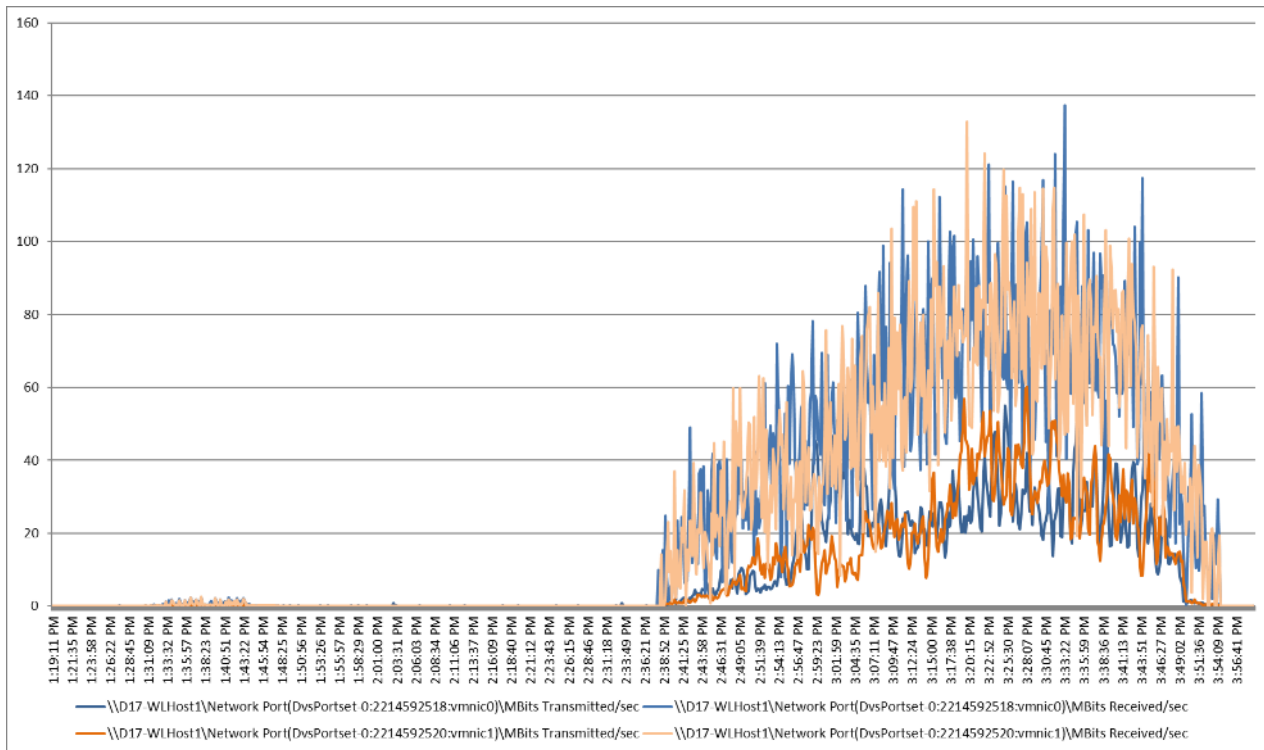

Figure 126. Full Scale | 5022 Users | VDI Persistent VM Hosts | Host Network Utilization



Pure Storage FlashArray//X70 R3 Storage System Graph for 5022 Users Persistent Desktop Workload Test

Figure 127. Full Scale | 5022 Users | VDI-Persistent VM Hosts | FlashArray//X70 R3 System Latency Chart

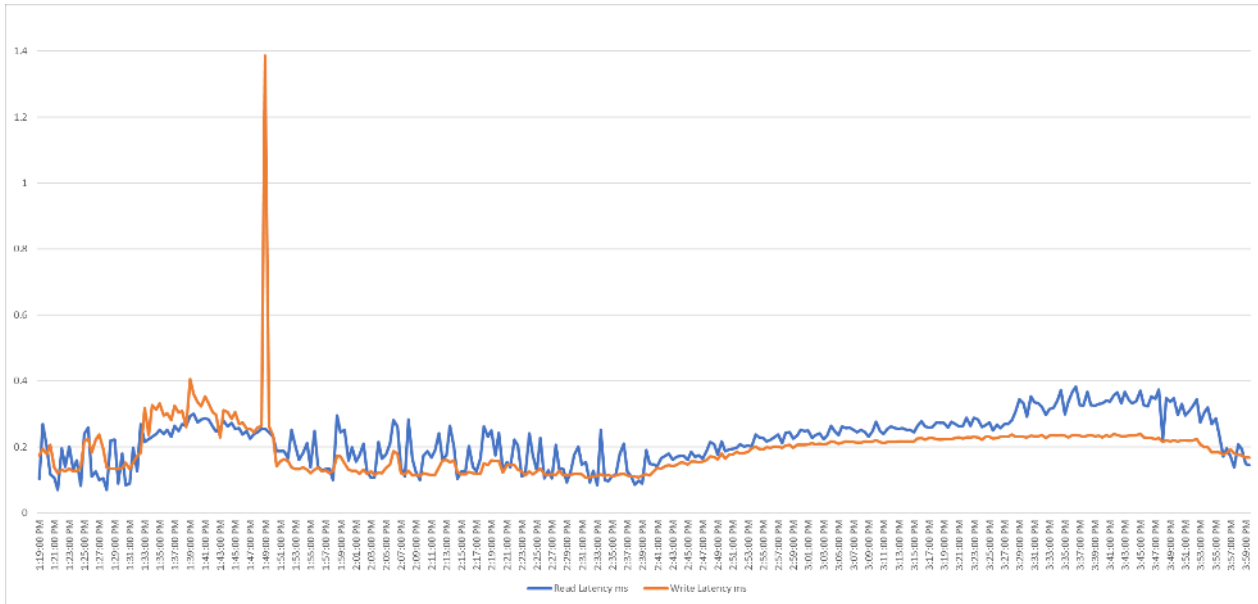
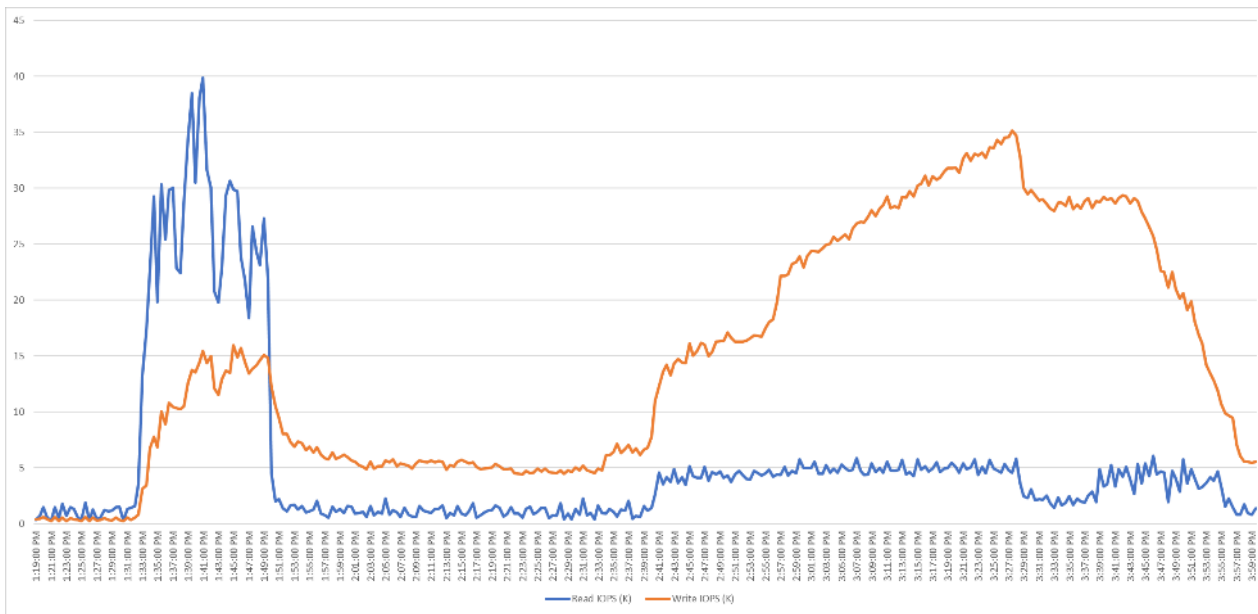
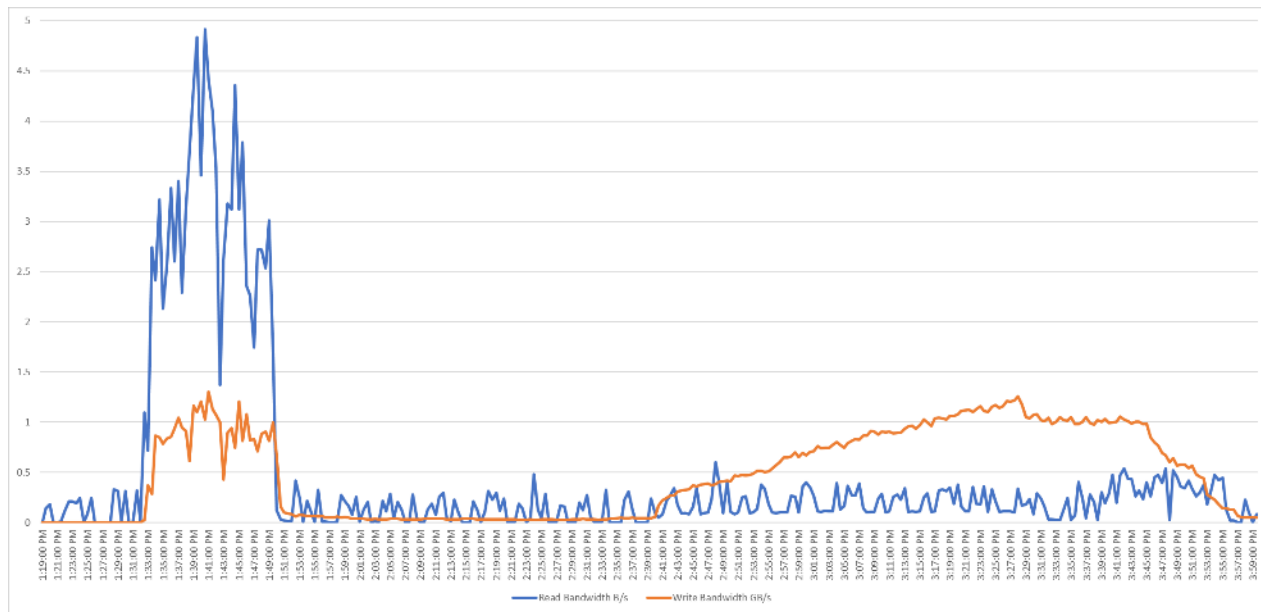

Figure 128. Full Scale | 5022 Users | VDI-Persistent VM Hosts | FlashArray//X70 R3 System IOPS Chart



**Figure 129. Full Scale | 5022 Users | VDI-Persistent VM Hosts | FlashArray//X70 R3 System Bandwidth Chart**



**Figure 130. Full Scale | 5022 Users | VDI-Persistent VM Hosts | FlashArray//X70 R3 System Performance Chart**

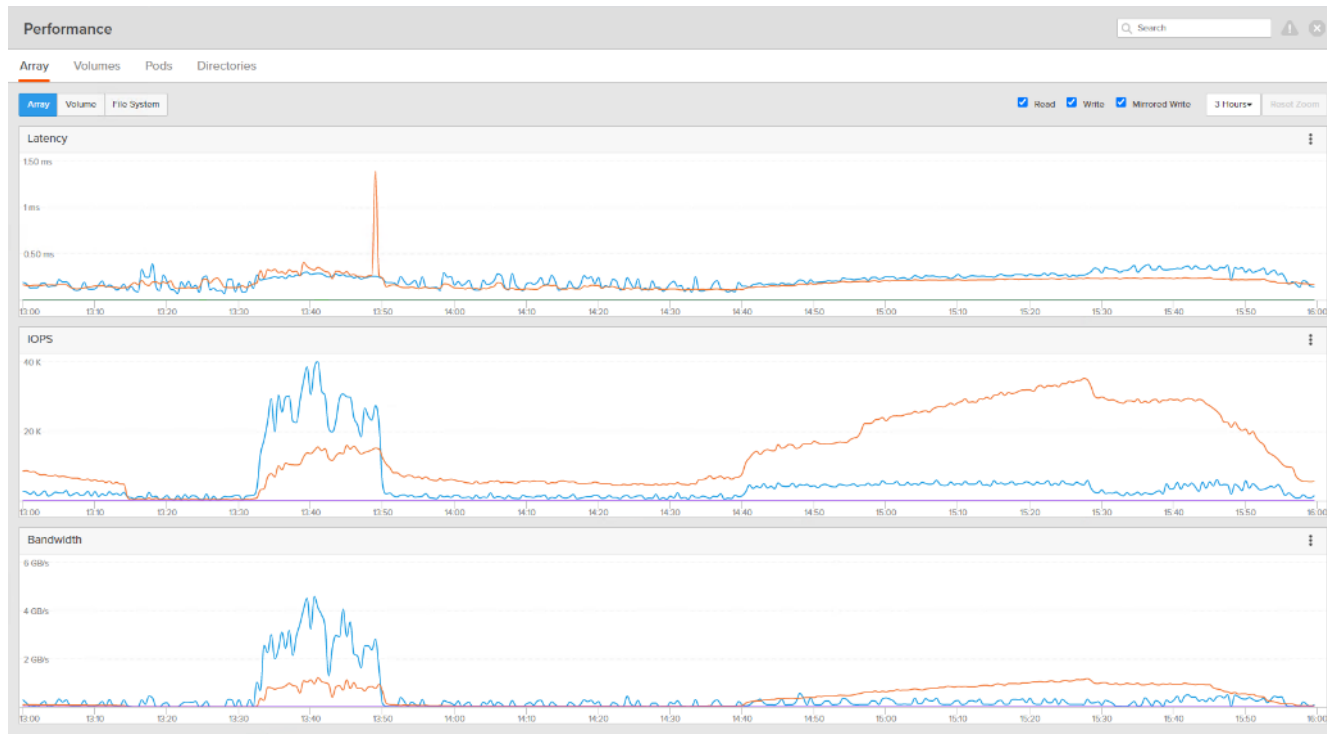

**Full Scale Workload Testing with 5300 Mixed Desktop Users**

This section describes the key performance metrics that were captured on the Cisco UCS and Pure Storage FlashArray array during the mixed desktop users full-scale testing. The full-scale testing with 5363 users comprised of: 2015 RDS Desktop Sessions using 10 blades, 1674 VDI Instant Clones Non-Persistent sessions using 10 blades, and 1674 VDI Full Clones Persistent sessions using 10 blades.

The combined mixed workload for the solution is 5363 users. To achieve the target, sessions were launched against all workload clusters concurrently. As per the Cisco Test Protocol for VDI solutions, all sessions were launched within 48 minutes (using the official Knowledge Worker Workload in VSI Benchmark Mode) and all launched sessions became active within two minutes subsequent to the last logged in session.

The configured system efficiently and effectively delivered the following results:

**Figure 131. Full Scale | 5800 Mixed Users | VSI Score**

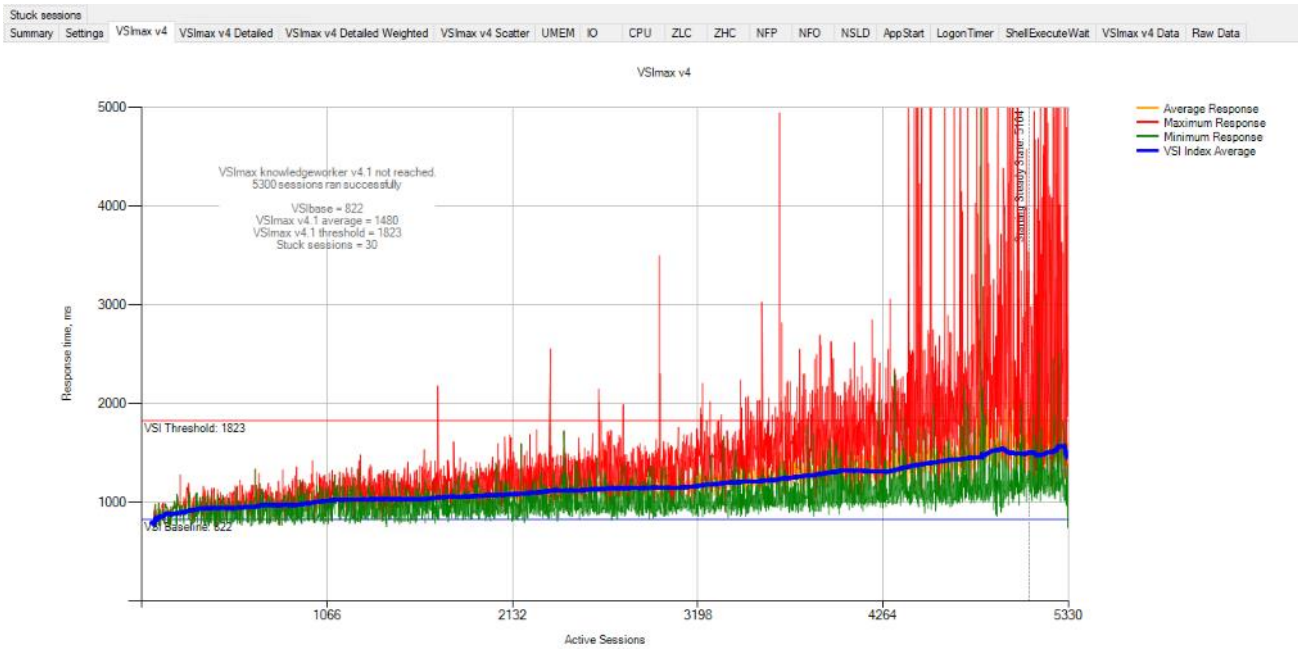

Figure 132. Full Scale | 5363 Mixed Users | Non-Persistent VDI Hosts | Host CPU Utilization

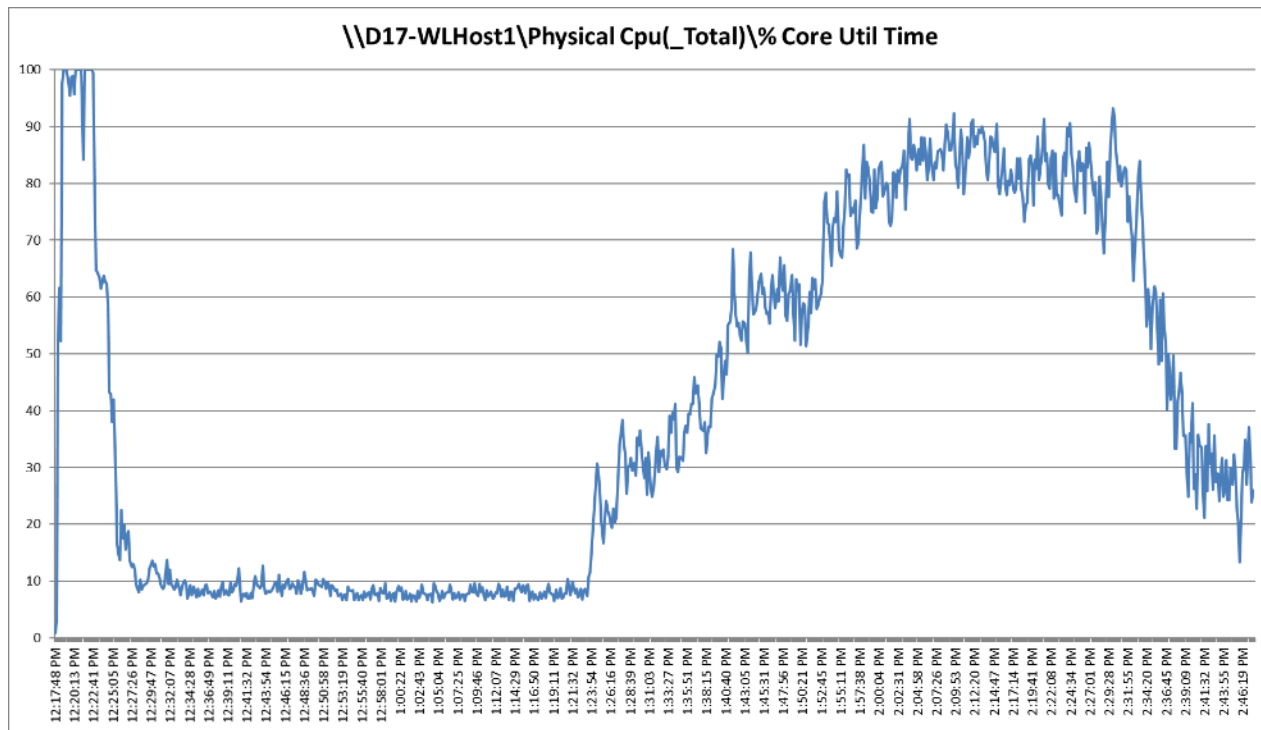

Figure 133. Full Scale | 5363 Mixed Users | Non-Persistent VDI Hosts | Host Memory Utilization

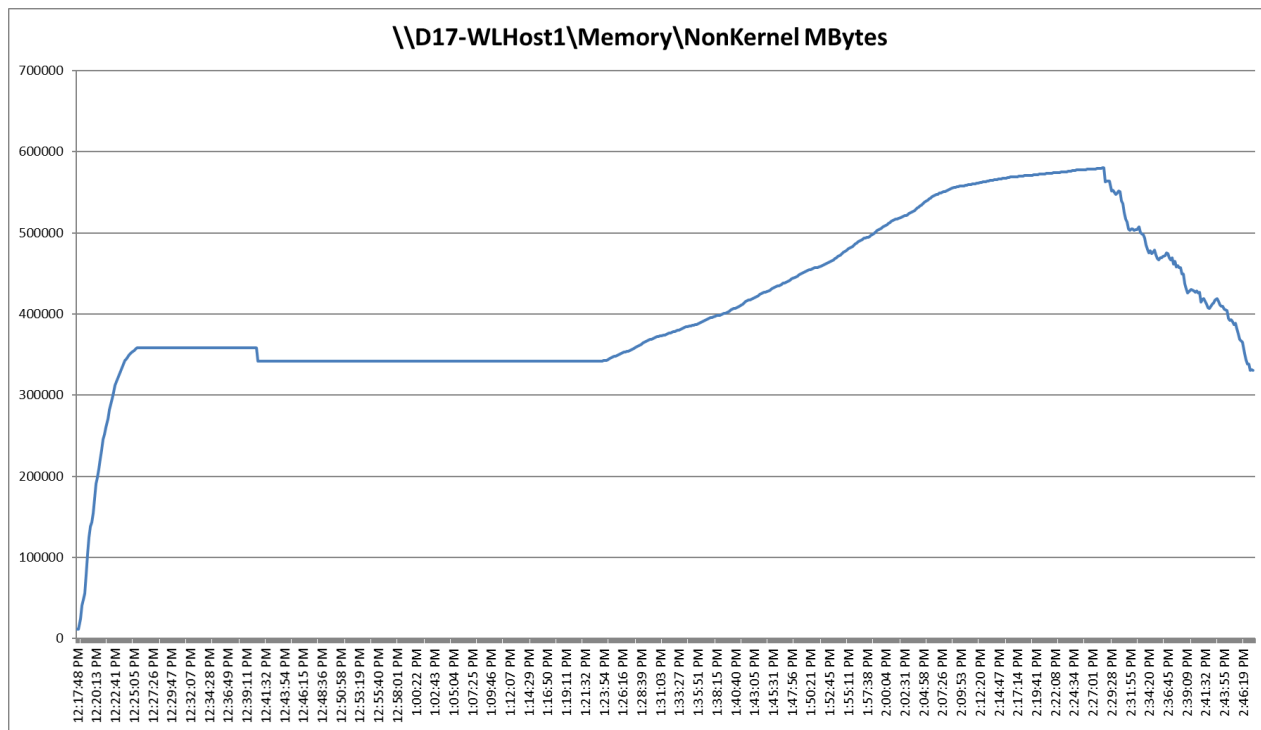



Figure 134. Full Scale | 5363 Mixed Users | Non-Persistent VDI Hosts | Host Network Utilization

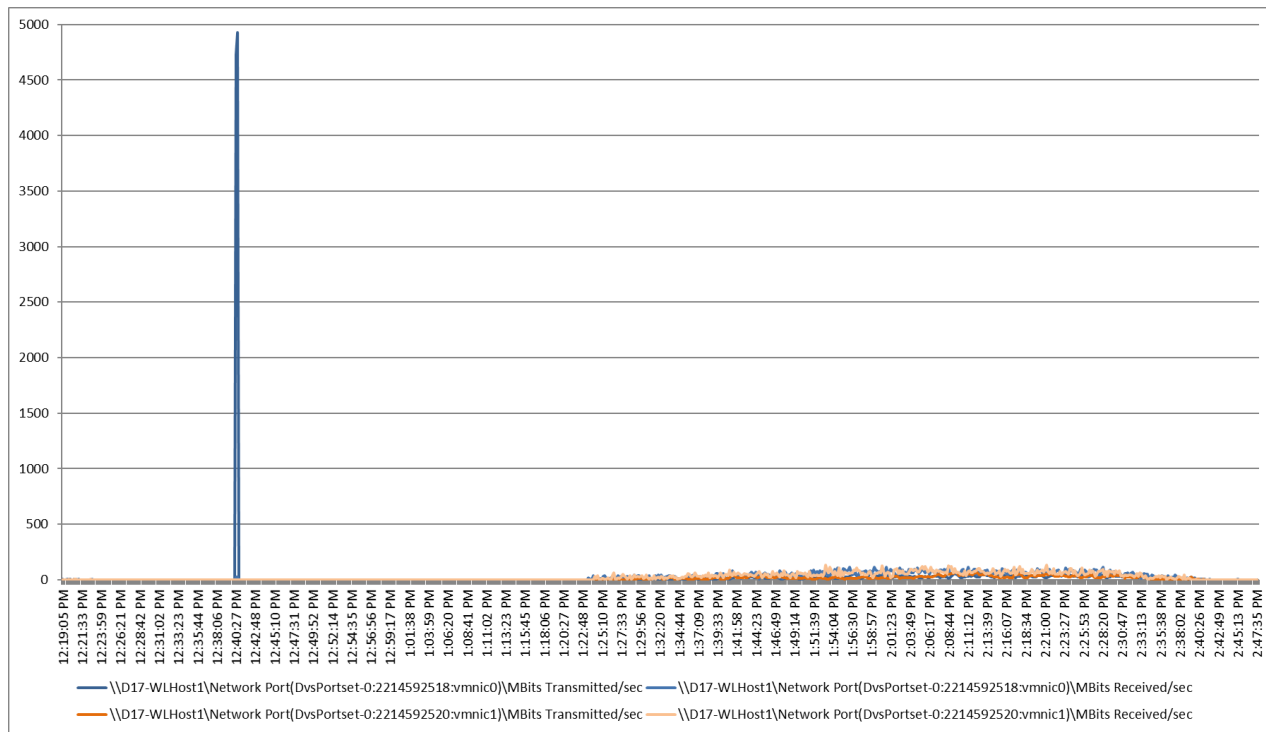

Figure 135. Full Scale | 5363 Mixed Users | RDS Hosts | Host CPU Utilization

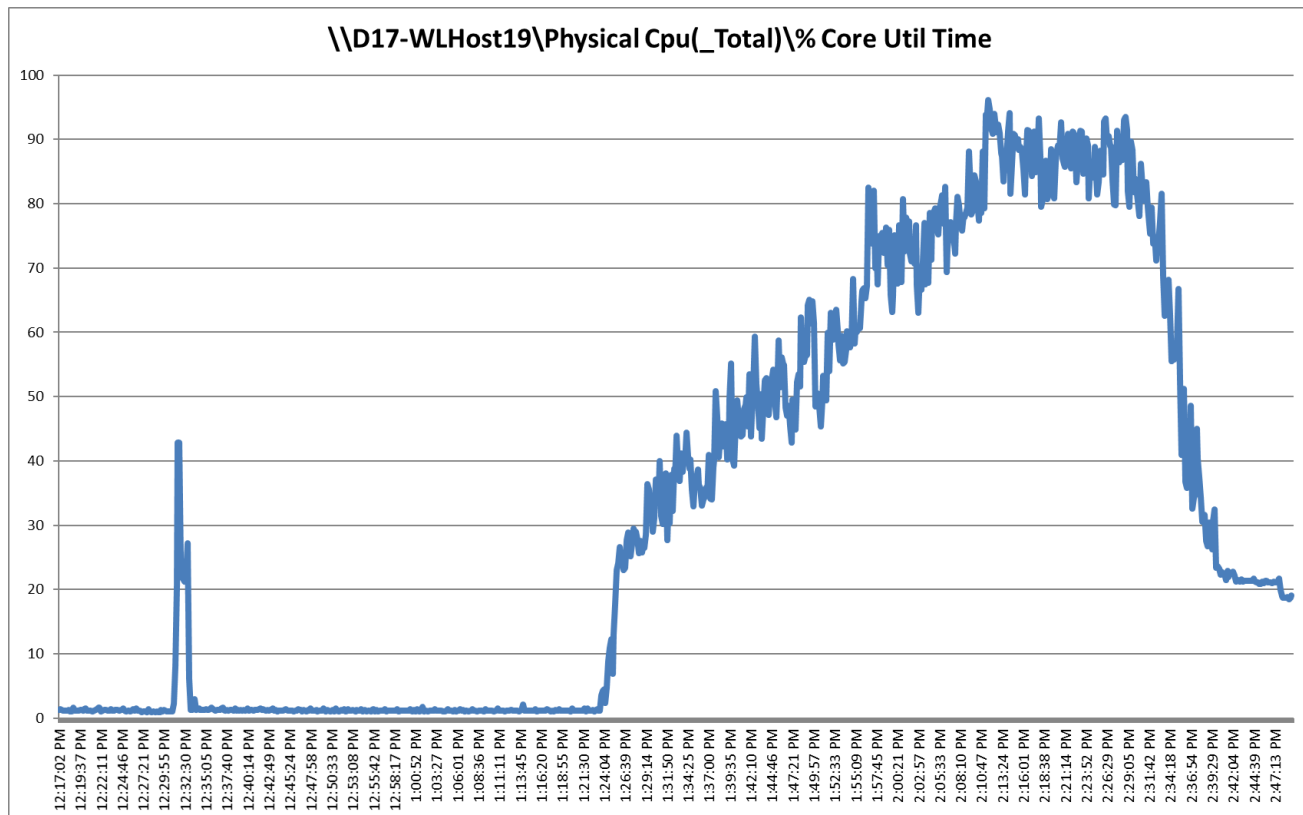

Figure 136. Full Scale | 5363 Mixed Users | RDS Hosts | Host Memory Utilization

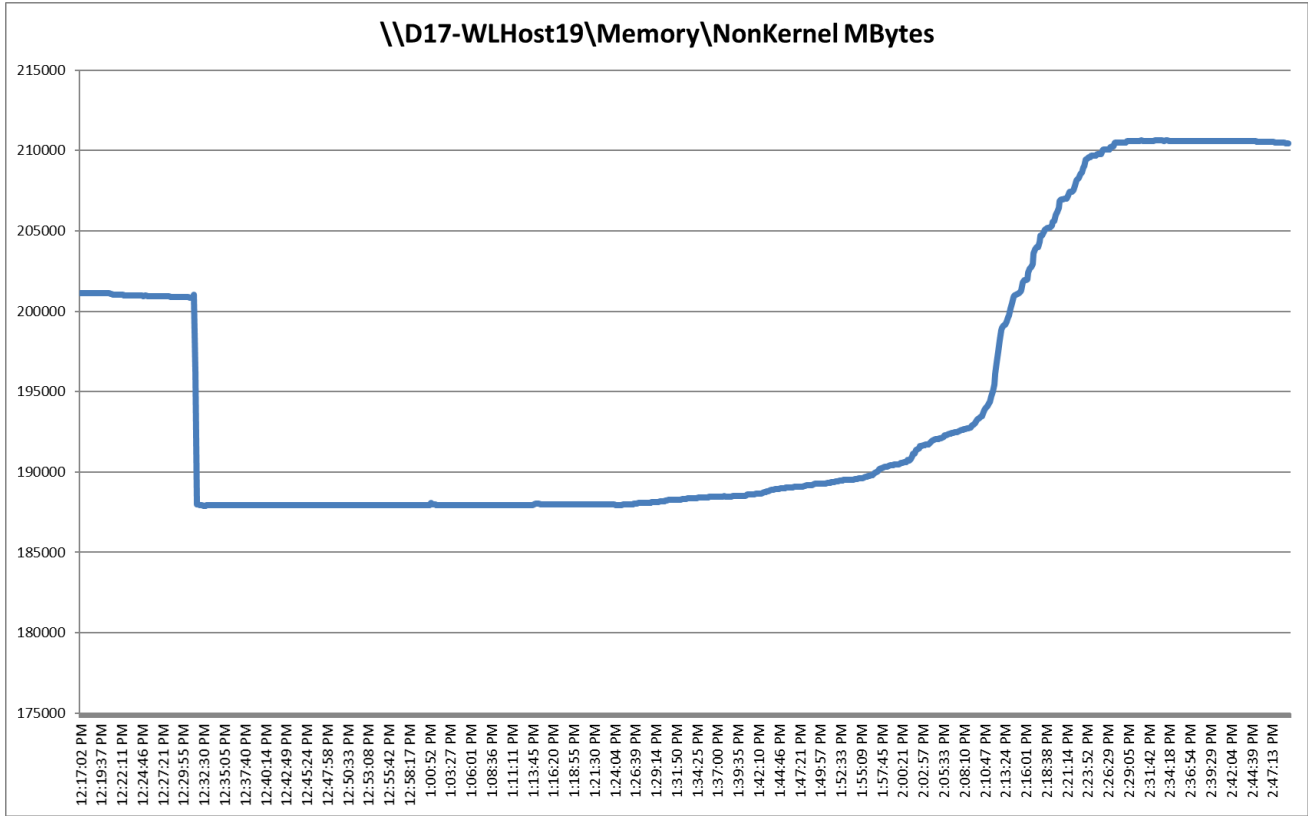

Figure 137. Full Scale | 5363 Mixed Users | RDS Hosts | Host Network Utilization

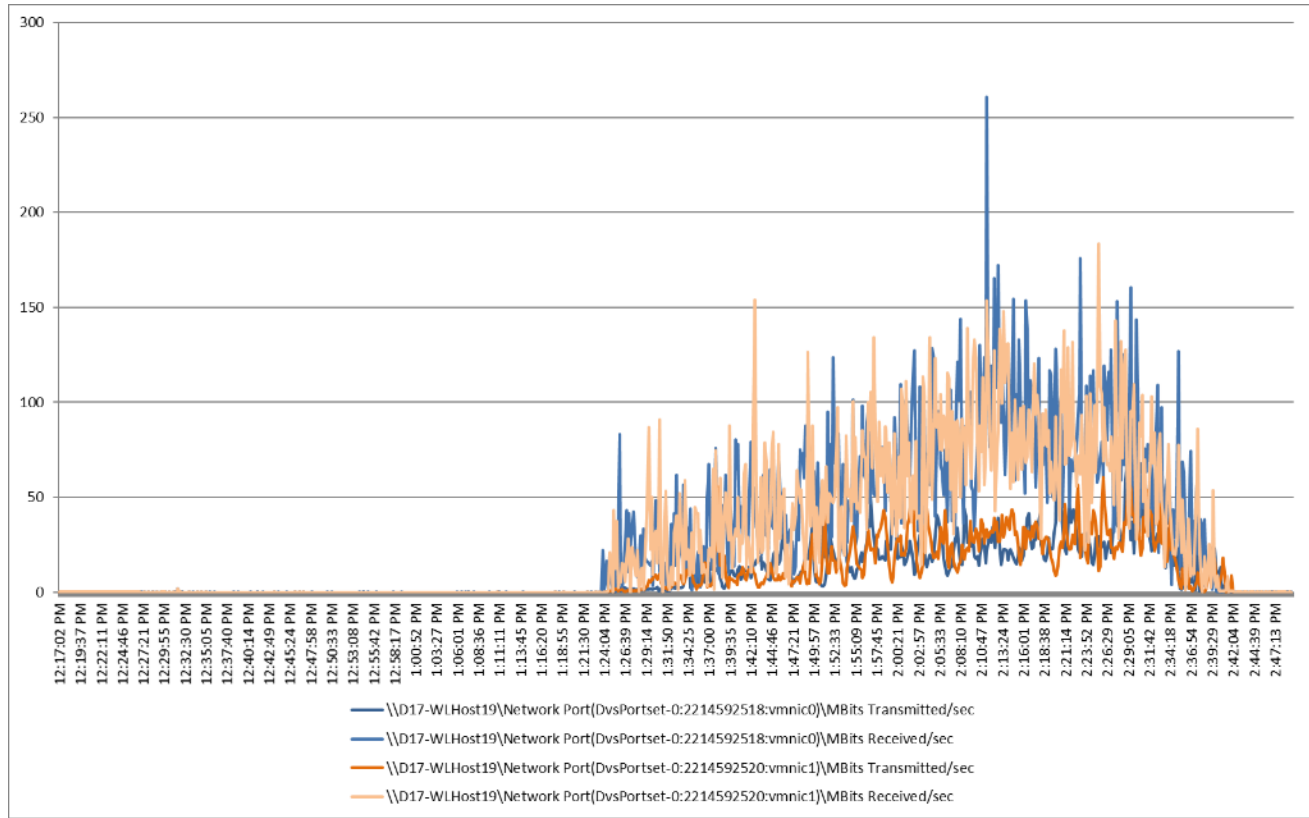

Figure 138. Full Scale | 5363 Mixed Users | Persistent Hosts | Host CPU Utilization

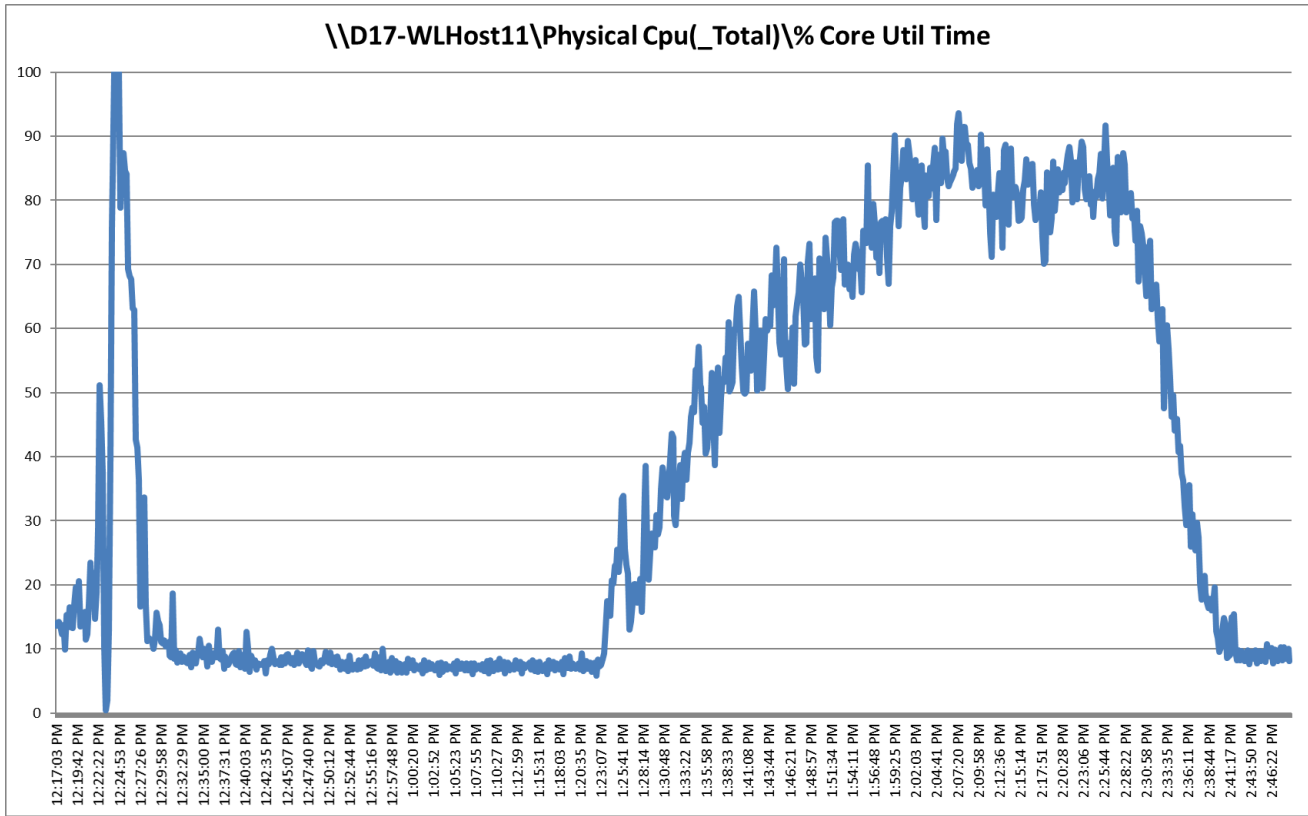
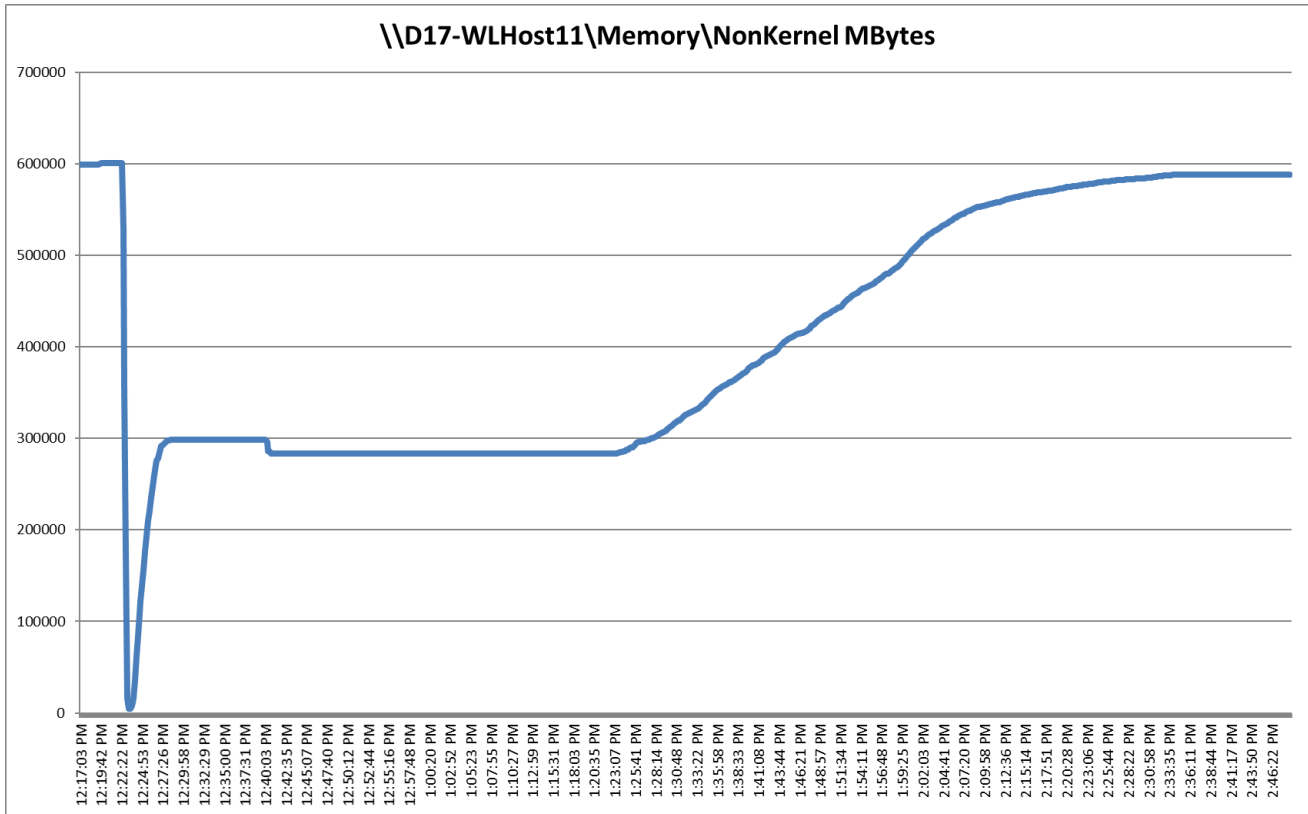
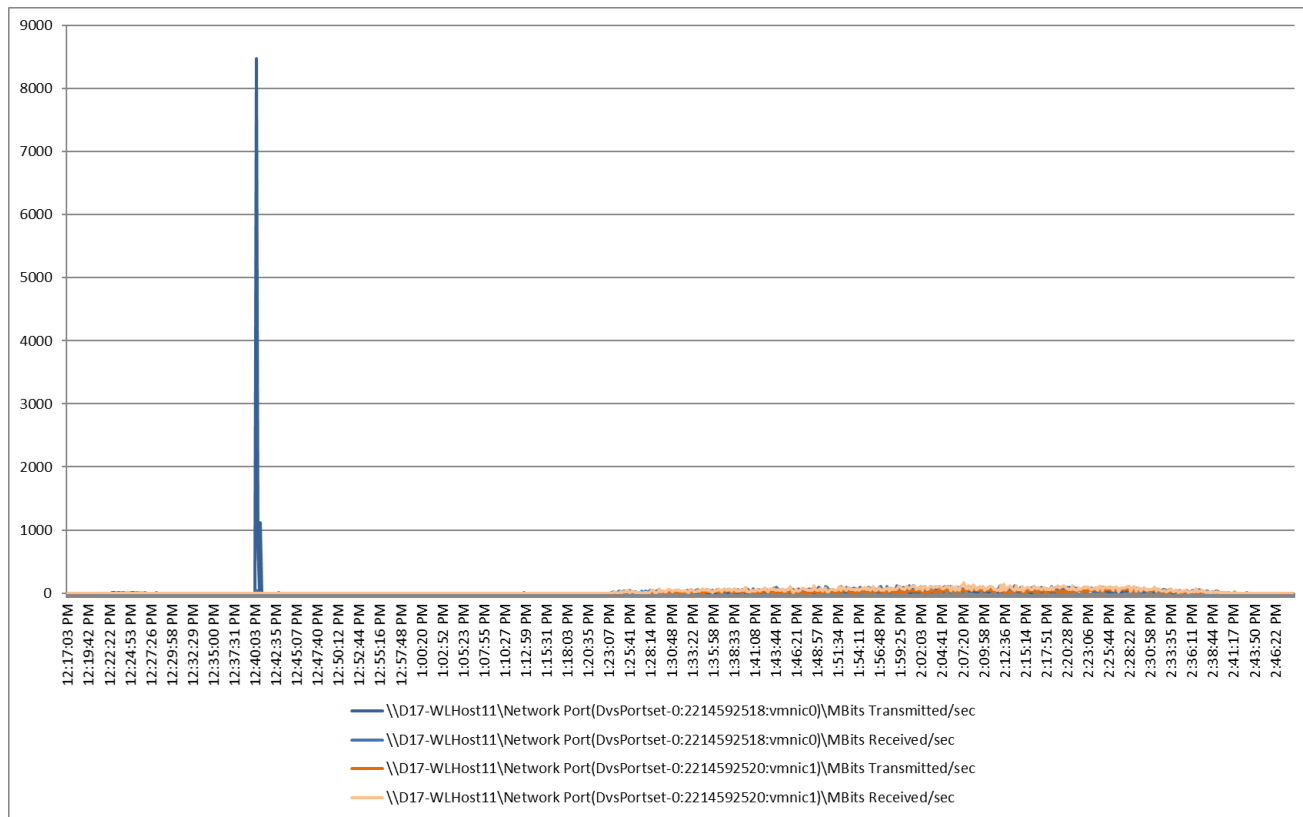

Figure 139. Full Scale | 5363 Mixed Users | Persistent VDI Hosts | Host Memory Utilization



**Figure 140. Full Scale | 5363 Mixed Users | Persistent VDI Hosts | Host Network Utilization**



**Pure Storage FlashArray//X70 R3 Storage System Graph for 60 Users Persistent Desktop Workload Test**

**Figure 141. Full Scale | 5363 Users | Mixed VM Hosts | FlashArray//X70 R3 System Latency Chart**

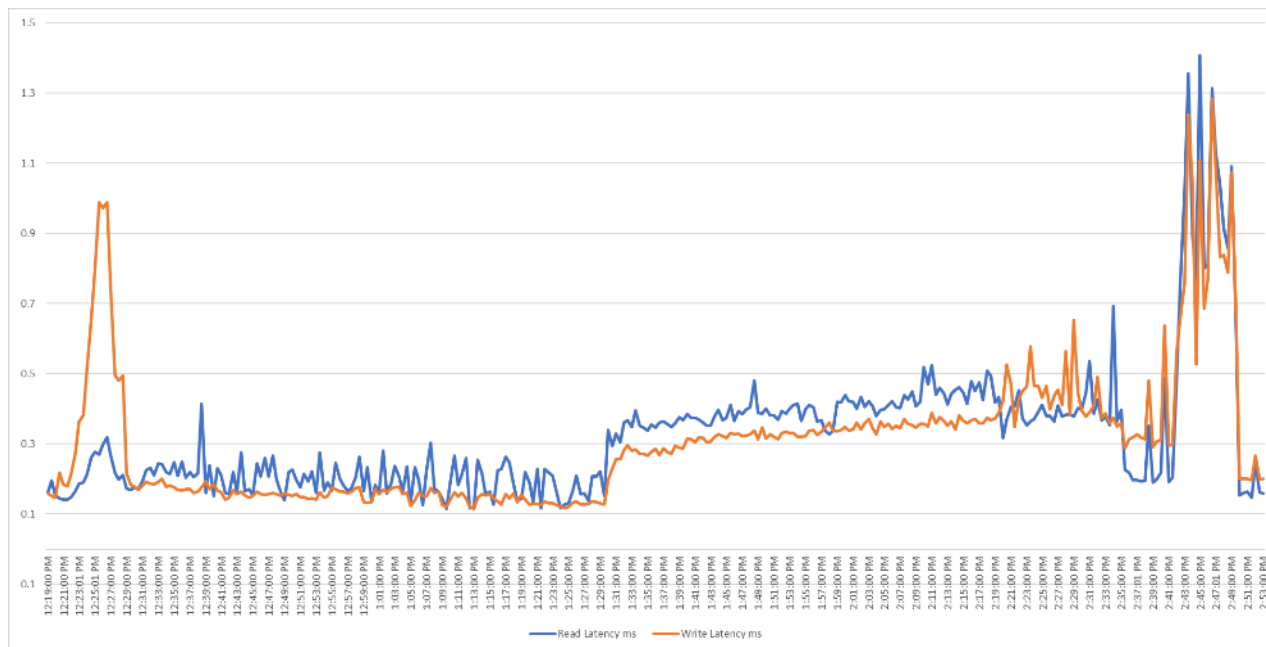

Figure 142. Full Scale | 5363 Users | Mixed VM Hosts | FlashArray//X70 R3 System IO Chart

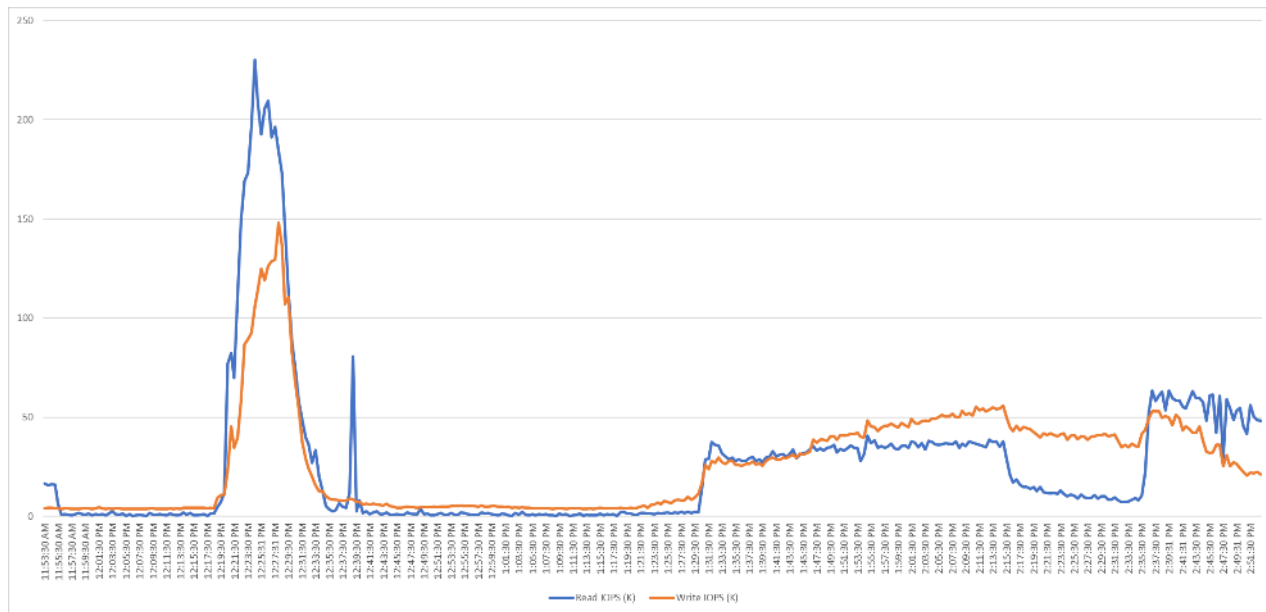

Figure 143. Full Scale | 5363 Users | Mixed VM Hosts | FlashArray//X70 R3 System Bandwidth Chart

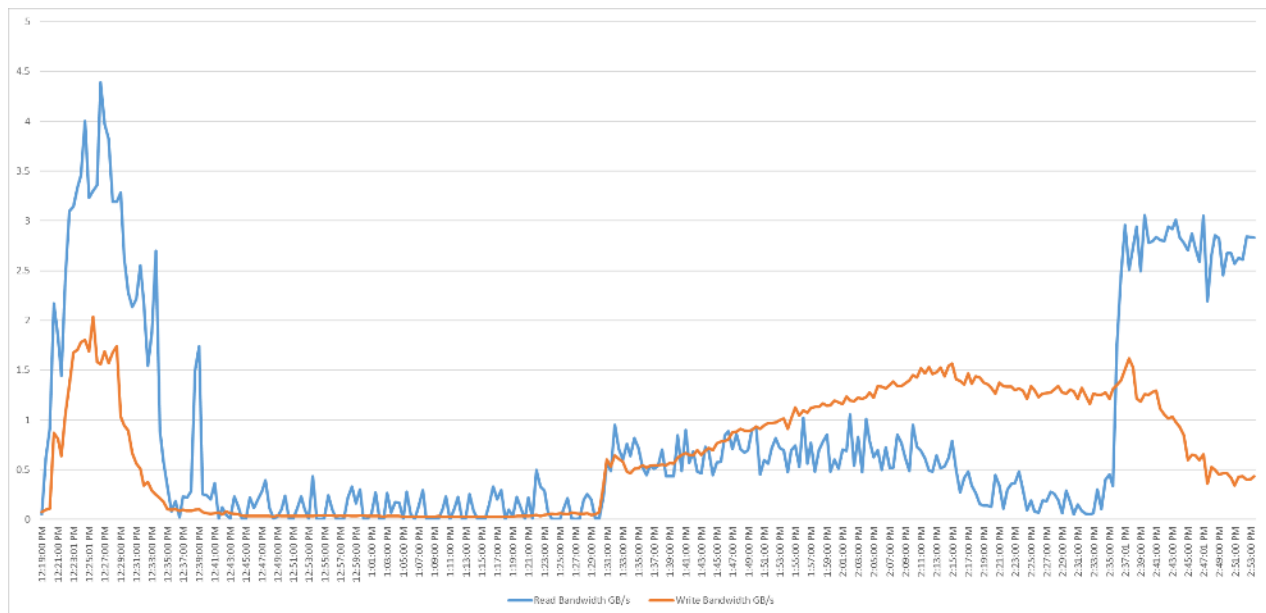
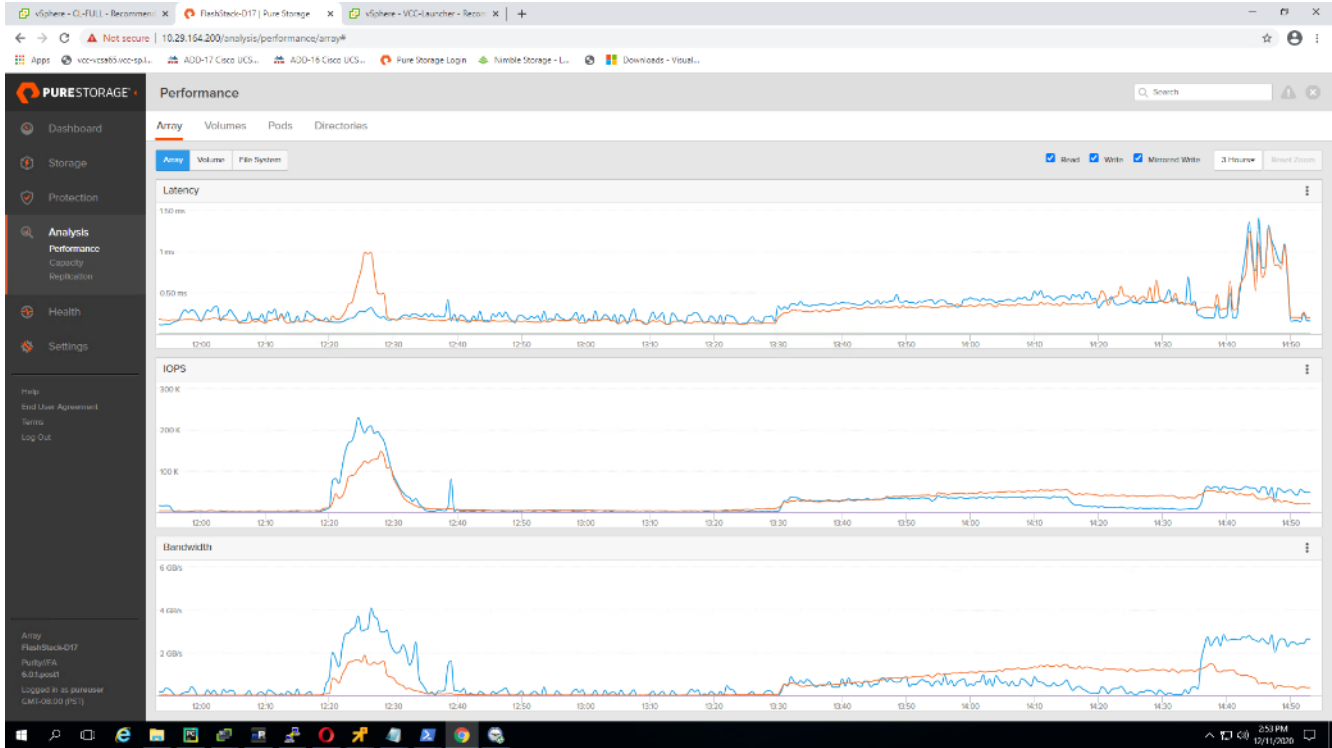

Figure 144. Full Scale | 5363 Mixed Users | Mixed Hosts | FlashArray//X70 R3 System Performance Chart





---

## Summary

FlashStack delivers a platform for Enterprise End User Computing deployments and cloud data centers using Cisco UCS Blade and Rack Servers, Cisco Fabric Interconnects, Cisco Nexus 9000 switches, Cisco MDS 9100 Fibre Channel switches and Pure Storage FlashArray//X70 R3 Storage Array. FlashStack is designed and validated using compute, network and storage best practices and high availability to reduce deployment time, project risk and IT costs while maintaining scalability and flexibility for addressing a multitude of IT initiatives. This CVD validates the design, performance, management, scalability, and resilience that FlashStack provides to customers wishing to deploy enterprise-class VDI and RDS.

## Get More Business Value with Services

Whether you are planning your next-generation environment, need specialized know-how for a major deployment, or want to get the most from your current storage, Cisco Advanced Services, Pure Storage FlashArray//X70 R3 storage and our certified partners can help. We collaborate with you to enhance your IT capabilities through a full portfolio of services for your IT lifecycle with:

- Strategy services to align IT with your business goals:
- Design services to architect your best storage environment
- Deploy and transition services to implement validated architectures and prepare your storage environment
- Operations services to deliver continuous operations while driving operational excellence and efficiency.

Additionally,, Cisco Advanced Services and Pure Storage Support provide in-depth knowledge transfer and education services that give you access to our global technical resources and intellectual property.

---

## About the Author

Vadim Lebedev, Technical Marketing Engineer, Desktop Virtualization and Graphics Solutions, Cisco Systems, Inc.

Vadim Lebedev for the last 5 years is a member of the Cisco's Computing Systems Product Group team focusing on design, testing, and solutions validation, technical content creation, and performance testing/benchmarking. He has years of experience in server and desktop virtualization. Vadim is a subject matter expert on Desktop/Server virtualization, Cisco HyperFlex, Cisco Unified Computing System, Cisco Nexus Switching, and NVIDIA Graphics.

## Acknowledgements

For their support and contribution to the design, validation, and creation of this Cisco Validated Design, we would like to acknowledge the following for their contribution and expertise that resulted in developing this document:

- Keith Hageman, Solutions Architect, Pure Storage, Inc.
- Craig Waters, Solutions Architecture/Product Management, Pure Storage, Inc.

---

## References

This section provides links to additional information for each partner's solution component of this document.

### Cisco UCS B-Series Servers

- <http://www.cisco.com/c/en/us/products/servers-unified-computing/ucs-b-series-blade-servers/index.html>
- <https://www.cisco.com/c/dam/en/us/products/collateral/servers-unified-computing/ucs-b-series-blade-servers/b200m5-specsheet.pdf>
- <https://www.cisco.com/c/en/us/products/servers-unified-computing/ucs-b-series-blade-servers/datasheet-listing.html>
- <https://www.cisco.com/c/en/us/support/servers-unified-computing/ucs-b200-m5-blade-server/model.html>
- [https://www.cisco.com/c/en/us/td/docs/unified\\_computing/ucs/hw/blade-servers/B200M5.pdf](https://www.cisco.com/c/en/us/td/docs/unified_computing/ucs/hw/blade-servers/B200M5.pdf)

### Cisco UCS Manager Configuration Guides

- <http://www.cisco.com/c/en/us/support/servers-unified-computing/ucs-manager/products-installation-and-configuration-guides-list.html>
- <https://www.cisco.com/c/en/us/support/servers-unified-computing/ucs-manager/products-release-notes-list.html>

### Cisco UCS Virtual Interface Cards

- <https://www.cisco.com/c/en/us/products/collateral/interfaces-modules/unified-computing-system-adapters/datasheet-c78-741130.html>

### Cisco Nexus Switching References

- <http://www.cisco.com/c/en/us/products/collateral/switches/nexus-9000-series-switches/datasheet-c78-736967.html>
- <https://www.cisco.com/c/en/us/products/switches/nexus-93180vc-fx-switch/index.html>

### Cisco MDS 9000 Service Switch References

- <http://www.cisco.com/c/en/us/products/storage-networking/mds-9000-series-multilayer-switches/index.html>
- <http://www.cisco.com/c/en/us/products/storage-networking/product-listing.html>
- <https://www.cisco.com/c/en/us/products/collateral/storage-networking/mds-9132T-32-Gb-16g-multilayer-fabric-switch/datasheet-c78-731523.html>

### VMware References

- <https://docs.vmware.com/en/VMware-vSphere/index.html>

- 
- <https://docs.vmware.com/en/VMware-Horizon-7/index.html>

### **Login VSI Documentation**

- [https://www.loginvsi.com/documentation/Main\\_Page](https://www.loginvsi.com/documentation/Main_Page)
- [https://www.loginvsi.com/documentation/Start\\_your\\_first\\_test](https://www.loginvsi.com/documentation/Start_your_first_test)

### **Pure Storage Reference Documents**

- <https://www.flashstack.com/>
- [https://www.purestorage.com/content/dam/purestorage/pdf/datasheets/ps\\_ds\\_flasharray\\_03.pdf](https://www.purestorage.com/content/dam/purestorage/pdf/datasheets/ps_ds_flasharray_03.pdf)
- <https://www.purestorage.com>
- <https://www.purestorage.com/products/evergreen-subscriptions.html>
- <https://www.purestorage.com/solutions/infrastructure/vdi.html>
- <https://www.purestorage.com/solutions/infrastructure/vdi-calculator.html>

---

## Appendix

### Ethernet Network Configuration

The following section provides a detailed procedure for configuring the Cisco Nexus 9000 Switches used in this study.

#### Cisco Nexus 93180YC-A Configuration

```
version 7.0(3)I7(2)
switchname AAD17-NX9K-A
class-map type network-qos class-fcoe
match qos-group 1
class-map type network-qos class-all-flood
match qos-group 2
class-map type network-qos class-ip-multicast
match qos-group 2
policy-map type network-qos jumbo
  class type network-qos class-fcoe
    mtu 2158
  class type network-qos class-default
    mtu 9216
install feature-set fcoe-npv
vdc AAD17-NX9K-A id 1
  allow feature-set fcoe-npv
  limit-resource vlan minimum 16 maximum 4094
  limit-resource vrf minimum 2 maximum 4096
  limit-resource port-channel minimum 0 maximum 511
  limit-resource u4route-mem minimum 248 maximum 248
  limit-resource u6route-mem minimum 96 maximum 96
  limit-resource m4route-mem minimum 58 maximum 58
  limit-resource m6route-mem minimum 8 maximum 8
feature-set fcoe-npv

feature telnet
cfs eth distribute
feature interface-vlan
feature hsrp
```

```
feature lacp
feature dhcp
feature vpc
feature lldp

no password strength-check
username admin password 5 $5$d3vc8gvD$hmf.YoRRPcqZ2dDGV2IaVKYZsPSP1s8E9bpUzMciMZ0 role
network-admin
ip domain-lookup
system default switchport
class-map type qos match-all class-fcoe
policy-map type qos jumbo
  class class-default
    set qos-group 0
system qos
  service-policy type network-qos jumbo
copp profile lenient
snmp-server user admin network-admin auth md5 0xc9a73d344387b8db2dc0f3fc624240ac priv
0xc9a73d344387b8db2dc0f3fc624240ac localizedkey
snmp-server host 10.24.66.169 traps version 2c public udp-port 1165
snmp-server host 10.24.72.119 traps version 2c public udp-port 1163
rmon event 1 description FATAL(1) owner PMON@FATAL
rmon event 2 description CRITICAL(2) owner PMON@CRITICAL
rmon event 3 description ERROR(3) owner PMON@ERROR
rmon event 4 description WARNING(4) owner PMON@WARNING
rmon event 5 description INFORMATION(5) owner PMON@INFO
ntp server 10.10.70.2 use-vrf default
ntp peer 10.10.70.3 use-vrf default
ntp server 72.163.32.44 use-vrf management
ntp logging
ntp master 8

vlan 1,70-76
vlan 70
  name InBand-Mgmt-SP
vlan 71
  name Infra-Mgmt-SP
```

```
vlan 72
  name VM-Network-SP
vlan 73
  name vMotion-SP
vlan 74
  name Storage_A-SP
vlan 75
  name Storage_B-SP
vlan 76
  name Launcher-SP

service dhcp
ip dhcp relay
ip dhcp relay information option
ipv6 dhcp relay
vrf context management
  ip route 0.0.0.0/0 10.29.164.1
hardware access-list tcam region ing-racl 1536
hardware access-list tcam region ing-redirect 256
vpc domain 70
  role priority 1000
  peer-keepalive destination 10.29.164.234 source 10.29.164.233

interface Vlan1
  no shutdown
  ip address 10.29.164.241/24

interface Vlan70
  no shutdown
  ip address 10.10.70.2/24
  hsrp version 2
  hsrp 70
    preempt
    priority 110
    ip 10.10.70.1
```

---

```
interface Vlan71
  no shutdown
  ip address 10.10.71.2/24
  hsrp version 2
  hsrp 71
    preempt
    priority 110
    ip 10.10.71.1
```

```
interface Vlan72
  no shutdown
  ip address 10.72.0.2/19
  hsrp version 2
  hsrp 72
    preempt
    priority 110
    ip 10.72.0.1
  ip dhcp relay address 10.10.71.11
  ip dhcp relay address 10.10.71.12
```

```
interface Vlan73
  no shutdown
  ip address 10.10.73.2/24
  hsrp version 2
  hsrp 73
    preempt
    priority 110
    ip 10.10.73.1
```

```
interface Vlan74
  no shutdown
  ip address 10.10.74.2/24
  hsrp version 2
  hsrp 74
    preempt
```



---

```
    priority 110
    ip 10.10.74.1

interface Vlan75
  no shutdown
  ip address 10.10.75.2/24
  hsrp version 2
  hsrp 75
    preempt
    priority 110
    ip 10.10.75.1

interface Vlan76
  no shutdown
  ip address 10.10.76.2/23
  hsrp version 2
  hsrp 76
    preempt
    priority 110
    ip 10.10.76.1
  ip dhcp relay address 10.10.71.11
  ip dhcp relay address 10.10.71.12

interface port-channel10

interface port-channel11
  description FI-Uplink-D17
  switchport mode trunk
  switchport trunk allowed vlan 1,70-76
  spanning-tree port type edge trunk
  mtu 9216
  service-policy type qos input jumbo
  vpc 11

interface port-channel12
  description FI-Uplink-D17
```

---

```
switchport mode trunk
switchport trunk allowed vlan 1,70-76
spanning-tree port type edge trunk
mtu 9216
service-policy type qos input jumbo
vpc 12
```

```
interface port-channel13
description FI-Uplink-D16
switchport mode trunk
switchport trunk allowed vlan 1,70-76
spanning-tree port type edge trunk
mtu 9216
service-policy type qos input jumbo
vpc 13
```

```
interface port-channel14
description FI-Uplink-D16
switchport mode trunk
switchport trunk allowed vlan 1,70-76
spanning-tree port type edge trunk
mtu 9216
service-policy type qos input jumbo
vpc 14
```

```
interface port-channel70
description vPC-PeerLink
switchport mode trunk
switchport trunk allowed vlan 1,70-76
spanning-tree port type network
service-policy type qos input jumbo
vpc peer-link
```

```
interface port-channel101
description to PureStorage ethernet port eth2
shutdown
```

---

```
switchport access vlan 72
spanning-tree port type edge
mtu 9216
service-policy type qos input jumbo
vpc 101

interface Ethernet1/1

interface Ethernet1/2
switchport mode trunk
switchport trunk allowed vlan 1,70-76

interface Ethernet1/3
switchport mode trunk
switchport trunk allowed vlan 1,70-76
mtu 9216
channel-group 13 mode active

interface Ethernet1/4
switchport mode trunk
switchport trunk allowed vlan 1,70-76
mtu 9216
channel-group 13 mode active

interface Ethernet1/5
switchport mode trunk
switchport trunk allowed vlan 1,70-76
mtu 9216
channel-group 14 mode active

interface Ethernet1/6
switchport mode trunk
switchport trunk allowed vlan 1,70-76
mtu 9216
channel-group 14 mode active
```

---

interface Ethernet1/7

interface Ethernet1/8

interface Ethernet1/9

interface Ethernet1/10

interface Ethernet1/11

interface Ethernet1/12

interface Ethernet1/13

interface Ethernet1/14

interface Ethernet1/15

interface Ethernet1/16

interface Ethernet1/17

interface Ethernet1/18

interface Ethernet1/19

interface Ethernet1/20

interface Ethernet1/21

interface Ethernet1/22

interface Ethernet1/23

interface Ethernet1/24

---

```
interface Ethernet1/25
```

```
interface Ethernet1/26
```

```
interface Ethernet1/27
```

```
interface Ethernet1/28
```

```
interface Ethernet1/29
```

```
interface Ethernet1/30
```

```
interface Ethernet1/31
```

```
interface Ethernet1/32
```

```
interface Ethernet1/33
```

```
    switchport access vlan 71
```

```
    spanning-tree port type edge
```

```
interface Ethernet1/34
```

```
    switchport access vlan 71
```

```
    spanning-tree port type edge
```

```
interface Ethernet1/35
```

```
interface Ethernet1/36
```

```
interface Ethernet1/37
```

```
interface Ethernet1/38
```

```
interface Ethernet1/39
```

```
interface Ethernet1/40
```

---

```
interface Ethernet1/41

interface Ethernet1/42

interface Ethernet1/43

interface Ethernet1/44

interface Ethernet1/45

interface Ethernet1/46

interface Ethernet1/47

interface Ethernet1/48

interface Ethernet1/49

interface Ethernet1/50

interface Ethernet1/51
  switchport mode trunk
  switchport trunk allowed vlan 1,70-76
  mtu 9216
  channel-group 11 mode active

interface Ethernet1/52
  switchport mode trunk
  switchport trunk allowed vlan 1,70-76
  mtu 9216
  channel-group 12 mode active

interface Ethernet1/53
  switchport mode trunk
  switchport trunk allowed vlan 1,70-76
  channel-group 70 mode active
```

```
interface Ethernet1/54
  switchport mode trunk
  switchport trunk allowed vlan 1,70-76
  channel-group 70 mode active

interface mgmt0
  vrf member management
  ip address 10.29.164.233/24
line console
line vty
boot nxos bootflash:/nxos.7.0.3.I7.2.bin
no system default switchport shutdown
```

### **Cisco Nexus 93180YC -B Configuration**

```
version 7.0(3)I7(2)
switchname AAD17-NX9K-B
class-map type network-qos class-fcoe
match qos-group 1
class-map type network-qos class-all-flood
match qos-group 2
class-map type network-qos class-ip-multicast
match qos-group 2
policy-map type network-qos jumbo
  class type network-qos class-fcoe
    mtu 2158
  class type network-qos class-default
    mtu 9216
install feature-set fcoe-npv
vdc AAD17-NX9K-B id 1
  allow feature-set fcoe-npv
  limit-resource vlan minimum 16 maximum 4094
  limit-resource vrf minimum 2 maximum 4096
  limit-resource port-channel minimum 0 maximum 511
  limit-resource u4route-mem minimum 248 maximum 248
  limit-resource u6route-mem minimum 96 maximum 96
```

```
limit-resource m4route-mem minimum 58 maximum 58
limit-resource m6route-mem minimum 8 maximum 8
feature-set fcoe-npv

feature telnet
cfs eth distribute
feature interface-vlan
feature hsrp
feature lacp
feature dhcp
feature vpc
feature lldp

no password strength-check
username admin password 5 $5$/48.OHa8$g6pOMLIwrzqxJesMYoP5CNphujBksPPRjn4I3iFfOp. role
network-admin
ip domain-lookup
system default switchport
class-map type qos match-all class-fcoe
policy-map type qos jumbo
  class class-default
    set qos-group 0
system qos
  service-policy type network-qos jumbo
copp profile lenient
snmp-server user admin network-admin auth md5 0x6d450e3d5a3927ddee1dadd30e5f616f priv
0x6d450e3d5a3927ddee1dadd30e5f616f localizedkey
snmp-server host 10.24.66.169 traps version 2c public udp-port 1166
snmp-server host 10.24.72.119 traps version 2c public udp-port 1164
rmon event 1 description FATAL(1) owner PMON@FATAL
rmon event 2 description CRITICAL(2) owner PMON@CRITICAL
rmon event 3 description ERROR(3) owner PMON@ERROR
rmon event 4 description WARNING(4) owner PMON@WARNING
rmon event 5 description INFORMATION(5) owner PMON@INFO
ntp peer 10.10.70.2 use-vrf default
ntp server 10.10.70.3 use-vrf default
ntp server 72.163.32.44 use-vrf management
```



---

```
ntp logging
ntp master 8
```

```
vlan 1,70-76
vlan 70
    name InBand-Mgmt-SP
vlan 71
    name Infra-Mgmt-SP
vlan 72
    name VM-Network-SP
vlan 73
    name vMotion-SP
vlan 74
    name Storage_A-SP
vlan 75
    name Storage_B-SP
vlan 76
    name Launcher-SP
```

```
service dhcp
ip dhcp relay
ip dhcp relay information option
ipv6 dhcp relay
vrf context management
    ip route 0.0.0.0/0 10.29.164.1
hardware access-list tcam region ing-racl 1536
hardware access-list tcam region ing-redirect 256
vpc domain 70
    role priority 2000
    peer-keepalive destination 10.29.164.233 source 10.29.164.234
```

```
interface Vlan1
    no shutdown
    ip address 10.29.164.240/24
```

---

```
interface Vlan70
  no shutdown
  ip address 10.10.70.3/24
  hsrp version 2
  hsrp 70
    preempt
    priority 110
    ip 10.10.70.1

interface Vlan71
  no shutdown
  ip address 10.10.71.3/24
  hsrp version 2
  hsrp 71
    preempt
    priority 110
    ip 10.10.71.1

interface Vlan72
  no shutdown
  ip address 10.72.0.2/19
  hsrp version 2
  hsrp 72
    preempt
    priority 110
    ip 10.72.0.1
  ip dhcp relay address 10.10.71.11
  ip dhcp relay address 10.10.71.12

interface Vlan73
  no shutdown
  ip address 10.10.73.3/24
  hsrp version 2
  hsrp 73
    preempt
    priority 110
```

---

```
    ip 10.10.73.1

interface Vlan74
  no shutdown
  ip address 10.10.74.3/24
  hsrp version 2
  hsrp 74
    preempt
    priority 110
    ip 10.10.74.1

interface Vlan75
  no shutdown
  ip address 10.10.75.3/24
  hsrp version 2
  hsrp 75
    preempt
    priority 110
    ip 10.10.75.1

interface Vlan76
  no shutdown
  ip address 10.10.76.3/23
  hsrp version 2
  hsrp 76
    preempt
    priority 110
    ip 10.10.76.1
  ip dhcp relay address 10.10.71.11
  ip dhcp relay address 10.10.71.12

interface port-channel10

interface port-channel11
  description FI-Uplink-D17
  switchport mode trunk
```

---

```
switchport trunk allowed vlan 1,70-76
spanning-tree port type edge trunk
mtu 9216
service-policy type qos input jumbo
vpc 11
```

```
interface port-channel12
description FI-Uplink-D17
switchport mode trunk
switchport trunk allowed vlan 1,70-76
spanning-tree port type edge trunk
mtu 9216
service-policy type qos input jumbo
vpc 12
```

```
interface port-channel13
description FI-Uplink-D16
switchport mode trunk
switchport trunk allowed vlan 1,70-76
spanning-tree port type edge trunk
mtu 9216
service-policy type qos input jumbo
vpc 13
```

```
interface port-channel14
description FI-Uplink-D16
switchport mode trunk
switchport trunk allowed vlan 1,70-76
spanning-tree port type edge trunk
mtu 9216
service-policy type qos input jumbo
vpc 14
```

```
interface port-channel70
description vPC-PeerLink
switchport mode trunk
```

```
switchport trunk allowed vlan 1,70-76
spanning-tree port type network
service-policy type qos input jumbo
vpc peer-link

interface port-channel101
description to PureStorage ethernet port eth2
shutdown
switchport access vlan 72
mtu 9216
service-policy type qos input jumbo
vpc 101

interface Ethernet1/1
switchport access vlan 70
speed 1000

interface Ethernet1/2
switchport mode trunk
switchport trunk allowed vlan 1,70-76

interface Ethernet1/3
switchport mode trunk
switchport trunk allowed vlan 1,70-76
mtu 9216
channel-group 13 mode active

interface Ethernet1/4
switchport mode trunk
switchport trunk allowed vlan 1,70-76
mtu 9216
channel-group 13 mode active

interface Ethernet1/5
switchport mode trunk
switchport trunk allowed vlan 1,70-76
```

---

```
mtu 9216
channel-group 14 mode active

interface Ethernet1/6
  switchport mode trunk
  switchport trunk allowed vlan 1,70-76
  mtu 9216
  channel-group 14 mode active

interface Ethernet1/7

interface Ethernet1/8

interface Ethernet1/9

interface Ethernet1/10

interface Ethernet1/11

interface Ethernet1/12

interface Ethernet1/13

interface Ethernet1/14

interface Ethernet1/15

interface Ethernet1/16

interface Ethernet1/17

interface Ethernet1/18

interface Ethernet1/19

interface Ethernet1/20
```

---

```
interface Ethernet1/21

interface Ethernet1/22

interface Ethernet1/23

interface Ethernet1/24

interface Ethernet1/25

interface Ethernet1/26

interface Ethernet1/27

interface Ethernet1/28

interface Ethernet1/29

interface Ethernet1/30

interface Ethernet1/31

interface Ethernet1/32

interface Ethernet1/33
  switchport access vlan 71
  spanning-tree port type edge

interface Ethernet1/34
  switchport access vlan 71
  spanning-tree port type edge

interface Ethernet1/35

interface Ethernet1/36
```

---

```
interface Ethernet1/37

interface Ethernet1/38

interface Ethernet1/39

interface Ethernet1/40

interface Ethernet1/41

interface Ethernet1/42

interface Ethernet1/43

interface Ethernet1/44

interface Ethernet1/45

interface Ethernet1/46

interface Ethernet1/47

interface Ethernet1/48

interface Ethernet1/49

interface Ethernet1/50

interface Ethernet1/51
  switchport mode trunk
  switchport trunk allowed vlan 1,70-76
  mtu 9216
  channel-group 11 mode active

interface Ethernet1/52
```



```
switchport mode trunk
switchport trunk allowed vlan 1,70-76
mtu 9216
channel-group 12 mode active

interface Ethernet1/53
switchport mode trunk
switchport trunk allowed vlan 1,70-76
channel-group 70 mode active

interface Ethernet1/54
switchport mode trunk
switchport trunk allowed vlan 1,70-76
channel-group 70 mode active

interface mgmt0
vrf member management
ip address 10.29.164.234/24
line console
line vty
boot nxos bootflash:/nxos.7.0.3.I7.2.bin
no system default switchport shutdown
```

## Fibre Channel Network Configuration

The following section provides a detailed procedure for configuring the Cisco MDS 9100 Switches used in this study.

### Cisco MDS 9132T-A Configuration

```
version 8.3(1)
power redundancy-mode redundant
feature npiv
feature fport-channel-trunk
role name default-role
description This is a system defined role and applies to all users.
rule 5 permit show feature environment
rule 4 permit show feature hardware
rule 3 permit show feature module
rule 2 permit show feature snmp
```

```
rule 1 permit show feature system
no password strength-check
username admin password 5 $5$Dcs72Ao/$8lHyVrotTm4skqb/84BC793tgdly/yWf9IoMx2OEg6C role
network-admin
ip domain-lookup
ip name-server 10.10.61.30
ip host ADD16-MDS-A 10.29.164.238
aaa group server radius radius
snmp-server user admin network-admin auth md5 0x616758aed4f07bab2d24f3d594ebd649 priv
0x616758aed4f07bab2d24f3d594ebd649 localizedkey
snmp-server host 10.24.30.91 traps version 2c public udp-port 1163
snmp-server host 10.24.46.67 traps version 2c public udp-port 1163
snmp-server host 10.24.66.169 traps version 2c public udp-port 1163
snmp-server host 10.24.72.119 traps version 2c public udp-port 1165
rmon event 1 log trap public description FATAL(1) owner PMON@FATAL
rmon event 2 log trap public description CRITICAL(2) owner PMON@CRITICAL
rmon event 3 log trap public description ERROR(3) owner PMON@ERROR
rmon event 4 log trap public description WARNING(4) owner PMON@WARNING
rmon event 5 log trap public description INFORMATION(5) owner PMON@INFO
ntp server 10.81.254.131
ntp server 10.81.254.202
vsan database
vsan 100 name "FlashStack-VCC-CVD-Fabric-A"
device-alias database
device-alias name X70R3-CT0-FC0 pwnn 52:4a:93:71:56:84:09:00
device-alias name X70R3-CT1-FC0 pwnn 52:4a:93:71:56:84:09:10
device-alias name VCC-Infra01-HBA0 pwnn 20:00:00:25:b5:aa:17:1e
device-alias name VCC-Infra01-HBA2 pwnn 20:00:00:25:b5:aa:17:1f
device-alias name VCC-Infra02-HBA0 pwnn 20:00:00:25:b5:aa:17:3e
device-alias name VCC-Infra02-HBA2 pwnn 20:00:00:25:b5:aa:17:3f
device-alias name VCC-WLHost01-HBA0 pwnn 20:00:00:25:b5:aa:17:00
device-alias name VCC-WLHost01-HBA2 pwnn 20:00:00:25:b5:aa:17:01
device-alias name VCC-WLHost02-HBA0 pwnn 20:00:00:25:b5:aa:17:02
device-alias name VCC-WLHost02-HBA2 pwnn 20:00:00:25:b5:aa:17:03
device-alias name VCC-WLHost03-HBA0 pwnn 20:00:00:25:b5:aa:17:04
device-alias name VCC-WLHost03-HBA2 pwnn 20:00:00:25:b5:aa:17:05
device-alias name VCC-WLHost04-HBA0 pwnn 20:00:00:25:b5:aa:17:06
```

```
device-alias name VCC-WLHost04-HBA2 pwn 20:00:00:25:b5:aa:17:07
device-alias name VCC-WLHost05-HBA0 pwn 20:00:00:25:b5:aa:17:08
device-alias name VCC-WLHost05-HBA2 pwn 20:00:00:25:b5:aa:17:09
device-alias name VCC-WLHost06-HBA0 pwn 20:00:00:25:b5:aa:17:0a
device-alias name VCC-WLHost06-HBA2 pwn 20:00:00:25:b5:aa:17:0b
device-alias name VCC-WLHost07-HBA0 pwn 20:00:00:25:b5:aa:17:0c
device-alias name VCC-WLHost07-HBA2 pwn 20:00:00:25:b5:aa:17:0d
device-alias name VCC-WLHost08-HBA0 pwn 20:00:00:25:b5:aa:17:0e
device-alias name VCC-WLHost08-HBA2 pwn 20:00:00:25:b5:aa:17:0f
device-alias name VCC-WLHost09-HBA0 pwn 20:00:00:25:b5:aa:17:10
device-alias name VCC-WLHost09-HBA2 pwn 20:00:00:25:b5:aa:17:11
device-alias name VCC-WLHost10-HBA0 pwn 20:00:00:25:b5:aa:17:12
device-alias name VCC-WLHost10-HBA2 pwn 20:00:00:25:b5:aa:17:13
device-alias name VCC-WLHost11-HBA0 pwn 20:00:00:25:b5:aa:17:14
device-alias name VCC-WLHost11-HBA2 pwn 20:00:00:25:b5:aa:17:15
device-alias name VCC-WLHost12-HBA0 pwn 20:00:00:25:b5:aa:17:16
device-alias name VCC-WLHost12-HBA2 pwn 20:00:00:25:b5:aa:17:17
device-alias name VCC-WLHost13-HBA0 pwn 20:00:00:25:b5:aa:17:18
device-alias name VCC-WLHost13-HBA2 pwn 20:00:00:25:b5:aa:17:19
device-alias name VCC-WLHost14-HBA0 pwn 20:00:00:25:b5:aa:17:1a
device-alias name VCC-WLHost14-HBA2 pwn 20:00:00:25:b5:aa:17:1b
device-alias name VCC-WLHost15-HBA0 pwn 20:00:00:25:b5:aa:17:1c
device-alias name VCC-WLHost15-HBA2 pwn 20:00:00:25:b5:aa:17:1d
device-alias name VCC-WLHost16-HBA0 pwn 20:00:00:25:b5:aa:17:20
device-alias name VCC-WLHost16-HBA2 pwn 20:00:00:25:b5:aa:17:21
device-alias name VCC-WLHost17-HBA0 pwn 20:00:00:25:b5:aa:17:22
device-alias name VCC-WLHost17-HBA2 pwn 20:00:00:25:b5:aa:17:23
device-alias name VCC-WLHost18-HBA0 pwn 20:00:00:25:b5:aa:17:24
device-alias name VCC-WLHost18-HBA2 pwn 20:00:00:25:b5:aa:17:25
device-alias name VCC-WLHost19-HBA0 pwn 20:00:00:25:b5:aa:17:26
device-alias name VCC-WLHost19-HBA2 pwn 20:00:00:25:b5:aa:17:27
device-alias name VCC-WLHost20-HBA0 pwn 20:00:00:25:b5:aa:17:28
device-alias name VCC-WLHost20-HBA2 pwn 20:00:00:25:b5:aa:17:29
device-alias name VCC-WLHost21-HBA0 pwn 20:00:00:25:b5:aa:17:2a
device-alias name VCC-WLHost21-HBA2 pwn 20:00:00:25:b5:aa:17:2b
device-alias name VCC-WLHost22-HBA0 pwn 20:00:00:25:b5:aa:17:2c
```

```
device-alias name VCC-WLHost22-HBA2 pwwn 20:00:00:25:b5:aa:17:2d
device-alias name VCC-WLHost23-HBA0 pwwn 20:00:00:25:b5:aa:17:2e
device-alias name VCC-WLHost23-HBA2 pwwn 20:00:00:25:b5:aa:17:2f
device-alias name VCC-WLHost24-HBA0 pwwn 20:00:00:25:b5:aa:17:30
device-alias name VCC-WLHost24-HBA2 pwwn 20:00:00:25:b5:aa:17:31
device-alias name VCC-WLHost25-HBA0 pwwn 20:00:00:25:b5:aa:17:32
device-alias name VCC-WLHost25-HBA2 pwwn 20:00:00:25:b5:aa:17:33
device-alias name VCC-WLHost26-HBA0 pwwn 20:00:00:25:b5:aa:17:34
device-alias name VCC-WLHost26-HBA2 pwwn 20:00:00:25:b5:aa:17:35
device-alias name VCC-WLHost27-HBA0 pwwn 20:00:00:25:b5:aa:17:36
device-alias name VCC-WLHost27-HBA2 pwwn 20:00:00:25:b5:aa:17:37
device-alias name VCC-WLHost28-HBA0 pwwn 20:00:00:25:b5:aa:17:38
device-alias name VCC-WLHost28-HBA2 pwwn 20:00:00:25:b5:aa:17:39
device-alias name VCC-WLHost29-HBA0 pwwn 20:00:00:25:b5:aa:17:3a
device-alias name VCC-WLHost29-HBA2 pwwn 20:00:00:25:b5:aa:17:3b
device-alias name VCC-WLHost30-HBA0 pwwn 20:00:00:25:b5:aa:17:3c
device-alias name VCC-WLHost30-HBA2 pwwn 20:00:00:25:b5:aa:17:3d
```

```
device-alias commit
```

```
fcdomain fcid database
```

```
vsan 100 wwn 20:03:00:de:fb:92:8d:00 fcid 0x300000 dynamic
vsan 100 wwn 52:4a:93:75:dd:91:0a:02 fcid 0x300020 dynamic
!
[X70-CT0-FC2]
vsan 100 wwn 52:4a:93:75:dd:91:0a:17 fcid 0x300040 dynamic
vsan 100 wwn 52:4a:93:75:dd:91:0a:06 fcid 0x300041 dynamic
!
[X70-CT0-FC8]
vsan 100 wwn 52:4a:93:75:dd:91:0a:07 fcid 0x300042 dynamic
vsan 100 wwn 52:4a:93:75:dd:91:0a:16 fcid 0x300043 dynamic
!
[X70-CT1-FC8]
vsan 100 wwn 20:00:00:25:b5:aa:17:3e fcid 0x300060 dynamic
!
[VCC-Infra02-HBA0]
vsan 100 wwn 20:00:00:25:b5:aa:17:07 fcid 0x300061 dynamic
!
[VCC-WLHost04-HBA2]
vsan 100 wwn 20:00:00:25:b5:aa:17:06 fcid 0x300062 dynamic
!
[VCC-WLHost04-HBA0]
```

```
vsan 100 wwn 20:00:00:25:b5:aa:17:3a fcid 0x300063 dynamic
!          [VCC-WLHost29-HBA0]
vsan 100 wwn 20:00:00:25:b5:aa:17:29 fcid 0x300064 dynamic
!          [VCC-WLHost20-HBA2]
vsan 100 wwn 20:00:00:25:b5:aa:17:13 fcid 0x300065 dynamic
!          [VCC-WLHost10-HBA2]
vsan 100 wwn 20:00:00:25:b5:aa:17:1c fcid 0x300066 dynamic
!          [VCC-WLHost15-HBA0]
vsan 100 wwn 20:00:00:25:b5:aa:17:32 fcid 0x300067 dynamic
!          [VCC-WLHost25-HBA0]
vsan 100 wwn 20:00:00:25:b5:aa:17:17 fcid 0x300068 dynamic
!          [VCC-WLHost12-HBA2]
vsan 100 wwn 20:00:00:25:b5:aa:17:2e fcid 0x300069 dynamic
!          [VCC-WLHost23-HBA0]
vsan 100 wwn 20:00:00:25:b5:aa:17:1f fcid 0x30006a dynamic
!          [VCC-Infra01-HBA2]
vsan 100 wwn 20:00:00:25:b5:aa:17:1b fcid 0x30006b dynamic
!          [VCC-WLHost14-HBA2]
vsan 100 wwn 20:00:00:25:b5:aa:17:1a fcid 0x30006c dynamic
!          [VCC-WLHost14-HBA0]
vsan 100 wwn 20:00:00:25:b5:aa:17:0a fcid 0x30006d dynamic
!          [VCC-WLHost06-HBA0]
vsan 100 wwn 20:00:00:25:b5:aa:17:34 fcid 0x30006e dynamic
!          [VCC-WLHost26-HBA0]
vsan 100 wwn 20:00:00:25:b5:aa:17:19 fcid 0x30006f dynamic
!          [VCC-WLHost13-HBA2]
vsan 100 wwn 20:00:00:25:b5:aa:17:36 fcid 0x300070 dynamic
!          [VCC-WLHost27-HBA0]
vsan 100 wwn 20:00:00:25:b5:aa:17:01 fcid 0x300071 dynamic
!          [VCC-WLHost01-HBA2]
vsan 100 wwn 20:00:00:25:b5:aa:17:12 fcid 0x300072 dynamic
!          [VCC-WLHost10-HBA0]
vsan 100 wwn 20:00:00:25:b5:aa:17:16 fcid 0x300073 dynamic
!          [VCC-WLHost12-HBA0]
vsan 100 wwn 20:00:00:25:b5:aa:17:2b fcid 0x300074 dynamic
!          [VCC-WLHost21-HBA2]
```

```
vsan 100 wwn 20:00:00:25:b5:aa:17:25 fcid 0x300075 dynamic
!          [VCC-WLHost18-HBA2]
vsan 100 wwn 20:00:00:25:b5:aa:17:27 fcid 0x300076 dynamic
!          [VCC-WLHost19-HBA2]
vsan 100 wwn 20:00:00:25:b5:aa:17:3d fcid 0x300077 dynamic
!          [VCC-WLHost30-HBA2]
vsan 100 wwn 20:00:00:25:b5:aa:17:15 fcid 0x300078 dynamic
!          [VCC-WLHost11-HBA2]
vsan 100 wwn 20:00:00:25:b5:aa:17:38 fcid 0x300079 dynamic
!          [VCC-WLHost28-HBA0]
vsan 100 wwn 20:00:00:25:b5:aa:17:23 fcid 0x30007a dynamic
!          [VCC-WLHost17-HBA2]
vsan 100 wwn 20:00:00:25:b5:aa:17:00 fcid 0x30007b dynamic
!          [VCC-WLHost01-HBA0]
vsan 100 wwn 20:00:00:25:b5:aa:17:04 fcid 0x30007c dynamic
!          [VCC-WLHost03-HBA0]
vsan 100 wwn 20:00:00:25:b5:aa:17:03 fcid 0x30007d dynamic
!          [VCC-WLHost02-HBA2]
vsan 100 wwn 20:00:00:25:b5:aa:17:0f fcid 0x30007e dynamic
!          [VCC-WLHost08-HBA2]
vsan 100 wwn 20:00:00:25:b5:aa:17:1d fcid 0x30007f dynamic
!          [VCC-WLHost15-HBA2]
vsan 100 wwn 20:00:00:25:b5:aa:17:31 fcid 0x300080 dynamic
!          [VCC-WLHost24-HBA2]
vsan 100 wwn 20:00:00:25:b5:aa:17:30 fcid 0x300081 dynamic
!          [VCC-WLHost24-HBA0]
vsan 100 wwn 20:00:00:25:b5:aa:17:02 fcid 0x300082 dynamic
!          [VCC-WLHost02-HBA0]
vsan 100 wwn 20:00:00:25:b5:aa:17:08 fcid 0x300083 dynamic
!          [VCC-WLHost05-HBA0]
vsan 100 wwn 20:00:00:25:b5:aa:17:26 fcid 0x300084 dynamic
!          [VCC-WLHost19-HBA0]
vsan 100 wwn 20:00:00:25:b5:aa:17:22 fcid 0x300085 dynamic
!          [VCC-WLHost17-HBA0]
vsan 100 wwn 20:00:00:25:b5:aa:17:2c fcid 0x300086 dynamic
!          [VCC-WLHost22-HBA0]
```

```
vsan 100 wwn 20:00:00:25:b5:aa:17:33 fcid 0x300087 dynamic
!          [VCC-WLHost25-HBA2]
vsan 100 wwn 20:00:00:25:b5:aa:17:21 fcid 0x300088 dynamic
!          [VCC-WLHost16-HBA2]
vsan 100 wwn 20:00:00:25:b5:aa:17:2d fcid 0x300089 dynamic
!          [VCC-WLHost22-HBA2]
vsan 100 wwn 20:00:00:25:b5:aa:17:24 fcid 0x30008a dynamic
!          [VCC-WLHost18-HBA0]
vsan 100 wwn 20:00:00:25:b5:aa:17:3f fcid 0x30008b dynamic
!          [VCC-Infra02-HBA2]
vsan 100 wwn 20:00:00:25:b5:aa:17:39 fcid 0x30008c dynamic
!          [VCC-WLHost28-HBA2]
vsan 100 wwn 20:00:00:25:b5:aa:17:3c fcid 0x30008d dynamic
!          [VCC-WLHost30-HBA0]
vsan 100 wwn 20:00:00:25:b5:aa:17:14 fcid 0x30008e dynamic
!          [VCC-WLHost11-HBA0]
vsan 100 wwn 20:00:00:25:b5:aa:17:11 fcid 0x30008f dynamic
!          [VCC-WLHost09-HBA2]
vsan 100 wwn 20:00:00:25:b5:aa:17:10 fcid 0x300090 dynamic
!          [VCC-WLHost09-HBA0]
vsan 100 wwn 20:00:00:25:b5:aa:17:05 fcid 0x300091 dynamic
!          [VCC-WLHost03-HBA2]
vsan 100 wwn 20:00:00:25:b5:aa:17:0e fcid 0x300092 dynamic
!          [VCC-WLHost08-HBA0]
vsan 100 wwn 20:00:00:25:b5:aa:17:0d fcid 0x300093 dynamic
!          [VCC-WLHost07-HBA2]
vsan 100 wwn 20:00:00:25:b5:aa:17:0c fcid 0x300094 dynamic
!          [VCC-WLHost07-HBA0]
vsan 100 wwn 20:00:00:25:b5:aa:17:1e fcid 0x300095 dynamic
!          [VCC-Infra01-HBA0]
vsan 100 wwn 20:00:00:25:b5:aa:17:0b fcid 0x300096 dynamic
!          [VCC-WLHost06-HBA2]
vsan 100 wwn 20:00:00:25:b5:aa:17:28 fcid 0x300097 dynamic
!          [VCC-WLHost20-HBA0]
vsan 100 wwn 20:00:00:25:b5:aa:17:37 fcid 0x300098 dynamic
!          [VCC-WLHost27-HBA2]
```

```
vsan 100 wwn 20:00:00:25:b5:aa:17:3b fcid 0x300099 dynamic
!          [VCC-WLHost29-HBA2]
vsan 100 wwn 20:00:00:25:b5:aa:17:09 fcid 0x30009a dynamic
!          [VCC-WLHost05-HBA2]
vsan 100 wwn 20:00:00:25:b5:aa:17:2a fcid 0x30009b dynamic
!          [VCC-WLHost21-HBA0]
vsan 100 wwn 20:00:00:25:b5:aa:17:2f fcid 0x30009c dynamic
!          [VCC-WLHost23-HBA2]
vsan 100 wwn 20:00:00:25:b5:aa:17:20 fcid 0x30009d dynamic
!          [VCC-WLHost16-HBA0]
vsan 100 wwn 20:00:00:25:b5:aa:17:35 fcid 0x30009e dynamic
!          [VCC-WLHost26-HBA2]
vsan 100 wwn 20:00:00:25:b5:aa:17:18 fcid 0x30009f dynamic
!          [VCC-WLHost13-HBA0]
vsan 100 wwn 20:02:00:de:fb:92:8d:00 fcid 0x3000a0 dynamic
vsan 100 wwn 20:04:00:de:fb:92:8d:00 fcid 0x3000c0 dynamic
vsan 100 wwn 20:01:00:de:fb:92:8d:00 fcid 0x3000e0 dynamic
vsan 100 wwn 52:4a:93:75:dd:91:0a:00 fcid 0x300044 dynamic
!          [X70-CT0-FC0]
vsan 100 wwn 20:01:00:3a:9c:0e:33:20 fcid 0x3000e1 dynamic
vsan 100 wwn 20:02:00:3a:9c:0e:33:20 fcid 0x3000a1 dynamic
vsan 100 wwn 20:04:00:3a:9c:0e:33:20 fcid 0x3000c1 dynamic
vsan 100 wwn 20:03:00:3a:9c:0e:33:20 fcid 0x300100 dynamic
vsan 100 wwn 52:4a:93:75:dd:91:0a:10 fcid 0x300021 dynamic
!          [X70-CT1-FC0]
vsan 100 wwn 52:4a:93:71:56:84:09:12 fcid 0x300022 dynamic
vsan 100 wwn 52:4a:93:71:56:84:09:10 fcid 0x300045 dynamic
!          [X70R3-CT1-FC0]
vsan 100 wwn 52:4a:93:71:56:84:09:02 fcid 0x300046 dynamic
vsan 100 wwn 52:4a:93:71:56:84:09:00 fcid 0x300023 dynamic
!          [X70R3-CT0-FC0]
vsan 100 wwn 20:00:00:25:b5:aa:17:40 fcid 0x3000e2 dynamic
!          [AMD-VMHost70-HBA0]
vsan 100 wwn 20:00:00:25:b5:aa:17:41 fcid 0x3000a2 dynamic
!          [AMD-VMHost70-HBA2]
vsan 100 wwn 20:00:00:25:b5:aa:17:44 fcid 0x3000e3 dynamic
```



```
!           [AMD-VMHost72-HBA0]
vsan 100 wwn 20:00:00:25:b5:aa:17:45 fcid 0x3000a3 dynamic
!           [AMD-VMHost72-HBA2]
vsan 100 wwn 20:00:00:25:b5:aa:17:4e fcid 0x3000e4 dynamic
!           [AMD-VMHost73-HBA0]
vsan 100 wwn 20:00:00:25:b5:aa:17:4f fcid 0x3000a4 dynamic
!           [AMD-VMHost73-HBA2]
vsan 100 wwn 20:00:00:25:b5:aa:17:42 fcid 0x3000e5 dynamic
!           [AMD-VMHost71-HBA0]
vsan 100 wwn 20:00:00:25:b5:aa:17:43 fcid 0x3000a5 dynamic
!           [AMD-VMHost71-HBA2]
vsan 100 wwn 20:00:00:25:b5:aa:17:46 fcid 0x3000e6 dynamic
!           [AMD-VMHost74-HBA0]
vsan 100 wwn 20:00:00:25:b5:aa:17:47 fcid 0x3000a6 dynamic
!           [AMD-VMHost74-HBA2]
vsan 100 wwn 20:00:00:25:b5:aa:17:48 fcid 0x3000e7 dynamic
!           [AMD-VMHost75-HBA0]
vsan 100 wwn 20:00:00:25:b5:aa:17:49 fcid 0x3000a7 dynamic
!           [AMD-VMHost75-HBA2]
vsan 100 wwn 20:00:00:25:b5:aa:17:4a fcid 0x3000e8 dynamic
!           [AMD-VMHost76-HBA0]
vsan 100 wwn 20:00:00:25:b5:aa:17:4b fcid 0x3000a8 dynamic
!           [AMD-VMHost76-HBA2]
vsan 100 wwn 20:00:00:25:b5:aa:17:4c fcid 0x3000e9 dynamic
!           [AMD-VMHost77-HBA0]
vsan 100 wwn 20:00:00:25:b5:aa:17:4d fcid 0x3000a9 dynamic
!           [AMD-VMHost77-HBA2]
```

!Active Zone Database Section for vsan 100

zone name FlaskStack-VCC-CVD-WLHost01 vsan 100

member pwwn 20:00:00:25:b5:aa:17:00

! [VCC-WLHost01-HBA0]

member pwwn 20:00:00:25:b5:aa:17:01

! [VCC-WLHost01-HBA2]

member pwwn 52:4a:93:71:56:84:09:00

! [X70R3-CT0-FC0]

---

```
member pwnn 52:4a:93:71:56:84:09:10
!           [X70R3-CT1-FC0]
```

```
zone name FlaskStack-VCC-CVD-WLHost02 vsan 100
```

```
member pwnn 20:00:00:25:b5:aa:17:02
!           [VCC-WLHost02-HBA0]
member pwnn 20:00:00:25:b5:aa:17:03
!           [VCC-WLHost02-HBA2]
member pwnn 52:4a:93:71:56:84:09:00
!           [X70R3-CT0-FC0]
member pwnn 52:4a:93:71:56:84:09:10
!           [X70R3-CT1-FC0]
```

```
zone name FlaskStack-VCC-CVD-WLHost03 vsan 100
```

```
member pwnn 20:00:00:25:b5:aa:17:04
!           [VCC-WLHost03-HBA0]
member pwnn 20:00:00:25:b5:aa:17:05
!           [VCC-WLHost03-HBA2]
member pwnn 52:4a:93:71:56:84:09:00
!           [X70R3-CT0-FC0]
member pwnn 52:4a:93:71:56:84:09:10
!           [X70R3-CT1-FC0]
```

```
zone name FlaskStack-VCC-CVD-WLHost04 vsan 100
```

```
member pwnn 20:00:00:25:b5:aa:17:06
!           [VCC-WLHost04-HBA0]
member pwnn 20:00:00:25:b5:aa:17:07
!           [VCC-WLHost04-HBA2]
member pwnn 52:4a:93:71:56:84:09:00
!           [X70R3-CT0-FC0]
member pwnn 52:4a:93:71:56:84:09:10
!           [X70R3-CT1-FC0]
```

```
zone name FlaskStack-VCC-CVD-WLHost05 vsan 100
```

```
member pwnn 20:00:00:25:b5:aa:17:08
!           [VCC-WLHost05-HBA0]
```

---

```
member pwn 20:00:00:25:b5:aa:17:09
!          [VCC-WLHost05-HBA2]
member pwn 52:4a:93:71:56:84:09:00
!          [X70R3-CT0-FC0]
member pwn 52:4a:93:71:56:84:09:10
!          [X70R3-CT1-FC0]
```

```
zone name FlaskStack-VCC-CVD-WLHost06 vsan 100
```

```
member pwn 20:00:00:25:b5:aa:17:0a
!          [VCC-WLHost06-HBA0]
member pwn 20:00:00:25:b5:aa:17:0b
!          [VCC-WLHost06-HBA2]
member pwn 52:4a:93:71:56:84:09:00
!          [X70R3-CT0-FC0]
member pwn 52:4a:93:71:56:84:09:10
!          [X70R3-CT1-FC0]
```

```
zone name FlaskStack-VCC-CVD-WLHost07 vsan 100
```

```
member pwn 20:00:00:25:b5:aa:17:0c
!          [VCC-WLHost07-HBA0]
member pwn 20:00:00:25:b5:aa:17:0d
!          [VCC-WLHost07-HBA2]
member pwn 52:4a:93:71:56:84:09:00
!          [X70R3-CT0-FC0]
member pwn 52:4a:93:71:56:84:09:10
!          [X70R3-CT1-FC0]
```

```
zone name FlaskStack-VCC-CVD-WLHost08 vsan 100
```

```
member pwn 20:00:00:25:b5:aa:17:0e
!          [VCC-WLHost08-HBA0]
member pwn 20:00:00:25:b5:aa:17:0f
!          [VCC-WLHost08-HBA2]
member pwn 52:4a:93:71:56:84:09:00
!          [X70R3-CT0-FC0]
member pwn 52:4a:93:71:56:84:09:10
!          [X70R3-CT1-FC0]
```

---

```
zone name FlaskStack-VCC-CVD-WLHost09 vsan 100
  member pwnn 20:00:00:25:b5:aa:17:10
  !           [VCC-WLHost09-HBA0]
  member pwnn 20:00:00:25:b5:aa:17:11
  !           [VCC-WLHost09-HBA2]
  member pwnn 52:4a:93:71:56:84:09:00
  !           [X70R3-CT0-FC0]
  member pwnn 52:4a:93:71:56:84:09:10
  !           [X70R3-CT1-FC0]
```

```
zone name FlaskStack-VCC-CVD-WLHost10 vsan 100
  member pwnn 20:00:00:25:b5:aa:17:12
  !           [VCC-WLHost10-HBA0]
  member pwnn 20:00:00:25:b5:aa:17:13
  !           [VCC-WLHost10-HBA2]
  member pwnn 52:4a:93:71:56:84:09:00
  !           [X70R3-CT0-FC0]
  member pwnn 52:4a:93:71:56:84:09:10
  !           [X70R3-CT1-FC0]
```

```
zone name FlaskStack-VCC-CVD-WLHost11 vsan 100
  member pwnn 20:00:00:25:b5:aa:17:14
  !           [VCC-WLHost11-HBA0]
  member pwnn 20:00:00:25:b5:aa:17:15
  !           [VCC-WLHost11-HBA2]
  member pwnn 52:4a:93:71:56:84:09:00
  !           [X70R3-CT0-FC0]
  member pwnn 52:4a:93:71:56:84:09:10
  !           [X70R3-CT1-FC0]
```

```
zone name FlaskStack-VCC-CVD-WLHost12 vsan 100
  member pwnn 20:00:00:25:b5:aa:17:16
  !           [VCC-WLHost12-HBA0]
  member pwnn 20:00:00:25:b5:aa:17:17
  !           [VCC-WLHost12-HBA2]
```

---

```
member pwnn 52:4a:93:71:56:84:09:00
!           [X70R3-CT0-FC0]
member pwnn 52:4a:93:71:56:84:09:10
!           [X70R3-CT1-FC0]
```

```
zone name FlaskStack-VCC-CVD-WLHost13 vsan 100
member pwnn 20:00:00:25:b5:aa:17:18
!           [VCC-WLHost13-HBA0]
member pwnn 20:00:00:25:b5:aa:17:19
!           [VCC-WLHost13-HBA2]
member pwnn 52:4a:93:71:56:84:09:00
!           [X70R3-CT0-FC0]
member pwnn 52:4a:93:71:56:84:09:10
!           [X70R3-CT1-FC0]
```

```
zone name FlaskStack-VCC-CVD-WLHost14 vsan 100
member pwnn 20:00:00:25:b5:aa:17:1a
!           [VCC-WLHost14-HBA0]
member pwnn 20:00:00:25:b5:aa:17:1b
!           [VCC-WLHost14-HBA2]
member pwnn 52:4a:93:71:56:84:09:00
!           [X70R3-CT0-FC0]
member pwnn 52:4a:93:71:56:84:09:10
!           [X70R3-CT1-FC0]
```

```
zone name FlaskStack-VCC-CVD-WLHost15 vsan 100
member pwnn 20:00:00:25:b5:aa:17:1c
!           [VCC-WLHost15-HBA0]
member pwnn 20:00:00:25:b5:aa:17:1d
!           [VCC-WLHost15-HBA2]
member pwnn 52:4a:93:71:56:84:09:00
!           [X70R3-CT0-FC0]
member pwnn 52:4a:93:71:56:84:09:10
!           [X70R3-CT1-FC0]
```

```
zone name FlaskStack-VCC-CVD-Infra01 vsan 100
```

```
member pwnn 20:00:00:25:b5:aa:17:1e
!           [VCC-Infra01-HBA0]
member pwnn 20:00:00:25:b5:aa:17:1f
!           [VCC-Infra01-HBA2]
member pwnn 52:4a:93:71:56:84:09:00
!           [X70R3-CT0-FC0]
member pwnn 52:4a:93:71:56:84:09:10
!           [X70R3-CT1-FC0]
```

```
zone name FlaskStack-VCC-CVD-WLHost16 vsan 100
```

```
member pwnn 20:00:00:25:b5:aa:17:20
!           [VCC-WLHost16-HBA0]
member pwnn 20:00:00:25:b5:aa:17:21
!           [VCC-WLHost16-HBA2]
member pwnn 52:4a:93:71:56:84:09:00
!           [X70R3-CT0-FC0]
member pwnn 52:4a:93:71:56:84:09:10
!           [X70R3-CT1-FC0]
```

```
zone name FlaskStack-VCC-CVD-WLHost17 vsan 100
```

```
member pwnn 20:00:00:25:b5:aa:17:22
!           [VCC-WLHost17-HBA0]
member pwnn 20:00:00:25:b5:aa:17:23
!           [VCC-WLHost17-HBA2]
member pwnn 52:4a:93:71:56:84:09:00
!           [X70R3-CT0-FC0]
member pwnn 52:4a:93:71:56:84:09:10
!           [X70R3-CT1-FC0]
```

```
zone name FlaskStack-VCC-CVD-WLHost18 vsan 100
```

```
member pwnn 20:00:00:25:b5:aa:17:24
!           [VCC-WLHost18-HBA0]
member pwnn 20:00:00:25:b5:aa:17:25
!           [VCC-WLHost18-HBA2]
member pwnn 52:4a:93:71:56:84:09:00
!           [X70R3-CT0-FC0]
```

---

```
member pwnn 52:4a:93:71:56:84:09:10
!           [X70R3-CT1-FC0]
```

```
zone name FlaskStack-VCC-CVD-WLHost19 vsan 100
```

```
member pwnn 20:00:00:25:b5:aa:17:26
!           [VCC-WLHost19-HBA0]
member pwnn 20:00:00:25:b5:aa:17:27
!           [VCC-WLHost19-HBA2]
member pwnn 52:4a:93:71:56:84:09:00
!           [X70R3-CT0-FC0]
member pwnn 52:4a:93:71:56:84:09:10
!           [X70R3-CT1-FC0]
```

```
zone name FlaskStack-VCC-CVD-WLHost20 vsan 100
```

```
member pwnn 20:00:00:25:b5:aa:17:28
!           [VCC-WLHost20-HBA0]
member pwnn 20:00:00:25:b5:aa:17:29
!           [VCC-WLHost20-HBA2]
member pwnn 52:4a:93:71:56:84:09:00
!           [X70R3-CT0-FC0]
member pwnn 52:4a:93:71:56:84:09:10
!           [X70R3-CT1-FC0]
```

```
zone name FlaskStack-VCC-CVD-WLHost21 vsan 100
```

```
member pwnn 20:00:00:25:b5:aa:17:2a
!           [VCC-WLHost21-HBA0]
member pwnn 20:00:00:25:b5:aa:17:2b
!           [VCC-WLHost21-HBA2]
member pwnn 52:4a:93:71:56:84:09:00
!           [X70R3-CT0-FC0]
member pwnn 52:4a:93:71:56:84:09:10
!           [X70R3-CT1-FC0]
```

```
zone name FlaskStack-VCC-CVD-WLHost22 vsan 100
```

```
member pwnn 20:00:00:25:b5:aa:17:2c
!           [VCC-WLHost22-HBA0]
```

---

```
member pwn 20:00:00:25:b5:aa:17:2d
!          [VCC-WLHost22-HBA2]
member pwn 52:4a:93:71:56:84:09:00
!          [X70R3-CT0-FC0]
member pwn 52:4a:93:71:56:84:09:10
!          [X70R3-CT1-FC0]
```

```
zone name FlaskStack-VCC-CVD-WLHost23 vsan 100
```

```
member pwn 20:00:00:25:b5:aa:17:2e
!          [VCC-WLHost23-HBA0]
member pwn 20:00:00:25:b5:aa:17:2f
!          [VCC-WLHost23-HBA2]
member pwn 52:4a:93:71:56:84:09:00
!          [X70R3-CT0-FC0]
member pwn 52:4a:93:71:56:84:09:10
!          [X70R3-CT1-FC0]
```

```
zone name FlaskStack-VCC-CVD-WLHost24 vsan 100
```

```
member pwn 20:00:00:25:b5:aa:17:30
!          [VCC-WLHost24-HBA0]
member pwn 20:00:00:25:b5:aa:17:31
!          [VCC-WLHost24-HBA2]
member pwn 52:4a:93:71:56:84:09:00
!          [X70R3-CT0-FC0]
member pwn 52:4a:93:71:56:84:09:10
!          [X70R3-CT1-FC0]
```

```
zone name FlaskStack-VCC-CVD-WLHost25 vsan 100
```

```
member pwn 20:00:00:25:b5:aa:17:32
!          [VCC-WLHost25-HBA0]
member pwn 20:00:00:25:b5:aa:17:33
!          [VCC-WLHost25-HBA2]
member pwn 52:4a:93:71:56:84:09:00
!          [X70R3-CT0-FC0]
member pwn 52:4a:93:71:56:84:09:10
!          [X70R3-CT1-FC0]
```



---

```
zone name FlaskStack-VCC-CVD-WLHost26 vsan 100
  member pwnn 20:00:00:25:b5:aa:17:34
  !           [VCC-WLHost26-HBA0]
  member pwnn 20:00:00:25:b5:aa:17:35
  !           [VCC-WLHost26-HBA2]
  member pwnn 52:4a:93:71:56:84:09:00
  !           [X70R3-CT0-FC0]
  member pwnn 52:4a:93:71:56:84:09:10
  !           [X70R3-CT1-FC0]
```

```
zone name FlaskStack-VCC-CVD-WLHost27 vsan 100
  member pwnn 20:00:00:25:b5:aa:17:36
  !           [VCC-WLHost27-HBA0]
  member pwnn 20:00:00:25:b5:aa:17:37
  !           [VCC-WLHost27-HBA2]
  member pwnn 52:4a:93:71:56:84:09:00
  !           [X70R3-CT0-FC0]
  member pwnn 52:4a:93:71:56:84:09:10
  !           [X70R3-CT1-FC0]
```

```
zone name FlaskStack-VCC-CVD-WLHost28 vsan 100
  member pwnn 20:00:00:25:b5:aa:17:38
  !           [VCC-WLHost28-HBA0]
  member pwnn 20:00:00:25:b5:aa:17:39
  !           [VCC-WLHost28-HBA2]
  member pwnn 52:4a:93:71:56:84:09:00
  !           [X70R3-CT0-FC0]
  member pwnn 52:4a:93:71:56:84:09:10
  !           [X70R3-CT1-FC0]
```

```
zone name FlaskStack-VCC-CVD-WLHost29 vsan 100
  member pwnn 20:00:00:25:b5:aa:17:3a
  !           [VCC-WLHost29-HBA0]
  member pwnn 20:00:00:25:b5:aa:17:3b
  !           [VCC-WLHost29-HBA2]
```

---

```
member pwnn 52:4a:93:71:56:84:09:00
!           [X70R3-CT0-FC0]
member pwnn 52:4a:93:71:56:84:09:10
!           [X70R3-CT1-FC0]
```

```
zone name FlaskStack-VCC-CVD-WLHost30 vsan 100
member pwnn 20:00:00:25:b5:aa:17:3c
!           [VCC-WLHost30-HBA0]
member pwnn 20:00:00:25:b5:aa:17:3d
!           [VCC-WLHost30-HBA2]
member pwnn 52:4a:93:71:56:84:09:00
!           [X70R3-CT0-FC0]
member pwnn 52:4a:93:71:56:84:09:10
!           [X70R3-CT1-FC0]
```

```
zone name FlaskStack-VCC-CVD-Infra02 vsan 100
member pwnn 20:00:00:25:b5:aa:17:3e
!           [VCC-Infra02-HBA0]
member pwnn 20:00:00:25:b5:aa:17:3f
!           [VCC-Infra02-HBA2]
member pwnn 52:4a:93:71:56:84:09:00
!           [X70R3-CT0-FC0]
member pwnn 52:4a:93:71:56:84:09:10
!           [X70R3-CT1-FC0]
```

```
zone name FlaskStack-AMD-VMHost70 vsan 100
member pwnn 20:00:00:25:b5:aa:17:40
!           [AMD-VMHost70-HBA0]
member pwnn 20:00:00:25:b5:aa:17:41
!           [AMD-VMHost70-HBA2]
member pwnn 52:4a:93:71:56:84:09:00
!           [X70R3-CT0-FC0]
member pwnn 52:4a:93:71:56:84:09:10
!           [X70R3-CT1-FC0]
```

```
zone name FlaskStack-AMD-VMHost71 vsan 100
```

```
member pwnn 20:00:00:25:b5:aa:17:42
!           [AMD-VMHost71-HBA0]
member pwnn 20:00:00:25:b5:aa:17:43
!           [AMD-VMHost71-HBA2]
member pwnn 52:4a:93:71:56:84:09:00
!           [X70R3-CT0-FC0]
member pwnn 52:4a:93:71:56:84:09:10
!           [X70R3-CT1-FC0]
```

```
zone name FlaskStack-AMD-VMHost72 vsan 100
```

```
member pwnn 20:00:00:25:b5:aa:17:44
!           [AMD-VMHost72-HBA0]
member pwnn 20:00:00:25:b5:aa:17:45
!           [AMD-VMHost72-HBA2]
member pwnn 52:4a:93:71:56:84:09:00
!           [X70R3-CT0-FC0]
member pwnn 52:4a:93:71:56:84:09:10
!           [X70R3-CT1-FC0]
```

```
zone name FlaskStack-AMD-VMHost73 vsan 100
```

```
member pwnn 20:00:00:25:b5:aa:17:4e
!           [AMD-VMHost73-HBA0]
member pwnn 20:00:00:25:b5:aa:17:4f
!           [AMD-VMHost73-HBA2]
member pwnn 52:4a:93:71:56:84:09:00
!           [X70R3-CT0-FC0]
member pwnn 52:4a:93:71:56:84:09:10
!           [X70R3-CT1-FC0]
```

```
zone name FlaskStack-AMD-VMHost74 vsan 100
```

```
member pwnn 20:00:00:25:b5:aa:17:46
!           [AMD-VMHost74-HBA0]
member pwnn 20:00:00:25:b5:aa:17:47
!           [AMD-VMHost74-HBA2]
member pwnn 52:4a:93:71:56:84:09:00
!           [X70R3-CT0-FC0]
```

---

```
member pwnn 52:4a:93:71:56:84:09:10
!           [X70R3-CT1-FC0]
```

```
zone name FlaskStack-AMD-VMHost75 vsan 100
```

```
member pwnn 20:00:00:25:b5:aa:17:48
!           [AMD-VMHost75-HBA0]
member pwnn 20:00:00:25:b5:aa:17:49
!           [AMD-VMHost75-HBA2]
member pwnn 52:4a:93:71:56:84:09:00
!           [X70R3-CT0-FC0]
member pwnn 52:4a:93:71:56:84:09:10
!           [X70R3-CT1-FC0]
```

```
zone name FlaskStack-AMD-VMHost76 vsan 100
```

```
member pwnn 20:00:00:25:b5:aa:17:4a
!           [AMD-VMHost76-HBA0]
member pwnn 20:00:00:25:b5:aa:17:4b
!           [AMD-VMHost76-HBA2]
member pwnn 52:4a:93:71:56:84:09:00
!           [X70R3-CT0-FC0]
member pwnn 52:4a:93:71:56:84:09:10
!           [X70R3-CT1-FC0]
```

```
zone name FlaskStack-AMD-VMHost77 vsan 100
```

```
member pwnn 20:00:00:25:b5:aa:17:4c
!           [AMD-VMHost77-HBA0]
member pwnn 20:00:00:25:b5:aa:17:4d
!           [AMD-VMHost77-HBA2]
member pwnn 52:4a:93:71:56:84:09:00
!           [X70R3-CT0-FC0]
member pwnn 52:4a:93:71:56:84:09:10
!           [X70R3-CT1-FC0]
```

```
zoneset name FlashStack-VCC-CVD vsan 100
```

```
member FlaskStack-VCC-CVD-WLHost01
member FlaskStack-VCC-CVD-WLHost02
```

---

member FlaskStack-VCC-CVD-WLHost03  
member FlaskStack-VCC-CVD-WLHost04  
member FlaskStack-VCC-CVD-WLHost05  
member FlaskStack-VCC-CVD-WLHost06  
member FlaskStack-VCC-CVD-WLHost07  
member FlaskStack-VCC-CVD-WLHost08  
member FlaskStack-VCC-CVD-WLHost09  
member FlaskStack-VCC-CVD-WLHost10  
member FlaskStack-VCC-CVD-WLHost11  
member FlaskStack-VCC-CVD-WLHost12  
member FlaskStack-VCC-CVD-WLHost13  
member FlaskStack-VCC-CVD-WLHost14  
member FlaskStack-VCC-CVD-WLHost15  
member FlaskStack-VCC-CVD-Infra01  
member FlaskStack-VCC-CVD-WLHost16  
member FlaskStack-VCC-CVD-WLHost17  
member FlaskStack-VCC-CVD-WLHost18  
member FlaskStack-VCC-CVD-WLHost19  
member FlaskStack-VCC-CVD-WLHost20  
member FlaskStack-VCC-CVD-WLHost21  
member FlaskStack-VCC-CVD-WLHost22  
member FlaskStack-VCC-CVD-WLHost23  
member FlaskStack-VCC-CVD-WLHost24  
member FlaskStack-VCC-CVD-WLHost25  
member FlaskStack-VCC-CVD-WLHost26  
member FlaskStack-VCC-CVD-WLHost27  
member FlaskStack-VCC-CVD-WLHost28  
member FlaskStack-VCC-CVD-WLHost29  
member FlaskStack-VCC-CVD-WLHost30  
member FlaskStack-VCC-CVD-Infra02  
member FlaskStack-AMD-VMHost70  
member FlaskStack-AMD-VMHost71  
member FlaskStack-AMD-VMHost72  
member FlaskStack-AMD-VMHost73  
member FlaskStack-AMD-VMHost74  
member FlaskStack-AMD-VMHost75

```
member FlaskStack-AMD-VMHost76
member FlaskStack-AMD-VMHost77
```

```
zoneset activate name FlashStack-VCC-CVD vsan 100
do clear zone database vsan 100
```

```
!Full Zone Database Section for vsan 100
```

```
zone name FlaskStack-VCC-CVD-WLHost01 vsan 100
```

```
member pwnn 20:00:00:25:b5:aa:17:00
!           [VCC-WLHost01-HBA0]
member pwnn 20:00:00:25:b5:aa:17:01
!           [VCC-WLHost01-HBA2]
member pwnn 52:4a:93:71:56:84:09:00
!           [X70R3-CT0-FC0]
member pwnn 52:4a:93:71:56:84:09:10
!           [X70R3-CT1-FC0]
```

```
zone name FlaskStack-VCC-CVD-WLHost02 vsan 100
```

```
member pwnn 20:00:00:25:b5:aa:17:02
!           [VCC-WLHost02-HBA0]
member pwnn 20:00:00:25:b5:aa:17:03
!           [VCC-WLHost02-HBA2]
member pwnn 52:4a:93:71:56:84:09:00
!           [X70R3-CT0-FC0]
member pwnn 52:4a:93:71:56:84:09:10
!           [X70R3-CT1-FC0]
```

```
zone name FlaskStack-VCC-CVD-WLHost03 vsan 100
```

```
member pwnn 20:00:00:25:b5:aa:17:04
!           [VCC-WLHost03-HBA0]
member pwnn 20:00:00:25:b5:aa:17:05
!           [VCC-WLHost03-HBA2]
member pwnn 52:4a:93:71:56:84:09:00
!           [X70R3-CT0-FC0]
member pwnn 52:4a:93:71:56:84:09:10
!           [X70R3-CT1-FC0]
```

---

zone name FlaskStack-VCC-CVD-WLHost04 vsan 100

member pwnn 20:00:00:25:b5:aa:17:06

! [VCC-WLHost04-HBA0]

member pwnn 20:00:00:25:b5:aa:17:07

! [VCC-WLHost04-HBA2]

member pwnn 52:4a:93:71:56:84:09:00

! [X70R3-CT0-FC0]

member pwnn 52:4a:93:71:56:84:09:10

! [X70R3-CT1-FC0]

zone name FlaskStack-VCC-CVD-WLHost05 vsan 100

member pwnn 20:00:00:25:b5:aa:17:08

! [VCC-WLHost05-HBA0]

member pwnn 20:00:00:25:b5:aa:17:09

! [VCC-WLHost05-HBA2]

member pwnn 52:4a:93:71:56:84:09:00

! [X70R3-CT0-FC0]

member pwnn 52:4a:93:71:56:84:09:10

! [X70R3-CT1-FC0]

zone name FlaskStack-VCC-CVD-WLHost06 vsan 100

member pwnn 20:00:00:25:b5:aa:17:0a

! [VCC-WLHost06-HBA0]

member pwnn 20:00:00:25:b5:aa:17:0b

! [VCC-WLHost06-HBA2]

member pwnn 52:4a:93:71:56:84:09:00

! [X70R3-CT0-FC0]

member pwnn 52:4a:93:71:56:84:09:10

! [X70R3-CT1-FC0]

zone name FlaskStack-VCC-CVD-WLHost07 vsan 100

member pwnn 20:00:00:25:b5:aa:17:0c

! [VCC-WLHost07-HBA0]

member pwnn 20:00:00:25:b5:aa:17:0d

! [VCC-WLHost07-HBA2]

member pwnn 52:4a:93:71:56:84:09:00

---

```
!           [X70R3-CT0-FC0]
member pwnn 52:4a:93:71:56:84:09:10
!           [X70R3-CT1-FC0]
```

```
zone name FlaskStack-VCC-CVD-WLHost08 vsan 100
  member pwnn 20:00:00:25:b5:aa:17:0e
  !           [VCC-WLHost08-HBA0]
  member pwnn 20:00:00:25:b5:aa:17:0f
  !           [VCC-WLHost08-HBA2]
  member pwnn 52:4a:93:71:56:84:09:00
  !           [X70R3-CT0-FC0]
  member pwnn 52:4a:93:71:56:84:09:10
  !           [X70R3-CT1-FC0]
```

```
zone name FlaskStack-VCC-CVD-WLHost09 vsan 100
  member pwnn 20:00:00:25:b5:aa:17:10
  !           [VCC-WLHost09-HBA0]
  member pwnn 20:00:00:25:b5:aa:17:11
  !           [VCC-WLHost09-HBA2]
  member pwnn 52:4a:93:71:56:84:09:00
  !           [X70R3-CT0-FC0]
  member pwnn 52:4a:93:71:56:84:09:10
  !           [X70R3-CT1-FC0]
```

```
zone name FlaskStack-VCC-CVD-WLHost10 vsan 100
  member pwnn 20:00:00:25:b5:aa:17:12
  !           [VCC-WLHost10-HBA0]
  member pwnn 20:00:00:25:b5:aa:17:13
  !           [VCC-WLHost10-HBA2]
  member pwnn 52:4a:93:71:56:84:09:00
  !           [X70R3-CT0-FC0]
  member pwnn 52:4a:93:71:56:84:09:10
  !           [X70R3-CT1-FC0]
```

```
zone name FlaskStack-VCC-CVD-WLHost11 vsan 100
  member pwnn 20:00:00:25:b5:aa:17:14
```



---

```
!           [VCC-WLHost11-HBA0]
member pwnn 20:00:00:25:b5:aa:17:15
!           [VCC-WLHost11-HBA2]
member pwnn 52:4a:93:71:56:84:09:00
!           [X70R3-CT0-FC0]
member pwnn 52:4a:93:71:56:84:09:10
!           [X70R3-CT1-FC0]
```

```
zone name FlaskStack-VCC-CVD-WLHost12 vsan 100
member pwnn 20:00:00:25:b5:aa:17:16
!           [VCC-WLHost12-HBA0]
member pwnn 20:00:00:25:b5:aa:17:17
!           [VCC-WLHost12-HBA2]
member pwnn 52:4a:93:71:56:84:09:00
!           [X70R3-CT0-FC0]
member pwnn 52:4a:93:71:56:84:09:10
!           [X70R3-CT1-FC0]
```

```
zone name FlaskStack-VCC-CVD-WLHost13 vsan 100
member pwnn 20:00:00:25:b5:aa:17:18
!           [VCC-WLHost13-HBA0]
member pwnn 20:00:00:25:b5:aa:17:19
!           [VCC-WLHost13-HBA2]
member pwnn 52:4a:93:71:56:84:09:00
!           [X70R3-CT0-FC0]
member pwnn 52:4a:93:71:56:84:09:10
!           [X70R3-CT1-FC0]
```

```
zone name FlaskStack-VCC-CVD-WLHost14 vsan 100
member pwnn 20:00:00:25:b5:aa:17:1a
!           [VCC-WLHost14-HBA0]
member pwnn 20:00:00:25:b5:aa:17:1b
!           [VCC-WLHost14-HBA2]
member pwnn 52:4a:93:71:56:84:09:00
!           [X70R3-CT0-FC0]
member pwnn 52:4a:93:71:56:84:09:10
```

---

! [X70R3-CT1-FC0]

zone name FlaskStack-VCC-CVD-WLHost15 vsan 100

member pwnn 20:00:00:25:b5:aa:17:1c

! [VCC-WLHost15-HBA0]

member pwnn 20:00:00:25:b5:aa:17:1d

! [VCC-WLHost15-HBA2]

member pwnn 52:4a:93:71:56:84:09:00

! [X70R3-CT0-FC0]

member pwnn 52:4a:93:71:56:84:09:10

! [X70R3-CT1-FC0]

zone name FlaskStack-VCC-CVD-Infra01 vsan 100

member pwnn 20:00:00:25:b5:aa:17:1e

! [VCC-Infra01-HBA0]

member pwnn 20:00:00:25:b5:aa:17:1f

! [VCC-Infra01-HBA2]

member pwnn 52:4a:93:71:56:84:09:00

! [X70R3-CT0-FC0]

member pwnn 52:4a:93:71:56:84:09:10

! [X70R3-CT1-FC0]

zone name FlaskStack-VCC-CVD-WLHost16 vsan 100

member pwnn 20:00:00:25:b5:aa:17:20

! [VCC-WLHost16-HBA0]

member pwnn 20:00:00:25:b5:aa:17:21

! [VCC-WLHost16-HBA2]

member pwnn 52:4a:93:71:56:84:09:00

! [X70R3-CT0-FC0]

member pwnn 52:4a:93:71:56:84:09:10

! [X70R3-CT1-FC0]

zone name FlaskStack-VCC-CVD-WLHost17 vsan 100

member pwnn 20:00:00:25:b5:aa:17:22

! [VCC-WLHost17-HBA0]

member pwnn 20:00:00:25:b5:aa:17:23

---

```
!           [VCC-WLHost17-HBA2]
member pwnn 52:4a:93:71:56:84:09:00
!           [X70R3-CT0-FC0]
member pwnn 52:4a:93:71:56:84:09:10
!           [X70R3-CT1-FC0]
```

```
zone name FlaskStack-VCC-CVD-WLHost18 vsan 100
member pwnn 20:00:00:25:b5:aa:17:24
!           [VCC-WLHost18-HBA0]
member pwnn 20:00:00:25:b5:aa:17:25
!           [VCC-WLHost18-HBA2]
member pwnn 52:4a:93:71:56:84:09:00
!           [X70R3-CT0-FC0]
member pwnn 52:4a:93:71:56:84:09:10
!           [X70R3-CT1-FC0]
```

```
zone name FlaskStack-VCC-CVD-WLHost19 vsan 100
member pwnn 20:00:00:25:b5:aa:17:26
!           [VCC-WLHost19-HBA0]
member pwnn 20:00:00:25:b5:aa:17:27
!           [VCC-WLHost19-HBA2]
member pwnn 52:4a:93:71:56:84:09:00
!           [X70R3-CT0-FC0]
member pwnn 52:4a:93:71:56:84:09:10
!           [X70R3-CT1-FC0]
```

```
zone name FlaskStack-VCC-CVD-WLHost20 vsan 100
member pwnn 20:00:00:25:b5:aa:17:28
!           [VCC-WLHost20-HBA0]
member pwnn 20:00:00:25:b5:aa:17:29
!           [VCC-WLHost20-HBA2]
member pwnn 52:4a:93:71:56:84:09:00
!           [X70R3-CT0-FC0]
member pwnn 52:4a:93:71:56:84:09:10
!           [X70R3-CT1-FC0]
```

---

zone name FlaskStack-VCC-CVD-WLHost21 vsan 100

member pwnn 20:00:00:25:b5:aa:17:2a

! [VCC-WLHost21-HBA0]

member pwnn 20:00:00:25:b5:aa:17:2b

! [VCC-WLHost21-HBA2]

member pwnn 52:4a:93:71:56:84:09:00

! [X70R3-CT0-FC0]

member pwnn 52:4a:93:71:56:84:09:10

! [X70R3-CT1-FC0]

zone name FlaskStack-VCC-CVD-WLHost22 vsan 100

member pwnn 20:00:00:25:b5:aa:17:2c

! [VCC-WLHost22-HBA0]

member pwnn 20:00:00:25:b5:aa:17:2d

! [VCC-WLHost22-HBA2]

member pwnn 52:4a:93:71:56:84:09:00

! [X70R3-CT0-FC0]

member pwnn 52:4a:93:71:56:84:09:10

! [X70R3-CT1-FC0]

zone name FlaskStack-VCC-CVD-WLHost23 vsan 100

member pwnn 20:00:00:25:b5:aa:17:2e

! [VCC-WLHost23-HBA0]

member pwnn 20:00:00:25:b5:aa:17:2f

! [VCC-WLHost23-HBA2]

member pwnn 52:4a:93:71:56:84:09:00

! [X70R3-CT0-FC0]

member pwnn 52:4a:93:71:56:84:09:10

! [X70R3-CT1-FC0]

zone name FlaskStack-VCC-CVD-WLHost24 vsan 100

member pwnn 20:00:00:25:b5:aa:17:30

! [VCC-WLHost24-HBA0]

member pwnn 20:00:00:25:b5:aa:17:31

! [VCC-WLHost24-HBA2]

member pwnn 52:4a:93:71:56:84:09:00

---

```
!           [X70R3-CT0-FC0]
member pwnn 52:4a:93:71:56:84:09:10
!           [X70R3-CT1-FC0]
```

```
zone name FlaskStack-VCC-CVD-WLHost25 vsan 100
member pwnn 20:00:00:25:b5:aa:17:32
!           [VCC-WLHost25-HBA0]
member pwnn 20:00:00:25:b5:aa:17:33
!           [VCC-WLHost25-HBA2]
member pwnn 52:4a:93:71:56:84:09:00
!           [X70R3-CT0-FC0]
member pwnn 52:4a:93:71:56:84:09:10
!           [X70R3-CT1-FC0]
```

```
zone name FlaskStack-VCC-CVD-WLHost26 vsan 100
member pwnn 20:00:00:25:b5:aa:17:34
!           [VCC-WLHost26-HBA0]
member pwnn 20:00:00:25:b5:aa:17:35
!           [VCC-WLHost26-HBA2]
member pwnn 52:4a:93:71:56:84:09:00
!           [X70R3-CT0-FC0]
member pwnn 52:4a:93:71:56:84:09:10
!           [X70R3-CT1-FC0]
```

```
zone name FlaskStack-VCC-CVD-WLHost27 vsan 100
member pwnn 20:00:00:25:b5:aa:17:36
!           [VCC-WLHost27-HBA0]
member pwnn 20:00:00:25:b5:aa:17:37
!           [VCC-WLHost27-HBA2]
member pwnn 52:4a:93:71:56:84:09:00
!           [X70R3-CT0-FC0]
member pwnn 52:4a:93:71:56:84:09:10
!           [X70R3-CT1-FC0]
```

```
zone name FlaskStack-VCC-CVD-WLHost28 vsan 100
member pwnn 20:00:00:25:b5:aa:17:38
```

---

```
!           [VCC-WLHost28-HBA0]
member pwnn 20:00:00:25:b5:aa:17:39
!           [VCC-WLHost28-HBA2]
member pwnn 52:4a:93:71:56:84:09:00
!           [X70R3-CT0-FC0]
member pwnn 52:4a:93:71:56:84:09:10
!           [X70R3-CT1-FC0]
```

```
zone name FlaskStack-VCC-CVD-WLHost29 vsan 100
member pwnn 20:00:00:25:b5:aa:17:3a
!           [VCC-WLHost29-HBA0]
member pwnn 20:00:00:25:b5:aa:17:3b
!           [VCC-WLHost29-HBA2]
member pwnn 52:4a:93:71:56:84:09:00
!           [X70R3-CT0-FC0]
member pwnn 52:4a:93:71:56:84:09:10
!           [X70R3-CT1-FC0]
```

```
zone name FlaskStack-VCC-CVD-WLHost30 vsan 100
member pwnn 20:00:00:25:b5:aa:17:3c
!           [VCC-WLHost30-HBA0]
member pwnn 20:00:00:25:b5:aa:17:3d
!           [VCC-WLHost30-HBA2]
member pwnn 52:4a:93:71:56:84:09:00
!           [X70R3-CT0-FC0]
member pwnn 52:4a:93:71:56:84:09:10
!           [X70R3-CT1-FC0]
```

```
zone name FlaskStack-VCC-CVD-Infra02 vsan 100
member pwnn 20:00:00:25:b5:aa:17:3e
!           [VCC-Infra02-HBA0]
member pwnn 20:00:00:25:b5:aa:17:3f
!           [VCC-Infra02-HBA2]
member pwnn 52:4a:93:71:56:84:09:00
!           [X70R3-CT0-FC0]
member pwnn 52:4a:93:71:56:84:09:10
```

---

! [X70R3-CT1-FC0]

zone name FlaskStack-AMD-VMHost70 vsan 100

member pwnn 20:00:00:25:b5:aa:17:40

! [AMD-VMHost70-HBA0]

member pwnn 20:00:00:25:b5:aa:17:41

! [AMD-VMHost70-HBA2]

member pwnn 52:4a:93:71:56:84:09:00

! [X70R3-CT0-FC0]

member pwnn 52:4a:93:71:56:84:09:10

! [X70R3-CT1-FC0]

zone name FlaskStack-AMD-VMHost71 vsan 100

member pwnn 20:00:00:25:b5:aa:17:42

! [AMD-VMHost71-HBA0]

member pwnn 20:00:00:25:b5:aa:17:43

! [AMD-VMHost71-HBA2]

member pwnn 52:4a:93:71:56:84:09:00

! [X70R3-CT0-FC0]

member pwnn 52:4a:93:71:56:84:09:10

! [X70R3-CT1-FC0]

zone name FlaskStack-AMD-VMHost72 vsan 100

member pwnn 20:00:00:25:b5:aa:17:44

! [AMD-VMHost72-HBA0]

member pwnn 20:00:00:25:b5:aa:17:45

! [AMD-VMHost72-HBA2]

member pwnn 52:4a:93:71:56:84:09:00

! [X70R3-CT0-FC0]

member pwnn 52:4a:93:71:56:84:09:10

! [X70R3-CT1-FC0]

zone name FlaskStack-AMD-VMHost73 vsan 100

member pwnn 20:00:00:25:b5:aa:17:4e

! [AMD-VMHost73-HBA0]

member pwnn 20:00:00:25:b5:aa:17:4f

---

```
!           [AMD-VMHost73-HBA2]
member pwnn 52:4a:93:71:56:84:09:00
!           [X70R3-CT0-FC0]
member pwnn 52:4a:93:71:56:84:09:10
!           [X70R3-CT1-FC0]
```

```
zone name FlaskStack-AMD-VMHost74 vsan 100
member pwnn 20:00:00:25:b5:aa:17:46
!           [AMD-VMHost74-HBA0]
member pwnn 20:00:00:25:b5:aa:17:47
!           [AMD-VMHost74-HBA2]
member pwnn 52:4a:93:71:56:84:09:00
!           [X70R3-CT0-FC0]
member pwnn 52:4a:93:71:56:84:09:10
!           [X70R3-CT1-FC0]
```

```
zone name FlaskStack-AMD-VMHost75 vsan 100
member pwnn 20:00:00:25:b5:aa:17:48
!           [AMD-VMHost75-HBA0]
member pwnn 20:00:00:25:b5:aa:17:49
!           [AMD-VMHost75-HBA2]
member pwnn 52:4a:93:71:56:84:09:00
!           [X70R3-CT0-FC0]
member pwnn 52:4a:93:71:56:84:09:10
!           [X70R3-CT1-FC0]
```

```
zone name FlaskStack-AMD-VMHost76 vsan 100
member pwnn 20:00:00:25:b5:aa:17:4a
!           [AMD-VMHost76-HBA0]
member pwnn 20:00:00:25:b5:aa:17:4b
!           [AMD-VMHost76-HBA2]
member pwnn 52:4a:93:71:56:84:09:00
!           [X70R3-CT0-FC0]
member pwnn 52:4a:93:71:56:84:09:10
!           [X70R3-CT1-FC0]
```



```
zone name FlaskStack-AMD-VMHost77 vsan 100
  member pwwn 20:00:00:25:b5:aa:17:4c
  !           [AMD-VMHost77-HBA0]
  member pwwn 20:00:00:25:b5:aa:17:4d
  !           [AMD-VMHost77-HBA2]
  member pwwn 52:4a:93:71:56:84:09:00
  !           [X70R3-CT0-FC0]
  member pwwn 52:4a:93:71:56:84:09:10
  !           [X70R3-CT1-FC0]
```

```
zoneset name FlashStack-VCC-CVD vsan 100
  member FlaskStack-VCC-CVD-WLHost01
  member FlaskStack-VCC-CVD-WLHost02
  member FlaskStack-VCC-CVD-WLHost03
  member FlaskStack-VCC-CVD-WLHost04
  member FlaskStack-VCC-CVD-WLHost05
  member FlaskStack-VCC-CVD-WLHost06
  member FlaskStack-VCC-CVD-WLHost07
  member FlaskStack-VCC-CVD-WLHost08
  member FlaskStack-VCC-CVD-WLHost09
  member FlaskStack-VCC-CVD-WLHost10
  member FlaskStack-VCC-CVD-WLHost11
  member FlaskStack-VCC-CVD-WLHost12
  member FlaskStack-VCC-CVD-WLHost13
  member FlaskStack-VCC-CVD-WLHost14
  member FlaskStack-VCC-CVD-WLHost15
  member FlaskStack-VCC-CVD-Infra01
  member FlaskStack-VCC-CVD-WLHost16
  member FlaskStack-VCC-CVD-WLHost17
  member FlaskStack-VCC-CVD-WLHost18
  member FlaskStack-VCC-CVD-WLHost19
  member FlaskStack-VCC-CVD-WLHost20
  member FlaskStack-VCC-CVD-WLHost21
  member FlaskStack-VCC-CVD-WLHost22
  member FlaskStack-VCC-CVD-WLHost23
  member FlaskStack-VCC-CVD-WLHost24
```

```
member FlaskStack-VCC-CVD-WLHost25
member FlaskStack-VCC-CVD-WLHost26
member FlaskStack-VCC-CVD-WLHost27
member FlaskStack-VCC-CVD-WLHost28
member FlaskStack-VCC-CVD-WLHost29
member FlaskStack-VCC-CVD-WLHost30
member FlaskStack-VCC-CVD-Infra02
member FlaskStack-AMD-VMHost70
member FlaskStack-AMD-VMHost71
member FlaskStack-AMD-VMHost72
member FlaskStack-AMD-VMHost73
member FlaskStack-AMD-VMHost74
member FlaskStack-AMD-VMHost75
member FlaskStack-AMD-VMHost76
member FlaskStack-AMD-VMHost77
```

```
interface mgmt0
```

```
ip address 10.29.164.238 255.255.255.0
```

```
vsan database
```

```
vsan 400 interface fc1/1
```

```
vsan 400 interface fc1/2
```

```
vsan 400 interface fc1/3
```

```
vsan 400 interface fc1/4
```

```
vsan 400 interface fc1/5
```

```
vsan 400 interface fc1/6
```

```
vsan 400 interface fc1/7
```

```
vsan 400 interface fc1/8
```

```
vsan 100 interface fc1/9
```

```
vsan 100 interface fc1/10
```

```
vsan 100 interface fc1/11
```

```
vsan 100 interface fc1/12
```

```
vsan 100 interface fc1/13
```

```
vsan 100 interface fc1/14
```

```
vsan 100 interface fc1/15
```

```
vsan 100 interface fc1/16
```

```
clock timezone PST 0 0
```

```
clock summer-time PDT 2 Sun Mar 02:00 1 Sun Nov 02:00 60
switchname ADD16-MDS-A
cli alias name autozone source sys/autozone.py
line console
line vty
boot kickstart bootflash:/m9100-s6ek9-kickstart-mz.8.3.1.bin
boot system bootflash:/m9100-s6ek9-mz.8.3.1.bin
interface fc1/4
    switchport speed auto
interface fc1/1
interface fc1/2
interface fc1/3
interface fc1/5
interface fc1/6
interface fc1/7
interface fc1/8
interface fc1/9
interface fc1/10
interface fc1/11
interface fc1/12
interface fc1/13
interface fc1/14
interface fc1/15
interface fc1/16
interface fc1/4

interface fc1/1
    port-license acquire
    no shutdown

interface fc1/2
    port-license acquire
    no shutdown

interface fc1/3
    port-license acquire
```

---

```
no shutdown

interface fc1/4
  port-license acquire
  no shutdown

interface fc1/5
  no port-license

interface fc1/6
  no port-license

interface fc1/7
  no port-license

interface fc1/8
  no port-license

interface fc1/9
  switchport trunk allowed vsan 100
  switchport trunk mode off
  port-license acquire
  no shutdown

interface fc1/10
  switchport trunk allowed vsan 100
  switchport trunk mode off
  port-license acquire
  no shutdown

interface fc1/11
  switchport trunk allowed vsan 100
  switchport trunk mode off
  port-license acquire
  no shutdown
```

---

```
interface fc1/12
  switchport trunk allowed vsan 100
  switchport trunk mode off
  port-license acquire
  no shutdown
```

```
interface fc1/13
  switchport trunk allowed vsan 100
  switchport trunk mode off
  port-license acquire
  no shutdown
```

```
interface fc1/14
  switchport trunk allowed vsan 100
  switchport trunk mode off
  port-license acquire
  no shutdown
```

```
interface fc1/15
  switchport trunk allowed vsan 100
  switchport trunk mode off
  port-license acquire
  no shutdown
```

```
interface fc1/16
  switchport trunk allowed vsan 100
  switchport trunk mode off
  port-license acquire
  no shutdown
ip default-gateway 10.29.164.1
```

### **Cisco MDS 9132T-B Configuration**

```
version 8.3(1)
power redundancy-mode redundant
feature npiv
feature fport-channel-trunk
role name default-role
```

```
description This is a system defined role and applies to all users.
rule 5 permit show feature environment
rule 4 permit show feature hardware
rule 3 permit show feature module
rule 2 permit show feature snmp
rule 1 permit show feature system
no password strength-check
username admin password 5 $5$1qs42bIH$hp2kMO3FA/4Zzg6EekVHWpA81A7Mc/kBsFZVU8q1uU7 role
network-admin
ip domain-lookup
ip host ADD16-MDS-B 10.29.164.239
aaa group server radius radius
snmp-server user admin network-admin auth md5 0x6fa97f514b0cdf3638e31dfd0bd19c71 priv
0x6fa97f514b0cdf3638e31dfd0bd19c71 localizedkey
snmp-server host 10.155.160.97 traps version 2c public udp-port 1164
snmp-server host 10.24.66.169 traps version 2c public udp-port 1164
snmp-server host 10.24.72.119 traps version 2c public udp-port 1166
snmp-server host 10.29.164.250 traps version 2c public udp-port 1163
rmon event 1 log trap public description FATAL(1) owner PMON@FATAL
rmon event 2 log trap public description CRITICAL(2) owner PMON@CRITICAL
rmon event 3 log trap public description ERROR(3) owner PMON@ERROR
rmon event 4 log trap public description WARNING(4) owner PMON@WARNING
rmon event 5 log trap public description INFORMATION(5) owner PMON@INFO
ntp server 10.81.254.131
ntp server 10.81.254.202
vsan database
  vsan 101 name "FlashStack-VCC-CVD-Fabric-B"
device-alias database
  device-alias name X70R3-CT0-FC2 pwnn 52:4a:93:71:56:84:09:02
  device-alias name X70R3-CT1-FC2 pwnn 52:4a:93:71:56:84:09:12
  device-alias name VCC-Infra01-HBA1 pwnn 20:00:00:25:b5:bb:17:1e
  device-alias name VCC-Infra01-HBA3 pwnn 20:00:00:25:b5:bb:17:1f
  device-alias name VCC-Infra02-HBA1 pwnn 20:00:00:25:b5:bb:17:3e
  device-alias name VCC-Infra02-HBA3 pwnn 20:00:00:25:b5:bb:17:3f
  device-alias name VCC-WLHost01-HBA1 pwnn 20:00:00:25:b5:bb:17:00
  device-alias name VCC-WLHost01-HBA3 pwnn 20:00:00:25:b5:bb:17:01
  device-alias name VCC-WLHost02-HBA1 pwnn 20:00:00:25:b5:bb:17:02
```

```
device-alias name VCC-WLHost02-HBA3 pwn 20:00:00:25:b5:bb:17:03
device-alias name VCC-WLHost03-HBA1 pwn 20:00:00:25:b5:bb:17:04
device-alias name VCC-WLHost03-HBA3 pwn 20:00:00:25:b5:bb:17:05
device-alias name VCC-WLHost04-HBA1 pwn 20:00:00:25:b5:bb:17:06
device-alias name VCC-WLHost04-HBA3 pwn 20:00:00:25:b5:bb:17:07
device-alias name VCC-WLHost05-HBA1 pwn 20:00:00:25:b5:bb:17:08
device-alias name VCC-WLHost05-HBA3 pwn 20:00:00:25:b5:bb:17:09
device-alias name VCC-WLHost06-HBA1 pwn 20:00:00:25:b5:bb:17:0a
device-alias name VCC-WLHost06-HBA3 pwn 20:00:00:25:b5:bb:17:0b
device-alias name VCC-WLHost07-HBA1 pwn 20:00:00:25:b5:bb:17:0c
device-alias name VCC-WLHost07-HBA3 pwn 20:00:00:25:b5:bb:17:0d
device-alias name VCC-WLHost08-HBA1 pwn 20:00:00:25:b5:bb:17:0e
device-alias name VCC-WLHost08-HBA3 pwn 20:00:00:25:b5:bb:17:0f
device-alias name VCC-WLHost09-HBA1 pwn 20:00:00:25:b5:bb:17:10
device-alias name VCC-WLHost09-HBA3 pwn 20:00:00:25:b5:bb:17:11
device-alias name VCC-WLHost10-HBA1 pwn 20:00:00:25:b5:bb:17:12
device-alias name VCC-WLHost10-HBA3 pwn 20:00:00:25:b5:bb:17:13
device-alias name VCC-WLHost11-HBA1 pwn 20:00:00:25:b5:bb:17:14
device-alias name VCC-WLHost11-HBA3 pwn 20:00:00:25:b5:bb:17:15
device-alias name VCC-WLHost12-HBA1 pwn 20:00:00:25:b5:bb:17:16
device-alias name VCC-WLHost12-HBA3 pwn 20:00:00:25:b5:bb:17:17
device-alias name VCC-WLHost13-HBA1 pwn 20:00:00:25:b5:bb:17:18
device-alias name VCC-WLHost13-HBA3 pwn 20:00:00:25:b5:bb:17:19
device-alias name VCC-WLHost14-HBA1 pwn 20:00:00:25:b5:bb:17:1a
device-alias name VCC-WLHost14-HBA3 pwn 20:00:00:25:b5:bb:17:1b
device-alias name VCC-WLHost15-HBA1 pwn 20:00:00:25:b5:bb:17:1c
device-alias name VCC-WLHost15-HBA3 pwn 20:00:00:25:b5:bb:17:1d
device-alias name VCC-WLHost16-HBA1 pwn 20:00:00:25:b5:bb:17:20
device-alias name VCC-WLHost16-HBA3 pwn 20:00:00:25:b5:bb:17:21
device-alias name VCC-WLHost17-HBA1 pwn 20:00:00:25:b5:bb:17:22
device-alias name VCC-WLHost17-HBA3 pwn 20:00:00:25:b5:bb:17:23
device-alias name VCC-WLHost18-HBA1 pwn 20:00:00:25:b5:bb:17:24
device-alias name VCC-WLHost18-HBA3 pwn 20:00:00:25:b5:bb:17:25
device-alias name VCC-WLHost19-HBA1 pwn 20:00:00:25:b5:bb:17:26
device-alias name VCC-WLHost19-HBA3 pwn 20:00:00:25:b5:bb:17:27
device-alias name VCC-WLHost20-HBA1 pwn 20:00:00:25:b5:bb:17:28
```

```
device-alias name VCC-WLHost20-HBA3 pwwn 20:00:00:25:b5:bb:17:29
device-alias name VCC-WLHost21-HBA1 pwwn 20:00:00:25:b5:bb:17:2a
device-alias name VCC-WLHost21-HBA3 pwwn 20:00:00:25:b5:bb:17:2b
device-alias name VCC-WLHost22-HBA1 pwwn 20:00:00:25:b5:bb:17:2c
device-alias name VCC-WLHost22-HBA3 pwwn 20:00:00:25:b5:bb:17:2d
device-alias name VCC-WLHost23-HBA1 pwwn 20:00:00:25:b5:bb:17:2e
device-alias name VCC-WLHost23-HBA3 pwwn 20:00:00:25:b5:bb:17:2f
device-alias name VCC-WLHost24-HBA1 pwwn 20:00:00:25:b5:bb:17:30
device-alias name VCC-WLHost24-HBA3 pwwn 20:00:00:25:b5:bb:17:31
device-alias name VCC-WLHost25-HBA1 pwwn 20:00:00:25:b5:bb:17:32
device-alias name VCC-WLHost25-HBA3 pwwn 20:00:00:25:b5:bb:17:33
device-alias name VCC-WLHost26-HBA1 pwwn 20:00:00:25:b5:bb:17:34
device-alias name VCC-WLHost26-HBA3 pwwn 20:00:00:25:b5:bb:17:35
device-alias name VCC-WLHost27-HBA1 pwwn 20:00:00:25:b5:bb:17:36
device-alias name VCC-WLHost27-HBA3 pwwn 20:00:00:25:b5:bb:17:37
device-alias name VCC-WLHost28-HBA1 pwwn 20:00:00:25:b5:bb:17:38
device-alias name VCC-WLHost28-HBA3 pwwn 20:00:00:25:b5:bb:17:39
device-alias name VCC-WLHost29-HBA1 pwwn 20:00:00:25:b5:bb:17:3a
device-alias name VCC-WLHost29-HBA3 pwwn 20:00:00:25:b5:bb:17:3b
device-alias name VCC-WLHost30-HBA1 pwwn 20:00:00:25:b5:bb:17:3c
device-alias name VCC-WLHost30-HBA3 pwwn 20:00:00:25:b5:bb:17:3d
```

```
device-alias commit
```

```
fcdomain fcid database
```

```
vsan 101 wwn 20:03:00:de:fb:90:a4:40 fcid 0xc40000 dynamic
vsan 101 wwn 52:4a:93:75:dd:91:0a:17 fcid 0xc40020 dynamic
! [X70-CT1-FC9]
vsan 101 wwn 52:4a:93:75:dd:91:0a:07 fcid 0xc40040 dynamic
! [X70-CT0-FC9]
vsan 101 wwn 52:4a:93:75:dd:91:0a:16 fcid 0xc40021 dynamic
vsan 101 wwn 52:4a:93:75:dd:91:0a:13 fcid 0xc40041 dynamic
! [X70-CT1-FC3]
vsan 101 wwn 20:00:00:25:b5:bb:17:3e fcid 0xc40060 dynamic
! [VCC-Infra02-HBA1]
vsan 101 wwn 20:00:00:25:b5:bb:17:07 fcid 0xc40061 dynamic
```



```
!           [VCC-WLHost04-HBA3]
vsan 101 wwn 20:00:00:25:b5:bb:17:3c fcid 0xc40062 dynamic
!           [VCC-WLHost30-HBA1]
vsan 101 wwn 20:00:00:25:b5:bb:17:11 fcid 0xc40063 dynamic
!           [VCC-WLHost09-HBA3]
vsan 101 wwn 20:00:00:25:b5:bb:17:01 fcid 0xc40064 dynamic
!           [VCC-WLHost01-HBA3]
vsan 101 wwn 20:00:00:25:b5:bb:17:00 fcid 0xc40065 dynamic
!           [VCC-WLHost01-HBA1]
vsan 101 wwn 20:00:00:25:b5:bb:17:13 fcid 0xc40066 dynamic
!           [VCC-WLHost10-HBA3]
vsan 101 wwn 20:00:00:25:b5:bb:17:04 fcid 0xc40067 dynamic
!           [VCC-WLHost03-HBA1]
vsan 101 wwn 20:00:00:25:b5:bb:17:17 fcid 0xc40068 dynamic
!           [VCC-WLHost12-HBA3]
vsan 101 wwn 20:00:00:25:b5:bb:17:16 fcid 0xc40069 dynamic
!           [VCC-WLHost12-HBA1]
vsan 101 wwn 20:00:00:25:b5:bb:17:30 fcid 0xc4006a dynamic
!           [VCC-WLHost24-HBA1]
vsan 101 wwn 20:00:00:25:b5:bb:17:21 fcid 0xc4006b dynamic
!           [VCC-WLHost16-HBA3]
vsan 101 wwn 20:00:00:25:b5:bb:17:1f fcid 0xc4006c dynamic
!           [VCC-Infra01-HBA3]
vsan 101 wwn 20:00:00:25:b5:bb:17:1a fcid 0xc4006d dynamic
!           [VCC-WLHost14-HBA1]
vsan 101 wwn 20:00:00:25:b5:bb:17:3f fcid 0xc4006e dynamic
!           [VCC-Infra02-HBA3]
vsan 101 wwn 20:00:00:25:b5:bb:17:0a fcid 0xc4006f dynamic
!           [VCC-WLHost06-HBA1]
vsan 101 wwn 20:00:00:25:b5:bb:17:38 fcid 0xc40070 dynamic
!           [VCC-WLHost28-HBA1]
vsan 101 wwn 20:00:00:25:b5:bb:17:19 fcid 0xc40071 dynamic
!           [VCC-WLHost13-HBA3]
vsan 101 wwn 20:00:00:25:b5:bb:17:22 fcid 0xc40072 dynamic
!           [VCC-WLHost17-HBA1]
vsan 101 wwn 20:00:00:25:b5:bb:17:2f fcid 0xc40073 dynamic
```

```
!           [VCC-WLHost23-HBA3]
vsan 101 wwn 20:00:00:25:b5:bb:17:1b fcid 0xc40074 dynamic
!           [VCC-WLHost14-HBA3]
vsan 101 wwn 20:00:00:25:b5:bb:17:3b fcid 0xc40075 dynamic
!           [VCC-WLHost29-HBA3]
vsan 101 wwn 20:00:00:25:b5:bb:17:2a fcid 0xc40076 dynamic
!           [VCC-WLHost21-HBA1]
vsan 101 wwn 20:00:00:25:b5:bb:17:29 fcid 0xc40077 dynamic
!           [VCC-WLHost20-HBA3]
vsan 101 wwn 20:00:00:25:b5:bb:17:1c fcid 0xc40078 dynamic
!           [VCC-WLHost15-HBA1]
vsan 101 wwn 20:00:00:25:b5:bb:17:0b fcid 0xc40079 dynamic
!           [VCC-WLHost06-HBA3]
vsan 101 wwn 20:00:00:25:b5:bb:17:0d fcid 0xc4007a dynamic
!           [VCC-WLHost07-HBA3]
vsan 101 wwn 20:00:00:25:b5:bb:17:37 fcid 0xc4007b dynamic
!           [VCC-WLHost27-HBA3]
vsan 101 wwn 20:00:00:25:b5:bb:17:31 fcid 0xc4007c dynamic
!           [VCC-WLHost24-HBA3]
vsan 101 wwn 20:00:00:25:b5:bb:17:08 fcid 0xc4007d dynamic
!           [VCC-WLHost05-HBA1]
vsan 101 wwn 20:00:00:25:b5:bb:17:10 fcid 0xc4007e dynamic
!           [VCC-WLHost09-HBA1]
vsan 101 wwn 20:00:00:25:b5:bb:17:34 fcid 0xc4007f dynamic
!           [VCC-WLHost26-HBA1]
vsan 101 wwn 20:00:00:25:b5:bb:17:25 fcid 0xc40080 dynamic
!           [VCC-WLHost18-HBA3]
vsan 101 wwn 20:00:00:25:b5:bb:17:3d fcid 0xc40081 dynamic
!           [VCC-WLHost30-HBA3]
vsan 101 wwn 20:00:00:25:b5:bb:17:15 fcid 0xc40082 dynamic
!           [VCC-WLHost11-HBA3]
vsan 101 wwn 20:00:00:25:b5:bb:17:23 fcid 0xc40083 dynamic
!           [VCC-WLHost17-HBA3]
vsan 101 wwn 20:00:00:25:b5:bb:17:3a fcid 0xc40084 dynamic
!           [VCC-WLHost29-HBA1]
vsan 101 wwn 20:00:00:25:b5:bb:17:28 fcid 0xc40085 dynamic
```

```
!           [VCC-WLHost20-HBA1]
vsan 101 wwn 20:00:00:25:b5:bb:17:32 fcid 0xc40086 dynamic
!           [VCC-WLHost25-HBA1]
vsan 101 wwn 20:00:00:25:b5:bb:17:0f fcid 0xc40087 dynamic
!           [VCC-WLHost08-HBA3]
vsan 101 wwn 20:00:00:25:b5:bb:17:0c fcid 0xc40088 dynamic
!           [VCC-WLHost07-HBA1]
vsan 101 wwn 20:00:00:25:b5:bb:17:2e fcid 0xc40089 dynamic
!           [VCC-WLHost23-HBA1]
vsan 101 wwn 20:00:00:25:b5:bb:17:03 fcid 0xc4008a dynamic
!           [VCC-WLHost02-HBA3]
vsan 101 wwn 20:00:00:25:b5:bb:17:02 fcid 0xc4008b dynamic
!           [VCC-WLHost02-HBA1]
vsan 101 wwn 20:00:00:25:b5:bb:17:2b fcid 0xc4008c dynamic
!           [VCC-WLHost21-HBA3]
vsan 101 wwn 20:00:00:25:b5:bb:17:35 fcid 0xc4008d dynamic
!           [VCC-WLHost26-HBA3]
vsan 101 wwn 20:00:00:25:b5:bb:17:2c fcid 0xc4008e dynamic
!           [VCC-WLHost22-HBA1]
vsan 101 wwn 20:00:00:25:b5:bb:17:27 fcid 0xc4008f dynamic
!           [VCC-WLHost19-HBA3]
vsan 101 wwn 20:00:00:25:b5:bb:17:18 fcid 0xc40090 dynamic
!           [VCC-WLHost13-HBA1]
vsan 101 wwn 20:00:00:25:b5:bb:17:14 fcid 0xc40091 dynamic
!           [VCC-WLHost11-HBA1]
vsan 101 wwn 20:00:00:25:b5:bb:17:0e fcid 0xc40092 dynamic
!           [VCC-WLHost08-HBA1]
vsan 101 wwn 20:00:00:25:b5:bb:17:1e fcid 0xc40093 dynamic
!           [VCC-Infra01-HBA1]
vsan 101 wwn 20:00:00:25:b5:bb:17:06 fcid 0xc40094 dynamic
!           [VCC-WLHost04-HBA1]
vsan 101 wwn 20:00:00:25:b5:bb:17:09 fcid 0xc40095 dynamic
!           [VCC-WLHost05-HBA3]
vsan 101 wwn 20:00:00:25:b5:bb:17:26 fcid 0xc40096 dynamic
!           [VCC-WLHost19-HBA1]
vsan 101 wwn 20:00:00:25:b5:bb:17:24 fcid 0xc40097 dynamic
```

```
!           [VCC-WLHost18-HBA1]
vsan 101 wwn 20:00:00:25:b5:bb:17:20 fcid 0xc40098 dynamic
!           [VCC-WLHost16-HBA1]
vsan 101 wwn 20:00:00:25:b5:bb:17:1d fcid 0xc40099 dynamic
!           [VCC-WLHost15-HBA3]
vsan 101 wwn 20:00:00:25:b5:bb:17:33 fcid 0xc4009a dynamic
!           [VCC-WLHost25-HBA3]
vsan 101 wwn 20:00:00:25:b5:bb:17:36 fcid 0xc4009b dynamic
!           [VCC-WLHost27-HBA1]
vsan 101 wwn 20:00:00:25:b5:bb:17:39 fcid 0xc4009c dynamic
!           [VCC-WLHost28-HBA3]
vsan 101 wwn 20:00:00:25:b5:bb:17:2d fcid 0xc4009d dynamic
!           [VCC-WLHost22-HBA3]
vsan 101 wwn 20:00:00:25:b5:bb:17:12 fcid 0xc4009e dynamic
!           [VCC-WLHost10-HBA1]
vsan 101 wwn 20:00:00:25:b5:bb:17:05 fcid 0xc4009f dynamic
!           [VCC-WLHost03-HBA3]
vsan 101 wwn 20:02:00:de:fb:90:a4:40 fcid 0xc400a0 dynamic
vsan 101 wwn 20:01:00:de:fb:90:a4:40 fcid 0xc400c0 dynamic
vsan 101 wwn 20:04:00:de:fb:90:a4:40 fcid 0xc400e0 dynamic
vsan 101 wwn 52:4a:93:75:dd:91:0a:00 fcid 0xc40022 dynamic
vsan 101 wwn 52:4a:93:75:dd:91:0a:12 fcid 0xc40042 dynamic
vsan 101 wwn 52:4a:93:75:dd:91:0a:11 fcid 0xc40023 dynamic
!           [X70-CT1-FC1]
vsan 101 wwn 20:01:00:3a:9c:a4:fd:20 fcid 0xc400c1 dynamic
vsan 101 wwn 20:02:00:3a:9c:a4:fd:20 fcid 0xc400a1 dynamic
vsan 101 wwn 20:03:00:3a:9c:a4:fd:20 fcid 0xc40100 dynamic
vsan 101 wwn 20:04:00:3a:9c:a4:fd:20 fcid 0xc400e1 dynamic
vsan 101 wwn 52:4a:93:75:dd:91:0a:01 fcid 0xc40043 dynamic
!           [X70-CT0-FC1]
vsan 101 wwn 52:4a:93:71:56:84:09:02 fcid 0xc40044 dynamic
!           [X70R3-CT0-FC2]
vsan 101 wwn 52:4a:93:71:56:84:09:00 fcid 0xc40024 dynamic
vsan 101 wwn 52:4a:93:71:56:84:09:12 fcid 0xc40045 dynamic
!           [X70R3-CT1-FC2]
vsan 101 wwn 20:00:00:25:b5:bb:17:40 fcid 0xc400c2 dynamic
```

```
!           [AMD-VMHost70-HBA1]
vsan 101 wwn 20:00:00:25:b5:bb:17:41 fcid 0xc400a2 dynamic
!           [AMD-VMHost70-HBA3]
vsan 101 wwn 20:00:00:25:b5:bb:17:44 fcid 0xc400c3 dynamic
!           [AMD-VMHost72-HBA1]
vsan 101 wwn 20:00:00:25:b5:bb:17:45 fcid 0xc400a3 dynamic
!           [AMD-VMHost72-HBA3]
vsan 101 wwn 20:00:00:25:b5:bb:17:4e fcid 0xc400c4 dynamic
!           [AMD-VMHost73-HBA1]
vsan 101 wwn 20:00:00:25:b5:bb:17:4f fcid 0xc400a4 dynamic
!           [AMD-VMHost73-HBA3]
vsan 101 wwn 20:00:00:25:b5:bb:17:42 fcid 0xc400c5 dynamic
!           [AMD-VMHost71-HBA1]
vsan 101 wwn 20:00:00:25:b5:bb:17:43 fcid 0xc400a5 dynamic
!           [AMD-VMHost71-HBA3]
vsan 101 wwn 20:00:00:25:b5:bb:17:46 fcid 0xc400c6 dynamic
!           [AMD-VMHost74-HBA1]
vsan 101 wwn 20:00:00:25:b5:bb:17:47 fcid 0xc400a6 dynamic
!           [AMD-VMHost74-HBA3]
vsan 101 wwn 20:00:00:25:b5:bb:17:48 fcid 0xc400c7 dynamic
!           [AMD-VMHost75-HBA1]
vsan 101 wwn 20:00:00:25:b5:bb:17:49 fcid 0xc400a7 dynamic
!           [AMD-VMHost75-HBA3]
vsan 101 wwn 20:00:00:25:b5:bb:17:4a fcid 0xc400c8 dynamic
!           [AMD-VMHost76-HBA1]
vsan 101 wwn 20:00:00:25:b5:bb:17:4b fcid 0xc400a8 dynamic
!           [AMD-VMHost76-HBA3]
vsan 101 wwn 20:00:00:25:b5:bb:17:4c fcid 0xc400c9 dynamic
!           [AMD-VMHost77-HBA1]
vsan 101 wwn 20:00:00:25:b5:bb:17:4d fcid 0xc400a9 dynamic
!           [AMD-VMHost77-HBA3]
```

```
!Active Zone Database Section for vsan 101
zone name FlaskStack-VCC-CVD-WLHost01 vsan 101
  member pwwn 20:00:00:25:b5:bb:17:00
    !           [VCC-WLHost01-HBA1]
```

```
member pwn 20:00:00:25:b5:bb:17:01
!          [VCC-WLHost01-HBA3]
member pwn 52:4a:93:71:56:84:09:02
!          [X70R3-CT0-FC2]
member pwn 52:4a:93:71:56:84:09:12
!          [X70R3-CT1-FC2]
```

```
zone name FlaskStack-VCC-CVD-WLHost02 vsan 101
```

```
member pwn 20:00:00:25:b5:bb:17:02
!          [VCC-WLHost02-HBA1]
member pwn 20:00:00:25:b5:bb:17:03
!          [VCC-WLHost02-HBA3]
member pwn 52:4a:93:71:56:84:09:02
!          [X70R3-CT0-FC2]
member pwn 52:4a:93:71:56:84:09:12
!          [X70R3-CT1-FC2]
```

```
zone name FlaskStack-VCC-CVD-WLHost03 vsan 101
```

```
member pwn 20:00:00:25:b5:bb:17:04
!          [VCC-WLHost03-HBA1]
member pwn 20:00:00:25:b5:bb:17:05
!          [VCC-WLHost03-HBA3]
member pwn 52:4a:93:71:56:84:09:02
!          [X70R3-CT0-FC2]
member pwn 52:4a:93:71:56:84:09:12
!          [X70R3-CT1-FC2]
```

```
zone name FlaskStack-VCC-CVD-WLHost04 vsan 101
```

```
member pwn 20:00:00:25:b5:bb:17:06
!          [VCC-WLHost04-HBA1]
member pwn 20:00:00:25:b5:bb:17:07
!          [VCC-WLHost04-HBA3]
member pwn 52:4a:93:71:56:84:09:02
!          [X70R3-CT0-FC2]
member pwn 52:4a:93:71:56:84:09:12
!          [X70R3-CT1-FC2]
```

---

```
zone name FlaskStack-VCC-CVD-WLHost05 vsan 101
  member pwnn 20:00:00:25:b5:bb:17:08
  !           [VCC-WLHost05-HBA1]
  member pwnn 20:00:00:25:b5:bb:17:09
  !           [VCC-WLHost05-HBA3]
  member pwnn 52:4a:93:71:56:84:09:02
  !           [X70R3-CT0-FC2]
  member pwnn 52:4a:93:71:56:84:09:12
  !           [X70R3-CT1-FC2]
```

```
zone name FlaskStack-VCC-CVD-WLHost06 vsan 101
  member pwnn 20:00:00:25:b5:bb:17:0a
  !           [VCC-WLHost06-HBA1]
  member pwnn 20:00:00:25:b5:bb:17:0b
  !           [VCC-WLHost06-HBA3]
  member pwnn 52:4a:93:71:56:84:09:02
  !           [X70R3-CT0-FC2]
  member pwnn 52:4a:93:71:56:84:09:12
  !           [X70R3-CT1-FC2]
```

```
zone name FlaskStack-VCC-CVD-WLHost07 vsan 101
  member pwnn 20:00:00:25:b5:bb:17:0c
  !           [VCC-WLHost07-HBA1]
  member pwnn 20:00:00:25:b5:bb:17:0d
  !           [VCC-WLHost07-HBA3]
  member pwnn 52:4a:93:71:56:84:09:02
  !           [X70R3-CT0-FC2]
  member pwnn 52:4a:93:71:56:84:09:12
  !           [X70R3-CT1-FC2]
```

```
zone name FlaskStack-VCC-CVD-WLHost08 vsan 101
  member pwnn 20:00:00:25:b5:bb:17:0e
  !           [VCC-WLHost08-HBA1]
  member pwnn 20:00:00:25:b5:bb:17:0f
  !           [VCC-WLHost08-HBA3]
```

---

```
member pwnn 52:4a:93:71:56:84:09:02
!           [X70R3-CT0-FC2]
member pwnn 52:4a:93:71:56:84:09:12
!           [X70R3-CT1-FC2]
```

```
zone name FlaskStack-VCC-CVD-WLHost09 vsan 101
member pwnn 20:00:00:25:b5:bb:17:10
!           [VCC-WLHost09-HBA1]
member pwnn 20:00:00:25:b5:bb:17:11
!           [VCC-WLHost09-HBA3]
member pwnn 52:4a:93:71:56:84:09:02
!           [X70R3-CT0-FC2]
member pwnn 52:4a:93:71:56:84:09:12
!           [X70R3-CT1-FC2]
```

```
zone name FlaskStack-VCC-CVD-WLHost10 vsan 101
member pwnn 20:00:00:25:b5:bb:17:12
!           [VCC-WLHost10-HBA1]
member pwnn 20:00:00:25:b5:bb:17:13
!           [VCC-WLHost10-HBA3]
member pwnn 52:4a:93:71:56:84:09:02
!           [X70R3-CT0-FC2]
member pwnn 52:4a:93:71:56:84:09:12
!           [X70R3-CT1-FC2]
```

```
zone name FlaskStack-VCC-CVD-WLHost11 vsan 101
member pwnn 20:00:00:25:b5:bb:17:14
!           [VCC-WLHost11-HBA1]
member pwnn 20:00:00:25:b5:bb:17:15
!           [VCC-WLHost11-HBA3]
member pwnn 52:4a:93:71:56:84:09:02
!           [X70R3-CT0-FC2]
member pwnn 52:4a:93:71:56:84:09:12
!           [X70R3-CT1-FC2]
```

```
zone name FlaskStack-VCC-CVD-WLHost12 vsan 101
```



```
member pwnn 20:00:00:25:b5:bb:17:16
!           [VCC-WLHost12-HBA1]
member pwnn 20:00:00:25:b5:bb:17:17
!           [VCC-WLHost12-HBA3]
member pwnn 52:4a:93:71:56:84:09:02
!           [X70R3-CT0-FC2]
member pwnn 52:4a:93:71:56:84:09:12
!           [X70R3-CT1-FC2]
```

```
zone name FlaskStack-VCC-CVD-WLHost13 vsan 101
```

```
member pwnn 20:00:00:25:b5:bb:17:18
!           [VCC-WLHost13-HBA1]
member pwnn 20:00:00:25:b5:bb:17:19
!           [VCC-WLHost13-HBA3]
member pwnn 52:4a:93:71:56:84:09:02
!           [X70R3-CT0-FC2]
member pwnn 52:4a:93:71:56:84:09:12
!           [X70R3-CT1-FC2]
```

```
zone name FlaskStack-VCC-CVD-WLHost14 vsan 101
```

```
member pwnn 20:00:00:25:b5:bb:17:1a
!           [VCC-WLHost14-HBA1]
member pwnn 20:00:00:25:b5:bb:17:1b
!           [VCC-WLHost14-HBA3]
member pwnn 52:4a:93:71:56:84:09:02
!           [X70R3-CT0-FC2]
member pwnn 52:4a:93:71:56:84:09:12
!           [X70R3-CT1-FC2]
```

```
zone name FlaskStack-VCC-CVD-WLHost15 vsan 101
```

```
member pwnn 20:00:00:25:b5:bb:17:1c
!           [VCC-WLHost15-HBA1]
member pwnn 20:00:00:25:b5:bb:17:1d
!           [VCC-WLHost15-HBA3]
member pwnn 52:4a:93:71:56:84:09:02
!           [X70R3-CT0-FC2]
```

---

```
member pwnn 52:4a:93:71:56:84:09:12
!           [X70R3-CT1-FC2]
```

```
zone name FlaskStack-VCC-CVD-Infra01 vsan 101
```

```
member pwnn 20:00:00:25:b5:bb:17:1e
!           [VCC-Infra01-HBA1]
member pwnn 20:00:00:25:b5:bb:17:1f
!           [VCC-Infra01-HBA3]
member pwnn 52:4a:93:71:56:84:09:02
!           [X70R3-CT0-FC2]
member pwnn 52:4a:93:71:56:84:09:12
!           [X70R3-CT1-FC2]
```

```
zone name FlaskStack-VCC-CVD-WLHost16 vsan 101
```

```
member pwnn 20:00:00:25:b5:bb:17:20
!           [VCC-WLHost16-HBA1]
member pwnn 20:00:00:25:b5:bb:17:21
!           [VCC-WLHost16-HBA3]
member pwnn 52:4a:93:71:56:84:09:02
!           [X70R3-CT0-FC2]
member pwnn 52:4a:93:71:56:84:09:12
!           [X70R3-CT1-FC2]
```

```
zone name FlaskStack-VCC-CVD-WLHost17 vsan 101
```

```
member pwnn 20:00:00:25:b5:bb:17:22
!           [VCC-WLHost17-HBA1]
member pwnn 20:00:00:25:b5:bb:17:23
!           [VCC-WLHost17-HBA3]
member pwnn 52:4a:93:71:56:84:09:02
!           [X70R3-CT0-FC2]
member pwnn 52:4a:93:71:56:84:09:12
!           [X70R3-CT1-FC2]
```

```
zone name FlaskStack-VCC-CVD-WLHost18 vsan 101
```

```
member pwnn 20:00:00:25:b5:bb:17:24
!           [VCC-WLHost18-HBA1]
```

```
member pwn 20:00:00:25:b5:bb:17:25
!          [VCC-WLHost18-HBA3]
member pwn 52:4a:93:71:56:84:09:02
!          [X70R3-CT0-FC2]
member pwn 52:4a:93:71:56:84:09:12
!          [X70R3-CT1-FC2]
```

```
zone name FlaskStack-VCC-CVD-WLHost19 vsan 101
```

```
member pwn 20:00:00:25:b5:bb:17:26
!          [VCC-WLHost19-HBA1]
member pwn 20:00:00:25:b5:bb:17:27
!          [VCC-WLHost19-HBA3]
member pwn 52:4a:93:71:56:84:09:02
!          [X70R3-CT0-FC2]
member pwn 52:4a:93:71:56:84:09:12
!          [X70R3-CT1-FC2]
```

```
zone name FlaskStack-VCC-CVD-WLHost20 vsan 101
```

```
member pwn 20:00:00:25:b5:bb:17:28
!          [VCC-WLHost20-HBA1]
member pwn 20:00:00:25:b5:bb:17:29
!          [VCC-WLHost20-HBA3]
member pwn 52:4a:93:71:56:84:09:02
!          [X70R3-CT0-FC2]
member pwn 52:4a:93:71:56:84:09:12
!          [X70R3-CT1-FC2]
```

```
zone name FlaskStack-VCC-CVD-WLHost21 vsan 101
```

```
member pwn 20:00:00:25:b5:bb:17:2a
!          [VCC-WLHost21-HBA1]
member pwn 20:00:00:25:b5:bb:17:2b
!          [VCC-WLHost21-HBA3]
member pwn 52:4a:93:71:56:84:09:02
!          [X70R3-CT0-FC2]
member pwn 52:4a:93:71:56:84:09:12
!          [X70R3-CT1-FC2]
```

---

```
zone name FlaskStack-VCC-CVD-WLHost22 vsan 101
  member pwnn 20:00:00:25:b5:bb:17:2c
    !          [VCC-WLHost22-HBA1]
  member pwnn 20:00:00:25:b5:bb:17:2d
    !          [VCC-WLHost22-HBA3]
  member pwnn 52:4a:93:71:56:84:09:02
    !          [X70R3-CT0-FC2]
  member pwnn 52:4a:93:71:56:84:09:12
    !          [X70R3-CT1-FC2]
```

```
zone name FlaskStack-VCC-CVD-WLHost23 vsan 101
  member pwnn 20:00:00:25:b5:bb:17:2e
    !          [VCC-WLHost23-HBA1]
  member pwnn 20:00:00:25:b5:bb:17:2f
    !          [VCC-WLHost23-HBA3]
  member pwnn 52:4a:93:71:56:84:09:02
    !          [X70R3-CT0-FC2]
  member pwnn 52:4a:93:71:56:84:09:12
    !          [X70R3-CT1-FC2]
```

```
zone name FlaskStack-VCC-CVD-WLHost24 vsan 101
  member pwnn 20:00:00:25:b5:bb:17:30
    !          [VCC-WLHost24-HBA1]
  member pwnn 20:00:00:25:b5:bb:17:31
    !          [VCC-WLHost24-HBA3]
  member pwnn 52:4a:93:71:56:84:09:02
    !          [X70R3-CT0-FC2]
  member pwnn 52:4a:93:71:56:84:09:12
    !          [X70R3-CT1-FC2]
```

```
zone name FlaskStack-VCC-CVD-WLHost25 vsan 101
  member pwnn 20:00:00:25:b5:bb:17:32
    !          [VCC-WLHost25-HBA1]
  member pwnn 20:00:00:25:b5:bb:17:33
    !          [VCC-WLHost25-HBA3]
```

---

```
member pwnn 52:4a:93:71:56:84:09:02
!           [X70R3-CT0-FC2]
member pwnn 52:4a:93:71:56:84:09:12
!           [X70R3-CT1-FC2]
```

```
zone name FlaskStack-VCC-CVD-WLHost26 vsan 101
member pwnn 20:00:00:25:b5:bb:17:34
!           [VCC-WLHost26-HBA1]
member pwnn 20:00:00:25:b5:bb:17:35
!           [VCC-WLHost26-HBA3]
member pwnn 52:4a:93:71:56:84:09:02
!           [X70R3-CT0-FC2]
member pwnn 52:4a:93:71:56:84:09:12
!           [X70R3-CT1-FC2]
```

```
zone name FlaskStack-VCC-CVD-WLHost27 vsan 101
member pwnn 20:00:00:25:b5:bb:17:36
!           [VCC-WLHost27-HBA1]
member pwnn 20:00:00:25:b5:bb:17:37
!           [VCC-WLHost27-HBA3]
member pwnn 52:4a:93:71:56:84:09:02
!           [X70R3-CT0-FC2]
member pwnn 52:4a:93:71:56:84:09:12
!           [X70R3-CT1-FC2]
```

```
zone name FlaskStack-VCC-CVD-WLHost28 vsan 101
member pwnn 20:00:00:25:b5:bb:17:38
!           [VCC-WLHost28-HBA1]
member pwnn 20:00:00:25:b5:bb:17:39
!           [VCC-WLHost28-HBA3]
member pwnn 52:4a:93:71:56:84:09:02
!           [X70R3-CT0-FC2]
member pwnn 52:4a:93:71:56:84:09:12
!           [X70R3-CT1-FC2]
```

```
zone name FlaskStack-VCC-CVD-WLHost29 vsan 101
```

```
member pwnn 20:00:00:25:b5:bb:17:3a
!           [VCC-WLHost29-HBA1]
member pwnn 20:00:00:25:b5:bb:17:3b
!           [VCC-WLHost29-HBA3]
member pwnn 52:4a:93:71:56:84:09:02
!           [X70R3-CT0-FC2]
member pwnn 52:4a:93:71:56:84:09:12
!           [X70R3-CT1-FC2]
```

```
zone name FlaskStack-VCC-CVD-WLHost30 vsan 101
```

```
member pwnn 20:00:00:25:b5:bb:17:3c
!           [VCC-WLHost30-HBA1]
member pwnn 20:00:00:25:b5:bb:17:3d
!           [VCC-WLHost30-HBA3]
member pwnn 52:4a:93:71:56:84:09:02
!           [X70R3-CT0-FC2]
member pwnn 52:4a:93:71:56:84:09:12
!           [X70R3-CT1-FC2]
```

```
zone name FlaskStack-VCC-CVD-Infra02 vsan 101
```

```
member pwnn 20:00:00:25:b5:bb:17:3e
!           [VCC-Infra02-HBA1]
member pwnn 20:00:00:25:b5:bb:17:3f
!           [VCC-Infra02-HBA3]
member pwnn 52:4a:93:71:56:84:09:02
!           [X70R3-CT0-FC2]
member pwnn 52:4a:93:71:56:84:09:12
!           [X70R3-CT1-FC2]
```

```
zone name FlaskStack-AMD-VMHost70 vsan 101
```

```
member pwnn 20:00:00:25:b5:bb:17:40
!           [AMD-VMHost70-HBA1]
member pwnn 20:00:00:25:b5:bb:17:41
!           [AMD-VMHost70-HBA3]
member pwnn 52:4a:93:71:56:84:09:02
!           [X70R3-CT0-FC2]
```

---

member pwnn 52:4a:93:71:56:84:09:12  
! [X70R3-CT1-FC2]

zone name FlaskStack-AMD-VMHost71 vsan 101

member pwnn 20:00:00:25:b5:bb:17:42  
! [AMD-VMHost71-HBA1]  
member pwnn 20:00:00:25:b5:bb:17:43  
! [AMD-VMHost71-HBA3]  
member pwnn 52:4a:93:71:56:84:09:02  
! [X70R3-CT0-FC2]  
member pwnn 52:4a:93:71:56:84:09:12  
! [X70R3-CT1-FC2]

zone name FlaskStack-AMD-VMHost72 vsan 101

member pwnn 20:00:00:25:b5:bb:17:44  
! [AMD-VMHost72-HBA1]  
member pwnn 20:00:00:25:b5:bb:17:45  
! [AMD-VMHost72-HBA3]  
member pwnn 52:4a:93:71:56:84:09:02  
! [X70R3-CT0-FC2]  
member pwnn 52:4a:93:71:56:84:09:12  
! [X70R3-CT1-FC2]

zone name FlaskStack-AMD-VMHost73 vsan 101

member pwnn 20:00:00:25:b5:bb:17:4e  
! [AMD-VMHost73-HBA1]  
member pwnn 20:00:00:25:b5:bb:17:4f  
! [AMD-VMHost73-HBA3]  
member pwnn 52:4a:93:71:56:84:09:02  
! [X70R3-CT0-FC2]  
member pwnn 52:4a:93:71:56:84:09:12  
! [X70R3-CT1-FC2]

zone name FlaskStack-AMD-VMHost74 vsan 101

member pwnn 20:00:00:25:b5:bb:17:46  
! [AMD-VMHost74-HBA1]

---

```
member pwn 20:00:00:25:b5:bb:17:47
!          [AMD-VMHost74-HBA3]
member pwn 52:4a:93:71:56:84:09:02
!          [X70R3-CT0-FC2]
member pwn 52:4a:93:71:56:84:09:12
!          [X70R3-CT1-FC2]
```

```
zone name FlaskStack-AMD-VMHost75 vsan 101
member pwn 20:00:00:25:b5:bb:17:48
!          [AMD-VMHost75-HBA1]
member pwn 20:00:00:25:b5:bb:17:49
!          [AMD-VMHost75-HBA3]
member pwn 52:4a:93:71:56:84:09:02
!          [X70R3-CT0-FC2]
member pwn 52:4a:93:71:56:84:09:12
!          [X70R3-CT1-FC2]
```

```
zone name FlaskStack-AMD-VMHost76 vsan 101
member pwn 20:00:00:25:b5:bb:17:4a
!          [AMD-VMHost76-HBA1]
member pwn 20:00:00:25:b5:bb:17:4b
!          [AMD-VMHost76-HBA3]
member pwn 52:4a:93:71:56:84:09:02
!          [X70R3-CT0-FC2]
member pwn 52:4a:93:71:56:84:09:12
!          [X70R3-CT1-FC2]
```

```
zone name FlaskStack-AMD-VMHost77 vsan 101
member pwn 20:00:00:25:b5:bb:17:4c
!          [AMD-VMHost77-HBA1]
member pwn 20:00:00:25:b5:bb:17:4d
!          [AMD-VMHost77-HBA3]
member pwn 52:4a:93:71:56:84:09:02
!          [X70R3-CT0-FC2]
member pwn 52:4a:93:71:56:84:09:12
!          [X70R3-CT1-FC2]
```



```
zoneset name FlashStack-VCC-CVD vsan 101
  member FlaskStack-VCC-CVD-WLHost01
  member FlaskStack-VCC-CVD-WLHost02
  member FlaskStack-VCC-CVD-WLHost03
  member FlaskStack-VCC-CVD-WLHost04
  member FlaskStack-VCC-CVD-WLHost05
  member FlaskStack-VCC-CVD-WLHost06
  member FlaskStack-VCC-CVD-WLHost07
  member FlaskStack-VCC-CVD-WLHost08
  member FlaskStack-VCC-CVD-WLHost09
  member FlaskStack-VCC-CVD-WLHost10
  member FlaskStack-VCC-CVD-WLHost11
  member FlaskStack-VCC-CVD-WLHost12
  member FlaskStack-VCC-CVD-WLHost13
  member FlaskStack-VCC-CVD-WLHost14
  member FlaskStack-VCC-CVD-WLHost15
  member FlaskStack-VCC-CVD-Infra01
  member FlaskStack-VCC-CVD-WLHost16
  member FlaskStack-VCC-CVD-WLHost17
  member FlaskStack-VCC-CVD-WLHost18
  member FlaskStack-VCC-CVD-WLHost19
  member FlaskStack-VCC-CVD-WLHost20
  member FlaskStack-VCC-CVD-WLHost21
  member FlaskStack-VCC-CVD-WLHost22
  member FlaskStack-VCC-CVD-WLHost23
  member FlaskStack-VCC-CVD-WLHost24
  member FlaskStack-VCC-CVD-WLHost25
  member FlaskStack-VCC-CVD-WLHost26
  member FlaskStack-VCC-CVD-WLHost27
  member FlaskStack-VCC-CVD-WLHost28
  member FlaskStack-VCC-CVD-WLHost29
  member FlaskStack-VCC-CVD-WLHost30
  member FlaskStack-VCC-CVD-Infra02
  member FlaskStack-AMD-VMHost70
  member FlaskStack-AMD-VMHost71
```

```
member FlaskStack-AMD-VMHost72
member FlaskStack-AMD-VMHost73
member FlaskStack-AMD-VMHost74
member FlaskStack-AMD-VMHost75
member FlaskStack-AMD-VMHost76
member FlaskStack-AMD-VMHost77
```

```
zoneset activate name FlashStack-VCC-CVD vsan 101
```

```
do clear zone database vsan 101
```

```
!Full Zone Database Section for vsan 101
```

```
zone name FlaskStack-VCC-CVD-WLHost01 vsan 101
```

```
member pwnn 20:00:00:25:b5:bb:17:00
!           [VCC-WLHost01-HBA1]
member pwnn 20:00:00:25:b5:bb:17:01
!           [VCC-WLHost01-HBA3]
member pwnn 52:4a:93:71:56:84:09:02
!           [X70R3-CT0-FC2]
member pwnn 52:4a:93:71:56:84:09:12
!           [X70R3-CT1-FC2]
```

```
zone name FlaskStack-VCC-CVD-WLHost02 vsan 101
```

```
member pwnn 20:00:00:25:b5:bb:17:02
!           [VCC-WLHost02-HBA1]
member pwnn 20:00:00:25:b5:bb:17:03
!           [VCC-WLHost02-HBA3]
member pwnn 52:4a:93:71:56:84:09:02
!           [X70R3-CT0-FC2]
member pwnn 52:4a:93:71:56:84:09:12
!           [X70R3-CT1-FC2]
```

```
zone name FlaskStack-VCC-CVD-WLHost03 vsan 101
```

```
member pwnn 20:00:00:25:b5:bb:17:04
!           [VCC-WLHost03-HBA1]
member pwnn 20:00:00:25:b5:bb:17:05
!           [VCC-WLHost03-HBA3]
member pwnn 52:4a:93:71:56:84:09:02
```

---

```
!           [X70R3-CT0-FC2]
member pwnn 52:4a:93:71:56:84:09:12
!           [X70R3-CT1-FC2]
```

```
zone name FlaskStack-VCC-CVD-WLHost04 vsan 101
  member pwnn 20:00:00:25:b5:bb:17:06
  !           [VCC-WLHost04-HBA1]
  member pwnn 20:00:00:25:b5:bb:17:07
  !           [VCC-WLHost04-HBA3]
  member pwnn 52:4a:93:71:56:84:09:02
  !           [X70R3-CT0-FC2]
  member pwnn 52:4a:93:71:56:84:09:12
  !           [X70R3-CT1-FC2]
```

```
zone name FlaskStack-VCC-CVD-WLHost05 vsan 101
  member pwnn 20:00:00:25:b5:bb:17:08
  !           [VCC-WLHost05-HBA1]
  member pwnn 20:00:00:25:b5:bb:17:09
  !           [VCC-WLHost05-HBA3]
  member pwnn 52:4a:93:71:56:84:09:02
  !           [X70R3-CT0-FC2]
  member pwnn 52:4a:93:71:56:84:09:12
  !           [X70R3-CT1-FC2]
```

```
zone name FlaskStack-VCC-CVD-WLHost06 vsan 101
  member pwnn 20:00:00:25:b5:bb:17:0a
  !           [VCC-WLHost06-HBA1]
  member pwnn 20:00:00:25:b5:bb:17:0b
  !           [VCC-WLHost06-HBA3]
  member pwnn 52:4a:93:71:56:84:09:02
  !           [X70R3-CT0-FC2]
  member pwnn 52:4a:93:71:56:84:09:12
  !           [X70R3-CT1-FC2]
```

```
zone name FlaskStack-VCC-CVD-WLHost07 vsan 101
  member pwnn 20:00:00:25:b5:bb:17:0c
```

---

```
!           [VCC-WLHost07-HBA1]
member pwnn 20:00:00:25:b5:bb:17:0d
!           [VCC-WLHost07-HBA3]
member pwnn 52:4a:93:71:56:84:09:02
!           [X70R3-CT0-FC2]
member pwnn 52:4a:93:71:56:84:09:12
!           [X70R3-CT1-FC2]
```

```
zone name FlaskStack-VCC-CVD-WLHost08 vsan 101
member pwnn 20:00:00:25:b5:bb:17:0e
!           [VCC-WLHost08-HBA1]
member pwnn 20:00:00:25:b5:bb:17:0f
!           [VCC-WLHost08-HBA3]
member pwnn 52:4a:93:71:56:84:09:02
!           [X70R3-CT0-FC2]
member pwnn 52:4a:93:71:56:84:09:12
!           [X70R3-CT1-FC2]
```

```
zone name FlaskStack-VCC-CVD-WLHost09 vsan 101
member pwnn 20:00:00:25:b5:bb:17:10
!           [VCC-WLHost09-HBA1]
member pwnn 20:00:00:25:b5:bb:17:11
!           [VCC-WLHost09-HBA3]
member pwnn 52:4a:93:71:56:84:09:02
!           [X70R3-CT0-FC2]
member pwnn 52:4a:93:71:56:84:09:12
!           [X70R3-CT1-FC2]
```

```
zone name FlaskStack-VCC-CVD-WLHost10 vsan 101
member pwnn 20:00:00:25:b5:bb:17:12
!           [VCC-WLHost10-HBA1]
member pwnn 20:00:00:25:b5:bb:17:13
!           [VCC-WLHost10-HBA3]
member pwnn 52:4a:93:71:56:84:09:02
!           [X70R3-CT0-FC2]
member pwnn 52:4a:93:71:56:84:09:12
```

---

! [X70R3-CT1-FC2]

zone name FlaskStack-VCC-CVD-WLHost11 vsan 101

member pwwn 20:00:00:25:b5:bb:17:14

! [VCC-WLHost11-HBA1]

member pwwn 20:00:00:25:b5:bb:17:15

! [VCC-WLHost11-HBA3]

member pwwn 52:4a:93:71:56:84:09:02

! [X70R3-CT0-FC2]

member pwwn 52:4a:93:71:56:84:09:12

! [X70R3-CT1-FC2]

zone name FlaskStack-VCC-CVD-WLHost12 vsan 101

member pwwn 20:00:00:25:b5:bb:17:16

! [VCC-WLHost12-HBA1]

member pwwn 20:00:00:25:b5:bb:17:17

! [VCC-WLHost12-HBA3]

member pwwn 52:4a:93:71:56:84:09:02

! [X70R3-CT0-FC2]

member pwwn 52:4a:93:71:56:84:09:12

! [X70R3-CT1-FC2]

zone name FlaskStack-VCC-CVD-WLHost13 vsan 101

member pwwn 20:00:00:25:b5:bb:17:18

! [VCC-WLHost13-HBA1]

member pwwn 20:00:00:25:b5:bb:17:19

! [VCC-WLHost13-HBA3]

member pwwn 52:4a:93:71:56:84:09:02

! [X70R3-CT0-FC2]

member pwwn 52:4a:93:71:56:84:09:12

! [X70R3-CT1-FC2]

zone name FlaskStack-VCC-CVD-WLHost14 vsan 101

member pwwn 20:00:00:25:b5:bb:17:1a

! [VCC-WLHost14-HBA1]

member pwwn 20:00:00:25:b5:bb:17:1b

---

```
!           [VCC-WLHost14-HBA3]
member pwnn 52:4a:93:71:56:84:09:02
!           [X70R3-CT0-FC2]
member pwnn 52:4a:93:71:56:84:09:12
!           [X70R3-CT1-FC2]
```

```
zone name FlaskStack-VCC-CVD-WLHost15 vsan 101
member pwnn 20:00:00:25:b5:bb:17:1c
!           [VCC-WLHost15-HBA1]
member pwnn 20:00:00:25:b5:bb:17:1d
!           [VCC-WLHost15-HBA3]
member pwnn 52:4a:93:71:56:84:09:02
!           [X70R3-CT0-FC2]
member pwnn 52:4a:93:71:56:84:09:12
!           [X70R3-CT1-FC2]
```

```
zone name FlaskStack-VCC-CVD-Infra01 vsan 101
member pwnn 20:00:00:25:b5:bb:17:1e
!           [VCC-Infra01-HBA1]
member pwnn 20:00:00:25:b5:bb:17:1f
!           [VCC-Infra01-HBA3]
member pwnn 52:4a:93:71:56:84:09:02
!           [X70R3-CT0-FC2]
member pwnn 52:4a:93:71:56:84:09:12
!           [X70R3-CT1-FC2]
```

```
zone name FlaskStack-VCC-CVD-WLHost16 vsan 101
member pwnn 20:00:00:25:b5:bb:17:20
!           [VCC-WLHost16-HBA1]
member pwnn 20:00:00:25:b5:bb:17:21
!           [VCC-WLHost16-HBA3]
member pwnn 52:4a:93:71:56:84:09:02
!           [X70R3-CT0-FC2]
member pwnn 52:4a:93:71:56:84:09:12
!           [X70R3-CT1-FC2]
```

---

```
zone name FlaskStack-VCC-CVD-WLHost17 vsan 101
  member pwnn 20:00:00:25:b5:bb:17:22
    !          [VCC-WLHost17-HBA1]
  member pwnn 20:00:00:25:b5:bb:17:23
    !          [VCC-WLHost17-HBA3]
  member pwnn 52:4a:93:71:56:84:09:02
    !          [X70R3-CT0-FC2]
  member pwnn 52:4a:93:71:56:84:09:12
    !          [X70R3-CT1-FC2]
```

```
zone name FlaskStack-VCC-CVD-WLHost18 vsan 101
  member pwnn 20:00:00:25:b5:bb:17:24
    !          [VCC-WLHost18-HBA1]
  member pwnn 20:00:00:25:b5:bb:17:25
    !          [VCC-WLHost18-HBA3]
  member pwnn 52:4a:93:71:56:84:09:02
    !          [X70R3-CT0-FC2]
  member pwnn 52:4a:93:71:56:84:09:12
    !          [X70R3-CT1-FC2]
```

```
zone name FlaskStack-VCC-CVD-WLHost19 vsan 101
  member pwnn 20:00:00:25:b5:bb:17:26
    !          [VCC-WLHost19-HBA1]
  member pwnn 20:00:00:25:b5:bb:17:27
    !          [VCC-WLHost19-HBA3]
  member pwnn 52:4a:93:71:56:84:09:02
    !          [X70R3-CT0-FC2]
  member pwnn 52:4a:93:71:56:84:09:12
    !          [X70R3-CT1-FC2]
```

```
zone name FlaskStack-VCC-CVD-WLHost20 vsan 101
  member pwnn 20:00:00:25:b5:bb:17:28
    !          [VCC-WLHost20-HBA1]
  member pwnn 20:00:00:25:b5:bb:17:29
    !          [VCC-WLHost20-HBA3]
  member pwnn 52:4a:93:71:56:84:09:02
```

---

```
!           [X70R3-CT0-FC2]
member pwnn 52:4a:93:71:56:84:09:12
!           [X70R3-CT1-FC2]
```

```
zone name FlaskStack-VCC-CVD-WLHost21 vsan 101
  member pwnn 20:00:00:25:b5:bb:17:2a
  !           [VCC-WLHost21-HBA1]
  member pwnn 20:00:00:25:b5:bb:17:2b
  !           [VCC-WLHost21-HBA3]
  member pwnn 52:4a:93:71:56:84:09:02
  !           [X70R3-CT0-FC2]
  member pwnn 52:4a:93:71:56:84:09:12
  !           [X70R3-CT1-FC2]
```

```
zone name FlaskStack-VCC-CVD-WLHost22 vsan 101
  member pwnn 20:00:00:25:b5:bb:17:2c
  !           [VCC-WLHost22-HBA1]
  member pwnn 20:00:00:25:b5:bb:17:2d
  !           [VCC-WLHost22-HBA3]
  member pwnn 52:4a:93:71:56:84:09:02
  !           [X70R3-CT0-FC2]
  member pwnn 52:4a:93:71:56:84:09:12
  !           [X70R3-CT1-FC2]
```

```
zone name FlaskStack-VCC-CVD-WLHost23 vsan 101
  member pwnn 20:00:00:25:b5:bb:17:2e
  !           [VCC-WLHost23-HBA1]
  member pwnn 20:00:00:25:b5:bb:17:2f
  !           [VCC-WLHost23-HBA3]
  member pwnn 52:4a:93:71:56:84:09:02
  !           [X70R3-CT0-FC2]
  member pwnn 52:4a:93:71:56:84:09:12
  !           [X70R3-CT1-FC2]
```

```
zone name FlaskStack-VCC-CVD-WLHost24 vsan 101
  member pwnn 20:00:00:25:b5:bb:17:30
```



---

```
!           [VCC-WLHost24-HBA1]
member pwnn 20:00:00:25:b5:bb:17:31
!           [VCC-WLHost24-HBA3]
member pwnn 52:4a:93:71:56:84:09:02
!           [X70R3-CT0-FC2]
member pwnn 52:4a:93:71:56:84:09:12
!           [X70R3-CT1-FC2]
```

```
zone name FlaskStack-VCC-CVD-WLHost25 vsan 101
member pwnn 20:00:00:25:b5:bb:17:32
!           [VCC-WLHost25-HBA1]
member pwnn 20:00:00:25:b5:bb:17:33
!           [VCC-WLHost25-HBA3]
member pwnn 52:4a:93:71:56:84:09:02
!           [X70R3-CT0-FC2]
member pwnn 52:4a:93:71:56:84:09:12
!           [X70R3-CT1-FC2]
```

```
zone name FlaskStack-VCC-CVD-WLHost26 vsan 101
member pwnn 20:00:00:25:b5:bb:17:34
!           [VCC-WLHost26-HBA1]
member pwnn 20:00:00:25:b5:bb:17:35
!           [VCC-WLHost26-HBA3]
member pwnn 52:4a:93:71:56:84:09:02
!           [X70R3-CT0-FC2]
member pwnn 52:4a:93:71:56:84:09:12
!           [X70R3-CT1-FC2]
```

```
zone name FlaskStack-VCC-CVD-WLHost27 vsan 101
member pwnn 20:00:00:25:b5:bb:17:36
!           [VCC-WLHost27-HBA1]
member pwnn 20:00:00:25:b5:bb:17:37
!           [VCC-WLHost27-HBA3]
member pwnn 52:4a:93:71:56:84:09:02
!           [X70R3-CT0-FC2]
member pwnn 52:4a:93:71:56:84:09:12
```

---

! [X70R3-CT1-FC2]

zone name FlaskStack-VCC-CVD-WLHost28 vsan 101

member pwnn 20:00:00:25:b5:bb:17:38

! [VCC-WLHost28-HBA1]

member pwnn 20:00:00:25:b5:bb:17:39

! [VCC-WLHost28-HBA3]

member pwnn 52:4a:93:71:56:84:09:02

! [X70R3-CT0-FC2]

member pwnn 52:4a:93:71:56:84:09:12

! [X70R3-CT1-FC2]

zone name FlaskStack-VCC-CVD-WLHost29 vsan 101

member pwnn 20:00:00:25:b5:bb:17:3a

! [VCC-WLHost29-HBA1]

member pwnn 20:00:00:25:b5:bb:17:3b

! [VCC-WLHost29-HBA3]

member pwnn 52:4a:93:71:56:84:09:02

! [X70R3-CT0-FC2]

member pwnn 52:4a:93:71:56:84:09:12

! [X70R3-CT1-FC2]

zone name FlaskStack-VCC-CVD-WLHost30 vsan 101

member pwnn 20:00:00:25:b5:bb:17:3c

! [VCC-WLHost30-HBA1]

member pwnn 20:00:00:25:b5:bb:17:3d

! [VCC-WLHost30-HBA3]

member pwnn 52:4a:93:71:56:84:09:02

! [X70R3-CT0-FC2]

member pwnn 52:4a:93:71:56:84:09:12

! [X70R3-CT1-FC2]

zone name FlaskStack-VCC-CVD-Infra02 vsan 101

member pwnn 20:00:00:25:b5:bb:17:3e

! [VCC-Infra02-HBA1]

member pwnn 20:00:00:25:b5:bb:17:3f

---

```
!           [VCC-Infra02-HBA3]
member pwnn 52:4a:93:71:56:84:09:02
!           [X70R3-CT0-FC2]
member pwnn 52:4a:93:71:56:84:09:12
!           [X70R3-CT1-FC2]
```

```
zone name FlaskStack-AMD-VMHost70 vsan 101
member pwnn 20:00:00:25:b5:bb:17:40
!           [AMD-VMHost70-HBA1]
member pwnn 20:00:00:25:b5:bb:17:41
!           [AMD-VMHost70-HBA3]
member pwnn 52:4a:93:71:56:84:09:02
!           [X70R3-CT0-FC2]
member pwnn 52:4a:93:71:56:84:09:12
!           [X70R3-CT1-FC2]
```

```
zone name FlaskStack-AMD-VMHost71 vsan 101
member pwnn 20:00:00:25:b5:bb:17:42
!           [AMD-VMHost71-HBA1]
member pwnn 20:00:00:25:b5:bb:17:43
!           [AMD-VMHost71-HBA3]
member pwnn 52:4a:93:71:56:84:09:02
!           [X70R3-CT0-FC2]
member pwnn 52:4a:93:71:56:84:09:12
!           [X70R3-CT1-FC2]
```

```
zone name FlaskStack-AMD-VMHost72 vsan 101
member pwnn 20:00:00:25:b5:bb:17:44
!           [AMD-VMHost72-HBA1]
member pwnn 20:00:00:25:b5:bb:17:45
!           [AMD-VMHost72-HBA3]
member pwnn 52:4a:93:71:56:84:09:02
!           [X70R3-CT0-FC2]
member pwnn 52:4a:93:71:56:84:09:12
!           [X70R3-CT1-FC2]
```

---

```
zone name FlaskStack-AMD-VMHost73 vsan 101
  member pwwn 20:00:00:25:b5:bb:17:4e
    !          [AMD-VMHost73-HBA1]
  member pwwn 20:00:00:25:b5:bb:17:4f
    !          [AMD-VMHost73-HBA3]
  member pwwn 52:4a:93:71:56:84:09:02
    !          [X70R3-CT0-FC2]
  member pwwn 52:4a:93:71:56:84:09:12
    !          [X70R3-CT1-FC2]
```

```
zone name FlaskStack-AMD-VMHost74 vsan 101
  member pwwn 20:00:00:25:b5:bb:17:46
    !          [AMD-VMHost74-HBA1]
  member pwwn 20:00:00:25:b5:bb:17:47
    !          [AMD-VMHost74-HBA3]
  member pwwn 52:4a:93:71:56:84:09:02
    !          [X70R3-CT0-FC2]
  member pwwn 52:4a:93:71:56:84:09:12
    !          [X70R3-CT1-FC2]
```

```
zone name FlaskStack-AMD-VMHost75 vsan 101
  member pwwn 20:00:00:25:b5:bb:17:48
    !          [AMD-VMHost75-HBA1]
  member pwwn 20:00:00:25:b5:bb:17:49
    !          [AMD-VMHost75-HBA3]
  member pwwn 52:4a:93:71:56:84:09:02
    !          [X70R3-CT0-FC2]
  member pwwn 52:4a:93:71:56:84:09:12
    !          [X70R3-CT1-FC2]
```

```
zone name FlaskStack-AMD-VMHost76 vsan 101
  member pwwn 20:00:00:25:b5:bb:17:4a
    !          [AMD-VMHost76-HBA1]
  member pwwn 20:00:00:25:b5:bb:17:4b
    !          [AMD-VMHost76-HBA3]
  member pwwn 52:4a:93:71:56:84:09:02
```

```
!           [X70R3-CT0-FC2]
member pwnn 52:4a:93:71:56:84:09:12
!           [X70R3-CT1-FC2]
```

```
zone name FlaskStack-AMD-VMHost77 vsan 101
```

```
member pwnn 20:00:00:25:b5:bb:17:4c
!           [AMD-VMHost77-HBA1]
member pwnn 20:00:00:25:b5:bb:17:4d
!           [AMD-VMHost77-HBA3]
member pwnn 52:4a:93:71:56:84:09:02
!           [X70R3-CT0-FC2]
member pwnn 52:4a:93:71:56:84:09:12
!           [X70R3-CT1-FC2]
```

```
zoneset name FlashStack-VCC-CVD vsan 101
```

```
member FlaskStack-VCC-CVD-WLHost01
member FlaskStack-VCC-CVD-WLHost02
member FlaskStack-VCC-CVD-WLHost03
member FlaskStack-VCC-CVD-WLHost04
member FlaskStack-VCC-CVD-WLHost05
member FlaskStack-VCC-CVD-WLHost06
member FlaskStack-VCC-CVD-WLHost07
member FlaskStack-VCC-CVD-WLHost08
member FlaskStack-VCC-CVD-WLHost09
member FlaskStack-VCC-CVD-WLHost10
member FlaskStack-VCC-CVD-WLHost11
member FlaskStack-VCC-CVD-WLHost12
member FlaskStack-VCC-CVD-WLHost13
member FlaskStack-VCC-CVD-WLHost14
member FlaskStack-VCC-CVD-WLHost15
member FlaskStack-VCC-CVD-Infra01
member FlaskStack-VCC-CVD-WLHost16
member FlaskStack-VCC-CVD-WLHost17
member FlaskStack-VCC-CVD-WLHost18
member FlaskStack-VCC-CVD-WLHost19
member FlaskStack-VCC-CVD-WLHost20
```

```
member FlaskStack-VCC-CVD-WLHost21
member FlaskStack-VCC-CVD-WLHost22
member FlaskStack-VCC-CVD-WLHost23
member FlaskStack-VCC-CVD-WLHost24
member FlaskStack-VCC-CVD-WLHost25
member FlaskStack-VCC-CVD-WLHost26
member FlaskStack-VCC-CVD-WLHost27
member FlaskStack-VCC-CVD-WLHost28
member FlaskStack-VCC-CVD-WLHost29
member FlaskStack-VCC-CVD-WLHost30
member FlaskStack-VCC-CVD-Infra02
member FlaskStack-AMD-VMHost70
member FlaskStack-AMD-VMHost71
member FlaskStack-AMD-VMHost72
member FlaskStack-AMD-VMHost73
member FlaskStack-AMD-VMHost74
member FlaskStack-AMD-VMHost75
member FlaskStack-AMD-VMHost76
member FlaskStack-AMD-VMHost77
```

```
interface mgmt0
  ip address 10.29.164.239 255.255.255.0
vsan database
  vsan 101 interface fc1/9
  vsan 101 interface fc1/10
  vsan 101 interface fc1/11
  vsan 101 interface fc1/12
  vsan 101 interface fc1/13
  vsan 101 interface fc1/14
  vsan 101 interface fc1/15
  vsan 101 interface fc1/16
clock timezone PST 0 0
clock summer-time PDT 2 Sun Mar 02:00 1 Sun Nov 02:00 60
switchname ADD16-MDS-B
```

```
cli alias name autozone source sys/autozone.py
line console
line vty
boot kickstart bootflash:/m9100-s6ek9-kickstart-mz.8.3.1.bin
boot system bootflash:/m9100-s6ek9-mz.8.3.1.bin
interface fc1/1
interface fc1/2
interface fc1/3
interface fc1/4
interface fc1/5
interface fc1/6
interface fc1/7
interface fc1/8
interface fc1/9
interface fc1/10
interface fc1/11
interface fc1/12
interface fc1/13
interface fc1/14
interface fc1/15
interface fc1/16

interface fc1/1
    no port-license

interface fc1/2
    no port-license

interface fc1/3
    no port-license

interface fc1/4
    no port-license

interface fc1/5
    no port-license
```

---

```
interface fc1/6
  no port-license
```

```
interface fc1/7
  no port-license
```

```
interface fc1/8
  no port-license
```

```
interface fc1/9
  switchport trunk allowed vsan 101
  switchport trunk mode off
  port-license acquire
  no shutdown
```

```
interface fc1/10
  switchport trunk allowed vsan 101
  switchport trunk mode off
  port-license acquire
  no shutdown
```

```
interface fc1/11
  switchport trunk allowed vsan 101
  switchport trunk mode off
  port-license acquire
  no shutdown
```

```
interface fc1/12
  switchport trunk allowed vsan 101
  switchport trunk mode off
  port-license acquire
  no shutdown
```

```
interface fc1/13
  switchport trunk allowed vsan 101
```



```
switchport trunk mode off
port-license acquire
no shutdown

interface fcl/14
switchport trunk allowed vsan 101
switchport trunk mode off
port-license acquire
no shutdown

interface fcl/15
switchport trunk allowed vsan 101
switchport trunk mode off
port-license acquire
no shutdown

interface fcl/16
switchport trunk allowed vsan 101
switchport trunk mode off
port-license acquire
no shutdown

ip default-gateway 10.29.164.1
```

## **Full Scale Server Performance Chart with Boot and LoginVSI Knowledge Worker Workload Test**

This section provides a detailed performance chart for ESXi 7.0 GA installed on Cisco UCS B200 M5 Blade Server as part of the workload test with VMware Horizon 7.12 deployed on Pure Storage FlashArray//70 R3 system running LoginVSI v4.1.39 based knowledge worker workload part of the FlashStack reference architecture defined here.

The charts below are defined in the set of 30 hosts in the single performance chart.

# VDI Server Performance Monitor Data for One Sample Test: 5022 Users VDI Non-Persistent (Instant Clones) Scale Testing

Figure 145. Full Scale | 5022 Non-Persistent Users| VDI Host | Host CPU Utilization

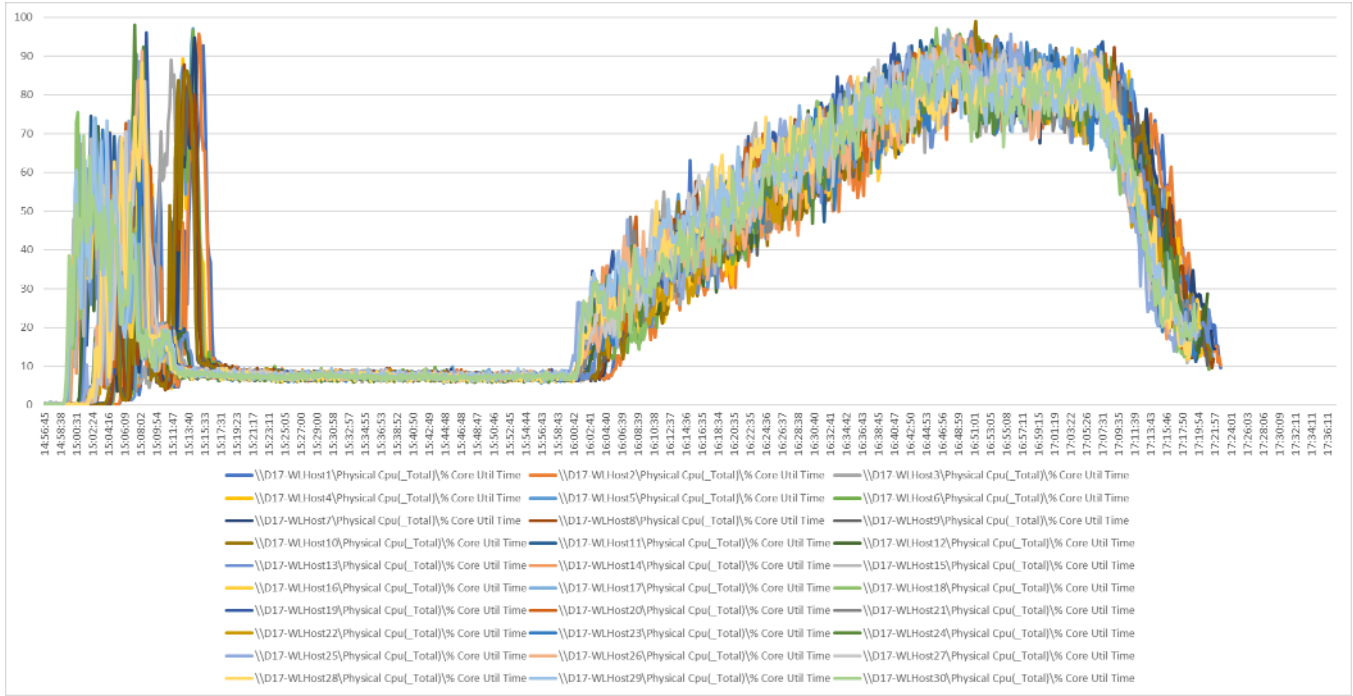



Figure 147. Full Scale | 5022 Non-Persistent Users| VDI Host | Host Network Utilization | Received

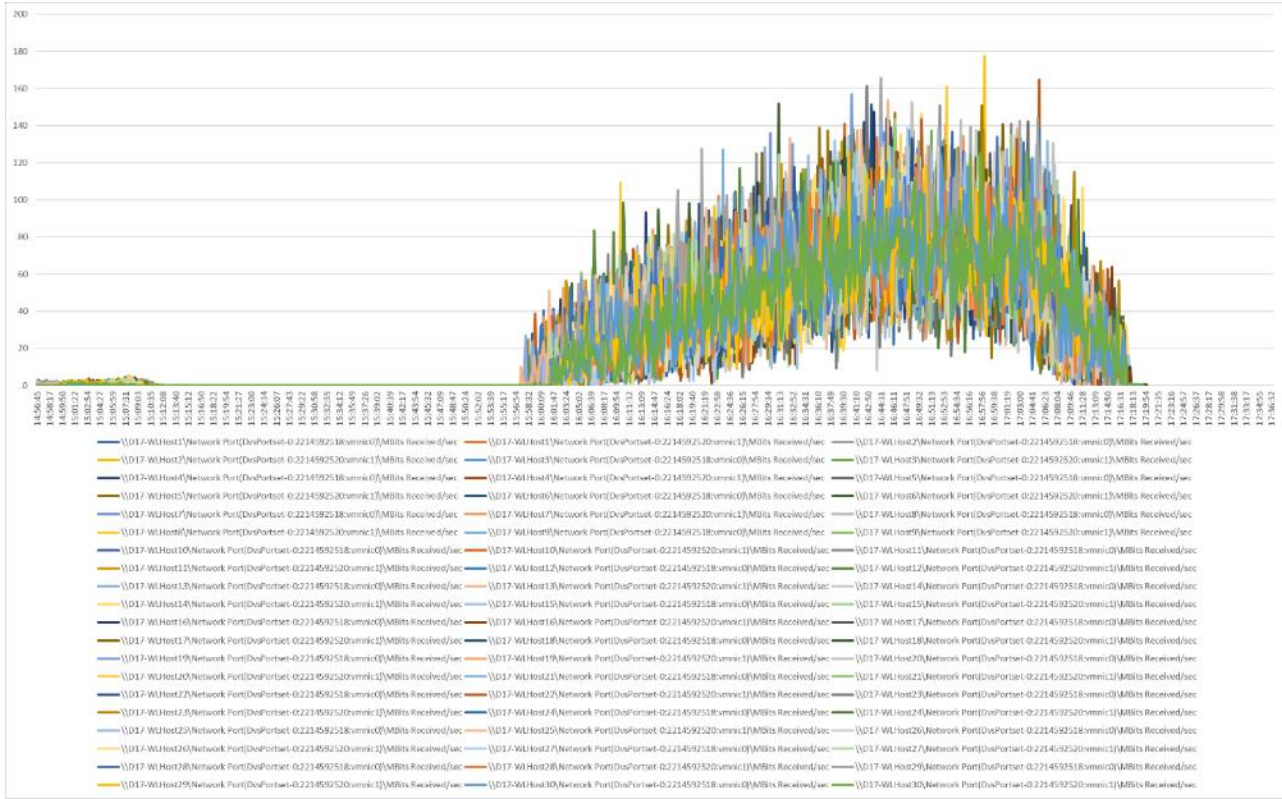
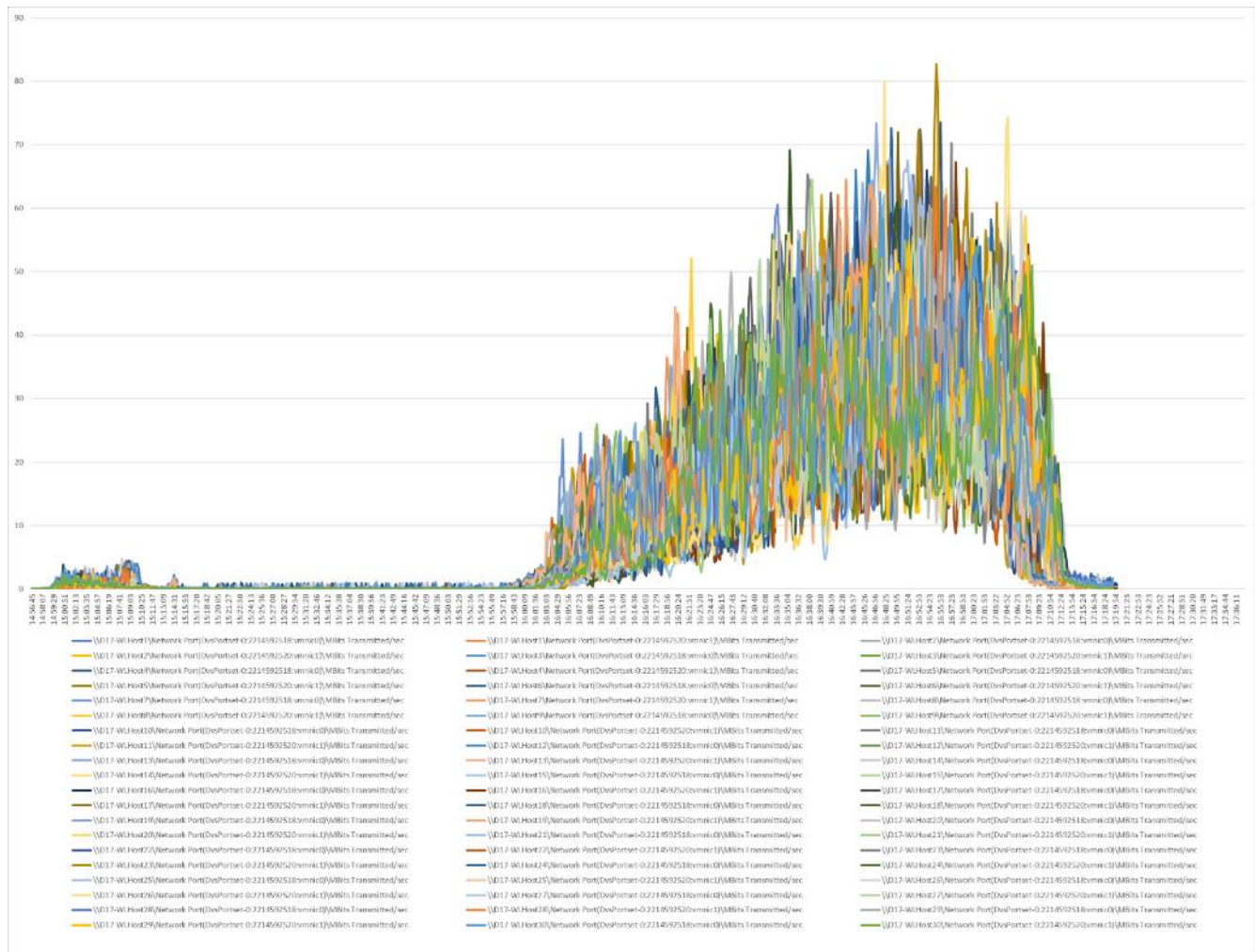

Figure 148. Full Scale | 5022 Non-Persistent Users| VDI Host | Host Network Utilization | Transmitted



# VDI Server Performance Monitor Data for One Sample Test: 5022 Users VDI Persistent (Full Clones) Scale Testing

Figure 149. Full Scale | 5022 Persistent Users| VDI Host | Host CPU Utilization

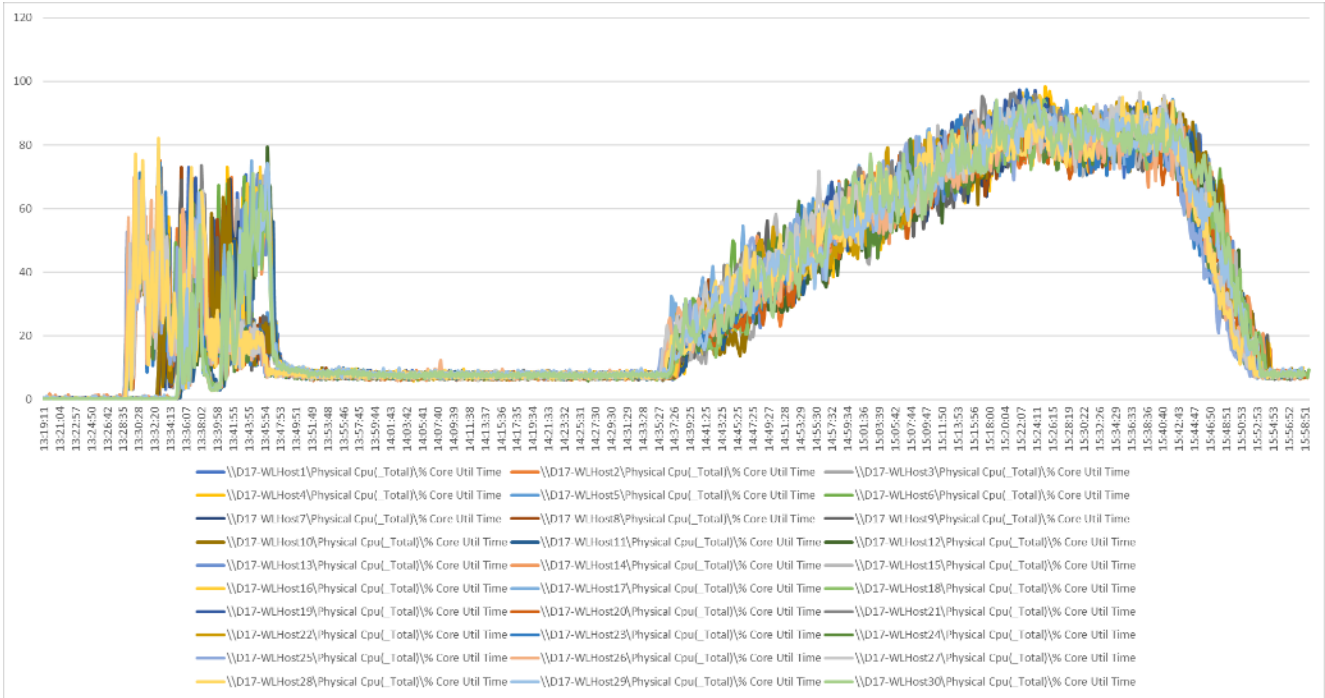





Figure 151. Full Scale | 5022 Persistent Users | VDI Host | Host Network Utilization | Received

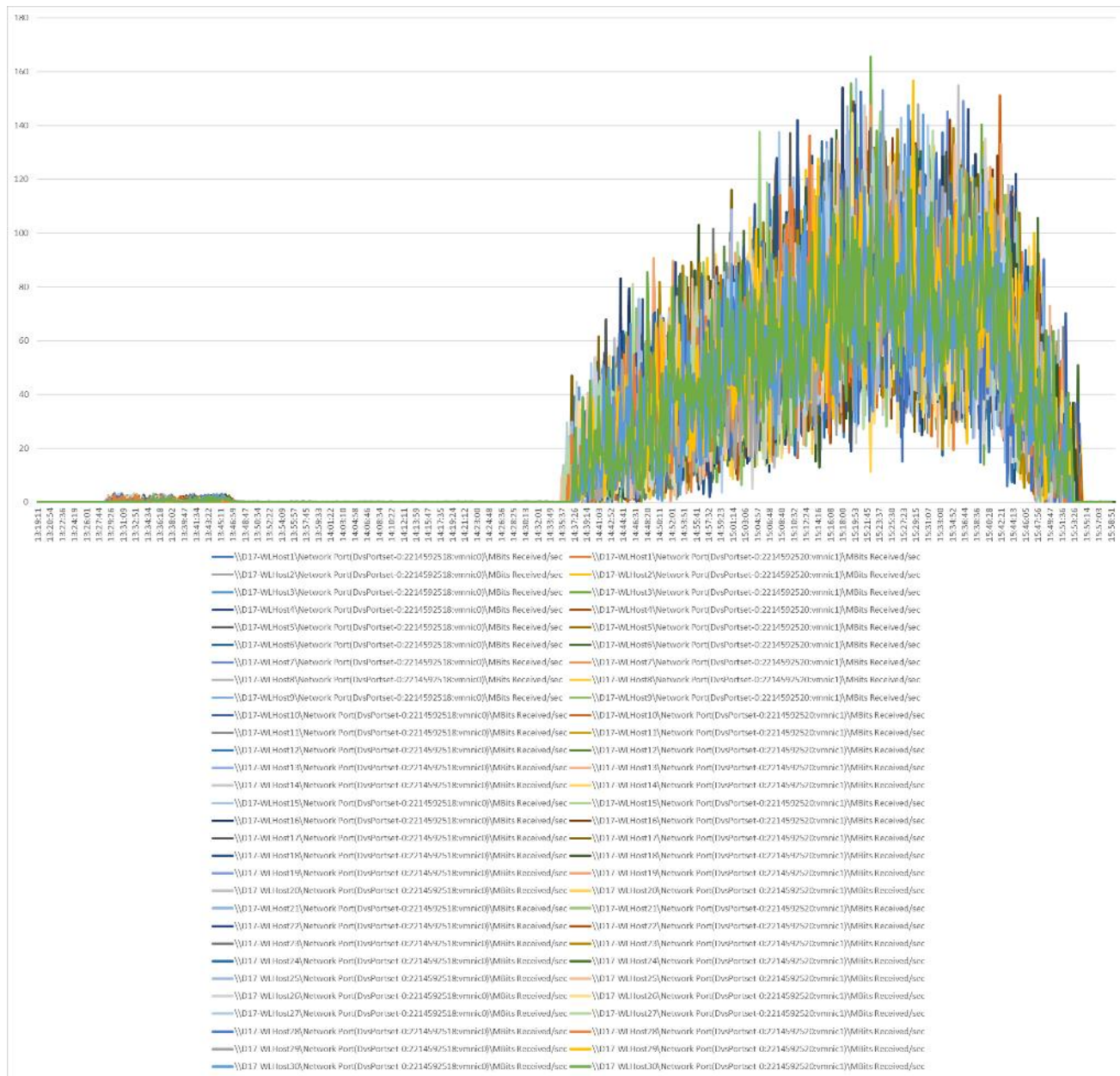
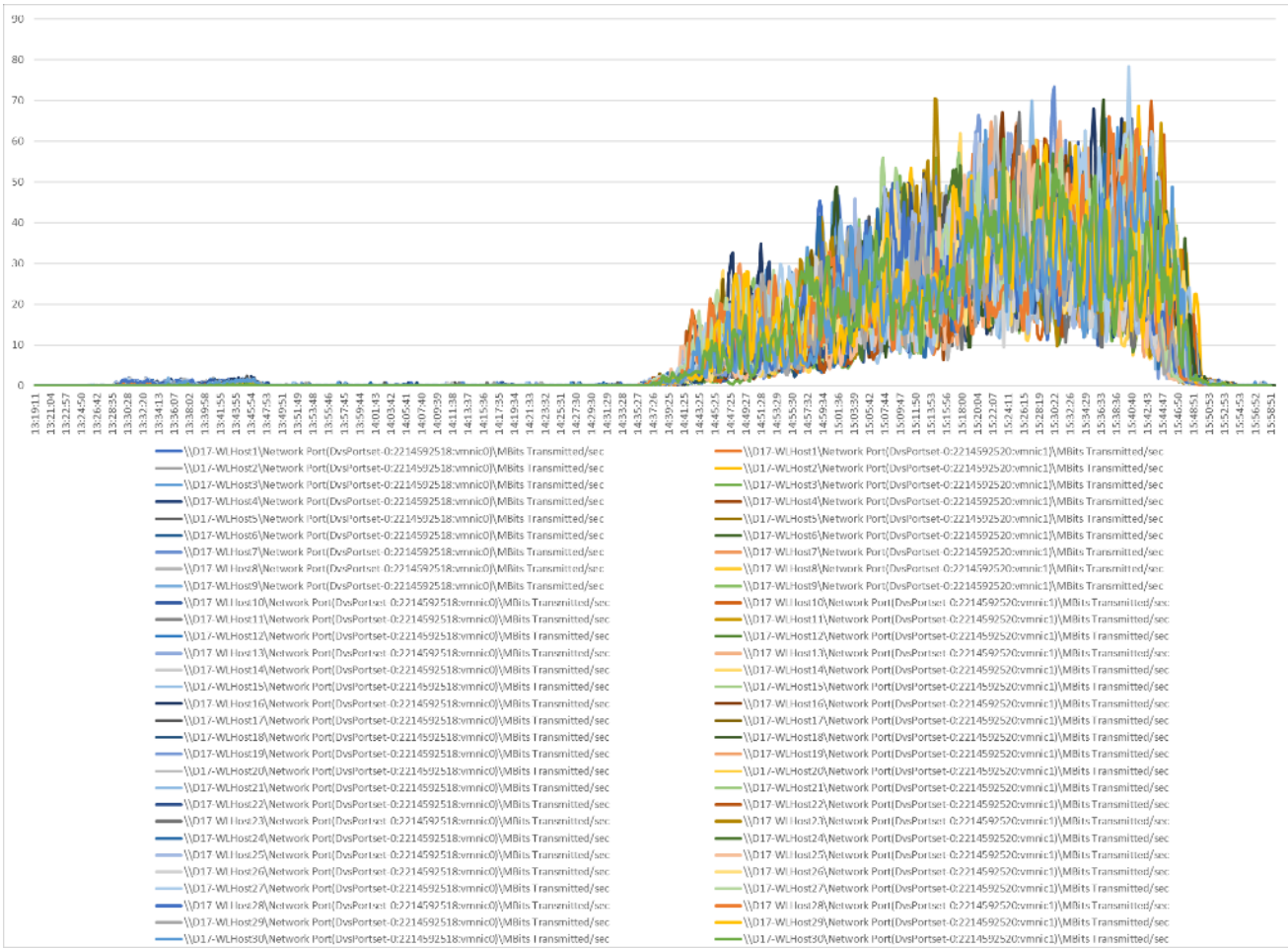



Figure 152. Full Scale | 5022 Persistent Users | VDI Host | Host Network Utilization | Transmitted



# VDI Server Performance Monitor Data for One Sample Test: 6048 Users RDS Scale Testing

Figure 153. Full Scale | 6048 RDS Users| VDI Host | Host CPU Utilization

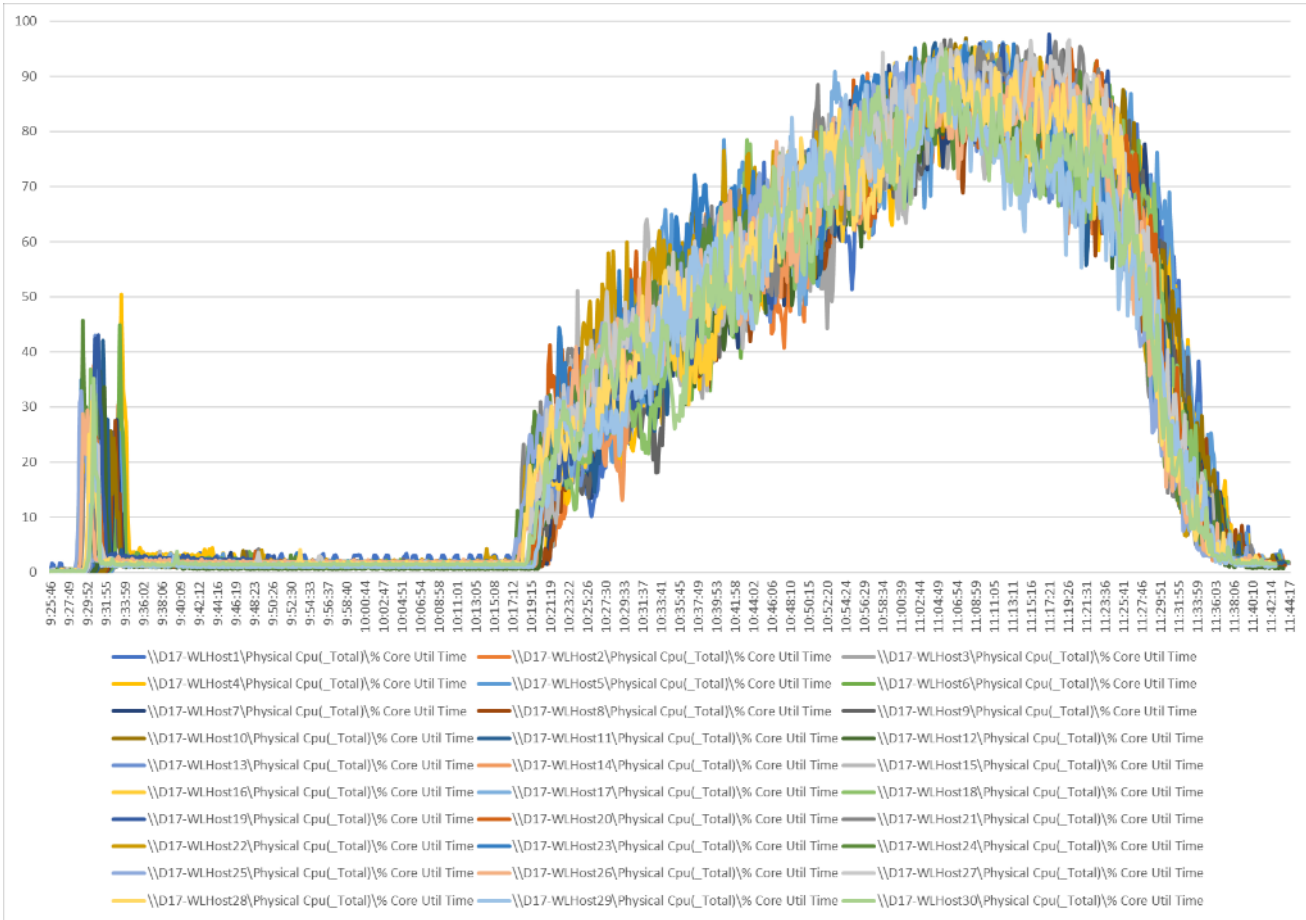

Figure 154. Full Scale | 6048 RDS Users| VDI Host | Host Memory Utilization

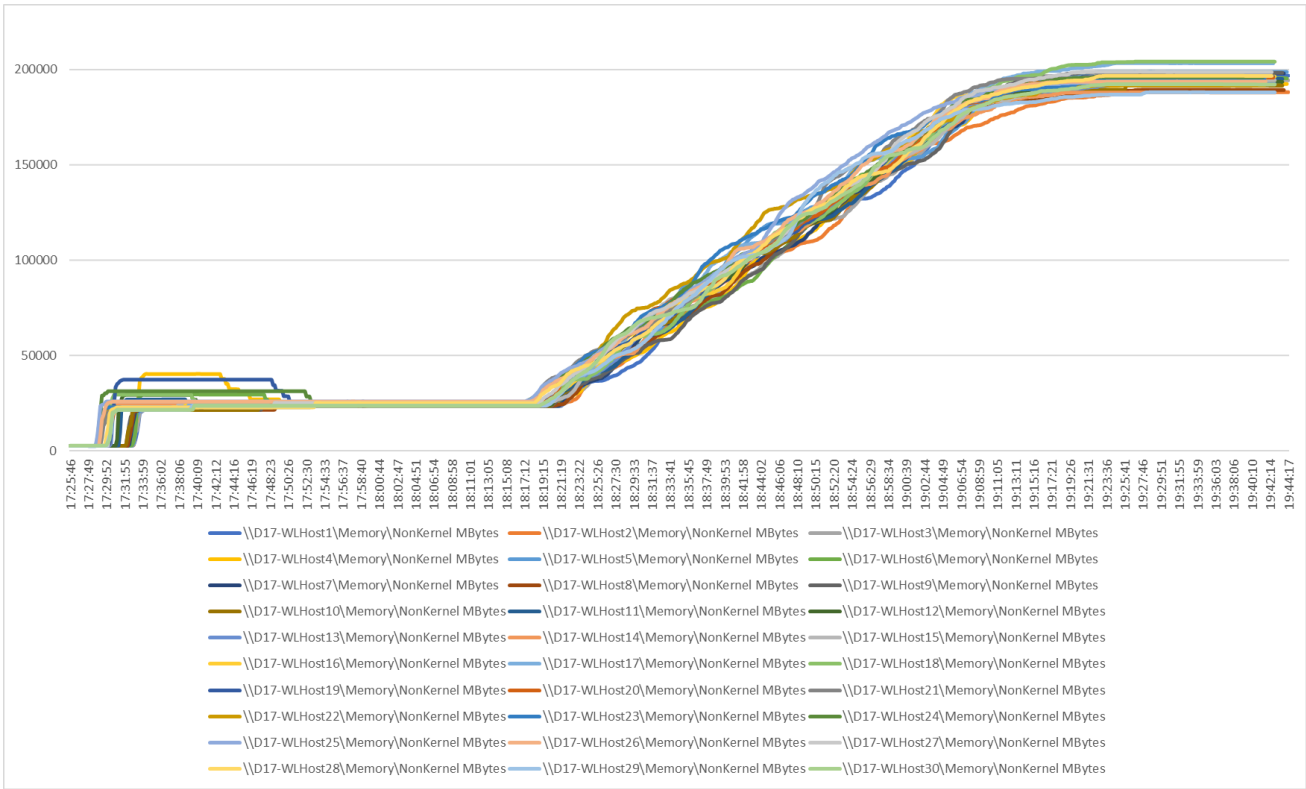

Figure 155. Full Scale | 6048 RDS Users| VDI Host | Host Network Utilization | Received

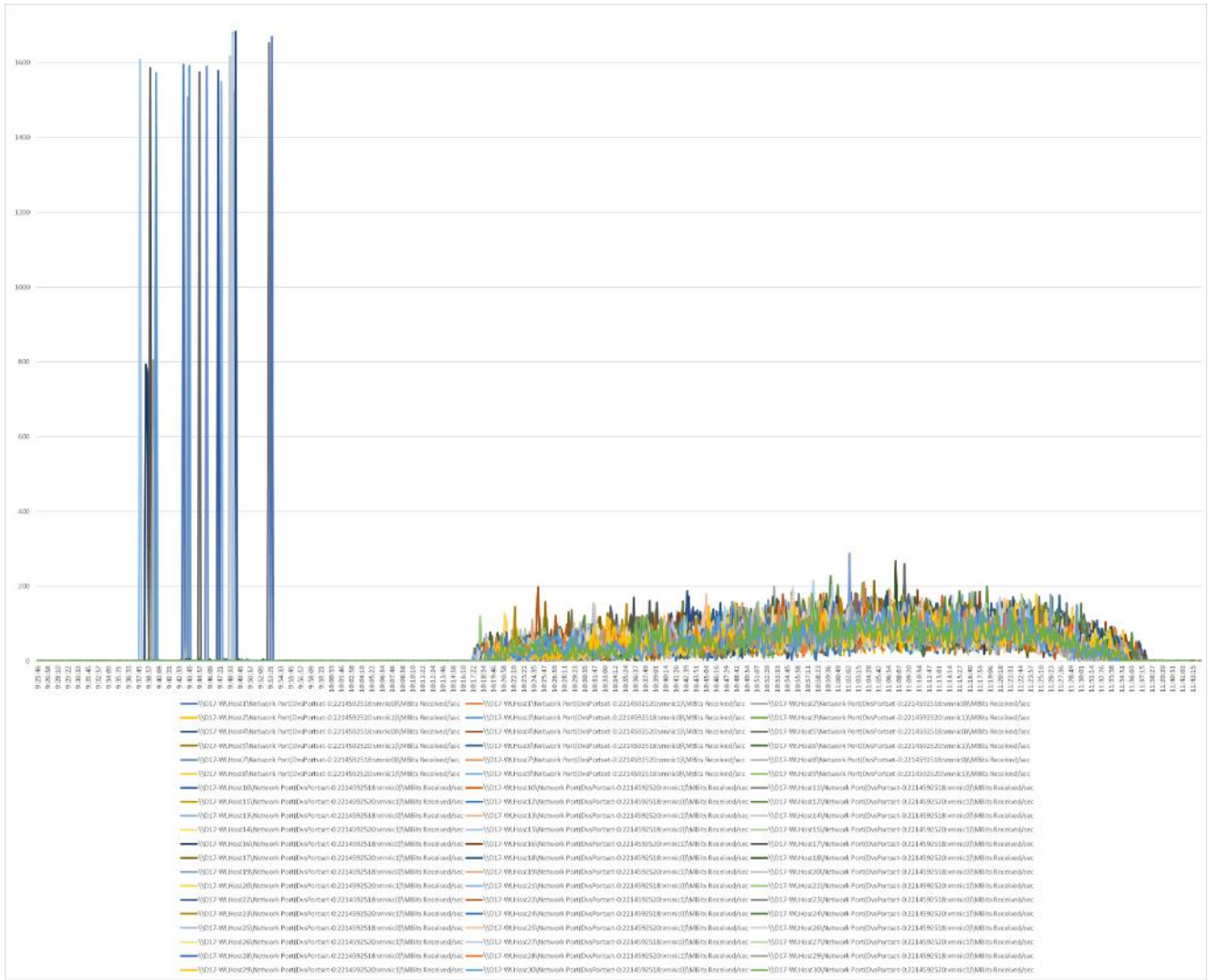
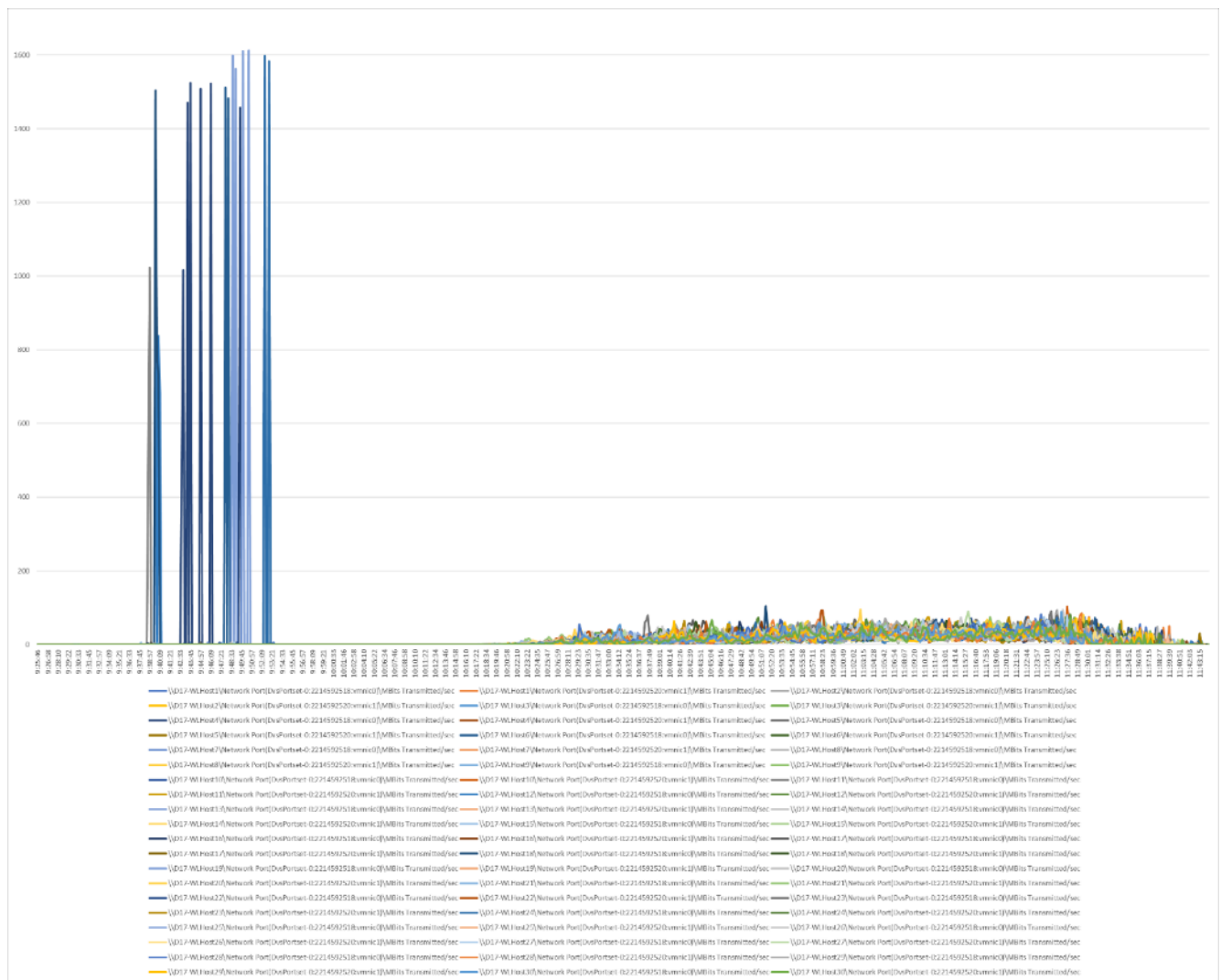

Figure 156. Full Scale | 6048 RDS Users| VDI Host | Host Network Utilization | Transmitted



---

## Feedback

For comments and suggestions about this guide and related guides, join the discussion on [Cisco Community](https://cs.co/en-cvds) at <https://cs.co/en-cvds>.

---

**Americas Headquarters**

Cisco Systems, Inc.  
San Jose, CA

**Asia Pacific Headquarters**

Cisco Systems (USA) Pte. Ltd.  
Singapore

**Europe Headquarters**

Cisco Systems International BV Amsterdam,  
The Netherlands

Cisco has more than 200 offices worldwide. Addresses, phone numbers, and fax numbers are listed on the Cisco Website at <https://www.cisco.com/go/offices>.

Cisco and the Cisco logo are trademarks or registered trademarks of Cisco and/or its affiliates in the U.S. and other countries. To view a list of Cisco trademarks, go to this URL: <https://www.cisco.com/go/trademarks>. Third-party trademarks mentioned are the property of their respective owners. The use of the word partner does not imply a partnership relationship between Cisco and any other company. (1110R)