



User Guide for AsyncOS 13.5.1 for Cisco Cloud Email Security - GD (General Deployment)

First Published: 2020-06-02

Last Modified: 2020-09-01

Americas Headquarters

Cisco Systems, Inc.
170 West Tasman Drive
San Jose, CA 95134-1706
USA
<http://www.cisco.com>
Tel: 408 526-4000
800 553-NETS (6387)
Fax: 408 527-0883

THE SPECIFICATIONS AND INFORMATION REGARDING THE PRODUCTS IN THIS MANUAL ARE SUBJECT TO CHANGE WITHOUT NOTICE. ALL STATEMENTS, INFORMATION, AND RECOMMENDATIONS IN THIS MANUAL ARE BELIEVED TO BE ACCURATE BUT ARE PRESENTED WITHOUT WARRANTY OF ANY KIND, EXPRESS OR IMPLIED. USERS MUST TAKE FULL RESPONSIBILITY FOR THEIR APPLICATION OF ANY PRODUCTS.

THE SOFTWARE LICENSE AND LIMITED WARRANTY FOR THE ACCOMPANYING PRODUCT ARE SET FORTH IN THE INFORMATION PACKET THAT SHIPPED WITH THE PRODUCT AND ARE INCORPORATED HEREIN BY THIS REFERENCE. IF YOU ARE UNABLE TO LOCATE THE SOFTWARE LICENSE OR LIMITED WARRANTY, CONTACT YOUR CISCO REPRESENTATIVE FOR A COPY.

The Cisco implementation of TCP header compression is an adaptation of a program developed by the University of California, Berkeley (UCB) as part of UCB's public domain version of the UNIX operating system. All rights reserved. Copyright © 1981, Regents of the University of California.

NOTWITHSTANDING ANY OTHER WARRANTY HEREIN, ALL DOCUMENT FILES AND SOFTWARE OF THESE SUPPLIERS ARE PROVIDED "AS IS" WITH ALL FAULTS. CISCO AND THE ABOVE-NAMED SUPPLIERS DISCLAIM ALL WARRANTIES, EXPRESSED OR IMPLIED, INCLUDING, WITHOUT LIMITATION, THOSE OF MERCHANTABILITY, FITNESS FOR A PARTICULAR PURPOSE AND NON-INFRINGEMENT OR ARISING FROM A COURSE OF DEALING, USAGE, OR TRADE PRACTICE.

IN NO EVENT SHALL CISCO OR ITS SUPPLIERS BE LIABLE FOR ANY INDIRECT, SPECIAL, CONSEQUENTIAL, OR INCIDENTAL DAMAGES, INCLUDING, WITHOUT LIMITATION, LOST PROFITS OR LOSS OR DAMAGE TO DATA ARISING OUT OF THE USE OR INABILITY TO USE THIS MANUAL, EVEN IF CISCO OR ITS SUPPLIERS HAVE BEEN ADVISED OF THE POSSIBILITY OF SUCH DAMAGES.

Any Internet Protocol (IP) addresses and phone numbers used in this document are not intended to be actual addresses and phone numbers. Any examples, command display output, network topology diagrams, and other figures included in the document are shown for illustrative purposes only. Any use of actual IP addresses or phone numbers in illustrative content is unintentional and coincidental.

All printed copies and duplicate soft copies of this document are considered uncontrolled. See the current online version for the latest version.

Cisco has more than 200 offices worldwide. Addresses and phone numbers are listed on the Cisco website at www.cisco.com/go/offices.

Cisco and the Cisco logo are trademarks or registered trademarks of Cisco and/or its affiliates in the U.S. and other countries. To view a list of Cisco trademarks, go to this URL: <https://www.cisco.com/c/en/us/about/legal/trademarks.html>. Third-party trademarks mentioned are the property of their respective owners. The use of the word partner does not imply a partnership relationship between Cisco and any other company. (1721R)

© 2020 Cisco Systems, Inc. All rights reserved.



CONTENTS

CHAPTER 1

Getting Started with Cisco Email Security 1

- What's New in AsyncOS 13.5.1 1
- Comparison of Web Interfaces, New Web Interface with Legacy Web Interface 4
- Where to Find More Information 6
 - Documentation 6
 - Training 7
 - Cisco Notification Service 7
 - Knowledge Base 8
 - Cisco Support Community 8
 - Cisco Customer Support 8
 - Third Party Contributors 8
 - Cisco Welcomes Your Comments 9
 - Registering for a Cisco Account 9
- Cisco Email Security Appliance Overview 9
 - Supported Languages 10

CHAPTER 2

Accessing the Appliance 11

- Web-based Graphical User Interface (GUI) 11
 - Browser Requirements 11
 - Accessing the GUI 12
 - Factory Default Username and Passphrase 12
 - Centralized Management 12
 - Cloud Administrator - Web Interface Access 13
 - Enhanced User Experience using How-Tos Widget 13
 - Disabling How-Tos Widget on the Appliance 14
- Changing Configuration Settings 14

Configuration Changes	14
Commit or Abandoning Changes	14
Command Line Interface (CLI)	15
Cloud Administrator - CLI Access	15

CHAPTER 3**Setup and Installation 17**

Installation Planning	17
Review Information That Impacts Planning Decisions	17
Plan to Place the Email Security Appliance at the Perimeter of Your Network	17
Register the Email Security Appliance in DNS	18
Installation Scenarios	19
Configuration Overview	19
Incoming	19
Outgoing	19
Ethernet Interfaces	19
Hardware Ports	20
Advanced Configurations	20
Firewall Settings (NAT, Ports)	20
Physically Connecting the Email Security Appliance to the Network	20
Configuration Scenarios	21
Segregating Incoming and Outgoing Mail	21
Preparing for System Setup	24
Determine Method for Connecting to the Appliance	25
Connecting to the Appliance	25
Determining Network and IP Address Assignments	26
Default IP Addresses for Management and Data Ports	26
Choosing Network Connections to Receive and Deliver Email	26
Binding Logical IP Addresses to Physical Ethernet Ports	26
Choosing Network Settings for Your Connections	26
Gathering the Setup Information	27
Using the System Setup Wizard	30
Accessing the Web-Based Graphical User Interface (GUI)	30
Factory Default Username and Passphrase	31
Accessing the Legacy Web Interface	32

Accessing New Web Interface in Dusk Mode	32
Defining Basic Configuration Using the Web-Based System Setup Wizard	32
Step 1: Start	33
Step 2: System	34
Step 3: Network	35
Step 4: Security	39
Step 5: Review	40
Setting up the Connection to Active Directory	40
Proceeding to the Next Steps	41
Accessing the Command Line Interface (CLI)	41
Factory Default Username and Passphrase	41
Running the Command Line Interface (CLI) System Setup Wizard	42
Change the Admin Passphrase	43
Accept the License Agreement	43
Set the Hostname	43
Assign and Configure Logical IP Interface(s)	44
Specify the Default Gateway	44
Enable the Web Interface	45
Configure the DNS Settings	45
Create a Listener	45
Enable Anti-Spam	52
Select a Default Anti-Spam Scanning Engine	53
Enable the Spam Quarantine	53
Enable Anti-Virus Scanning	53
Enable Outbreak Filters	53
Configure the Alert Settings and AutoSupport	54
Configure Scheduled Reporting	54
Configure Time Settings	54
Commit Changes	54
Test the Configuration	54
Immediate Alerts	55
Configuring your system as an Enterprise Gateway	55
Verifying Your Configuration and Next Steps	55

CHAPTER 4**Understanding the Email Pipeline 57**

Overview of the Email Pipeline	57
Email Pipeline Flows	57
Incoming / Receiving	60
Host Access Table (HAT), Sender Groups, and Mail Flow Policies	60
Received: Header	61
Default Domain	61
Bounce Verification	61
Domain Map	61
Recipient Access Table (RAT)	61
Alias Tables	61
LDAP Recipient Acceptance	62
SMTP Call-Ahead Recipient Validation	62
Work Queue / Routing	62
Email Pipeline and Security Services	62
LDAP Recipient Acceptance	63
Masquerading or LDAP Masquerading	63
LDAP Routing	63
Message Filters	64
Email Security Manager (Per-Recipient Scanning)	64
Safelist/Blocklist Scanning	64
Anti-Spam	64
Anti-Virus	64
Graymail Detection and Safe Unsubscribing	65
File Reputation Scanning and File Analysis	65
Content Filters	65
Outbreak Filters	65
Quarantines	65
Delivery	66
Virtual gateways	66
Delivery Limits	66
Domain-Based Limits	66
Domain-Based Routing	67

Global Unsubscribe 67

Bounce Limits 67

CHAPTER 5

Configuring the Gateway to Receive Email 69

Overview of Configuring the Gateway to Receive Email 69

Working with Listeners 70

Configuring Global Settings for Listeners 72

Settings for Messages Containing Multiple Encodings 74

Listening for Connection Requests by Creating a Listener Using Web Interface 75

Partial Domains, Default Domains, and Malformed MAIL FROMs 79

Listening for Connection Requests by Creating a Listener Using CLI 80

Advanced HAT Parameters 81

Enterprise Gateway Configuration 82

CHAPTER 6

IP Reputation Filtering 85

Overview of Sender IP Reputation Filtering 85

IP Reputation Service 85

IP Reputation Score 86

How Sender IP Reputation Filters Work 87

Recommended Settings for Different Sender IP Reputation Filtering Approaches 87

Editing IP Reputation Filtering Score Thresholds for a Listener 88

Testing IP Reputation Filtering Using the IP Reputation Scores 89

Entering Low IP Reputation Scores in the Message Subject 90

CHAPTER 7

Defining Which Hosts Are Allowed to Connect Using the Host Access Table 93

Overview of Defining Which Hosts Are Allowed to Connect 93

Default HAT Entries 94

Defining Remote Hosts into Sender Groups 94

Sender Group Syntax 95

Sender Groups Defined by Network Owners, Domains, and IP Addresses 96

Setting Policies Based on the HAT 97

Defining Sender Groups by IP Reputation Score 98

Sender Groups Defined by Querying DNS Lists 99

Defining Access Rules for Email Senders Using Mail Flow Policies 99

HAT Variable Syntax	100
Using HAT Variables	101
Testing HAT Variables	102
Understanding Predefined Sender Groups and Mail Flow Policies	102
Handling Messages from a Group of Senders in the Same Manner	104
Creating a Sender Group for Message Handling	105
Adding a Sender to an Existing Sender Group	106
Rearranging the Order of the Rules to Perform for Incoming Connections	106
Searching for Senders	107
Defining Rules for Incoming Messages Using a Mail Flow Policy	107
Defining Default Values for Mail Flow Policies	112
Working with the Host Access Table Configuration	112
Exporting the Host Access Table Configuration to an External File	113
Importing the Host Access Table Configuration from an External File	113
Using a List of Sender Addresses for Incoming Connection Rules	114
SenderBase Settings and Mail Flow Policies	114
HAT Significant Bits Feature	115
HAT Configuration	116
Significant Bits HAT Policy Option	116
Injection Control Periodicity	116
Verifying Senders	116
Sender Verification: Host	117
Sender Verification: Envelope Sender	118
Partial Domains, Default Domains, and Malformed MAIL FROMs	119
Custom SMTP Code and Response	119
Sender Verification Exception Table	119
Implementing Sender Verification — Example Settings	119
Throttling Messages from Unverified Senders Using the SUSPECTLIST Sender Group	120
Implementing More Stringent Throttling Settings for Unverified Senders	121
Defining Messages to Send to Unverified Senders Using the ACCEPTED Mail Flow Policy	121
Excluding Unverified Senders from Sender Verification Rules Based on Sender's Email Address	122
Searching for Addresses within the Sender Verification Exception Table	122
Testing Your Settings for Messages from Unverified Senders	122

Sending a Test Message with a Malformed MAIL FROM Sender Address	122
Sending a Message from an Address That is Excluded from Sender Verification Rules	123
Sender Verification and Logging	123
Envelope Sender Verification	124

CHAPTER 8**Accepting or Rejecting Connections Based on Domain Name or Recipient Address 125**

Overview of Accepting or Rejecting Connections Based on the Recipient's Address	125
Overview of the Recipient Access Table (RAT)	126
Accessing the RAT using the GUI	126
Accessing the RAT using the CLI	126
Editing the Default RAT Entry	126
Domains and Users	127
Adding Domains and Users For Which to Accept Messages	127
Defining Recipient Addresses	128
Bypassing LDAP Accept for Special Recipients	128
Bypassing Throttling for Special Recipients	129
Rearranging the Order of Domains and Users in the Recipient Access Table	129
Exporting the Recipient Access Table to an External File	130
Importing the Recipient Access Table from an External File	130

CHAPTER 9**Using Message Filters to Enforce Email Policies 131**

Overview	131
Components of a Message Filter	132
Message Filter Rules	132
Message Filter Actions	132
Message Filter Example Syntax	133
Message Filter Processing	134
Message Filter Order	135
Message Header Rules and Evaluation	135
Message Bodies vs. Message Attachments	135
Thresholds for Matches in Content Scanning	136
Threshold Syntax	137
Threshold Scoring for Message Bodies and Attachments	137
Threshold Scoring Multipart/Alternative MIME Parts	137

Threshold Scoring for Content Dictionaries	138
AND Test and OR Tests in Message Filters	139
Message Filter Rules	139
Filter Rules Summary Table	140
Regular Expressions in Rules	150
Using Regular Expressions to Filter Messages	152
Guidelines for Using Regular Expressions	152
Regular Expression and Non-ASCII Character Sets	152
n Tests	153
Case-sensitivity	153
Writing Efficient Filters	153
PDFs and Regular Expressions	154
Smart Identifiers	154
Smart Identifier Syntax	155
Description and Examples of Message Filter Rules	155
True Rule	156
Valid Rule	157
Subject Rule	157
Envelope Recipient Rule	157
Envelope Recipient in Group Rule	158
Envelope Sender Rule	158
Envelope Sender in Group Rule	159
Sender Group Rule	159
Body Size Rule	159
Remote IP Rule	160
Receiving Listener Rule	160
Receiving IP Interface Rule	161
Date Rule	161
Header Rule	161
Random Rule	162
Recipient Count Rule	163
Address Count Rule	163
Body Scanning Rule	163
Body Scanning	164

Encryption Detection Rule	164
Attachment Type Rule	165
Attachment Filename Rule	165
DNS List Rule	166
IP Reputation Rule	167
Dictionary Rules	167
SPF-Status Rule	169
SPF-Passed Rule	170
S/MIME Gateway Message Rule	171
S/MIME Gateway Verified Rule	171
Workqueue-count Rule	171
SMTP Authenticated User Match Rule	172
Signed Rule	173
Signed Certificate Rule	174
Header Repeats Rule	176
URL Reputation Rules	178
URL Category Rule	179
Corrupt Attachment Rule	179
Message Language Rule	179
Macro Detection Rule	180
Forged Email Detection Rule	181
Duplicate Boundaries Verification Rule	182
Malformed MIME Header Detection Rule	182
Geolocation Rule	183
Domain Reputation Rule for ETF	183
Domain Reputation Rule for SDR	183
Message Filter Actions	185
Filter Actions Summary Table	186
Attachment Groups	192
Action Variables	195
Non-ASCII Character Sets and Message Filter Action Variables	197
Matched Content Visibility	197
Description and Examples of Message Filter Actions	198
Skip Remaining Message Filters Action	199

Drop Action	199
Bounce Action	200
Encrypt Action	200
S/MIME Sign or Encrypt on Delivery Action	200
S/MIME Sign or Encrypt Action	200
Notify and Notify-Copy Actions	201
Blind Carbon Copy Actions	203
Quarantine and Duplicate Actions	205
Alter Recipient Action	206
Alter Delivery Host Action	206
Alter Source Host (Virtual Gateway address) Action	207
Archive Action	207
Strip Header Action	208
Insert Header Action	208
Edit Header Text Action	209
Edit Body Text Action	209
HTML Convert Action	210
Bounce Profile Action	211
Bypass Anti-Spam System Action	211
Bypassing Graymail Actions	212
Bypass Anti-Virus System Action	212
Bypass File Reputation Filtering and File Analysis System Actions	213
Bypass Outbreak Filter Scanning Action	213
Add Message Tag Action	213
Add Log Entry Action	214
URL Reputation Actions	214
URL Category Actions	216
No Operation	217
Forged Email Detection Action	217
Attachment Scanning	217
Message Filters for Scanning Attachments	219
Image Analysis	220
Configuring the Image Analysis Scanning Engine	220
Tuning Image Analysis Settings	221

Configuring the Message Filter to Perform Actions Based on Image Analysis Results	222
Creating Content Filters to Strip Attachments Based on Image Analysis Verdicts	223
Configuring an Action Based on Image Analysis Verdicts	223
Notifications	224
Examples of Attachment Scanning Message Filters	224
Inserting Headers	225
Dropping Attachments by File Type	225
Dropping Attachments by Dictionary Matches	226
Quarantining Protected Attachments	227
Detecting Unprotected Attachments	227
Detecting Malicious Files in Messages Attachments Using Message Filter	227
Using the CLI to Manage Message Filters	228
Creating a New Message Filter	230
Deleting a Message Filter	230
Moving a Message Filter	230
Activating and Deactivating a Message Filter	230
Activating or Deactivating a Message Filter	233
Importing Message Filters	233
Exporting Message Filters	234
Viewing Non-ASCII Character Sets	234
Displaying a Message Filter List	234
Displaying Message Filter Details	235
Configuring Filter Log Subscriptions	235
Changing Message Encoding	236
Sample Message Filters	238
Message Filter Examples	243
Open-Relay Prevention Filter	243
Policy Enforcement Filters	243
Notify Based on Subject Filter	244
BCC and Scan Mail Sent to Competitors	244
Block Specific User Filter	244
Archive and Drop Messages Filter	244
Large “To:” Header Filter	245
Blank “From:” Filter	245

IP Reputation Filter	246
Alter IP Reputation Filter	246
Filename Regex Filter	246
Show IP Reputation Score in Header Filter	246
Insert Policy into Header Filter	246
Too Many Recipients Bounce Filter	247
Routing and Domain Spoofing	247
Using Virtual Gateways Filter	247
Same Listener for Deliver and Listener Filter	247
Single Listener Filter	248
Drop Spoofed Domain Filter (Single Listener)	248
Drop Spoofed Domain Filter (Multiple Listeners)	248
Another Drop Spoofed Domain Filter	248
Detect Looping Filter	249
Configuring Scan Behavior	250
Configuring Message Handling Actions for Unscannable Messages	252
Delivering the Message	253
Sending Message to Policy Quarantine	254

CHAPTER 10
Mail Policies 257

Overview of Mail Policies	257
How to Enforce Mail Policies on a Per-User Basis	258
Handling Incoming and Outgoing Messages Differently	259
Matching Users to a Mail Policy	259
First Match Wins	260
Examples of Policy Matching	260
Example 1	261
Example 2	261
Example 3	261
Message Splintering	261
Managed Exceptions	263
Configuring Mail Policies	263
Configuring the Default Mail Policy for Incoming or Outgoing Messages	263
Creating a Mail Policy for a Group of Senders and Recipients	264

Defining Senders and Recipients for Mail Policies	264
Examples	266
Finding Which Policies Apply to a Sender or Recipient	267
Managed Exceptions	267
Setting Priority for Message Headers	268

CHAPTER 11
Content Filters 271

Overview of Content Filters	271
How Content Filters Work	271
How to Scan Message Content Using a Content Filter	272
Content Filter Conditions	272
Content Filter Actions	280
Action Variables	287
How to Filter Messages Based on Content	289
Creating a Content Filter	289
Enabling Content Filters for All Recipients by Default	290
Applying the Content Filter to Messages for a Certain User Group	291
Notes on Configuring Content Filters in the GUI	291

CHAPTER 12
Configuring Email Gateway to Consume External Threat Feeds 295

Overview of External Threat Feeds	295
How to Configure Email Gateway to Consume External Threat Feeds	296
Obtaining External Threat Feeds Feature Key	296
Enabling External Threat Feeds Engine on Email Gateway	298
Configuring an External Threat Feed Source	298
Handling Messages Containing Threats	301
Configuring a Sender Group for Handling Messages containing Threats	302
Configuring Content or Message Filters for Handling Messages Containing Threats	302
Detecting Malicious Domains in Messages Using Content Filter	303
Creating Domain Exception List	303
Detecting Malicious Domains in Messages Using Message Filter	304
Detecting Malicious URLs in Messages Using Content Filter	304
Detecting Malicious URLs in Messages Using Message Filter	306
Detecting Malicious Files in Message Attachments Using Content Filter	307

- Creating File Hash List 308
- Detecting Malicious Files in Messages Attachments Using Message Filter 308
- Attaching Content Filter to Incoming Mail Policy 309
- External Threat Feeds and Clusters 309
- Monitoring External Threat Feeds Engine Updates 309
- Viewing Alerts 310
- Displaying Threat Details in Message Tracking 310

CHAPTER 13

Sender Domain Reputation Filtering 313

- Overview of Sender Domain Reputation Filtering 313
 - SDR Verdicts 313
 - How to Filter Messages based on Sender Domain Reputation 315
 - Enabling Sender Domain Reputation Filtering on Email Gateway 316
 - Configuring Message or Content Filter for Handling Messages based on Sender Domain Reputation 317
 - Filtering Messages based on Sender Domain Reputation using Message Filter 317
 - Filtering Messages based on Sender Domain Reputation using Content Filter 319
 - Creating Domain Exception List 320
 - Attaching Content Filter to Incoming Mail Policy 320
 - Sender Domain Reputation Filtering and Clusters 321
 - Displaying Sender Domain Reputation Details in Message Tracking 321
 - Viewing Alerts 321
 - Viewing Logs 322
 - Examples of SDR Filtering Log Entries 322
 - Sender Domain Reputation Authentication Failure 322
 - Sender Domain Reputation Request Timeout 322
 - Sender Domain Reputation Invalid Host 323
 - Sender Domain Reputation General Errors 323

CHAPTER 14

Integrating with Cisco Threat Response 325

- Integrating the Appliance with Cisco Threat Response 325
- Performing Threat Analysis using Casebooks 327
 - Obtaining Client ID and Client Password Credentials 328
 - Adding Observable to Casebook for Threat Analysis 329

Improving User Experience of Email Gateway using Cisco Success Network	330
Enabling CSN on Email Gateway	331
Disabling CSN on Email Gateway	332

CHAPTER 15**Configuring Email Gateway to Safe Print Message Attachments 333**

Overview	333
How to Configure Email Gateway to Safe Print Message Attachments	334
Configuring Safe Print Settings on Email Gateway	334
Configuring Content Filter to Safe Print Message Attachments	335
Attaching Content Filter to Incoming Mail Policy	337
Safe Print Settings and Clusters	338
Monitoring Messages with Safe-Printed Attachments	338
Viewing Logs	338
Examples of Safe Print Log Entries	338
Unable to Create Temporary Directory	339
Unable to Create Safe-printed PDF Attachment	339
Corrupt File	339
Encrypted File	339
Timeout Error	339
Displaying Safe Print Details in Message Tracking	339

CHAPTER 16**Anti-Virus 341**

Anti-Virus Scanning Overview	341
Evaluation Key	342
Scanning Messages with Multiple Anti-Virus Scanning Engines	342
Sophos Anti-Virus Filtering	342
Virus Detection Engine	343
Virus Scanning	343
Detection Methods	343
Pattern Matching	343
Heuristics	344
Emulation	344
Virus Descriptions	344
Sophos Alerts	344

- When a Virus is Found 344
- McAfee Anti-Virus Filtering 345
 - Pattern-Matching Virus Signatures 345
 - Encrypted Polymorphic Virus Detection 345
 - Heuristics Analysis 345
 - When a Virus is Found 346
- How to Configure the Appliance to Scan for Viruses 346
 - Enabling Virus Scanning and Configuring Global Settings 347
 - Configuring Virus Scanning Actions for Users 347
 - Message Scanning Settings 348
 - Message Handling Settings 348
 - Configuring Settings for Message Handling Actions 349
 - Configuring the Anti-Virus Policies for Different Groups of Senders and Recipients 352
 - Notes on Anti-Virus Configurations 353
 - Flow Diagram for Anti-Virus Actions 354
- Sending an Email to the Appliance to Test Anti-Virus Scanning 355
- Updating Virus Definitions 357
 - About Retrieving Anti-Virus Updates via HTTP 357
 - Configuring Update Server Settings 357
 - Monitoring and Manually Checking for Anti-Virus Updates 357
 - Manually Updating Anti-Virus Engines 357
 - Verifying Anti-Virus Files Have Updated on the Appliance 358

CHAPTER 17

- Managing Spam and Graymail 359**
 - Overview of Anti-Spam Scanning 359
 - Anti-Spam Solutions 360
 - How to Configure the Appliance to Scan Messages for Spam 360
 - IronPort Anti-Spam Filtering 361
 - Evaluation Key 362
 - Cisco Anti-Spam: an Overview 362
 - Spam Scanning for International Regions 362
 - Configuring IronPort Anti-Spam Scanning 363
 - Configuring Intelligent Multi-Scan and Graymail Detection 365
 - Configuring Cisco Intelligent Multi-Scan 365

Managing Graymail	366
Overview of Graymail	366
Graymail Management Solution in Email Security Appliance	366
How Graymail Management Solution Works	367
Configuring Graymail Detection and Safe Unsubscribing	370
Troubleshooting Graymail Detection and Safe Unsubscribing	375
Configuring Global Settings for Intelligent Multi-Scan and Graymail Detection	375
Defining Anti-Spam Policies	376
Understanding Positive and Suspect Spam Thresholds	378
Configuration Examples: Actions for Positively Identified versus Suspected Spam	379
Unwanted Marketing Messages From Legitimate Sources	379
Using Custom Headers to Redirect URLs in Suspected Spam to the Cisco Web Security Proxy: Configuration Example	380
Enabling Different Anti-Spam Scanning Engines in Different Mail Policies: Configuration Example	381
Protecting Appliance -Generated Messages From the Spam Filter	382
Headers Added During Anti-Spam Scanning	383
Reporting Incorrectly Classified Messages to Cisco	383
How to Report Incorrectly Classified Messages to Cisco	383
How to Report Incorrectly Classified Messages to Cisco	385
Using Cisco Email Security Plug-In	386
Forwarding Incorrectly Classified Message as an Attachment	386
How to Track Your Submissions	388
Determining Sender IP Address In Deployments with Incoming Relays	388
Example Environments with Incoming Relays	389
Configuring the Appliance to Work with Incoming Relays	390
Enabling the Incoming Relays Feature	390
Adding an Incoming Relay	391
Message Headers for Relayed Messages	392
How Incoming Relays Affect Functionality	395
Incoming Relays and Filters	395
Incoming Relays, HAT, IP Reputation Score, and Sender Groups	396
Incoming Relays and Directory Harvest Attack Prevention	396
Incoming Relays and Trace	396

Incoming Relays and Email Security Monitor (Reporting)	396
Incoming Relays and Message Tracking	396
Incoming Relays and Logging	396
Configuring Logs to Specify Which Headers Are Used	397
Monitoring Rules Updates	397
Testing Anti-Spam	398
Sending an Email to the Appliance to Test Cisco Anti-Spam	399
Testing Anti-Spam Configuration: Example Using SMTP	399
Ways Not to Test Anti-Spam Efficacy	400

CHAPTER 18**Outbreak Filters 401**

Overview of Outbreak Filters	401
How Outbreak Filters Work	401
Delaying, Redirecting, and Modifying Messages	402
Threat Categories	402
Virus Outbreaks	403
Phishing, Malware Distribution, and Other Non-Viral Threats	403
Cisco Security Intelligence Operations	403
Context Adaptive Scanning Engine	404
Delaying Messages	404
Redirecting URLs	405
Modifying Messages	406
Types of Rules: Adaptive and Outbreak	406
Outbreak Rules	406
Adaptive Rules	406
Outbreaks	407
Threat Levels	407
Guidelines for Setting Your Quarantine Threat Level Threshold	407
Containers: Specific and Always Rules	408
How the Outbreak Filters Feature Works	408
Message Scoring	409
Dynamic Quarantine	409
Outbreak Lifecycle and Rules Publishing	410
Managing Outbreak Filters	411

Configuring Outbreak Filters Global Settings	412
Enabling the Outbreak Filters Feature	413
Enabling Adaptive Rules	413
Enabling Alerts for Outbreak Filters	413
Enabling Logging of URLs and Message Tracking Details for URLs	413
Outbreak Filters Rules	414
Managing Outbreak Filter Rules	415
The Outbreak Filters Feature and Mail Policies	415
Setting a Quarantine Level Threshold	416
Maximum Quarantine Retention	416
Bypassing File Extension Types	416
Message Modification	417
The Outbreak Filters Feature and the Outbreak Quarantine	419
Monitoring the Outbreak Quarantine	420
Outbreak Quarantine and the Manage by Rule Summary View	420
Monitoring Outbreak Filters	421
Outbreak Filters Report	421
Outbreak Filters Overview and Rules Listing	422
Outbreak Quarantine	422
Alerts, SNMP Traps, and Outbreak Filters	422
Troubleshooting The Outbreak Filters Feature	422
Reporting Incorrectly Classified Messages to Cisco	422
Multiple Attachments and Bypassed Filetypes	423
Message and Content Filters and the Email Pipeline	423

CHAPTER 19

Protecting Against Malicious or Undesirable URLs	425
URL-Related Protections and Controls	425
Which URLs Are Evaluated	426
Setting Up URL Filtering	426
Requirements for URL Filtering	426
Enable URL Filtering	427
About the Connection to Talos Intelligence Services	428
Certificates for URL Filtering Features	428
Web Interaction Tracking	428

Configuring Web Interaction Tracking	429
About the Connection to Cisco Aggregator Server	429
URL Filtering in Cluster Configurations	429
Creating Allowed Lists for URL Filtering	429
Importing a URL List	430
Customizing the Notification That End Users See If a Site Is Malicious	431
Taking Action Based on the Reputation or Category of URLs in Messages	432
Using URL-Related Conditions (Rules) and Actions	432
Filtering by URL Reputation or URL Category: Conditions and Rules	433
Modifying URLs in Messages: Using URL Reputation and URL Category Actions in Filters	434
Redirected URLs: What Does the End User Experience?	435
Handling Unscannable Messages for URL Filtering	436
Detecting Malicious URLs in Messages Using Content Filter	436
Detecting Malicious URLs in Messages Using Message Filter	438
Monitoring URL Filtering Results	439
Displaying URL Details in Message Tracking	439
Troubleshooting URL Filtering	439
Viewing Logs	440
Alert: Beaker Connector: Error Fetching Enrollment Certificate	440
Alert: Beaker Connector: Certificate Is Invalid	440
Unable to Connect to Talos Intelligence Services	441
Alert: Unable to Connect to the Cisco Aggregator Server	441
Alert: Unable to Retrieve Web Interaction Tracking Information from the Cisco Aggregator Server	441
Using the <code>websecurityadvancedconfig</code> Command	442
Message Tracking Search Does Not Find Messages with Specified Category	442
Malicious URLs and Marketing Messages Are Not Caught by Anti-Spam or Outbreak Filters	442
URLs in a Filtered Category Are Not Handled Correctly	442
End User Reaches Malicious Site via Rewritten URL	443
Manually Configuring a Certificate for Communication with Talos Intelligence Services	443
About URL Categories	443
URL Category Descriptions	444
Determining the Category of a URL	456
Reporting Uncategorized and Misclassified URLs	456

Future URL Category Set Changes 456

CHAPTER 20

File Reputation Filtering and File Analysis 457

Overview of File Reputation Filtering and File Analysis	457
File Threat Verdict Updates	457
File Processing Overview	458
Supported Files for File Reputation and Analysis Services	459
Archive or Compressed File Processing	460
Privacy of Information Sent to the Cloud	461
Configuring File Reputation and Analysis Features	461
Requirements for Communication with File Reputation and Analysis Services	461
Configuring an On-premises File Reputation Server	462
Configuring an On-Premises File Analysis Server	462
Enabling and Configuring File Reputation and Analysis Services	463
Integrating the Appliance with AMP for Endpoints Console	467
Important! Changes Needed in File Analysis Setting	469
(Public Cloud File Analysis Services Only) Configuring Appliance Groups	469
Which Appliances Are In the Analysis Group?	470
Configuring the Mail Policy for File Reputation Scanning and File Analysis	471
Quarantining Messages with Attachments Sent for Analysis	473
Using the File Analysis Quarantine	474
Edit File Analysis Quarantine Settings	474
Manually Processing Messages in the File Analysis Quarantine	475
Centralized File Analysis Quarantine	476
X-Headers for File Reputation and Analysis	476
Sending Notifications to End Users about Dropped Messages or Attachments	476
Advanced Malware Protection and Clusters	476
Ensuring That You Receive Alerts About Advanced Malware Protection Issues	477
Configuring Centralized Reporting for Advanced Malware Protection Features	477
File Reputation and File Analysis Reporting and Tracking	478
Identifying Files by SHA-256 Hash	478
File Reputation and File Analysis Report Pages	478
Viewing File Reputation Filtering Data in Other Reports	479
About Message Tracking and Advanced Malware Protection Features	479

Taking Action When File Threat Verdicts Change 480

Troubleshooting File Reputation and Analysis 480

- Log Files 481
- Using Trace 481
- Several Alerts About Failure to Connect to File Reputation or File Analysis Servers 481
- API Key Error (On-Premises File Analysis) 482
- Files are Not Uploaded As Expected 482
- Alerts about File Types That Can Be Sent for Analysis 482

CHAPTER 21

Data Loss Prevention 485

- Overview of Data Loss Prevention 485
 - Overview of the DLP Scanning Process 485
 - How Data Loss Prevention Works 486
- System Requirements for Data Loss Prevention 486
- How to Set Up Data Loss Prevention 487
- Enabling Data Loss Prevention (DLP) 488
- Policies for Data Loss Prevention 488
 - DLP Policy Description 489
 - Predefined DLP Policy Templates 489
 - Setting Up DLP Prevention Using a Wizard 489
 - Creating a DLP Policy Using a Predefined Template 491
 - Creating a Custom DLP Policy (Advanced) 492
 - About Defining Disallowed Content Using Content Matching Classifiers 493
 - Content Matching Classifier Examples 494
 - Creating a Content Matching Classifier for Custom DLP Policies 495
 - Classifier Detection Rules for Identifying Sensitive Content (Custom DLP Policies Only) 496
 - Regular Expressions for Identifying Identification Numbers 497
 - Using Custom Dictionaries of Sensitive DLP Terms (Custom DLP Policies Only) 498
 - Determiners of the Risk Factor of a Suspected Violation 500
 - Using Minimum Score for Entity-based Rules (Custom DLP Policies Only) 502
 - Viewing the Policies in Which Custom Content Classifiers are Used 503
 - Filtering Messages for DLP Policies 503
 - About Assessing Violation Severity 504
 - Adjusting the Severity Scale 504

Arranging the Order of the Email DLP Policies for Violation Matching	505
Associating DLP Policies with Outgoing Mail Policies	505
Associating DLP Policies with the Default Outgoing Mail Policy	505
Using Outgoing Mail Policies to Assign DLP Policies to Senders and Recipients	505
Important Information About Editing or Deleting DLP Policies	506
Message Actions	506
Defining Actions to Take for DLP Violations (Message Actions)	507
Viewing and Editing Message Actions	508
Drafting DLP Notifications	509
DLP Notification Template Variable Definitions	510
Displaying Sensitive DLP Data in Message Tracking	511
About Updating the DLP Engine and Content Matching Classifiers	512
Determining the Current Version of the DLP Engine	512
Updating the DLP Engine and Content Matching Classifiers Manually	512
Enabling Automatic Updates (Not Recommended)	513
DLP Updates on Centralized (Clustered) Appliances	513
Working with DLP Incident Messages and Data	513
Troubleshooting Data Loss Prevention	514
DLP Fails to Detect Violations in Email Attachments	514

CHAPTER 22
Cisco Email Encryption 515

Overview of Cisco Email Encryption	515
How to Encrypt Messages with a Local Key Server	516
Encryption Workflow	516
Encrypting Messages using the Email Security Appliance	517
Enabling Message Encryption on the Email Security Appliance	518
Configuring How a Key Service Handles Encrypted Messages	518
Configuring the Default Locale of the Envelope	521
Updating to the Latest Version of the PXE Engine	522
Determining Which Messages to Encrypt	522
Using a TLS Connection as an Alternative to Encryption	522
Encrypting and Immediately Delivering Messages using a Content Filter	523
Encrypting a Message upon Delivery using a Content Filter	524
Inserting Encryption Headers into Messages	525

Encryption Headers	526
Encryption Headers Examples	527
Enabling Envelope Key Caching for Offline Opening	528
Enabling JavaScript-Free Envelopes	528
Enabling Message Expiration	528
Disabling the Decryption Applet	528

CHAPTER 23
S/MIME Security Services 529

Overview of S/MIME Security Services	529
S/MIME Security Services in Email Security Appliance	529
Understanding How S/MIME Security Services Works	530
Scenario: Business-to-Business	530
Scenario: Business-to-Consumer	532
Signing, Encrypting, or Signing and Encrypting Outgoing Messages using S/MIME	533
S/MIME Signing and Encryption Workflow in Email Security Appliance	533
S/MIME Signing Workflow	533
S/MIME Encryption Workflow	533
How to Sign, Encrypt, or Sign and Encrypt Outgoing Messages using S/MIME	534
Setting Up Certificates for S/MIME Signing	535
Creating a Self-Signed S/MIME Certificate	535
Importing an S/MIME Signing Certificate	536
Setting Up Public Keys for S/MIME Encryption	537
Adding a Public Key for S/MIME Encryption	537
S/MIME Harvested Public Keys	538
Harvesting Public Keys	538
Managing S/MIME Sending Profiles	539
Create an S/MIME Sending Profile for Signing, Encrypting, or Signing and Encrypting Messages	540
Edit an S/MIME Sending Profile	541
Determining Which Messages to Sign, Encrypt, or Sign and Encrypt	541
Signing, Encrypting, or Signing and Encrypting and Immediately Delivering Messages using a Content Filter	542
Signing, Encrypting, or Signing and Encrypting a Message upon Delivery using a Content Filter	542

Verifying, Decrypting, or Decrypting and Verifying Incoming Messages using S/MIME	543
S/MIME Verification and Decryption Workflow in Email Security Appliance	543
S/MIME Verification Workflow	544
S/MIME Decryption Workflow	544
How to Verify, Decrypt, or Decrypt and Verify Incoming Messages Using S/MIME	544
Setting Up Certificates for Decrypting Messages	545
Setting Up Public Keys for Verifying Signed Messages	546
Adding a Public Key for S/MIME Verification	546
Harvesting Public Keys for S/MIME Verification	546
Enabling Public Key Harvesting	547
Adding a Harvested Public Key for S/MIME Verification	547
Enabling S/MIME Decryption and Verification	548
Configuring an Action for S/MIME Decrypted or Verified Message	548
S/MIME Certificate Requirements	549
Certificate Requirements for Signing	549
Certificate Requirements for Encryption	550
Managing Public Keys	550
Adding a Public Key	551
Importing Public Keys from an Existing Export File	551
Exporting Public Keys	552
CHAPTER 24	
Remediating Messages in Mailboxes	553
Overview	553
Workflow	554
How the Appliance Performs Auto-Remedial Actions	555
Performing Remedial Actions on Messages in Mailboxes	556
Performing Remedial Actions on Messages in Microsoft Exchange Online Mailboxes	557
How to Configure Remedial Action on Messages in Microsoft Exchange Online Mailboxes	557
Performing Remedial Actions on Messages in Microsoft Exchange On-Premise Mailboxes	558
How to Configure Remedial Actions on Messages in Microsoft Exchange On-Premise Mailboxes	559
Performing Remedial Actions on Messages in Mailboxes on Hybrid Deployment	560
How to Perform Remedial Actions on Messages in Mailboxes on Hybrid Deployment	560
Configuring Mailbox Remediation on Cisco Email Security Appliance	562

Prerequisites	562
Prerequisites for Remediating Messages in Microsoft Exchange Online Mailboxes	562
Prerequisites for Remediating Messages in an On-Premise Account	563
Registering Your Appliance as an Application on Azure AD	564
Enabling Account Settings on Cisco Email Security Appliance	566
Creating an Account Profile	566
Creating a Chained Profile	568
Mapping Domains to the Account Profile	568
Configure Auto-Remedial Actions on Messages in the Mailboxes	569
Search and Remediate Messages in the Mailboxes	570
Upgrading to AsyncOS 13.0 and Later Releases	571
Monitoring Mailbox Remediation Results	571
Viewing Mailbox Remediation Details in Message Tracking	572
Troubleshooting Mailbox Remediation	572
Connection Errors	572
Viewing Logs	574
Alerts	574
Configured Remedial Actions Are Not Performed	574

CHAPTER 25
Email Authentication 577

Email Authentication Overview	577
DomainKeys and DKIM Authentication	577
DomainKeys and DKIM Authentication Workflow	578
DomainKeys and DKIM Signing in AsyncOS	578
Configuring DomainKeys and DKIM Signing	579
Signing Keys	580
Exporting and Importing Signing Keys	580
Public Keys	580
Domain Profiles	581
Exporting and Importing Domain Profiles	582
Enabling Signing for Outgoing Mail	582
Enabling Signing for Bounce and Delay Messages	582
Configuring DomainKeys/DKIM Signing (GUI)	583
Creating Domain Profiles for DomainKeys Signing	583

Creating a New Domain Profile for DKIM Signing	584
Creating or Editing a Signing Key	586
Exporting Signing Keys	587
Importing or Entering Existing Signing Keys	587
Deleting Signing Keys	588
Generating a DNS Text Record	588
Testing Domain Profiles	589
Exporting Domain Profiles	589
Importing Domain Profiles	590
Deleting Domain Profiles	590
Searching Domain Profiles	591
Editing DKIM Global Settings	591
Domain Keys and Logging	591
How to Verify Incoming Messages Using DKIM	592
DKIM Verification Checks Performed by AsyncOS	592
Managing DKIM Verification Profiles	593
Creating a DKIM Verification Profile	594
Exporting DKIM Verification Profiles	595
Importing DKIM Verification Profiles	595
Deleting DKIM Verification Profiles	595
Searching DKIM Verification Profiles	596
Configuring DKIM Verification on the Mail Flow Policy	596
DKIM Verification and Logging	597
Configuring an Action for DKIM Verified Mail	597
Overview of SPF and SIDF Verification	597
A Note About Valid SPF Records	598
Valid SPF Records	598
Valid SIDF Records	598
Testing Your SPF Records	599
How to Verify Incoming Messages Using SPF/SIDF	599
Enabling SPF and SIDF	600
Enabling SPF and SIDF via the CLI	601
The Received-SPF Header	603
Determining the Action to Take for SPF/SIDF Verified Mail	604

Verification Results	604
Using the spf-status Filter Rule in the CLI	605
spf-status Content Filter Rule in the GUI	606
Using the spf-passed Filter Rule	606
Testing the SPF/SIDF Results	607
Basic Granularity Test of SPF/SIDF Results	607
Greater Granularity Test of SPF/SIDF Results	607
DMARC Verification	608
DMARC Verification Workflow	609
How to Verify Incoming Messages Using DMARC	609
Managing DMARC Verification Profiles	610
Configure Global DMARC Settings	612
Configuring DMARC Verification on the Mail Flow Policy	613
Configure a Return Address for DMARC Feedback Reports	614
DMARC Aggregate Reports	614
Forged Email Detection	616
Setting Up Forged Email Detection	616
Monitoring Forged Email Detection Results	617
Displaying Forged Email Detection Details in Message Tracking	618

CHAPTER 26
Text Resources 619

Overview of Text Resources	619
Content Dictionaries	619
Text Resources	620
Message Disclaimer Stamping	620
Content Dictionaries	620
Dictionary Content	621
Word Boundaries and Double-byte Character Sets	622
Importing and Exporting Dictionaries as Text Files	622
Adding Dictionaries	623
Deleting Dictionaries	624
Importing Dictionaries	624
Exporting Dictionaries	625
Using and Testing the Content Dictionaries Filter Rules	625

Dictionary Match Filter Rule	625
Example Dictionary Entries	626
Testing Content Dictionaries	626
Understanding Text Resources	627
Importing and Exporting Text Resources as Text Files	627
Overview of Text Resource Management	628
Adding Text Resources	628
Deleting Text Resources	628
Importing Text Resources	629
Exporting Text Resources	629
Overview of HTML-Based Text Resources	630
Importing and Exporting HTML-Based Text Resources	630
Using Text Resources	631
Disclaimer Template	631
Adding Disclaimer Text via a Listener	632
Adding Disclaimers via Filters	632
Disclaimers and Filter Action Variables	632
Disclaimer Stamping and Multiple Encodings	634
Notification Templates	636
Anti-Virus Notification Templates	637
Custom Anti-Virus Notification Templates	637
Bounce and Encryption Failure Notification Templates	639
Bounce and Encryption Failure Notification Variables	640
Encryption Notification Templates	640
CHAPTER 27	Validating Recipients Using an SMTP Server
	643
Overview of SMTP Call-Ahead Recipient Validation	643
SMTP Call-Ahead Recipient Validation Workflow	643
How to Validate Recipients Using an External SMTP Server	645
Configuring the Call-Ahead Server Profile	645
SMTP Call-Ahead Server Profile Settings	645
Call Ahead Server Responses	647
Enabling a Listener to Validate Incoming Mail Via the SMTP Server	648
Configuring LDAP Routing Query Settings	648

SMTP Call-Ahead Query Routing	649
Bypassing SMTP Call-Ahead Validation for Certain Users or Groups	649

CHAPTER 28**Encrypting Communication with Other MTAs 651**

Overview of Encrypting Communication with Other MTAs	651
How to Encrypt SMTP Conversations using TLS	651
Working with Certificates	652
Deploying a Signed Certificate	653
Deploying Self-Signed Certificates	653
Certificates and Centralized Management	654
Intermediate Certificates	654
Creating a Self-Signed Certificate	654
About Sending a Certificate Signing Request (CSR) to a Certificate Authority	655
Uploading a Certificate Signed by a Certificate Authority	656
Importing a Certificate	656
Exporting a Certificate	657
Enabling TLS on a Listener's HAT	657
Assigning a Certificate to a Public or Private Listener for TLS Connections Using the GUI	658
Assigning a Certificate to a Public or Private Listener for TLS Connections Using the CLI	659
Logging	659
GUI Example: Changing the TLS setting for Listeners HAT	659
CLI Example: Changing the TLS Setting for Listeners HAT	659
Enabling TLS and Certificate Verification on Delivery	660
Sending Alerts When a Required TLS Connection Fails	662
Enabling TLS Connection Alerts	663
Logging	663
DNS-based Authentication of Named Entities	663
Overview of SMTP DNS-based Authentication of Named Entities	664
SMTP DANE Workflow	664
Creating TLSA Record	665
Enabling TLS for Delivery with DANE Support	666
Sending Alerts When DANE Fails	667
Enabling DANE Alerts	667
Managing Lists of Certificate Authorities	667

Viewing the Pre-Installed list of Certificate Authorities	668
Disabling the System Certificate Authority List	668
Importing a Custom Certificate Authority List	669
Exporting a Certificate Authorities List	669
Enabling a Certificate for HTTPS	669

CHAPTER 29
Configuring Routing and Delivery Features 671

Routing Email for Local Domains	671
SMTP Routes Overview	672
Default SMTP Route	672
Defining an SMTP Route	673
SMTP Routes Limits	673
SMTP Routes and DNS	673
SMTP Routes and Alerts	674
SMTP Routes, Mail Delivery, and Message Splintering	674
SMTP Routes and Outbound SMTP Authentication	674
Managing SMTP Routes to Send Outbound Email Using the GUI	674
Adding SMTP Routes	674
Exporting SMTP Routes	675
Importing SMTP Routes	675
Rewriting Addresses	676
Creating Alias Tables	677
Configuring an Alias Table from the Command Line	677
Exporting and Importing an Alias Table	678
Deleting Entries from the Alias Table	679
Example Alias Table	679
Example aliasconfig Command	681
Configuring Masquerading	684
Masquerading and altsrhost	685
Configuring Static Masquerading Tables	685
Sample Masquerading Table for a Private Listener	686
Importing a Masquerading Table	687
Example Masquerading	687
The Domain Map Feature	694

Importing and Exporting a Domain Map Table	699
Directing Bounced Email	700
Handling Undeliverable Email	701
Notes on Soft and Hard Bounces	701
Bounce Profile Parameters	702
Hard Bounces and the status Command	705
Conversational Bounces and SMTP Routes Message Filter actions	705
Example Bounce Profiles	705
Delivery Status Notification Format	706
Delay Warning Messages	706
Delay Warning Messages and Hard Bounces	706
Creating a New Bounce Profile	707
Editing the Default Bounce Profile	707
Example of a Minimalist Bounce Profile	707
Applying Bounce Profiles to Listeners	707
Controlling Email Delivery Using Destination Controls	708
Rate Limiting	709
TLS	709
Bounce Verification	709
Bounce Profile	709
Determining Which Interface is Used for Mail Delivery	709
Default Delivery Limits	710
Working with Destination Controls	710
Controlling the Version of Internet Protocol Addresses	710
Controlling the Number of Connections, Messages, and Recipients to a Domain	710
Controlling TLS	712
Controlling Bounce Verification Tagging	712
Controlling Bounces	712
Adding a New Destination Control Entry	712
Importing and Exporting Destination Control Configurations	713
Destination Controls and the CLI	716
Bounce Verification	716
Overview: Tagging and Bounce Verification	717
Handling Incoming Bounce Messages	717

Bounce Verification Address Tagging Keys	718
Accepting Legitimate Untagged Bounced Messages	718
Preventing a Bounced Message Storm Using Bounce Verification	718
Configuring Bounce Verification Address Tagging Keys	719
Configuring Bounce Verification Settings	719
Configuring Bounce Verification Using the CLI	720
Bounce Verification and Cluster Configuration	720
Set Email Delivery Parameters	720
Default Delivery IP Interface	720
Possible Delivery Feature	721
Default Maximum Concurrency	721
deliveryconfig Example	721
Configuring Mail Gateways for all Hosted Domains Using Virtual Gateway™ Technology	723
Overview	723
Setting Up Virtual Gateway Addresses	723
Creating New IP Interfaces for Use with Virtual Gateways	724
Mapping Messages to IP Interfaces for Delivery	726
Importing an altsrghost File	727
altsrghost Limits	728
Example Text File with Valid Mappings for the altsrghost Command	728
Adding an altsrghost Mapping through the CLI	728
Monitoring the Virtual Gateway Addresses	730
Managing Delivery Connections per Virtual Gateway Address	731
Using Global Unsubscribe	731
Adding a Global Unsubscribe Address Using The CLI	732
Exporting and Importing a Global Unsubscribe File	734
Review: Email Pipeline	734

CHAPTER 30**Integrating the Email Gateway with Cisco Advanced Phishing Protection 739**

Overview of Cisco Advanced Phishing Protection	739
Benefits of Cisco Advanced Phishing Protection	740
Workflow	740
How to Integrate Email Gateway with the Cisco Advanced Phishing Protection Cloud Service	740
Prerequisites	741

Activating the Account for Cisco Advanced Phishing Protection Cloud Service	741
Installing Sensors on the Cisco Advanced Phishing Protection Cloud Service	741
Obtaining the Provisioning Key from the Cisco Advanced Phishing Protection Cloud Service	742
Registering the Cisco Advanced Phishing Protection Sensor on the Email Gateway	742
Enabling Advanced Phishing Protection on the Email Gateway	743
Obtaining API Access Keys from Cisco Advanced Phishing Protection Cloud Service	744
Configuring Incoming Mail Policies to Enable Forwarding of Message Metadata	745
Monitoring Message Metadata on the Cisco Advanced Phishing Protection Cloud Service	746
Advanced Phishing Protection and Clusters	746
Advanced Phishing Protection Report Page	746
Monitoring Message Metadata on the Cisco Advanced Phishing Protection Cloud Service	747
Displaying Messages Submitted to the Cisco Advanced Phishing Protection Cloud Service	747

CHAPTER 31**LDAP Queries 749**

Overview of LDAP Queries	749
Understanding LDAP Queries	750
Understanding How LDAP Works with AsyncOS	751
Configuring the Cisco IronPort Appliance to Work with an LDAP Server	752
Creating LDAP Server Profiles to Store Information About the LDAP Server	753
Testing LDAP Servers	754
Enabling LDAP Queries to Run on a Particular Listener	754
Configuring Global Settings for LDAP Queries	754
Example of Creating an LDAP Server Profile	755
Enabling LDAP Queries on a Public Listener	756
Enabling LDAP Queries on a Private Listener	756
Enhanced Support for Microsoft Exchange 5.5	757
Working with LDAP Queries	759
Types of LDAP Queries	759
Base Distinguishing Name (DN)	760
LDAP Query Syntax	760
Tokens:	760
Secure LDAP (SSL)	761
Routing Queries	761
Allowing Clients to Bind to the LDAP Server Anonymously	761

Anonymous Authentication Setup	762
Anonymous Bind Setup for Active Directory	763
Notes for Active Directory Implementations	764
Testing LDAP Queries	764
Troubleshooting Connections to LDAP Servers	765
Using Acceptance Queries For Recipient Validation	766
Sample Acceptance Queries	766
Configuring Acceptance Queries for Lotus Notes	767
Using Routing Queries to Send Mail to Multiple Target Addresses	767
Sample Routing Queries	767
Routing: MAILHOST and MAILROUTINGADDRESS	768
Using Masquerading Queries to Rewrite the Envelope Sender	768
Sample Masquerading Queries	768
Masquerading “Friendly Names”	769
Using Group LDAP Queries to Determine if a Recipient is a Group Member	770
Sample Group Queries	770
Configuring a Group Query	770
Example: Using a Group Query to Skip Spam and Virus Checking	772
Using Domain-based Queries to Route to a Particular Domain	773
Creating a Domain-Based Query	774
Using Chain Queries to Perform a Series of LDAP Queries	774
Creating a Chain Query	775
Using LDAP For Directory Harvest Attack Prevention	776
Directory Harvest Attack Prevention within the SMTP Conversation	776
Directory Harvest Attack Prevention within the Work Queue	777
Configuring Directory Harvest Prevention in the Work Queue	778
Configuring AsyncOS for SMTP Authentication	778
Configuring SMTP Authentication	779
Specifying a Passphrase as Attribute	779
Configuring an SMTP Authentication Query	780
SMTP Authentication via Second SMTP Server (SMTP Auth with Forwarding)	781
SMTP Authentication with LDAP	781
Enabling SMTP Authentication on a Listener	782
Authenticating SMTP Sessions Using Client Certificates	785

- Outgoing SMTP Authentication **785**
- Logging and SMTP Authentication **786**
- Configuring External LDAP Authentication for Users **786**
 - User Accounts Query **787**
 - Group Membership Queries **787**
- Authenticating End-Users of the Spam Quarantine **789**
 - Sample Active Directory End-User Authentication Settings **789**
 - Sample OpenLDAP End-User Authentication Settings **790**
- Spam Quarantine Alias Consolidation Queries **790**
 - Sample Active Directory Alias Consolidation Settings **791**
 - Sample OpenLDAP Alias Consolidation Settings **791**
- Sample User Distinguished Name Settings **792**
- Configuring AsyncOS To Work With Multiple LDAP Servers **792**
- Performing Recipient Verification and Resolving Group Queries using Azure AD Domain Services **793**
- Testing Servers and Queries **793**
 - Failover **793**
 - Configuring the Appliance for LDAP Failover **794**
 - Load Balancing **794**
 - Configuring the Appliance for Load Balancing **795**

CHAPTER 32

- Authenticating SMTP Sessions Using Client Certificates **797****
 - Overview of Certificates and SMTP Authentication **797**
 - How to Authenticate a User with a Client Certificate **798**
 - How to Authenticate a User with an SMTP Authentication LDAP Query **798**
 - How to Authenticate a User with an LDAP SMTP Authentication Query if the Client Certificate is Invalid **799**
 - Checking the Validity of a Client Certificate **799**
 - Authenticating a User Using an LDAP Directory **800**
 - Authenticating an SMTP Connection Over TLS Using a Client Certificate **801**
 - Establishing a TLS Connection from the Appliance **801**
 - Updating a List of Revoked Certificates **802**
 - Authenticating a User’s SMTP Session With a Client Certificate **803**
 - Authenticating a User’s SMTP Session with the SMTP AUTH Command **803**

Authenticating a User's SMTP Session with Either a Client Certificate or SMTP AUTH 804

CHAPTER 33**Using Email Security Monitor 807**

Email Security Monitor Overview 807

Email Security Monitor and Centralized Management 808

Email Security Monitor Pages 808

Searching and Email Security Monitor 810

Viewing Details of Messages Included in Reports 810

My Dashboard Page 811

Overview Page 812

System Overview 812

Incoming and Outgoing Summary and Graph 813

Categorizing Email 814

How Messages are Categorized 815

Incoming Mail Page 815

Incoming Mail 816

Incoming Mail Details Listing 817

Reporting Pages Populated with Data: Sender Profile Pages 818

Sender Groups Report 820

Sender Domain Reputation Page 820

Outgoing Destinations 821

Outgoing Senders 821

Geo Distribution Page 822

Delivery Status Page 822

Retrying Delivery 823

Delivery Status Details Page 823

Internal Users Page 823

Internal User Details 824

Searching for a Specific Internal User 824

DLP Incidents Page 824

DLP Incidents Details 825

DLP Policy Detail Page 825

Content Filters Page 825

Content Filter Details 826

DMARC Verification Page	826
Macro Detection Page	826
External Threat Feeds Page	827
Outbreak Filters Page	827
Virus Types Page	829
URL Filtering Page	829
Web Interaction Tracking Page	830
Forged Email Matches Report	831
File Reputation and File Analysis Reports	831
Mailbox Auto Remediation Report	831
TLS Connections Page	831
Inbound SMTP Authentication Page	832
Rate Limits Page	833
System Capacity Page	833
System Capacity- Workqueue	834
System Capacity- Incoming Mail	835
System Capacity-Outgoing Mail	835
System Capacity-System Load	835
Note about Memory Page Swapping	836
System Capacity- All	836
System Status Page	836
System Status	836
Gauges	837
Rates	837
Counters	837
High Volume Mail Page	838
Message Filters Page	838
Safe Print Page	839
Retrieving CSV Data	839
Retrieving CSV Data Via Automated Processes	839
Email Security Monitor Pages on the New Web Interface	841
Searching and the Interactive Email Report Pages	842
Viewing Details of Messages Included in Reports	843
Time Range for Reports	844

My Favorite Reports Page	844
Modules That Cannot Be Added to the My Reports Page	845
Adding Reports on the My Favorite Reports Page	845
Mail Flow Summary Page	846
How Email Messages Are Categorized by the Appliances	848
Incoming and Outgoing Summary and Graph	849
Categorizing Email Messages on the Mail Flow Summary Page	849
Using Counters to Filter Data on the Trend Graphs	851
System Capacity Page	851
System Capacity- Workqueue	852
System Capacity- Incoming Mail	853
System Capacity-Outgoing Mail	853
System Capacity-System Load	853
Note about Memory Page Swapping	854
System Capacity- All	854
Reporting Data Availability	854
Advanced Malware Protection Page	855
Advanced Malware Protection – Summary	855
Advanced Malware Protection – AMP Reputation	856
Advanced Malware Protection – File Analysis	857
Advanced Malware Protection – File Retrospection	857
Advanced Malware Protection – Mailbox Auto Remediation	858
Identifying Files by SHA-256 Hash	859
Viewing File Reputation Filtering Data in Other Reports	859
Virus Filtering Page	859
Macro Detection Page	859
DMARC Verification Page	860
URL Filtering Page	860
Outbreak Filtering Page	861
Forged Email Detection Page	862
Sender Domain Reputation Page	863
External Threat Feeds Page	863
Mail Flow Details Page	864
Views Within the Mail Flow Details Page	865

- Incoming Mails Table **867**
- Sender Profile Pages **869**
- Sender Details Table **870**
- Sender Groups Report **871**
- Outgoing Destinations **871**
- TLS Encryption Page **871**
- Inbound SMTP Authentication Page **872**
- Rate Limits Page **873**
- Connections by Country Page **873**
- User Mail Summary Page **874**
 - User Mail Flow Details **875**
 - Searching for a Specific Internal User **875**
- DLP Incident Summary Page **875**
 - DLP Incident Details **876**
 - DLP Policy Detail Page **876**
- Web Interaction Page **876**
- Remediation Report Page **878**
- Message Filters Page **879**
- High Volume Mail Page **879**
- Content Filters Page **880**
 - Content Filter Details **880**
- Safe Print Page **880**
- Advanced Phishing Protection Report Page **880**
- Reporting Overview **881**
 - Scheduled or Archived Report Types **881**
 - Notes on Reports **882**
 - Setting the Return Address for Reports **883**
- Managing Reports **883**
 - Scheduled Reports **883**
 - Scheduling a Report to be Generated Automatically **883**
 - Editing Scheduled Reports **884**
 - Deleting Scheduled Reports **884**
 - Archived Reports **885**
 - Generating On-Demand Reports **885**

Troubleshooting Email Reports	886
Link to Message Tracking Gives Unexpected Results	886
File Analysis Details in the Cloud Are Incomplete	886

CHAPTER 34**Tracking Messages 887**

Message Tracking Overview	887
Enabling Message Tracking	887
Searching for Messages on the Legacy Interface	888
Searching for Email Messages on the New Web Interface	891
Working with Message Tracking Search Results	893
Message Tracking Details	894
Checking Message Tracking Data Availability	896
About Message Tracking and Upgrades	897
Troubleshooting Message Tracking	897
Attachments Do Not Appear in Search Results	897
Expected Messages Are Missing from Search Results	897

CHAPTER 35**Policy, Virus, and Outbreak Quarantines 899**

Overview of Policy, Virus, and Outbreak Quarantines	899
Quarantine Types	900
Managing Policy, Virus, and Outbreak Quarantines	901
Disk Space Allocation for Policy, Virus, and Outbreak Quarantines	901
Retention Time for Messages in Quarantines	902
Default Actions for Automatically Processed Quarantined Messages	903
Checking the Settings of System-Created Quarantines	903
Configuring Policy, Virus, and Outbreak Quarantines	903
About Editing Policy, Virus, and Outbreak Quarantine Settings	905
Determining the Filters and Message Actions to Which a Policy Quarantine Is Assigned	905
About Deleting Policy Quarantines	906
Monitoring Quarantine Status, Capacity, and Activity	906
Policy Quarantine Performance	907
Alerts About Quarantine Disk-Space Usage	908
Policy Quarantines and Logging	908
About Distributing Message Processing Tasks to Other Users	908

- Which User Groups Can Access Policy, Virus, and Outbreak Quarantines 908
- About Policy, Virus, and Outbreak Quarantines in Cluster Configurations 909
- About Centralized Policy, Virus, and Outbreak Quarantines 909
- Working with Messages in Policy, Virus, or Outbreak Quarantines 909
 - Viewing Messages in Quarantines 910
 - Quarantined Messages and International Character Sets 910
 - Finding Messages in Policy, Virus, and Outbreak Quarantines 910
 - Manually Processing Messages in a Quarantine 911
 - Sending a Copy of the Message 912
 - About Moving Messages Between Policy Quarantines 912
 - Messages in Multiple Quarantines 913
 - Message Details and Viewing Message Content 913
 - Viewing Matched Content 914
 - Downloading Attachments 915
 - Testing for Viruses 915
 - About Rescanning of Quarantined Messages 915
 - The Outbreak Quarantine 916
 - Rescanning Messages in an Outbreak Quarantine 916
 - Manage by Rule Summary Link 917
 - Reporting False Positives or Suspicious Messages to Cisco Systems 917

CHAPTER 36

Spam Quarantine 919

- Overview of the Spam Quarantine 919
- Local Versus External Spam Quarantine 919
- Setting Up the Local Spam Quarantine 920
 - Enabling and Configuring the Spam Quarantine on the Legacy Web Interface 921
 - Configuring the IP Interface for Browser Access to the Spam Quarantine 922
 - Configuring Administrative User Access to the Spam Quarantine 923
 - Configuring a Mail Policy to Quarantine Spam 924
 - Limiting Which Recipients Have Mail Quarantined 924
 - Ensuring That Message Text Displays Correctly 924
 - Specifying a Default Encoding 924
 - Spam Quarantine Language 925
- Using Safelists and Blocklists to Control Email Delivery Based on Sender 925

Message Processing of Safelists and Blocklists	925
Enabling Safelists and Blocklists on the Legacy Web Interface	926
External Spam Quarantine and Safelist/Blocklists	927
Adding Senders and Domains to Safelists and Blocklists (Administrators)	927
Syntax for Safelists and Blocklist Entries	931
Clearing All Safelists and Blocklists	932
About End-User Access to Safelists and Blocklists	932
Adding Entries to Safelists (End Users)	932
Adding Senders to Blocklists (End Users)	933
Synchronizing Safelists or Blocklists on Multiple Email Security Appliances (Deployments Without a Security Management Appliance)	934
Backing Up and Restoring the Safelist/Blocklist	934
Troubleshooting Safelists and Blocklists	935
Message from Safelisted Sender Was Not Delivered	935
Configuring Spam Management Features for End Users	936
Authentication Options for End Users Accessing Spam Management Features	936
LDAP Authentication Process	937
IMAP/POP Authentication Process	937
Setting Up End-User Access to the Spam Quarantine via Web Browser	938
Configuring End-User Access to the Spam Quarantine	938
Determining the URL for End-User Access to the Spam Quarantine	939
Which Messages an End User Sees	940
Notifying End Users About Quarantined Messages	940
Recipient Email Mailing List Aliases and Spam Notifications	943
Testing Notifications	943
Troubleshooting Spam Notifications	943
Managing Messages in the Spam Quarantine	944
Accessing the Spam Quarantine (Administrative Users)	944
Searching for Messages in the Spam Quarantine	945
Searching Very Large Message Collections	945
Viewing Messages in the Spam Quarantine	945
Delivering Messages in the Spam Quarantine	946
Deleting Messages from the Spam Quarantine	946
Disk Space for the Spam Quarantine	946

About Disabling the External Spam Quarantine	947
Troubleshooting Spam Quarantine Features	947

CHAPTER 37

Distributing Administrative Tasks	949
Working with User Accounts	949
User Roles	950
Managing Users	951
Adding Users	952
Editing Users	952
Force Users To Change Their Passphrases	953
Deleting Users	953
Controlling Access to Sensitive Information in Message Tracking	953
Managing Cisco Cloud Email Security	954
The Cloud Administrator	956
The Cloud Operator	957
Cloud DLP Admin	957
Cloud Help Desk	957
Cloud Guest	957
Managing Custom User Roles for Delegated Administration	957
Account Privileges Page	958
Assigning Access Privileges	959
Mail Policies and Content Filters	960
DLP Policies	961
Email Reporting	961
Message Tracking	962
Trace	962
Quarantines	962
Encryption Profiles	963
Defining a Custom User Role	963
Defining a Custom User Role When Adding a User Account	963
Updating Responsibilities for a Custom User Role	964
Editing a Custom User Role	964
Duplicating a Custom User Role	964
Deleting a Custom User Role	965

Passphrases	965
Changing Your Passphrase	965
Locking and Unlocking a User Account	966
Configuring Restrictive User Account and Passphrase Settings	966
Cloud User Accounts	967
External Authentication	970
Enabling LDAP Authentication	971
Enabling RADIUS Authentication	972
Enable SAML Authentication	973
Configuring Access to the Email Security Appliance	974
Configuring IP-Based Network Access	975
Direct Connections	975
Connecting Through a Proxy	975
Important Precautions When Restricting Network Access	975
Creating the Access List	976
Configuring Session Timeouts	977
Configuring the Web UI Session Timeout	977
Configuring the CLI Session Timeout	978
Displaying Messages to Administrative Users	978
Displaying a Message Before Login	978
Displaying a Message After Login	979
Managing Secure Shell (SSH) Keys	979
Example: Install a New Public Key	979
Example: Edit SSH Server Configuration	980
Remote SSH Command Execution	981
Monitoring Administrative User Access	981

CHAPTER 38**System Administration 983**

Management of the Appliance	983
Shutting Down or Rebooting the Appliance	984
Suspending Email Receiving and Delivery	984
Resuming Suspended Email Receiving and Delivery	985
Resetting to Factory Defaults	985
Next Steps	986

Displaying the Version Information for AsyncOS	986
Email Security Appliance Licensing	986
Feature Keys	986
Adding and Managing Feature Keys	986
Automating Feature Key Download and Activation	987
Expired Feature Keys	988
Smart Software Licensing	988
Overview	988
Enabling Smart Software Licensing	990
Registering the Appliance with Cisco Smart Software Manager	990
Requesting for Licenses	991
Deregistering the Appliance from Smart Cisco Software Manager	992
Reregistering the Appliance with Smart Cisco Software Manager	992
Changing Transport Settings	992
Renewing Authorization and Certificate	993
Alerts	993
Updating Smart Agent	994
Smart Licensing in Cluster Mode	994
Cisco Email Security Virtual ApplianceVirtual Email Gateway License	994
Virtual Appliance License Expiration	994
Managing the Configuration File	995
Managing Multiple Appliances with XML Configuration Files	995
Managing Configuration Files	995
Saving and Exporting the Current Configuration File	996
Mailing the Configuration File	997
Loading a Configuration File	997
Resetting the Current Configuration	999
Viewing the Configuration File	999
Configuration File Page	1000
Managing Disk Space	1000
(Virtual Appliances Only) Increasing Available Disk Space	1000
Viewing and Allocating Disk Space Usage	1001
Managing Disk Space for the Miscellaneous Quota	1001
Ensuring That You Receive Alerts About Disk Space	1002

Disk Space and Centralized Management	1002
Managing Security Services	1002
Manually Updating the Engines	1003
Rollback to Previous Version of Engine	1003
Viewing Logs	1003
Service Updates	1003
Setting Up to Obtain Upgrades and Updates	1004
Options for Distributing Upgrades and Updates	1004
Configuring Your Network to Download Upgrades and Updates from the Cisco Servers	1004
Configuring the Appliance for Upgrades and Updates in Strict Firewall Environments	1005
Upgrading and Updating from a Local Server	1005
Hardware and Software Requirements for Upgrading and Updating from a Local Server	1006
Hosting an Upgrade Image on a Local Server	1007
Updates Through a Proxy Server	1007
Configuring Server Settings for Downloading Upgrades and Updates	1008
Configuring Automatic Updates	1010
Configuring the Appliance to Verify the Validity of Updater Server Certificate	1010
Configuring the Email Gateway to Trust Proxy Server Communication	1011
Upgrading AsyncOS	1012
About Upgrading Clustered Systems	1012
About Batch Commands for Upgrade Procedures	1012
Notifications of Available Upgrades	1012
Notifications of Available Upgrades	1013
Preparing to Upgrade AsyncOS	1013
Downloading and Installing the Upgrade	1013
Viewing Status of, Canceling, or Deleting a Background Download	1016
Enabling Remote Power Cycling	1016
Reverting to a Previous Version of AsyncOS	1017
Reversion Impact	1017
Reverting AsyncOS on Virtual Appliances May Impact the License	1018
Reverting AsyncOS	1018
Configuring the Return Address for Appliance Generated Messages	1019
Setting Thresholds for System Health Parameters	1019
Checking the Health of Appliance	1020

Alerts	1021
Alert Severities	1021
AutoSupport	1021
Alert Delivery	1022
Example Alert Message	1022
Adding Alert Recipients	1022
Configuring Alert Settings	1023
Alert Settings	1024
Viewing Recent Alerts	1024
Alert Descriptions	1024
Anti-Spam Alerts	1025
Anti-Virus Alerts	1025
Directory Harvest Attack Prevention (DHAP) Alerts	1026
Hardware Alerts	1026
Spam Quarantine Alerts	1027
Safelist/Blocklist Alerts	1028
System Alerts	1029
Updater Alerts	1040
Outbreak Filter Alerts	1040
Clustering Alerts	1041
Changing Network Settings	1043
Changing the System Hostname	1044
Configuring Domain Name System (DNS) Settings	1044
Specifying DNS Servers	1044
Multiple Entries and Priority	1044
Using the Internet Root Servers	1045
Reverse DNS Lookup Timeout	1045
DNS Alert	1046
Clearing the DNS Cache	1046
Configuring DNS Settings via the Graphical User Interface	1046
Configuring TCP/IP Traffic Routes	1046
Configuring the Default Gateway	1047
Configuring SSL Settings	1047
Single Sign-On (SSO) Using SAML 2.0	1048

About Single Sign-On (SSO) and SAML 2.0	1049
SAML 2.0 SSO Workflow	1049
Guidelines and Limitations for SAML 2.0	1050
General	1050
Logout	1051
Limitations	1051
How to Configure SSO on your Appliance	1051
Prerequisites	1051
Configuring Appliance as a Service Provider	1052
Configuring the Identity Provider to Communicate with Appliance	1055
Configure Identity Provider Settings on Appliance	1057
System Time	1058
Selecting a Time Zone	1058
Selecting a GMT Offset	1059
Editing Time Settings	1059
(Recommended) Setting Appliance System Time Using the Network Time Protocol (NTP)	1059
Setting Appliance System Time Manually	1059
Customizing Your View	1060
Using Favorite Pages	1060
Setting User Preferences	1060
General Settings	1061
Overriding Internet Explorer Compatibility Mode	1061
Collecting Usage Statistics of the Appliance on the New Web Interface	1062
Configuring Maximum HTTP Header Size	1062
Restarting and Viewing Status of Service Engines	1062
<hr/>	
CHAPTER 39	Managing and Monitoring Using the CLI 1063
Overview of Managing and Monitoring Using the CLI	1063
Reading the Available Components of Monitoring	1064
Reading the Event Counters	1064
Reading the System Gauges	1066
Reading the Rates of Delivered and Bounced Messages	1068
Monitoring Using the CLI	1069
Monitoring the Email Status	1069

Example	1070
Monitoring Detailed Email Status	1070
Example	1071
Monitoring the Status of a Mail Host	1072
Virtual Gateway	1073
Example	1073
Determining the Make-up of the Email Queue	1074
Example	1074
Displaying Real-time Activity	1075
Example	1075
Example	1076
Monitoring Inbound Email Connections	1076
Example	1077
Checking the DNS Status	1077
Example	1078
Resetting Email Monitoring Counters	1078
Example	1079
Identifying Active TCP/IP Services	1079
Managing the Email Queue	1079
Deleting Recipients in Queue	1079
Example	1079
Bouncing Recipients in Queue	1080
Example	1081
Redirecting Messages in Queue	1081
Example	1081
Showing Messages Based on Recipient in Queue	1082
Example	1082
Suspending Email Delivery	1082
Example	1083
Resuming Email Delivery	1083
Syntax	1083
Suspending Receiving Email	1083
Syntax	1084
Resuming Receiving Email	1084

	Syntax	1084
	Resuming Delivery and Receiving of Email	1084
	Syntax	1085
	Scheduling Email for Immediate Delivery	1085
	Syntax	1085
	Pausing the Work Queue	1085
	Locating and Archiving Older Messages	1086
	Syntax	1087
	Syntax	1087
	Tracking Messages Within the System	1087
	Monitoring System Health and Status Using SNMP	1088
	MIB Files	1089
	Hardware Objects	1089
	Hardware Traps	1089
	SNMP Traps	1090
	Example: snmpconfig Command	1090
<hr/>		
CHAPTER 40	Improving Phishing Detection Efficacy using Service Logs	1093
	Overview	1093
	Enabling Service Logs on Appliance	1093
	Disabling Service Logs on Appliance	1094
	Frequently Asked Questions	1094
	What data do I share?	1094
	What does Cisco do to make sure that the data I share is secure?	1095
	Will sharing data impact the performance of my Cisco appliances ?	1096
	Are there other ways I can share data?	1096
<hr/>		
CHAPTER 41	Other Tasks in the GUI	1097
	The Graphical User Interface (GUI)	1097
	Enabling the GUI on an Interface	1097
	System Information in the GUI	1098
	Gathering XML status from the GUI	1098
<hr/>		
CHAPTER 42	Advanced Network Configuration	1099

Media Settings on Ethernet Interfaces	1099
Using etherconfig to Edit Media Settings on Ethernet Interfaces	1099
Example of Editing Media Settings	1099
Network Interface Card Pairing/Teaming	1100
NIC Pairing and VLANs	1101
NIC Pair Naming	1101
NIC Pairing and Existing Listeners	1101
Enabling NIC Pairing via the etherconfig Command	1101
Virtual Local Area Networks (VLANs)	1103
About Configuring VLANs	1103
Managing VLANs	1104
Creating a New VLAN via the etherconfig Command	1104
Creating an IP Interface on a VLAN via the interfaceconfig Command	1105
Configuring VLANs Using the Web Interface	1107
Direct Server Return	1107
Enabling Direct Server Return	1107
Enabling the Loopback Interface via the etherconfig Command	1108
Creating an IP Interface on Loopback via the interfaceconfig Command	1109
Creating a Listener on the New IP Interface	1110
Ethernet Interface's Maximum Transmission Unit	1111
Accept or Reject ARP Replies with a Multicast Address	1112

CHAPTER 43**Logging 1113**

Overview	1113
Understanding Log Files and Log Subscriptions	1113
Log Types	1113
Log Type Characteristics	1117
Log Retrieval Methods	1120
Log Filenames and Directory Structure	1121
Log Rollover and Transfer Schedule	1121
Logs Enabled by Default	1122
Log Types	1122
Timestamps in Log Files	1122
Using Text Mail Logs	1123

Interpreting a Text Mail Log	1123
Examples of Text Mail Log Entries	1125
Message received based on Sender's Country of Origin	1131
Maximum URLs in Message Attachments Exceeds URL Scan Limit	1131
Maximum URLs in Message Body Exceeds URL Scan Limit	1131
Malicious Shortened URL redirected to Cisco Proxy Server	1131
Unable to Expand Shortened URL in Message	1132
Log Entry for Malicious URL in Message Attachment	1132
Message marked as Unscannable due to Extraction Failure	1132
Message marked as Unscannable due to RFC Violation	1133
Log Entries for Generated or Re-Written Messages	1133
Messages Sent to the Spam Quarantine	1133
Example of External Threat Feeds Mail Logs	1134
Examples of SDR Filtering Log Entries	1134
Cisco Advanced Phishing Protection Cloud Service Expired	1136
Reminder about Cisco Advanced Phishing Protection Cloud Service Expiry Date	1136
No API Access UID and API Access Secret Key	1136
Invalid API Access UID or API Access Secret Key	1136
Using Delivery Logs	1136
Examples of Delivery Log Entries	1138
Using Bounce Logs	1139
Examples of Bounce Log Entries	1139
Using Status Logs	1140
Reading Status Logs	1140
Using Domain Debug Logs	1143
Domain Debug Log Example	1143
Using Injection Debug Logs	1143
Injection Debug Log Example	1144
Using System Logs	1145
System Log Example	1145
Using CLI Audit Logs	1145
CLI Audit Log Example	1145
Using FTP Server Logs	1146
FTP Server Log Example	1146

Using HTTP Logs	1147
HTTP Log Example	1147
Using NTP Logs	1148
NTP Log Example	1148
Using Scanning Logs	1148
Scanning Log Example	1148
Using Anti-Spam Logs	1149
Anti-Spam Log Example	1149
Using Graymail Logs	1149
Graymail Log Example	1149
Using Anti-Virus Logs	1150
Anti-Virus Log Example	1150
Using AMP Engine Logs	1150
Examples of AMP Engine Log Entries	1150
Using Spam Quarantine Logs	1155
Spam Quarantine Log Example	1155
Using Spam Quarantine GUI Logs	1155
Spam Quarantine GUI Log Example	1155
Using LDAP Debug Logs	1156
LDAP Debug Log Example	1156
Using Safelist/Blocklist Logs	1157
Safelist/Blocklist Log Example	1158
Using Reporting Logs	1158
Reporting Log Example	1158
Using Reporting Query Logs	1159
Reporting Query Log Example	1159
Using Updater Logs	1160
Updater Log Example	1160
Updater Log Example	1161
Understanding Tracking Logs	1161
Using Authentication Logs	1162
Authentication Log Example	1162
Using Configuration History Logs	1162
Configuration History Log Example	1162

Using External Threat Feeds Engine Logs	1163
Example of External Threat Feeds Engine Logs	1163
Using Consolidated Event Logs	1164
Using CSN Logs	1170
Using Advanced Phishing Protection Logs	1171
Log Subscriptions	1171
Configuring Log Subscriptions	1171
Log Levels	1172
Creating a Log Subscription in the GUI	1173
Editing Log Subscriptions	1173
Configuring Global Settings for Logging	1174
Logging Message Headers	1175
Configuring Global Settings for Logging Using the GUI	1175
Rolling Over Log Subscriptions	1176
Rollover By File Size	1176
Rollover By Time	1176
Rolling Over Log Subscriptions on Demand	1178
Viewing Recent Log Entries in the GUI	1178
Viewing Recent Log Entries in the CLI (tail Command)	1178
Example	1179
Configuring Host Keys	1180

CHAPTER 44

Centralized Management Using Clusters	1183
Overview of Centralized Management Using Clusters	1183
Cluster Requirements	1184
Cluster Organization	1184
Initial Configuration Settings	1185
Creating and Joining a Cluster	1186
The clusterconfig Command	1186
Joining an Existing Cluster	1187
Joining an Existing Cluster over SSH	1187
Joining an Existing Cluster over CCS	1188
Joining an Existing Cluster over SSH with Pre-Shared Keys	1190
Adding Groups	1192

- Managing Clusters **1192**
 - Administering a Cluster from the CLI **1192**
 - Copying and Moving Settings **1193**
 - Experimenting with New Configurations **1193**
 - Leaving a Cluster Permanently (Removal) **1194**
 - Upgrading Machines in a Cluster **1194**
 - CLI Command Support **1195**
 - All Commands Are Cluster-aware **1195**
 - The commit and clearchanges Commands **1195**
 - New Operation Added **1196**
 - Restricted Commands **1196**
- Administering a Cluster from the GUI **1197**
- Cluster Communication **1200**
 - DNS and Hostname Resolution **1200**
 - Clustering, Fully Qualified Domain Names, and Upgrading **1200**
 - Cluster Communication Security **1201**
 - Cluster Consistency **1201**
 - Disconnect/Reconnect **1202**
 - Interdependent Settings **1203**
- Loading a Configuration in Clustered Appliances **1204**
- Best Practices and Frequently Asked Questions **1206**
 - Best Practices **1206**
 - Copy vs Move **1206**
 - Good CM Design Practices **1206**
 - Best Practices for Accessing Spam or Policy Quarantines in Cluster Setup **1207**
 - Procedures: Configuring an Example Cluster **1207**
 - Summary of GUI Options for Using CM Settings Other Than the Cluster Default **1209**
 - Setup and Configuration Questions **1209**
 - General Questions **1210**
 - Network Questions **1210**
 - Planning and Configuration **1211**

CHAPTER 45

Testing and Troubleshooting 1213

- Debugging Mail Flow Using Test Messages: Trace **1213**

Using the Listener to Test the Appliance	1219
Example	1220
Troubleshooting the Network	1222
Testing the Network Connectivity of the Appliance	1223
Troubleshooting	1224
Troubleshooting the Listener	1227
Troubleshooting Email Delivery From the Appliance	1229
Troubleshooting Performance	1231
Web Interface Appearance and Rendering Issues	1232
Responding to Alerts	1232
Troubleshooting Alerts That Miscellaneous Disk Usage is Approaching the Quota	1232
Troubleshooting Hardware Issues	1232
Remotely Resetting Appliance Power	1232
Working with Technical Support	1233
Technical Support for Virtual Appliances	1233
Opening or Updating a Support Case From the Appliance	1234
Enabling Remote Access for Cisco Technical Support Personnel	1234
Enabling Remote Access to Appliances With an Internet Connection	1235
Enabling Remote Access to Appliances Without a Direct Internet Connection	1235
Disabling a Tech Support Tunnel	1236
Disabling Remote Access	1236
Checking the Status of the Support Connection	1236
Running a Packet Capture	1237

CHAPTER 46
Optimizing the Appliance for Outbound Mail Delivery Using D-Mode 1239

Feature Summary: D-Mode for Optimized Outbound Delivery	1239
Features Unique to D-Mode-Enabled Appliances	1239
Standard Features Disabled in D-Mode-Enabled Appliances	1240
Standard Features Applicable to D-Mode-Enabled Appliances	1240
Setting Up the Appliance for Optimized Outbound Mail Delivery	1241
Configuring Resource-Conserving Bounce Settings	1241
Example of Enabling Resource-Conserving Bounce Settings	1241
Sending Bulk Mail Using IronPort Mail Merge (IPMM)	1242
Overview of IronPort Mail Merge	1242

- Benefits of the Mail Merge Function 1242
- Using Mail Merge 1242
 - SMTP Injection 1242
 - Variable Substitution 1243
 - Reserved Variables 1243
 - Example Message 1 1244
 - Part Assembly 1244
 - Example Message 2, Part 1 1244
 - Example Message 2, Part 2 1244
 - IPMM and DomainKeys Signing 1245
- Command Descriptions 1245
 - XMRG FROM 1245
 - XDFN 1245
 - XPRT 1245
- Notes on Defining Variables 1246
- Example IPMM Conversation 1246
 - Example Code 1248

CHAPTER 47

Centralizing Services on a Cisco Content (M-Series) Security Management Appliance 1249

- Overview of Cisco Content Security Management Appliance Services 1249
- Network Planning 1250
- Working with an External Spam Quarantine 1250
 - Mail Flow and External Spam Quarantine 1250
 - Migrating from a Local Spam Quarantine to an External Quarantine 1251
 - Enabling an External Spam Quarantine and External Safelist/Blocklist 1251
 - Disabling the Local Spam Quarantine to Activate the External Quarantine 1252
 - Troubleshooting an External Spam Quarantine 1253
- About Centralizing Policy, Virus, and Outbreak Quarantines 1253
 - Centralized Policy, Virus, and Outbreak Quarantines 1253
 - Restrictions and Limitations of Centralized Policy, Virus, and Outbreak Quarantines 1253
 - Requirements for Centralized Policy, Virus, and Outbreak Quarantines in Cluster Configurations 1254
 - About Migration of Policy, Virus, and Outbreak Quarantines 1254
 - Centralizing Policy, Virus, and Outbreak Quarantines 1255

About Disabling Centralized Policy, Virus, and Outbreak Quarantines	1256
Disabling Centralized Policy, Virus, and Outbreak Quarantines	1257
Troubleshooting Centralized Policy, Virus, and Outbreak Quarantines	1257
Configuring Centralized Reporting	1257
Requirements for Advanced Malware Protection Reporting	1258
Availability of Reporting Information after Changing to Centralized Reporting	1258
About Disabling Centralized Reporting	1258
Configuring Centralized Message Tracking	1258
Using Centralized Services	1259

APPENDIX A	FTP, SSH, and SCP Access	1261
	IP Interfaces	1261
	How AsyncOS Selects Default IP Interface	1262
	Configuring FTP Access to the Email Security Appliance	1262
	Secure Copy (scp) Access	1264
	Accessing the Email Security appliance via a Serial Connection	1265
	Pinout Details for the Serial Port in 80- and 90- Series Hardware	1265
	Pinout Details for the Serial Port in 70-Series Hardware	1266

APPENDIX B	Assigning Network and IP Addresses	1267
	Ethernet Interfaces	1267
	Selecting IP Addresses and Netmasks	1267
	Sample Interface Configurations	1268
	IP Addresses, Interfaces, and Routing	1268
	Summary	1269
	Strategies for Connecting Your Content Security Appliance	1269

APPENDIX C	Example of Mail Policies and Content Filters	1271
	Overview of Incoming Mail Policies	1271
	Accessing Mail Policies	1271
	Enabled, Disabled, and “Not Available”	1272
	Configuring the Default Anti-Spam Policies for Incoming Messages	1273
	Creating a Mail Policy for a Group of Sender and Recipients	1274
	Default, Custom, and Disabled	1277

Creating Mail Policies for Different Groups of Senders and Recipients 1277

Creating Mail Policies for Different Groups of Senders and Recipients 1278

Finding Senders or Recipients in Mail Policies 1280

 Managed Exceptions 1280

Filtering Messages Based on Content 1281

 Quarantining Message with “Confidential” in the Subject 1281

 Stripping MP3 Attachments from Messages 1282

 Bouncing Messages Sent to a Former Employee 1282

Applying Individual Content Filters to Different Groups of Recipients 1283

 Enabling Content Filters for All Recipients by Default 1284

 Allowing MP3 Attachments for Recipients in Engineering 1284

Notes on Configuring Content Filters in the GUI 1285

APPENDIX D

Firewall Information 1289

 Firewall Information 1289

 Protecting Email Gateway from Network Attacks 1293

APPENDIX E

End User License Agreement 1295

 Cisco Systems End User License Agreement 1295

 Supplemental End User License Agreement for Cisco Systems Content Security Software 1301



CHAPTER 1

Getting Started with Cisco Email Security

This chapter contains the following sections:

- [What's New in AsyncOS 13.5.1, on page 1](#)
- [Comparison of Web Interfaces, New Web Interface with Legacy Web Interface , on page 4](#)
- [Where to Find More Information, on page 6](#)
- [Cisco Email Security Appliance Overview, on page 9](#)

What's New in AsyncOS 13.5.1

Table 1: Whats New in AsyncOS 13.5.1

Feature	Description
Search and Remediate Messages in the Mailboxes	You can now configure your appliance to remediate the messages manually using the Search and Remediate feature. This feature provides the capability to search for the messages using the Message Tracking filter and apply remedial action on the messages. For more information, see Remediating Messages in Mailboxes, on page 553 .
Improving User Experience of Cisco Email Security Gateway using Cisco Success Network	<p>You can use the Cisco Success Network (CSN) feature to send your appliance and feature usage details to Cisco. These details are used by Cisco to identify the appliance version and the features activated but not enabled on your appliance.</p> <p>The ability to send your appliance and feature usage details to Cisco helps an organization to:</p> <ul style="list-style-type: none">• Improve the effectiveness of the product in user networks by performing analytics on collected telemetry data and suggesting users with recommendations using a digital campaign.• Improve user experience with Cisco Email Security gateway. <p>For more information, see Integrating with Cisco Threat Response, on page 325.</p>

Feature	Description
New Cisco Talos Email Status Portal	<p>The Cisco Talos Email Status Portal replaces the legacy Cisco Email Submission and Tracking Portal.</p> <p>The Cisco Talos Email Status Portal is a web-based tool for monitoring the status of email submissions from Cisco users.</p> <p>Important</p> <ul style="list-style-type: none"> • Users of the legacy portal can still access their previous submissions in the new portal • You will not be able to submit samples of spam/phish, ham, marketing or non-marketing emails that may have been mis-identified by your email gateway in the new portal. For more information on how to submit email samples, see the Cisco Talos Email Status Portal Help page at https://talosintelligence.com/tickets/email_submissions/help <p>For more information, see Managing Spam and Graymail, on page 359.</p>
Accessing New Web Interface of Appliance in Dusk Mode	<p>Dusk Mode is a reversed color scheme that utilizes light-colored typography, UI elements, and iconography on dark backgrounds.</p> <p>You can now access the new web interface of your appliance using the dusk mode.</p> <p>For more information, see Setup and Installation, on page 17.</p>
Ability to connect appliance to Cisco Threat Response using proxy server	<p>You can now connect your appliance to Cisco Threat Response using a proxy server.</p> <p>You can configure a proxy server in any one of the following ways:</p> <ul style="list-style-type: none"> • Security Services > Service Updates page in the web interface. • <code>updateconfig > setup</code> sub command in the CLI. <p>For more information, see, System Administration, on page 983.</p>

Feature	Description
Integrating the Cisco Email Security Gateway with Cisco Advanced Phishing Protection cloud service	<p>The Cisco Advanced Phishing Protection engine on the Cisco Email Security Gateway checks the unique behavior of all legitimate senders, based on the historic email traffic sent to your organization. The cloud service interface of Cisco Advanced Phishing Protection provides risk analysis to distinguish good messages from potentially malicious messages.</p> <p>The Cisco Advanced Phishing Protection cloud service relies on the email gateway as a sensor engine to receive a copy of the message metadata sent inbound into your organization. This sensor engine collects metadata such as message headers from the email gateway and relays them to the Cisco Advanced Phishing Protection cloud service for analysis. After the analysis, potentially malicious messages are remediated from the recipient mailbox automatically based on the pre-configured policies on the Cisco Advanced Phishing Protection cloud service.</p> <p>The ability to use the Cisco Email Security Gateway as a sensor engine helps an organization to:</p> <ul style="list-style-type: none"> • Identify, investigate, and remediate threats, observed on the message headers from the recipient mailbox. • View the reporting data of the metadata of the message from multiple email gateways in your organization. • Send real-time alerts to the end-users about malicious messages. <p>For more information, see Integrating the Email Gateway with Cisco Advanced Phishing Protection, on page 739.</p>
Improve Phishing Detection Efficacy using Service Logs	<p>The Service Logs is sent to the Cisco Talos Cloud service to improve Phishing detection.</p> <p>For more information, see Improving Phishing Detection Efficacy using Service Logs, on page 1093.</p>
Improved Phishing Efficacy	<p>The Cisco Email Security appliance now provides an improved IP Reputation and URL Reputation services for faster and better Phishing catch rates.</p>
Note	<p>If you have configured an HTTP proxy server, the IP Reputation and URL Reputation services, and Service Logs will directly connect to the Internet to get the IP and URL reputations. If you want to use proxy for these services, then configure the HTTPS proxy server on your email gateway.</p> <p>Note If you have configured an HTTPS proxy server, make sure that you do not configure the proxy server to decrypt the HTTPS traffic originating from your email gateway.</p>

Comparison of Web Interfaces, New Web Interface with Legacy Web Interface

The following table shows the comparison of the new web interface with the legacy interface:

Table 2: Comparison of New Web Interface with legacy interface

Web Interface Page or Element	New Web Interface	Legacy Web Interface
Landing Page	After you log in to the appliance , the Mail Flow Summary page is displayed.	After you log in to the appliance, the My Dashboard page is displayed.
Reports Drop-down	You can view reports for your appliances from the Reports drop-down.	You can view reports for your appliance from the Monitor menu.
My Reports Page	Choose My Reports from the Reports drop-down.	You can view the My Reports page from Monitor > My Dashboard .
Mail Flow Summary Page	The Mail Flow Summary page includes trend graphs and summary tables for incoming and outgoing messages.	The Incoming Mail includes graphs and summary tables for the incoming and outgoing messages.
Advanced Malware Protection Report Pages	The following sections are available on the Advanced Malware Protection report page of the Reports menu: <ul style="list-style-type: none"> • Summary • AMP File Reputation • File Analysis • File Retrospection • Mailbox Auto Remediation 	The appliance has the following Advanced Malware Protection report pages under Monitor menu: <ul style="list-style-type: none"> • Advanced Malware Protection • AMP File Analysis • AMP Verdict Updates • Mailbox Auto Remediation
Outbreak Filters Page	The Past Year Virus Outbreaks and Past Year Virus Outbreak Summary are not available in the Outbreak Filtering report page of the new web interface.	The Monitor > Outbreak Filters page displays the Past Year Virus Outbreaks and Past Year Virus Outbreak Summary.

Web Interface Page or Element	New Web Interface	Legacy Web Interface
Spam Quarantines (Administrative and End Users)	<p>Click Quarantine > Spam Quarantine > Search in the new web interface.</p> <p>The end users can access the spam quarantine using the URL:</p> <p><code>https://example.com:<https-api-port>/url-login</code></p> <p>where <code>example.com</code> is the appliance hostname and <code><https-api-port></code> is the AsyncOS API HTTPS port opened on the firewall.</p>	You can view spam quarantine from the Monitor > Spam Quarantine menu.
Policy, Virus and Outbreak Quarantines	<p>Click Quarantine > Other Quarantine in the new web interface.</p> <p>You can only view Policy, Virus and Outbreak Quarantines in the new web interface.</p>	You can view, configure and modify the Policy, Virus and Outbreak Quarantines on the appliance using the Monitor > Policy, Virus and Outbreak Quarantines .
Select All Action for Messages in Quarantine	You can select multiple (or all) messages and perform a message action such as delete, delay, release, move, etc.	You cannot select multiple messages to perform a message action.
Maximum Download Limit for Attachments	The maximum limit for downloading attachments of a quarantined message is restricted to 25 MB.	-
Rejected Connections	To search for rejected connections, click Tracking > Search > Rejected Connection tab on the .	-
Query Settings	The Query Settings field of the Message Tracking feature is not available on the .	You can set the query timeout in the Query Settings field of the Message Tracking feature.
Message Tracking Data Availability	Click the gear icon on the upper right side of the page the web interface to access Message Tracking Data Availability page.	You can view the missing-data intervals for your appliance .
Show Additional Details of Messages	You can view additional details of a message such as Verdict Charts, Last State, Sender Groups, Sender IP, IP Reputation Score and Policy Match details.	-

Web Interface Page or Element	New Web Interface	Legacy Web Interface
Verdict Charts and Last State Verdicts	Verdict Chart displays information of the various possible verdicts triggered by each engine in your appliance . Last State of the message determines the final verdict triggered after all the possible verdicts of the engine.	Verdict Charts and Last State Verdicts of the messages are not available.
Message Attachments and Host Names in Message Details	Message attachments and host names are not displayed in the Message Details section of the message on the appliance.	Message attachments and host names are displayed in the Message Details section of the message.
Sender Groups, Sender IP, IP Reputation Score and Policy Match in Message Details	Sender Groups, Sender IP, IP Reputation Score, and Policy Match details of the message is displayed in the Message Details section, on the appliance.	Sender Groups, Sender IP, IP Reputation Score, and Policy Match of the message is not available in the Message Details section of the message.
Direction of the Message (Incoming or Outgoing)	Direction of the message (incoming or outgoing) is displayed in the message tracking results page, on the appliance.	Direction of the message (incoming or outgoing) is not displayed in the message tracking results page.

Where to Find More Information

Cisco offers the following resources to learn more about your appliance :

- [Documentation](#) , on page 6
- [Training](#), on page 7
- [Cisco Notification Service](#) , on page 7
- [Knowledge Base](#), on page 8
- [Cisco Support Community](#), on page 8
- [Cisco Customer Support](#), on page 8
- [Third Party Contributors](#), on page 8
- [Cisco Welcomes Your Comments](#), on page 9
- [Registering for a Cisco Account](#) , on page 9

Documentation

You can access the online help version of this user guide directly from the appliance GUI by clicking Help and Support in the upper-right corner.

The documentation set for the Cisco Email Security appliances includes the following documents and books:

- Release Notes

- Quick Start Guide for your Cisco Email Security Appliance model
- Hardware Installation or Hardware installation and maintenance guide for your model or series
- *Cisco Content Security Virtual Appliance Installation Guide*
- *User Guide for AsyncOS for Cisco Email Security Appliances* (this book)
- *CLI Reference Guide for AsyncOS for Cisco Email Security Appliances*
- AsyncOS API for Cisco Email Security Appliances - Getting Started Guide

Documentation for all Cisco Content Security products is available from:

Documentation For Cisco Content Security Products	Location
Hardware and virtual appliances	See the applicable product in this table.
Cisco Email Security	http://www.cisco.com/c/en/us/support/security/email-security-appliance/tsd-products-support-series-home.html
Cisco Web Security	http://www.cisco.com/c/en/us/support/security/web-security-appliance/tsd-products-support-series-home.html
Cisco Content Security Management	http://www.cisco.com/c/en/us/support/security/content-security-management-appliance/tsd-products-support-series-home.html
CLI reference guide for Cisco Content Security appliances	http://www.cisco.com/c/en/us/support/security/email-security-appliance/products-command-reference-list.html
Cisco IronPort Encryption	http://www.cisco.com/c/en/us/support/security/email-security-appliance/products-command-reference-list.html

Training

More information about training is available from:

- <http://www.cisco.com/c/en/us/training-events/training-certifications/supplemental-training/email-and-web-security.html>
- <http://www.cisco.com/c/en/us/training-events/training-certifications/overview.html>

Cisco Notification Service

Sign up to receive notifications relevant to your Cisco Content Security Appliances, such as Security Advisories, Field Notices, End of Sale and End of Support statements, and information about software updates and known issues.

You can specify options such as notification frequency and types of information to receive. You should sign up separately for notifications for each product that you use.

To sign up, visit <http://www.cisco.com/cisco/support/notifications.html>

A Cisco.com account is required. If you do not have one, see [Registering for a Cisco Account](#), on page 9.

Knowledge Base

Procedure

- Step 1** Go to the main product page (<http://www.cisco.com/c/en/us/support/security/email-security-appliance/tsd-products-support-series-home.html>)
- Step 2** Look for links with **TechNotes** in the name.
-

Cisco Support Community

The Cisco Support Community is an online forum for Cisco customers, partners, and employees. It provides a place to discuss general email and web security issues, as well as technical information about specific Cisco products. You can post topics to the forum to ask questions and share information with other Cisco users.

Access the Cisco Support Community on the Customer Support Portal at the following URLs:

- For email security and associated management:
<https://supportforums.cisco.com/community/5756/email-security>
- For web security and associated management:
<https://supportforums.cisco.com/community/5786/web-security>

Cisco Customer Support

Do not contact Cisco Customer Support for help with Cloud Email Security appliances. See the Cisco IronPort Hosted Email Security / Hybrid Hosted Email Security Overview Guide for information on getting support for Cloud/Hybrid Email Security appliances.

Cisco TAC: <http://www.cisco.com/c/en/us/support/web/tsd-cisco-worldwide-contacts.html>

Support site for legacy IronPort: <http://www.cisco.com/c/en/us/services/acquisitions/ironport.html>

For non-critical issues, you can also access customer support from the appliance. For instructions, see the User Guide or online help.

Third Party Contributors

See Open Source licensing information for your release on this page:

<http://www.cisco.com/c/en/us/support/security/email-security-appliance/products-release-notes-list.html>.

Some software included within Cisco AsyncOS is distributed under the terms, notices, and conditions of software license agreements of FreeBSD, Inc., Stichting Mathematisch Centrum, Corporation for National Research Initiatives, Inc., and other third party contributors, and all such terms and conditions are incorporated in Cisco license agreements.

The full text of these agreements can be found here:

https://support.ironport.com/3rdparty/AsyncOS_User_Guide-1-1.html.

Portions of the software within Cisco AsyncOS is based upon the RRDtool with the express written consent of Tobin Oetiker.

Portions of this document are reproduced with permission of Dell Computer Corporation. Portions of this document are reproduced with permission of McAfee, Inc. Portions of this document are reproduced with permission of Sophos Plc.

Cisco Welcomes Your Comments

The Cisco Technical Publications team is interested in improving the product documentation. Your comments and suggestions are always welcome. You can send comments to the following email address:

contentsecuritydocs@cisco.com

Please include the product name, release number, and document publication date in the subject of your message.

Registering for a Cisco Account

Access to many resources on Cisco.com requires a Cisco account.

If you do not have a Cisco.com User ID, you can register for one here: <https://idreg.cloudapps.cisco.com/idreg/register.do>

Related Topics

- [Cisco Notification Service](#), on page 7
- [Knowledge Base](#), on page 8

Cisco Email Security Appliance Overview

The AsyncOS™ operating system includes the following features:

- **Anti-Spam** at the gateway, through the unique, multi-layer approach of SenderBase Reputation Filters and Cisco Anti-Spam integration.
- **Anti-Virus** at the gateway with the Sophos and McAfee Anti-Virus scanning engines.
- **Outbreak Filters™**, Cisco's unique, preventive protection against new virus, scam, and phishing outbreaks that can quarantine dangerous messages until new updates are applied, reducing the window of vulnerability to new message threats.
- **Policy, Virus, and Outbreak Quarantines** provide a safe place to store suspect messages for evaluation by an administrator.
- **Spam Quarantine** either on-box or off, providing end user access to quarantined spam and suspected spam.
- **Email Authentication.** Cisco AsyncOS supports various forms of email authentication, including Sender Policy Framework (SPF), Sender ID Framework (SIDF), and DomainKeys Identified Mail (DKIM) verification of incoming mail, as well as DomainKeys and DKIM signing of outgoing mail.
- Cisco **Email Encryption.** You can encrypt outgoing mail to address HIPAA, GLBA and similar regulatory mandates. To do this, you configure an encryption policy on the appliance and use a local key server or hosted key service to encrypt the message.
- **Email Security Manager**, a single, comprehensive dashboard to manage all email security services and applications on the appliance. Email Security Manager can enforce email security based on user groups,

allowing you to manage Cisco Reputation Filters, Outbreak Filters, Anti-Spam, Anti-Virus, and email content policies through distinct inbound and outbound policies.

- **On-box message tracking.** AsyncOS for Email includes an on-box message tracking feature that makes it easy to find the status of messages that the Eappliance processes.
- **Mail Flow Monitoring** of all inbound and outbound email that provides complete visibility into all email traffic for your enterprise.
- **Access control** for inbound senders, based upon the sender's IP address, IP address range, or domain.
- Extensive **message and content filtering** technology allows you to enforce corporate policy and act on specific messages as they enter or leave your corporate infrastructure. Filter rules identify messages based on message or attachment content, information about the network, message envelope, message headers, or message body. Filter actions allow messages to be dropped, bounced, archived, blind carbon copied, or altered, or to generate notifications.
- **Message encryption via secure SMTP over Transport Layer Security** ensures messages traveling between your corporate infrastructure and other trusted hosts are encrypted.
- **Virtual Gateway™** technology allows the appliance to function as several email gateways within a single server, which allows you to partition email from different sources or campaigns to be sent over separate IP addresses. This ensures that deliverability issues affecting one IP address do not impact others.
- **Protection against malicious attachments and links** in email messages, provided by multiple services.
- Use **Data Loss Prevention** to control and monitor the information that leaves your organization.

AsyncOS supports RFC 2821-compliant Simple Mail Transfer Protocol (SMTP) to accept and deliver messages.

Most reporting, monitoring, and configuration commands are available through both the web-based GUI via HTTP or HTTPS. In addition, an interactive Command Line Interface (CLI) which you access from a Secure Shell (SSH) or direct serial connection is provided for the system.

You can also set up a Security Management appliance to consolidate reporting, tracking, and quarantine management for multiple Eappliances .

Related Topics

- [Supported Languages, on page 10](#)

Supported Languages

AsyncOS can display its GUI and CLI in any of the following languages:

- English
- French
- Spanish
- German
- Italian
- Korean
- Japanese
- Portuguese (Brazil)
- Chinese (traditional and simplified)
- Russian



CHAPTER 2

Accessing the Appliance

This chapter contains the following sections:

- [Web-based Graphical User Interface \(GUI\)](#) , on page 11
- [Changing Configuration Settings](#), on page 14
- [Command Line Interface \(CLI\)](#), on page 15

Web-based Graphical User Interface (GUI)

You can administer the appliance using both the web-based Graphical User Interface (GUI) and Command Line Interface (CLI). The GUI contains most of the functionality you need to configure and monitor the system. However, not all CLI commands are available in the GUI; some features are *only* available through the CLI.

- [Browser Requirements](#), on page 11
- [Accessing the GUI](#), on page 12

Browser Requirements

To access the web-based UI, your browser must support and be enabled to accept JavaScript and cookies, and it must be able to render HTML pages containing Cascading Style Sheets (CSS).

Browser	Operating System
Internet Explorer 11.0	Microsoft Windows 7
Safari 7.0 and later	Mac OS X
Firefox 39.0 and later	Microsoft Windows 7, Mac OS X
Chrome 44.0 and later	Microsoft Windows 7, Mac OS X

Do not use multiple browser windows or tabs simultaneously to make changes to the appliance . Do not use concurrent GUI and CLI sessions. Doing so will cause unexpected behavior and is not supported.

You may need to configure your browser's pop-up blocking settings in order to use the web interface because some buttons or links in the interface will cause additional windows to open.

Accessing the GUI

To access the GUI on a brand new system, access the following URL:

<http://192.168.42.42/>

When the login page is displayed, log in to the system using the default username and passphrase.

Related Topics

- [Factory Default Username and Passphrase, on page 12](#)
- [Centralized Management, on page 12](#)

Factory Default Username and Passphrase

- Username: `admin`
- Passphrase: `ironport`

On brand new (not upgraded from previous releases of AsyncOS) systems, you will automatically be redirected to the System Setup Wizard.

During the initial system setup, you choose IP addresses for interfaces and whether to run HTTP and/or HTTPS services for those interfaces. When HTTP and/or HTTPS services have been enabled for an interface, you can use any supporting browser to view the GUI by entering the IP address or hostname of the IP interface as a URL in the location field (“address bar”) of the browser.

For example:

`http://192.168.1.1` or

`https://192.168.1.1` or

`http://mail3.example.com` or

`https://mail3.example.com`



Note If HTTPS has been enabled for an interface (and HTTP requests are *not* being redirected to the secure service), remember to access the GUI using the “`https://`” prefix.

Related Topics

- [Adding Users , on page 952](#)

Centralized Management

If you have created a cluster, you can browse machines in the cluster, create, delete, copy, and move settings among clusters, groups, and machines (that is, perform the equivalent of the `clustermode` and `clusterset` commands) from within the GUI.

For more information, see [Administering a Cluster from the GUI, on page 1197](#).

Cloud Administrator - Web Interface Access

As a cloud administrator, you have limited access to specific features and configuration settings available in the web interface of your email gateway.

The following table details the specific features and configuration settings limited for a cloud administrator:

Feature or Configuration Setting	Navigation Path in Email Gateway
Running a Packet Capture.	Help and Support > Packet Capture
Configuring FTP Access to the Email Gateway	Network > IP Interfaces
Configuring Domain Name System (DNS) Settings	Network > DNS
Configuring TCP/IP Traffic Routes	Network > Routing
Updating a List of Revoked Certificates	Network > CRL Sources
Configuring Server Settings for Downloading Upgrades and Updates	Security Services > Service Updates
Managing and Configuring Alerts	System Administration > Alerts
Shutting Down or Rebooting the Email Gateway	System Administration > Shutdown/Suspend
Downloading and Installing the Upgrade	System Administration > System Upgrade
Configuring Access to the Email Gateway	System Administration > Network Access
Editing General Settings of the Email Gateway	System Administration > General Settings
Defining Basic Configuration Using the Web-Based System Setup Wizard	System Administration > System Setup Wizard
Complete Configuration Process of your Email Gateway	System Administration > Next Steps

Enhanced User Experience using How-Tos Widget

The How-Tos is a contextual widget that provides in-app assistance to users in the form of walkthroughs to accomplish complex tasks on your appliance . To view a list of walkthroughs supported in this release, see [List of Walkthroughs](#).

You can access the walkthroughs by clicking the How-Tos widget on the web interface of your appliance . By default, the How-Tos widget is enabled on your appliance . The contents of the How-Tos widget are cloud-updateable.

For each walkthrough, there are recommended settings for specific configurable values categorized as follows:

- Conservative Settings - Cautious, configuration of not excessive limits
- Moderate Settings - Average, configuration within reasonable limits
- Aggressive Settings- Forceful, configuration of assertive limits

**Note**

- The current set of walkthroughs is limited to the following users: admin, cloud-admin, and operator.
- If you are using Internet Explorer version 11 to access the web interface of your appliance, you may not be able to view the How-Tos widget. Go to **System Administration > General Settings** page on your web interface and enable the Override IE Compatibility Mode option to view the How-Tos widget.

Disabling How-Tos Widget on the Appliance

Use the `adminaccessconfig > how-tos` sub command in the CLI if you want to disable the How-Tos widget on your appliance .

Example: Disabling How-Tos widget on the Appliance

```
mail.example.com> adminaccessconfig
```

Choose the operation you want to perform:

- BANNER - Configure login message (banner) for appliance administrator login.
- WELCOME - Configure welcome message (post login message) for appliance administrator login.
- IPACCESS - Configure IP-based access for appliance administrative interface.
- CSRF - Configure web UI Cross-Site Request Forgeries protection.
- XSS - Configure Cross-Site Scripting Attack protection.
- HOSTHEADER - Configure option to use host header in HTTP requests.
- TIMEOUT - Configure GUI and CLI session inactivity timeout.
- MAXHTTPHEADERFIELDSize - Configure maximum HTTP header Field size.
- HOW-TOS - Configure How-Tos feature.

```
[ ]> how-tos
```

How-Tos consists of a list of generic walkthroughs to assist the users in completing a particular task (for example, "enabling and configuring a service engine on the appliance").

```
Would you like to enable How-Tos? [Y]> no
```

Changing Configuration Settings

- [Configuration Changes, on page 14](#)
- [Commit or Abandoning Changes , on page 14](#)

Configuration Changes

You can make configuration changes while email operations proceed normally.

Commit or Abandoning Changes

You must explicitly save most configuration changes.

When changes are pending a commit, the Commit Changes button turns orange.

To clear or commit these changes, click **Commit Changes**.

Command Line Interface (CLI)

The Command Line Interface is accessible via SSH on IP interfaces that have been configured with these services enabled, or via terminal emulation software on the serial port. By factory default, SSH is configured on the Management port. Use the `interfaceconfig` command to disable these services.

For more information about CLI commands and conventions, see the CLI Reference Guide for AsyncOS for Cisco Email Security Appliances .



Note The factory default username and passphrase for accessing CLI is same as that of the web interface. See [Factory Default Username and Passphrase, on page 12](#).

Cloud Administrator - CLI Access

As a cloud administrator, you have limited access to specific CLI commands used for configuration settings on your email gateway.

The following table details the specific CLI commands limited for a cloud administrator:

CLI command	Description
<code>alertconfig</code>	Configure email alerts.
<code>clusterconfig</code>	Configure cluster related settings.
<code>clustercheck</code>	Prompt to switch to the cluster mode.
<code>dnsconfig</code>	Configure DNS setup.
<code>dnshostprefs</code>	Configure IPv4/IPv6 DNS preferences.
<code>displayalerts</code>	Display the last n alerts sent by the email gateway.
<code>enginestatus</code>	Displays the status and CPU usage of all engines enabled on the email gateway.
<code>etherconfig</code>	Configure Ethernet settings.
<code>interfaceconfig</code>	Configure Ethernet IP addresses.
<code>loadconfig</code>	Load a configuration file.
<code>mailconfig</code>	Mail the current configuration to an email C- and M-Series address.
<code>packetcapture</code>	Intercept and display packets being transmitted or received over the network.
<code>reboot</code>	Restart the system.
<code>repengstatus</code>	Request version information of Reputation Engine.

CLI command	Description
resetconfig	Restore the factory configuration defaults.
revert	Revert to a previous release.
rollbackconfig	Rollback to one of the previously committed configurations.
routeconfig	Configure IP routing table.
saveconfig	Saves the configuration to disk.
setgateway	Set the default gateway (router).
sethostname	Set the name of the machine.
showconfig	Display all configuration values.
shutdown	Shut down the system to power off.
systemsetup	First time system setup.
tcpsservices	Display information about files opened by processes.
tzupdate	Update timezone rules.
updateconfig	Configure system update parameters.
updatenow	Update all components.
upgrade	Install an upgrade.
wipedata	Wipe the core files on the disk and check the status of the last coredump operation.



CHAPTER 3

Setup and Installation

This chapter contains the following sections:

- [Installation Planning](#), on page 17
- [Physically Connecting the Email Security Appliance to the Network](#), on page 20
- [Preparing for System Setup](#), on page 24
- [Using the System Setup Wizard](#), on page 30
- [Verifying Your Configuration and Next Steps](#), on page 55

Installation Planning

- [Review Information That Impacts Planning Decisions](#), on page 17
- [Plan to Place the Email Security Appliance at the Perimeter of Your Network](#), on page 17
- [Register the Email Security Appliance in DNS](#), on page 18
- [Installation Scenarios](#), on page 19

Review Information That Impacts Planning Decisions

- If you are configuring a virtual appliance, please see the *Cisco Content Security Virtual Appliance Installation Guide* before continuing with this chapter.
- If you are configuring an M-Series Cisco Content Security Management appliance, please see [Centralizing Services on a Cisco Content \(M-Series\) Security Management Appliance](#), on page 1249.
- We recommend reviewing [Understanding the Email Pipeline](#), on page 57 before installing, as some features and functions may affect the placement of the appliance within your infrastructure.

Plan to Place the Email Security Appliance at the Perimeter of Your Network

Your appliance is designed to serve as your SMTP gateway, also known as a mail exchange (MX). For best results, some features require the appliance to be the first machine with an IP address that is directly accessible to the Internet (that is, it is an external IP address) for sending and receiving email.

The per-recipient reputation filtering, anti-spam, anti-virus, and Virus Outbreak Filter features (see [IronPort Anti-Spam Filtering](#), on page 361, [Sophos Anti-Virus Filtering](#), on page 342, and [Outbreak Filters](#), on page 401) are designed to work with a *direct flow* of messages from the Internet and from your internal network. You can configure the appliance for policy enforcement ([Overview of Defining Which Hosts Are Allowed to Connect](#), on page 93) for all email traffic to and from your enterprise.

Ensure that the appliance is both accessible via the public Internet and is the “first hop” in your email infrastructure. If you allow another MTA to sit at your network’s perimeter and handle all external connections, then the appliance will not be able to determine the sender’s IP address. The sender’s IP address is needed to identify and distinguish senders in the Mail Flow Monitor, to query the IP Reputation Service for the sender’s IP Reputation Score, and to improve the efficacy of the Anti-Spam and Outbreak Filters features.



Note If you cannot configure the appliance as the *first* machine receiving email from the Internet, you can still exercise some of the security services available on the appliance. For more information, see [Determining Sender IP Address In Deployments with Incoming Relays](#), on page 388.

When you use the appliance as your SMTP gateway:

- The Mail Flow Monitor feature (see [Using Email Security Monitor](#), on page 807) offers complete visibility into all email traffic for your enterprise from both internal and external senders.
- LDAP queries (see [LDAP Queries](#), on page 749) for routing, aliasing, and masquerading can consolidate your directory infrastructure and provide for simpler updates.
- Familiar tools like alias tables (see [Creating Alias Tables](#), on page 677), domain-based routing ([The Domain Map Feature](#), on page 694), and masquerading ([Configuring Masquerading](#), on page 684) make the transition from Open-Source MTAs easier.

Register the Email Security Appliance in DNS

Malicious email senders actively search public DNS records to hunt for new victims. In order to utilize the full capabilities of Anti-Spam, Outbreak Filters, McAfee Antivirus and Sophos Anti-Virus, ensure that the appliance is registered in DNS.

To register the appliance in DNS, create an A record that maps the appliance's hostname to its IP address, and an MX record that maps your public domain to the appliance's hostname. You must specify a priority for the MX record to advertise the appliance as either a primary or backup MTA for your domain.

In the following example, the appliance (`ironport.example.com`) is a backup MTA for the domain `example.com`, since its MX record has a higher priority value (20). In other words, the higher the numeric value, the lower the priority of the MTA.

```
$ host -t mx example.com
example.com mail is handled (pri=10) by mail.example.com
example.com mail is handled (pri=20) by ironport.example.com
```

By registering the appliance in DNS, you will attract spam attacks regardless of how you set the MX record priority. However, virus attacks rarely target backup MTAs. Given this, if you want to evaluate an anti-virus engine to its fullest potential, configure the appliance to have an MX record priority of equal or higher value than the rest of your MTAs.

Installation Scenarios

You can install your appliance into your existing network infrastructure in several ways.

Most customers' network configurations are represented in the following scenarios. If your network configuration varies significantly and you would like assistance planning an installation, please contact Cisco Customer Support (see [Cisco Customer Support](#), on page 8).

- [Configuration Overview](#), on page 19
- [Incoming](#), on page 19
- [Outgoing](#), on page 19
- [Ethernet Interfaces](#), on page 19
- [Advanced Configurations](#), on page 20
- [Firewall Settings \(NAT, Ports\)](#), on page 20

Configuration Overview

The following figure shows the typical placement of the appliance in an enterprise network environment:



In some scenarios, the appliance resides inside the network “DMZ,” in which case an additional firewall sits between the appliance and the groupware server.

The following network scenarios are described:

- Behind the Firewall: two listeners configuration (*Figure - Behind the Firewall Scenario / 2 Listeners Configuration*)

Choose the configuration that best matches your infrastructure. Then proceed to the next section, [Preparing for System Setup](#), on page 24.

Incoming

- Incoming mail is accepted for the local domains you specify.
- All other domains are rejected.
- External systems connect directly to the appliance to transmit email for the local domains, and the appliance relays the mail to the appropriate groupware servers (for example, Exchange™, Groupwise™, Domino™) via SMTP routes. (See [Routing Email for Local Domains](#), on page 671.)

Outgoing

- Outgoing mail sent by internal users is routed by the groupware server to the appliance .
- The appliance accepts outbound email based on settings in the Host Access Table for the private listener. (For more information, see [Working with Listeners](#), on page 70.)

Ethernet Interfaces

Only one of the available Ethernet interfaces on the appliance is required in these configurations. However, you can configure two Ethernet interfaces and segregate your internal network from your external Internet network connection.

For more information about assigning multiple IP addresses to the available interfaces, see [Configuring Mail Gateways for all Hosted Domains Using Virtual Gateway™ Technology](#), on page 723 and [Assigning Network and IP Addresses](#), on page 1267.

Hardware Ports

The number and type of ports on your hardware appliance depend on the model:

Ports	Type	C190	C390	C690	C690F	C195	C395	C695	C695F
Management	Ethernet	0	1	1	1	0	1	1	1
Data	Ethernet	2*	5	5	3	2*	5	5	3
Console	Serial	RJ-45	RJ-45	RJ-45	RJ-45	RJ-45	RJ-45	RJ-45	RJ-45
Remote Power Management (RPC)	Ethernet	Y	Y	Y	Y	Y	Y	Y	Y

* For appliances without a dedicated management port, use the Data1 port for management purposes.

For more information about ports, see the *Hardware Installation Guide* for your appliance model.

Related Topics

- [Configuring Network Interfaces](#), on page 35
- [Accessing the Email Security appliance via a Serial Connection](#), on page 1265
- [Enabling Remote Power Cycling](#), on page 1016

Advanced Configurations

In addition to the configurations shown in Figure - Behind the Firewall Scenario / 2 Listeners Configuration and Figure One Listener Configuration, you can also configure:

- Multiple appliances using the Centralized Management feature. See [Centralized Management Using Clusters](#), on page 1183
- Redundancy at the network interface card level by “teaming” two of the Ethernet interfaces on appliances using the NIC Pairing feature. See [Advanced Network Configuration](#), on page 1099

Firewall Settings (NAT, Ports)

SMTP and DNS services must have access to the Internet. Other services may also require open firewall ports. For details, see [Firewall Information](#), on page 1289.

Physically Connecting the Email Security Appliance to the Network

- [Configuration Scenarios](#), on page 21

Configuration Scenarios

The typical configuration scenario for the appliance is as follows:

- **Interfaces** - Only one of the three available Ethernet interfaces on the appliance is required for most network environments. However, you can configure two Ethernet interfaces and segregate your internal network from your external Internet network connection.
- **Public Listener (incoming email)** - The public listener receives connections from many external hosts and directs messages to a limited number of internal groupware servers.
 - Accepts connections from external mail hosts based on settings in the Host Access Table (HAT). By default, the HAT is configured to ACCEPT connections from all external mail hosts.
 - Accepts incoming mail only if it is addressed for the local domains specified in the Recipient Access Table (RAT). All other domains are rejected.
 - Relays mail to the appropriate internal groupware server, as defined by SMTP Routes.
- **Private Listener (outgoing email)** - The private listener receives connections from a limited number of internal groupware servers and directs messages to many external mail hosts.
 - Internal groupware servers are configured to route outgoing mail to the Cisco C- or X-Series appliance.
 - The appliance accepts connections from internal groupware servers based on settings in the HAT. By default, the HAT is configured to RELAY connections from all internal mail hosts.

Related Topics

- [Segregating Incoming and Outgoing Mail, on page 21](#)

Segregating Incoming and Outgoing Mail

You can segregate incoming and outgoing email traffic over separate listeners and on separate IP addresses. You can use Internet Protocol version 4 (IPv4) and version 6 (IPv6) addresses. However, the System Setup Wizard on the appliance supports initial configuration of the following configurations:

- 2 separate listeners on 2 logical IPv4 and 2 IPv6 addresses configured on *separate* physical interfaces
 - segregates incoming and outgoing traffic
 - you can assign an IPv4 and an IPv6 address to each listener
- 1 listener on 1 logical IPv4 address configured on one physical interface
 - combines both incoming and outgoing traffic
 - you can assign both an IPv4 and an IPv6 address to the listener

Configuration worksheets for both one and two listener configurations are included below (see [Gathering the Setup Information, on page 27](#)). Most configuration scenarios are represented by one of the following three figures.

Figure 1: Behind the Firewall Scenario / 2 Listeners Configuration

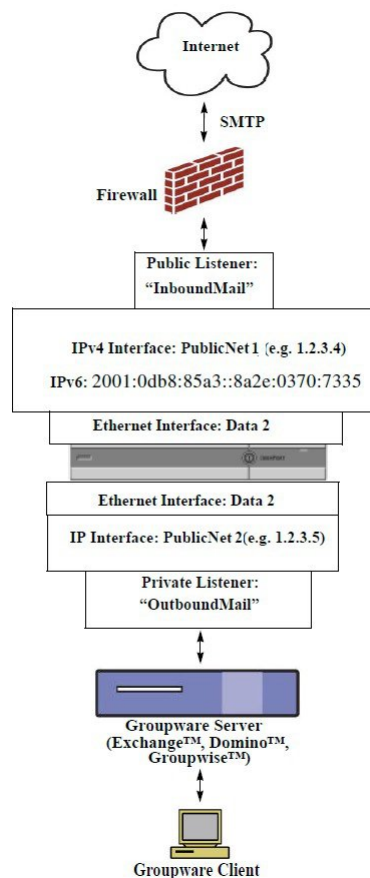
**Notes:**

- 2 Listeners
- 2 IPv4 addresses
- 2 IPv6 addresses
- 1 or 2 Ethernet interfaces (only 1 interface shown)
- SMTP routes configured

Inbound Listener: “InboundMail” (public)

- IPv4 address: 1.2.3.4
- IPv6 address: 2001:0db8:85a3::8a2e:0370:7334
- Listener on the Data2 interface listens on port 25
- HAT (accept ALL)
- RAT (accept mail for local domains; reject ALL)

Outbound Listener: “OutboundMail” (private)

- IP address: 1.2.3.5
- IPv6 address: 2001:0db8:85a3::8a2e:0370:7335
- Listener on the Data2 interface listens on port 25
- HAT (relay for local domains; reject ALL)

DNS can be configured to use Internet Root servers or internal DNS servers

SMTP routes direct mail to proper groupware server

Firewall ports opened for appropriate services to and from the appliance

Figure 2: One Listener Configuration

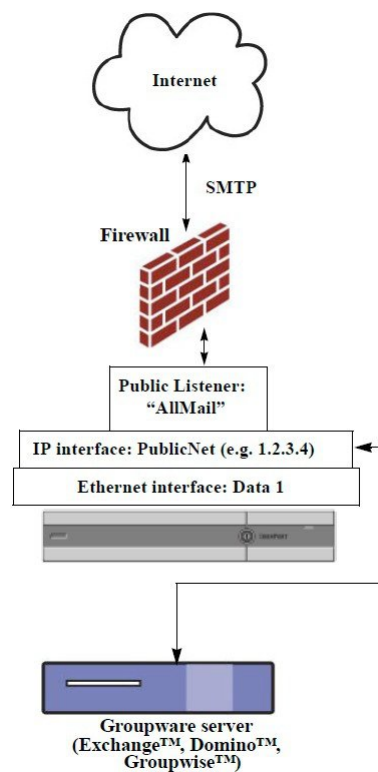

Notes:

- 1 Listener
- 1 IP addresses
- 1 Ethernet interface
- SMTP routes configured

Inbound Listener: "InboundMail" (public)

- IP address: 1.2.3.4
- Listener on the Data2 interface listens on port 25

- HAT (accept ALL) includes entries for Groupware servers in RELAYLIST
- RAT (accept mail for local domains; reject ALL)

DNS can be configured to use Internet Root servers or internal DNS servers

SMTP routes direct mail to proper groupware server

Firewall ports opened for appropriate services to and from the appliance .

Preparing for System Setup

- [Determine Method for Connecting to the Appliance](#) , on page 25
- [Determining Network and IP Address Assignments](#), on page 26
- [Gathering the Setup Information](#), on page 27

Procedure

	Command or Action	Purpose
Step 1	Determine how you will connect to the appliance .	See Determine Method for Connecting to the Appliance , on page 25
Step 2	Determine network and IP address assignments. <ul style="list-style-type: none"> • If you have already cabled your appliance to your network, ensure that the default IP address for the appliance does not conflict with other IP addresses on your network. 	See Determine Method for Connecting to the Appliance , on page 25 and Determining Network and IP Address Assignments , on page 26
Step 3	Gather information about your system setup.	See Gathering the Setup Information , on page 27.
Step 4	Review the latest product release notes for your appliance .	Release notes are available from the link in Documentation , on page 6.
Step 5	Unpack the appliance , physically install it in a rack, and turn it on.	See Quickstart Guide for your appliance . This guide is available from the link in Documentation , on page 6.
Step 6	If you will run the setup wizard using the command line interface (CLI), access the CLI.	See Running the Command Line Interface (CLI) System Setup Wizard , on page 42)
Step 7	If you will run the setup wizard using the web interface:	<ol style="list-style-type: none"> (Virtual appliances ONLY) Access the command-line interface and enable HTTP and/or HTTPS using the <code>interfaceconfig</code> command. Launch a web browser and enter the IP address of the appliance .
Step 8	If you are setting up a virtual appliance, load your virtual appliance license.	Use the <code>loadlicense</code> command. For more information, see the <i>Cisco Content Security Virtual Appliance Installation Guide</i> available from the link in Documentation , on page 6.

	Command or Action	Purpose
Step 9	Configure basic settings for your system.	See Using the System Setup Wizard , on page 30

Determine Method for Connecting to the Appliance

To successfully set up the appliance in your environment, you must gather important network information from your network administrator about how you would like to connect the appliance to your network.

Related Topics

- [Connecting to the Appliance](#) , on page 25

Connecting to the Appliance

During the initial setup, you can connect to the appliance in one of two ways:

Table 3: Options for Connecting to the Appliance

Ethernet	An Ethernet connection between a PC and the network and between the network and the Management port. The IPv4 address that has been assigned to the Management port by the factory is 192.168.42.42 . This is the easiest way to connect if it works with your network configuration.
Serial	A serial communications connection between the PC and the Serial Console port. If you cannot use the Ethernet method, a straight serial-to- serial connection between the computer and the appliance will work until alternate network settings can be applied to the Management port. For pinout information, see Accessing the Email Security appliance via a Serial Connection , on page 1265. The communications settings for the serial port are: Bits per second: 9600 Data bits: 8 Parity: None Stop bits: 1 Flow control: Hardware



Note

Keep in mind that the initial connection method is not final. This process applies only for the initial configuration. You can change network settings at a later time to allow different connection methods. (See [FTP, SSH, and SCP Access](#), on page 1261 for more information.) You can also create multiple user accounts with differing administrative privileges to access the appliance . (For more information, see [Adding Users](#) , on page 952.)

Determining Network and IP Address Assignments

You can use both IPv4 and IPv6 addresses.

- [Default IP Addresses for Management and Data Ports](#) , on page 26
- [Choosing Network Connections to Receive and Deliver Email](#) , on page 26
- [Binding Logical IP Addresses to Physical Ethernet Ports](#), on page 26
- [Choosing Network Settings for Your Connections](#), on page 26

Default IP Addresses for Management and Data Ports

The IP address that is pre-configured on the Management port (the Data 1 port on C170 and C190 appliances) is 192.168.42.42 .

Choosing Network Connections to Receive and Deliver Email

Most users take advantage of the two Data Ethernet ports on the appliance by connecting to two networks from the appliance:

- The private network accepts and delivers messages to your internal systems.
- The public network accepts and delivers messages to the Internet.

Other users may want to use only one Data port serving both functions. Although the Management Ethernet port can support any function, it is preconfigured for access to the graphical user interface and the command line interface.

Binding Logical IP Addresses to Physical Ethernet Ports

You can segregate incoming and outgoing email traffic over separate listeners and on separate IP addresses. You can use Internet Protocol version 4 (IPv4) and version 6 (IPv6) addresses. However, the System Setup Wizard on the appliance supports initial configuration of the following configurations:

- 2 separate listeners on 2 logical IPv4 and 2 IPv6 addresses configured on *separate* physical interfaces
 - segregates incoming and outgoing traffic
 - you can assign an IPv4 and an IPv6 address to each listener
- 1 listener on 1 logical IPv4 address configured on one physical interface
 - combines both incoming and outgoing traffic
 - you can assign both an IPv4 and an IPv6 address to the listener

The appliance can support both IPv4 and IPv6 addresses on single listener. The listener will accept mail on both the addresses. All settings on a listener apply to both IPv4 and IPv6 addresses.

Choosing Network Settings for Your Connections

You will need the following network information about each Ethernet port that you choose to use:

- IP address (IPv4 or IPv6 or both)
- Netmask for IPv4 address in CIDR format
- Prefix for IPv6 address in CIDR format

In addition, you will need the following information about your overall network:

- IP address of the default router (gateway) on your network

- IP address and hostname of your DNS servers (not required if you want to use Internet root servers)
- Hostname or IP address of your NTP servers (not required if you want to use Cisco's time servers)

See [Assigning Network and IP Addresses, on page 1267](#) for more information.



Note If you are running a firewall on your network between the Internet and the appliance, it may be necessary to open specific ports for the appliance to work properly. See [Firewall Information, on page 1289](#) for more information.

Gathering the Setup Information

Now that you understand the requirements and strategies when making the necessary selections in the System Setup Wizard, use the following tables to gather information about your system setup while reading this section.

See [Assigning Network and IP Addresses, on page 1267](#) for more detailed information on network and IP addresses. See [Centralizing Services on a Cisco Content \(M-Series\) Security Management Appliance, on page 1249](#) if you are configuring a Cisco Content Security Management appliance.

Table 4: System Setup Worksheet: 2 Listeners for Segregating Email Traffic

System Settings		
Default System Hostname:		
Email System Alerts To:		
Deliver Scheduled Reports To:		
Time Zone Information:		
NTP Server:		
Admin Passphrase:		
SenderBase Network Participation:	Enable / Disable	
AutoSupport:	Enable / Disable	
Network Integration		
Gateway:		
DNS (Internet or Specify Own):		
Interfaces		
Data 1 Port		
IPv4 Address / Netmask:		
IPv6 Address / Prefix:		

System Settings		
Fully Qualified Hostname:		
Accept Incoming Mail:	Domain	Destination
Relay Outgoing Mail:	System	
Data 2 Port		
IPv4 Address / Netmask:		
IPv6 Address / Prefix:		
Fully Qualified Hostname:		
Accept Incoming Mail:	Domain	Destination
Relay Outgoing Mail:	System	
Management Port		
IP Address:		
Network Mask:		
IPv6 Address:		
Prefix:		
Fully Qualified Hostname:		
Accept Incoming Mail:	Domain	Destination
Relay Outgoing Mail:	System	
Message Security		
IP Reputation Filtering:	Enable / Disable	
Anti-Spam Scanning Engine	None / IronPort	
McAfee Anti-Virus Scanning Engine	Enable / Disable	
Sophos Anti-Virus Scanning Engine	Enable / Disable	
Outbreak Filters	Enable / Disable	

Table 5: System Setup Worksheet: 1 Listener for All Email Traffic

System Settings		
Default System Hostname:		

System Settings		
Email System Alerts To:		
Deliver Scheduled Reports To:		
Time Zone:		
NTP Server:		
Admin Passphrase:		
SenderBase Network Participation:	Enable / Disable	
AutoSupport:	Enable / Disable	
Network Integration		
Gateway:		
DNS (Internet or Specify Own):		
Interfaces		
Data2 Port		
IPv4 Address / Netmask:		
IPv6 Address / Prefix:		
Fully Qualified Hostname:		
Accept Incoming Mail:	Domain	Destination
Relay Outgoing Mail:	System	
Data1 Port		
IPv4 Address / Netmask:		
IPv6 Address / Prefix:		
Fully Qualified Hostname:		
Message Security		
IP Reputation Filtering:	Enable / Disable	
Anti-Spam Scanning Engine	None / IronPort	
McAfee Anti-Virus Scanning Engine	Enable / Disable	
Sophos Anti-Virus Scanning Engine	Enable / Disable	

System Settings		
Outbreak Filters	Enable / Disable	

Using the System Setup Wizard

- [Accessing the Web-Based Graphical User Interface \(GUI\), on page 30](#)
- [Defining Basic Configuration Using the Web-Based System Setup Wizard , on page 32](#)
- [Setting up the Connection to Active Directory, on page 40](#)
- [Proceeding to the Next Steps, on page 41](#)
- [Accessing the Command Line Interface \(CLI\), on page 41](#)
- [Running the Command Line Interface \(CLI\) System Setup Wizard, on page 42](#)
- [Configuring your system as an Enterprise Gateway , on page 55](#)

You must use the System Setup Wizard for the initial setup in order to ensure a complete configuration. Later, you can configure custom options not available in the System Setup Wizard.

You can run the System Setup Wizard using a browser or the command line interface (CLI). For more information, see [Accessing the Web-Based Graphical User Interface \(GUI\), on page 30](#) or [Running the Command Line Interface \(CLI\) System Setup Wizard, on page 42](#)

Before you begin, complete the prerequisites at [Preparing for System Setup, on page 24](#).



Caution

If you are setting up a virtual appliance , you will have to use the `loadlicense` command to load your virtual appliance license before running the System Setup Wizard. See the *Cisco Content Security Virtual Appliance Installation Guide* for more information.



Caution

The System Setup Wizard will completely reconfigure your system. You should only use the System Setup Wizard the very first time you install the appliance , or if you want to completely overwrite your existing configuration.



Caution

The appliance ships with a default IP address of 192.168.42.42 on the Management port of all hardware except C170 and C190 appliances, which use the Data 1 port instead. Before connecting the appliance to your network, ensure that no other device's IP address conflicts with this factory default setting. If you are configuring a Cisco Content Security Management appliance , see [Centralizing Services on a Cisco Content \(M-Series\) Security Management Appliance , on page 1249](#).

If you are connecting multiple factory-configured content security appliances to your network, add them one at a time, reconfiguring each appliance's default IP address as you go.

Accessing the Web-Based Graphical User Interface (GUI)

The appliance has a standard web-based graphical user interface, a new web-based interface for managing the Email Security Monitor feature (Monitoring, Tracking, and Quarantine), and a command-line interface.

To access the web-based Graphical User Interface (GUI), open your web browser and point it to 192.168.42.42. [New Web Interface Only] You can access the new web interface in any one of the following ways:



Note The new web interface of your appliance uses AsyncOS API HTTP/HTTPS ports (6080/6443) and trailblazer HTTPS port (4431). You can use the `trailblazerconfig` command in the CLI to configure the trailblazer HTTPS ports. Make sure that the trailblazer HTTPS port is opened on the firewall.

- When `trailblazerconfig` CLI command is enabled, use the following URL -
`https://example.com:<trailblazer-https-port>/ng-login`

where `example.com` is the appliance host name and `<trailblazer-https-port>` is the trailblazer HTTPS port configured on the appliance.

For more information on the `trailblazerconfig` CLI command, see the Cisco Secure Email Command Reference Guide.

- Log in to the legacy web interface and click **Email Security Appliance is getting a new look. Try it!!** link to access the new web interface.

Important Notes

- Make sure that AsyncOS API is enabled on the appliance .
- Make sure that AsyncOS HTTPS API port is not enabled on multiple interfaces.
- You must login to the legacy web interface of the appliance .
- If `trailblazerconfig` is enabled, the configured HTTPS port must be opened on the firewall. The default HTTPS port is 4431.

Also ensure that your DNS server can resolve the hostname that you specified for accessing the appliance .

Related Topics

- [Factory Default Username and Passphrase, on page 31](#)
- [Accessing New Web Interface in Dusk Mode, on page 32](#)

Factory Default Username and Passphrase

If you install a new virtual or hardware appliance , you must change the default passphrase to get complete access to set up the appliance . When you log in to the appliance for the first time, the web interface prompts you to change the default passphrase, and the CLI limits the access to the following commands till you change the default passphrase.

- Commit
- Interfaceconfig
- passphrase
- Loadconfig
- Systemsetup

- loadlicense (for virtual appliances)
- feature key
- Ping
- Telnet
- netstat
- Username: `admin`
- Passphrase: `ironport`

For Example:

```
login: admin
passphrase: ironport
```



Note If your session times out, you will be asked to re-enter your username and passphrase. If your session times out while you are running the System Setup Wizard, you will have to start over again.

Accessing the Legacy Web Interface

To access the legacy web interface from the new web interface, click on the gear icon  as shown in the following figure:

Figure 3: Accessing the Legacy Web Interface from the



The legacy web interface opens in a new browser window. You must log in again to access it.

If you want to log out of the appliance completely, you need to log out of both the new and legacy web interfaces of your appliance .

Accessing New Web Interface in Dusk Mode

Dusk Mode is a reversed color scheme that utilizes light-colored typography, UI elements, and iconography on dark backgrounds.

You can now access the new web interface of your appliance using the dusk mode.

To switch to the dusk mode, click on the user icon on the top-right corner of the new web interface and select **Dusk Theme**.

Defining Basic Configuration Using the Web-Based System Setup Wizard

Procedure

Step 1 Launch the System Setup Wizard

- Log in to the graphical user interface as described in [Accessing the Web-Based Graphical User Interface \(GUI\), on page 30](#).
- On brand new (not upgraded from previous releases of AsyncOS) systems, your browser will automatically be redirected to the System Setup Wizard.
- Otherwise, on the System Administration tab, click System Setup Wizard in the list of links on the left.

Step 2 Start. See [Step 1: Start, on page 33](#).

- Read and accept the license agreement

Step 3 System. See [Step 2: System, on page 34](#).

- Setting the hostname of the appliance
- Configuring alert settings, report delivery settings, and AutoSupport
- Setting the system time settings, and NTP server
- Resetting the admin passphrase
- Enabling Service Logs

Step 4 Network. See [Step 3: Network, on page 35](#).

- Defining the default router and DNS settings
- Enabling and configuring network interfaces, including:Configuring incoming mail (inbound listener)Defining SMTP routes (optional) Configuring outgoing mail (outbound listener) and defining systems allowed to relay mail through the appliance (optional)

Step 5 Security. Se [Step 4: Security, on page 39](#).

- Enabling IP Reputation Filtering
- Enabling the Anti-Spam service
- Enabling the Spam Quarantine
- Enabling the Anti-Virus service
- Enabling Advanced Malware Protection (file reputation and analysis services.)
- Enabling the Outbreak Filters service

Step 6 Review. See [Step 5: Review, on page 40](#).

- Reviewing your setup and installing the configuration
- At the end of the process, you are prompted to

Step 7 Commit the changes you have made.

Your changes will not take effect until they have been committed.

Step 1: Start

Begin by reading the license agreement. Once you have read and agreed to the license agreement, check the box indicating that you agree and then click **Begin Setup** to proceed.

You can also view the text of the agreement here: <https://support.ironport.com/license/eula.html>

Step 2: System

- [Setting the Hostname, on page 34](#)
- [Configuring System Alerts, on page 34](#)
- [Configuring Report Delivery, on page 34](#)
- [Setting the Time, on page 34](#)
- [Setting the Passphrase, on page 34](#)
- [Improving Phishing Detection Efficacy using Service Logs, on page 1093](#)
- [Enabling AutoSupport, on page 35](#)

Setting the Hostname

Define the fully-qualified hostname for the appliance . This name should be assigned by your network administrator.

Configuring System Alerts

Cisco AsyncOS sends alert messages via email if there is a system error that requires the user's intervention. Enter the email address (or addresses) to which to send those alerts.

You must add at least one email address that receives System Alerts. Enter a single email address, or separate multiple addresses with commas. The email recipients initially receive all types of alerts at all levels, except for Directory Harvest Attack Prevention alerts. You can add more granularity to the alert configuration later. For more information, see [Alerts, on page 1021](#).

Configuring Report Delivery

Enter the address to which to send the default scheduled reports. If you leave this value blank, the scheduled reports are still run. They will be archived on the appliance rather than delivered.

Setting the Time

Set the time zone on the appliance so that timestamps in message headers and log files are correct. Use the drop-down menus to locate your time zone or to define the time zone via GMT offset (see [Selecting a GMT Offset, on page 1059](#) for more information).

You can set the system clock time manually later, or you can use the Network Time Protocol (NTP) to synchronize time with other servers on your network or the Internet. By default, one entry to the Cisco Systems time servers (`time.ironport.com`) to synchronize the time on your appliance is already configured.

Setting the Passphrase

Set the passphrase for the admin account. This is a required step. When changing the passphrase for the Cisco AsyncOS admin account, the new passphrase must be six characters or longer. Be sure to keep the passphrase in a secure location.

Enabling Service Logs

The 'Service Logs' are sent to the Cisco Talos Cloud service to improve Phishing detection.

If you enable Service Logs, the Cisco Email Security gateway collects limited personal data from customer emails and offers extensive useful threat detection capabilities that can be coupled with dedicated analysis systems to collect, trend, and correlate observed threat activity. Cisco uses the personal data to improve your email gateway capabilities to analyze the threat landscape, provide threat classification solutions on malicious emails, and to protect your email gateway from new threats such as spam, virus, and directory harvest attacks.

See [Improving Phishing Detection Efficacy using Service Logs, on page 1093](#) for more information.

Enabling AutoSupport

The AutoSupport feature (enabled by default) keeps the Cisco Customer Support team aware of issues with your appliance so that we can provide better support to you. (For more information, see [AutoSupport, on page 1021](#).)

Click **Next** to continue.

Step 3: Network

In Step 3, you define the default router (gateway) and configure the DNS settings, and then set up the appliance to receive and or relay email by configuring the Data 1, Data 2, and Management interfaces.

- [Configuring DNS and Default Gateway, on page 35](#)
- [Configuring Network Interfaces, on page 35](#)
- [Accepting Mail, on page 36](#)
- [Relaying Mail \(Optional\), on page 37](#)
- [C170 and C190 Installations, on page 38](#)

Configuring DNS and Default Gateway

Type the IP address of the default router (gateway) on your network. You can use an IPv4 address, an IPv6 address, or both.

Next, configure the DNS (Domain Name Service) settings. Cisco AsyncOS contains a high-performance internal DNS resolver/cache that can query the Internet's root servers directly, or the system can use DNS servers you specify. If you choose to use your own servers, you will need to supply the IP address and hostname of each DNS server. You can enter up to four DNS servers via the System Setup Wizard. Please note that DNS servers you enter will have an initial priority of 0. For more information, see [Configuring Domain Name System \(DNS\) Settings, on page 1044](#).



Note The appliance requires access to a working DNS server in order to perform DNS lookups for incoming connections. If you cannot specify a working DNS server that is reachable by the appliance while you are setting up the appliance, a workaround is to either select “Use Internet Root DNS Servers” or to specify, temporarily, the IP address of the Management interface so that you can complete the System Setup Wizard.

Configuring Network Interfaces

Your appliance has network interfaces that are associated with the physical Ethernet ports on the machine.

To use an interface, mark the “Enable” checkbox and then specify an IP address, network mask, and fully qualified hostname. The IP address you enter should be the address intended for your inbound mail as reflected in your DNS records. Typically this address would have an MX record associated with it in DNS. You can use an IPv4 address, an IPv6 address, or both. If you use both, the interface will accept both types of connections.

Each interface can be configured to accept mail (incoming), relay email (outgoing), or appliance management. During setup, you are limited to one of each. On most appliances, you would typically use one interface for incoming, one for outgoing, and one for appliance management. On the C170 and C190 appliances, you would typically use one interface for both incoming and outgoing mail, and the other interface for management.

You must configure one interface to receive email.

Assign and configure a logical IP address to one of the physical Ethernet interfaces on the appliance. If you decide to use both the Data 1 Ethernet port and the Data 2 Ethernet port, you need this information for both connections.

For C390, and C690 appliances: Cisco recommends using one of the physical Ethernet ports to connect directly to the Internet for the purposes of receiving inbound email through public listeners, and using another physical Ethernet port to connect directly to your internal network for the purposes of relaying outbound email through private listeners.

For C190 appliances: Typically, the System Setup Wizard will configure only one physical Ethernet port with one listener for both receiving inbound email and relaying outbound email.

See [Binding Logical IP Addresses to Physical Ethernet Ports, on page 26](#).

The following information is required:

- The **IP address** assigned by your network administrator. This can be an IPv4 address, an IPv6 address, or both.
- For IPv4 addresses: the **netmask** of the interface. AsyncOS only accepts a netmask in CIDR format. For example, /24 for the 255.255.255.0 subnet.
For IPv6 addresses: the **prefix** in CIDR format. For example /64 for a 64-bit prefix.
- (optional) A fully-qualified hostname for the IP address.



Note IP addresses within the same subnet cannot be configured on separate physical Ethernet interfaces. See [Assigning Network and IP Addresses, on page 1267](#) for more detailed information on Network and IP Address configuration.

Accepting Mail

When configuring your interfaces to accept mail, you define:

- the domain for which to accept mail
- destination (SMTP Route) for each domain, this is optional

Mark the checkbox for Accept Incoming Mail to configure the interface to accept mail. Enter the name of the domain for which to accept mail.

Enter the Destination. This is the SMTP Route or name of the machine(s) where you would like to route email for the domains specified.

This is the first SMTP Routes entry. The SMTP Routes table allows you to redirect all email for each domain (also known as a Recipient Access Table (RAT) entry) you enter to a specific mail exchange (MX) host. In typical installations, the SMTP Routes table defines the specific groupware (for example, Microsoft Exchange) server or the “next hop” in the email delivery for your infrastructure.

For example, you can define a route that specifies that mail accepted for the domain `example.com` and all of its subdomains `.example.com` is routed to the groupware server `exchange.example.com`.

You can enter multiple domains and destinations. Click **Add Row** to add another domain. Click the trash can icon to remove a row.



Note Configuring SMTP Routes in this step is optional. If no SMTP routes are defined, the system will use DNS to lookup and determine the delivery host for the incoming mail received by the listener. (See [Routing Email for Local Domains, on page 671.](#))

You must add at least one domain to the Recipient Access Table. Enter a domain — `example.com`, for example. To ensure that mail destined for any subdomain of `example.net` will match in the Recipient Access Table, enter `.example.net` as well as the domain name. For more information, see [Defining Recipient Addresses, on page 128.](#)

Relaying Mail (Optional)

When configuring your interfaces to relay mail, you define the systems allowed to relay email through the appliance .

These are entries in the RELAYLIST of the Host Access Table for a listener. See [Sender Group Syntax, on page 95](#) for more information.

Mark the check box for Relay Outgoing Mail to configure the interface to relay mail. Enter the hosts that may relay mail through the appliance .

When you configure an interface to relay outbound mail, the System Setup Wizard turns on SSH for the interface as long as no public listeners are configured to use the interface.

In the following example, two interfaces with IPv4 addresses are created:

- 192.168.42.42 remains configured on the Management interface.
- 192.168.1.1 is enabled on the Data 1 Ethernet interface. It is configured to accept mail for domains ending in `.example.com` and an SMTP route is defined for `exchange.example.com`.
- 192.168.2.1 is enabled on the Data 2 Ethernet interface. It is configured to relay mail from `exchange.example.com`.

C390, and C690 Installations

Figure 4: Network Interfaces: 2 Interfaces in Addition to Management (Segregated Traffic)

<input checked="" type="checkbox"/> Enable Data 1 Interface	
<i>This interface is typically configured to accept mail.</i>	
IPv4 Address / Netmask:	1.1.1.1/24
IPv6 Address / Prefix:	2001:db8:1::4/64
Fully Qualified Hostname:	<input type="text"/> <i>Fully qualified hostname for this appliance</i>
Accept Incoming Mail:	<input type="checkbox"/> Accept mail on this interface
Relay Outgoing Mail:	<input type="checkbox"/> Relay mail on this interface
<input checked="" type="checkbox"/> Enable Data 2 Interface	
<i>This interface is typically configured to relay mail.</i>	
IPv4 Address / Netmask:	1.1.1.2/24
IPv6 Address / Prefix:	2001:db8:1::4/64
Fully Qualified Hostname:	<input type="text"/> <i>Fully qualified hostname for this appliance</i>
Accept Incoming Mail:	<input type="checkbox"/> Accept mail on this interface
Relay Outgoing Mail:	<input type="checkbox"/> Relay mail on this interface
<input checked="" type="checkbox"/> Enable Management Interface	
<i>This interface is typically configured for system administration.</i>	
IPv4 Address / Netmask:	1.1.1.2/24
IPv6 Address / Prefix:	2001:db8:1::4/64
Fully Qualified Hostname:	mail.example.com <i>Fully qualified hostname for this appliance</i>
Accept Incoming Mail:	<input type="checkbox"/> Accept mail on this interface
Relay Outgoing Mail:	<input type="checkbox"/> Relay mail on this interface

C170 and C190 Installations

For C170 and C190 appliances, the Data 2 interface is typically configured for both incoming and outgoing mail while the Data 1 interface is used for appliance management.

When configuring a single IP address for all email traffic (nonsegregated traffic), step 3 of the System Setup Wizard will look like this:

Figure 5: Network Interfaces: 1 IP Address for Incoming and Outgoing (Nonsegregated) Traffic

<input checked="" type="checkbox"/> Enable Data 2 Interface										
<i>This interface is typically used to accept and relay mail.</i>										
IP Address:	192.168.1.1									
Network Mask:	255.255.255.0									
Fully Qualified Hostname:	mail3.example.com <i>Fully qualified hostname for this appliance</i>									
Accept Incoming Mail:	<input checked="" type="checkbox"/> Accept mail on this interface									
<table border="1"> <thead> <tr> <th>Domain ?</th> <th>Destination</th> <th>Add Row</th> </tr> </thead> <tbody> <tr> <td>example.com</td> <td>exchange.example.com</td> <td><input type="button" value="Add Row"/></td> </tr> <tr> <td colspan="2"><i>example: company.com</i></td> <td><i>i.e., An Exchange or Notes server</i></td> </tr> </tbody> </table>		Domain ?	Destination	Add Row	example.com	exchange.example.com	<input type="button" value="Add Row"/>	<i>example: company.com</i>		<i>i.e., An Exchange or Notes server</i>
Domain ?	Destination	Add Row								
example.com	exchange.example.com	<input type="button" value="Add Row"/>								
<i>example: company.com</i>		<i>i.e., An Exchange or Notes server</i>								
Relay Outgoing Mail:	<input checked="" type="checkbox"/> Relay mail on this interface									
<table border="1"> <thead> <tr> <th>System ?</th> <th>Add Row</th> </tr> </thead> <tbody> <tr> <td>exchange.example.com</td> <td><input type="button" value="Add Row"/></td> </tr> <tr> <td colspan="2"><i>example: company.com</i></td> </tr> </tbody> </table>		System ?	Add Row	exchange.example.com	<input type="button" value="Add Row"/>	<i>example: company.com</i>				
System ?	Add Row									
exchange.example.com	<input type="button" value="Add Row"/>									
<i>example: company.com</i>										
<input checked="" type="checkbox"/> Enable Data 1 Interface										
<i>This interface is typically used for system administration. (You are currently connected to this interface.)</i>										
IP Address:	192.168.42.42									
Network Mask:	255.255.255.0									
Fully Qualified Hostname:	mail.example.com <i>Fully qualified hostname for this appliance</i>									
Accept Incoming Mail:	<input type="checkbox"/> Accept mail on this interface									
Relay Outgoing Mail:	<input type="checkbox"/> Relay mail on this interface									

Click **Next** to continue.

Step 4: Security

In step 4, you configure anti-spam and anti-virus settings. The anti-spam options include IP Reputation Filtering and selecting an anti-spam scanning engine. For anti-virus, you can enable Outbreak Filters and Sophos or McAfee anti-virus scanning.

- [Enabling IP Reputation Filtering, on page 39](#)
- [Enabling Anti-Spam Scanning, on page 39](#)
- [Enabling Anti-Virus Scanning, on page 39](#)
- [Enabling Advanced Malware Protection \(File Reputation and Analysis Services\) , on page 39](#)
- [Enabling Outbreak Filters, on page 40](#)

Enabling IP Reputation Filtering

The IP Reputation Service can be used as a stand-alone anti-spam solution, but it is primarily designed to improve the effectiveness of a content-based anti-spam system such as Anti-Spam.

The IP Reputation Service provides an accurate, flexible way for users to reject or throttle suspected spam based on the connecting IP address of the remote host. The IP Reputation Service returns a score based on the probability that a message from a given source is spam. The IP Reputation Service is unique in that it provides a global view of email message volume and organizes the data in a way that makes it easy to identify and group related sources of email. Cisco strongly suggests that you enable IP Reputation Filtering.

Once enabled, IP Reputation Filtering is applied on the incoming (accepting) listener.

Enabling Anti-Spam Scanning

Your appliance may ship with a 30-day evaluation key for Anti-Spam software. During this portion of the System Setup Wizard, you can choose to enable Anti-Spam globally on the appliance . You can also elect to not enable the service.

If you choose to enable the anti-spam service, you can configure AsyncOS to send spam and suspected spam messages to the local Spam Quarantine. The Spam Quarantine serves as the end-user quarantine for the appliance . Only administrators can access the quarantine until end-user access is configured.

See [Managing Spam and Graymail, on page 359](#) for all of the Anti-Spam configuration options available on the appliance. See [Policy, Virus, and Outbreak Quarantines, on page 899](#).

Enabling Anti-Virus Scanning

Your appliance may ship with a 30-day evaluation key for the Sophos Anti-Virus or McAfee Anti-Virus scanning engines. During this portion of the System Setup Wizard, you can choose to enable an anti-virus scanning engine globally on the appliance .

If you choose to enable an anti-virus scanning engine, it is enabled for both the default incoming and default outgoing mail policies. The appliance scans mail for viruses, but it does not repair infected attachments. The appliance drops infected messages.

See [Anti-Virus, on page 341](#) for all of the anti-virus configuration options available on the appliance.

Enabling Advanced Malware Protection (File Reputation and Analysis Services)

Advanced Malware Protection obtains reputation information about attached files from a cloud-based service.

For more information, see [File Reputation Filtering and File Analysis, on page 457](#)

Enabling Outbreak Filters

Your appliance may ship with a 30-day evaluation key for Outbreak Filters. Outbreak Filters provide a “first line of defense” against new virus outbreaks by quarantining suspicious messages until traditional anti-virus security services can be updated with a new virus signature file.

See [Outbreak Filters, on page 401](#) for more information.

Click **Next** to continue.

Step 5: Review

A summary of the configuration information is displayed. You can edit the System Settings, Network Integration, and Message Security information by clicking the **Previous** button or by clicking the corresponding **Edit** link in the upper-right of each section. When you return to a step to make a change, you must proceed through the remaining steps until you reach this review page again. All settings you previously entered will be remembered.

Once you are satisfied with the information displayed click **Install This Configuration**.

A confirmation dialog is displayed. Click **Install** to install the new configuration.

Your appliance is now ready to send email.



Note

Clicking **Install** will cause the connection to the current URL (<http://192.168.42.42>) to be lost if you changed the IP address of the interface you used to connect to the appliance from the default. However, your browser will be redirected to the new IP address.

Once System Setup is complete, several alert messages are sent. See [Immediate Alerts, on page 55](#) for more information.

Setting up the Connection to Active Directory

If the System Setup Wizard properly installs the configuration on the appliance, the Active Directory Wizard appears. If you are running an Active Directory server on your network, use the Active Directory Wizard to configure an LDAP server profile for the Active Directory server and assign a listener for recipient validation. If you are not using Active Directory or want to configure it later, click Skip this Step. You can run the Active Directory Wizard on the **System Administration > Active Directory Wizard** page. You can also configure Active Directory and other LDAP profiles on the **System Administration > LDAP** page.

The Active Directory Wizard retrieves the system information needed to create an LDAP server profile, such as the authentication method, the port, the base DN, and whether SSL is supported. The Active Directory Wizard also creates LDAP accept and group queries for the LDAP server profile.

After the Active Directory Wizard creates the LDAP server profile, use the **System Administration > LDAP** page to view the new profile and make additional changes. It is recommended that you avoid changing LDAP settings on Cloud Email Security appliances.

Procedure

Step 1 On the Active Directory Wizard page, click **Run Active Directory Wizard**.

- Step 2** Enter the host name for the Active Directory server.
- Step 3** Enter a username and passphrase for the authentication request.
- Step 4** Click **Next** to continue.
- The Active Directory Wizard tests the connection to the Active Directory server. If successful, the Test Directory Settings page is displayed.
- Step 5** Test the directory settings by entering an email address that you know exists in the Active Directory and clicking **Test**. The results appear in the connection status field.
- Step 6** Click **Done**.
-

Proceeding to the Next Steps

After you successfully configure your appliance to work with your Active Directory Wizard, or skip the process, the System Setup Next Steps page appears.

Click the links on the System Setup Next Steps page to proceed with the configuration of your appliance.

Accessing the Command Line Interface (CLI)

Access to the CLI varies depending on the management connection method you chose in [Connecting to the Appliance](#), on page 25. The factory default username and passphrase are listed next. Initially, only the admin user account has access to the CLI. You can add other users with differing levels of permission after you have accessed the command line interface for the first time via the admin account. (For information about adding users, see [Adding Users](#), on page 952.) The System Setup Wizard asks you to change the passphrase for the admin account. The passphrase for the admin account can also be reset directly at any time using the `passphrase` command.

To connect via Ethernet: Start an SSH session with the factory default IP address 192.168.42.42. SSH is configured to use port 22. Enter the username and passphrase below.

To connect via a Serial connection: Start a terminal session with the communication port on your personal computer that the serial cable is connected to. Use the settings for serial port outlined in [Connecting to the Appliance](#), on page 25. Enter the username and passphrase below.

Log in to the appliance by entering the username and passphrase.

Related Topics

- [Factory Default Username and Passphrase, on page 31](#)

Factory Default Username and Passphrase

If you install a new virtual or hardware appliance, you must change the default passphrase to get complete access to set up the appliance. When you log in to the appliance for the first time, the web interface prompts you to change the default passphrase, and the CLI limits the access to the following commands till you change the default passphrase.

- `Commit`
- `Interfaceconfig`

- passphrase
- Loadconfig
- Systemsetup
- loadlicense (for virtual appliances)
- feature key
- Ping
- Telnet
- netstat

- Username: `admin`
- Passphrase: `ironport`

For Example:

```
login: admin
passphrase: ironport
```



Note

If your session times out, you will be asked to re-enter your username and passphrase. If your session times out while you are running the System Setup Wizard, you will have to start over again.

Running the Command Line Interface (CLI) System Setup Wizard

The CLI version of the System Setup Wizard basically mirrors the steps in the GUI version, with a few minor exceptions:

- The CLI version includes prompts to enable the web interface.
- The CLI version allows you to edit the default Mail Flow Policy for each listener you create.
- The CLI version contains prompts for configuring the global Anti-Virus and Outbreak Filters security settings.
- The CLI version does not prompt you to create an LDAP profile after the system setup is complete. Use the `ldapconfig` command to create an LDAP profile.

To run the System Setup Wizard, type `systemsetup` at the command prompt.

```
IronPort> systemsetup
```

The System Setup Wizard warns you that you will reconfigure your system. If this is the very first time you are installing the appliance , or if you want to completely overwrite your existing configuration, answer “Yes” to this question.

```
WARNING: The system setup wizard will completely delete any existing
```

```
'listeners' and all associated settings including the 'Host Access Table' -
mail operations may be interrupted.
```

Are you sure you wish to continue? [Y]> Y



Note The remainder of the system setup steps are described below. Examples of the CLI System Setup Wizard dialogue will only be included for sections that deviate from the GUI System Setup Wizard described above in [Defining Basic Configuration Using the Web-Based System Setup Wizard](#) , on page 32.

Related Topics

- [Change the Admin Passphrase](#), on page 43
- [Accept the License Agreement](#), on page 43
- [Set the Hostname](#) , on page 43
- [Assign and Configure Logical IP Interface\(s\)](#), on page 44
- [Specify the Default Gateway](#), on page 44
- [Enable the Web Interface](#), on page 45
- [Configure the DNS Settings](#), on page 45
- [Create a Listener](#), on page 45
- [Enable Anti-Spam](#), on page 52
- [Select a Default Anti-Spam Scanning Engine](#), on page 53
- [Enable the Spam Quarantine](#), on page 53
- [Enable Anti-Virus Scanning](#), on page 53
- [Enable Outbreak Filters](#) , on page 53
- [Configure the Alert Settings and AutoSupport](#), on page 54
- [Configure Scheduled Reporting](#), on page 54
- [Configure Time Settings](#), on page 54
- [Commit Changes](#), on page 54
- [Test the Configuration](#), on page 54
- [Immediate Alerts](#), on page 55

Change the Admin Passphrase

First, you change the passphrase for the AsyncOS admin account. You must enter the old passphrase to continue. The new passphrase must be six characters or longer. Be sure to keep the passphrase in a secure location. Changes made to the passphrase are effective once the system setup process is finished.

Accept the License Agreement

Read and accept the software license agreement that is displayed.

Set the Hostname

Next, you define the fully-qualified hostname for the appliance . This name should be assigned by your network administrator.

Assign and Configure Logical IP Interface(s)

The next step assigns and configures a logical IP interface on the physical Ethernet interface named Management (on C390, and C690 appliances) or Data 1 (on C190 appliances), and then prompts you to configure a logical IP interface on any other physical Ethernet interfaces available on the appliance .

Each Ethernet interface can have multiple IP interfaces assigned to it. An IP interface is a logical construct that associates an IP address and hostname with a physical Ethernet interface. If you decided to use both the Data 1 and Data 2 Ethernet ports, you need the IP addresses and hostnames for both connections.

For C390, and C690 appliances: Cisco recommends using one of the physical Ethernet ports to connect directly to the Internet for the purposes of receiving inbound email through public listeners, and using another physical Ethernet port to connect directly to your internal network for the purposes of relaying outbound email through private listeners.

For C190 appliances: By default, the `systemsetup` command will configure only one physical Ethernet port with one listener for receiving inbound email and relaying outbound email.



Note When you configure an interface to relay outbound mail, the system turns on SSH for the interface as long as no public listeners are configured to use the interface.

The following information is required:

- A **name** (nickname) created by you to refer to the IP interface later. For example, if you are using one Ethernet port for your private network and the other for the public network, you may want to name them PrivateNet and PublicNet, respectively.



Note The names you define for interfaces are case-sensitive. AsyncOS will not allow you to create two identical interface names. For example, the names `Privatenet` and `PrivateNet` are considered as two *different* (unique) names.

- The **IP address** assigned by your network administrator. This can be an IPv4 or IPv6 address, You can assign both types of IP addresses to a single IP interface.
- The **netmask** of the interface. The netmask must be in CIDR format. For example, use `/24` for the `255.255.255.0` subnet.



Note IP addresses within the same subnet cannot be configured on separate physical Ethernet interfaces. See [Assigning Network and IP Addresses, on page 1267](#) for more detailed information on Network and IP Address configuration.

For C190 appliances, the Data 2 interface is configured first.

Specify the Default Gateway

In the next portion of the `systemsetup` command, you type the IP address of the default router (gateway) on your network.

Enable the Web Interface

In the next portion of the `systemsetup` command, you enable the web interface for the appliance (for the Management Ethernet interface). You can also choose to run the web interface over secure HTTP (`https`). If you choose to use HTTPS, the system will use a demonstration certificate until you upload your own certificate.

Configure the DNS Settings

Next, you configure the DNS (Domain Name Service) settings. Cisco AsyncOS contains a high-performance internal DNS resolver/cache that can query the Internet's root servers directly, or the system can use your own DNS servers. If you choose to use your own servers, you will need to supply the IP address and hostname of each DNS server. You can enter as many DNS servers as you need (each server will have a priority of 0.). By default, `systemsetup` prompts you to enter the addresses for your own DNS servers.

Create a Listener

A “listener” manages inbound email processing services that will be configured on a particular IP interface. Listeners only apply to email entering the appliance — either from your internal systems or from the Internet. Cisco AsyncOS uses listeners to specify criteria that messages must meet in order to be accepted and relayed to recipient hosts. You can think of a listener as an email listener (or even a “SMTP daemon”) running for IP addresses you specified above.

For C390, and C690 appliances: By default, the `systemsetup` command configures two listeners — one public and one private. (For more information on the types of listeners available, see [Configuring the Gateway to Receive Email, on page 69.](#))

For C190 appliances: By default, the `systemsetup` command configures one public listener for both receiving mail from the Internet and for relaying email from your internal network. See [Listener Example for C190 Appliances , on page 50.](#)

When you define a listener, you specify the following attributes:

- A **name** (nickname) created by you to refer to the listener later. For example, the listener that accepts email from your internal systems to be delivered to the Internet may be called OutboundMail.
- One of the IP interfaces (that you created earlier in the `systemsetup` command) on which to receive email.
- The name of the machine(s) to which you want to route email (public listeners only). (This is the first `smtproutes` entry. See [Routing Email for Local Domains, on page 671.](#))
- Whether or not to enable filtering based on IP Reputation Scores for public listeners. If enabled, you are also prompted to select between Conservative, Moderate, or Aggressive settings.
- Rate-limiting per host: the maximum number of recipients per hour you are willing to receive from a remote host (public listeners only).
- The recipient domains or specific addresses you want to accept email for (public listeners) or the systems allowed to relay email through the appliance (private listeners). (These are the first Recipient Access Table and Host Access Table entries for a listener. See [Sender Group Syntax, on page 95](#) and [Adding Domains and Users For Which to Accept Messages, on page 127](#) for more information.)

Related Topics

- [Public Listener, on page 46](#)
- [Private Listener, on page 48](#)
- [Listener Example for C190 Appliances , on page 50](#)

Public Listener



Note The following examples of creating a public and private listener apply to C390, and C690 appliances only. For C190 appliances, skip to the next section, [Listener Example for C190 Appliances](#), on page 50.

In this example portion of the `systemsetup` command, a public listener named `InboundMail` is configured to run on the `PublicNet` IP interface. Then, it is configured to accept all email for the domain `example.com`. An initial SMTP route to the mail exchange `exchange.example.com` is configured. Rate limiting is enabled, and the maximum value of 4500 recipients per hour from a single host is specified for the public listener.



Note The value you enter for maximum recipients per hour you are willing to receive from a remote host is a completely arbitrary value, one that is usually relative to the size of the enterprise for which you are administering email. For example, a sender who sends 200 messages in an hour might be considered a “spammer” (sender of unsolicited bulk email), but if you are configuring the appliance to handle all email for a 10,000 person company, 200 messages per hour from a remote host may be a reasonable value. Conversely, in a 50-person company, someone sending 200 messages in an hour to you may be an obvious spammer. You must choose an appropriate value when you enable rate-limiting on a public listener (throttle) inbound email for your enterprise. For more information on Default Host Access policies, see [Sender Group Syntax](#), on page 95.

The default host access policy for the listener is then accepted.

You are now going to configure how the appliance accepts mail by

creating a "Listener".

Please create a name for this listener (Ex: "InboundMail"):

```
[ ]> InboundMail
```

Please choose an IP interface for this Listener.

1. Management (192.168.42.42/24: mail3.example.com)
2. PrivateNet (192.168.1.1/24: mail3.example.com)
3. PublicNet (192.168.2.1/24: mail3.example.com)

```
[1]> 3
```

Enter the domains or specific addresses you want to accept mail for.

Hostnames such as "example.com" are allowed.

Partial hostnames such as ".example.com" are allowed.

Username such as "postmaster@" are allowed.

Full email addresses such as "joe@example.com" or "joe@[1.2.3.4]" are allowed.

Separate multiple addresses with commas.

```
[ ]> example.com
```

Would you like to configure SMTP routes for example.com? [Y]> **y**

Enter the destination mail server which you want mail for example.com to be delivered.
Separate multiple entries with commas.

```
[ ]> exchange.example.com
```

Do you want to enable rate limiting for this listener? (Rate limiting defines the maximum number of recipients per hour you are willing to receive from a remote domain.) [Y]> **y**

Enter the maximum number of recipients per hour to accept from a remote domain.

```
[ ]> 4500
```

Default Policy Parameters

=====

Maximum Message Size: 100M

Maximum Number Of Connections From A Single IP: 1,000

Maximum Number Of Messages Per Connection: 1,000

Maximum Number Of Recipients Per Message: 1,000

Maximum Number Of Recipients Per Hour: 4,500

Maximum Recipients Per Hour SMTP Response:

452 Too many recipients received this hour

```

Use SenderBase for Flow Control:  Yes

Virus Detection Enabled:  Yes

Allow TLS Connections:  No

Would you like to change the default host access policy?  [N]> n

Listener InboundMail created.

Defaults have been set for a Public listener.

Use the listenerconfig->EDIT command to customize the listener.

*****

```

Private Listener

In this example portion of the `systemsetup` command, a private listener named `OutboundMail` is configured to run on the PrivateNet IP interface. Then, it is configured to relay all email for all hosts within the domain `example.com`. (Note the dot at the beginning of the entry: `.example.com`)

The default value for rate limiting (not enabled) and the default host access policy for this listener are then accepted.

Note that the default values for a private listener differ from the public listener created earlier. For more information, see [Working with Listeners, on page 70](#).

```
Do you want to configure the appliance to relay mail for internal hosts?  [Y]> y
```

```
Please create a name for this listener (Ex: "OutboundMail"):
```

```
[ ]> OutboundMail
```

```
Please choose an IP interface for this Listener.
```

1. Management (192.168.42.42/24: mail3.example.com)
2. PrivateNet (192.168.1.1/24: mail3.example.com)
3. PublicNet (192.168.2.1/24: mail3.example.com)

```
[1]> 2
```

```
Please specify the systems allowed to relay email through the appliance.
```

Hostnames such as "example.com" are allowed.

Partial hostnames such as ".example.com" are allowed.

IP addresses, IP address ranges, and partial IP addresses are allowed.

Separate multiple entries with commas.

```
[ ]> .example.com
```

```
Do you want to enable rate limiting for this listener?  
(Rate limiting defines the maximum number of recipients per hour you are willing  
to receive from a remote domain.) [N]> n
```

Default Policy Parameters

=====

Maximum Message Size: 100M

Maximum Number Of Connections From A Single IP: 600

Maximum Number Of Messages Per Connection: 10,000

Maximum Number Of Recipients Per Message: 100,000

Maximum Number Of Recipients Per Hour: Disabled

Use SenderBase for Flow Control: No

Virus Detection Enabled: Yes

Allow TLS Connections: No

```
Would you like to change the default host access policy? [N]> n
```

Listener OutboundMail created.

Defaults have been set for a Private listener.

Use the listenerconfig->EDIT command to customize the listener.

Listener Example for C190 Appliances



Note The following example of creating a listener applies to C170 and C190 appliances only.

In this example portion of the `systemsetup` command, a listener named `MailInterface` is configured to run on the MailNet IP interface. Then, it is configured to accept all email for the domain `example.com`. An initial SMTP route to the mail exchange `exchange.example.com` is configured. Then, the same listener is configured to relay all email for all hosts within the domain `example.com`. (Note the dot at the beginning of the entry: `.example.com`)

Rate limiting is enabled, and the maximum value of 450 recipients per hour from a single host is specified for the public listener.



Note The value you enter for maximum recipients per hour you are willing to receive from a remote host is a completely arbitrary value, one that is usually relative to the size of the enterprise for which you are administering email. For example, a sender who sends 200 messages in an hour might be considered a “spammer” (sender of unsolicited bulk email), but if you are configuring the appliance to handle all email for a 10,000 person company, 200 messages per hour from a remote host may be a reasonable value. Conversely, in a 50-person company, someone sending 200 messages in an hour to you may be an obvious spammer. You must choose an appropriate value when you enable rate-limiting on a public listener (throttle) inbound email for your enterprise. For more information on Default Host Access policies, see [Sender Group Syntax, on page 95](#).

The default host access policy for the listener is then accepted.

You are now going to configure how the appliance accepts mail by creating a "Listener".

Please create a name for this listener (Ex: "MailInterface"):

```
[ ]> MailInterface
```

Please choose an IP interface for this Listener.

1. MailNet (10.1.1.1/24: mail3.example.com)
2. Management (192.168.42.42/24: mail3.example.com)

```
[1]> 1
```

Enter the domain names or specific email addresses you want to accept mail for.

Hostnames such as "example.com" are allowed.

Partial hostnames such as ".example.com" are allowed.

Username such as "postmaster@" are allowed.

Full email addresses such as "joe@example.com" or "joe@[1.2.3.4]" are allowed.

Separate multiple addresses with commas.

```
[ ]> example.com
```

Would you like to configure SMTP routes for example.com? [Y]> **y**

Enter the destination mail server where you want mail for example.com to be delivered.
Separate multiple entries with commas.

```
[ ]> exchange.example.com
```

Please specify the systems allowed to relay email through the appliance.

Hostnames such as "example.com" are allowed.

Partial hostnames such as ".example.com" are allowed.

IP addresses, IP address ranges, and partial IP addresses are allowed.

Separate multiple entries with commas.

```
[ ]> .example.com
```

Do you want to enable rate limiting for this listener?
(Rate limiting defines the maximum number of recipients per hour you are willing
to receive from a remote domain.) [Y]> **y**

Enter the maximum number of recipients per hour to accept from a remote domain.

```
[ ]> 450
```

Default Policy Parameters

=====

```

Maximum Message Size: 10M

Maximum Number Of Connections From A Single IP: 50

Maximum Number Of Messages Per Connection: 100

Maximum Number Of Recipients Per Message: 100

Maximum Number Of Recipients Per Hour: 450

Maximum Recipients Per Hour SMTP Response:

    452 Too many recipients received this hour

Use SenderBase for Flow Control: Yes

Spam Detection Enabled: Yes

Virus Detection Enabled: Yes

Allow TLS Connections: No

Would you like to change the default host access policy? [N]>

Listener MailInterface created.

Defaults have been set for a Public listener.

Use the listenerconfig->EDIT command to customize the listener.

*****

```



Note Because the `systemsetup` command only configures one listener for both inbound and outbound mail for C170 and C190 appliances, all outgoing mail will be calculated in the Mail Flow Monitor feature (which is normally used for inbound messages). See [Using Email Security Monitor, on page 807](#)

Enable Anti-Spam

Your appliance ships with a 30-day evaluation key for the Anti-Spam software. During this portion of the `systemsetup` command, you can choose to accept the license agreements and enable Anti-Spam globally on the appliance .

Anti-Spam scanning will then be enabled on the incoming mail policy.



Note If you do not accept the license agreement, Anti-Spam is not enabled on the appliance .

See [Managing Spam and Graymail, on page 359](#) for all of the Anti-Spam configuration options available on the appliance.

Select a Default Anti-Spam Scanning Engine

If you have enabled more than one anti-spam scanning engine, you are prompted to select which engine will be enabled for use on the default incoming mail policy.

Enable the Spam Quarantine

If you choose to enable an anti-spam service, you can enable the incoming mail policy to send spam and suspected spam messages to the local Spam Quarantine. Enabling the Spam Quarantine also enables the end-user quarantine on the appliance . Only administrators can access the end-user quarantine until end-user access is configured.

See [Setting Up the Local Spam Quarantine, on page 920](#) .

Enable Anti-Virus Scanning

Your appliance ships with a 30-day evaluation key for virus scanning engines. During this portion of the `systemsetup` command, you can choose to accept one or more license agreements and enable anti-virus scanning on the appliance . You must accept a license agreement for each anti-virus scanning engine you want to enable on your appliance .

After you accept the agreement, the anti-virus scanning engine you selected is enabled on the incoming mail policy. The appliance scans incoming mail for viruses, but it does not repair infected attachments. The appliance drops infected messages.

See [Anti-Virus, on page 341](#) for the anti-virus configuration options available on the appliance .

Enable Outbreak Filters

This next step prompts you to enable Outbreak Filters. Your appliance ships with a 30-day evaluation key for Outbreak Filters.

Related Topics

- [Outbreak Filters, on page 53](#)

Outbreak Filters

Outbreak Filters provide a “first line of defense” against new virus outbreaks by quarantining suspicious messages until traditional Anti-Virus security services can be updated with a new virus signature file. If enabled, Outbreak Filters will be enabled on the default Incoming Mail Policy.

If you choose to enable Outbreak Filters, enter a threshold value and whether you would like to receive Outbreak Filters alerts. For more information about Outbreak Filters and threshold values, see [Outbreak Filters, on page 401](#).

Configure the Alert Settings and AutoSupport

Cisco AsyncOS sends alert messages to a user via email if there is a system error that requires the user's intervention. Add at least one email address that receives system alerts. Separate multiple addresses with commas. The email addresses that you enter initially receive all types of alerts at all levels, except for Directory Harvest Attack Prevention alerts. You can add more granularity to the alert configuration later using the `alertconfig` command in the CLI or the **System Administration > Alerts** page in the GUI. For more information, see section *Alerts* of chapter *Distributing Administrative Tasks* of the *Cisco Email Security Appliance Guide*.

The AutoSupport feature keeps the Cisco Customer Support team aware of issues with your appliance so that Cisco can provide industry-leading support to you. Answer “Yes” to send Cisco support alerts and weekly status updates. (For more information, see section *AutoSupport* of chapter *Distributing Administrative Tasks* of the *Cisco Email Security Appliance Guide*.)

Configure Scheduled Reporting

Enter an address to which to send the default scheduled reports. You can leave this value blank and the reports will be archived on the appliance instead of sent via email.

Configure Time Settings

Cisco AsyncOS allows you to use the Network Time Protocol (NTP) to synchronize time with other servers on your network or the Internet, or to manually set the system clock. You must also set the time zone on the appliance so that timestamps in message headers and log files are correct. You can also use the Cisco Systems time servers to synchronize the time on your appliance.

Choose the Continent, Country, and Timezone and whether to use NTP including the name of the NTP server to use.

Commit Changes

Finally, the System Setup Wizard will ask you to `commit` the configuration changes you have made throughout the procedure. Answer “Yes” if you want to commit the changes.

When you have successfully completed the System Setup Wizard, the following message will appear and you will be presented with the command prompt:

```
Congratulations! System setup is complete. For advanced configuration, please refer to the
User Guide.
```

```
mail3.example.com>
```

The appliance is now ready to send email.

Test the Configuration

To test the Cisco AsyncOS configuration, you can use the `mailconfig` command immediately to send a test email containing the system configuration data you just created with the `systemsetup` command:

```
mail3.example.com> mailconfig
```

```
Please enter the email address to which you want to send
```

the configuration file. Separate multiple addresses with commas.

```
[ ]> user@example.com
```

The configuration file has been sent to user@example.com.

```
mail3.example.com>
```

Send the configuration to a mailbox to which you have access to confirm that the system is able to send email on your network.

Immediate Alerts

The appliance uses feature keys to enable features. The first time you create a listener in the `systemsetup` command, enable Anti-Spam, enable Sophos or McAfee Anti-Virus, or enable Outbreak Filters, an alert is generated and sent to the addresses you specified in [Step 2: System, on page 34](#).

The alert notifies you periodically of the time remaining on the key. For example:

```
Your "Receiving" key will expire in under 30 day(s).  
Please contact IronPort Customer Support.
```

```
Your "Sophos" key will expire in under 30 day(s).  
Please contact IronPort Customer Support.
```

```
Your "Outbreak Filters" key will expire in under 30 day(s).  
Please contact IronPort Customer Support.
```

For information on enabling a feature beyond the 30-day evaluation period, contact your Cisco sales representative. You can see how much time remains on a key via the **System Administration > Feature Keys** page or by issuing the `featurekey` command. (For more information, see [Feature Keys, on page 986](#).)

Configuring your system as an Enterprise Gateway

To configure your system as an Enterprise Gateway (accepting email from the Internet), complete this chapter first, and then see [Configuring the Gateway to Receive Email, on page 69](#) for more information.

Verifying Your Configuration and Next Steps

Now that system setup is complete, your appliance should be sending and receiving email. If you have enabled the anti-virus, anti-spam, and virus-outbreak filters security features, the system will also be scanning incoming and outgoing mail for spam and viruses.

The next step is to understand how to customize your appliance's configuration. [Understanding the Email Pipeline, on page 57](#) provides a detailed overview of how email is routed through the system. Each feature is processed in order (from top to bottom) and is described in the remaining chapters of this guide.



CHAPTER 4

Understanding the Email Pipeline

This chapter contains the following sections:

- [Overview of the Email Pipeline, on page 57](#)
- [Email Pipeline Flows, on page 57](#)
- [Incoming / Receiving, on page 60](#)
- [Work Queue / Routing, on page 62](#)
- [Delivery, on page 66](#)

Overview of the Email Pipeline

The Email Pipeline is the flow of email as it is processed by the appliance . It has three phases:

- **Receipt** — As the appliance connects to a remote host to receive incoming email, it adheres to configured limits and other receipt policies. For example, verifying that the host can send your users mail, enforcing incoming connection and message limits, and validating the message's recipient.
- **Work Queue** — The appliance processes incoming and outgoing mail, performing tasks such as filtering, safelist/blocklist scanning, anti-spam and anti-virus scanning, Outbreak Filters, and quarantining.
- **Delivery** — As the appliance connects to send outgoing email, it adheres to configured delivery limits and policies. For example, enforcing outbound connection limits and processing undeliverable messages as specified.

Email Pipeline Flows

The following figures provide an overview of how email is processed through the system, from receipt to routing to delivery. Each feature is processed in order (from top to bottom). You can test most of the configurations of features in this pipeline using the trace command.

Figure 6: Email Pipeline — Receiving Email Connections

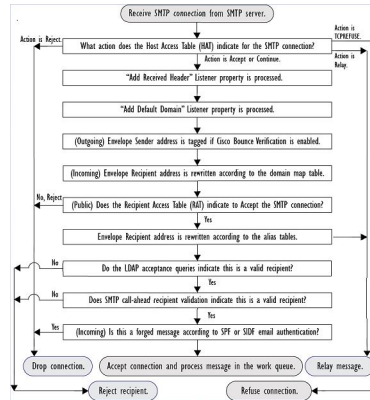

Figure 7: Email Pipeline — Work Queue

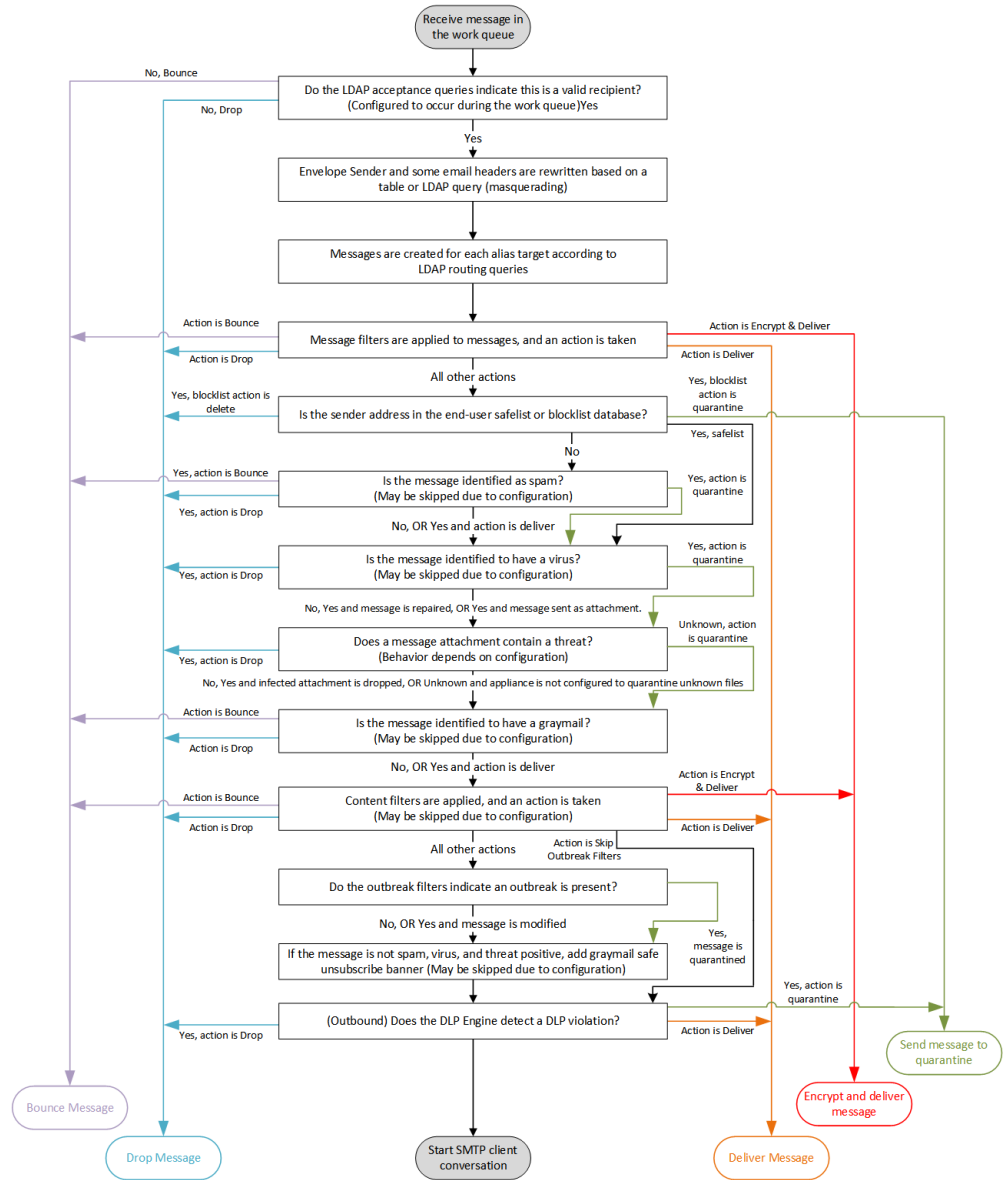
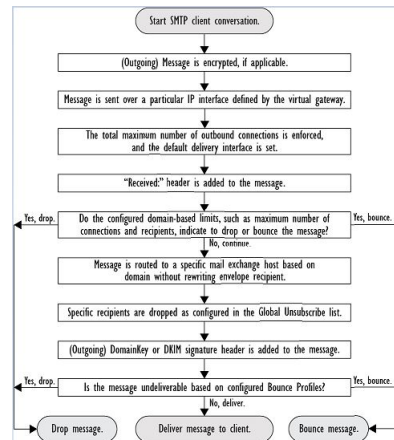

Figure 8: Email Pipeline — Delivering Email



Incoming / Receiving

The receiving phase of the Email Pipeline involves the initial connection from the sender's host. Each message's domains can be set, the recipient is checked, and the message is handed off to the work queue.

Related Topics

- [Host Access Table \(HAT\), Sender Groups, and Mail Flow Policies, on page 60](#)
- [Received: Header, on page 61](#)
- [Default Domain, on page 61](#)
- [Bounce Verification, on page 61](#)
- [Domain Map, on page 61](#)
- [Recipient Access Table \(RAT\), on page 61](#)
- [Alias Tables, on page 61](#)
- [LDAP Recipient Acceptance, on page 62](#)
- [SMTP Call-Ahead Recipient Validation, on page 62](#)

Host Access Table (HAT), Sender Groups, and Mail Flow Policies

The HAT allows you to specify hosts that are allowed to connect to a listener (that is, which hosts you will allow to send email).

Sender Groups are used to associate one or more senders into groups, upon which you can apply message filters, and other Mail Flow Policies. Mail Flow Policies are a way of expressing a group of HAT parameters (access rule, followed by rate limit parameters and custom SMTP codes and responses).

Together, sender groups and mail flow policies are defined in a listener's HAT.

Host DNS verification settings for sender groups allow you to classify unverified senders prior to the SMTP conversation and include different types of unverified senders in your various sender groups.

While the connecting host was subject to Host DNS verification in sender groups — prior to the SMTP conversation — the domain portion of the envelope sender is DNS verified in mail flow policies, and the verification takes place during the SMTP conversation. Messages with malformed envelope senders can be

ignored. You can add entries to the Sender Verification Exception Table — a list of domains and email addresses from which to accept or reject mail despite envelope sender DNS verification settings.

Sender reputation filtering allows you to classify email senders and restrict access to your email infrastructure based on sender's trustworthiness as determined by the IP Reputation Service.

For more information, see [Understanding Predefined Sender Groups and Mail Flow Policies, on page 102](#).

Received: Header

Using the `listenerconfig` command, you can configure a listener to not include the Received: header by default to all messages received by the listener.

For more information, see [Working with Listeners, on page 70](#).

Default Domain

You can configure a listener to automatically append a default domain to sender addresses that do not contain fully-qualified domain names; these are also known as “bare” addresses (such as “joe” vs. “joe@example.com”).

For more information, see [Working with Listeners, on page 70](#).

Bounce Verification

Outgoing mail is tagged with a special key, and so if that mail is sent back as a bounce, the tag is recognized and the mail is delivered. For more information, see [Bounce Verification, on page 709](#).

Domain Map

For each listener you configure, you can construct a domain map table which rewrites the envelope recipient for each recipient in a message that matches a domain in the domain map table. For example, joe@old.com -> joe@new.com

For more information, see [The Domain Map Feature, on page 694](#).

Recipient Access Table (RAT)

For inbound email only, the RAT allows you to specify a list of all local domains for which the appliance will accept mail.

For more information, see [Overview of Accepting or Rejecting Connections Based on the Recipient's Address, on page 125](#).

Alias Tables

Alias tables provide a mechanism to redirect messages to one or more recipients. Aliases are stored in a mapping table. When the envelope recipient (also known as the Envelope To, or RCPT TO) of an email matches an alias as defined in an alias table, the envelope recipient address of the email will be rewritten.

For more information about Alias Tables, see [Creating Alias Tables, on page 677](#).

LDAP Recipient Acceptance

You can use your existing LDAP infrastructure to define how the recipient email address of incoming messages (on a public listener) should be handled during the SMTP conversation or within the workqueue. For more information, see [Working with Listeners, on page 70](#). This allows the appliance to combat directory harvest attacks (DHAP) in a unique way: the system accepts the message and performs the LDAP acceptance validation within the SMTP conversation or the work queue. If the recipient is not found in the LDAP directory, you can configure the system to perform a delayed bounce or drop the message entirely.

For more information, see [Working with LDAP Queries, on page 759](#).

SMTP Call-Ahead Recipient Validation

When you configure your appliance for SMTP call-ahead recipient validation, the appliance suspends the SMTP conversation with the sending MTA while it “calls ahead” to the SMTP server to verify the recipient. When the appliance queries the SMTP server, it returns the SMTP server’s response to the appliance. The appliance resumes the SMTP conversation and sends a response to the sending MTA, allowing the conversation to continue or dropping the connection based on the SMTP server response (and settings you configure in the SMTP Call-Ahead profile).

For more information, see [Validating Recipients Using an SMTP Server, on page 643](#)

Work Queue / Routing

The Work Queue is where the received message is processed before moving to the delivery phase. Processing includes masquerading, routing, filtering, safelist/blocklist scanning, anti-spam and anti-virus scanning, file reputation scanning and analysis, Outbreak Filters, and quarantining.



Note

Data loss prevention (DLP) scanning is only available for outgoing messages. For information on where DLP message scanning occurs in the Work Queue, see [Message Splintering, on page 261](#).

Related Topics

- [Email Pipeline and Security Services, on page 62](#)
- [LDAP Recipient Acceptance, on page 62](#)
- [Masquerading or LDAP Masquerading, on page 63](#)
- [LDAP Routing, on page 63](#)
- [Message Filters, on page 64](#)
- [Email Security Manager \(Per-Recipient Scanning\), on page 64](#)
- [Quarantines, on page 65](#)

Email Pipeline and Security Services

It is recommended that you enable and avoid changing security services on Cloud Email Security appliances

Note, as a general rule, changes to security services (anti-spam scanning, anti-virus scanning, and Outbreak Filters) do not affect messages already in the work queue. As an example:

If a message bypasses anti-virus scanning when it first enters the pipeline because of any of these reasons:

- anti-virus scanning was not enabled globally for the appliance, or
- the HAT policy was to skip anti-virus scanning, or
- there was a message filter that caused the message to bypass anti-virus scanning,

then the message will not be anti-virus scanned upon release from the quarantine, regardless of whether anti-virus scanning has been re-enabled. However, messages that bypass anti-virus scanning due to mail policies may be anti-virus scanned upon release from a quarantine, as the mail policy's settings may have changed while the message was in the quarantine. For example, if a message bypasses anti-virus scanning due to a mail policy and is quarantined, then, prior to release from the quarantine, the mail policy is updated to include anti-virus scanning, the message will be anti-virus scanned upon release from the quarantine.

Similarly, suppose you had inadvertently disabled anti-spam scanning globally (or within the HAT), and you notice this after mail is in the work queue. Enabling anti-spam at that point will not cause the messages in the work queue to be anti-spam scanned.

LDAP Recipient Acceptance

You can use your existing LDAP infrastructure to define how the recipient email address of incoming messages (on a public listener) should be handled during the SMTP conversation or within the workqueue. For more information, see [Working with Listeners, on page 70](#). This allows the appliance to combat directory harvest attacks (DHAP) in a unique way: the system accepts the message and performs the LDAP acceptance validation within the SMTP conversation or the work queue. If the recipient is not found in the LDAP directory, you can configure the system to perform a delayed bounce or drop the message entirely.

For more information, see [Working with LDAP Queries, on page 759](#).

Masquerading or LDAP Masquerading

Masquerading is a feature that rewrites the envelope sender (also known as the sender, or MAIL FROM) and the To:, From:, and/or CC: headers on email processed by a private or public listener according to a table you construct. You can specify different masquerading parameters for each listener you create in one of two ways: via a static mapping table, or via an LDAP query.

For more information about masquerading via a static mapping table, see [Configuring Masquerading, on page 684](#).

For more information about masquerading via an LDAP query, see [Working with LDAP Queries, on page 759](#).

LDAP Routing

You can configure your appliance to route messages to the appropriate address and/or mail host based upon the information available in LDAP directories on your network.

For more information, see [Working with LDAP Queries, on page 759](#).

Message Filters

Message filters allow you to create special rules describing how to handle messages and attachments as they are received. Filter rules identify messages based on message or attachment content, information about the network, message envelope, message headers, or message body. Filter actions allow messages to be dropped, bounced, archived, quarantined, blind carbon copied, or altered.

For more information, see [Using Message Filters to Enforce Email Policies, on page 131](#).

Multi-recipient messages are “splintered” after this phase, prior to Email Security Manager. Splintering messages refers to creating splinter copies of emails with single recipients, for processing via Email Security Manager.

Email Security Manager (Per-Recipient Scanning)

- [Safelist/Blocklist Scanning, on page 64](#)
- [Anti-Spam, on page 64](#)
- [Anti-Virus, on page 64](#)
- [Graymail Detection and Safe Unsubscribing, on page 65](#)
- [File Reputation Scanning and File Analysis, on page 65](#)
- [Content Filters, on page 65](#)
- [Outbreak Filters, on page 65](#)

Safelist/Blocklist Scanning

End user safelists and blocklists are created by end users and stored in a database that is checked prior to anti-spam scanning. Each end user can identify domains, sub domains or email addresses that they wish to always treat as spam or never treat as spam. If a sender address is part of an end users safelist, anti-spam scanning is skipped, and if the sender address is listed in the blocklist, the message may be quarantined or dropped depending on administrator settings. For more information about configuring safelists and blocklists, see [Spam Quarantine, on page 919](#).

Anti-Spam

Anti-spam scanning offers complete, Internet-wide, server-side anti-spam protection. It actively identifies and defuses spam attacks before they inconvenience your users and overwhelm or damage your network, allowing you to remove unwanted mail before it reaches your users' inboxes, without violating their privacy.

Anti-spam scanning can be configured to deliver mail to the Spam Quarantine (either on- or off-box). Messages released from the Spam Quarantine proceed directly to the destination queue, skipping any further work queue processing in the email pipeline.

For more information, see [Managing Spam and Graymail, on page 359](#).

Anti-Virus

Your appliance includes integrated virus scanning engines. You can configure the appliance to scan messages and attachments for viruses on a per-“mail policy” basis. You can configure the appliance to take actions such as the following when a virus is found:

- attempt to repair the attachment
- drop the attachment

- modify the subject header
- add an additional X- header
- send the message to a different address or mailhost
- archive the message
- delete the message

Messages released from quarantines (see [Quarantines, on page 65](#)) are scanned for viruses. For more information about Anti-Virus scanning, see [Anti-Virus, on page 341](#) .

Graymail Detection and Safe Unsubscribing

You can configure the appliance to detect graymail messages and perform secure unsubscribe on behalf of the end user. Available actions are similar to those for anti-virus scanning.

For more information, see [Managing Spam and Graymail, on page 359](#).

File Reputation Scanning and File Analysis

You can configure the appliance to scan message attachments for emerging and targeted threats. Available actions are similar to those for anti-virus scanning.

For more information, see [File Reputation Filtering and File Analysis, on page 457](#)

Content Filters

You can create content filters to be applied to messages on a per-recipient or per-sender basis. Content filters are similar to message filters, except that they are applied later in the email pipeline — after a message has been “splintered” into a number of separate messages for each matching Email Security Manager policy. The functionality of content filters is applied after message filters processing and anti-spam and anti-virus scanning have been performed on a message.

For more information about Content Filters, see [Content Filters, on page 271](#).

Outbreak Filters

Cisco’s Outbreak Filters feature includes special filters that act proactively to provide a critical first layer of defense against new outbreaks. Based on Outbreak Rules published by Cisco, messages with attachments of specific filetypes can be sent to a quarantine named Outbreak.

Messages in the Outbreak quarantine are processed like any other message in a quarantine. For more information about quarantines and the Work Queue, see [Quarantines, on page 65](#).

For more information, see [Outbreak Filters, on page 401](#) .

Quarantines

You can filter incoming or outgoing messages and place them into quarantines. Quarantines are special queues or repositories used to hold and process messages. Messages in quarantines can be delivered or deleted, based on how you configure the quarantine.

The following Work Queue features can send messages to quarantines:

- Spam filters
- Message Filters
- Anti-Virus

- Outbreak Filters
- Content Filters
- File Analysis (Advanced Malware Protection)

Messages delivered from quarantines are re-scanned for threats.

Related Topics

- [Policy, Virus, and Outbreak Quarantines, on page 899](#)
- [Spam Quarantine, on page 919](#)

Delivery

The delivery phase of the Email Pipeline focuses on the final phase of email processing, including limiting connections, bounces, and recipients.

Related Topics

- [Virtual gateways, on page 66](#)
- [Delivery Limits, on page 66](#)
- [Domain-Based Limits, on page 66](#)
- [Domain-Based Routing, on page 67](#)
- [Global Unsubscribe, on page 67](#)
- [Bounce Limits, on page 67](#)

Virtual gateways

The Virtual Gateway technology enables users to separate the appliance into multiple Virtual Gateway addresses from which to send and receive email. Each Virtual Gateway address is given a distinct IP address, hostname and domain, and email delivery queue.

For more information, see [Configuring Mail Gateways for all Hosted Domains Using Virtual Gateway™ Technology, on page 723](#).

Delivery Limits

Use the `deliveryconfig` command to set limits on delivery, based on which IP interface to use when delivering and the maximum number of concurrent connections the appliance makes for outbound message delivery.

For more information, see [Set Email Delivery Parameters, on page 720](#).

Domain-Based Limits

For each domain, you can assign a maximum number of connections and recipients that will never be exceeded by the system in a given time period. This “good neighbor” table is defined through the Mail Policies > Destination Controls page (or the `destconfig` command).

For more information, see [Controlling Email Delivery Using Destination Controls, on page 708](#).

Domain-Based Routing

Use the Network > SMTP Routes page (or the `smtproutes` command) to redirect all email for a particular domain to a specific mail exchange (MX) host, without rewriting the envelope recipient.

For more information, see [Routing Email for Local Domains, on page 671](#).

Global Unsubscribe

Use Global Unsubscribe to ensure that specific recipients, recipient domains, or IP addresses never receive messages from the appliance. If Global Unsubscribe is enabled, the system will check all recipient addresses against a list of “globally unsubscribed” users, domains, email addresses, and IP Addresses. Matching emails are not sent.

For more information, see [Using Global Unsubscribe, on page 731](#).

Bounce Limits

You use the Network > Bounce Profiles page (or the `bounceconfig` command) to configure how AsyncOS handles hard and soft conversational bounces for each listener you create. You create bounce profiles and then apply profiles to each listener using the Network > Listeners page (or the `listenerconfig` command). You can also assign bounce profiles to specific messages using message filters.

For more information about bounce profiles, see [Directing Bounced Email, on page 700](#).



CHAPTER 5

Configuring the Gateway to Receive Email

This chapter contains the following sections:

- [Overview of Configuring the Gateway to Receive Email, on page 69](#)
- [Working with Listeners, on page 70](#)
- [Configuring Global Settings for Listeners, on page 72](#)
- [Listening for Connection Requests by Creating a Listener Using Web Interface, on page 75](#)
- [Listening for Connection Requests by Creating a Listener Using CLI, on page 80](#)
- [Enterprise Gateway Configuration, on page 82](#)

Overview of Configuring the Gateway to Receive Email

It is recommended that you avoid adding, changing, or deleting listeners on Cloud Email Security appliances .

The appliance functions as the gateway for your organization, servicing email connections, accepting messages, and relaying them to the appropriate systems. The appliance can service email connections from the Internet to recipients hosts inside your network, and from systems inside your network to the Internet. Typically, email connection requests use Simple Mail Transfer Protocol (SMTP). The appliance services SMTP connections by default, and acts as the SMTP gateway, also known as a mail exchanger or “MX,” for the network.

The appliance uses *listeners* to service incoming SMTP connection requests. A listener describes an email processing service that is configured on a particular IP interface. Listeners apply to email entering the appliance, from either the Internet or from systems within your network trying to reach the Internet. Use listeners to specify criteria that messages and connections must meet in order to be accepted and for messages to be relayed to recipient hosts. You can think of a listener as an “SMTP daemon” running on a specific port for each IP address specified. Also, listeners define how the appliance communicates with systems that try to send email to the appliance .

You can create the following types of listeners:

- **Public.** Listens for and accepts email messages coming in from the Internet. Public listeners receive connections from many hosts and direct messages to a limited number of recipients.
- **Private.** Listens for and accepts email messages coming from systems within the network, typically from internal groupware and email servers (POP/IMAP), intended for recipients outside the network in the Internet. Private listeners receive connections from a limited (known) number of hosts and direct messages to many recipients.

When you create a listener, you also must specify the following information:

- **Listener properties.** Define global properties that apply to all listeners, and properties specific to each listener. For example, you can specify the IP interface and port to use for a listener, and whether it is a public or private listener. For details on how to do this, see [Working with Listeners, on page 70](#).
- **Which hosts that are allowed to connect to the listener.** Define a set of rules that control incoming connections from remote hosts. For example, you can define remote hosts and whether or not they can connect to the listener. For details on how to do this, see [Defining Which Hosts Are Allowed to Connect Using the Host Access Table , on page 93](#).
- **(Public listeners only) The local domains for which the listener accepts messages.** Define which recipients are accepted by the public listener. For example, if your organization uses the domain `currentcompany.com` and it previously used `oldcompany.com` , then you might accept messages for both `currentcompany.com` and `oldcompany.com` . For details on how to do this, see [Accepting or Rejecting Connections Based on Domain Name or Recipient Address, on page 125](#).

The settings configured in the listener, including its Host Access Table and Recipient Access Table, affect how the listener communicates with an SMTP server during the SMTP conversation. This allows the appliance to block a spamming host before the connection is closed.

Figure 9: Relationship between Listeners, IP Interfaces, and Physical Ethernet Interfaces

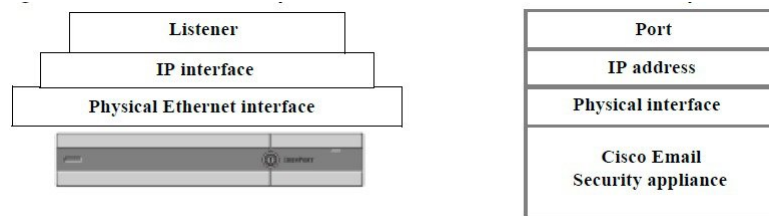

Working with Listeners

Configure listeners on the Network > Listeners page in the GUI, or using the `listenerconfig` command in the CLI.

You can define global settings that apply to all listeners. For more information, see [Configuring Global Settings for Listeners, on page 72](#).

Consider the following rules and guidelines when working with and configuring listeners on the appliance :

- You can define multiple listeners per configured IP interface, but each listener must use a different port.
- By default, listeners use SMTP as the mail protocol to service email connections. However, you can also configure the appliance to service email connections using Quick Mail Queuing Protocol (QMQP). Do this using the `listenerconfig` CLI command.
- Listeners support both Internet Protocol version 4 (IPv4) and version 6 (IPv6) addresses. You can use either protocol version or both on a single listener. The listener uses the same protocol version for mail delivery as the connecting host. For example, if the listener is configured for both IPv4 and IPv6 and connects to a host that uses IPv6, the listener uses IPv6. However, if the listener is configured to only use IPv6 addresses, it cannot connect to a host that is only using IPv4 addresses.
- At least one listener (with default values) is configured on the appliance after running the System Setup Wizard. However, when you create a listener manually, AsyncOS does not use these default IP Reputation score values.

- **C170 and C190 appliances:** By default, the System Setup Wizard walks you through configuring one public listener for both receiving mail from the Internet and for relaying email from your internal network. That is, one listener can perform both functions.
- To help test and troubleshoot the appliance, you can create a “sinkhole” type listener instead of a public or private listener. When you create a sinkhole listener, you choose whether messages are written to disk or not before they are deleted. (See the “Testing and Troubleshooting” chapter for more information.) Writing messages to disk before deleting them can help you measure the rate of receiving and the speed of the queue. A listener that doesn’t write messages to disk can help you measure the pure rate of receiving from your message generation systems. This listener type is only available through the `listenerconfig` command in the CLI.

Figure - Public and Private Listeners on Appliance Models with More than Two Ethernet Interfaces illustrates a typical email gateway configuration created by the System Setup Wizard on appliance models that have more than two Ethernet interfaces. Two listeners are created: a public listener to serve inbound connections on one interface and a private listener to serve outbound connections on a second IP interface.

Figure - Public Listener on Appliance Models with Only Two Ethernet Interfaces illustrates a typical email gateway configuration created by the System Setup Wizard on appliance models that have only two Ethernet interfaces. One public listener on a single IP interface is created to serve both inbound and outbound connections.

Figure 10: Public and Private Listeners on Appliance Models with More than Two Ethernet Interfaces

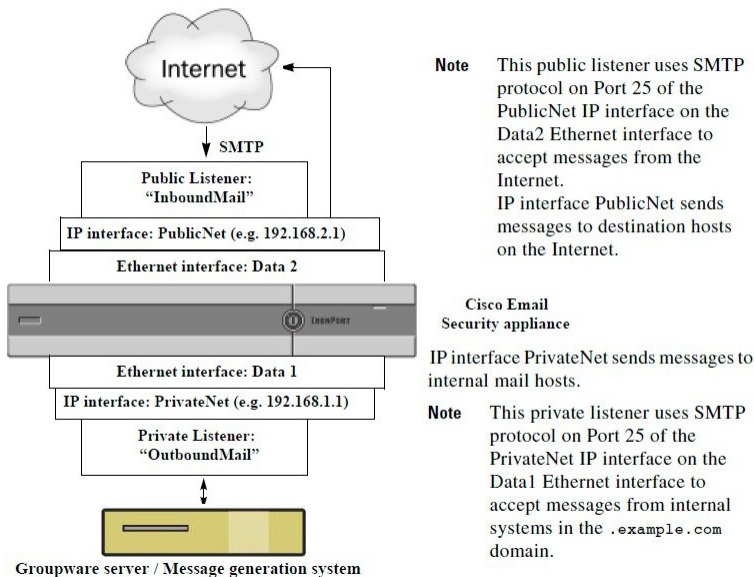
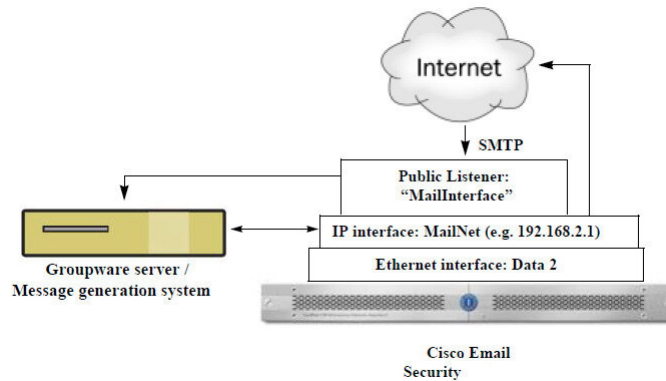

Figure 11: Public Listener on Appliance Models with Only Two Ethernet Interfaces



Note This public listener uses SMTP protocol on Port 25 of the PublicNet IP interface on the Data2 Ethernet interface to accept messages from the Internet and to relay messages from internal systems in the `.example.com` domain. IP interface MailNet sends messages to destination hosts on the Internet and to internal mail hosts

Configuring Global Settings for Listeners

Global settings for the listeners affect all of the listeners that are configured on the appliance. If the listener uses an interface that has both Internet Protocol version 4 (IPv4) and version 6 (IPv6) addresses, the listener settings apply to both IPv4 and IPv6 traffic

Procedure

- Step 1** Choose **Network > Listeners**.
- Step 2** Click **Edit Global Settings**.
- Step 3** Make changes to the settings defined in the following table.

Table 6: Listener Global Settings

Global Setting	Description
Maximum Concurrent Connections	Set the maximum number of concurrent connections for listeners. The default value is 300 for the C3x0 and C6x0 models, and the default value is 50 for the C1x0 models. If the listener accepts both IPv4 and IPv6 connections, the number of connections is divided between the two. For example, if the maximum concurrent connections is 300, then the sum of IPv4 and IPv6 connections cannot exceed 300.
Maximum Concurrent TLS Connections	Set the maximum concurrent TLS connections across all listeners combined. The default value is 100. If the listener accepts both IPv4 and IPv6 TLS connections, the number of connections is divided between the two. For example, if the maximum concurrent connections is 100, then the sum of IPv4 and IPv6 TLS connections cannot exceed 100.

Global Setting	Description
Injection Counters Reset Period	<p>Allows you to adjust when the injection control counters are reset. For very busy systems maintaining counters for a very large number of different IP addresses, configuring the counters to be reset more frequently (for example, every 15 minutes instead of every 60 minutes) will ensure that the data does not grow to an unmanageable size and impact system performance.</p> <p>The current default value is 1 hour. You can specify periods ranging from as little as 1 minute (60 seconds) to as long as 4 hours (14,400 seconds).</p> <p>See Injection Control Periodicity , on page 116.</p>
Timeout Period for Unsuccessful Inbound Connections	<p>Set the length of time AsyncOS will allow an unsuccessful inbound connection to remain intact before closing it.</p> <p>An unsuccessful connection can be an SMTP conversation in which SMTP or ESMTP commands continue to be issued without a successful message injection occurring. When the specified timeout is reached, the behavior is to send an error and disconnect:</p> <p>“421 Timed out waiting for successful message injection, disconnecting.”</p> <p>A connection is considered unsuccessful until it successfully injects a message.</p> <p>Only available for SMTP connections on public listeners. The default value is 5 minutes.</p>
Total Time Limit for All Inbound Connections	<p>Set the length of time AsyncOS will allow an inbound connection to remain intact before closing it.</p> <p>This setting is intended to preserve system resources by enforcing a maximum allowable connection time. Once about 80% of this maximum connection time is reached the following message is issued:</p> <p>“421 Exceeded allowable connection time, disconnecting.”</p> <p>The appliance will attempt to disconnect when the connection exceeds 80% of the maximum connection time in order to prevent disconnecting mid-message. It is likely that a problem is occurring with the inbound connection if it is open long enough to reach 80% of the maximum connection time. Keep this threshold in mind when specifying the time limit.</p> <p>Only available for SMTP connections on public listeners. The default value is 15 minutes.</p>
Maximum size of subject	<p>Messages having subject size within the specified limit will be accepted and any other messages will be rejected. If you set this value to 0, no limit is applied.</p>

Global Setting	Description
HAT delayed rejections	<p>Configure whether to perform HAT rejection at the message recipient level. By default, HAT rejected connections will be closed with a banner message at the start of the SMTP conversation.</p> <p>When an email is rejected due to HAT “Reject” settings, AsyncOS can perform the rejection at the message recipient level (RCPT TO), rather than at the start of the SMTP conversation. Rejecting messages in this way delays the message rejection and bounces the message, allowing AsyncOS to retain more detailed information about the rejected messages. For example, you can see the mail from address and each recipient address of the message which is blocked. Delaying HAT rejections also makes it less likely that the sending MTA will perform multiple retries.</p> <p>When you enable HAT delayed rejection, the following behavior occurs:</p> <p>The MAIL FROM command is accepted, but no message object is created.</p> <p>All RCPT TO commands are rejected with text explaining that access to send e-mail is refused.</p> <p>If the sending MTA authenticates with SMTP AUTH, they are granted a RELAY policy and are allowed to deliver mail as normal.</p> <p>Only configurable from the CLI <code>listenerconfig --> setup</code> command.</p>

Step 4 Submit and commit your changes.

What to do next

Related Topics

- [Settings for Messages Containing Multiple Encodings, on page 74](#)

Settings for Messages Containing Multiple Encodings

You can define the behavior of the appliance while modifying the message encoding for the following parameters:

- Headers
- Untagged non-ASCII headers
- Mismatched footer or heading encoding

To configure this behavior, use the `localeconfig` command in CLI.



Note This behavior cannot be configured using web interface.

For a sample CLI transcript, see [Disclaimer Stamping and Multiple Encodings, on page 634](#).

Listening for Connection Requests by Creating a Listener Using Web Interface

Procedure

- Step 1** Choose `Network > Listener`.
- Step 2** Click **Add Listener**.
- Step 3** Configure the settings defined in the following table.

Table 7: Listener Settings

Name	Unique nickname you supply for the listener, for future reference. The names you define for listeners are case-sensitive. AsyncOS will not allow you to create two identical listener names.
Type of Listener	Choose one of the following types of listeners: <ul style="list-style-type: none"> • Public. Public listeners contain default characteristics for receiving email from the Internet. • Private. Private listeners are intended to be used for private (internal) networks.
Interface	Choose a configured appliance IP interface and TCP port on which to create the listener. Depending on the version of the IP address used by the interface, the listener accepts connections from IPv4 addresses, IPv6 addresses or from both versions. By default, SMTP uses port 25 and QMQP uses port 628.
Bounce Profile	Select a bounce profile (bounce profiles created via the <code>bounceconfig</code> command in the CLI are available in the list, see Creating a New Bounce Profile, on page 707).
Disclaimer Above	Select a disclaimer to attach above or below emails (disclaimers created via the Mail Policies > Text Resources page or the <code>textconfig</code> command in the CLI are available in the list, see the “Text Resources” chapter).
Disclaimer Below	Select a disclaimer to attach above or below emails (disclaimers created via the Mail Policies > Text Resources page or the <code>textconfig</code> command in the CLI are available in the list, see the “Text Resources” chapter).
SMTP Authentication Profile	Specify an SMTP Authentication profile.
Certificate	Specify a certificate for TLS connections to the listener (certificates added via the Network > Certificates page or the <code>certconfig</code> command in the CLI are available in the list, see Overview of Encrypting Communication with Other MTAs, on page 651).

- Step 4** (Optional) Configure settings for controlling parsing in SMTP “MAIL FROM” and “RCPT TO” commands as defined in the following table.

Setting	Description
Address Parser Type	<p>Choose how strictly the appliance adheres to the RFC2821 standard using one of the following parser types:</p> <p>Strict Mode:</p> <ul style="list-style-type: none"> • Strict mode tries to follow RFC 2821. In Strict mode, the address parser follows RFC 2821 rules with the following exceptions/enhancements: • Space is allowed after the colon, as in “MAIL FROM: <joe@example.com>”. • Underscores are allowed in the domain name. • “MAIL FROM” and “RCPT TO” commands are case-insensitive. • Periods are not treated specially (for example, RFC 2821 does not allow a username of “J.D.”). <p>Some of the additional options below may be enabled which technically would violate RFC 2821.</p> <p>Loose Mode:</p> <p>The loose parser is basically the existing behavior from previous versions of AsyncOS. It does its best to “find” an email address and:</p> <ul style="list-style-type: none"> • Ignores comments. It supports nested comments (anything found in parenthesis) and ignores them. • Does not require angle brackets around email addresses provided in “RCPT TO” and “MAIL FROM” commands. • Allows multiple nested angle brackets (it searches for the email address in the deepest nested level).
Allow 8-bit User Names	If enabled, allow 8-bit characters in the username portion of the address without escaping.
Allow 8-bit Domain Names	If enabled, allow 8-bit characters in the domain portion of the address.

Setting	Description
Allow Partial Domains	<p>If enabled, will allow partial domains. Partial domains can be no domain at all, or a domain with no dots.</p> <p>The following addresses are examples of partial domains:</p> <ul style="list-style-type: none"> • foo • foo@ • foo@bar <p>This option <i>must</i> be enabled in order for the Default Domain feature to work properly.</p> <p>Add Default Domain: A default domain to use for email addresses without a fully qualified domain name. This option is disabled unless Allow Partial Domains is enabled in SMTP Address Parsing options. This affects how a listener modifies email that it relays by adding the “default sender domain” to sender and recipient addresses that do not contain fully-qualified domain names. (In other words, you can customize how a listener handles “bare” addresses).</p> <p>If you have a legacy system that sends email without adding (appending) your company’s domain to the sender address, use this to add the default sender domain. For example, a legacy system may automatically create email that only enters the string “ joe ” as the sender of the email. Changing the default sender domain would append “ @yourdomain.com ” to “ joe ” to create a fully-qualified sender name of joe@yourdomain.com .</p>
Source Routing	<p>Determines behavior if source routing is detected in the “MAIL FROM” and “RCPT TO” addresses. Source routing is a special form of an email address using multiple ‘@’ characters to specify routing (for example: @one.dom@two.dom:joe@three.dom). If set to “reject,” the address will be rejected. If “strip,” the source routing portion of the address will be deleted, and the message will be injected normally.</p>
Unknown Address Literals	<p>Determines behavior for when an address literal is received that the system cannot handle. Currently, this is everything except for IPv4. Thus, for example, for an IPv6 address literal, you can either reject it at the protocol level, or accept it and immediately hard bounce it.</p> <p>Recipient addresses containing literals will cause an immediate hard bounce. Sender addresses may get delivered. If the message cannot be delivered, then the hard bounce will hard bounce (double hard bounce).</p> <p>In the case of reject, both sender and recipient addresses will be rejected immediately at the protocol level.</p>
Reject These Characters in User Names	<p>Usernames that include characters (such as % or !, for example) entered here will be rejected.</p>

Step 5 (Optional) Configure advanced settings for customizing the behavior of the listener as defined in the following table.

Setting	Description
Maximum Concurrent Connections	The maximum number of connections allowed.
TCP Listen Queue Size	The backlog of connections that AsyncOS will manage before the SMTP server accepts them.
CR and LF Handling	Choose how to handle messages that contain bare CR (carriage return) and LF (line feed) characters. <ul style="list-style-type: none"> • Clean. Allows the message, but converts bare CR and LF characters to CRLF characters. • Reject. Rejects the message. • Allow. Allows the message.
Add Received Header	Add a received header to all received email. A listener also modifies email that it relays by adding a Received: header on each message. If you do not want to include the Received: header, you can disable it using this option. <p>Note The Received: header is not added to the message within the work queue processing. Rather, it is added when the message is enqueued for delivery</p> <p>Disabling the received header is a way to ensure that your network's topology is not exposed by revealing the IP addresses or hostnames of internal servers on any messages traveling outside your infrastructure. Please use caution when disabling the received header.</p>
Use SenderBase IP Profiling	Choose whether or not to enable SenderBase IP Profiling and configure the following setting: <ul style="list-style-type: none"> • SenderBase Timeout per Connection. Define how long the appliance caches SenderBase information per SMTP connection.

Step 6 (Optional) Configure settings for controlling LDAP queries associated with this listener as defined in the following table.

Use these settings to enable LDAP queries on the listener. You must create the LDAP query first, before using this option. Each type of query has a separate subsection to configure. Click the type of query to expand the subsection.

For more information about creating LDAP queries, see [LDAP Queries, on page 749](#).

Query Type	Description
Accept Queries	<p>For Accept queries, select the query to use from the list. You can specify whether the LDAP Accept occurs during the work queue processing or during the SMTP conversation.</p> <p>For LDAP Accept during the work queue processing, specify the behavior for non-matching recipients: bounce or drop.</p> <p>For LDAP Accept during the SMTP conversation, specify how to handle mail if the LDAP server is unreachable. You can elect to allow messages or drop the connection with a code and custom response. Finally, select whether or not to drop connections if the Directory Harvest Attack Prevention (DHAP) threshold is reached during an SMTP conversation.</p> <p>Performing recipient validation in the SMTP conversation can potentially reduce the latency between multiple LDAP queries. Therefore, you might notice an increased load on your directory server when you enable conversational LDAP Accept.</p> <p>See Overview of LDAP Queries, on page 749 for more information.</p>
Routing Queries	<p>For routing queries, select the query from the list. See Overview of LDAP Queries, on page 749 for more information.</p>
Masquerade Queries	<p>For masquerade queries, select a query from the list, and select which address to masquerade, such as the From or CC header addresses.</p> <p>See Overview of LDAP Queries, on page 749 for more information.</p>
Group Queries	<p>For group queries, select the query from the list. See Overview of LDAP Queries, on page 749 for more information.</p>

Step 7 Submit and commit your changes.

What to do next

Related Topics

[Partial Domains, Default Domains, and Malformed MAIL FROMs, on page 79](#)

Partial Domains, Default Domains, and Malformed MAIL FROMs

If you enable envelope sender verification or disable allowing partial domains in SMTP Address Parsing options for a listener, the default domain settings for that listener will no longer be used.

These features are mutually exclusive.

Listening for Connection Requests by Creating a Listener Using CLI

The following table lists some of the listenerconfig subcommands used in the tasks involved in creating and editing listeners.

Table 8: Tasks for Creating Listeners

Tasks for Creating Listeners	Command(s) and Subcommands
Create a new listener	listenerconfig -> new
Edit global settings for listeners	listenerconfig -> setup
Specify a bounce profile for the listener	bounceconfig, listenerconfig-> edit -> bounceconfig
Associate a disclaimer with the listener	textconfig, listenerconfig -> edit -> setup -> footer
Configure an SMTP Authentication	smtpauthconfig, listenerconfig -> smtpauth
Configure SMTP address parsing	textconfig, listenerconfig -> edit -> setup -> address
Configure a default domain for the listener	listenerconfig -> edit -> setup -> defaultdomain
Add a received header to email	listenerconfig -> edit -> setup -> received
Change bare CR and LF characters to CRLF	listenerconfig -> edit -> setup -> cleansmtp
Modify the Host Access Table	listenerconfig -> edit -> hostaccess
Accept email for local domains or specific users (RAT) (public listeners only)	listenerconfig -> edit -> rcptaccess
Encrypt conversations on listeners (TLS)	certconfig, listenerconfig -> edit
Choose the certificate (TLS)	listenerconfig -> edit -> certificate

For more information about listenerconfig command, see CLI Reference Guide for AsyncOS for Cisco Email Security Appliances .

For information about email routing and delivery configurations, see [Configuring Routing and Delivery Features, on page 671](#).

Related Topics

[Advanced HAT Parameters, on page 81](#)

Advanced HAT Parameters

The following table defines the syntax of advanced HAT parameters. Note that for the numeric values below, you can add a trailing **k** to denote kilobytes or a trailing **M** to denote megabytes. Values with no letters are considered bytes. Parameters marked with an asterisk support the variable syntax shown in the following table.

Table 9: Advanced HAT Parameter Syntax

Parameter	Syntax	Values	Example Values
Maximum messages per connection	<code>max_msgs_per_session</code>	Number	1000
Maximum recipients per message	<code>max_rcpts_per_msg</code>	Number	10000 1k
Maximum message size	<code>max_message_size</code>	Number	1048576 20M
Maximum concurrent connections allowed to this listener	<code>max_concurrency</code>	Number	1000
SMTP Banner Code	<code>smtp_banner_code</code>	Number	220
SMTP Banner Text (*)	<code>smtp_banner_text</code>	String	Accepted
SMTP Reject Banner Code	<code>smtp_banner_code</code>	Number	550
SMTP Reject Banner Text (*)	<code>smtp_banner_text</code>	String	Rejected
Override SMTP Banner Hostname	<code>use_override_hostname</code>	on off default	default
	<code>override_hostname</code>	String	newhostname
Use TLS	<code>tls</code>	on off required	on
Use anti-spam scanning	<code>spam_check</code>	on off	off
Use virus scanning	<code>virus_check</code>	on off	off
Maximum Recipients per Hour	<code>max_rcpts_per_hour</code>	Number	5k

Parameter	Syntax	Values	Example Values
Maximum Recipients per Hour Error Code	max_rcpts_per_hour_code	Number	452
Maximum Recipients per Hour Text (*)	max_rcpts_per_hour_text	String	Too manyrecipients
Use SenderBase	use_sb	on off	on
Define IP Reputation Score	sbrs[<i>value1</i> : <i>value2</i>]	-10.0- 10.0	sbrs[-10:-7.5]
Directory Harvest Attack Prevention: Maximum Invalid Recipients Per Hour	dhap_limit	Number	150

Enterprise Gateway Configuration

In this configuration, the Enterprise Gateway configuration accepts email from the Internet and relays email to groupware servers, POP/IMAP servers, or other MTAs. At the same time, the enterprise gateway accepts SMTP messages from groupware servers and other email servers for relay to recipients on the Internet.

Figure 12: Public and Private Listeners for an Enterprise Gateway

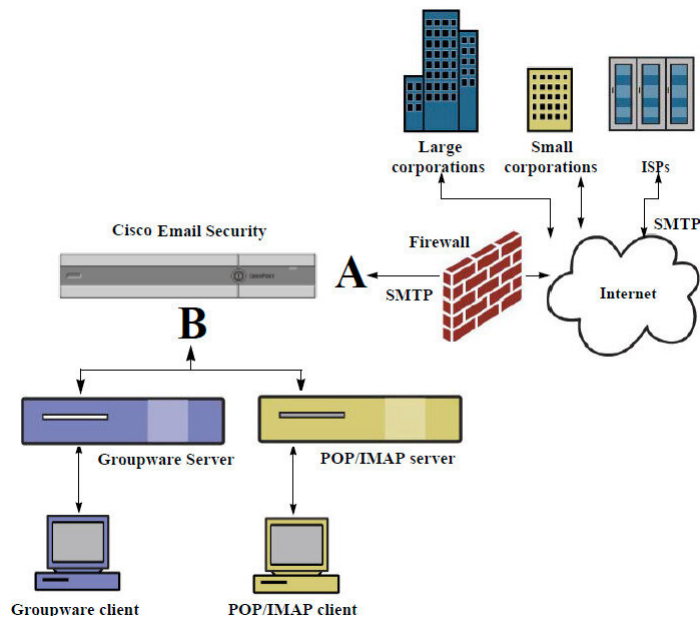

In this configuration, at least two listeners are required:

- One listener configured specifically to accept mail *from* the Internet
- One listener configured specifically to accept mail *from* your internal groupware and email servers (POP/IMAP)

By creating distinct public and private listeners for different public and private networks, you can distinguish among email for security, policy enforcement, reporting, and management. For example, email received on public listeners is scanned by your configured anti-spam engine and the anti-virus scanning engine by default, while email received on private listeners is not scanned.

Figure - Public and Private Listeners for an Enterprise Gateway shows one public listener (A) and one private listener (B) configured on the appliance in this Enterprise Gateway configuration.



CHAPTER 6

IP Reputation Filtering

This chapter contains the following sections:

- [Overview of Sender IP Reputation Filtering, on page 85](#)
- [IP Reputation Service, on page 85](#)
- [Editing IP Reputation Filtering Score Thresholds for a Listener , on page 88](#)
- [Entering Low IP Reputation Scores in the Message Subject, on page 90](#)

Overview of Sender IP Reputation Filtering

Sender IP reputation filtering is the first layer of spam protection, allowing you to control the messages that come through the email gateway based on senders' trustworthiness as determined by the Sender IP Reputation Service.

The appliance can accept messages from known or highly reputable senders — such as customers and partners — and deliver them directly to the end user without any content scanning. Messages from unknown or less reputable senders can be subjected to content scanning, such as anti-spam and anti-virus scanning, and you can also throttle the number of messages you are willing to accept from each sender. Email senders with the worst reputation can have their connections rejected or their messages bounced based on your preferences.



Note File reputation filtering is a separate service. For information, see [File Reputation Filtering and File Analysis, on page 457](#)

IP Reputation Service

The IP Reputation Service, using global data from the Talos Affiliate network, assigns a IP Reputation Score (IPRS) to email senders based on complaint rates, message volume statistics, and data from public blocked lists and open proxy lists. The IP Reputation Score helps to differentiate legitimate senders from spam sources. You can determine the threshold for blocking messages from senders with low reputation scores.

The Talos Security Network website (<https://talosintelligence.com>) provides a global overview of the latest email and web-based threats, displays current email traffic volume by country, and allows you to look up reputation scores based on IP address, URI or Domain.



Note The IP Reputation Service is only available with a current anti-spam feature key.

Related Topics

- [IP Reputation Score](#) , on page 86
- [How Sender IP Reputation Filters Work](#) , on page 87
- [Recommended Settings for Different Sender IP Reputation Filtering Approaches](#) , on page 87
- [Outbreak Filters](#), on page 401
- [Using Email Security Monitor](#), on page 807

IP Reputation Score

The IP Reputation Score is a numeric value assigned to an IP address based on information from the IP Reputation Service. The IP Reputation Service aggregates data from over 25 public blocked lists and open proxy lists, and combines this data with global data from Talos to assign a score from -10.0 to +10.0, as follows:

Score	Meaning
-10.0	Most likely to be a source of spam
0	Neutral, or not enough information to make a recommendation
+10.0	Most likely to be a trustworthy sender

The lower (more negative) the score, the more likely that a message is spam. A score of -10.0 means that this message is “guaranteed” to be spam, while a score of 10.0 means that the message is “guaranteed” to be legitimate.

Using the IP Reputation Score, you configure the appliance to apply mail flow policies to senders based on their trustworthiness. (You can also create message filters to specify “thresholds” for IP Reputation Scores to further act upon messages processed by the system. For more information, refer to “[IP Reputation Rule, on page 167](#)” and “[Bypass Anti-Spam System Action, on page 211](#).”)

Figure 13: The IP Reputation Service

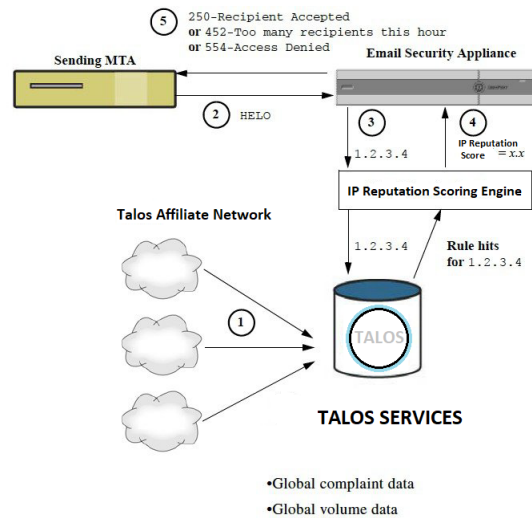

1. Talos affiliates send real-time, global data
2. Sending MTA opens connection with the appliance
3. Appliance checks global data for the connecting IP address
4. IP Reputation Service calculates the probability that this message is spam and assigns an IP Reputation Score
5. Cisco returns the response based on the IP Reputation Score

How Sender IP Reputation Filters Work

Sender IP Reputation filter technology aims to shunt as much mail as possible from the remaining security services processing that is available on the appliance. (See [Understanding the Email Pipeline, on page 57.](#))

When sender reputation filtering is enabled, mail from known bad senders is simply refused. Known good mail from global 2000 companies is automatically routed around the spam filters, reducing the chance of false positives. Unknown, or “grey” email is routed to the anti-spam scanning engine. Using this approach, Sender IP Reputation filters can reduce the load on the content filters by as much as 50%.

Figure 14: Sender IP Reputation Filtering Example

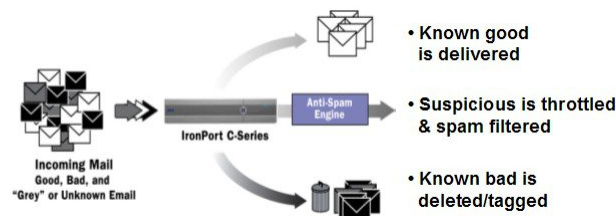

Recommended Settings for Different Sender IP Reputation Filtering Approaches

Depending on the objectives of your enterprise, you can implement a conservative, moderate, or aggressive approach.

Approach	Characteristics	Allowed_List	Blocked_List	Suspectlist	Unknownlist
		Sender IP Reputation Score range:			
Conservative	Near zero false positives, better performance	7 to 10	-10 to -4	-4 to -2	-2 to 7
Moderate (Installation default)	Very few false positives, high performance	Sender IPReputation Scores are not used.	-10 to -3	-3 to -1	-1 to +10
Aggressive	Some false positives, maximum performance. This option shunts the most mail away from Anti-Spam processing.	4 to 10	-10 to -2	-2 to -1	-1 to 4
All approaches		Mail Flow Policy:			
		Trusted	Blocked	Throttled	Accepted

Editing IP Reputation Filtering Score Thresholds for a Listener

Use this procedure if you want to change the default IP Reputation Service score thresholds or add a sender group for reputation filtering.



Note Other settings related to IP Reputation Score thresholds, and Mail Flow Policy settings, are described in [Defining Which Hosts Are Allowed to Connect Using the Host Access Table](#) , on page 93

Before You Begin

- If your appliance is set to receive mail from a local MX/MTA, identify upstream hosts that may mask the sender's IP address. See [Determining Sender IP Address In Deployments with Incoming Relays](#) , on page 388 for more information.
- Understand IP Reputation Scores. See [Defining Sender Groups by IP Reputation Score](#), on page 98.
- Choose a filtering approach for your organization and note the recommended settings for that approach. See [Recommended Settings for Different Sender IP Reputation Filtering Approaches](#) , on page 87.

Procedure

- Step 1** Select **Mail Policies > HAT Overview**.
- Step 2** Select the public listener from the **Sender Groups (Listener)** menu.
- Step 3** Click the link for a sender group.

For example, click the “SUSPECTLIST” link.

- Step 4** Click **Edit Settings**.
- Step 5** Enter the range of IP Reputation Scores for this sender group.
For example, for “ALLOWED_LIST,” enter the range 7.0 to 10.
- Step 6** Click **Submit**.
- Step 7** Repeat as needed for each sender group for this listener.
- Step 8** Commit changes.

What to do next

Related Topics

- [Testing IP Reputation Filtering Using the IP Reputation Scores, on page 89](#)
- [Defining Which Hosts Are Allowed to Connect Using the Host Access Table , on page 93](#)
- [How to Configure the Appliance to Scan Messages for Spam, on page 360](#)

Testing IP Reputation Filtering Using the IP Reputation Scores

Unless you regularly receive a large portion of spam, or you have set up “dummy” accounts to specifically receive spam for your organization, it may be difficult to immediately test the IP Reputation policies you have implemented. However, if you add entries for reputation filtering with IP Reputation Scores into a listener’s HAT as indicated in the following table, you will notice that a smaller percentage of inbound mail will be “unclassified.”

Test the policies using the `trace` command with an arbitrary IP Reputation scores. See [Debugging Mail Flow Using Test Messages: Trace, on page 1213](#). The `trace` command is available in the CLI as well as the GUI.

Table 10: Suggested Mail Flow Policies for Implementing the IP Reputation Scores

Policy Name	Primary Behavior (Access Rule)	Parameters	Value
\$BLOCKED	REJECT	None	
\$THROTTLED	ACCEPT	Maximum messages / session: Maximum recipients / message: Maximum message size: Maximum concurrent connections: Use Spam Detection: Use TLS: Maximum recipients / hour: Use SenderBase:	10 20 1 MB 10 ON OFF 20 (recommended) ON

Policy Name	Primary Behavior (Access Rule)	Parameters	Value
\$ACCEPTED (Public Listener)	ACCEPT	Maximum messages / session: Maximum recipients / message: Maximum message size: Maximum concurrent connections: Use Spam Detection: Use TLS: Use SenderBase:	1,000 1,000 100 MB 1,000 ON OFF ON
\$TRUSTED	ACCEPT	Maximum messages / session: Maximum recipients / message: Maximum message size: Maximum concurrent connections: Use Spam Detection: Use TLS: Maximum recipients / hour: Use SenderBase:	1,000 1,000 100 MB 1,000 OFF OFF -1 (<i>disabled</i>) OFF



Note In the \$THROTTLED policy, the maximum recipients per hour from the remote host is set to 20 recipients per hour, by default. Note that this setting controls the maximum throttling available. You can increase the number of recipients to receive per hour if this parameter is too aggressive. For more information on Default Host Access policies, see [Understanding Predefined Sender Groups and Mail Flow Policies, on page 102](#).

Entering Low IP Reputation Scores in the Message Subject

Although Cisco recommends throttling, an alternate way to use the IP Reputation Service is to modify the subject line of suspected spam messages. To do this, use the message filter shown in the following table. This filter uses the reputation filter rule and the strip-header and insert-header filter actions to replace the subject line of messages having a IP Reputation Score lower than -2.0 with a subject line that includes the actual IP Reputation Score represented as: **{Spam IP Reputation Score}**. Replace *listener_name* in this example with the name of your public listener. (The period on its own line is included so that you can cut and paste this text directly into the command line interface of the filters command.)

Table: Message Filter to Modify Subject Header with IP Reputation: Example 1

```
iprs_filter:

if ((recv-inj == "listener_name
" AND subject != "\\{Spam -?[0-9.]+\\}"))
```



```
{  
  
    insert-header("X-IPRS", "$REPUTATION");  
  
    if (reputation <= -2.0)  
  
    {  
  
        strip-header("Subject");  
  
        insert-header("Subject", "$Subject \\{Spam $REPUTATION\\}");  
  
    }  
  
}  
  
.
```

Related Topic

- [Using Message Filters to Enforce Email Policies, on page 131](#)



CHAPTER 7

Defining Which Hosts Are Allowed to Connect Using the Host Access Table

This chapter contains the following sections:

- [Overview of Defining Which Hosts Are Allowed to Connect, on page 93](#)
- [Defining Remote Hosts into Sender Groups, on page 94](#)
- [Defining Access Rules for Email Senders Using Mail Flow Policies, on page 99](#)
- [Understanding Predefined Sender Groups and Mail Flow Policies, on page 102](#)
- [Handling Messages from a Group of Senders in the Same Manner, on page 104](#)
- [Working with the Host Access Table Configuration, on page 112](#)
- [Using a List of Sender Addresses for Incoming Connection Rules, on page 114](#)
- [SenderBase Settings and Mail Flow Policies, on page 114](#)
- [Verifying Senders, on page 116](#)

Overview of Defining Which Hosts Are Allowed to Connect

For every configured listener, you must define a set of rules that control incoming connections from remote hosts. For example, you can define remote hosts and whether or not they can connect to the listener. AsyncOS allows you to define which hosts are allowed to connect to the listener using the Host Access Table (HAT).

The HAT maintains a set of rules that control incoming connections from remote hosts for a listener. Every configured listener has its own HAT. You configure HATs for both public and private listeners.

To control incoming connections from remote hosts, you define the following information:

- **Remote hosts.** Define the way in which a remote host attempts to connect to the listener. You group remote host definitions into *sender groups*. For example, you can define multiple remote hosts in a sender group by IP address and partial hostname. You can also define remote hosts by their IP Reputation score. For more information, see [Defining Remote Hosts into Sender Groups, on page 94](#).
- **Access rules.** You can define whether the defined remote hosts in the sender group are allowed to connect to the listener and under what conditions. You define access rules using *mail flow policies*. For example, you can define that a particular sender group is allowed to connect to the listener, but only allow a maximum number of messages per connection. For more information, see [Defining Access Rules for Email Senders Using Mail Flow Policies, on page 99](#)

Define which hosts are allowed to connect to the listener on the Mail Policies > HAT Overview page.

When a listener receives a TCP connection, it compares the source IP address against the configured sender groups. It evaluates the sender groups in the order listed on the HAT Overview page. When it finds a match, it applies the configured mail flow policy to the connection. If you have configured multiple conditions within a sender group, that sender group is matched if any of the conditions match.

When you create a listener, AsyncOS creates predefined sender groups and mail flow policies for the listener. You can edit the predefined sender groups and mail flow policies, and create new sender groups and mail flow policies. For more information, see [Understanding Predefined Sender Groups and Mail Flow Policies, on page 102](#).

You can export all information stored in a Host Access Table to a file, and you can import Host Access Table information stored in a file into the appliance for a listener, overriding all configured Host Access Table information. For more information, see [Working with the Host Access Table Configuration, on page 112](#).

Related Topics

- [Default HAT Entries, on page 94](#)

Default HAT Entries

By default, the HAT is defined to take different actions depending on the listener type:

- **Public listeners.** The HAT is set to *accept* email from *all* hosts.
- **Private listeners.** The HAT is set up to *relay* email from the host(s) you specify, and reject all other hosts.

In the HAT Overview, the default entry is named “ALL.” You can edit the default entry by clicking the mail flow policy for the ALL sender group on the Mail Policies > HAT Overview page.



Note By rejecting all hosts other than the ones you specify, the `listenerconfig` and `systemsetup` commands prevent you from unintentionally configuring your system as an “open relay.” An open relay (sometimes called an “insecure relay” or a “third party” relay) is an SMTP email server that allows third-party relay of email messages. By processing email that is neither for nor from a local user, an open relay makes it possible for an unscrupulous sender to route large volumes of spam through your gateway.

Defining Remote Hosts into Sender Groups

You can define the way in which remote hosts attempt to connect to a listener. You group remote host definitions into sender groups. A sender group is a list of remote hosts defined for the purpose of handling email from those senders in the same way.

A sender group is a list of senders identified by:

- IP address (IPv4 or IPv6)
- IP range
- Specific host or domain name
- IP Reputation Service “organization” classification
- IP Reputation Score (IPRS) range (or lack of score)
- DNS List query response

For more information on the list of acceptable addresses in sender groups, see [Sender Group Syntax, on page 95](#).

When an SMTP server attempts an SMTP connection with the appliance, the listener evaluates the sender groups in order and assigns the connection to a sender group when it matches *any* criterion in the sender group, such as IP reputation score, domain, or IP address.



Note The system acquires and verifies the validity of the remote host’s IP address by performing a double DNS lookup. This consists of a reverse DNS (PTR) lookup on the IP address of the connecting host, followed by a forward DNS (A) lookup on the results of the PTR lookup. The system then checks that the results of the A lookup match the results of the PTR lookup. If the results do not match, or if an A record does not exist, the system only uses the IP address to match entries in the HAT.

Define sender groups on the Mail Policies > HAT Overview page.

Related Topics

- [Sender Group Syntax, on page 95](#)
- [Sender Groups Defined by Network Owners, Domains, and IP Addresses, on page 96](#)
- [Defining Sender Groups by IP Reputation Score, on page 98](#)
- [Sender Groups Defined by Querying DNS Lists, on page 99](#)

Sender Group Syntax

Table 11: Defining Remote Hosts in the HAT: Sender Group Syntax

Syntax	Meaning
n:n:n:n:n:n:n	IPv6 address; does not need to include leading zeroes.
n:n:n:n:n:n:n-n:n:n:n:n:n:n:n n:n-n:n:n:n:n:n	Range of IPv6 addresses; does not need to include leading zeroes.
n.n.n.n	Full (complete) IPv4 Address
n.n.n. n.n.n. n.n. n.n. n.	Partial IPv4 address
n.n.n.n-n. n.n.n.n-n. n.n.n-n. n.n-n. n.n-n n-n. n-n	Range of IPv4 addresses

Syntax	Meaning
<code>yourhost.example.com</code>	A fully-qualified domain name
<code>.partialhost</code>	Everything within the partialhost domain
<code>n/c</code> <code>n.n/c</code> <code>n.n.n/c</code> <code>n.n.n.n/c</code>	IPv4 CIDR address block
<code>n:n:n:n:n:n:n/c</code>	IPv6 CIDR address block; does not need to include leading zeroes
<code>SBRs [n:n] SBRs [none]</code>	IP Reputation Score. For more information, see Defining Sender Groups by IP Reputation Score, on page 98 .
<code>SBO:n</code>	Network Owner Identification Number. For more information, see Defining Sender Groups by IP Reputation Score, on page 98 .
<code>dnslist [dnsserver.domain]</code>	DNS List query. For more information, see Sender Groups Defined by Querying DNS Lists, on page 99 .
<code>ALL</code>	Special keyword that matches ALL addresses. This applies only to the ALL sender group, and is always included (but not listed).

Sender Groups Defined by Network Owners, Domains, and IP Addresses

Since the SMTP protocol has no built-in method for authenticating senders of email, senders of unsolicited bulk email have been successful at employing a number of tactics for hiding their identity. Examples include spoofing the Envelope Sender address on a message, using a forged HELO address, or simply rotating through different domain names. This leaves many mail administrators asking themselves the fundamental question, “Who is sending me all of this email?” To answer this question, the IP Reputation Service has developed a unique hierarchy for aggregating identity-based information based on the IP address of the connecting host — the one thing that is almost impossible for a sender to forge in a message.

An **IP Address** is defined as the IP address of the sending mail host. The appliance supports both Internet Protocol version 4 (IPv4) and version 6 (IPv6) addresses.

A **Domain** is defined as an entity that uses hostnames with a given second-level domain name (for example, yahoo.com), as determined by a reverse (PTR) lookup on the IP address.

A **Network Owner** is defined as an entity (usually a company) that controls a block of IP addresses, as determined based on IP address space assignments from global registries such as ARIN (the American Registry for Internet Numbers) and other sources.

An **Organization** is defined as an entity that most closely controls a particular group of mail gateways within a network owner’s IP block, as determined by SenderBase. An Organization may be the same as the Network Owner, a division within that Network Owner, or a customer of that Network Owner.

Related Topics

- [Setting Policies Based on the HAT, on page 97](#)

Setting Policies Based on the HAT

The following table lists some examples of network owners and organizations.

Table 12: Example of Network Owners and Organizations

Example Type	Network Owner	Organization
Network Service Provider	Level 3 Communications	Macromedia Inc. AllOutDeals.com GreatOffers.com
Email Service Provider	GE	GE Appliances GE Capital GE Mortgage
Commercial Sender	The Motley Fool	The Motley Fool

As network owners can range dramatically in size, the appropriate entity to base your mail flow policy on is the organization. The IP Reputation Service has a unique understanding of the source of the email down to the organization level, which the appliance leverages to automatically apply policies based on the organization. In the example above, if a user specified “Level 3 Communications” as a sender group in the Host Access Table (HAT), SenderBase will enforce policies based on the individual organizations controlled by that network owner.

For example, in the table above, if a user enters a limit of 10 recipients per hour for Level 3, the appliance will allow up to 10 recipients per hour for Macromedia Inc., Alloutdeals.com *and* Greatoffers.com (a total of 30 recipients per hour for the Level 3 network owner). The advantage of this approach is that if one of these organizations begins spamming, the other organizations controlled by Level 3 will not be impacted. Contrast this to the example of “The Motley Fool” network owner. If a user sets rate limiting to 10 recipients per hour, the Motley Fool network owner will receive a total limit of 10 recipients per hour.

The Mail Flow Monitor feature is a way of defining the sender and providing you with monitoring tools to create mail flow policy decisions about the sender. To create mail flow policy decisions about a given sender, ask these questions:

- **Which IP addresses are controlled by this sender?**

The first piece of information that the Mail Flow Monitor feature uses to control the inbound email processing is the answer to this question. The answer is derived by querying the IP Reputation Service. The IP Reputation Service provides information about the relative size of the sender (either the network owner or the SenderBase organization). Answering this question assumes the following:

- Larger organizations tend to control more IP addresses, and send more legitimate email.

- **Depending on its size, how should the overall number of connections be allotted for this sender?**

- Larger organizations tend to control more IP addresses, and send more legitimate email. Therefore, they should be allotted more connections to your appliance .
- The sources of high-volume email are often ISPs, NSPs, companies that manage outsourced email delivery, or sources of unsolicited bulk email. ISPs, NSPS, and companies that manage outsourced email delivery are examples of organizations that control many IP addresses, and should be allotted more connections to your appliance . Senders of unsolicited bulk email usually do not control many

IP addresses; rather, they send large volumes of mail through a few number of IP addresses. They should be allotted fewer connections to your appliance .

The Mail Flow Monitor feature uses its differentiation between network owners and SenderBase organizations to determine how to allot connections per sender, based on logic in SenderBase. See the “Using Email Security Monitor” chapter for more information on using the Mail Flow Monitor feature.

Defining Sender Groups by IP Reputation Score

The appliance can query the IPReputation Service to determine a IP reputation score. The IP Reputation Score is a numeric value assigned to an IP address, domain, or organization based on information from the IP Reputation Service. The scale of the score ranges from -10.0 to +10.0, as described in the following table.

Table 13: Definition of the IP Reputation Score

Score	Meaning
-10.0	Most likely to be a source of spam
0	Neutral, or not enough information to make a recommendation
+10.0	Most likely to be a trustworthy sender
none	No data available for this sender (typically a source of spam)

Using the IP Reputation Score, you configure the appliance to apply mail flow policies to senders based on their trustworthiness. For example, all senders with a score less than -7.5 could be rejected. This is most easily accomplished via the GUI; see [Creating a Sender Group for Message Handling](#) , on page 105. However, if you are modifying an exported HAT in a text file, the syntax for including IP Reputation Scores is described in the following table.

Table 14: Syntax for IP Reputation Scores

SBRS[<i>n n</i>]	IP Reputation Score. Senders are identified by querying the IP Reputation Service, and the scores are defined between the ranges.
SBRS[none]	Specify no IP (very new domains may not have IP Reputation Scores yet).



Note Network owners added to a HAT via the GUI use the syntax `SBO:n`, where *n* is the network owner’s unique identification number in the IP Reputation Service.

Use the **Network > Listeners** page or `listenerconfig -> setup` command in the CLI to enable a listener to query the IP Reputation Service. You can also define the timeout value that the appliance should wait when querying the IP Reputation Service. Then, you can configure different policies to use look ups to the IP Reputation Service by using the values in the Mail Policies Pages in the GUI or the `listenerconfig -> edit -> hostaccess` commands in the CLI.



Note You can also create message filters to specify “thresholds” for IP Reputation Scores to further act upon messages processed by the system. For more information, see “IP Reputation Rule,” “Bypass Anti-Spam System Action,” and “Bypass Anti-Virus System Action” in the anti-spam and anti-virus chapters.

Sender Groups Defined by Querying DNS Lists

You also have the ability in a listener’s HAT to define a sender group as matching a query to a specific DNS List sever. The query is performed via DNS at the time of the remote client’s connection. The ability to query a remote list also exists currently as a message filter rule (see “DNS List Rule” in the chapter on “Using Message Filters to Enforce Email Policies”), but only once the message content has been received in full.

This mechanism allows you to configure a sender within a group that queries a DNS List so that you can adjust your mail flow policies accordingly. For example, you could reject connections or limit the behavior of the connecting domain.



Note Some DNS Lists use variable responses (for example, “127.0.0.1” versus “127.0.0.2” versus “127.0.0.3”) to indicate various facts about the IP address being queried against. If you use the message filter DNS List rule (see “DNS List Rule” in the chapter on “Using Message Filters to Enforce Email Policies”), you can compare the result of the query against different values. However, specifying a DNS List server to be queried in the HAT only supports a Boolean operation for simplicity (that is, does the IP address appear in the list or not)



Note Be sure to include brackets in the query in the CLI. Brackets are not necessary when specifying a DNS List query in the GUI. Use the `dnslistconfig` command in the CLI to test a query, configure general settings for DNL queries, or flush the current DNS list cache.

Note that this mechanism can be used to identify “good” connections as well as “bad” connections. For example, a query to `query.bondedsender.org` will match on connecting hosts who have posted a financial bond with Cisco Systems’ Bonded Sender™ program to ensure the integrity of their email campaign. You could modify the default `ALLOWED_LIST` sender group to query the Bonded Sender program’s DNS servers (which lists these legitimate email senders who have willingly posted bonds) and adjust the mail flow policy accordingly.

Defining Access Rules for Email Senders Using Mail Flow Policies

Mail flow policies allow you to control or limit the flow of email messages from a sender to the listener during the SMTP conversation. You control SMTP conversations by defining the following types of parameters in the mail flow policy:

- Connection parameters, such as maximum number of messages per connection.
- Rate limiting parameters, such as maximum number of recipients per hour.
- Modify custom SMTP codes and responses communicated during the SMTP conversation.

- Enable spam detection.
- Enable virus protection.
- Encryption, such as using TLS to encrypt the SMTP connection.
- Authentication parameters, such as using DKIM to verify incoming mail.

Ultimately, mail flow policies perform one of the following actions on connections from remote hosts:

- **ACCEPT.** Connection is accepted, and email acceptance is then further restricted by listener settings, including the Recipient Access Table (for public listeners).
- **REJECT.** Connection is initially accepted, but the client attempting to connect gets a 4XX or 5XX SMTP status code. No email is accepted.



Note You can also configure AsyncOS to perform this rejection at the message recipient level (RCPT TO), rather than at the start of the SMTP conversation. Rejecting messages in this way delays the message rejection and bounces the message, allowing AsyncOS to retain more detailed information about the rejected messages. This setting is configured from the CLI `listenerconfig > setup` command. For more information, see [Listening for Connection Requests by Creating a Listener Using CLI](#), on page 80.

- **TCPREFUSE.** Connection is refused at the TCP level.
- **RELAY.** Connection is accepted. Receiving for any recipient is allowed and is not constrained by the Recipient Access Table.
- **CONTINUE.** The mapping in the HAT is ignored, and processing of the HAT continues. If the incoming connection matches a later entry that is not CONTINUE, that entry is used instead. The CONTINUE rule is used to facilitate the editing of the HAT in the GUI. For more information, see [Creating a Sender Group for Message Handling](#), on page 105.

Related Topics

- [HAT Variable Syntax](#), on page 100

HAT Variable Syntax

The following table defines a set of variables that can also be used in conjunction with the custom SMTP and Rate Limiting banners defined for a mail flow policy. Variable names are case-insensitive. (That is, \$group is equivalent to \$Group.)

Table 15: HAT Variable Syntax

Variable	Definition
\$Group	Replaced by the name of the sender group that was matched in the HAT. If the sender group has no name, “None” is displayed.
\$Hostname	Replaced by the remote hostname if and only if it has been validated by the appliance. If the reverse DNS lookup of the IP address is successful but returns no hostname, then “None” is displayed. If the reverse DNS lookup fails (for example, if the DNS server cannot be reached, or no DNS server has been configured) then “Unknown” is displayed.

Variable	Definition
\$OrgID	Replaced by the SenderBase Organization ID (an integer value). If the appliance cannot obtain a SenderBase Organization ID, or if the IP Reputation Service did not return a value, “None” is displayed.
\$RemoteIP	Replaced by the IP address of the remote client.
\$HATEntry	Replaced by the entry in the HAT that the remote client matched.

Related Topics

- [Using HAT Variables, on page 101](#)
- [Testing HAT Variables, on page 102](#)

Using HAT Variables



Note These variables can be used with the `smtp_banner_text` and `max_rcpts_per_hour_text` advanced HAT parameters described in the “Configuring the Gateway to Receive Email” chapter.

Using these variables, you could edit the custom SMTP banner response text for accepted connections in the \$TRUSTED policy in the GUI:

Figure 15: Using HAT Variables

Rate Limiting:	Max. Recipients Per Hour:	<input checked="" type="radio"/> Unlimited <input type="radio"/> <input type="text"/>
	Max. Recipients Per Hour Code:	<input type="text" value="452"/>
	Max. Recipients Per Hour Text:	<input type="text" value="Too many recipients received this hour from Host: \$hostname"/>

Or like this, in the CLI:

```
Would you like to specify a custom SMTP response? [Y]> y
```

```
Enter the SMTP code to use in the response. 220 is the standard code.
```

```
[220]> 200
```

```
Enter your custom SMTP response. Press Enter on a blank line to finish.
```

```
You've connected from the hostname: $Hostname, IP address of: $RemoteIP, matched the group:
$Group,
$HATEntry and the SenderBase Organization: $OrgID.
```

Testing HAT Variables

To test these variables, add the IP address of a known, trusted machine to the \$ALLOWED_LIST sender group of a listener on the appliance. Then, connect from that machine via telnet. You can see the variable substitution in the SMTP response. For example:

```
# telnet
IP_address_of_Email_Security_Appliance port

220 hostname
    ESMTP

200 You've connected from the hostname: hostname
    , IP address of: IP_address_of_connecting_machine
    , matched the group: ALLOWED_LIST, 10.1.1.1 the SenderBase Organization: OrgID
.
```

Understanding Predefined Sender Groups and Mail Flow Policies

The following table lists the predefined sender groups and mail flow policies that are configured when a public listener is created.

Table 16: Predefined Sender Groups and Mail Flow Policies for Public Listeners

Predefined Sender Group	Description	Default Configured Mail Flow Policy
ALLOWED_LIST	Add senders you trust to the Allowed_list sender group. The \$TRUSTED mail flow policy is configured so that email from senders you trust has no rate limiting enabled, and the content from those senders is not scanned by the Anti-Spam or Anti-Virus software.	\$TRUSTED
BLOCKED_LIST	Senders in the Blocked_list sender group are rejected (by the parameters set in the \$BLOCKED mail flow policy). Adding senders to this group rejects connections from those hosts by returning a 5XX SMTP response in the SMTP HELO command.	\$BLOCKED

Predefined Sender Group	Description	Default Configured Mail Flow Policy
SUSPECTLIST	<p>The Suspectlist sender group contains a mail flow policy that throttles, or slows, the rate of incoming mail. If senders are suspicious, you can add them to the Suspectlist sender group, where the mail flow policy dictates that:</p> <ul style="list-style-type: none"> • Rate limiting limits the maximum number of messages per session, the maximum number of recipients per message, the maximum message size, and the maximum number of concurrent connections you are willing to accept from a remote host. • The maximum recipients per hour from the remote host is set to 20 recipients per hour. Note that this setting is the maximum throttling available. You can increase the number of recipients to receive per hour if this parameter is too aggressive. • The content of messages will be scanned by the anti-spam scanning engine and the anti-virus scanning engine (if you have these feature enabled for the system). • The SenderBase Reputation Service will be queried for more information about the sender. 	\$THROTTLED
UNKNOWNLIST	<p>The Unknownlist sender group may be useful if you are undecided about the mail flow policy you should use for a given sender. The mail flow policy for this group dictates that mail is accepted for senders in this group, but the Anti-Spam software (if enabled for the system), the anti-virus scanning engine, and the IP Reputation Service should all be used to gain more information about the sender and the message content. Rate limits for senders in this group are also enabled with default values. For more information on virus scanning engines, see Virus Scanning, on page 343. For more information on the IP Reputation Service, see IP Reputation Service, on page 85.</p>	\$ACCEPTED
ALL	<p>Default sender group that applies to all other senders. For more information, see Default HAT Entries, on page 94.</p>	\$ACCEPTED

The following table lists the predefined sender groups and mail flow policies that are configured when a private listener is created.

Table 17: Predefined Sender Groups and Mail Flow Policies for Private Listeners

Predefined Sender Group	Description	Default Configured Mail Flow Policy
RELAYLIST	<p>Add senders you know should be allowed to relay to the Relaylist sender group. The \$RELAYED mail flow policy is configured so that email from senders you are allowing to relay has no rate limiting, and the content from those senders is not scanned by the anti-spam scanning engine or anti-virus software.</p> <p>Note The RELAYLIST sender group includes the systems allowed to relay email when the System Setup Wizard was run.</p>	\$RELAYED
ALL	<p>Default sender group that applies to all other senders. For more information, see Default HAT Entries, on page 94.</p>	\$BLOCKED



Note When you run the System Setup Wizard on an appliance model that has only two Ethernet ports, you are prompted to create only one listener. It creates a public listener that also includes a \$RELAYED mail flow policy that is used to relay mail for internal systems. For appliance models that have more than two Ethernet ports, the RELAYLIST sender group and \$RELAYED mail flow policy only appear on private listeners.

Handling Messages from a Group of Senders in the Same Manner

Use the Mail Policies > HAT Overview and Mail Flow Policy pages to configure how the listener handles messages from senders. Do this by creating, editing, and deleting sender groups and mail flow policies.

Related Topics

- [Creating a Sender Group for Message Handling](#), on page 105
- [Adding a Sender to an Existing Sender Group](#), on page 106
- [Rearranging the Order of the Rules to Perform for Incoming Connections](#), on page 106
- [Searching for Senders](#), on page 107
- [Defining Access Rules for Email Senders Using Mail Flow Policies](#), on page 99
- [Defining Default Values for Mail Flow Policies](#), on page 112

Creating a Sender Group for Message Handling

Procedure

- Step 1** Navigate to the **Mail Policies > HAT Overview** page.
- Step 2** Choose the listener to edit in the Listener field.
- Step 3** Click **Add Sender Group**.
- Step 4** Type the name of the sender group.
- Step 5** Select the order in which to place it in the list of sender groups.
- Step 6** (Optional) Enter a comment, for example information about this sender group or its settings.
- Step 7** Select a mail flow policy to which to apply this sender group.
- Note** If you do not know the mail flow policy you would like to apply to this group (or if no mail flow policies exist yet), then use the default “CONTINUE (no policy)” mail flow policy.
- Step 8** (Optional) Select a DNS list.
- Step 9** (Optional) Include senders for which IP Reputation Score has no information. This is referred to as “none” and generally denotes a suspect.
- Step 10** (Optional) Enter a DNS list.
- Step 11** (Optional) Configure host DNS verification settings.
- For more information, see [Implementing More Stringent Throttling Settings for Unverified Senders](#), on page 121 .
- Step 12** Click **Submit** to create the sender group.
- Step 13** Click on the newly created sender group.
- Step 14** Click **Add Sender** to add senders to the sender group.
- **Add sender IP address** .Select **IP Addresses**, add an IPv4 address, IPv6 address, or a hostname, and submit the changes.
A sender can include a range of IP addresses and partial hostnames.
 - **Add sender's country of origin**. Select **Geolocation**, select the country, and submit the changes.
- Step 15** Submit and commit your changes.
-

What to do next

Related Topics

- [Editing IP Reputation Filtering Score Thresholds for a Listener](#) , on page 88

Adding a Sender to an Existing Sender Group

Procedure

Step 1 From a domain, IP, or network owner profile page, click the Add to Sender Group link.

Step 2 Choose the sender group from the list defined for each listener.

Step 3 Submit and commit your changes.

Note When you add a domain to a sender group, two actual domains are listed in the GUI. For example, if you were adding the domain `example.net`, on the Add to Sender Group page, both `example.net` and `.example.net` are added. The second entry ensures that any host in the subdomain of `example.net` will be added to the sender group. For more information, see [Sender Group Syntax, on page 95](#).

If one or more of the senders you are adding to a sender group is a duplicate of a sender that is already present in that sender group, the duplicate senders will not be added and you will see a confirmation message.

Step 4 Click **Save** to add the sender and return to the Incoming Mail Overview page.

What to do next

Related Topics

- [Protecting Appliance -Generated Messages From the Spam Filter, on page 382](#)
- [How to Configure the Appliance to Scan Messages for Spam, on page 360](#)

Rearranging the Order of the Rules to Perform for Incoming Connections

If you add a sender group to a listener, you may need to edit the sender group order.

The HAT is read from top to bottom for each host that attempts to connect to the listener. If a rule matches a connecting host, the action is taken for that connection immediately.

Procedure

Step 1 Navigate to the **Mail Policies > HAT Overview** page.

Step 2 Choose the listener to edit in the Listener field.

Step 3 Click **Edit Order**.

Step 4 Type the new order for existing rows of sender groups in the HAT.

Cisco recommends maintaining the default order: RELAYLIST (certain hardware models only), followed by ALLOWED_LIST, BLOCKED_LIST, SUSPECTLIST, and UNKNOWNLIST.

Step 5 Submit and commit your changes.

Searching for Senders

You can find senders by entering text in the Find Senders field at the top of the HAT Overview page. Enter the text to search with and click Find.

Defining Rules for Incoming Messages Using a Mail Flow Policy

Consider the following rules and guidelines before creating a mail flow policy:

- Defaults for the policy are “greyed out” while the “Use Default” radio button is selected. To overwrite the default values, enable the feature or setting by selecting the “On” radio button and making changes to the now accessible values. To define default values, see [Defining Default Values for Mail Flow Policies, on page 112](#).
- Some parameters depend on certain pre-configurations. (For example, the Directory Harvest Attack prevention setting requires that you have configured an LDAP Acceptance Query.)

Procedure

- Step 1** Navigate to the **Mail Policies > Mail Flow Policies** page.
- Step 2** Click **Add Policy**.
- Step 3** Enter the information described in the following table.

Table 18: Mail Flow Policy Parameters

Parameter	Description
Connections	
Maximum message size	The maximum size of a message that will be accepted by this listener. The smallest possible maximum message size is 1 kilobyte.
Maximum concurrent connections from a single IP	The maximum number of concurrent connections allowed to connect to this listener from a single IP address.
Maximum messages per connection	The maximum number of messages that can be sent through this listener per connection from a remote host.
Maximum recipients per message	That maximum number of recipients per message that will be accepted from this host.
SMTP Banner	
Custom SMTP Banner Code	The SMTP code returned when a connection is established with this listener.
Custom SMTP Banner Text	The SMTP banner text returned when a connection is established with this listener. Note You can use some variables in this field. For more information, see HAT Variable Syntax, on page 100 .

Parameter	Description
Custom SMTP Reject Banner Code	The SMTP code returned when a connection is rejected by this listener.
Custom SMTP Reject Banner Text	The SMTP banner text returned when a connection is rejected by this listener.
Override SMTP Banner Host Name	By default, the appliance will include the hostname associated with the interface of the listener when displaying the SMTP banner to remote hosts (for example: 220- <i>hostname</i> ESMTP). You may choose to override this banner by entering a different hostname here. Additionally, you may leave the hostname field blank to choose <i>not</i> to display a hostname in the banner.
Rate Limit for Hosts	
Max. Recipients per Hour	The maximum number of recipients per hour this listener will receive from a remote host. The number of recipients per sender IP address is tracked globally. Each listener tracks its own rate limiting threshold; however, because all listeners validate against a single counter, it is more likely that the rate limit will be exceeded if the same IP address (sender) is connecting to multiple listeners. Note You can use some variables in this field. For more information, see HAT Variable Syntax, on page 100 .
Max. Recipients per Hour Code	The SMTP code returned when a host exceeds the maximum number of recipients per hour defined for this listener.
Max. Recipients Per Hour Exceeded Text	The SMTP banner text returned when a host exceeds the maximum number of recipients per hour defined for this listener.
Rate Limit for Sender	
Max. Recipients per Time Interval	The maximum number of recipients during a specified time period that this listener will receive from a unique envelope sender, based on the mail-from address. The number of recipients is not tracked globally. Each listener tracks its own rate limiting threshold; however, because all listeners validate against a single counter, it is more likely that the rate limit will be exceeded if messages from the same mail-from address are received by multiple listeners. Select whether to use the default maximum recipients, accept unlimited recipients, or specify another maximum number of recipients. Use the Default Mail Flow Policy settings to specify the maximum number of recipients and the time interval that will be used by the other mail flow policies by default. The time interval can only be specified using the Default Mail Flow Policy.
Sender Rate Limit Exceeded Error Code	The SMTP code returned when an envelope exceeds the maximum number of recipients for the time interval defined for this listener.
Sender Rate Limit Exceeded Error Text	The SMTP banner text returned when an envelope sender exceeds the maximum number of recipients for the time interval defined for this listener.

Parameter	Description
Exceptions	If you want certain envelope senders to be exempt from the defined rate limit, select an address list that contains the envelope senders. See Using a List of Sender Addresses for Incoming Connection Rules, on page 114 for more information.
Flow Control	
Use SenderBase for Flow Control	Enable “look ups” to the IP Reputation Service for this listener.
Group by Similarity of IP Addresses: (significant bits 0-32)	Used to track and rate limit incoming mail on a per-IP address basis while managing entries in a listener’s Host Access Table (HAT) in large CIDR blocks. You define a range of significant bits (from 0 to 32) by which to group similar IP addresses for the purposes of rate limiting, while still maintaining an individual counter for each IP address within that range. Requires “Use SenderBase” to be disabled. For more information about HAT significant bits, see Configuring Routing and Delivery Features, on page 671 .
Directory Harvest Attack Prevention (DHAP)	
Directory Harvest Attack Prevention: Maximum Invalid Recipients Per Hour	The maximum number of invalid recipients per hour this listener will receive from a remote host. This threshold represents the total number of RAT rejections and SMTP call-ahead server rejections combined with the total number of messages to invalid LDAP recipients dropped in the SMTP conversation or bounced in the work queue (as configured in the LDAP accept settings on the associated listener). For more information on configuring DHAP for LDAP accept queries, see Working with LDAP Queries, on page 759 .
Directory Harvest Attack Prevention: Drop Connection if DHAP threshold is Reached within an SMTP Conversation	The appliance will drop a connection to a host if the threshold of invalid recipients is reached.
Max. Invalid Recipients Per Hour Code:	Specify the code to use when dropping connections. The default code is 550.
Max. Invalid Recipients Per Hour Text:	Specify the text to use for dropped connections. The default text is “Too many invalid recipients.”
Drop Connection if DHAP threshold is reached within an SMTP Conversation	Enable to drop connections if the DHAP threshold is reached within an SMTP conversation.
Max. Invalid Recipients Per Hour Code	Specify the code to use when dropping connections due to DHAP within an SMTP conversation. The default code is 550.

Parameter	Description
Max. Invalid Recipients Per Hour Text:	Specify the text to use when dropping connections due to DHAP within an SMTP conversation.
Spam Detection	
Anti-spam scanning	Enable anti-spam scanning on this listener.
Virus Detection	
Anti-virus scanning	Enable the anti-virus scanning on this listener.
Encryption and Authentication	
TLS	<p>Deny, Prefer, or Require Transport Layer Security (TLS) in SMTP conversations for this listener.</p> <p>If you select Preferred, you can make TLS mandatory for envelope senders from a specific domain or with a specific email address by selecting an Address List that specifies those domains and email addresses. When an envelope sender matching a domain or address in this list tries to send a message over a connection that does not use TLS, the appliance rejects the connection and the sender will have to try again using TLS.</p> <p>The Verify Client Certificate option directs the appliance to establish a TLS connection to the user's mail application if the client certificate is valid. If you select this option for the TLS Preferred setting, the appliance still allows a non-TLS connection if the user doesn't have a certificate, but rejects a connection if the user has an invalid certificate. For the TLS Required setting, selecting this option requires the user to have a valid certificate in order for the appliance to allow the connection.</p> <p>For information on creating an address list, see Using a List of Sender Addresses for Incoming Connection Rules, on page 114.</p> <p>For information on using client certificates for TLS connections, see Establishing a TLS Connection from the Appliance, on page 801.</p>
SMTP Authentication	Allows, disallow, or requires SMTP Authentication from remote hosts connecting to the listener. SMTP Authentication is described in detail in the "LDAP Queries" chapter.
If Both TLS and SMTP Authentication are enabled:	Require TLS to offer SMTP Authentication.
Domain Key/ DKIM Signing	Enable Domain Keys or DKIM signing on this listener (ACCEPT and RELAY only).
DKIM Verification	Enable DKIM verification.
S/MIME Decryption and Verification	

Parameter	Description
S/MIME Decryption/Verification	<ul style="list-style-type: none"> • Enable S/MIME decryption or verification. • Choose whether to retain or remove the digital signature from the messages after S/MIME verification. For triple wrapped messages, only the inner signature is retained or removed.
S/MIME Public Key Harvesting	
S/MIME Public Key Harvesting	Enable S/MIME public key harvesting.
Harvest Certificates on Verification Failure	Choose whether to harvest public keys if the verification of the incoming signed messages fail.
Store Updated Certificate	Choose whether to harvest updated public keys.
SPF/SIDF Verification	
Enable SPF/SIDF Verification	Enable SPF/SIDF signing on this listener. For more information, see Email Authentication, on page 577 .
Conformance Level	Set the SPF/SIDF conformance level. You can choose from SPF, SIDF or SIDF Compatible. For details, see Email Authentication, on page 577 .
Downgrade PRA verification result if 'Resent-Sender:' or 'Resent-From:' were used:	If you choose a conformance level of SIDF compatible, configure whether you want to downgrade Pass result of the PRA Identity verification to None if there are Resent-Sender: or Resent-From: headers present in the message. You may choose this option for security purposes.
HELO Test	Configure whether you want to perform a test against the HELO identity (Use this for SPF and SIDF Compatible conformance levels).
DMARC Verification	
Enable DMARC Verification	Enable DMARC verification on this listener. For more information, see DMARC Verification, on page 608 .
Use DMARC Verification Profile	Select the DMARC verification profile that you want to use on this listener.
DMARC Feedback Reports	<p>Enable sending of DMARC aggregate feedback reports.</p> <p>For more information about DMARC aggregate feedback report, see DMARC Aggregate Reports, on page 614.</p> <p>Note DMARC specification requires the feedback report messages to be DMARC compliant. Make sure that these messages are DKIM signed or you must publish appropriate SPF records.</p>
Untagged Bounces	

Parameter	Description
Consider Untagged Bounces to be Valid	Applies only if bounce verification tagging (discussed in the “Configuring Routing and Delivery Features” chapter) is enabled. By default, the appliance considers untagged bounces invalid and either rejects the bounce or adds a custom header, depending on the Bounce Verification settings. If you choose to consider untagged bounces to be valid, the appliance accepts the bounce message.
Envelope Sender DNS Verification	
	See Verifying Senders, on page 116 .
Exception Table	
Use Exception Table	Use the sender verification domain exception table. You can only have one exception table, but you can enable it per mail flow policy. See Sender Verification Exception Table, on page 119 for more information.

Note If anti-spam or anti-virus scanning is enabled globally in the HAT, messages are flagged for anti-spam or anti-virus scanning as they are accepted by the appliance. If anti-spam or anti-virus scanning is disabled after the message is accepted, the message will still be subject to scanning when it leaves the work queue.

Step 4 Submit and commit your changes.

Defining Default Values for Mail Flow Policies

Procedure

- Step 1** Click **Mail Policies > Mail Flow Policies**.
- Step 2** Choose the listener to edit in the Listener field.
- Step 3** Click the **Default Policy Parameters** link below the configured mail flow policies.
- Step 4** Define the default values that all mail flow policies for this listener use.

For more information on the properties, see [Defining Rules for Incoming Messages Using a Mail Flow Policy, on page 107](#).

Step 5 Submit and commit your changes.

Working with the Host Access Table Configuration

You can export all information stored in a Host Access Table to a file, and you can import Host Access Table information stored in a file into the appliance for a listener, overwriting all existing Host Access Table information.

Related Topics

- [Exporting the Host Access Table Configuration to an External File, on page 113](#)
- [Importing the Host Access Table Configuration from an External File, on page 113](#)

Exporting the Host Access Table Configuration to an External File

Procedure

- Step 1** Navigate to the Mail Policies > HAT Overview page.
- Step 2** Choose the listener to edit in the Listener menu.
- Step 3** Click **Export HAT**.
- Step 4** Enter a file name for the exported HAT. This is the name of the file that will be created in the configuration directory on the appliance .
- Step 5** Submit and commit your changes.
-

Importing the Host Access Table Configuration from an External File

When you import a HAT, all of the existing HAT entries are removed from the current HAT.

Procedure

- Step 1** Navigate to the Mail Policies > HAT Overview page.
- Step 2** Choose the listener to edit in the Listener menu.
- Step 3** Click **Import HAT**.
- Step 4** Select a file from the list.
- Note** The file to import must be in the configuration directory on the appliance.
- Step 5** Click **Submit**. You will see a warning message, asking you to confirm that you wish to remove all of the existing HAT entries.
- Step 6** Click **Import**.
- Step 7** Commit your changes.

You can place “comments” in the file. Lines that begin with a ‘#’ character are considered comments and are ignored by AsyncOS. For example:

```
# File exported by the GUI at 20060530T215438
$BLOCKED
    REJECT {}
[ ... ]
```

Using a List of Sender Addresses for Incoming Connection Rules

Mail flow policies allow you to use of an address list for certain settings that apply to a group of envelope senders, such as rate limiting exemptions and mandatory TLS connections. An address list can consist of email addresses, domains, partial domains, and IP addresses. You can use the **Mail Policies > Address Lists** page in the GUI or the `addresslistconfig` command in the CLI to create an address list. The Address Lists page displays all address lists on the appliance, along with any mail flow policies that use an address list.

Procedure

-
- Step 1** Select **Mail Policies > Address Lists**.
- Step 2** Click **Add Address List**.
- Step 3** Enter a name for the address list.
- Step 4** Enter a description of the address list.
- Step 5** (Optional) To enforce using full email addresses in the address list, select **Full Email Addresses only**.
- Step 6** Choose any one of the following options to create an address list:
- Select **Full Email Addresses only** if you want to enforce using full email addresses in the address list.
 - Select **Domains only** if you want to enforce using domains in the address list.
 - Select **IP Addresses only** if you want to enforce using IP addresses in the address list.
- Step 7** Enter the addresses you want to include. You can use the following formats:
- Full email address: `user@example.com`
 - Partial email address: `user@`
- Note** If you have selected **Allow only full Email Addresses**, you cannot use partial email addresses.
- IP address in their email address: `@[1.2.3.4]`
 - All users in a domain: `@example.com`
 - All users in a partial domain: `@.example.com`
- Note that domains and IP addresses must start with a `@` character.
- Separate email addresses with a comma. If you separate the addresses using a new line, AsyncOS automatically converts your entries into a comma-separated list.
- Step 8** Submit and commit your changes.
-

SenderBase Settings and Mail Flow Policies

In order to classify connections to the appliance and apply mail flow policies (which may or may not contain rate limiting), a listener uses the following methodology:

Classification -> Sender Group -> Mail Flow Policy -> Rate Limiting

For more information, see [Sender Groups Defined by Network Owners, Domains, and IP Addresses](#), on page 96.

The “Classification” stage uses the sending host’s IP address to classify an inbound SMTP session (received on a public listener) into a Sender Group. The Mail Flow Policy associated with that Sender Group may have parameters for rate limiting enabled. (Rate limiting limits the maximum number of messages per session, the maximum number of recipients per message, the maximum message size, and/or the maximum number of concurrent connections you are willing to accept from a remote host.)

Normally, in this process, recipients are counted against each sender in the corresponding named sender group. If mail is received from several senders in the same hour, the total recipients for all senders is compared against the limit.

There are some exceptions to this counting methodology:

- If the classification is done by Network Owner, then the IP Reputation Service will automatically divide a large block of addresses into smaller blocks.

Counting of recipients and recipient rate limiting is done separately for each of these smaller blocks (usually, but not always, the equivalent of a /24 CIDR block).

- If the HAT Significant Bits feature is used. In this case, a large block of addresses may be divided into smaller blocks by applying the significant bits parameter associated with the policy.

Note that this parameter relates to the **Mail Flow Policy -> Rate Limiting** phase. It is not the same as the “bits” field in the “network/bits” CIDR notation that may be used to classify IP addresses in a Sender Group.

By default, IP Reputation Service and IP Profiling support are *enabled* for public listeners and *disabled* for private listeners.

Related Topics

- [HAT Significant Bits Feature](#), on page 115

HAT Significant Bits Feature

Beginning with the 3.8.3 release of AsyncOS, you can track and rate limit incoming mail on a per-IP address basis while managing sender group entries in a listener’s Host Access Table (HAT) in large CIDR blocks. For example, if an incoming connection matched against the host “10.1.1.0/24,” a counter could still be generated for each individual address within that range, rather than aggregating all traffic into one large counter.



Note In order for the significant bits HAT policy option to take effect, you *must* not enable “User SenderBase” in the Flow Control options for the HAT (or, for the CLI, answer **no** to the question for enabling the SenderBase Information Service in the `listenerconfig -> setup` command: “Would you like to enable Reputation Filters and IP Profiling support?”). That is, the Hat Significant Bits feature and enabling SenderBase IP Profiling support are mutually exclusive.

In most cases, you can use this feature to define sender groups *broadly* — that is, large groups of IP addresses such as “10.1.1.0/24” or “10.1.0.0/16” — while applying mail flow rate limiting *narrowly* to smaller groups of IP addresses.

The HAT Significant Bits feature corresponds to these components of the system:

- [HAT Configuration](#) , on page 116
- [Significant Bits HAT Policy Option](#) , on page 116
- [Injection Control Periodicity](#) , on page 116

HAT Configuration

There are two parts of HAT configuration: sender groups and mail flow policies. Sender group configuration defines how a sender's IP address is “classified” (put in a sender group). Mail flow policy configuration defines how the SMTP session from that IP address is controlled. When using this feature, an IP address may be “classified in a CIDR block” (e.g. 10.1.1.0/24) sender group while being controlled as an individual host (/32). This is done via the “significant_bits” policy configuration setting.

Significant Bits HAT Policy Option

The HAT syntax allows for the `significant_bits` configuration option. This feature appears in the GUI in the Mail Policies > Mail Flow Policies page.

When the option to use SenderBase for flow control is set to “OFF” or Directory Harvest Attack Prevention is enabled, the “significant bits” value is applied to the connecting sender’s IP address, and the resulting CIDR notation is used as the token for matching defined sender groups within the HAT. Any rightmost bits that are covered by the CIDR block are “zeroed out” when constructing the string. Thus, if a connection from the IP address 1.2.3.4 is made and matches on a policy with the `significant_bits` option set to 24, the resultant CIDR block would be 1.2.3.0/24. So by using this feature, the HAT sender group entry (for example, 10.1.1.0/24) can have a different number of network significant bits (24) from the significant bits entry in the policy assigned to that group (32, in the example).

For more information on `listenerconfig` command, see the CLI Reference Guide for AsyncOS for Cisco Email Security Appliances .

Injection Control Periodicity

A global configuration option exists to allow you to adjust when the injection control counters are reset. For very busy systems maintaining counters for a very large number of different IP addresses, configuring the counters to be reset more frequently (for example, every 15 minutes instead of every 60 minutes) will ensure that the data does not grow to an unmanageable size and impact system performance.

The current default value is 3600 seconds (1 hour). You can specify periods ranging from as little as 1 minute (60 seconds) to as long as 4 hours (14,400 seconds).

Adjust this period via the GUI, using the global settings (for more information, see [Configuring Global Settings for Listeners](#), on page 72).

You can also adjust this period using the `listenerconfig -> setup` command in the CLI. For more information on `listenerconfig` command, see the CLI Reference Guide for AsyncOS for Cisco Email Security Appliances .

Verifying Senders

Spam and unwanted mail is frequently sent by senders whose domains or IP addresses cannot be resolved by DNS. DNS verification means that you can get reliable information about senders and process mail accordingly. Sender verification prior to the SMTP conversation (connection filtering based on DNS lookups of the sender’s IP address) also helps reduce the amount of junk email processed through the mail pipeline on the appliance .

Mail from unverified senders is not automatically discarded. Instead, AsyncOS provides sender verification settings that allow you to determine how the appliance handles mail from unverified senders: you can configure your appliance to automatically block all mail from unverified senders prior to the SMTP conversation or throttle unverified senders, for example.

The sender verification feature consists of the following components:

- **Verification of the connecting host.** This occurs prior to the SMTP conversation. For more information, see [Sender Verification: Host, on page 117](#).
- **Verification of the domain portion of the envelope sender.** This occurs during the SMTP conversation. For more information, see [Sender Verification: Envelope Sender, on page 118](#).

Related Topics

- [Sender Verification: Host, on page 117](#)
- [Sender Verification: Envelope Sender, on page 118](#)
- [Implementing Sender Verification — Example Settings, on page 119](#)
- [Testing Your Settings for Messages from Unverified Senders, on page 122](#)
- [Sender Verification and Logging, on page 123](#)

Sender Verification: Host

Senders can be unverified for different reasons. For example, the DNS server could be “down” or not responding, or the domain may not exist. Host DNS verification settings for sender groups allow you to classify unverified senders prior to the SMTP conversation and include different types of unverified senders in your various sender groups.

The appliance attempts to verify the sending domain of the connecting host via DNS for incoming mail. This verification is performed prior to the SMTP conversation. The system acquires and verifies the validity of the remote host’s IP address (that is, the domain) by performing a *double DNS lookup*. A double DNS lookup is defined as a reverse DNS (PTR) lookup on the IP address of the connecting host, followed by a forward DNS (A) lookup on the results of the PTR lookup. The appliance then checks that the results of the A lookup match the results of the PTR lookup. If the PTR or A lookups fail, or the results do not match, the system uses only the IP address to match entries in the HAT and the sender is considered as not verified.

Unverified senders are classified into the following categories:

- Connecting host PTR record does not exist in the DNS.
- Connecting host PTR record lookup fails due to temporary DNS failure.
- Connecting host reverse DNS lookup (PTR) does not match the forward DNS lookup (A).

Using the sender group “Connecting Host DNS Verification” settings, you can specify a behavior for unverified senders (see [Throttling Messages from Unverified Senders Using the SUSPECTLIST Sender Group, on page 120](#)).

You can enable host DNS verification in the sender group settings for any sender group; however, keep in mind that adding host DNS verification settings to a sender group means *including* unverified senders in that group. That means that spam and other unwanted mail will be included. Therefore, you should only enable these settings on sender groups that are used to reject or throttle senders. Enabling host DNS verification on the ALLOWED_LIST sender group, for example, would mean that mail from unverified senders would receive the same treatment as mail from your trusted senders in your ALLOWED_LIST (including bypassing anti-spam/anti-virus checking, rate limiting, etc., depending on how the mail flow policy is configured).

Sender Verification: Envelope Sender

With envelope sender verification, the domain portion of the envelope sender is DNS verified. (Does the envelope sender domain resolve? Is there an A or MX record in DNS for the envelope sender domain?) A domain does not resolve if an attempt to look it up in the DNS encounters a temporary error condition such as a timeout or DNS server failure. On the other hand, a domain does not exist if an attempt to look it up returns a definitive “domain does not exist” status. This verification takes place during the SMTP conversation whereas host DNS verification occurs before the conversation begins — it applies to the IP address of connecting SMTP server.

In more detail: AsyncOS performs an MX record query for the domain of the sender address. AsyncOS then performs an A record lookup based on the result of the MX record lookup. If the DNS server returns “NXDOMAIN” (there is no record for this domain), AsyncOS treats that domain as non-existent. This falls into the category of “Envelope Senders whose domain does not exist.” NXDOMAIN can mean that the root name servers are not providing any authoritative name servers for this domain.

However, if the DNS server returns “SERVFAIL,” it is categorized as “Envelope Senders whose domain does not resolve.” SERVFAIL means that the domain does exist but DNS is having transient problems looking up the record.

A common technique for spammers or other illegitimate senders of mail is to forge the MAIL FROM information (in the envelope sender) so that mail from unverified senders that is accepted will be processed. This can lead to problems as bounce messages sent to the MAIL FROM address are undeliverable. Using envelope sender verification, you can configure your appliance to reject mail with malformed (but not blank) MAIL FROMs.

For each mail flow policy, you can:

- Enable envelope sender DNS verification.
- Offer custom SMTP code and response for malformed envelope sender. Malformed envelope senders are blocked if you have enabled envelope sender DNS verification.
- Offer custom response for envelope sender domains which do not resolve.
- Offer custom response for envelope sender domains which do not exist in DNS.

You can use the sender verification exception table to store [Sender Verification Exception Table, on page 119](#) a list of domains or addresses from which mail will be automatically allowed or rejected (see). The sender verification exception table can be enabled independently of Envelope Sender verification. So, for example, you can still reject special addresses or domains specified in the exception table without enabling envelope sender verification. You can also always allow mail from internal or test domains, even if they would not otherwise be verified.

Though most spam is from unverifiable senders, there are reasons why you might want to accept mail from an unverified sender. For example, not all legitimate email can be verified through DNS lookups — a temporary DNS server problem can stop a sender from being verified.

When mail from unverified senders is attempted, the sender verification exception table and mail flow policy envelope sender DNS verification settings are used to classify envelope senders during the SMTP conversation. For example, you may accept and throttle mail from sending domains that are not verified because they do not exist in DNS. Once that mail is accepted, messages with malformed MAIL FROMs are rejected with a customizable SMTP code and response. This occurs during the SMTP conversation.

You can enable envelope sender DNS verification (including the domain exception table) in the mail flow policy settings for any mail flow policy via the GUI or the CLI (`listenerconfig -> edit -> hostaccess -> < policy >`).

Related Topics

- [Partial Domains, Default Domains, and Malformed MAIL FROMs, on page 119](#)
- [Custom SMTP Code and Response, on page 119](#)
- [Sender Verification: Envelope Sender, on page 118](#)

Partial Domains, Default Domains, and Malformed MAIL FROMs

If you enable envelope sender verification or disable allowing partial domains in SMTP Address Parsing options for a listener (see the SMTP Address Parsing Options section in the “Configuring the Gateway to Receive Email” chapter), the default domain settings for that listener will no longer be used.

These features are mutually exclusive.

Custom SMTP Code and Response

You can specify the SMTP code and response message for messages with malformed envelope senders, for envelope senders which do not exist in DNS, and for envelope senders which do not resolve via DNS queries (DNS server might be down, etc.).

In the SMTP response, you can include a variable, `$EnvelopeSender`, which is expanded to the value of the envelope sender when the custom response is sent.

While typically a “Domain does not exist” result is permanent, it is possible for this to be a transient condition. To handle such cases, “conservative” users may wish to change the error code from the default 5XX to a 4XX code.

Sender Verification Exception Table

The sender verification exception table is a list of domains or email addresses that will either be automatically allowed or rejected during the SMTP conversation. You can also specify an optional SMTP code and reject response for rejected domains. There is only one sender verification exception table per appliance and it is enabled per mail flow policy.

The sender verification exception table can be used to list obviously fake but correctly formatted domains or email addresses from which you want to reject mail. For example, the correctly formatted MAIL FROM: `pres@whitehouse.gov` could be listed in the sender verification exception table and set to be automatically rejected. You can also list domains that you want to automatically allow, such as internal or test domains. This is similar to envelope recipient (SMTP RCPT TO command) processing which occurs in the Recipient Access Table (RAT).

The sender verification exception table is defined in the GUI via the Mail Policies > Exception Table page (or the CLI, via the `exceptionconfig` command) and then is enabled on a per-policy basis via the GUI (see [Defining Messages to Send to Unverified Senders Using the ACCEPTED Mail Flow Policy, on page 121](#)) or the CLI (see the *CLI Reference Guide for AsyncOS for Cisco Email Security Appliances*).

Entries in the sender verification exception table have the following syntax:

See [Excluding Unverified Senders from Sender Verification Rules Based on Sender’s Email Address, on page 122](#) for more information about modifying the exception table.

Implementing Sender Verification — Example Settings

This section provides an example of a typical conservative implementation of host and envelope sender verification.

For this example, when implementing host sender verification, mail from connecting hosts for which reverse DNS lookup does not match is throttled via the existing SUSPECTLIST sender group and THROTTLED mail flow policy.

A new sender group (UNVERIFIED) and a new mail flow policy (THROTTLEMORE) are created. Mail from connecting hosts which are not verified will be throttled (using the UNVERIFIED sender group and the more aggressive THROTTLEMORE mail flow policy) prior to the SMTP conversation.

Envelope sender verification is enabled for the ACCEPTED mail flow policy.

The following table shows the suggested settings for implementing sender verification:

Table 19: Sender Verification: Suggested Settings

Sender Group	Policy	Include
UNVERIFIED SUSPECTLIST	THROTTLEMORE THROTTLED	Prior to SMTP conversation: Connecting host PTR record does not exist in the DNS. Connecting host reverse DNS lookup (PTR) does not match the forward DNS lookup (A).
	ACCEPTED	Envelope Sender Verification during SMTP conversation: - Malformed MAIL FROM: - Envelope sender does not exist in DNS. - Envelope sender DNS does not resolve.

Related Topics

- [Throttling Messages from Unverified Senders Using the SUSPECTLIST Sender Group](#), on page 120
- [Implementing More Stringent Throttling Settings for Unverified Senders](#), on page 121
- [Defining Messages to Send to Unverified Senders Using the ACCEPTED Mail Flow Policy](#), on page 121
- [Excluding Unverified Senders from Sender Verification Rules Based on Sender’s Email Address](#), on page 122
- [Searching for Addresses within the Sender Verification Exception Table](#), on page 122

Throttling Messages from Unverified Senders Using the SUSPECTLIST Sender Group

Procedure

-
- Step 1** Select **Mail Policies > HAT Overview**.
 - Step 2** Click **SUSPECTLIST** in the list of sender groups.
 - Step 3** Click **Edit Settings**.
 - Step 4** Select the **THROTTLED** policy from the list.
 - Step 5** Check the “Connecting host reverse DNS lookup (PTR) does not match the forward DNS lookup (A)” checkbox under Connecting Host DNS Verification.
 - Step 6** Submit and commit your changes.

Now, senders for which reverse DNS lookups fail will match the SUSPECTLIST sender group and will receive the default action from the THROTTLED mail flow policy.

Implementing More Stringent Throttling Settings for Unverified Senders

Procedure

- Step 1** Create a new mail flow policy (for this example, it is named THROTTLEMORE) and configure it with more stringent throttling settings.
- On the Mail Flow Policies page, click **Add Policy**
 - Enter a name for the mail flow policy, and select Accept as the Connection Behavior.
 - Configure the policy to throttle mail.
 - Submit and commit your changes.
- Step 2** Create a new sender group (for this example, it is named UNVERIFIED) and configure it to use the THROTTLEMORE policy:
- On the HAT Overview page, click **Add Sender Group**
 - Select the THROTTLEMORE policy from the list.
 - Check the “Connecting host PTR record does not exist in DNS” checkbox under Connecting Host DNS Verification.
 - Submit and commit your changes.
-

Defining Messages to Send to Unverified Senders Using the ACCEPTED Mail Flow Policy

Procedure

- Step 1** Select **Mail Policies > Mail Flow Policies**.
- Step 2** On the Mail Flow Policies page, click on the ACCEPTED mail flow policy.
- Step 3** Scroll down to the **Sender Verification** section.
- Step 4** In the **Envelope Sender DNS Verification** section, do the following:
- Select **On** to enable envelope sender DNS verification for this mail flow policy.
 - You may also define custom SMTP code and responses.
- Step 5** In the **Use Domain Exception Table** section, select **On** to enable the domain exception table.
- Step 6** Submit and commit your changes.
-

Excluding Unverified Senders from Sender Verification Rules Based on Sender's Email Address

Procedure

Step 1 Select **Mail Policies > Exception Table**.

Note The exception table applies globally to all mail flow policies with “Use Exception Table” enabled.

Step 2 Click **Add Domain Exception** on the Mail Policies > Exception Table page.

Step 3 Enter an email address. You can enter a specific address (pres@whitehouse.gov), a name (user@), a domain (@example.com or @.example.com), or an address with a bracketed IP address (user@[192.168.23.1]).

Step 4 Specify whether to allow or reject messages from the address. When rejecting mail, you can also specify an SMTP code and custom response.

Step 5 Submit and commit your changes.

Searching for Addresses within the Sender Verification Exception Table

Procedure

Step 1 Enter the email address in the Find Domain Exception section of the Exception Table page.

Step 2 Click **Find**.

If the address matches any of the entries in the table, the first matching entry is displayed.

Testing Your Settings for Messages from Unverified Senders

Now that you have configured sender verification settings, you can verify the behavior of your appliance.

Note that testing DNS-related settings is beyond the scope of this document.

Related Topics

- [Sending a Test Message with a Malformed MAIL FROM Sender Address, on page 122](#)
- [Sending a Message from an Address That is Excluded from Sender Verification Rules, on page 123](#)

Sending a Test Message with a Malformed MAIL FROM Sender Address

While it may be difficult to test the various DNS-related settings for your THROTTLED policy, you can test the malformed MAIL FROM setting.

Procedure

Step 1 Open a Telnet session to your appliance .

Step 2 Use SMTP commands to send a test message with a malformed MAIL FROM (something like “admin” without a domain).

Note If you have configured your appliance to use a default domain or to specifically allow partial domains when sending or receiving email or if you have enabled address parsing (see the “Configuring the Gateway to Receive Email” chapter) you may not be able to create, send, and receive an email with a missing or malformed domain.

Step 3 Verify that the message is rejected.

```
# telnet IP_address_of_Email_Security_Appliance port
220 hostname ESMTP
helo example.com
250 hostname
mail from: admin
553 #5.5.4 Domain required for sender address
```

Note that the SMTP code and response is the one you configured for the envelope sender verification settings for the THROTTLED mail flow policy.

Sending a Message from an Address That is Excluded from Sender Verification Rules

To confirm that mail from the email address listed in the sender verification exception table is not subject to envelope sender verification:

Procedure

Step 1 Add the following address to the exception table with an “Allow” behavior: admin@zzzaazzz.com

Step 2 Commit your changes.

Step 3 Open a Telnet session to your appliance .

Step 4 Use SMTP commands to send a test message from the email address you entered in the sender verification exception table (admin@zzzaazzz.com).

Step 5 Verify that the message is accepted.

```
# telnet IP_address_of_Email_Security_Appliance port
220 hostname ESMTP
helo example.com
250 hostname
mail from: admin@zzzaazzz.com
250 sender <admin@zzzaazzz.com> ok
```

If you remove that email address from the sender verification exception table, mail from that sender will be rejected because the domain portion of the envelope sender is not DNS verified.

Sender Verification and Logging

The following log entries provide an example of Sender Verification verdicts.

Related Topics

- [Envelope Sender Verification, on page 124](#)

Envelope Sender Verification

Malformed Envelope Senders:

```
Thu Aug 10 10:14:10 2006 Info: ICID 3248 Address: <user> sender rejected, envelope sender domain missing
```

Domain does not exist (NXDOMAIN):

```
Wed Aug 9 15:39:47 2006 Info: ICID 1424 Address: <user@domain.com> sender rejected, envelope sender domain does not exist
```

Domain does not resolve (SERVFAIL):

```
Wed Aug 9 15:44:27 2006 Info: ICID 1425 Address: <user@domain.com> sender rejected, envelope sender domain could not be resolved
```



CHAPTER 8

Accepting or Rejecting Connections Based on Domain Name or Recipient Address

This chapter contains the following sections:

- [Overview of Accepting or Rejecting Connections Based on the Recipient's Address, on page 125](#)
- [Overview of the Recipient Access Table \(RAT\), on page 126](#)
- [Accessing the RAT using the GUI, on page 126](#)
- [Accessing the RAT using the CLI, on page 126](#)
- [Editing the Default RAT Entry, on page 126](#)
- [Domains and Users, on page 127](#)

Overview of Accepting or Rejecting Connections Based on the Recipient's Address

AsyncOS uses a Recipient Access Table (RAT) for each public listener to manage accept and reject actions for recipient addresses. Recipient addresses include these:

- Domains
- Email addresses
- Groups of email addresses

The System Setup Wizard guides the administrator in configuring at least one public listener (with default values) on the appliance. Configuring a public listener during setup involves specifying default local domains or specific addresses to accept mail. These local domains or specific addresses are the first entries in the RAT for that public listener.

For each public listener, the default entry, “All Other Recipients”, rejects email from all recipients. The administrator defines all local domains for which the appliance accepts messages. Optionally, you can also define specific users for whom the appliance will accept or reject messages. AsyncOS allows you to define acceptable local domains and specific users using the Recipient Access Table (RAT).

You might need to configure a listener to accept messages for multiple domains. For example, if your organization uses the domain `currentcompanyname.com` and it previously used `oldcompanyname.com`, then you might accept messages for both `currentcompanyname.com` and `oldcompanyname.com`. In this case, include both local domains in the RAT for your public listener.

(Note: the Domain Map feature can map messages from one domain to another. See the Domain Map feature section of the “Configuring Routing and Delivery Features” chapter.)

Overview of the Recipient Access Table (RAT)

The Recipient Access Table defines which recipients are accepted by a public listener. At a minimum, the table specifies the address and whether to accept or reject it.

The Recipient Access Table (RAT) page shows a listing of the entries in the RAT including the order, default action, and whether or not the entry has been configured to bypass LDAP accept queries.

Accessing the RAT using the GUI

GUI

Procedure

Navigate to **Mail Policies > Recipient Access Table (RAT)**.

Accessing the RAT using the CLI

CLI

Procedure

Use the `listenerconfig` command with the `edit > rcptaccess > new` subcommands.

Editing the Default RAT Entry

Before you begin

- Set up a public listener.
- Plan edits with caution, ensuring you do not create an *open relay* on the Internet. An open relay (sometimes called an “insecure relay” or a “third-party” relay) is an SMTP email server that allows third-party relay of email messages. By processing mail that is neither for — nor from — a local user, an open relay makes it possible for an unscrupulous sender to route large volumes of spam through your gateway. By default, the RAT *rejects* all recipients to prevent creation of an open relay.
- Note that you cannot delete the default entry from the RAT.

Procedure

Step 1 Navigate to **Mail Policies > Recipient Access Table (RAT)**.

Step 2 Click **All Other Recipients**.

Domains and Users

Modifying the Domains For Which to Accept Messages using the RAT

Use the Mail Policies > Recipient Access Table (RAT) page to configure the local domains and specific users for which the appliance accepts messages. On this page, you can perform the following tasks:

- Add, delete, and modify entries in the RAT.
- Change the order of the entries.
- Export RAT entries to a text file.
- Import RAT entries from a text file. Importing from a text file overwrites the existing entries.

Related Topics

- [Adding Domains and Users For Which to Accept Messages, on page 127](#)
- [Rearranging the Order of Domains and Users in the Recipient Access Table, on page 129](#)
- [Exporting the Recipient Access Table to an External File, on page 130](#)
- [Importing the Recipient Access Table from an External File, on page 130](#)

Adding Domains and Users For Which to Accept Messages

Procedure

- Step 1** Navigate to the **Mail Policies > Recipient Access Table (RAT)** page.
- Step 2** Choose the listener to edit in the Overview for Listener field.
- Step 3** Click **Add Recipient**.
- Step 4** Select an order for the entry.
- Step 5** Enter the recipient address.
- Step 6** Choose to accept or reject the recipient.
- Step 7** (Optional) Choose to bypass LDAP acceptance queries for the recipient.
- Step 8** (Optional) Use a custom SMTP response for this entry.
- a) Select Yes for Custom SMTP Response.
 - b) Enter an SMTP response code and text. Include the SMTP response to the RCPT TO command for the recipient.
- Step 9** (Optional) Choose to bypass throttling by selecting Yes for Bypass Receiving Control.
- Step 10** Submit and commit your changes.
-

What to do next

Related Topics

- [Defining Recipient Addresses, on page 128](#)

- [Bypassing LDAP Accept for Special Recipients, on page 128](#)
- [Bypassing Throttling for Special Recipients, on page 129](#)

Defining Recipient Addresses

The RAT allows you to define a recipient or group of recipients. Recipients can be defined by full email address, domain, partial domain, username, or IP address:

[IPv4 address]	Specific Internet Protocol version 4 (IPv4) address of the host. Note that the IP address must be between the “ [] ” characters.
[IPv6 address]	Specific Internet Protocol version 6 (IPv6) address of the host. Note that the IP address must be between the “ [] ” characters.
division.example.com	Fully-qualified domain name.
.partialhost	Everything within the “partialhost” domain.
user@domain	Complete email address.
user@	Anything with the given username.
user@[IP_address]	Username at a specific IPv4 or IPv6 address. Note that the IP address must be between the “ [] ” characters. Note that “ user@IP_address ” (without the bracket characters) is not a valid address. The system will append the brackets when it receives the message to create a valid address, which could affect whether a recipient is matched in the RAT.



Note When you add a domain to the Recipient Access Table in step 4 of the System Setup Wizard in the GUI (see [Step 3: Network, on page 35](#)), you might want to consider adding a second entry to specify subdomains. For example, if you type the domain `example.net`, you might also want to enter `.example.net`. The second entry ensures that mail destined for any subdomain of `example.net` will match in the Recipient Access Table. Note that *only* specifying `.example.com` in the RAT will accept for all subdomains of `.example.com` but *will not* accept mail for complete email address recipients *without* a subdomain (for example `joe@example.com`).

Bypassing LDAP Accept for Special Recipients

If you configure LDAP acceptance queries, you may wish to bypass the acceptance query for certain recipients. This feature can be useful if there are recipients for whom you receive email which you do not want to be delayed or queued during LDAP queries, such as `customercare@example.com`.

If you configure the recipient address to be rewritten in the work queue prior to the LDAP acceptance query, (such as aliasing or using a domain map), the rewritten address will not bypass LDAP acceptance queries. For example you use an alias table to map `customercare@example.com` to `bob@example.com` and `sue@example.com`. If you configure bypassing LDAP acceptance for `customercare@example.com`, an LDAP acceptance query is still run for `bob@example.com` and `sue@example.com` after the aliasing takes place.

To configure bypassing LDAP acceptance via the GUI, select **Bypass LDAP Accept Queries for this Recipient** when you add or edit the RAT entry.

To configure bypassing LDAP acceptance queries via the CLI, answer yes to the following question when you enter recipients using the `listenerconfig -> edit -> rcptaccess` command:

```
Would you like to bypass LDAP ACCEPT for this entry? [Y]> y
```

When you configure a RAT entry to bypass LDAP acceptance, be aware that the order of RAT entries affects how recipient addresses are matched. The RAT matches the recipient address with the first RAT entry that qualifies. For example, you have the following RAT entries: `postmaster@ironport.com` and `ironport.com`. You configure the entry for `postmaster@ironport.com` to bypass LDAP acceptance queries, and you configure the entry for `ironport.com` for ACCEPT. When you receive mail for `postmaster@ironport.com`, the LDAP acceptance bypass will occur only if the entry for `postmaster@ironport.com` is before the entry for `ironport.com`. If the entry for `ironport.com` is before the `postmaster@ironport.com` entry, the RAT matches the recipient address to this entry and applies the ACCEPT action.

Bypassing Throttling for Special Recipients

For recipient entries, you can specify that the recipient bypasses throttling control mechanisms enabled on the listener.

This feature is useful if there are certain recipients for whom you do not want to limit messages. For example, many users will want to receive email for the address “`postmaster@domain`” on a listener, even if the sending domain is being throttled based on the receiving control defined in mail flow policies. Specifying this recipient to bypass receiving control in a listener’s RAT allows the listener to receive unlimited messages for the recipient “`postmaster@domain`” while retaining mail flow policies for other recipients in the same domain. Recipients will avoid being counted against the recipients-per-hour counter maintained by the system if the sending domain is being limited.

To specify certain recipients to bypass receiving control via the GUI, select Yes for the “Bypass Receiving Control” setting when adding or editing a RAT entry:

To specify certain recipients to bypass receiving control via the CLI, answer yes to the following question when you enter recipients using the `listenerconfig > edit > rcptaccess` command:

```
Would you like to bypass receiving control for this entry? [N]> y
```

Rearranging the Order of Domains and Users in the Recipient Access Table

Procedure

-
- Step 1** Navigate to the **Mail Policies > Recipient Access Table (RAT)** page.
 - Step 2** Choose the listener to edit in the **Overview for Listener** field.
 - Step 3** Click **Edit Order**.
 - Step 4** Change the order by arranging the values in the **Order** column.
 - Step 5** Submit and commit your changes.
-

Exporting the Recipient Access Table to an External File

Procedure

- Step 1** Navigate to the **Mail Policies > Recipient Access Table (RAT)** page.
 - Step 2** Choose the listener to edit in the **Overview for Listener** field.
 - Step 3** Click **Export RAT**.
 - Step 4** Enter a file name for the exported entries.
This is the name of the file that will be created in the configuration directory on the appliance.
 - Step 5** Submit and commit your changes.
-

Importing the Recipient Access Table from an External File

When you import Recipient Access Table entries from a text file, all of the existing entries are removed from the Recipient Access Table.

Procedure

- Step 1** Navigate to the **Mail Policies > Recipient Access Table (RAT)** page.
- Step 2** Choose the listener to edit in the **Overview for Listener** field.
- Step 3** Click **Import RAT**.
- Step 4** Select a file from the list.
AsyncOS lists all text files in the configuration directory on the appliance .
- Step 5** Click **Submit**.
A warning message displays asking you to confirm that you want to remove all of the existing Recipient Access Table entries.
- Step 6** Click **Import**.
- Step 7** Commit your changes.
You can place “comments” in the file. Lines that begin with a ‘#’ character are considered comments and are ignored by AsyncOS. For example:

Example:

```
# File exported by the GUI at 20060530T220526
.example.com ACCEPT
ALL REJECT
```



CHAPTER 9

Using Message Filters to Enforce Email Policies

The appliance contains extensive content scanning and message filtering technology that allows you to enforce corporate policies and act on specific messages as they enter or leave your corporate networks.

This chapter contains information about the powerful combinations of features available for policy enforcement: a content scanning engine, message filters, attachment filters, and content dictionaries.

This chapter contains the following sections:

- [Overview, on page 131](#)
- [Components of a Message Filter, on page 132](#)
- [Message Filter Processing, on page 134](#)
- [Message Filter Rules, on page 139](#)
- [Message Filter Actions, on page 185](#)
- [Attachment Scanning, on page 217](#)
- [Detecting Malicious Files in Messages Attachments Using Message Filter , on page 227](#)
- [Using the CLI to Manage Message Filters, on page 228](#)
- [Message Filter Examples, on page 243](#)
- [Configuring Scan Behavior, on page 250](#)

Overview

Message filters allow you to create special rules describing how to handle messages as they are received by the appliance. A message filter specifies that a certain kind of email message should be given special treatment. Cisco message filters also allow you to enforce corporate email policy by scanning the content of messages for words you specify. This chapter contains the following sections:

- **Components of a message filter.** Message filters allow you to create special rules describing how to handle messages as they are received. Filter rules identify messages based on message or attachment content, information about the network, message envelope, message headers, or message body. Filter actions generate notifications or allow messages to be dropped, bounced, archived, blind carbon copied, or altered. For more information, see [Components of a Message Filter, on page 132](#).
- **Processing Message Filters.** When AsyncOS processes message filters, the content that AsyncOS scans, the order of the processing, and the actions taken are based on several factors, including the message filter order, any prior processing that may have altered the message content, the MIME structure of the message, the threshold score configured for content matching, and structure of the query. For more information, see [Message Filter Processing, on page 134](#).

- **Message Filter Rules.** Each filter has a rule that defines the collection of messages that the filter can act upon. You define those rules when you create a message filter. For more information, see [Message Filter Rules, on page 132](#).
- **Message Filter Actions.** Each filter has an action that is performed on a message if the rule evaluates to true. There are two types of actions that can be performed: final actions (such as delivering, dropping, or bouncing a message), or non-final actions (such as stripping or inserting a header) which permit the message to be further processed. For more information, see [Message Filter Actions, on page 132](#).
- **Attachment Scanning Message Filters.** Attachment scanning message filters allow you to strip attachments from messages that are inconsistent with your corporate policies, while still retaining the ability to deliver the original message. You can filter attachments based on their specific file type, fingerprint, or content. You can also scan image attachments using an image analyzer. The image analyzer uses algorithms that measure image attributes to determine the likelihood of inappropriate content. These algorithms can detect, for example, the shapes and color palette in an image. The analyzer can identify the type of shapes in an image and the percentage of any flesh-tone colors relative to the other colors in the image to help identify inappropriate content. Images with a high percentage of flesh-tone colors are more likely to be inappropriate. The algorithms do not discriminate in any way. For more information, see [Attachment Scanning, on page 217](#).
- **Using the CLI to Manage Message Filters.** The CLI accepts commands for working with message filters. For example, you might want to display, reorder, import or export a list of message filters. For more information, see [Using the CLI to Manage Message Filters, on page 228](#).
- **Message Filter Examples.** This section contains some real world examples of filters with a brief discussion of each. For more information, see [Message Filter Examples, on page 243](#).

Components of a Message Filter

Message filters allow you to create special rules describing how to handle messages as they are received. A message filter is comprised of message filter rules and message filter actions.

Related Topics

- [Message Filter Rules, on page 132](#)
- [Message Filter Actions, on page 132](#)
- [Message Filter Example Syntax, on page 133](#)

Message Filter Rules

Message filter rules determine the messages that a filter will act on. Rules may be combined using the logical connectors AND, OR, and NOT to create more complex tests. Rule expressions may also be grouped using parentheses.

Message Filter Actions

The purpose of message filters is to perform actions on selected messages.

The two types of actions are:

- *Final* actions — such as deliver, drop, and bounce — end the processing of a message, and permit no further processing through subsequent filters.
- *Non-final* actions perform an action which permits the message to be processed further.



Note Non-final message filter actions are cumulative. If a message matches multiple filters where each filter specifies a different action, then all actions are accumulated and enforced. However, if a message matches multiple filters specifying the same action, the prior actions are overridden and the final filter action is enforced.

Related Topics

- [Filter Actions Summary Table, on page 186](#)
- [Action Variables, on page 195](#)
- [Matched Content Visibility, on page 197](#)
- [Description and Examples of Message Filter Actions, on page 198](#)

Message Filter Example Syntax

The intuitive meaning of a filter specification is:

if the message matches the rule, *then* apply the actions in sequence. If the else clause is present, the actions within the else clause are executed in the event the message does not match the rule.

The name of the filter you specify makes it easier to manage filters when you are activating, deactivating, or deleting them.

Message filters use the following syntax:

Example Syntax	Purpose
expedite:	filter name
if (recv-listener == 'InboundMail' or recv-int == 'notmain')	rule specification
<pre>{ alt-src-host('outbound1'); skip-filters(); }</pre>	action specification
<pre>else { alt-src-host('outbound2'); }</pre>	optional alternative action specification

Note that you can omit any alternative actions:

Example Syntax	Purpose
expedite2:	filter name
<pre>if ((not (recv-listener == 'InboundMail')) and (not (recv-int == 'notmain')))</pre>	rule specification

Example Syntax	Purpose
<pre>{ alt-src-host('outbound2'); skip-filters(); }</pre>	action specification

You can combine several filters in sequence within a single text file, one following the other.

You must enclose the values in filters in either single or double quotation marks. Single or double quotation marks must be equally paired on each side of the value; for example, the expressions `notify('customercare@example.com')` and `notify("customercare@example.com")` are both legal, but the expression `notify("customercare@example.com')` causes a syntax error.

Lines beginning with a ‘#’ character are considered comments and are ignored; however, they are not preserved by AsyncOS as can be verified by viewing a filter via `filters -> detail`.

Message Filter Processing

When AsyncOS processes message filters, the content that AsyncOS scans, the order of the processing, and the actions taken are based on several factors:

- **Message filter order.** Message filters are maintained in an ordered list. When a message is processed, AsyncOS applies each message filter in the order it appears in the list. If a final action occurs, no further action is taken on the message. For more information, see [Message Filter Order, on page 135](#).
- **Prior processing.** Actions performed on AsyncOS messages may add or remove headers before the message filter is evaluated. AsyncOS processes the message filter process on the headers that are present in the message at the time of processing. For more information, see [Message Header Rules and Evaluation, on page 135](#).
- **The MIME structure of the message.** The MIME structure of the message determines which part of the message is treated as “body,” and which part of the message is treated as an “attachment”. Many message filters are configured to act on just the body or just the attachment part of the message. For more information, see [Message Bodies vs. Message Attachments, on page 135](#).
- **The threshold score configured for the regular expression.** When you match a regular expression, you configure a “score” to tally up the number of times a match must occur before a filter action is taken. This allows you to “weight” the responses to different terms. For more information, see [Thresholds for Matches in Content Scanning, on page 136](#).
- **The structure of the query.** When evaluating AND or OR tests within message filters, AsyncOS does not evaluate unneeded tests. In addition, it is important to note that the system does not evaluate the tests from left to right. Instead, when AND and OR tests are evaluated, the least expensive test is evaluated first. For more information, see [AND Test and OR Tests in Message Filters, on page 139](#).

Related Topics

- [Message Filter Order, on page 135](#)
- [Message Header Rules and Evaluation, on page 135](#)
- [Message Bodies vs. Message Attachments, on page 135](#)
- [Thresholds for Matches in Content Scanning, on page 136](#)
- [AND Test and OR Tests in Message Filters, on page 139](#)

Message Filter Order

Message filters are kept in an ordered list and numbered by their position in the list. When a message is processed, the message filters are applied in the associated numeric order. Therefore, filter number 30 will not have a chance to alter the source host of a message if filter number 9 has already executed a final action on (for example, bounced) the message. The position of a filter in the list can be changed via the system user interfaces. Filters imported via a file are ordered based on their relative order in the imported file.

After a final action, no further actions may be taken on the message.

Although a message may match a filter rule, the filter may not act upon that message for any of the following reasons:

- The filter is inactive.
- The filter is invalid.
- The filter has been superseded by an earlier filter that executed a final action for the message.

Message Header Rules and Evaluation

Filters evaluate “processed” headers rather than the original message headers when applying header rules. Thus:

- If a header was added by a previous processing action, it can now be matched by any subsequent header rule.
- If a header was stripped by a previous processing action, it can no longer be matched by any subsequent header rule.
- If a header was modified by a previous processing action, any subsequent header rule will evaluate the modified header and not the original message header.

This behavior is common to both message filters and content filters.

Message Bodies vs. Message Attachments

An email message is composed of multiple parts. Although RFCs define everything that comes after a message’s headers as a multipart “message body,” many users still conceptualize a message’s “body” and its “attachment” differently. When you use any of the Cisco message filters named *body-variable* or *attachment-variable*, the appliance attempts to distinguish the parts that most users consider to be the “body” and the “attachment” in the same way that many MUAs attempt to render these parts differently.

For the purposes of writing *body-variable* or *attachment-variable* message filter rules, everything after the message headers is considered the message *body*, whose content is considered the first text part of the MIME parts that are within the body. Anything after the content, (that is, any additional MIME parts) is considered an *attachment*. AsyncOS evaluates the different MIME parts of the message, and identifies the parts of the file that is treated as an attachment.

For example, The following figure shows a message in the Microsoft Outlook MUA where the words “Document attached below.” appear as a plain text message *body* and the document “This is a Microsoft Word document.doc” appears as an *attachment*. Because many users conceptualize email this way (rather than as a multipart message whose first part is plain text and whose second part is a binary file), the Cisco uses the term “attachment” in message filters to create rules to differentiate and act on the .doc file part (in essence, the second MIME part) as opposed to the “body” of the message (the first, plain text part) — although, according to the language used in RFCs 1521 and 1522, a message’s *body* is comprised of all MIME parts.

Figure 16: Message with "Attachment"

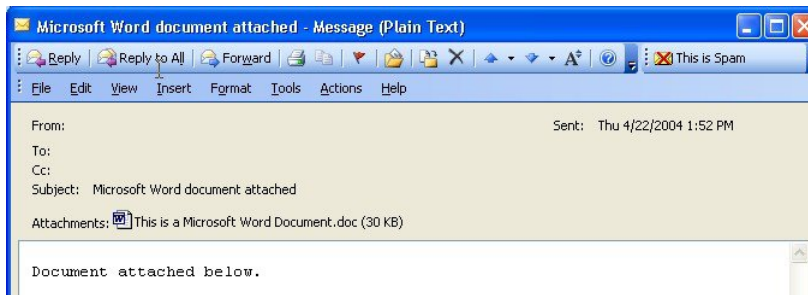

Because the appliance makes this distinction between the *body* and the *attachment* in multipart messages, there are several cases you should be aware of when using the *body - variable* or *attachment-variable* message filter rules in order to achieve the expected behavior:

- If you have a message with a single text part—that is, a message containing a header of “Content-Type: text/plain” or “Content-Type: text/html” — the appliance will consider the entire message as the body. If the content type is anything different, the appliance considers it to be a single attachment.
- Some encoded files (uencoded, for example) are included in the body of the email message. When this occurs, the encoded file is treated as an attachment, and it is extracted and scanned, while the remaining text is considered to be the body of the text.
- A single, non-text part is always considered an *attachment*. For example, a message consisting of only a.zip file is considered an attachment.

Thresholds for Matches in Content Scanning

When you add filter rules that search for patterns in the message body or attachments, you can specify the minimum threshold for the number of times the pattern must be found. When AsyncOS scans the message, it totals the “score” for the number of matches it finds in the message and attachments. If the minimum threshold is not met, the regular expression does not evaluate to true. You can specify this threshold for the following filter rules:

- body-contains
- only-body-contains
- attachment-contains
- every-attachment-contains
- dictionary-match
- attachment-dictionary-match

You can also specify a threshold value for the `drop-attachments-where-contains` action.



Note You cannot specify thresholds for filter rules that scan headers or envelope recipients and senders.

Related Topics

- [Threshold Syntax, on page 137](#)
- [Threshold Scoring for Message Bodies and Attachments, on page 137](#)
- [Threshold Scoring Multipart/Alternative MIME Parts, on page 137](#)

- [Threshold Scoring for Content Dictionaries, on page 138](#)

Threshold Syntax

To specify a threshold for the minimum number of occurrences, specify the pattern and the minimum number of matches required to evaluate to true:

```
if(<filter rule>(<pattern>,<minimum threshold>){
```

For example, to specify that the `body-contains` filter rule must find the value “Company Confidential” at least two times, use the following syntax:

```
if(body-contains('Company Confidential',2)){
```

By default, when AsyncOS saves a content scanning filter, it compiles the filter and assigns a threshold value of 1, if you have not assigned a value.

You can also specify a minimum number of pattern matches for values in a content dictionary. For more information about content dictionaries, see the “Text Resources” chapter.

Threshold Scoring for Message Bodies and Attachments

An email message may be composed of multiple parts. When you specify threshold values for filter rules that search for patterns in the message body or attachments, AsyncOS counts the number of matches in the message parts and attachments to determine the threshold “score.” Unless the message filter specifies a specific MIME part (such as the `attachment-contains` filter rule), AsyncOS will total the matches found in all parts of the message to determine if the matches total the threshold value. For example, you have a `body-contains` message filter with a threshold of 2. You receive a message in which the body contains one match, and the attachment contains one match. When AsyncOS scores this message, it totals the two matches and determines that the threshold score has been met.

Similarly, if you have multiple attachments, AsyncOS totals the scores for each attachment to determine the score for matches. For example, you have an `attachment-contains` filter rule with a threshold of 3. You receive a message with two attachments, and each attachment contains two matches. AsyncOS would score this message with four matches and determine that the threshold score has been met.

Threshold Scoring Multipart/Alternative MIME Parts

To avoid duplicate counting, if there are two representatives of the same content (plain text and HTML), AsyncOS does not total the matches from the duplicate parts. Instead, it compares the matches in each part and selects the highest value. AsyncOS would then add this value to the scores from other parts of the multipart message to create a total score.

For example, you configure a `body-contains` filter rule and set the threshold to 4. You then receive a message that contains both plain text, HTML and two attachments. The message would use the following structure:

```
multipart/mixed

    multipart/alternative

        text/plain

        text/html
```

```
application/octet-stream
```

```
application/octet-stream
```

The `body-contains` filter rule would determine the score for this message by first scoring the `text/plain` and `text/html` parts of the message. It would then compare the results of these scores and select the highest score from the results. Next, it would add this result to the score from each of the attachments to determine the final score. Suppose the message has the following number of matches:

```
multipart/mixed
```

```
multipart/alternative
```

```
text/plain (2 matches)
```

```
text/html (2 matches)
```

```
application/octet-stream (1 match)
```

```
application/octet-stream
```

Because AsyncOS compares the matches for the `text/plain` and `text/html` parts, it returns a score of 3, which does not meet the minimum threshold to trigger the filter rule.

Threshold Scoring for Content Dictionaries

When you use a content dictionary, you can “weight” terms so that certain terms trigger filter actions more easily. For example, you may want not want to trigger a message filter for the term, “bank.” However, if the term, “bank” is combined with the term, “account,” and accompanied with an ABA routing number, you may want to trigger a filter action. To accomplish this, you can use a weighted dictionary to give increased importance to certain terms or a combination of terms. When a message filter that uses a content dictionary scores the matches for filter rule, it uses these weights to determine the final score. For example, suppose you create a content dictionary with the following contents and weights:

Table 20: Sample Content Dictionary

Term/Smart Identifier	Weight
ABA Routing Number	3
Account	2
Bank	1

When you associate this content dictionary with a `dictionary-match` or `attachment-dictionary-match` message filter rule, AsyncOS would add the weight for the term to the total “score” for each instance of the matching term found in the message. For example, if the message contains three instances of the term, “account” in the message body, AsyncOS would add a value of 6 to the total score. If you set the threshold value for the message filter to 6, AsyncOS would determine that the threshold score has been met. Or, if the message contained one instance of each term, the total value would be 6, and this score would trigger the filter action.

AND Test and OR Tests in Message Filters

When evaluating AND or OR tests within message filters, AsyncOS does not evaluate unneeded tests. So, for example, if one side of an AND test is false, the system will not evaluate the other side. It is important to note that the system does not evaluate the tests from left to right. Instead, when AND and OR tests are evaluated, the least expensive test is evaluated first. For example, in the following filter, the `remote-ip` test will always be processed first because it has a lower cost than the `rcpt-to-group` test (generally LDAP tests are more expensive):

```
andTestFilter:

if (remote-ip == "192.168.100.100" AND rcpt-to-group == "GROUP")

    { ... }
```

Because the least expensive test is performed first, switching the order of the items in the test will have no effect. If you want to guarantee the order in which tests are performed, use nested if statements. This is also the best way to ensure that an expensive test is avoided whenever possible:

```
expensiveAvoid:

if (<simple tests>)

    { if (<expensive test>)

        { <action> }

    }
```

In a somewhat more complicated example, consider:

```
if (test1 AND test2 AND test3) { ... }
```

The system groups the expression from left to right, so this becomes:

```
if ((test1 AND test2) AND test3) { ... }
```

This means the first thing the system does is compare the cost of `(test1 AND test2)` against the cost of `test3`, evaluating the second AND first. If all three tests have the same cost, then `test3` will be performed first because `(test1 AND test2)` would be twice as expensive.

Message Filter Rules

Each message filter contains a rule that defines the collection of messages that a filter can act upon. You define the filter rules, and then you define a filter action for messages that return true .

Related Topics

- [Filter Rules Summary Table, on page 140](#)
- [Regular Expressions in Rules, on page 150](#)
- [Smart Identifiers, on page 154](#)

- [Description and Examples of Message Filter Actions, on page 198](#)

Filter Rules Summary Table

The following table summarizes the rules you can use in message filters.

Table 21: Message Filter Rules

Rule	Syntax	Description
Subject Header	subject	Does the subject header match a certain pattern? See Subject Rule, on page 157 .
Body Size	body-size	Is the body size within some range? See Body Size Rule, on page 159 .
Envelope Sender	mail-from	Does the Envelope Sender (i.e., the Envelope From, <MAIL FROM>) match a given pattern? See Envelope Sender Rule, on page 158 .
Envelope Sender in Group	mail-from-group	Is the Envelope Sender (i.e., the Envelope From, <MAIL FROM>) in a given LDAP group? See Envelope Sender in Group Rule, on page 159 .
Sender Group	sendergroup	Which sender group was matched in a listener's Host Access Table (HAT)? See Sender Group Rule, on page 159 .
Envelope Recipient	rcpt-to	Does the Envelope Recipient, (i.e. the Envelope To, <RCPT TO>) match a given pattern? See Envelope Recipient Rule, on page 157 . Note The <code>rcpt-to</code> rule is message-based. If a message has multiple recipients, only one recipient has to match the rule for the specified action to affect the message to all recipients.

Rule	Syntax	Description
Envelope Recipient in Group	<code>rcpt-to-group</code>	<p>Is the Envelope Recipient, (i.e. the Envelope To, <RCPT TO>) in a given LDAP group? See Envelope Recipient in Group Rule, on page 158.</p> <p>Note The <code>rcpt-to-group</code> rule is message-based. If a message has multiple recipients, only one recipient has to be found in a group for the specified action to affect the message to all recipients.</p>
Remote IP	<code>remote-ip</code>	Was the message sent from a remote host that matches a given IP address or IP block? See Remote IP Rule , on page 160.
Receiving Interface	<code>rcv-int</code>	Did the message arrive via the named receiving interface? See Receiving IP Interface Rule , on page 161
Receiving Listener	<code>rcv-listener</code>	Did the message arrive via the named listener? See Receiving Listener Rule , on page 160.
Date	<code>date</code>	Is current time before or after a specific time and date? See Date Rule , on page 161.
Header	<code>header(<string>)</code>	Does the message contain a specific header? Does the value of that header match a certain pattern? See Header Rule , on page 161.
Random	<code>random(<integer>)</code>	Is a random number in some range? See Random Rule , on page 162.
Recipient Count	<code>rcpt-count</code>	How many recipients is this email going to? See Recipient Count Rule , on page 163.

Filter Rules Summary Table

Rule	Syntax	Description
Address Count	<code>addr-count ()</code>	What is the cumulative number of recipients? This filter differs from the <code>rcpt-count</code> filter rule in that it operates on the message body headers instead of the envelope recipients. See Address Count Rule, on page 163 .
SPF Status	<code>spf-status</code>	What was the SPF verification status? This filter rule allows you to query for different SPF verification results. You can enter a different action for each valid SPF/SIDF return value. See SPF-Status Rule, on page 169 .
SPF Passed	<code>spf-passed</code>	Did the SPF/SIDF verification pass? This filter rule generalizes the SPF/SIDF results as a Boolean value. See SPF-Passed Rule, on page 170 .
S/MIME Gateway Message	<code>smime-gateway</code>	Is the message S/MIME signed, encrypted, or signed and encrypted? See S/MIME Gateway Message Rule, on page 171
S/MIME Gateway Verified	<code>smime-gateway-verified</code>	Is the S/MIME message successfully verified, decrypted, or decrypted and verified? See S/MIME Gateway Verified Rule, on page 171 .
Image verdict	<code>image-verdict</code>	What was the image scanning verdict? This filter rule allows you to query for different image analysis verdicts. See Image Analysis, on page 220 .
Workqueue count	<code>workqueue-count</code>	Is the work queue count equal to, less than, or greater than the specified value? See Workqueue-count Rule, on page 171 .

Rule	Syntax	Description
Body Scanning	<code>body-contains(<regular expression>)</code>	Does the message contain text or an attachment that matches a specified pattern? Does the pattern occur the minimum number of times you specified for the threshold value? The engine scans delivery-status parts and associated attachments. See Body Scanning , on page 164.
Body Scanning	<code>only-body-contains (<regular expression>)</code>	Does the message body contain text that matches a specified pattern? Does the pattern occur the minimum number of times you specified for the threshold value? Attachments are not scanned. See Body Scanning Rule , on page 163.
Encryption Detection	<code>encrypted</code>	Is the message encrypted? See Encryption Detection Rule , on page 164.
Attachment Filename	<code>attachment-filename</code>	Does the message contain an attachment with a filename that matches a specific pattern? See Attachment Filename Rule , on page 165.
Attachment Type	<code>attachment-type</code>	Does the message contain an attachment of a particular MIME type? See Attachment Type Rule , on page 165.

Rule	Syntax	Description
Attachment File Type	<code>attachment-filetype</code>	<p>Does the message contain an attachment of a file type that matches a specific pattern based on its fingerprint (similar to a UNIX <code>file</code> command)? If the attachment is an Excel or Word document, you can also search for the following embedded file types: <code>.exe</code>, <code>.dll</code>, <code>.bmp</code>, <code>.tiff</code>, <code>.pcx</code>, <code>.gif</code>, <code>.jpeg</code>, <code>png</code>, and Photoshop images.</p> <p>You must enclose the file type in quotes to create a valid filter. You can use single or double quotes. For example, to search for <code>.exe</code> attachments, use the following syntax:</p> <pre>if (attachment-filetype == "exe")</pre> <p>For more information, see Attachment Filenames and Single Compressed Files within Archive Files, on page 166.</p>
Attachment MIME Type	<code>attachment-mimetype</code>	<p>Does the message contain an attachment of a specific MIME type? This rule is similar to the <code>attachment-type</code> rule, except only the MIME type given by the MIME attachment is evaluated. (The appliance does not try to “guess” the type of the file by its extension if there is no explicit type given.) See Examples of Attachment Scanning Message Filters, on page 224.</p>
Attachment Protected	<code>attachment-protected</code>	<p>Does the message contain an attachment that is password protected? See Quarantining Protected Attachments, on page 227.</p>

Rule	Syntax	Description
Attachment Unprotected	<code>attachment-unprotected</code>	<p>The <code>attachment-unprotected</code> filter condition returns true if the scanning engine detects an attachment that is unprotected. A file is considered unprotected if the scanning engine was able to read the attachment. A zip file is considered to be unprotected if any of its members is unprotected.</p> <p>Note — The <code>attachment-unprotected</code> filter condition is not mutually exclusive of the <code>attachment-protected</code> filter condition. It is possible for both filter conditions to return true when scanning the same attachment. This can occur, for example, if a zip file contains both protected and unprotected members.</p> <p>See Detecting Unprotected Attachments, on page 227.</p>
Attachment Scanning	<code>attachment-contains</code> (<i><regular expression></i>)	<p>Does the message contain an attachment that contains text or another attachment that matches a specific pattern? Does the pattern occur the minimum number of times you specified for the threshold value?</p> <p>This rule is similar to the <code>body-contains()</code> rule, but it attempts to avoid scanning the entire “body” of the message. That is, it attempts to scan only that which the user would view as being an attachment. See Examples of Attachment Scanning Message Filters, on page 224.</p>
Attachment Scanning	<code>attachment-binary-contains</code> (<i><regular expression></i>)	<p>Does the message contain an attachment with binary data that matches a specific pattern?</p> <p>This rule is like the <code>attachment-contains()</code> rule, but it searches specifically for patterns in the binary data.</p>

Rule	Syntax	Description
Attachment Scanning	<code>every-attachment-contains</code> (<i><regular expression></i>)	Do all of the attachments in this message contain text that matches a specific pattern? The text must exist in all attachments and the action performed is, in effect, a logical AND operation of an ' <code>attachment-contains()</code> ' for each attachment. The body is not scanned. Does the pattern occur the minimum number of times you specified for the threshold value? See Examples of Attachment Scanning Message Filters , on page 224.
Attachment Size	<code>attachment-size</code>	Does the message contain an attachment whose size is within some range? This rule is similar to the <code>body-size</code> rule, but it attempts to avoid scanning the entire “body” of the message. That is, it attempts to scan only that which the user would view as being an attachment. The size is evaluated prior to any decoding. See Examples of Attachment Scanning Message Filters , on page 224.
Public Blocked lists	<code>dnslist(<query server>)</code>	Does the sender’s IP address appear on a public blocked list server (RBL)? See DNS List Rule , on page 166.
IP Reputation	<code>reputation</code>	What is the sender’s IP Reputation Score? See IP Reputation Rule , on page 167.
No IP Reputation	<code>no-reputation</code>	Used to test if IP Reputation Score is “None.” See IP Reputation Rule , on page 167.
Dictionary	<code>dictionary-match</code> (<i><dictionary_name></i>)	Does the message body contain any of the regular expressions or terms in the content dictionary named <i>dictionary_name</i> ? Does the pattern occur the minimum number of times you specified for the threshold value? See Dictionary Rules , on page 167.

Rule	Syntax	Description
Attachment Dictionary Match	attachment-dictionary-match (<i><dictionary_name></i>)	Does the attachment contain any of the regular expressions in the content dictionary named <i>dictionary_name</i> ? Does the pattern occur the minimum number of times you specified for the threshold value? See Dictionary Rules, on page 167 .
Subject Dictionary Match	subject-dictionary-match (<i><dictionary_name></i>)	Does the Subject header contain any of the regular expressions or terms in the content dictionary named <i>dictionary name</i> ? See Dictionary Rules, on page 167 .
Header Dictionary Match	header-dictionary-match (<i><dictionary_name></i> , <i><header></i>)	Does the specified header (case insensitive) contain any of the regular expressions or terms in the content dictionary named <i>dictionary name</i> ? See Dictionary Rules, on page 167 .
Body Dictionary Match	body-dictionary-match (<i><dictionary_name></i>)	This filter condition returns true if the dictionary term matches content in the body of the message only. The filter searches for terms within the MIME parts not considered to be an attachment, and it returns true if the user-defined threshold is met (the default threshold value is one). See Dictionary Rules, on page 167 .
Envelope Recipient Dictionary Match	rcpt-to-dictionary-match (<i><dictionary_name></i>)	Does the envelope recipient contain any of the regular expressions or terms in the content dictionary named <i>dictionary name</i> ? See Dictionary Rules, on page 167 .
Envelope Sender Dictionary Match	mail-from-dictionary-match (<i><dictionary_name></i>)	Does the envelope sender contain any of the regular expressions or terms in the content dictionary named <i>dictionary name</i> ? See Dictionary Rules, on page 167 .
SMTP Authenticated User Match	smtp-auth-id-matches (<i><target></i> [, <i><sieve-char></i>])	Does the address of the Envelope Sender and the address in message header match the authenticated SMTP user ID of the sender? See SMTP Authenticated User Match Rule, on page 172 .

Rule	Syntax	Description
True	true	Matches all messages. See True Rule, on page 156 .
Valid	valid	Returns false if the message contains unparseable/invalid MIME parts and true otherwise. See Valid Rule, on page 157 .
Signed	signed	Is the message is signed? See Signed Rule, on page 173 .
Signed Certificate	signed-certificate (<field> [<operator> <regular expression>])	Does the message signer or X.509 certificate issuer match a certain pattern? See Signed Certificate Rule, on page 174 .
Header Repeats	header-repeats (<target>, <threshold> [, <direction>])	Returns true if at a given point in time, a specified number of messages: <ul style="list-style-type: none"> • With same subject header are detected in last one hour. • From same envelope-sender are detected in last one hour. See Header Repeats Rule, on page 176 .
URL Reputation	url-reputation url-no-reputation	Is the reputation score of any URL in the message within the specified range? Is a reputation score for a URL unavailable? See URL Reputation Rules , on page 178 and Configuring Email Gateway to Consume External Threat Feeds, on page 295 .
URL Category	url-category	Does the category of any URL in the message match the specified categories? See URL Category Rule , on page 179 .
Corrupt Attachment	attachment-corrupt	Does this message have an attachment that is corrupt? See Corrupt Attachment Rule, on page 179 .

Rule	Syntax	Description
Message Language	message-language	Is the message (subject and body) in one of the selected languages? See Message Language Rule, on page 179 .
Macro Detection	macro-detection-rule (['file_type-1', 'file_type-2', ..., 'file_type-n'])	Does the incoming or outgoing message contain macro-enabled attachments? See Macro Detection Rule, on page 180
Forged Email Detection	forged-email-detection ("<dictionary_name>", <threshold>)	Is the sender address of the message forged? The rule checks if the From: header in the message is similar to any of the users in the content dictionary. See Forged Email Detection Rule, on page 181 .
Duplicate Boundaries Verification	duplicate_boundaries	Does the message contain duplicate MIME boundaries? See Duplicate Boundaries Verification Rule, on page 182 .
Malformed MIME Header Detection	malformed-header	Does the message contain malformed MIME headers? See Malformed MIME Header Detection Rule, on page 182 .
Geolocation	geolocation-rule (['country_name-1', 'country_name-2', 'country_name-n'])	Does the incoming message originate from the selected countries? Note Enable the Anti-Spam engine on your appliance before you use the Geolocation message filter rule. See Geolocation Rule, on page 183 .

Rule	Syntax	Description
Domain Reputation	<p>Sender Domain Reputation:</p> <ul style="list-style-type: none"> - sdr-reputation (<'sdr_verdict_range'>, <'domain_exception_list'>) - sdr-age (<'unit'>, <'operator'> <'actual value'>) - sdr-unscannable (<'domain_exception_list'>) <p>External Threat Feeds:</p> <pre>domain-external- threat-feeds (<'external_threat_ feed_source_name'>, <'header'> , <'domain_ exception_list'>)</pre>	<p>Does the sender domain match the specified criteria?</p> <ul style="list-style-type: none"> • Sender Domain Reputation • External Threat Feeds <p>See Domain Reputation Rule for ETF, on page 183 or Domain Reputation Rule for SDR, on page 183.</p> <p>For more information, see the Configuring Email Gateway to Consume External Threat Feeds, on page 295 or Sender Domain Reputation Filtering, on page 313.</p>

Each message injected into the appliance is processed through all message filters in order, unless you specify a final action, which stops the message from being processed further. (See [Message Filter Actions, on page 132](#).) Filters may also apply to all messages, and rules may also be combined using logical connectors (AND, OR, NOT).

Regular Expressions in Rules

Several of the atomic tests used to define rules use *regular expression matching*. Regular expressions can become complex. Use the following table as a guide for the applying of regular expressions within message filter rules:

Table 22: Regular Expression in Rules

Regular expression (abc)	<p>Regular expressions in filter rules match a string if the sequence of directives in the regular expression match any part of the string.</p> <p>For example, the regular expression <code>Georg</code> matches the string <code>George Of The Jungle</code>, the string <code>Georgy Porgy</code>, the string <code>La Meson Georgette</code> as well as <code>Georg</code>.</p>
Carat (^) Dollar sign (\$)	<p>Rules containing the dollar sign character (\$) only match the end of the string, and rules containing the caret symbol (^) only match the beginning of the string.</p> <p>For example, the regular expression <code>^Georg\$</code> only matches the string <code>Georg</code>.</p> <p>Searching for an empty header would look like this: <code>"^\$"</code></p>
Letters, white space and the at sign (@) character	<p>Rules containing characters, white space, and the at sign character (@) only match themselves explicitly.</p> <p>For example, the regular expression <code>^George@admin\$</code> only matches the string <code>George@admin</code>.</p>

Period character (.)	<p>Rules containing a period character (.) match any character (except a new line).</p> <p>For example, the regular expression <code>^...admin\$</code> matches the string <code>macadmin</code> as well as the string <code>sunadmin</code> but not <code>win32admin</code>.</p>
Asterisk (*) directive	<p>Rules containing an asterisk (*) match “zero or more matches of the previous directive.” In particular, the sequence of a period and an asterisk (.*) matches any sequence of characters (not containing a new line).</p> <p>For example, the regular expression <code>^P.*Piper\$</code> matches all of these strings: <code>PPiper</code> , <code>Peter Piper</code> , <code>P.Piper</code> , and <code>Penelope Penny Piper</code> .</p>
Backslash special characters (\)	<p>The backslash character <i>escapes</i> special characters. Thus the sequence <code>\.</code> only matches a literal period, the sequence <code>\\$</code> only matches a literal dollar sign, and the sequence <code>\^</code> only matches a literal caret symbol. For example, the regular expression <code>^ik\.ac\.uk\$</code> only matches the string <code>ik.ac.uk</code>.</p> <p>Important Note: The backslash is also a special escape character for the parser. As a result, if you want to include backslash in your regular expression, you must use <i>two</i> backslashes — so that after parsing, only one “real” backslash remains, which is then passed to the regular expression system. So, if you wanted to match the example domain above, you would enter <code>^ik\\.ac\\.uk\$</code>.</p>
Case-insensitivity ((?i))	<p>The token <code>(?i)</code> that indicates the rest of the regular expression should be treated in case-insensitive mode. Placing this token at the beginning of a case-sensitive regular expression results in a completely insensitive match.</p> <p>For example, the regular expression “<code>(?i)viagra</code>” matches <code>Viagra</code> , <code>vIaGrA</code> , and <code>VIAGRA</code> .</p>
Number of repetitions {min,max}	<p>The regular expression notation that indicates the number of repetitions of the previous token is supported.</p> <p>For example, the expression “<code>fo{2,3}</code>” matches <code>foo</code> and <code>fooo</code> but not <code>fo</code> or <code>fofo</code> .</p> <p>This statement: <code>if(header('To') == "^.{500,}")</code> looks for a “To” header that has 500 or more characters in it.</p>
Or ()	<p>Alternation, or the “or” operator. If A and B are regular expressions, the expression “<code>A B</code>” will match any string that matches either “A” or “B.”</p> <p>For example, the expression “<code>foo bar</code>” will match either <code>foo</code> or <code>bar</code> , but not <code>foobar</code> .</p>

Related Topics

- [Using Regular Expressions to Filter Messages, on page 152](#)
- [Guidelines for Using Regular Expressions, on page 152](#)
- [Regular Expression and Non-ASCII Character Sets, on page 152](#)
- [n Tests, on page 153](#)
- [Case-sensitivity, on page 153](#)
- [Writing Efficient Filters, on page 153](#)

- [PDFs and Regular Expressions, on page 154](#)

Using Regular Expressions to Filter Messages

You can use filters to search for strings and patterns in non-ASCII encoded message content (both headers and bodies). Specifically, the system supports regular expression (regex) searching for non-ASCII character sets within:

- Message headers
- MIME attachment filename strings
- Message body:
 - Bodies without MIME headers (i.e. traditional email)
 - Bodies with MIME headers indicating encoding but no MIME parts
 - Multi-part MIME messages with encoding indicated
 - All of the above without the encoding specified in a MIME header

You can use regular expressions (regexes) to match on any part of the message or body, including matching attachments. The various attachment types include text, HTML, MS Word, Excel, and others. Examples of character sets of interest include gb2312, HZ, EUC, JIS, Shift-JIS, Big5, and Unicode. Message filter rules with regular expressions can be created through the content filter GUI, or using a text editor to generate a file that is then imported into the system. For more information, see [Using the CLI to Manage Message Filters, on page 228](#) and [Configuring Scan Behavior, on page 250](#).

Guidelines for Using Regular Expressions

It is important to begin a regular expression with a caret (^) and end it with a dollar sign (\$) whenever you want to exactly match a string and not a prefix.



Note

When matching an empty string, do not use "" as that actually matches *all* strings. Instead use "^\$". For an example, see the second example in [Subject Rule, on page 157](#).

It is also important to remember that if you want to match a literal period, you must use an escaped period in the regular expression. For example, the regular expression sun.com matches the string `thegodsunocommando`, but the regular expression `^sun\.com$` only matched the string `sun.com`.

Technically, the style of regular expressions used are **Python re Module** style regular expressions. For a more detailed discussion of Python style regular expressions, consult the Python Regular Expression HOWTO, accessible from: <http://www.python.org/doc/howto/>

Regular Expression and Non-ASCII Character Sets

In some languages, the concepts of a word or word boundary, or case do not exist.

Complex regular expressions that depend on concepts like what is or is not a character that would compose a word (represented as “\w” in regex syntax) cause problems when the locale is unknown or if the encoding is not known for certain.

The regular expression engine only has to start twice and the filter is arguably easier to maintain as you do not have to worry about adding “()”, spelling errors. In contrast to the above, this should show a decrease in CPU overhead.

PDFs and Regular Expressions

Depending on how a PDF is generated, it may contain no spaces or line breaks. When this occurs, the scanning engine attempts to insert logical spaces and line breaks based on the location of the words on the page. For example, when a word is constructed using multiple fonts or font sizes, the PDF code is rendered in a way that makes it difficult for the scanning engine to determine word and line breaks. When you attempt to match a regular expression against a PDF file constructed in this way, the scanning engine may return unexpected results.

For example, you enter a word in a PowerPoint document that uses different fonts and different font sizes for each letter in the word. When a scanning engine reads a PDF generated from this application, it inserts logical spaces and line breaks. Because of the construction of the PDF, it may interpret the word “callout” as “call out” or “c a l l out.” Attempting to match either of these renderings against the regular expression, “callout,” would result in no matches.

Smart Identifiers

When you use message rules that scan message content, you can use smart identifiers to detect certain patterns in the data.

Smart identifiers can detect the following patterns in data:

- Credit card numbers
- U.S. Social Security numbers
- Committee on Uniform Security Identification Procedures (CUSIP) numbers
- American Banking Association (ABA) routing numbers

To use smart identifiers in a filter, enter the following keywords in a filter rule that scans body or attachment content:

Table 23: Smart Identifiers in Message Filters

Key Word	Smart Identifier	Description
*credit	Credit card number	Identifies 14-, 15-, and 16- digit credit card numbers. NOTE: The smart identifier does not identify enRoute cards.
*aba	ABA routing number	Identifies ABA routing numbers.
*ssn	Social security number	Identifies U.S. social security numbers. The *ssn smart identifier identifies social security numbers with dashes, periods and spaces.
*cusip	CUSIP number	Identifies CUSIP numbers.

Related Topics

- [Smart Identifier Syntax, on page 155](#)

Smart Identifier Syntax

When you use a smart identifier in a filter rule, enter the smart-identifier keyword in quotes within a filter rule that scans the body or attachment file, as in the example below:

```
ID_Credit_Cards:

if (body-contains ("*credit")) {

notify ("legaldept@example.com");

}

.
```

You can also use smart identifiers in content filters and as a part of content dictionaries.



Note You cannot combine a smart identifier key word with a normal regular expression or another key word. For example the pattern `*credit|*ssn` would not be valid.



Note To minimize on false positives using the `*SSN` smart identifier, it may be helpful to use the `*ssn` smart identifier along with other filter criteria. One example filter that can be used is the “only-body-contains” filter condition. This will only evaluate the expression to be true if the search string is present in all of the message body mime parts. For example, you could create the following filter:

```
SSN-nohtml: if only-body-contains ("*ssn") { duplicate-quarantine ("Policy"); }
```

Description and Examples of Message Filter Rules

The following section describes the various message filter rules in use and their examples.

Related Topics

- [True Rule, on page 156](#)
- [Valid Rule, on page 157](#)
- [Subject Rule, on page 157](#)
- [Envelope Recipient Rule, on page 157](#)
- [Envelope Recipient in Group Rule, on page 158](#)
- [Envelope Sender Rule, on page 158](#)
- [Envelope Sender in Group Rule, on page 159](#)
- [Sender Group Rule, on page 159](#)
- [Body Size Rule, on page 159](#)
- [Remote IP Rule, on page 160](#)
- [Receiving Listener Rule, on page 160](#)
- [Receiving IP Interface Rule, on page 161](#)
- [Date Rule, on page 161](#)
- [Header Rule, on page 161](#)

- [Random Rule](#), on page 162
- [Recipient Count Rule](#), on page 163
- [Address Count Rule](#), on page 163
- [Body Scanning Rule](#), on page 163
- [Body Scanning](#) , on page 164
- [Encryption Detection Rule](#), on page 164
- [Attachment Type Rule](#), on page 165
- [Attachment Filename Rule](#), on page 165
- [DNS List Rule](#), on page 166
- [IP Reputation Rule](#), on page 167
- [Dictionary Rules](#), on page 167
- [SPF-Status Rule](#), on page 169
- [SPF-Passed Rule](#), on page 170
- [S/MIME Gateway Message Rule](#), on page 171
- [S/MIME Gateway Verified Rule](#), on page 171
- [Workqueue-count Rule](#), on page 171
- [SMTP Authenticated User Match Rule](#), on page 172
- [Signed Rule](#), on page 173
- [Header Repeats Rule](#), on page 176
- [URL Reputation Rules](#) , on page 178
- [URL Category Rule](#) , on page 179
- [Corrupt Attachment Rule](#), on page 179
- [Message Language Rule](#), on page 179
- [Macro Detection Rule](#), on page 180
- [Forged Email Detection Rule](#), on page 181
- [Duplicate Boundaries Verification Rule](#), on page 182
- [Malformed MIME Header Detection Rule](#), on page 182
- [Geolocation Rule](#), on page 183
- [Domain Reputation Rule for ETF](#), on page 183
- [Domain Reputation Rule for SDR](#), on page 183

True Rule

The true rule matches all messages. For example, the following rule changes the IP interface to external for all messages it tests.

```
externalFilter:

    if (true)

    {

        alt-src-host('external');

    }
```

Valid Rule

The `valid` rule returns `false` if the message contains unparsable/invalid MIME parts and `true` otherwise. For example, the following rule drops all unparsable messages it tests.

```
not-valid-mime:
if not valid
{
drop();
}
```

Subject Rule

The `subject` rule selects those messages where the value of the subject header matches the given regular expression.

For example, the following filter discards all messages with subjects that start with the phrase Make Money...

```
not-valid-mime:
if not valid
{
drop();
}
```

You can specify non-ASCII characters to search for in the value of the header.

When working with headers, remember that the current value of the header includes changes made during processing (such as with filter actions that add, remove, or modify message headings). See [Message Header Rules and Evaluation, on page 135](#) for more information.

The following filter returns `true` if the headers are empty or if the headers are missing from the message:

```
EmptySubject_To_filter:
if (header('Subject') != ".") OR
(header('To') != ".") {
drop();
}
```



Note This filter returns `true` for empty Subject and To headers, but it also returns `true` for missing headers. If the message does not contain the specified headers, the filter still returns `true`.

Envelope Recipient Rule

The `rcpt-to` rule selects those messages where any Envelope Recipient matches the given regular expression. For example, the following filter drops all messages sent with an email address containing the string “scarface.”



Note The regular expression for the `rcpt-to` rule is case *insensitive* .

```
scarfaceFilter:
if (rcpt-to == 'scarface')
{
drop();
}
```



Note The `rcpt-to` rule is message-based. If a message has multiple recipients, only one recipient has to match the rule for the specified action to affect the message to all recipients.

Envelope Recipient in Group Rule

The `rcpt-to-group` rule selects those messages where any Envelope Recipient is found to be a member of the LDAP group given. For example, the following filter drops all messages sent with an email address within the LDAP group “ExpiredAccounts.”

```
expiredFilter:
if (rcpt-to-group == 'ExpiredAccounts')
{
drop();
}
```



Note The `rcpt-to-group` rule is message-based. If a message has multiple recipients, only one recipient has to match the rule for the specified action to affect the message to all recipients.

Envelope Sender Rule

The `mail-from` rule selects those messages where the Envelope Sender matches the given regular expression. For example, the following filter immediately delivers any message sent by `admin@yourdomain.com` .



Note The regular expression for the `mail-from` rule is case *insensitive* . Note that the period character is escaped in the following example.

```
kremFilter:
if (mail-from == '^admin@yourdomain\\.com$')
{
```

```
skip-filters();
}
```

Envelope Sender in Group Rule

The `mail-from-group` rule selects those messages where the Envelope Sender is found to be in an LDAP group given on the right side of the operator (or, in the case of inequality, where the sender's email address is *not* in the given LDAP group). For example, the following filter immediately delivers any message sent by someone whose email address is in the LDAP group "KnownSenders."

```
SenderLDAPGroupFilter:
if (mail-from-group == 'KnownSenders')
{
skip-filters();
}
```

Sender Group Rule

The `sendergroup` message filter selects a message based on which sender group was matched in a listener's Host Access Table (HAT). This rule uses '=' (for matching) or '!=' (for not matching) to test for matching a given regular expression (the right side of the expression). For example, the following message filter rule evaluates to `true` if the sender group of the message matches the regular expression `Internal`, and, if so, sends the message to an alternate mail host.

```
senderGroupFilter:
if (sendergroup == "Internal")
{
alt-mailhost("[172.17.0.1]");
}
```

Body Size Rule

Body size refers to the size of the message, including both headers and attachments. The `body-size` rule selects those messages where the body size compares as directed to a given number. For example, the following filter bounces any message where the body size is greater than 5 megabytes.

```
BigFilter:
if (body-size > 5M)
{
bounce();
}
```

The `body-size` can be compared in the following ways:

Example	Comparison Type
<code>body-size < 10M</code>	Less than

Example	Comparison Type
<code>body-size <= 10M</code>	Less than or equal
<code>body-size > 10M</code>	Greater than
<code>body-size >= 10M</code>	Greater than or equal
<code>body-size == 10M</code>	Equal
<code>body-size != 10M</code>	Not equal

As a convenience, the size measurement may be specified with a suffix:

Quantity	Description
10b	ten bytes (same as 10)
13k	thirteen kilobytes
5M	five megabytes
40G	40 gigabytes (Note: The appliance cannot accept messages larger than 100 megabytes.)

Remote IP Rule

The `remote-ip` rule tests to see if the IP address of the host that sent that message matches a certain pattern. The IP address can be either Internet Protocol version 4 (IPv4) or Internet Protocol version 6 (IPv6). The IP address pattern is specified using the allowed hosts notation described in “Sender Group Syntax”, except for the `SBO`, `IPR`, `dnslist` notations and the special keyword `ALL`.

The allowed hosts notation can only identify sequences and numeric ranges of IP addresses (not hostnames). For example, the following filter bounces any message not injected from IP addresses of form `10.1.1.x` where `X` is `50`, `51`, `52`, `53`, `54`, or `55`.

```
notMineFilter:
if (remote-ip != '10.1.1.50-55')
{
bounce();
}
```

Receiving Listener Rule

The `recv-listener` rule selects those messages received on the named listener. The listener name must be the nickname of one of the listeners currently configured on the system. For example, the following filter immediately delivers any message arriving from the listener named `expedite`.

```

expediteFilter:

if (recv-listener == 'expedite')

{

skip-filters();

}

```

Receiving IP Interface Rule

The `recv-int` rule selects those messages received via the named interface. The interface name must be the nickname of one of the interfaces currently configured for the system. For example, the following filter bounces any message arriving from the interface named `outside`.

```

outsideFilter:

if (recv-int == 'outside')

{

bounce();

}

```

Date Rule

The `date` rule checks the current time and date against a time and date you specify. The date rule is compared against a string containing a timestamp of the format `MM/DD/YYYY hh:mm:ss`. This is useful to specify actions to be performed before or after certain times in US format. (Note that there may be an issue if you are searching messages with non-US date formats.) The following filter bounces all messages from `campaign1@yourdomain.com` that are injected after 1:00pm on July 28th, 2003:

```

TimeOutFilter:

if ((date > '07/28/2003 13:00:00') and (mail-from ==

'campaign1@yourdomain\\.com'))

{

bounce();

}

```



Note Do not confuse the `date` rule with the `$Date` message filter action variable.

Header Rule

The `header()` rule checks the message headers for a specific header, which must be specified quoted in parentheses (“*header name*”). This rule may be compared to a regular expression, much like the subject rule, or may be used without any comparison, in which case it will be “true” if the header is found in the message, and “false” if it is not found. For example, the following example checks to see if the header `x-sample` is found, and if its value contains the string “`sample text`”. If a match is made, the message is bounced.

```

FooHeaderFilter:
if (header('X-Sample') == 'sample text')
{
bounce();
}

```

You can specify non-ASCII characters to search for in the value of the header.

The following example demonstrates the header rule without a comparison. In this case, if the header X-DeleteMe is found, it is removed from the message.

```

DeleteMeHeaderFilter:
if header('X-DeleteMe')
{
strip-header('X-DeleteMe');
}

```

When working with headers, remember that the current value of the header includes changes made during processing (such as with filter actions that add, remove, or modify message headings). See [Message Header Rules and Evaluation, on page 135](#) for more information.

Random Rule

The `random` rule generates a random number from zero to N-1, where N is the integer value supplied in parenthesis after the rule. Like the `header()` rule, this rule may be used in a comparison, or may be used alone in a “unary” form. The rule evaluates to `true` in the unary form if the random number generated is non-zero. For example, both of the following filters are effectively equal, choosing Virtual Gateway address A half the time, and Virtual Gateway address B the other half of the time:

```

load_balance_a:
if (random(10) < 5)
{
alt-src-host('interface_a');
}
else
{
alt-src-host('interface_b');
}

load_balance_b:
if (random(2))
{
alt-src-host('interface_a');
}

```



```
else
{
alt-src-host('interface_b');
}
```

Recipient Count Rule

The `rcpt-count` rule compares the number of recipients of a message against an integer value, in a similar way to the `body-size` rule. This can be useful for preventing users from sending email to large numbers of recipients at once, or for ensuring that such large mailing campaigns go out over a certain Virtual Gateway address. The following example sends any email with more than 100 recipients over a specific Virtual Gateway address:

```
large_list_filter:
if (rcpt-count > 100) {
alt-src-host('mass_mailing_interface');
}
```

Address Count Rule

The `addr-count()` message filter rule takes one or more header strings, counts the number of recipients in each line and reports the cumulative number of recipients. This filter differs from the `rcpt-count` filter rule in that it operates on the message body headers instead of the envelope recipients. The following example shows the filter rule used to replace a long list of recipients with the alias, “undisclosed-recipients”:

```
large_list_filter:

if (rcpt-count > 100) {

alt-src-host('mass_mailing_interface');

}
```

Body Scanning Rule

The `body-contains()` rule scans the incoming email and all its attachments for a particular pattern defined by its parameter. This includes delivery-status parts and associated attachments. The `body-contains()` rule does not perform multi-line matching. The scanning logic can be modified on the Scan Behavior page or using the `scanconfig` command in the CLI to define which MIME types should or should not be scanned. You can also specify a minimum number of matches that the scanning engine must find in order for the scan to evaluate to true.

By default, the system scans all attachments *except* for those with a MIME type of `video/*`, `audio/*`, `image/*`. The system scans archive attachments — `.zip`, `.bzip`, `.compress`, `.tar`, or `.gzip` attachments containing multiple files. You can set the number of “nested” archived attachments to scan (for example, a `.zip` contained within a `.zip`).

For more information, see [Configuring Scan Behavior, on page 250](#).

Body Scanning

When AsyncOS performs body scanning, it scans the body text and attachments for the regular expression. You can assign a minimum threshold value for the expression, and if the scanning engine encounters the regular expression the minimum number of times, the expression evaluates to `true`.

AsyncOS evaluates the different MIME parts of the message, and it scans any MIME part that is textual. AsyncOS identifies the text parts if the MIME type specifies text in the first part. AsyncOS determines the encoding based on the encoding specified in the message, and it converts the text to Unicode. It then searches for the regular expression in Unicode space. If no encoding is specified in the message, AsyncOS uses the encoding you specify on the Scan Behavior page or using the `scanconfig` command.

For more information about how AsyncOS evaluates MIME parts when scanning messages, see [Message Bodies vs. Message Attachments, on page 135](#).

If the MIME part is not textual, AsyncOS extract files from a .zip or .tar archive or decompresses compressed files. After extracting the data, a scanning engine identifies the encoding for the file and returns the data from the file in Unicode. AsyncOS then searches for the regular expression in Unicode space.

The following example searches the body text and attachment for the phrase “Company Confidential.” The example specifies a minimum threshold of two instances, so if the scanning engine finds two or more instances of the phrase, it bounces any matching messages, and notifies the legal department of the attempt:

```
ConfidentialFilter:
if (body-contains('Company Confidential',2)) {
  notify ('legaldept@example.domain');
  bounce();
}
```

To scan only the body of the message, use `only-body-contains`:

```
disclaimer:
if (not only-body-contains('[dD]isclaimer',1) ) {
  notify('hresource@example.com');
}
```

Encryption Detection Rule

The `encrypted` rule examines the contents of a message for encrypted data. It does not attempt to decode the encrypted data, but merely examines the contents of the message for the existence of encrypted data. This can be useful for preventing users from sending encrypted email.



Note

The encrypted rule can only detect encrypted data in the content of messages. It does not detect encrypted attachments.

The encrypted rule is similar to the `true` rule in that it takes no parameters and cannot be compared. This rule returns `true` if encrypted data is found and `false` if no encrypted data is found. Because this function requires the message to be scanned, it uses the scanning settings you define on the Scan Behavior page or using the

`scanconfig` command. For more information about configuring these options, see [Configuring Scan Behavior, on page 250](#).

The following filter checks all email sent through the listener, and if a message contains encrypted data, the message is blind-carbon-copied to the legal department and then bounced:

```
prevent_encrypted_data:
if (encrypted) {
bcc ('legaldept@example.domain');
bounce();
}
```

Attachment Type Rule

The `attachment-type` rule checks the MIME types of each attachment in a message to see if it matches the given pattern. The pattern must be of the same form used in the Scan Behavior page or the `scanconfig` command, as described in [Configuring Scan Behavior, on page 250](#), and so may have either side of the slash (/) replaced by an asterisk as a wildcard. If the message contains an attachment that matches this specified MIME type, this rule returns “true.”

Because this function requires the message to be scanned, it obeys all of the options described in [Configuring Scan Behavior, on page 250](#).

See [Attachment Scanning, on page 217](#) for more information on message filter rules you can use to manipulate attachments to messages.

The following filter checks all email sent through the listener, and if a message contains an attachment with a MIME type of `video/*`, the message is bounced:

```
bounce_video_clips:
if (attachment-type == 'video/*') {
bounce();
}
```

Attachment Filename Rule

The `attachment-filename` rule checks the filenames of each attachment in a message to see if it matches the given regular expression. This comparison is case-sensitive. The comparison is, however sensitive to whitespace so if the filename has encoded whitespace at the end, the filter will skip the attachment. If one of the message’s attachments matches the filename, this rule returns “true.”

Please note the following points:

- Each attachment’s filename is captured from the MIME headers. The filename in the MIME header may contain trailing spaces.
- If an attachment is an archive, the appliance will harvest the filenames from inside the archive, and apply scan configuration rules (see [Configuring Scan Behavior, on page 250](#)) accordingly.
 - If the attachment is a single compressed file (despite the file extension), it is not considered an archive and the filename of the compressed file is not harvested. This means that the file is not

processed by the `attachment-filename` rule. An example of this type of file is an executable file (.exe) compressed with `gzip`.

- For attachments consisting of a single compressed file, such as `foo.exe.gz`, use regular expression to search for specific file types within compressed files. See [Attachment Filenames and Single Compressed Files within Archive Files, on page 166](#).

See [Attachment Scanning, on page 217](#) for more information on message filter rules you can use to manipulate attachments to messages.

The following filter checks all email sent through the listener, and if a message contains an attachment with a filename `*.mp3`, the message is bounced:

```
block_mp3s:

if (attachment-filename == '(?i)\\.mp3$') {

bounce();

}
```

Related Topics

- [Attachment Filenames and Single Compressed Files within Archive Files, on page 166](#)

Attachment Filenames and Single Compressed Files within Archive Files

This example shows how to match single compressed files in archives such as those created by `gzip`:

```
quarantine_gzipped_exe_or_pif:

if (attachment-filename == '(?i)\\. (exe|pif) ($|.gz$)') {

quarantine("Policy");

}
```

DNS List Rule

The `dnslist()` rule queries a public DNS List server that uses the DNSBL method (sometimes called “ip4r lookups”) of querying. The IP address of the incoming connection is reversed (so an IP of 1.2.3.4 becomes 4.3.2.1) and then added as a prefix to the server name in the parenthesis (a period to separate the two is added if the server name does not start with one). A DNS query is made, and the system is returned with either a DNS failure response (indicating the connection's IP address was not found in the server's list) or an IP address (indicating that the address was found). The IP address returned is *usually* of the form `127.0.0. x` where `x` can be almost any number from 0 to 255 (IP address ranges are not allowed). Some servers actually return different numbers based on the reason for the listing, while others return the same result for all matches.

Like the `header()` rule, `dnslist()` can be used in either a unary or binary comparison. By itself, it simply evaluates to `true` if a response is received and `false` if no response is received (for example, if the DNS server is unreachable).

The following filter immediately delivers a message if the sender has been bonded with the Cisco Bonded Sender information services program:

```
allowedlist_bondedsender:

if (dnslist('query.bondedsender.org')) {
```

```
skip-filters();
}
```

Optionally, you can compare the result to a string using the equality (`==`) or inequality (`!=`) expressions.

The following filter drops a message that results in a “127.0.0.2” response from the server. If the response is anything else, the rule returns “false” and the filter is ignored.

```
blockedlist:
if (dnslist('dnsbl.example.domain') == '127.0.0.2') {
drop();
}
```

IP Reputation Rule

The `reputation` rule checks the IP Reputation Score against another value. All the comparison operators are allowed, such as `>`, `==`, `<=`, and so forth. If the message does not have a IP Reputation Score at all (because one was never checked for it, or because the system failed to get a response from the IP Reputation Service query server), any comparison against a reputation fails (the number will not be greater than, less than, equal to, or not equal to any value). You can check for a IP Reputation score of “none” using the `no-reputation` rule described below. The following example adjusts the “Subject:” line of a message to be prefixed by “*** BadRep ***” if the reputation score returned from the IP Reputation Service is below a threshold of -7.5..

```
note_bad_reps:
if (reputation < -7.5) {
strip-header ('Subject');
insert-header ('Subject', '*** BadRep $Reputation *** $Subject');
}
```

For more information, see the “Sender Reputation Filtering” chapter. See also [Bypass Anti-Spam System Action, on page 211](#)

Values for the IP Reputation rule are -10 through 10, but the value `NONE` may also be returned. To check specifically for the value `NONE`, use the `no-reputation` rule.

```
none_rep:
if (no-reputation) {
strip-header ('Subject');
insert-header ('Subject', '*** Reputation = NONE *** $Subject');
}
```

Dictionary Rules

The `dictionary-match(< dictionary_name >)` rule evaluates to `true` if the message body contains any of the regular expressions or terms in the content dictionary named “*dictionary_name*.” If the dictionary does not exist, the rule evaluates to `false`. For more information on defining dictionaries (including their case sensitivity and word boundary settings), see the “Text Resources” chapter.

The following filter blind carbon copies the administrator when the Cisco scans a message that contains any words within the dictionary named “secret_words.”

```
copy_codenames:
if (dictionary-match ('secret_words')) {
bcc('administrator@example.com');
}
```

The following example sends the message to the Policy quarantine if the message body contains any words within the dictionary named “secret_words.” Unlike the `only-body-contains` condition, the `body-dictionary-match` condition does not require that all the content parts individually match the dictionary. The scores of each content part (taking into account multipart/alternative parts) are added together.

```
quarantine_data_loss_prevention:
if (body-dictionary-match ('secret_words'))
{
quarantine('Policy');
}
```

In the following filter, a subject that matches a term in the specified dictionary is quarantined:

```
quarantine_policy_subject:
if (subject-dictionary-match ('gTest'))
{
quarantine('Policy');
}
```

This example matches an email address in the “to” header and blind copies an administrator:

```
headerTest:
if (header-dictionary-match ('competitorsList', 'to'))
{
bcc('administrator@example.com');
}
```

The `attachment-dictionary-match(<dictionary_name>)` rule works like the `dictionary-match` rule above, except that it looks for matches in the attachment.

The following filter sends the message to the Policy quarantine if the message attachment contains any words found within the dictionary named “secret_words.”

```
quarantine_codenames_attachment:
if (attachment-dictionary-match ('secret_words'))
{
```

```
quarantine('Policy');
}
```

The `header-dictionary-match(<dictionary_name>, <header>)` rule works like the `dictionary-match` rule above, except that it looks for matches in the header specified in `<header>`. The header name is case insensitive, so, for example, “subject” and “Subject” both work.

The following filter sends the message to the Policy quarantine if the message’s “cc” header contains any words found within the dictionary named “ex_employees.”

```
quarantine_codenames_attachment:
if (header-dictionary-match ('ex_employees', 'cc'))
{
quarantine('Policy');
}
```

You can use wild cards within the dictionary terms. You do not have to escape the period in email addresses.

SPF-Status Rule

When you receive SPF/SIDF verified mail, you may want to take different actions depending on the results of the SPF/SIDF verification. The `spf-status` rule checks against different SPF verification results. For more information, see [Verification Results, on page 604](#).



Note If you have configured an SPF verification message filter rule without an SPF identity and if a message contains different SPF identities with different verdicts, the rule is triggered if one of the verdicts in the message matches the rule.

You can check against the SPF/SIDF verification results using the following syntax:

```
if (spf-status == "Pass")
```

If you want a single condition to check against multiple status verdicts, you can use the following syntax:

```
if (spf-status == "PermError, TempError")
```

You can also check the verification results against the HELO, MAIL FROM, and PRA identities using the following syntax:

```
if (spf-status("pra") == "Fail")
```

The following example shows the `spf-status` filter in use:

```
skip-spam-check-for-verified-senders:
if (sendergroup == "TRUSTED" and spf-status == "Pass"){
skip-spamcheck();
```

```

}

quarantine-spf-failed-mail:
if (spf-status("pra") == "Fail") {
if (spf-status("mailfrom") == "Fail"){
# completely malicious mail
quarantine("Policy");
} else {
if(spf-status("mailfrom") == "SoftFail") {
# malicious mail, but tempting
quarantine("Policy");
}
}
} else {
if(spf-status("pra") == "SoftFail"){
if (spf-status("mailfrom") == "Fail"
or spf-status("mailfrom") == "SoftFail"){
# malicious mail, but tempting
quarantine("Policy");
}
}
}

stamp-mail-with-spf-verification-error:
if (spf-status("pra") == "PermError, TempError"

or spf-status("mailfrom") == "PermError, TempError"
or spf-status("helo") == "PermError, TempError"){
# permanent error - stamp message subject
strip-header("Subject");
insert-header("Subject", "[POTENTIAL PHISHING] $Subject"); }
.

```

SPF-Passed Rule

The following example shows an `spf-passed` rule used to quarantine emails that are not marked as `spf-passed`:

```
quarantine-spf-unauthorized-mail:
if (not spf-passed) {
quarantine("Policy");
}
```



Note Unlike the `spf-status` rule, the `spf-passed` rule reduces the SPF/SIDF verification values to a simple Boolean. The following verification results are treated as not passed in the `spf-passed` rule: None, Neutral, Softfail, TempError, PermError, and Fail. To perform actions on messages based on more granular results, use the `spf-status` rule.

S/MIME Gateway Message Rule

The S/MIME Gateway Message rule checks if a message is S/MIME signed, encrypted, or signed and encrypted. The following message filter checks if the message is an S/MIME message and quarantines it if the verification or decryption using S/MIME fails.

```
quarantine_smime_messages:
if (smime-gateway-message and not smime-gateway-verified) {
quarantine("Policy");
}
```

For more information, see [S/MIME Security Services, on page 529](#).

S/MIME Gateway Verified Rule

The S/MIME Gateway Message Verified rule checks if a message is successfully verified, decrypted, or decrypted and verified. The following message filter checks if the message is an S/MIME message and quarantines it if the verification or decryption using S/MIME fails.

```
quarantine_smime_messages:
if (smime-gateway-message and not smime-gateway-verified) {
quarantine("Policy");
}
```

For more information, see [S/MIME Security Services, on page 529](#).

Workqueue-count Rule

The `workqueue-count` rule checks the workqueue-count against a specified value. All the comparison operators are allowed, such as `>`, `==`, `<=`, and so forth.

The following filter checks the workqueue count, and skips spam check if the queue is greater than the specified number.

```
wqfull:
if (workqueue-count > 1000) {
skip-spamcheck();
}
```

For more information on SPF/SIDF, see [Overview of SPF and SIDF Verification, on page 597](#).

SMTP Authenticated User Match Rule

If your appliance uses SMTP authentication to send messages, the `smtp-auth-id-matches (<target> [, <sieve-char>])` rule can check a message's headers and Envelope Sender against the sender's SMTP authenticated user ID to identify outgoing messages with spoofed headers. This filter allows the system to quarantine or block potentially spoofed messages.

The `smtp-auth-id-matches` rule compares the SMTP authenticated ID against the following targets:

Target	Description
*EnvelopeFrom	Compares the address of the Envelope Sender (also known as MAIL FROM) in the SMTP conversation
*FromAddress	Compares the addresses parsed out of the From header. Since multiple addresses are permitted in the From: header, only one has to match.
*Sender	Compares the address specified in the Sender header.
*Any	Matches messages that were created during an authenticated SMTP session regardless of identity.
*None	Matches messages that were not created during an authenticated SMTP session. This is useful when authentication is optional (preferred).

The filter performs matches loosely. It is not case-sensitive. If the optional *sieve-char* parameter is supplied, the last portion of an address that follows the specified character will be ignored for the purposes of comparison. For example, if the `+` character is included as a parameter, the filter ignores the portion of the address `joe+folder@example.com` that follows the `+` character. If the address was `joe+smith+folder@example.com`, only the `+folder` portion is ignored. If the SMTP authenticated user ID string is a simple username and not a fully-qualified e-mail address, only the username portion of the target will be examined to determine a match. The domain must be verified in a separate rule.

Also, you can use the `$$SMTPAuthID` variable to insert the SMTP authenticated user ID into headers.

The following table shows examples of comparisons between the SMTP authenticated ID and email addresses and whether they would match using the `smtp-auth-id-matches` filter rule:

SMTP Auth ID	Sieve Char	Comparison Address	Matches?
someuser		otheruser@example.com	No
someuser		someuser@example.com	Yes
someuser		someuser@another.com	Yes
SomeUser		someuser@example.com	Yes
someuser		someuser+folder@example.com	No
someuser	+	someuser+folder@example.com	Yes
someuser@example.com		someuser@forged.com	No

SMTP Auth ID	Sieve Char	Comparison Address	Matches?
someuser@example.com		someuser@example.com	Yes
SomeUser@example.com		someuser@example.com	Yes

The following filter checks all messages created during an authenticated SMTP session to verify that the addresses in the From header and the Envelope Sender match the SMTP authenticated user ID. If the addresses and the ID match, the filter verifies the domain. If they do not match, the appliance quarantines the message.

Msg_Authentication:

```

if (smtp-auth-id-matches("*Any"))
{
# Always include the original authentication credentials in a
# special header.
insert-header("X-Auth-ID", "$SMTPAuthID");
if (smtp-auth-id-matches("*FromAddress", "+") and
smtp-auth-id-matches("*EnvelopeFrom", "+"))
{
# Username matches. Verify the domain
if header('from') != "(?i)@(:example\\.com|alternate\\.com)" or
mail-from != "(?i)@(:example\\.com|alternate\\.com)"
{
# User has specified a domain which cannot be authenticated
quarantine("forged");
}
} else {
# User claims to be an completely different user
quarantine("forged");
}
}

```

Signed Rule

The signed rule checks messages for a signature. The rule returns a boolean value to indicate if the message is signed or not. This rule evaluates whether the signature is encoded according to ASN.1 DER encoding rules and that it conforms to the CMS SignedData Type structure (RFC 3852, Section 5.1.). It does not aim to validate whether the signature matches the content, nor does it check the validity of the certificate.

The following example shows a `signed` rule used to insert headers into a signed message:

```
signedcheck: if signed { insert-header("X-Signed", "True"); }
```

The following example shows a signed rule used to drop attachments from unsigned messages from a certain sender group:

```
Signed: if ((sendergroup == "NOTTRUSTED") AND NOT signed) {
  html-convert();
  if (attachment_size > 0)
  {
    drop_attachments("");
  }
}
```

Signed Certificate Rule

The signed-certificate rule selects those S/MIME messages where the X.509 certificate issuer or message signer matches the given regular expression. This rule only supports X.509 certificates.

The rule's syntax is signed-certificate (<field> [<operator> <regular expression>]), where:

- <field> is either the quoted string "issuer" or "signer" ,
- <operator> is either == or != ,
- and <regular expression> is the value for matching the "issuer" or "signer."

If the message is signed using multiple signatures, the rule returns true if any of the issuers or signers match the regular expression. The short form of this rule, signed-certificate("issuer") and signed-certificate("signer") , returns true if the S/MIME message contains an issuer or signer.

Related Topics

- [Signer, on page 174](#)
- [Issuer, on page 174](#)
- [Escaping in Regular Expressions, on page 175](#)
- [\\$CertificateSigners Action Variable, on page 175](#)
- [Examples 1, on page 176](#)

Signer

For message signers, the rule extracts the sequence of rfc822Name names from the X.509 certificate's subjectAltName extension. If there is no subjectAltName field in the signing certificate, or this field does not have any rfc822Name names, the signed-certificate("signer") rule evaluates to false. In the rare cases of multiple rfc822Name names, the rule tries to match all of the names to the regular expression and evaluates as true on the first match.

Issuer

The issuer is a non-empty distinguished name in the X.509 certificate. AsyncOS extracts the issuer from the certificate and converts it to an LDAP-UTF8 Unicode string. For example:

- C=US,S=CA,O=IronPort

- C=US,CN=Bob Smith

Since X.509 certificates require the issuer field, `signed-certificate("issuer")` evaluates whether the S/MIME message contains an X.509 certificate.

Escaping in Regular Expressions

LDAP-UTF8 defines a mechanism for escaping that you can use in your regular expressions. For a detailed discussion on escaping characters in LDAP-UTF8, consult Lightweight Directory Access Protocol (LDAP): String Representation of Distinguished Names, accessible from <http://www.ietf.org/rfc/rfc4514.txt>.

The escaping rules for the `signed-certificate` rule's regular expressions differ from the escaping rules defined in LDAP-UTF8 by limiting escaping to only the characters that require escaping. LDAP-UTF8 allows optional escaping for characters that can be represented without escaping. For example, the following two strings are considered correct for "Example, Inc." using the LDAP-UTF8 escaping rules:

- Example\, Inc.
- Example\, \ Inc\.

However, the `signed-certificate` rule only matches `Example\, Inc.` The regular expression does not allow escaping the space and period for matching because these characters do not require escaping, even though it is permitted in LDAP-UTF8. When creating a regular expression for the `signed-certificate` rule, do not escape a character if it can be represented without escaping.

\$CertificateSigners Action Variable

The action variable `$CertificateSigners` is a comma separated list of signers obtained from the `subjectAltName` element of the signing certificate. Multiple email addresses of a single signer will be included in the list with duplicates removed.

For example, Alice signs a message with her two certificates. Bob signs the message with his single certificate. All certificates are issued by a single corporate authority. After the message passes the S/MIME scan, the extracted data contain three items:

```
[
{
'issuer': 'CN=Auth,O=Example\, Inc.',
'signer': ['alice@example.com', 'al@private.example.com']}
},
{
'issuer': 'CN=Auth,O=Example\, Inc.',
'signer': ['alice@example.com', 'al@private.example.com']}
},
{
'issuer': 'CN=Auth,O=Example\, Inc.',
'signer': ['bob@example.com', 'bob@private.example.com']}
}
```

```
]
```

The `$CertificateSigners` variable expands to:

```
"alice@example.com, al@private.example.com, bob@example.com, bob@private.example.com"
```

Examples 1

The following example inserts a new header if the certificate issuer is from the US:

```
Issuer: if signed-certificate("issuer") == "(?i)C=US" {
insert-header("X-Test", "US issuer");
}
```

The following example notifies an administrator if the signer is not from example.com:

```
NotOurSigners: if signed-certificate("signer") AND
signed-certificate("signer") != "example\\.com$" {
notify("admin@example.com");
}
```

The following example adds a header if the message has an X.509 certificate:

```
AnyX509: if signed-certificate ("issuer") {
insert-header("X-Test", "X.509 present");
}
```

The following example adds a header if the message's certificate does not have a signer:

```
NoSigner: if not signed-certificate ("signer") {
insert-header("X-Test", "Old X.509?");
}
```

Header Repeats Rule

The Header Repeats rule evaluates to true if at a given point in time, a specified number of messages:

- With same subject are detected in the last one hour.
- From same envelope sender are detected in the last one hour.

You can use this rule to detect high volume emails. For example, political campaigns through certain websites may send out emails to organizations in high volumes. Anti-spam engines treat such emails as clean, and do not stop the delivery of these emails.

The syntax of this rule is `header-repeats (<target>, <threshold> [, <direction>])`, where:

- `<target>` is subject or mail-from . AsyncOS counts the repetition of values of the target.
- `<threshold>` is the number of messages with identical values for a given target, received in the last one hour, beyond which the rule evaluates to true.

- <direction> is incoming , outgoing , or both. If direction is not specified in this rule, incoming or outgoing messages are counted for rule evaluation.

Every time when a Header Repeats rule evaluates to true , a System Alert is sent. See [System Alerts, on page 1029](#).



Note If the header field includes comma or semi-colon separated values, the rule considers the complete string for tracking. This rule ignores messages with empty subject header.

The Header Repeats rule maintains a moving sum of messages with up to one minute's precision. As a result, after the set threshold has reached, there can be a delay of one minute before this rule is triggered.

Related Topics

- [Using Header Repeats Rule with Other Rules, on page 177](#)
- [Examples, on page 177](#)

Using Header Repeats Rule with Other Rules

You can use the Header Repeats rule with other rules using AND or OR operators. For example, you can categorize an allowed list for a subset of messages using the following filter:

```
f1: if (recv_listener == 'Gray') AND (header-repeats('subject', X, 'incoming') { drop();}
```

When you use a Header Repeats rule with another rule using AND or OR operators, the Header Repeats rule is evaluated last, and only if needed. If a Header Repeats rule is not evaluated for a given message, subject or mail-from is not counted to compare with the supplied threshold.

As Header Repeats rule is evaluated last and only if needed, the behavior of this rule may vary when used with other rules using an OR operator. The following sample filter uses an OR condition of Signed and Header Repeats rule.

```
f1: if signed OR (header-repeats('subject', 10)) { drop();}
```

In this example, if the first nine messages processed by this filter are signed messages with identical subject, the Header Repeats rule will not process these messages. If the tenth message is an unsigned message with identical subject header as the previous nine messages, the filter will not perform the configured action, even though the threshold has reached.

Examples

In the following example, at any given point in time, if the filter detects X or more incoming messages with identical subject in the last one hour, the subsequent messages with identical subject are sent to Policy quarantine.

```
f1 : if header-repeats('subject', X, 'incoming') { quarantine('Policy');}
```

In the following example, at any given point in time, if the filter detects X or more outgoing messages from same envelope sender in the last one hour, the subsequent messages from the same envelope sender are dropped and discarded.

```
f2 : if header-repeats('mail-from', X, 'outgoing') {drop();}
```

In the following example, at any given point in time, if the filter detects *X* or more incoming or outgoing messages with identical subject in the last one hour, the administrator is notified for every subsequent message with identical subject.

```
f3: if header-repeats('subject', X) {notify('admin@xyz.com');}
```

URL Reputation Rules

Use a URL reputation rule to define message actions based on the reputation score of any URL in the message. For important details, see [Filtering by URL Reputation or URL Category: Conditions and Rules](#), on page 433 in [Protecting Against Malicious or Undesirable URLs](#), on page 425

For these rules:

- `msg_filter_name`: is the name of this message filter.
- `allowedlist` is the name of a defined URL list (via the `urllistconfig` command.) Specifying an allowed list is optional.

To take action when the reputation service provides a score:

Use the `url-reputation` rule.

Filter syntax when using a `url-reputation` rule is:

```
<msg_filter_name>:
if url-reputation('<min_score>', '<max_score>', '<allowedlist>',
'<include_attachments>', '<include_message_body_subject>')
{<action>}
```

Where:

- `min_score` and `max_score` are the minimum and maximum scores in the range for which the action should apply. The values that you specify are included in the range.

Minimum and maximum scores must be between `-10.0` and `10.0`.

- `include_attachments` to scan for URLs in the message attachments. A value of '1' indicates that URL scanning for message attachments is enabled and a value of '0' indicates that URL scanning for message attachments is not enabled.
- `include_message_body_subject` to scan for URLs in the message body and subject. A value of '1' indicates that URL scanning for message body and subject is enabled and a value of '0' indicates that URL scanning for message body and subject is not enabled.

To take action when the reputation service does not provide a score:

Use the `url-no-reputation` rule.

Filter syntax when using a `url-no-reputation` rule is:

```
<msg_filter_name>:
```



```
if url_no_reputation('<allowedlist>',
'<include_attachments>', '<include_message_body_subject>')

{<action>}
```

URL Category Rule

Use URL categories to define message actions based on the category of URLs in the message. For important details, see [Filtering by URL Reputation or URL Category: Conditions and Rules](#), on page 433 in [Protecting Against Malicious or Undesirable URLs](#), on page 425.

Filter syntax when using a `url-category` rule is:

```
<msg_filter_name>: if url-category ([ '<category-name1>', '<category-name2>', ...,
'<category-name3>' ], '<url_allowed_list>', '<include_attachments>', '<include_message_body_subject>')
<action>
```

Where:

- `msg_filter_name` is the name of this message filter.
- `action` is any message filter action.
- `category-name` is the URL category. Separate multiple categories with commas. To obtain correct category names, look at a URL Category condition or action in a Content Filter. For descriptions and examples of the categories, see [About URL Categories](#), on page 443.
- `url_allowed_list` is the name of a defined URL list (via the `urllistconfig` command.)
- `include_attachments` to scan for URLs in message attachments. A value of '1' indicates that URL scanning for message attachments is enabled and a value of '0' indicates that URL scanning for message attachments is not enabled.
- `include_message_body_subject` to scan for URLs in the message body and subject. A value of '1' indicates that URL scanning for the message body and subject is enabled and a value of '0' indicates that URL scanning for the message body and subjects is not enabled.

Corrupt Attachment Rule

The Corrupt Attachment rule evaluates to true if a message contains corrupt attachment. A corrupt attachment is an attachment that the scanning engine cannot scan and identified as corrupt.

Related Topics

- [Example, on page 179](#)

Example

In the following example, if the filter detects a corrupt attachment in a message, the message is quarantined to Policy Quarantine.

```
quar_corrupt_attach: if (attachment-corrupt) { quarantine("Policy"); }
```

Message Language Rule

You may want to take different message actions based on the message language. For example, you may want to:

- Add a disclaimer in Russian to the messages that are in Russian

- Drop the messages whose language could not be determined

Use the message-language rule to take message actions depending on the language of the message subject and body.



Note This rule will not check for the language in attachments and headers.

How Does Language Detection Work

The appliance uses the built-in language detection engine to detect the language in a message. The appliance extracts the subject and the message body and passes it to the language detection engine.

The language detection engine determines the probability of each language in the extracted text and passes it back to the appliance. The appliance considers the language with the highest probability as the language of the message. The appliance considers the language of the message as 'undetermined' in one of the following scenarios:

- If the detected language is not supported by the appliance
- If the appliance is unable to detect the language of the message
- If the total size of the extracted text sent to the language detection engine is less than 50 bytes.

Message Filter Syntax

```
<msg_filter_name>: if (message-language <operator> "<language1>, <language2>,..., <language n>") {<action>}
```

Where:

- `msg_filter_name` is the name of this message filter.
- `operator` is `==` or `!=`.
- `language` is the value of message language that you want to specify in this message filter. Separate multiple entries with commas. For a list of supported message languages and values, look at the Message Language condition in a content filter. Values are enclosed with brackets ([and]).
- `action` is any message filter action.

Examples

The following example shows how to drop the messages whose language could not be determined:

```
DropMessagesWithUndeterminedLanguage: if (message-language == "unknown") { drop(); }
```

The following example shows how to add a disclaimer in Russian to the messages in Russian:

```
ussianDisclaimerRule: if (message-language == "ru") { add-heading("RussianDisclaimer"); }
```

Macro Detection Rule

You can use the Macro Detection rule to detect macro-enabled attachments in messages for the specified file types.



Note If an archive or embedded file contains macros, the parent file is dropped from the message.

Macro Detection Syntax

```
<msg_filter_name>: if (macro-detection-rule (['file_type-1', 'file_type-2',...
,'file_type-n'])) {<action>}
```

Where:

- `msg_filter_name` is the name of this message filter.
- `file_type` can be any one of the following supported file types:
 - Adobe Portable Document Format
 - Microsoft Office Files
 - OLE File types
- `action` is any message filter action.

Examples

The following example shows how to drop a message that contains a macro-enabled Microsoft Office attachment:

```
Drop_Messages_With_Macro-enabled_Office_Files: if (macro-detection-rule (['Microsoft Office
Files'])) { drop(); }
```

In the following example, if a message containing a macro-enabled attachment in a PDF format is sent to a specific user, the message is dropped:

```
Strip_Macro_enabled_PDF: if (rcpt-to == "joe@example.com") {
drop-macro-enabled-attachments(['Adobe Portable Document Format']); }
```

Forged Email Detection Rule

You may want to detect fraudulent messages with forged sender address (From: header) and perform actions on such messages.

Use the forged-email-detection rule to detect such messages. While configuring this rule, you must specify a content dictionary and the threshold value (1 through 100) for considering a message as potentially forged.

The forged-email-detection rule compares the From: header with the users in the content dictionary. During this process, depending on the similarity, the appliance assigns similarity score to each of the users in the dictionary. The following are some examples:

- If the From: header is <john.sim0ns@example.com> and the content dictionary contains a user 'John Simons,' the appliance assigns a similarity score of 82 to the user.
- If the From: header is <john.simons@diff-example.com> and the content dictionary contains a user 'John Simons,' the appliance assigns a similarity score of 100 to the user.

The higher the similarity score, the higher the probability that the message is forged. If the similarity score is greater than or equal to the specified threshold value, the filter action is triggered.

For more information, see [Forged Email Detection, on page 616](#).

Message Filter Syntax

```
<filter_name>: if (forged-email-detection("<content_dictionary>", threshold)) {<action>;}
```

Where:

- filter_name is the name of the message filter
- content_dictionary is the name of content dictionary
- threshold is the threshold value (1 through 100) for considering a message as potentially forged

Example

The following message filter compares the From: header in the message with the terms in dictionary and if the similarity score of a user in the content dictionary is greater than or equal to 70, the message filter strips the From: header and replaces it with the Envelope Sender.

```
FED_CF: if (forged-email-detection("Execs", 70)) { fed("from", ""); }
```

Duplicate Boundaries Verification Rule

You can use the duplicate_boundaries rule to detect messages that contain duplicate MIME boundaries.



Note Attachment-based rules (for example, attachment-contains) or actions (for example, drop-attachments-where-contains) will not work on malformed messages (with duplicate MIME boundaries).

Message Filter Syntax

```
<filter_name>: if (duplicate_boundaries){<action>;}
```

Example

The following message filter will quarantine all the messages that contain duplicate MIME boundaries.

```
DuplicateBoundaries: if (duplicate_boundaries) { quarantine("Policy"); }
```

Malformed MIME Header Detection Rule

You can use the malformed-header rule to detect messages that contain malformed MIME headers.

Message Filter Syntax

```
<filter_name>: if (malformed-header){<action>;}
```

Example

The following example shows how to quarantine all the messages with malformed MIME headers:

```
quarantine_malformed_headers: if (malformed-header)
{
  quarantine("Policy");
}
```

Geolocation Rule

You can use the Geolocation rule to handle incoming messages from particular countries that you select.

Geolocation Syntax

```
<msg_filter_name>: if (geolocation-rule (['country_name-1', 'country_name-2', ...
,'country_name-n'])) {<action>}
```

Where:

- `msg_filter_name` is the name of this message filter.
- `country_name` can be name of any country that you select.
- `action` is any message filter action.

Example

The following example shows how to quarantine an incoming message from Country1 and Country2:

```
Quarantine_Incoming_Messages_from_Country1_and_Country2: if (geolocation-rule
(['Country1', 'Country2'])) {quarantine("Policy");}
```

Domain Reputation Rule for ETF

As an example, use the following message filter rule syntax to detect malicious domains in messages using the ETF engine, and take appropriate actions on such messages.

Syntax:

```
quarantine_msg_based_on ETF: if (domain-external-threat-feeds (['etf_source1'],
['mail-from', 'from'], <'domain_exception_list'>)) { quarantine("Policy"); }
```

Where

- `'domain-external-threat-feeds'` is the Domain reputation message filter rule.
- `'etf_source1'` is the ETF source(s) used to detect malicious domain(s) in the header(s) of a message.
- `'mail-from', 'from'` are the required header(s) used to check for the reputation of the domain.
- `'domain_exception_list'` is the name of a domain exception list. If a domain exception list is not present it is displayed as "".

Example

In the following example, if the domain in the 'Errors To:' custom header is detected as malicious by the ETF engine, the message is quarantined.

```
Quarantining_Messages_with_Malicious_Domains: if domain-external-threat-feeds
(['threat_feed_source'], ['Errors-To'], "") {quarantine("Policy");}
```

Domain Reputation Rule for SDR

You can use the Domain Reputation rule to filter messages based on SDR, and take appropriate actions on such messages:

- Sender Domain Verdict
- Sender Domain Age

- Sender Domain Unscannable

Filtering Messages based on Sender Domain Verdict



Note The recommended blocking threshold is "Poor." For more information about SDR, contact Cisco Talos at <https://www.talosintelligence.com>.

Syntax:

```
drop_msg_based_on_sdr_verdict:
if sdr-reputation (['awful', 'poor'], "<domain_exception_list>")
{drop();}
```

Where:

- 'drop_msg_based_on_sdr_verdict' is the name of the message filter.
- 'sdr-reputation' is the Domain Reputation message filter rule.
- 'awful', 'poor' is the range of the sender domain verdict used to filter messages based on SDR.
- 'domain_exception_list' is the name of a domain exception list. If a domain exception list is not present it is displayed as "".
- 'drop' is the action applied on the message.

Example

In the following message, if the SDR verdict is 'Unknownr', the message is quarantined.

```
quarantine_unknown_sdr_verdicts:
if sdr-reputation (['unknown'], "")
{quarantine("Policy")}
```

Filtering Messages based on Sender Domain Age

Syntax:

```
<msg_filter_name>
if sdr-age (<'unit'>, <'operator'> <'actual value'>)
{<action>}
```

Where:

- 'sdr-reputation' is the Domain Reputation message filter rule.
- 'sdr_age' is the age of the sender domain used to filter messages based on SDR.
- 'unit' is the number of 'days,' 'years,' 'months,' or 'weeks' option used to filter messages based on the sender domain age.
- 'operator' are the following comparison operators used to filter messages based on the sender domain age:
 - -> (Greater than)
 - ->= (Greater than or equal to)
 - -< (Lesser than)

- – <= (Lesser than or equal to)
 - – == (Equal to)
 - – != (Not equal to)
 - – Unknown
- 'actual value' is the number used to filter messages based on the sender domain age.

Examples

In the following message, if the age of the sender domain is unknown, the message is dropped.

```
Drop_Messages_Based_On_SDR_Age: if (sdr-age ("unknown", "")) {drop();}
```

In the following message, if the age of the sender domain is less than one month, the message is dropped.

```
Drop_Messages_Based_On_SDR_Age: if (sdr-age ("months", <, 1, "")) { drop(); }
```

Filtering Messages based on Sender Domain Unscannable

Syntax:

```
<msg_filter_name>
if sdr-unsannable (<'domain_exception_list'>)
{<action>}
```

Where:

- 'sdr-unsannable' is the Domain Reputation message filter rule.
- 'domain_exception_list' is the name of a domain exception list. If a domain exception list is not present it is displayed as "".

Example

In the following message, if the message failed the SDR check, the message is quarantined.

```
Quarantine_Messages_Based_On_Sender_Domain_Unscannable: if (sdr-unsannable (""))
{quarantine("Policy");}
```

Message Filter Actions

The purpose of message filters is to perform actions on selected messages.

The two types of actions are:

- *Final* actions — such as deliver , drop , and bounce — end the processing of a message, and permit no further processing through subsequent filters.
- *Non-final* actions perform an action which permits the message to be processed further.



Note Non-final message filter actions are cumulative. If a message matches multiple filters where each filter specifies a different action, then all actions are accumulated and enforced. However, if a message matches multiple filters specifying the same action, the prior actions are overridden and the final filter action is enforced.

Related Topics

- [Filter Actions Summary Table](#), on page 186
- [Action Variables](#), on page 195
- [Matched Content Visibility](#), on page 197
- [Description and Examples of Message Filter Actions](#), on page 198

Filter Actions Summary Table

Message filters can apply the following actions to an email message as shown in the following table:

Table 24: Message Filter Actions

Action	Syntax	Description
Alter source host	alt-src-host	Change the source hostname and IP interface (Virtual Gateway address) to send the message. See Alter Source Host (Virtual Gateway address) Action , on page 207.
Alter recipient	alt-rcpt-to	Change a recipient of the message. See Alter Recipient Action , on page 206.
Alter mailhost	alt-mailhost	Change the destination mail host for the message. See Alter Delivery Host Action , on page 206.
Notify	notify	Report this message to another recipient. See Notify and Notify-Copy Actions , on page 201.
Notify Copy	notify-copy	Perform just like the notify action, but also sends a copy as with the bcc-scan action. See Notify and Notify-Copy Actions , on page 201.
Blind carbon copy	bcc	Copy this message (message replication) anonymously to another recipient. See Blind Carbon Copy Actions , on page 203.
Blind carbon copy with scan	bcc-scan	Copy this message anonymously to another recipient, and process that message through the work queue as if it were a new message. See Blind Carbon Copy Actions , on page 203.
Archive	archive	Archive this message into an mbox-format file. See Archive Action , on page 207.
Quarantine	quarantine (<i>quarantine_name</i>)	Flag this message to be sent to the quarantine named <i>quarantine_name</i> . See Quarantine and Duplicate Actions , on page 205.

Action	Syntax	Description
Duplicate (Quarantine)	<code>duplicate-quarantine</code> (<i>quarantine_name</i>)	Send a copy of the message to the specified quarantine. See Quarantine and Duplicate Actions , on page 205.
Remove headers	<code>strip-header</code>	Remove specified headers from the message before delivering. See Strip Header Action , on page 208.
Insert headers	<code>insert-header</code>	Insert a header and value pair into the message before delivering. See Insert Header Action , on page 208.
Edit header text	<code>edit-header-text</code>	Replace specified header text with a text string you specify in the filter condition. See Edit Header Text Action , on page 209.
Edit body text	<code>edit-body-text()</code>	Strip a regular expression from a message body and replaces it with text that you specify. You might want to use this filter if you want to remove and replace specific content, such as a URL within a message body. See Edit Body Text Action , on page 209.
Convert HTML	<code>html-convert()</code>	Strip HTML tags from message bodies and leaves the plain text content of the message. You might want to use this filter if you want to convert all HTML text in a message to plain text. HTML Convert Action , on page 210.
Assign bounce profile	<code>bounce-profile</code>	Assign a specific bounce profile to the message. See Bounce Profile Action , on page 211.
Bypass Anti-Spam System	<code>skip-spamcheck</code>	Ensure that the anti-spam systems in the Cisco system are <i>not</i> applied to this message. See Bypass Anti-Spam System Action , on page 211.
Bypass Graymail Actions	<code>skip-marketingcheck</code>	Bypass actions on marketing emails. See Bypassing Graymail Actions , on page 212.
	<code>skip-socialcheck</code>	Bypass actions on social network emails. See Bypassing Graymail Actions , on page 212.
	<code>skip-bulkcheck</code>	Bypass actions on bulk emails. See Bypassing Graymail Actions , on page 212.

Filter Actions Summary Table

Action	Syntax	Description
Bypass Anti-Virus System	<code>skip-viruscheck</code>	Ensure that the anti-virus systems in the Cisco system are <i>not</i> applied to this message. See Bypass Anti-Virus System Action , on page 212.
Bypass File Reputation Filtering and File Analysis	<code>skip-ampcheck</code>	Ensure that File Reputation Filtering and File Analysis are <i>not</i> applied to this message. See Bypass File Reputation Filtering and File Analysis System Actions , on page 213.
Skip Outbreak Filter Scanning	<code>skip-vofcheck</code>	Ensure that this message is not processed by the Outbreak Filters scanning. See Bypass Anti-Virus System Action , on page 212.
Drop Attachments by Name	<code>drop-attachments-by-name</code>	Drop all attachments on messages that have a filename that match the given regular expression. Archive file attachments (zip, tar), Microsoft Office attachments (doc, docx), and Email attachments (winmail.dat) will be dropped if they contain a file that matches. See Examples of Attachment Scanning Message Filters , on page 224.
Drop Attachments by Type	<code>drop-attachments-by-type</code>	Drop all attachments on messages that have a MIME type, determined by either the given MIME type or the file extension. Archive file attachments (zip, tar) will be dropped if they contain a file that matches. See Examples of Attachment Scanning Message Filters , on page 224.
Drop Attachments by File Type	<code>drop-attachments-by-filetype</code>	Drop all attachments on messages that match the given “fingerprint” of the file. Archive file attachments (zip, tar) will be dropped if they contain a file that matches. For more information, see Examples of Attachment Scanning Message Filters , on page 224.
Drop Attachments by MIME Type	<code>drop-attachments-by-mimetype</code>	Drop all attachments on messages that have a given MIME type. This action does not attempt to ascertain the MIME type by file extension and so it also does not examine the contents of archives. See Examples of Attachment Scanning Message Filters , on page 224.

Action	Syntax	Description
Drop Attachments by Size	<code>drop-attachments-by-size</code>	Drop all attachments on the message that, in raw encoded form, are equal to or greater than the size (in bytes) given. Note that for archive or compressed files, this action does not examine the uncompressed size, but rather the size of the actual attachment prior to any decoding. See Examples of Attachment Scanning Message Filters, on page 224 .
Drop Attachments by Content	<code>drop-attachments-where-contains</code>	Drop all attachments on message that contain the regular expression. Does the pattern occur the minimum number of times you specified for the threshold value? Archive files (zip, tar) will be dropped if any of the files they contain match the regular expression pattern. See Examples of Attachment Scanning Message Filters, on page 224 . The optional comment serves as the means to modify the text used to replace the attachment that was dropped. Attachment footers simply append to the message.

Action	Syntax	Description
Drop Attachments with Macro	drop-macro-enabled-attachments	<p>Drops all macro-enabled attachments of the specified file type.</p> <p>Note If an archive or embedded file contains macros, the parent file is dropped from the message.</p> <p>Syntax</p> <pre>drop-macro-enabled-attachments (['file_type-1', 'file_type-2', ..., 'file_type-n'], "custom_replacement_message")</pre> <p>Where:</p> <ul style="list-style-type: none"> • <code>file_type</code> can be any one of the following supported file types: <ul style="list-style-type: none"> • Adobe Portable Document Format • Microsoft Office Files • OLE File types • custom replacement message is an optional message to replace the default system generated message added to the bottom of the message body when an attachment is dropped. <p>See Macro Detection Rule, on page 180</p>
Drop Attachments by Dictionary Matches	drop-attachments-where-dictionary-match	Strip attachments based on matches to dictionary terms. If the terms in the MIME parts considered to be an attachment match a dictionary term (and the user-defined threshold is met), the attachment is stripped from the email. See Examples of Attachment Scanning Message Filters , on page 224.
Add Footer	add-footer (<i>footer-name</i>)	Add disclaimer text as a footer to the message. See “Message Disclaimer Stamping” in the “Text Resources” chapter for more information.
Add Heading	add-heading (<i>heading-name</i>)	Add disclaimer text as a heading to the message. See “Message Disclaimer Stamping” in the “Text Resources” chapter for more information.

Action	Syntax	Description
Encrypt on Delivery	<code>encrypt-deferred</code>	Encrypt message on delivery, which means that the message continues to the next stage of processing, and when all processing is complete, the message is encrypted and delivered.
S/MIME Sign/Encrypt on Delivery	<code>smime-gateway-deferred ("sending_profile")</code>	Performs an S/MIME signing or encryption of the message using the specified sending profile during the delivery. See S/MIME Sign or Encrypt on Delivery Action, on page 200 .
S/MIME Sign/Encrypt	<code>smime-gateway ("sending_profile")</code>	Performs an S/MIME signing or encryption using the specified sending profile and delivers the message, skipping any further processing. See S/MIME Sign or Encrypt Action, on page 200 .
Add Message Tag	<code>tag-message (tag-name)</code>	Add a custom term into the message to use with DLP policy filtering. You can configure a DLP policy to limit scanning to messages with the message tag. The message tag is not visible to recipients. See Add Message Tag Action, on page 213 and the “Data Loss Prevention” chapter.
Add Log Entry	<code>log-entry</code>	Adds customized text into the Text Mail logs at the INFO level. The text can include action variables. The log entry appears in message tracking. See Add Log Entry Action, on page 214 .
Replace URL with text, based on URL reputation	<ul style="list-style-type: none"> <code>url-reputation-replace</code> <code>url-no-reputation-replace</code> 	Modify URLs or their behavior based on the reputation of the URL.
Defang URL based on URL reputation	<ul style="list-style-type: none"> <code>url-reputation-defang</code> <code>url-no-reputation-defang</code> 	Use a separate action to handle the case in which the reputation service does not provide a score for a URL.
Redirect URL to a Cisco security proxy, based on URL reputation	<ul style="list-style-type: none"> <code>url-reputation-proxy-redirect</code> <code>url-no-reputation-proxy-redirect</code> 	See URL Reputation Actions , on page 214 .

Action	Syntax	Description
Replace URL with text, based on URL Category	<code>url-category-replace</code>	Modify URLs or their behavior based on the category of the URL. See URL Category Actions , on page 216.
Defang URL based on URL category	<code>url-category-defang</code>	
Redirect URL to Cisco security proxy, based on URL category	<code>url-category-proxy-redirect</code>	
Forged Email Detection	<code>fed</code>	Strips the From: header from the forged message and replaces it with the Envelope Sender. See Forged Email Detection Action , on page 217.
No Operation	<code>no-op</code>	No action is performed. See No Operation , on page 217.
*Skip Remaining Message Filters	<code>skip-filters</code>	Ensure that this message is not processed by any other message filters and continues through the email pipeline. See Skip Remaining Message Filters Action , on page 199.
*Drop message	<code>drop</code>	Drop and discard the message. See Drop Action , on page 199.
*Bounce message	<code>bounce</code>	Send the message back to the sender. See Bounce Action , on page 200.
*Encrypt and Deliver Now	<code>encrypt</code>	Use Cisco Email Encryption to encrypt outgoing messages. See Encrypt Action , on page 200.
* <i>Final Actions</i>		

Related Topics

- [Attachment Groups](#), on page 192

Attachment Groups

You can specify a particular file type (“exe” files for example) or common groups of attachments in the `attachment-filetype` and `drop-attachments-by-filetype` rules . AsyncOS divides the attachments into the groups listed in the following table.

If you create a message filter that uses the `!=` operator to match a message that does not contain an attachment with a specific file type, the filter will not perform any action on the message if there is at least one attachment with the file type you want to filter out. For example, the following filter drops any message with an attachment that is not an `.exe` file type:

```
exe_check: if (attachment-filetype != "exe") {
drop();
}
```

If a message has multiple attachments, the appliance does not drop the message if at least one of the attachments is an .exe file, even if the other attachments not .exe files.

Table 25: Attachment Groups

Attachment Group Name	Scanned File Types
Document	<ul style="list-style-type: none"> • doc • docx • mdb • mpp • ole • pdf • ppt • pptx • rtf • wps • x-wmf • xls • xlsx
Executable	<ul style="list-style-type: none"> • exe • java • msi • pif <p>Note Filtering the Executable group will also scan .dll and .scr files, but you cannot filter these file types individually.</p>

Attachment Group Name	Scanned File Types
Compressed	<ul style="list-style-type: none"> • ace (ACE Archiver compressed file) • arc (SQUASH Compressed archive) • arj (Robert Jung ARJ compressed archive) • binhex • bz (Bzip compressed file) • bz2 (Bzip compressed file) • cab (Microsoft cabinet file) • gzip* (Compressed file - UNIX gzip) • lha (Compressed Archive [LHA/LHARC/LZH]) • rar (Compressed archive) • sit (Compressed archive - Macintosh file [Stuffit]) • tar* (Compressed archive) • unix (UNIX compress file) • zip* (Compressed archive - Windows) • zoo (ZOO Compressed Archive File) <p>* These file types can be “body-scanned”</p>
Text	<ul style="list-style-type: none"> • txt • html • xml
Image	<ul style="list-style-type: none"> • bmp • cur • gif • ico • jpeg • pcx • png • psd • psp • tga • tiff

Attachment Group Name	Scanned File Types
Media	<ul style="list-style-type: none"> • aac • aiff • asf • avi • flash • midi • mov • mp3 • mpeg • ogg • ram • snd • wav • wma • wmv

Action Variables

The `bcc()`, `bcc-scan()`, `notify()`, `notify-copy()`, `add-footer()`, `add-heading()`, and `insert-headers()` actions have parameters that may use certain variables that will be automatically replaced with information from the original message when the action is executed. These special variables are called *action variables*. Your appliance supports the following set of action variables:

Table 26: Message Filter Action Variables

Variable	Syntax	Description
All Headers	<code>\$AllHeaders</code>	Returns the message headers.
Body Size	<code>\$BodySize</code>	Returns the size, in bytes, of the message.
Certificate Signers	<code>\$CertificateSigners</code>	Returns the signers from the <code>subjectAltName</code> element of a signing certificate. See \$CertificateSigners Action Variable, on page 175 for more information.
Date	<code>\$Date</code>	Returns the current date, using the format <code>MM/DD/YYYY</code> .
Dropped File Name	<code>\$dropped_filename</code>	Returns only the most recently dropped filename.
Dropped File Names	<code>\$dropped_filenames</code>	Displays list of dropped files (similar to <code>\$filenames</code>).
Dropped File Types	<code>\$dropped_filetypes</code>	Displays list of dropped file types (similar to <code>\$filetypes</code>).
Envelope Sender	<code>\$EnvelopeFrom</code>	Returns the Envelope Sender (Envelope From, <code><MAIL FROM></code>) of the message.

Variable	Syntax	Description
Envelope Recipients	<code>\$EnvelopeRecipients</code>	Returns all Envelope Recipients (Envelope To, <RCPT TO>) of the message.
File Names	<code>\$filenames</code>	Returns a comma-separated list of the message's attachments' filenames.
File Sizes	<code>\$filesizes</code>	Returns a comma-separated list of the message's attachments' file sizes.
File Types	<code>\$filetypes</code>	Returns a comma-separated list of the message's attachments' file types.
Filter Name	<code>\$FilterName</code>	Returns the name of the filter being processed.
GMTTimeStamp	<code>\$GMTTimeStamp</code>	Returns the current time and date, as would be found in the Received: line of an email message, using GMT.
HAT Group Name	<code>\$Group</code>	Returns the name of the sender group the sender matched on when injecting the message. If the sender group had no name, the string ">Unknown<" is inserted.
Matched Content	<code>\$MatchedContent</code>	Returns the content that triggered a scanning filter rule (including filter rules such as body-contains and content dictionaries).
Mail Flow Policy	<code>\$Policy</code>	Returns the name of the HAT policy applied to the sender when injecting the message. If no predefined policy name was used, the string ">Unknown<" is inserted.
Header	<code>\$Header['string']</code>	Returns the value of the quoted header, if the original message contains a matching header. Note that double quotes may also be used.
Hostname	<code>\$Hostname</code>	Returns the hostname of the appliance .
Internal Message ID	<code>\$MID</code>	Returns the Message ID, or "MID" used internally to identify the message. Not to be confused with the RFC822 "Message-Id" value (use \$Header to retrieve that).
Receiving Listener	<code>\$RecvListener</code>	Replaced by the nickname of the listener that received the message.
Receiving Interface	<code>\$RecvInt</code>	Returns the nickname of the interface that received the message.
Remote IP Address	<code>\$RemoteIP</code>	Returns the IP address of the system that sent the message to the appliance.
Remote Host Address	<code>\$remotehost</code>	Returns the hostname of the system that sent the message to the appliance.

Variable	Syntax	Description
IP Reputation Score	<code>\$Reputation</code>	Returns the IP Reputation score of the sender. If there is no reputation score, it is replaced with “None”.
Subject	<code>\$Subject</code>	Returns the subject of the message.
Time	<code>\$Time</code>	Returns the current time, in the local time zone.
Timestamp	<code>\$Timestamp</code>	Returns the current time and date, as would be found in the Received: line of an email message, in the local time zone.

Related Topics

- [Non-ASCII Character Sets and Message Filter Action Variables, on page 197](#)

Non-ASCII Character Sets and Message Filter Action Variables

The system supports the expansion of action variables that contain ISO-2022 style character codings (the style of encoding used in header values) and also supports international text in the notification. These will be merged together to generate a notification that will then be sent as a UTF-8, quoted printable message.

Matched Content Visibility

When you configure a quarantine action for messages that match Attachment Content conditions, Message Body or Attachment conditions, Message body conditions, or the Attachment content conditions, you can view the matched content in the quarantined message. When you display the message body, the matched content is highlighted in yellow. You can also use the `$MatchedContent` action variable to include the matched content in the message subject.

When you view messages in the local quarantine that have triggered message or content filter rules, the GUI may display content that did not actually trigger the filter action (along with content that triggered the filter action). The GUI display should be used as a guideline for locating content matches, but does not necessarily reflect an exact list of content matches. This occurs because the GUI uses less strict content matching logic than is used in the filters. This issue applies only to the highlighting in the message body. The table that lists the matched strings in each part of the message along with the associated filter rule is correct.

Figure 17: Matched Content Viewed in the Policy Quarantine

Attachment Name	Matched Content	Condition
FP1.1.txt	<ul style="list-style-type: none"> MS 38930 USA Facilities 662-646-0523 jsamuelson@acmecorp.com 7/17/06 4929132070312710 Acme Corp Irene Gibbs 808 Sumner Street Greenwood MS 38930 USA Publishing 662-646-0522 igibbs@acmecorp.com 2/1/07 4485231592071860 Acme Corp Kathy Lopez 808 Sumner Street Greenwood MS 38930 USA Marketing 662-646-0541 klopez@acmecorp.com 2/1/07 4716298862510192 Acme Corp Marty Smith 808 Sumner Street Greenwood MS 38930 USA Engineering 662-646-0542 	DLP Classifier: Contact Information

Headers

```
X-IronPort-AV: E=Sophos;i="4,43,282,1246818600";
d="txt?scan208";a="178202"
Received: from d2.vmw023-bsd04.ibqa (HELO vmw023-bsd04.ibqa) ([172.22.107.1])
by c360q02.ibqa with ESMTMP; 28 Jul 2009 16:25:03 +0530
Message-ID: <792087.518002035-sendEmail@vmw023-bsd04>
From: "user@test.com" <user@test.com>
To: "user1@test.com" <user1@test.com>
Subject: DLPTEST
Date: Tue, 28 Jul 2009 08:42:11 +0000
X-Mailer: sendEmail-1.55
MIME-Version: 1.0
Content-Type: multipart/mixed; boundary="----MIME delimiter for sendEmail-538525.714612664"
```

Message

Test

Name	Size	Details
[message body]	6	ASCII text, with CRLF line terminators
FP1.1.txt	1K	ASCII text

Description and Examples of Message Filter Actions

The following section describes the various message filter actions in use and their examples.

- [Skip Remaining Message Filters Action, on page 199](#)
- [Drop Action, on page 199](#)
- [Bounce Action, on page 200](#)
- [Encrypt Action, on page 200](#)
- [Notify and Notify-Copy Actions, on page 201](#)
- [Blind Carbon Copy Actions, on page 203](#)
- [Quarantine and Duplicate Actions, on page 205](#)
- [Alter Recipient Action, on page 206](#)
- [Alter Delivery Host Action, on page 206](#)
- [Alter Source Host \(Virtual Gateway address\) Action, on page 207](#)
- [Archive Action, on page 207](#)
- [Strip Header Action, on page 208](#)
- [Insert Header Action, on page 208](#)
- [Edit Header Text Action, on page 209](#)
- [Edit Body Text Action, on page 209](#)
- [HTML Convert Action, on page 210](#)
- [Bounce Profile Action, on page 211](#)

- [Bypass Anti-Spam System Action](#), on page 211
- [Bypassing Graymail Actions](#), on page 212
- [Bypass Anti-Virus System Action](#), on page 212
- [Bypass File Reputation Filtering and File Analysis System Actions](#), on page 213
- [Bypass Anti-Virus System Action](#), on page 212
- [Add Message Tag Action](#), on page 213
- [Add Log Entry Action](#), on page 214
- [URL Reputation Actions](#) , on page 214
- [URL Category Actions](#) , on page 216
- [No Operation](#), on page 217
- [Forged Email Detection Action](#), on page 217

Skip Remaining Message Filters Action

The `skip-filters` action ensures that the message skips any further processing from message filters and continues through the email pipeline. The message that incurs the `skip-filters` action will be subject to anti-spam scanning and anti-virus scanning, if it is available on the appliance. The `skip-filters` action is the default final action for message filters.

The following filter notifies `customercare@example.com` and then immediately delivers any message addressed to `boss@admin`.

```
bossFilter:
if(rcpt-to == 'boss@admin$')
{
notify('customercare@example.com');
skip-filters();
}
```

Drop Action

The `drop` action discards a message without any delivery. The message is not returned to the sender, not sent to the intended recipient, nor processed further in any way.

The following filter first notifies `george@whitehouse.gov` and then discards any message where the subject begins with `SPAM`.

```
spamFilter:
if(subject == '^SPAM.*')
{
notify('george@whitehouse.gov');
drop();
}
```

Bounce Action

The `bounce` action sends the message back to the sender (Envelope Sender) without further processing.

The following filter returns (bounces) any message from an email address that ends in `@yahoo\\.com`.

```
yahooFilter:
if(mail-from == '@yahoo\\.com$')
{
bounce();
}
```

Encrypt Action

The `encrypt` action uses the configured encryption profile to deliver encrypted messages to email recipients.

The following filter encrypts messages if they contain the term `[encrypt]` in the subject:

```
Encrypt_Filter:
if ( subject == '\\[encrypt\\]' )
{
encrypt('My_Encryption_Profile');
}
```



Note You must have a Cisco Encryption Appliance in your network or a hosted key service configured to use this filter action. You must also have configured an encryption profile to use this filter action.

S/MIME Sign or Encrypt on Delivery Action

The `smime-gateway-deferred` action performs an S/MIME signing or encryption of the message using the specified sending profile during the delivery. This means that the message continues to the next stage of processing, and when all processing is complete, the message is signed or encrypted and delivered.

The following filter performs an S/MIME encryption on all the outgoing messages from a particular sender during the delivery:

```
smime-deferred:if(mail-from == "user@example.com") {smime-gateway-deferred("smime-encrypt");}
```

S/MIME Sign or Encrypt Action

The `smime-gateway` action performs an S/MIME signing or encryption using the specified sending profile and delivers the message, skipping any further processing.

The following filter performs an S/MIME signing on all the outgoing messages from a particular sender and delivers them immediately:

```
smime-deliver-now:if(mail-from == "user@example.com"){smime-gateway("smime-sign");}
```

Notify and Notify-Copy Actions

The `notify` and `notify-copy` actions send an email summary of the message to the specified email address. The `notify-copy` action also sends a copy of the original message, similar to the `bcc-scan` action. The notification summary contains:

- The contents of the Envelope Sender and Envelope Recipient (`MAIL FROM` and `RCPT TO`) directives from the mail transfer protocol conversation for the message.
- The message headers of the message.
- The name of the message filter that matched the message.

You can specify the recipient, subject line, from address, and notification template. the following filter selects messages with sizes larger than 4 megabytes, sends a notification email of each matching message to `admin@example.com` , and finally discards the message:

```
bigFilter:
if(body-size >= 4M)
{
notify('admin@example.com');
drop();
}
```

Or

```
bigFilterCopy:
if(body-size >= 4M)
{
notify-copy('admin@example.com');
drop();
}
```

The Envelope Recipient parameter may be any valid email address (for example, `admin@example.com` in the example above), or alternatively, may be the action variable `$EnvelopeRecipients` (see [Action Variables, on page 195](#)), which specifies all Envelope Recipients of the message:

```
bigFilter:
if(body-size >= 4M)
{
notify('$EnvelopeRecipients');
drop();
}
```

```
}
```

The `notify` action also supports up to three additional, optional arguments that allow you to specify the subject header, the Envelope Sender, and a pre-defined text resource to use for the notification message. These parameters must appear in order, so a subject must be provided if the Envelope Sender is to be set or a notification template specified.

The subject parameter may contain action variables (see [Action Variables, on page 195](#)) that will be replaced with data from the original message. By default, the subject is set to `Message Notification`.

The Envelope Sender parameter may be any valid email address, or alternatively, may be the action variable `$EnvelopeFrom`, which will set the return path of the message to the same as the original message

The notification template parameter is the name of an existing notification template. For more information, see [Notifications, on page 224](#).

This example extends the previous one, but changes the subject to look like `[bigFilter] Message too large`, sets the return path to be the original sender, and uses the “message.too.large” template:

```
bigFilter:
if (body-size >= 4M)
{
notify('admin@example.com', '[${FilterName}] Message too large',
'${EnvelopeFrom}', 'message.too.large');
drop();
}
```

You can also use the `$MatchedContent` action variable to notify senders or administrators that a content filter was triggered. The `$MatchedContent` action variable displays the content that triggered the filter. For example, the following filter sends a notification to an administrator if the email contains ABA account information.

```
ABA_filter:
if (body-contains ('*aba')){
notify('admin@example.com','[${MatchedContent}]Account Information Displayed');
}
```

Related Topics

- [Notification Template, on page 202](#)

Notification Template

You can use the [Text Resources](#) page or the `textconfig` CLI command to configure custom notification templates as text resources for use with the `notify()` and `notify-copy()` actions. If you do not create a custom notification template, a default template is used. The default template includes message headers, but the custom notification template does not include message headers by default. To include message headers in the custom notification, include the `$AllHeaders` action variable.

For more information, see the “Text Resources” chapter.

In the following example, when a large message triggers the filter shown below, an email is sent to the intended recipients explaining that the message was too large:

```
bigFilter:
if (body-size >= 4M)
{
  notify('${EnvelopeRecipients}', '[${FilterName}] Message too large',
  '${EnvelopeFrom}', 'message.too.large');
drop();
}
```

Blind Carbon Copy Actions

The `bcc` action sends an anonymous copy of the message to a specified recipient. This is sometimes referred to as message replication. Because no mention of the copy is made in the original message and the anonymous copy will never successfully bounce back to the recipient, the original sender and recipients of the message will not necessarily know that the copy was sent.

The following filter sends a blind carbon copy to `mom@home.org` for each message addressed to `sue` from `johnny`:

```
momFilter:
if ((mail-from == '^johnny$') and (rcpt-to == '^sue$'))
{
  bcc('mom@home.org');
}
```

The `bcc` action also supports up to three additional, optional arguments that allow you to specify the subject header and Envelope Sender to use on the copied message, as well as an `alt-mailhost`. These parameters must appear in order, so a subject must be provided if the Envelope Sender is to be set.

The subject parameter may contain action variables (see [Action Variables, on page 195](#)) that will be replaced with data from the original message. By default, this is set to the subject of the original message (the equivalent of `Subject`).

The Envelope Sender parameter may be any valid email address, or alternatively, may be the action variable `EnvelopeFrom`, which will set the return path of the message to the same as the original message.

This example expands the previous one by setting the subject to be `[Bcc] <original subject>`, and the return path set to `badbounce@home.org`:

```
momFilter:
if ((mail-from == '^johnny$') and (rcpt-to == '^sue$'))
```

The bcc-scan() Action

```
{
  bcc('mom@home.org', '[Bcc] $Subject', 'badbounce@home.org');
}
```

The alt-mailhost is the fourth parameter:

```
momFilterAltM:
if ((mail-from == '^johnny$') and (rcpt-to == '^sue$'))
{
  bcc('mom@home.org', '[Bcc] $Subject', '$EnvelopeFrom',
    'momaltmailserver.example.com');
}
```



Caution

The `Bcc()`, `notify()`, and `bounce()` filter actions can allow viruses through your network. The blind carbon copy filter action creates a new message which is a full copy of the original message. The notify filter action creates a new message that contains the headers of the original message. While it is rare, headers can contain viruses. The bounce filter action creates a new message which contains the first 10k of the original message. In all three cases, the new message will not be processed by anti-virus or anti-spam scanning.

To send to multiple hosts, you can call the `bcc()` action multiple times:

```
multiplealthosts:
if (recv-listener == "IncomingMail")
{
  insert-header('X-ORIGINAL-IP', '$remote_ip');
  bcc ('$EnvelopeRecipients', '$Subject', '$EnvelopeFrom', '10.2.3.4');
  bcc ('$EnvelopeRecipients', '$Subject', '$EnvelopeFrom', '10.2.3.5');
  bcc ('$EnvelopeRecipients', '$Subject', '$EnvelopeFrom', '10.2.3.6');
}
```

Related Topics

- [BCC and Scan Mail Sent to Competitors, on page 244](#)

The bcc-scan() Action

The `bcc-scan` action functions similarly to the `bcc` action, except that the message that is sent is treated as a brand new message and is therefore sent through the entire email pipeline.

```
momFilter:
```

```
if ((mail-from == '^johnny$') and (rcpt-to == '^sue$'))
{
  bcc-scan('mom@home.org');
}
```

Quarantine and Duplicate Actions

The `quarantine('quarantine_name')` action flags a message for inclusion into a queue called a quarantine. For more information about quarantines, see the “Quarantines” chapter. The `duplicate-quarantine('quarantine_name')` action immediately places a copy of the message into the specified quarantine and the original message continues through the email pipeline. The quarantine name is case sensitive.

When flagged for quarantine, the message continues through the rest of the email pipeline. When the message reaches the end of the pipeline, if the message has been flagged for one or more quarantines then it enters those queues. Otherwise, it is delivered. Note that if the message does not reach the end of the pipeline, it is not placed in a quarantine.

Accordingly, if a message filter contains a `quarantine()` action followed by a `bounce()` or `drop()` action, the message will not enter the quarantine, since the final action prevents the message from reaching the end of the pipeline. The same is true if a message filter includes a quarantine action, but the message is later dropped by anti-spam or anti-virus scanning, or a content filter. The `skip-filters()` action causes the message to skip any remaining message filters, but content filters may still apply. For example, if a message filter flags a message for quarantine and also includes the `skip-filters()` action, the message skips all remaining message filters and will be quarantined, unless another action in the email pipeline causes the message to be dropped.

In the following example, the message is sent to the Policy quarantine if the message contains any words within the dictionary named “secret_word.”

```
quarantine_codenames:
if (dictionary-match ('secret_words'))
{
  quarantine('Policy');
}
```

In the following example, suppose a company has an official policy to drop all .mp3 file attachments. If an inbound message has a .mp3 attachment, the attachment is stripped and the remaining message (original body and remaining attachments) is sent to the original recipient. Another copy of the original message with all attachments will be quarantined (sent to the Policy quarantine). If it is necessary to receive the blocked attachment(s), the original recipient would then request that the message be released from the quarantine.

```
strip_all_mp3s:
if (attachment-filename == '(?i)\\.mp3$') {
  duplicate-quarantine('Policy');
  drop-attachments-by-name '(?i)\\.mp3$';
}
```

```
}

```

Alter Recipient Action

The `alt-rcpt-to` action changes all recipients of the message to the specified recipient upon delivery.

The following filter sends all messages with an Envelope Recipient address that contain `.freelist.com` and changes all recipients for the message to `system-lists@myhost.com`:

```
freelistFilter:
if(rcpt-to == '\\.freelist\\.com$')
{
alt-rcpt-to('system-lists@myhost.com');
}

```

Alter Delivery Host Action

The `alt-mailhost` action changes the IP address for all recipients of the selected message to the numeric IP address or hostname given.



Note The `alt-mailhost` action prevents a message classified as spam by an anti-spam scanning engine from being quarantined. The `alt-mailhost` action overrides the `quarantine` action and sends it to the specified mail host.

The following filter redirects recipient addresses to the host `example.com` for all messages.

```
localRedirectFilter:
if(true)
{
alt-mailhost('example.com');
}

```

Thus, a message directed to `joe@anywhere.com` is delivered to the mailhost at `example.com` with the Envelope To address `joe@anywhere.com`. Note that any additional routing information specified by the `smtproutes` command still affects the routing of the message. (See [Routing Email for Local Domains, on page 671](#).)



Note The `alt-mailhost` action does not support specifying a port number. To do this, add an SMTP route instead.

The following filter redirects all messages to `192.168.12.5`:

```
local2Filter:

```

```
if(true)
{
alt-mailhost('192.168.12.5');
}
```

Alter Source Host (Virtual Gateway address) Action

The `alt-src-host` action changes the source host for the message to the source specified. The source host consists of the IP interface or group of IP interfaces that the messages should be delivered from. If a group of IP interfaces is selected, the system round-robins through all of the IP interfaces within the group as the source interface when delivering email. In essence, this allows multiple Virtual Gateway addresses to be created on a single appliance. For more information, see [Configuring Mail Gateways for all Hosted Domains Using Virtual Gateway™ Technology, on page 723](#).

The IP interface may only be changed to an IP interface or interface group currently configured in the system. The following filter creates a Virtual Gateway using the outbound (delivery) IP interface `outbound2` for all messages received from a remote host with the IP address `1.2.3.4`.

```
externalFilter:
if(remote-ip == '1.2.3.4')
{
alt-src-host('outbound2');
}
```

The following filter uses the IP interface group `Group1` for all messages received from a remote host with the IP address `1.2.3.4`.

```
groupFilter:
if(remote-ip == '1.2.3.4')
{
alt-src-host('Group1');
}
```

Archive Action

The `archive` action saves a copy of the original message, including all message headers and recipients into an `mbox-format` file on the appliance. The action takes a parameter that is the name of the log file in which to save the message. The system automatically creates a log subscription with the specified filename when you create the filter, or you can also specify an existing filter log file. After the filter and the filter log file are created, the filter log options may then be edited with the `filters -> logconfig` subcommand.



Note The `logconfig` command is a subcommand of `filters`. See [Using the CLI to Manage Message Filters, on page 228](#) for a full description of how to use this subcommand.

The `mbox` format is a standard UNIX mailbox format, and there are many utilities available to make viewing the messages easier. Most UNIX systems allow you to type “`mail -f mbox.filename`” to view the files. The `mbox` format is in plain text, so you can use a simple text editor to view the contents of the messages.

In the following example, a copy of the message is saved to a log named `joesmith` if the Envelope Sender matches `joesmith@yourdomain.com`:

```
logJoeSmithFilter:
if(mail-from == '^joesmith@yourdomain\\.com$')
{
archive('joesmith');
}
```

Strip Header Action

The `strip-header` action examines the message for a particular header and removes those lines from the message before delivering it. When there are multiple headers, all instances of the header are removed (for example, the “Received:” header.)

In the following example, all messages have the header `X-DeleteMe` removed before transmission:

```
stripXDeleteMeFilter:
if (true)
{
strip-header('X-DeleteMe');
}
```

When working with headers, remember that the current value of the header includes changes made during processing (such as with filter actions that add, remove, or modify message headings). See [Message Header Rules and Evaluation, on page 135](#) for more information.

Insert Header Action

The `insert-header` action inserts a new header into a message. AsyncOS does not verify the compliance to standards of the header you insert; you are responsible for ensuring that the resulting message complies with Internet standards for email.

The following example inserts a header named `X-Company` with the value set to `My Company Name` if the header is not already found in the message:

```
addXCompanyFilter:
```

```

if (not header('X-Company'))
{
insert-header('X-Company', 'My Company Name');
}

```

The `insert-header()` action allows the use of non-ASCII characters in the text of the header, while restricting the header name to be ASCII (to comply with standards). The transport encoding will be quoted-printable to maximize the readability.



Note The `strip-headers` and `insert-header` actions can be used in combination to rewrite any message headers in the original message. In some cases, it is valid to have multiple instances of the same header (for example, `Received:`) where in other cases, multiple instances of the same header could confuse a MUA (for example, multiple `Subject:` headers.)

When working with headers, remember that the current value of the header includes changes made during processing (such as with filter actions that add, remove, or modify message headings). See [Message Header Rules and Evaluation](#), on page 135 for more information.

Edit Header Text Action

The `edit-header-text` action allows you to rewrite specified header text using the regular expression substitution function. The filter matches the regular expression within the header and replaces it with a regular expression you specify.

For example, an email contains the following subject header:

```
Subject: SCAN Marketing Messages
```

The following filter removes the “SCAN” text, and leaves the text, “Marketing Messages”, in the header:

```

Remove_SCAN: if true
{
edit-header-text ('Subject', '^SCAN\s*', '');
}

```

After the filter processes the message, it returns the following header:

```
Subject: Marketing Messages
```

Edit Body Text Action

The `edit-body-text()` message filter is similar to the `Edit-Header-Text()` filter, but it operates across the body of the message instead of one of the headers.

The `edit-body-text()` message filter uses the following syntax where the first parameter is the regular expression to search for and the second parameter is the replacement text:

```
Example: if true {
```

```
edit-body-text("parameter 1","parameter 2");
}
```

The `edit-body-text()` message filter only works on the message body parts. For more information about whether a given MIME part is considered a message “body” or a message “attachment”, see [Message Bodies vs. Message Attachments, on page 135](#).

The following example shows a URL removed from a message and replaced with the text, ‘URL REMOVED’:

```
URL_Replaced: if true {
edit-body-text("(?i)(?:https?|ftp)://[^\s\>]+", "URL REMOVED");
}
```

The following example shows a social security number removed from the body of a message and replaced with the text, ‘XXX-XX-XXXX’:

```
ssn: if true {
edit-body-text("(?!000)(?:[0-6]\\d{2}|7(?:[0-6]\\d|7[012]))([
-]?) (?!00)\\d\\d\\d\\d\\d\\d\\d{4}",
"XXX-XX-XXXX");
}
```



Note You cannot use smart identifiers with the `edit-body-text()` filter at this time.

HTML Convert Action

While RFC 2822 defines a text format for email messages, there are extensions (such as MIME) to provide the transport of other content within an RFC 2822 message. AsyncOS can now use the `html-convert()` message filter to convert HTML to plain text using the following syntax:

```
Convert_HTML_Filter:
if (true)
{
html-convert();
}
```

The Cisco message filters make a determination on whether a given MIME part is considered a message “body” or a message “attachment”. The `html-convert()` filter only works on the message body parts. For more information about message bodies and attachments, see [Message Bodies vs. Message Attachments, on page 135](#).

Depending on the format, the `html-convert()` filter uses different methods to strip the HTML from within the documents.

If the message is plain text (`text/plain`), the message passes through the filter unchanged. If the message is a simple HTML message (`text/html`), all the HTML tags are stripped out of the message and the resulting body replaces the HTML message. The lines are not reformatted, and the HTML is not rendered in plain text. If the structure is MIME (with a `multipart/alternative` structure) and it contains both a `text/plain` part and `text/html` part with the same content, the filter removes the `text/html` part of the message and leaves the `text/plain` part of the message. For all other MIME types (such as `multipart/mixed`), all HTML body parts are stripped of their tags and reinserted into the message.

When encountered in a message filter, the `html-convert()` filter action only tags the message to be processed but does not immediately make a change to the message structure. The changes to the message only take effect after all processing is complete. This allows the other filter actions to process the original message body prior to modification.

Bounce Profile Action

The `bounce-profile` action assigns a previously-configured bounce profile to the message. (See [Directing Bounced Email, on page 700](#).) If the message is undeliverable, the bounce options configured via the bounce profile are used. Using this feature overrides the bounce profile assigned to the message from the listener's configuration (if one is assigned).

The following filter example assigns the bounce profile “fastbounce” to all email sent with the header

```
X-Bounce-Profile: fastbounce :
```

```
fastbounce:
if (header ('X-Bounce-Profile') == 'fastbounce') {
bounce-profile ('fastbounce');
}
```

Bypass Anti-Spam System Action

The `skip-spamcheck` action instructs the system to allow the message to bypass any content-based anti-spam filtering configured on the system. This action does nothing to the message if no content-based anti-spam filtering is configured, or if the message was never flagged to be scanned for spam in the first place.

The following example allows messages that have a high IP Reputation Score to bypass the content-based anti-spam filtering feature:

```
allowed_list_on_reputation:
if (reputation > 7.5)
{
skip-spamcheck();
}
```

Related Topics

- [How Incoming Relays Affect Functionality](#) , on page 395
- [Protecting Appliance -Generated Messages From the Spam Filter](#), on page 382

Bypassing Graymail Actions

If you do not want to apply graymail actions on certain messages, you can bypass them using the following message filter actions:

Message Filter Action	Description
skip-marketingcheck	Bypass actions on marketing emails
skip-socialcheck	Bypass actions on social network emails
skip-bulkcheck	Bypass actions on bulk emails

The following example specifies that messages received on the listener “private_listener” must bypass graymail actions on social network emails.

```
internal_mail_is_safe:
if (recv-listener == 'private_listener')
{
skip-socialcheck();
}
```

Bypass Anti-Virus System Action

The skip-viruscheck action instructs the system to allow the message to bypass any virus protection system configured on the system. This action does nothing to the message if there is no anti-virus system configured, or if the message was never flagged to be scanned for viruses in the first place.

The following example specifies that messages received on the listener “private_listener” should bypass the anti-spam and the anti-virus systems.

```
internal_mail_is_safe:
if (recv-listener == 'private_listener')
{
skip-spamcheck();
skip-viruscheck();
}
```

Bypass File Reputation Filtering and File Analysis System Actions

The `skip-ampcheck` action instructs the system to allow message to bypass File Reputation Filtering and File Analysis configured on the system. This action does nothing to the message if File Reputation Filtering and File Analysis is not configured, or if the message was never flagged to be scanned for File Reputation Filtering and File Analysis in the first place.

The following example specifies that messages with PDF attachments should bypass File Reputation Filtering and File Analysis.

```
skip_amp_scan:
if (attachment-filetype == 'pdf')
{
skip-ampcheck();
}
```

Bypass Outbreak Filter Scanning Action

The `skip-vofcheck` action instructs the system to allow the message to bypass the Outbreak Filters scanning. This action does nothing to the message if Outbreak Filters scanning is not enabled.

The following example specifies that messages received on the listener “private_listener” should bypass Outbreak Filter scanning.

```
internal_mail_is_safe:
if (recv-listener == 'private_listener') Outbreak Filters
{
skip-vofcheck();
}
```

Add Message Tag Action

The `tag-message` action inserts a custom term into an outgoing message to use with DLP policy filtering. You can configure a DLP policy to limit scanning to messages with the message tag. The message tag is not visible to recipients. The tag name can contain any combination of characters from the set `[a-zA-Z0-9_-.]`.

For information on configuring a DLP policy to filter messages, see the “Data Loss Prevention” chapter.

The following example inserts a message tag into a message with “[Encrypt]” in the subject. You can then create a DLP policy that will encrypt messages with this message tag before delivering them if Cisco Email Encryption is available:

```
Tag_Message:
if (subject == '^\\[Encrypt\\]')
{
tag-message('Encrypt-And-Deliver');
}
```

Add Log Entry Action

The `log-entry` action inserts customized text into the Text Mail logs at the `INFO` level. The text can include action variables. You can use this action to insert useful text for debugging purposes and information on why a message filter performed a certain action. The log entry also appears in message tracking.

The following example inserts a log entry explaining that message was bounced because it possibly contained confidential company information:

```
CompanyConfidential:

if (body-contains('Company Confidential'))
{

log-entry('Message may have contained confidential information.');
```

`bounce();`

```
}
```

URL Reputation Actions

Use the reputation score of URLs in messages to modify the URLs or their behavior. For important details and examples, see [Modifying URLs in Messages: Using URL Reputation and URL Category Actions in Filters](#), on page 434 in [Protecting Against Malicious or Undesirable URLs](#), on page 425

No rule is needed with these actions.

In URL Reputation actions:

- `msg_filter_name`: is the name of this message filter.
- `min_score` and `max_score` are the minimum and maximum scores in the range for which the action should apply. The applicable range includes the values that you specify.

Minimum and maximum scores must be between `-10.0` and `10.0`.

- To specify an action when the reputation service does not provide a score, use the corresponding "no-reputation" version of the action, as shown in the following subsections.
- `allowedlist` is the name of a defined URL list (via the `urllistconfig` command.) Specifying an allowed list is optional.
- In place of `Preserve_signed`, enter 0 or 1:
 - 1 - Apply this action to unsigned messages only
 - 0 - Apply this action to all messages

If you do not specify a `preserve_signed` value, the action is applied to unsigned messages only.

Related Topics

- [Replace URL with Text, Based on URL Reputation](#), on page 215
- [Defang URL, Based on URL Reputation](#), on page 215
- [Redirect URL to Cisco Security Proxy, Based on URL Reputation](#), on page 215

Replace URL with Text, Based on URL Reputation

To take action when the reputation service provides a score:

Use the `url-reputation-replace` action.

The syntax of a filter using the `url-reputation-replace` action is:

```
<msg_filter_name>:
if <condition>
{url-reputation-replace(<min_score>, <max_score>,'<replace_text>', '< allowedlist>','<
Preserve_signed>');}
```

Where `replace_text` is the text with which to replace the URL.

To take action when the reputation service does not provide a score:

Use the `url-no-reputation-replace` action.

The syntax of a filter using the `url-no-reputation-replace` action is:

```
<msg_filter_name>:
if <condition>
{url-no-reputation-replace ('<replace_text>', '<allowedlist>', <Preserve_signed>);}
```

Where `replace_text` is the text with which to replace the URL.

Defang URL, Based on URL Reputation

To take action when the reputation service provides a score:

Use the `url-reputation-defang` action.

The syntax of a filter using the `url-reputation-defang` action is:

```
<msg_filter_name>:
if <condition>
{url-reputation-defang (<min_score>, <max_score>, '<allowedlist>', <Preserve_signed>);}
```

To take action when the reputation service does not provide a score:

Use the `url-no-reputation-defang` action.

The syntax of a filter using the `url-no-reputation-defang` action is:

```
<msg_filter_name>:
if <condition>
{url-no-reputation-defang ('<allowedlist>', <Preserve_signed>);}
```

Redirect URL to Cisco Security Proxy, Based on URL Reputation

To take action when the reputation service provides a score:

Use the `url-reputation-proxy-redirect` action.

The syntax of a filter using the `url-reputation-proxy-redirect` action is:

```
<msg_filter_name>:
if <condition>
{url-reputation-proxy-redirect (<min_score>, <max_score>, '<allowedlist>',
<Preserve_signed>);}
```

To take action when the reputation service does not provide a score:

Use the `url-no-reputation-proxy-redirect` action.

The syntax of a filter using the `url-no-reputation-proxy-redirect` action is:

```
<msg_filter_name>:
if <condition>
{url-no-reputation-proxy-redirect ('<allowedlist>', <Preserve_signed>);}
```

URL Category Actions

Use the categories of URLs in messages to modify the URLs or their behavior. For important details, see [Modifying URLs in Messages: Using URL Reputation and URL Category Actions in Filters](#), on page 434 in [Protecting Against Malicious or Undesirable URLs](#), on page 425

No rule is needed with these actions.

In all URL Category actions:

- `msg_filter_name` : is the name of the message filter.
- `category-name` is the URL category. Separate multiple categories with commas. To obtain correct category names, look at a URL Category condition or action in a Content Filter. For descriptions and examples of the categories, see [About URL Categories](#), on page 443.
- `url_allowed_list` is the name of a defined URL list (via the `urllistconfig` command.)
- `unsigned-only` : Enter 0 or 1.
 - 1 - Apply this action to unsigned messages only
 - 0 - Apply this action to all messages

Related Topics

- [Replace URL with Text, Based on URL Category](#), on page 216
- [Defang URL, Based on URL Category](#), on page 217
- [Redirect URL to Cisco Security Proxy, Based on URL Category](#), on page 217

Replace URL with Text, Based on URL Category

The syntax of a filter using the `url-category-replace` action is

```
<msg_filter_name>:
if <condition>
url-category-replace(['<category-name1>', '<category-name2>', ...,
'<category-name3>'], '<replacement-text>', '<url_allowed_list>', <unsigned-only>);
```

Where `replacement-text` is the text that you want to use to replace the URL.

Defang URL, Based on URL Category

The syntax of a filter using the `url-category-defang` action is:

```
<msg_filter_name>:
if <condition>
url-category-defang ([ '<category-name1>', '<category-name2>', ..., '<category-name3>' ],
'<url_allowed_list>', <unsigned-only>);
```

Redirect URL to Cisco Security Proxy, Based on URL Category

The syntax of a filter using the `url-category-proxy-redirect` action is:

```
<msg_filter_name>:
if <condition>
url-category-proxy-redirect ([ '<category-name1>', '<category-name2>', ..., '<category-name3>' ],
'<url_allowed_list>', <unsigned-only>);
```

No Operation

The No Operation action performs a no-op, or no operation. You can use this action in a message filter if you do not want to use any of the other actions such as Notify, Quarantine, or Drop. For example, to understand the behavior of a new message filter that you created, you can use the No Operation action. After the message filter is operational, you can monitor the behavior of the new message filter using the Message Filters report page, and fine-tune the filter to match your requirements.

The following example shows how to use No Operation action in a message filter.

```
new_filter_test: if header-repeats ('subject', X, 'incoming') {no-op();}
```

Forged Email Detection Action

Strips the From: header from the forged message and replaces it with the Envelope Sender.

The following message filter compares the From: header in the message with the terms in dictionary and if the matching score of a term in the content dictionary is greater than or equal to 70, the message filter strips the From: header and replaces it with the Envelope Sender.

```
FED_CF: if (forged-email-detection("Execs", 70)) { fed("from", ""); }
```

Attachment Scanning

The appliance uses Content Scanner to strip attachments from messages that are inconsistent with your corporate policies, while still retaining the ability to deliver the original message.

You can filter attachments based on their specific file type, fingerprint, or based on the content of the attachment. Using the fingerprint to determine the exact type of attachment prevents users from renaming a malicious attachment extension (for example, `.exe`) to a more commonly used extension (for example, `.doc`) in the hope that the renamed file would bypass attachment filters.

When you scan attachments for content, the Content Scanner extracts data from attachment files to search for the regular expression. It examines both data and metadata in the attachment file. If you scan an Excel or

Word document, the attachment scanning engine can also detect the following types of embedded files: .exe, .dll, .bmp, .tiff, .pcx, .gif, .jpeg, .png, and Photoshop images.

The Content Scanner in your appliance can perform content scanning on the following archive file formats:

- ACE Archive
- ALZ Archive
- Apple Disk Image
- ARJ Archive
- bzip2 Archive
- EGG Archive
- GNU Zip
- ISO Disk Image
- Java Archive
- LZH
- Microsoft Cabinet Archive
- RAR Multi-Part File
- RedHat Package Manager Archive
- Roshal Archive (RAR)
- Unix AR Archive
- UNIX Compress Archive
- UNIX cpio
- UNIX Tar
- XZ Archive
- Zip Archive
- 7-Zip
- ARC



Note You can view the details of the Content Scanner-related files using the **Security Services > Scan Behavior** page in web interface or using the `contentscannerstatus` command in CLI. These files are automatically updated using update server. If you want to manually update these files, see [Configuring Scan Behavior, on page 250](#).

Related Topics

- [Message Filters for Scanning Attachments, on page 219](#)
- [Image Analysis, on page 220](#)

- [Configuring the Image Analysis Scanning Engine, on page 220](#)
- [Configuring the Message Filter to Perform Actions Based on Image Analysis Results, on page 222](#)
- [Notifications, on page 224](#)
- [Examples of Attachment Scanning Message Filters, on page 224](#)

Message Filters for Scanning Attachments

The message filter actions described in the following table are *non-final* actions. (Attachments are dropped and the message processing continues.)

The optional comment is text that is added to the message, much like a footer, and it can contain Message Filter Action Variables (see [Examples of Attachment Scanning Message Filters, on page 224](#)).

Table 27: Message Filter Actions for Attachment Filtering

Action	Syntax	Description
Drop Attachments by Name	<code>drop-attachments-by-name (<i><regular expression></i> >[, <i><optional comment></i> >])</code>	Drops all attachments on messages that have a filename that matches the given regular expression. Archive file attachments (zip, tar) will be dropped if they contain a file that matches. See Examples of Attachment Scanning Message Filters, on page 224 .
Drop Attachments by Type	<code>drop-attachments-by-type (<i><MIME type></i> >[, <i><optional comment></i> >])</code>	Drops all attachments on messages that have a MIME type, determined by either the given MIME type or the file extension. Archive file attachments (zip, tar) will be dropped if they contain a file that matches.
Drop Attachments by File Type	<code>drop-attachments-by-filetype (<i><fingerprint name></i> >[, <i><optional comment></i> >])</code>	Drops all attachments on messages that match the given “fingerprint” of the file. Archive file attachments (zip, tar) will be dropped if they contain a file that matches.
Drop Attachments by MIME Type	<code>drop-attachments-by-mimetype (<i><MIME type></i> >[, <i><optional comment></i> >])</code>	Drops all attachments on messages that have a given MIME type. This action does not attempt to ascertain the MIME type by file extension and so it also does not examine the contents of archives.
Drop Attachments by Size	<code>drop-attachments-by-size (<i><number></i> >[, <i><optional comment></i> >])</code>	Drops all attachments on the message that, in raw encoded form, are equal to or greater than the size (in bytes) given. Note that for archive or compressed files, this action does not examine the uncompressed size, but rather the size of the actual attachment itself.

Action	Syntax	Description
Attachment Scanning	<pre>drop-attachments-where-contains (<regular expression >[, <optional comment >])</pre>	Drops all attachments on message that contain the regular expression. Archive files (zip, tar) will be dropped if any of the files they contain match the regular expression pattern.
Drop Attachments by Dictionary Matches	<pre>drop-attachments-where-dictionary -match(<dictionary name>)</pre>	This filter action strips attachments based on matches to dictionary terms. If the terms in the MIME parts considered to be an attachment match a dictionary term (and the user-defined threshold is met), the attachment is stripped from the email. See Examples of Attachment Scanning Message Filters, on page 224 .

Image Analysis

Some messages contain images that you may wish to scan for inappropriate content. Use the image analysis engine to search for inappropriate content in email.

The image analyzer uses algorithms that measure image attributes to determine the likelihood of inappropriate content. These algorithms can detect, for example, the shapes and color palette in an image. The analyzer can identify the type of shapes in an image and the percentage of any flesh-tone colors relative to the other colors in the image to help identify inappropriate content. Images with a high percentage of flesh-tone colors are more likely to be inappropriate. The algorithms do not discriminate in any way.

Image analysis is not designed to supplement or replace your Anti-Virus and Anti-Spam scanning engines. Its purpose is to enforce acceptable use by identifying inappropriate content in email. Use the image analysis scanning engine to quarantine and analyze mail and to detect trends.

After you configure your appliance for image analysis, you can use image analysis filter rules to perform actions on suspect or inappropriate emails. Image scanning allows you to scan the following types of attached files: BMP, JPG, TIF, PNG, GIF, TGA, and PCX.

When you scan image attachments, Cisco fingerprinting determines the file type, and the image analyzer uses algorithms to analyze the image content. If the image is embedded in another file, the Content Scanner extracts the file. The image analysis verdict is computed on the message as a whole. If the message does not include any images, the message receives a score of "0" which maps to a "clean" verdict. Therefore, a message without any images will receive a "clean" verdict.

Configuring the Image Analysis Scanning Engine

To enable image analysis from the GUI:

Procedure

Step 1 Go to **Security Services > IronPort Image Analysis**.

Step 2 Click **Enable**.

A success message displays, and the verdict settings display.

The image analysis filter rule allows you to determine the actions to take based on the following verdicts:

- **Clean:** The image is free of inappropriate content. The image analysis verdict is computed on the message as a whole, so a message without any images will receive a "clean" verdict if scanned.
- **Suspect:** The image may contain inappropriate content.
- **Inappropriate:** The image contains inappropriate content.

These verdicts represent a numeric value assigned by the image analyzer algorithm to determine probability of inappropriate content.

The following values are recommended:

- Clean: 0 to 49
- Suspect: 50 to 74
- Inappropriate: 75 to 100

What to do next

You can fine-tune image scanning by configuring the sensitivity setting, which helps reduce the number of false positives. For example, if you find that you are getting false positives, you can decrease the sensitivity setting. Or, conversely, if you find that the image scanning is missing inappropriate content, you may want to set the sensitivity higher. The sensitivity setting is a value between 0 (no sensitivity) and 100 (highly sensitive). The default sensitivity setting of 65 is recommended.

Related Topics

- [Tuning Image Analysis Settings, on page 221](#)

Tuning Image Analysis Settings

Procedure

- Step 1** Go to **Security Services > IronPort Image Analysis**.
- Step 2** Click **Edit Settings**.
- Step 3** Configure the settings for image analysis sensitivity. The default sensitivity setting of 65 is recommended.
- Step 4** Configure the settings for Clean, Suspect, and Inappropriate verdicts.
When you configure the value ranges, ensure that you do not overlap values and that you use whole integers.
- Step 5** Optionally, configure AsyncOS to bypass scanning images that do not meet a minimum size requirement (recommended). By default, this setting is configured for 100 pixels. Scanning images that are smaller than 100 pixels can sometimes result in false positives.

You can also enable image analysis settings from the CLI using the `imageanalysisconfig` command:

What to do next

Related Topics

- [Viewing the Verdict Score of a Particular Message, on page 222](#)

Viewing the Verdict Score of a Particular Message

To see the verdict score for a particular message, you can view the mail logs. The mail logs display the image name or file name, the score for a particular message attachment. In addition, the log displays information about whether the images in a file were scannable or unscannable. Note that information in the log describes the result for each message attachment, rather than each image. For example, if the message had a zip attachment that contained a JPEG image, the log entry would contain the name of the zip file rather than the name of the JPEG. Also, if the zip file included multiple images then the log entry would include the maximum score of all the images. The unscannable notation indicates whether any of the images were unscannable.

The log does not contain information about how the scores translate to a particular verdict (clean, suspect or inappropriate). However, because you can use mail logs to track the delivery of specific messages, you can determine by the actions performed on the messages whether the mail contained inappropriate or suspect images.

For example, the following mail log shows attachments dropped by message filter rules as a result of Image Analysis scanning:

```
Thu Apr 3 08:17:56 2009 Debug: MID 154 IronPort Image Analysis: image 'Unscannable.jpg'
is unscannable.

Thu Apr 3 08:17:56 2009 Info: MID 154 IronPort Image Analysis: attachment
'Unscannable.jpg' score 0 unscannable

Thu Apr 3 08:17:56 2009 Info: MID 6 rewritten to MID 7 by
drop-attachments-where-image-verdict filter 'f-001'

Thu Apr 3 08:17:56 2009 Info: Message finished MID 6 done
```

Configuring the Message Filter to Perform Actions Based on Image Analysis Results

Once you enable image analysis, you must create a message filter to perform different actions for different message verdicts. For example, you may wish to deliver messages with a clean verdict, but quarantine messages that are determined to have inappropriate content.



Note

Cisco recommends you do not drop or bounce messages with inappropriate or suspect verdicts. Instead, send copies of violations to a quarantine for later review and better understanding of trend analysis.

The following filter shows messages tagged if the content is inappropriate or suspect:

```
image_analysis: if image-verdict == "inappropriate" {
strip-header("Subject");
insert-header("Subject", "[inappropriate image] $Subject");
}
else {
if image-verdict == "suspect" {
```

```
strip-header("Subject");

insert-header("Subject", "[suspect image] $Subject");

}

}
```

Related Topics

- [Creating Content Filters to Strip Attachments Based on Image Analysis Verdicts](#) , on page 223

Creating Content Filters to Strip Attachments Based on Image Analysis Verdicts

After you enable image analysis, you can create a content filter to strip attachments based on image analysis verdicts, or you can configure a filter to perform different actions for different message verdicts. For example, you might decide to quarantine messages that contain inappropriate content.

To strip attachments based on image analysis verdicts:

Procedure

- Step 1** Click Mail Policies > Incoming Content Filters.
 - Step 2** Click Add Filter.
 - Step 3** Enter a name for the content filter.
 - Step 4** Under Actions, click **Add Action**.
 - Step 5** Under Strip Attachment by File Info, click **Image Analysis Verdict is**:
 - Step 6** Select from the following image analysis verdicts:
 - Suspect
 - Inappropriate
 - Suspect or Inappropriate
 - Unscannable
 - Clean
-

Configuring an Action Based on Image Analysis Verdicts

To configure an action based on image analysis verdicts:

Procedure

- Step 1** Click Mail Policies > Incoming Content Filters.
- Step 2** Click Add Filter.
- Step 3** Enter a name for the content filter.
- Step 4** Under Conditions, click **Add Condition**.

- Step 5** Under Attachment File Info, click **Image Analysis Verdict**.
- Step 6** Choose from one of the following verdicts:
- Suspect
 - Inappropriate
 - Suspect or Inappropriate
 - Unscannable
 - Clean
- Step 7** Click **Add Action**.
- Step 8** Select an action to perform on messages based on the image analysis verdict.
- Step 9** Submit and commit your changes.
-

Notifications

Using the Text Resources page in the GUI or the `textconfig` CLI command to configure custom notification templates as text resources is another useful tool when used in conjunction with attachment filtering rules. The notification template supports non-ASCII characters (you are prompted to choose an encoding while creating the template).

In the following example, the `textconfig` command was first used to create a notification template named `strip.mp3` that will be inserted into the body of the notification message. Then, an attachment filtering rule is created so that when an `.mp3` file has been stripped from a message, a notification email is sent to the intended recipients explaining that the `.mp3` file has been deleted.

```
drop-mp3s:
if (attachment-type == '*/mp3')
{ drop-attachments-by-filetype('Media');
notify ('$EnvelopeRecipients', 'Your mp3 has been removed', '$EnvelopeFrom',
'strip.mp3');
}
```

For more information, see [Notify and Notify-Copy Actions, on page 201](#).

Examples of Attachment Scanning Message Filters

The following examples shows actions performed on attachments:

- [Inserting Headers, on page 225](#)
- [Dropping Attachments by File Type, on page 225](#)
- [Dropping Attachments by Dictionary Matches, on page 226](#)
- [Quarantining Protected Attachments, on page 227](#)
- [Detecting Unprotected Attachments, on page 227](#)

Inserting Headers

In these examples, AsyncOS inserts headers when the attachments contain specified content.

In the following example, all of the attachments on the message are scanned for a keyword. If the keyword is present in all of the attachments, a custom X-Header is inserted:

```
attach_disclaim:
if (every-attachment-contains('[dD]isclaimer') ) {
insert-header("X-Example-Approval", "AttachOK");
}
```

In the following example, the attachment is scanned for a pattern in the binary data. The filter uses the `attachment-binary-contains` filter rule to search for a pattern that indicates that the PDF document is encrypted. If the pattern is present in the binary data, a custom header is inserted:

```
match_PDF_Encrypt:
if (attachment-filetype == 'pdf' AND
attachment-binary-contains('/Encrypt')){
strip-header ('Subject');
insert-header ('Subject', '[Encrypted] $Subject');
}
```

Dropping Attachments by File Type

In the following example, the “executable” group of attachments (`.exe` , `.dll` , and `.scr`) is stripped from messages and text is added to the message, listing the filenames of the dropped files (using the `$dropped_filename` action variable). Note that the `drop-attachments-by-filetype` action examines attachments and strips them based on the fingerprint of the file, and not just the three-letter filename extension. Note also that you can specify a single file type (“mpeg”) or you can refer to all of the members of the file type (“Media”):

```
strip_all_exes: if (true) {
drop-attachments-by-filetype ('Executable', "Removed attachment:
$dropped_filename");
}
```

In the following example, the same “executable” group of attachments (`.exe` , `.dll` , and `.scr`) are stripped from messages whose Envelope Sender is not within the domain `example.com` .

```
strip_inbound_exes: if (mail-from != "@example\\.com$") {
drop-attachments-by-filetype ('Executable');
```

```
}

```

In the following example, a specific member of a file type (“wmf”) as well as a the same “executable” group of attachments (`.exe` , `.dll` , and `.scr`) are stripped from messages whose Envelope Sender is not within the domain `example.com` .

```
strip_inbound_exes_and_wmf: if (mail-from != "@example\\.com$") {
drop-attachments-by-filetype ('Executable');
drop-attachments-by-filetype ('x-wmf');
}
```

In the following example, the “executable” pre-defined group of attachments is extended to include more attachment names. (Note that this action will *not* examine the attachments’ file type.)

```
strip_all_dangerous: if (true) {
drop-attachments-by-filetype ('Executable');
drop-attachments-by-name('(?!i)\\.cmd|pif|bat)$');
}
```

The `drop-attachments-by-name` action supports non-ASCII characters.



Note The `drop-attachments-by-name` action matches the regular expression against the filename captured from the MIME header. The filename captured from the MIME header may contain trailing spaces.

In the following example, a message is dropped if the attachment is not an `.exe` executable file type. However, the filter will not perform any action on the message if there is at least one attachment with the file type you want to filter out. For example, the following filter drops any message with an attachment that is not an `.exe` file type:

```
exe_check: if (attachment-filetype != "exe") {
drop();
}
```

If a message has multiple attachments, the appliance does not drop the message if at least one of the attachments is an `.exe` file, even if the other attachments not `.exe` files.

Dropping Attachments by Dictionary Matches

This `drop-attachments-where-dictionary-match` action strips attachments based on matches to dictionary terms. If the terms in the MIME parts considered to be an attachment match a dictionary term (and the user-defined threshold is met), the attachment is stripped from the email. The following example shows attachment drops if words in the “`secret_words`” dictionary are detected in the attachment. Note that the threshold for the matches is set to one:

```
Data_Loss_Prevention: if (true) {  
  drop-attachments-where-dictionary-match("secret_words", 1);  
}
```

Quarantining Protected Attachments

The `attachment-protected` filter tests whether any attachment in the message is password protected. You might use this filter on incoming mail to ensure that the attachments are scannable. According to this definition, a zip file containing one encrypted member along with unencrypted members will be considered protected. Similarly, PDF file that has no open password will not be considered protected, even though it may restrict copying or printing with a password. The following example shows protected attachments sent to a policy quarantine:

```
quarantine_protected:  
if attachment-protected  
{  
  quarantine("Policy");  
}
```

Detecting Unprotected Attachments

The `attachment-unprotected` filter tests whether any attachment in the message is *not* password protected. This message filter complements the `attachment-protected` filter. You might use this filter on outgoing mail to detect outgoing mail that is unprotected. The following example shows AsyncOS detecting unprotected attachments on an outgoing listener and quarantining the messages:

```
quarantine_unprotected:  
if attachment-unprotected  
{  
  quarantine("Policy");  
}
```

Detecting Malicious Files in Messages Attachments Using Message Filter

As an example, use the following message filter rule syntax to detect files in message attachments categorized as malicious by the ETF engine, and take appropriate actions on such messages.

Syntax:

```
Strip_malicious_files: if (file-hash-etf-rule (['etf_source1'], <'file_hash_exception_list'>))
```

```
{ file-hash-etf-strip-attachment-action (['etf_source1'], <'file_hash_exception_list>,
"file stripped from message attachment"); }
```

Where:

- 'file-hash-etf-rule' is the Attachment File Info message filter rule
- 'etf_source1' is the ETF source(s) used to detect malicious files in the messages based on the file hash.
- 'file_hash_exception_list' is the name of a file hash exception list. If a file hash exception list is not present, it is displayed as "".
- 'file-hash-etf-strip-attachment-action' is the name of the action that you want to apply on messages that contain malicious files.

In the following example, if a message contains a message attachment detected as malicious by the ETF engine, the attachment is stripped.

```
Strip_Malicious_Attachment: if (true) {file-hash-etf-strip-attachment-action
(['threat_feed_source'], "", "Malicious message attachment has been stripped from
the message."); }
```

Using the CLI to Manage Message Filters

You can use the CLI to add, delete, activate and de-activate, import and export, and set logging options for message filters. The table below shows a summary of the commands and subcommands. The table below shows a summary of the commands and subcommands.

Table 28: Message Filters Subcommands

Syntax	Description
filters	The main command. This command is interactive; it asks you for more information (for example, new , delete , import).
new	Creates a new filter. If no location is given, it is appended to the current sequence. Otherwise, the filter will be inserted into the specific place in the sequence. For more information, see Creating a New Message Filter, on page 230 .
delete	Deletes a filter by name or by sequence number. For more information, see Deleting a Message Filter, on page 230 .
move	Rearranges the existing filters. For more information, see Creating a New Message Filter, on page 230 .
set	Sets filter to active or inactive state. For more information, see Creating a New Message Filter, on page 230 .
import	Replaces the current set of filters with a new set stored in a file (in the /configuration directory of the appliance). For more information, see Creating a New Message Filter, on page 230 .
export	Exports the current set of filters to a file (in the /configuration directory of the appliance). For more information, see Exporting Message Filters, on page 234 .

Syntax	Description
<code>list</code>	Lists information about a filter or filters. For more information, see Displaying a Message Filter List, on page 234 .
<code>detail</code>	Prints detailed information about a specific filter, including the body of the filter rule itself. For more information, see Displaying Message Filter Details, on page 235 .
<code>logconfig</code>	Enters the <code>logconfig</code> submenu of filters, allowing you to edit the log subscriptions from <code>archive()</code> filter actions. For more information, see Configuring Filter Log Subscriptions, on page 235 .



Note You must issue the `commit` command for filters to take effect.

Three types of parameters are:

Table 29: Filter Management Parameters

<i>seqnum</i>	An integer representing a filter based on its position in the list of filters. A <i>seqnum</i> of 2 represents the second filter in the list, for example.
<i>filename</i>	The colloquial name of a filter.
<i>range</i>	A range may be used to represent more than one filter, and appears in the form of <i>X Y</i> , where <i>X</i> and <i>Y</i> are the first and last <i>seqnums</i> that identify the extent. For example, <i>2-4</i> represents filters in the second, third, and fourth positions. Either <i>X</i> or <i>Y</i> may be left off to represent an open-ended list. For example, <i>-4</i> represents the first four filters, and <i>2-</i> represents all filters except the first. You can also use the keyword <code>all</code> to represent all the filters in the filter list.

Related Topics

- [Creating a New Message Filter, on page 230](#)
- [Deleting a Message Filter, on page 230](#)
- [Moving a Message Filter, on page 230](#)
- [Activating and Deactivating a Message Filter, on page 230](#)
- [Importing Message Filters, on page 233](#)
- [Exporting Message Filters, on page 234](#)
- [Viewing Non-ASCII Character Sets, on page 234](#)
- [Displaying a Message Filter List, on page 234](#)
- [Displaying Message Filter Details, on page 235](#)
- [Configuring Filter Log Subscriptions, on page 235](#)
- [Changing Message Encoding, on page 236](#)
- [Sample Message Filters, on page 238](#)

Creating a New Message Filter

```
new [seqnum|filename|last]
```

Specifies the position at which to insert the new filter(s). If omitted, or given the keyword `last`, the filters entered in are appended to the list of filters. No gaps in the sequence numbers are allowed; you are not allowed to enter a *seqnum* outside the boundaries of the current list. If you enter an unknown *filename*, you are prompted to enter a valid *filename*, *seqnum*, or `last`.

After a filter has been entered, you may manually enter the filter script. When you are finished typing, end the entry by typing a period (`.`) on a line by itself.

The following conditions can cause errors:

- Sequence number beyond the current range of sequence numbers.
- Filter with a non-unique *filename*.
- Filter with a *filename* that is a reserved word.
- Filter with a syntax error.
- Filter with actions referring to non-existent system resources such as interfaces.

Deleting a Message Filter

```
delete [seqnum|filename|range]
```

Deletes the filter(s) identified.

The following conditions can cause errors:

- No filter with a given filter name.
- No filter with a given sequence number.

Moving a Message Filter

```
move [seqnum|filename|rangeseqnum|last]
```

Moves the filters identified by the first parameter to the position identified by the second parameter. If the second parameter is the keyword `last`, the filters are moved to the end of the list of filters. If more than one filter is being moved, their ordering remains the same in relation to one another.

The following conditions can cause errors:

- No filter with a given filter name.
- No filter with a given sequence number.
- Sequence number beyond the current range of sequence numbers.
- Movement would result in no change of sequence.

Activating and Deactivating a Message Filter

A given message filter is either *active* or *inactive* and it is also either *valid* or *invalid*. A message filter is only used for processing if it is both *active* and *valid*. You change an existing filter from active to inactive (and

back again) using the CLI. A filter is invalid if it refers to a listener or interface which does not exist (or has been removed).



Note You can determine if a filter is inactive by its syntax; AsyncOS changes the colon after the filter name to an exclamation point for inactive filters. If you use this syntax when entering or importing a filter, AsyncOS marks the filter as inactive.

For example, the following benign filter named “filterstatus” is entered. It is then made inactive using the `filter -> set` subcommand. Note that when the details of the filter are shown, the colon has been changed to an exclamation point (and is bold in the following example).

```
mail3.example.com> filters
```

```
Choose the operation you want to perform:
```

- NEW - Create a new filter.
- IMPORT - Import a filter script from a file.

```
[ ]> new
```

```
Enter filter script. Enter '.' on its own line to end.
```

```
filterstatus: if true(skip-filters());
```

```
.
```

```
1 filters added.
```

```
Choose the operation you want to perform:
```

- NEW - Create a new filter.
- DELETE - Remove a filter.
- IMPORT - Import a filter script from a file.
- EXPORT - Export filters to a file
- MOVE - Move a filter to a different position.
- SET - Set a filter attribute.
- LIST - List the filters.
- DETAIL - Get detailed information on the filters.
- LOGCONFIG - Configure log subscriptions used by filters.
- ROLLOVERNOW - Roll over a filter log file.

```
[ ]> list
```

```
Num Active Valid Name
```

```
1 Y Y filterstatus
```

```
Choose the operation you want to perform:
```

```
- NEW - Create a new filter.
- DELETE - Remove a filter.
- IMPORT - Import a filter script from a file.
- EXPORT - Export filters to a file
- MOVE - Move a filter to a different position.
- SET - Set a filter attribute.
- LIST - List the filters.
- DETAIL - Get detailed information on the filters.
- LOGCONFIG - Configure log subscriptions used by filters.
- ROLLOVERNOW - Roll over a filter log file.

[ ]> set

Enter the filter name, number, or range:

[all]> all

Enter the attribute to set:

[active]> inactive

1 filters updated.

Choose the operation you want to perform:

- NEW - Create a new filter.
- DELETE - Remove a filter.
- IMPORT - Import a filter script from a file.
- EXPORT - Export filters to a file
- MOVE - Move a filter to a different position.
- SET - Set a filter attribute.
- LIST - List the filters.
- DETAIL - Get detailed information on the filters.
- LOGCONFIG - Configure log subscriptions used by filters.
- ROLLOVERNOW - Roll over a filter log file.

[ ]> detail

Enter the filter name, number, or range:

[ ]> all

Num Active Valid Name
1 N Y filterstatus
```

```
filterstatus! if (true) {
skip-filters();
}
```

Choose the operation you want to perform:

- NEW - Create a new filter.
 - DELETE - Remove a filter.
 - IMPORT - Import a filter script from a file.
 - EXPORT - Export filters to a file
 - MOVE - Move a filter to a different position.
 - SET - Set a filter attribute.
 - LIST - List the filters.
 - DETAIL - Get detailed information on the filters.
 - LOGCONFIG - Configure log subscriptions used by filters.
 - ROLLOVERNOW - Roll over a filter log file.
- []>

Related Topics

- [Activating or Deactivating a Message Filter, on page 233](#)

Activating or Deactivating a Message Filter

```
set [seqnum|filename|range] active|inactive
```

Sets the filters identified to have the given state. Legal states are:

- active: Set the state of the selected filters to be active.
- inactive: Set the state of the selected filters to be inactive.

The following conditions can cause errors:

- No filter with a given *filename* .
- No filter with a given sequence number.



Note A filter which is inactive may also be noted in its syntax; the colon after the label (name of the filter) is changed to an exclamation point (!). A filter entered manually from the CLI, or imported, that contains this syntax, will automatically be marked inactive. For example, mailfrompm! instead of mailfrompm: is displayed.

Importing Message Filters

```
import filename
```

The name of the file containing filters to be processed. This file must reside in the configuration directory of the FTP/SCP root directory on the appliance, if you enabled FTP/SCP access for the interface with the `interfaceconfig` command. It is ingested and parsed, and any errors are reported. The filters imported replace all filters existing in the current filter set. See [FTP, SSH, and SCP Access, on page 1261](#) for more information. Consider exporting the current filter list (see [Exporting Message Filters, on page 234](#)) and then editing that file before importing.

When importing message filters, you are prompted to select the encoding used.

The following conditions can cause errors:

- File does not exist.
- Filter with a non-unique filter name.
- Filter with a *filename* that is a reserved word.
- Filter with a syntax error.
- Filter with actions referring to non-existent system resources such as interfaces.

Exporting Message Filters

```
export filename[seqnum|filename|range]
```

Output a formatted version of the existing filter set to a file in the configuration directory of the FTP/SCP root directory on the appliance. See [FTP, SSH, and SCP Access, on page 1261](#) for more information.

When exporting message filters, you are prompted to select the encoding used.

The following conditions can cause errors:

- No filter with a given filter name.
- No filter with a given sequence number.

Viewing Non-ASCII Character Sets

The system displays filters containing non-ASCII characters in the CLI in UTF-8. If your terminal/display does not support UTF-8, the filter will be unreadable.

The best way to manage non-ASCII characters in filters is to edit the filter in a text file and then import that text file (see [Importing Message Filters, on page 233](#)) into the appliance.

Displaying a Message Filter List

```
list [seqnum|filename|range]
```

Shows summarized information about the identified filters in a tabular form without printing the filter body.

The information displayed includes:

- Filter name
- Filter sequence number
- Filter's active/inactive state
- Filter's valid/invalid state

The following conditions can cause errors:

- Illegal range format.

Displaying Message Filter Details

```
detail [seqnum|filtname|range]
```

Provides full information about the identified filters, including the body of the filter and any additional state information.

Configuring Filter Log Subscriptions

```
logconfig
```

Enters a submenu that allows you to configure the filter log options for the mailbox files generated by the `archive()` action. These options are very similar to those used by the regular `logconfig` command, but the logs may only be created or deleted by adding or removing filters that reference them.

Each filter log subscription has the following default values, which can be modified using the `logconfig` subcommand:

- Retrieval method - FTP Poll
- File size - 10MB
- Max number of files - 10

For more information, see the “Logging” chapter.

```
mail3.example.com> filters
```

Choose the operation you want to perform:

- NEW - Create a new filter.
- DELETE - Remove a filter.
- IMPORT - Import a filter script from a file.
- EXPORT - Export filters to a file
- MOVE - Move a filter to a different position.
- SET - Set a filter attribute.
- LIST - List the filters.
- DETAIL - Get detailed information on the filters.
- LOGCONFIG - Configure log subscriptions used by filters.
- ROLLOVERNOW - Roll over a filter log file.

```
[> logconfig
```

Currently configured logs:

```
1. "joesmith" Type: "Filter Logs" Retrieval: FTP Poll
```

Choose the operation you want to perform:

- EDIT - Modify a log setting.

```

[ ]> edit

Enter the number of the log you wish to edit.

[ ]> 1

Choose the method to retrieve the logs.

1. FTP Poll
2. FTP Push
3. SCP Push

[1]> 1

Please enter the filename for the log:

[joesmith.mbox]>

Please enter the maximum file size:

[10485760]>

Please enter the maximum number of files:

[10]>

Currently configured logs:

1. "joesmith" Type: "Filter Logs" Retrieval: FTP Poll

Enter "EDIT" to modify or press Enter to go back.

[ ]>

```

Changing Message Encoding

You can use the `localeconfig` command to set the behavior of AsyncOS regarding modifying the encoding of message headings and footers during message processing:

```
example.com> localeconfig
```

```

Behavior when modifying headers: Use encoding of message body
Behavior for untagged non-ASCII headers: Impose encoding of message body
Behavior for mismatched footer or heading encoding: Try both body and footer or heading
encodings
Behavior when decoding errors found: Disclaimer is displayed as inline content and the
message body is added as an attachment.

```

```

Choose the operation you want to perform:
- SETUP - Configure multi-lingual settings.
[ ]> setup

```

```

If a header is modified, encode the new header in the same encoding as the message body?
(Some MUAs incorrectly handle headers encoded in a different encoding than the body.
However, encoding a modified header in the same encoding as the message body may cause
certain
characters in the modified header to be lost.) [Y]>

```

```

If a non-ASCII header is not properly tagged with a character set and is being used or
modified,

```

impose the encoding of the body on the header during processing and final representation of the message?
(Many MUAs create non-RFC-compliant headers that are then handled in an undefined way. Some MUAs handle headers encoded in character sets that differ from that of the main body in an incorrect way.
Imposing the encoding of the body on the header may encode the header more precisely. This will be used to interpret the content of headers for processing, it will not modify or rewrite the header unless that is done explicitly as part of the processing.) [Y]>

Disclaimers (as either footers or headings) are added in-line with the message body whenever possible.
However, if the disclaimer is encoded differently than the message body, and if imposing a single encoding will cause loss of characters, it will be added as an attachment. The system will always try to use the message body's encoding for the disclaimer. If that fails, the system can try to edit the message body to use an encoding that is compatible with the message body as well as the disclaimer. Should the system try to re-encode the message body in such a case? [Y]>

If the disclaimer that is added to the footer or header of the message generates an error when decoding the message body, it is added at the top of the message body. This prevents you to rewrite a new message content that must merge with the original message content and the header/footer-stamp. The disclaimer is now added as an additional MIME part that displays only the header disclaimer as an inline content, and the rest of the message content is split into separate email attachments. Should the system try to ignore such errors when decoding the message body? [N]>

Behavior when modifying headers: Use encoding of message body
Behavior for untagged non-ASCII headers: Impose encoding of message body
Behavior for mismatched footer or heading encoding: Try both body and footer or heading encodings
Behavior when decoding errors found: Disclaimer is displayed as inline content and the message body is added as an attachment.

Choose the operation you want to perform:
- SETUP - Configure multi-lingual settings.
[]>

The first prompt determines whether or not a message header's encoding should be changed to match that of the message body if the header is changed (via a filter, for example).

The second prompt controls whether or not the appliance should impose the encoding of the message body on the header if the header is not properly tagged with a character set.

The third prompt is used to configure how disclaimer stamping (and multiple encodings) in the message body works. Please see "Disclaimer Stamping and Multiple Encodings" in the "Text Resources" chapter for more information.

The fourth prompt is used to configure the behaviour of disclaimer stamping, if an error is generated during the decoding of the message body. If you select 'Yes', the decoding errors are ignored and the disclaimer is stamped. If you select 'No', the disclaimer text is added as an attachment to the message.

Sample Message Filters

In the following example, the filter command is used to create three new filters:

- The first filter is named **big_messages**. It uses the `body-size` rule to drop messages larger than 10 megabytes.
- The second filter is named **no_mp3s**. It uses the `attachment-filename` rule to drop messages that contain attachments with the filename extension of `.mp3`.
- The third filter is named **mail_frompm**. It uses `mail-from` rule examines all mail from `postmaster@example.com` and `blind-carbon copies administrator@example.com`.

Using the `filter -> list` subcommand, the filters are listed to confirm that they are active and valid, and then the first and last filters are switched in position using the `move` subcommand. Finally, the changes are committed so that the filters take effect.

```
mail3.example.com> filters

Choose the operation you want to perform:

- NEW - Create a new filter.

- IMPORT - Import a filter script from a file.

[> new

Enter filter script. Enter '.' on its own line to end.

big_messages:

if (body-size >= 10M) {

drop();

}

.

1 filters added.

Choose the operation you want to perform:

- NEW - Create a new filter.

- DELETE - Remove a filter.

- IMPORT - Import a filter script from a file.

- EXPORT - Export filters to a file

- MOVE - Move a filter to a different position.

- SET - Set a filter attribute.

- LIST - List the filters.

- DETAIL - Get detailed information on the filters.

- LOGCONFIG - Configure log subscriptions used by filters.

- ROLLOVERNOW - Roll over a filter log file.

[> new
```

Enter filter script. Enter '.' on its own line to end.

```
no_mp3s:
if (attachment-filename == '(?i)\\.mp3$') {
drop();
}
```

.

1 filters added.

Choose the operation you want to perform:

- NEW - Create a new filter.
- DELETE - Remove a filter.
- IMPORT - Import a filter script from a file.
- EXPORT - Export filters to a file
- MOVE - Move a filter to a different position.
- SET - Set a filter attribute.
- LIST - List the filters.
- DETAIL - Get detailed information on the filters.
- LOGCONFIG - Configure log subscriptions used by filters.
- ROLLOVERNOW - Roll over a filter log file.

[> new

Enter filter script. Enter '.' on its own line to end.

```
mailfrompm:
if (mail-from == "^postmaster$")
{ bcc ("administrator@example.com");}
```

.

1 filters added.

Choose the operation you want to perform:

- NEW - Create a new filter.
- DELETE - Remove a filter.
- IMPORT - Import a filter script from a file.
- EXPORT - Export filters to a file
- MOVE - Move a filter to a different position.
- SET - Set a filter attribute.

```
- LIST - List the filters.
- DETAIL - Get detailed information on the filters.
- LOGCONFIG - Configure log subscriptions used by filters.
- ROLLOVERNOW - Roll over a filter log file.

[]> list

Num Active Valid Name
1 Y Y big_messages
2 Y Y no_mp3s
3 Y Y mailfrompm

Choose the operation you want to perform:

- NEW - Create a new filter.
- DELETE - Remove a filter.
- IMPORT - Import a filter script from a file.
- EXPORT - Export filters to a file
- MOVE - Move a filter to a different position.
- SET - Set a filter attribute.
- LIST - List the filters.
- DETAIL - Get detailed information on the filters.
- LOGCONFIG - Configure log subscriptions used by filters.
- ROLLOVERNOW - Roll over a filter log file.

[]> move

Enter the filter name, number, or range to move:

[]> 1

Enter the target filter position number or name:

[]> last

1 filters moved.

Choose the operation you want to perform:

- NEW - Create a new filter.
- DELETE - Remove a filter.
- IMPORT - Import a filter script from a file.
- EXPORT - Export filters to a file
- MOVE - Move a filter to a different position.
```

- SET - Set a filter attribute.
- LIST - List the filters.
- DETAIL - Get detailed information on the filters.
- LOGCONFIG - Configure log subscriptions used by filters.
- ROLLOVERNOW - Roll over a filter log file.

```
[ ]> list
```

```
Num Active Valid Name
```

```
1 Y Y no_mp3s
```

```
2 Y Y mailfrompm
```

```
3 Y Y big_messages
```

```
Choose the operation you want to perform:
```

- NEW - Create a new filter.
- DELETE - Remove a filter.

- IMPORT - Import a filter script from a file.
- EXPORT - Export filters to a file
- MOVE - Move a filter to a different position.
- SET - Set a filter attribute.
- LIST - List the filters.
- DETAIL - Get detailed information on the filters.
- LOGCONFIG - Configure log subscriptions used by filters.
- ROLLOVERNOW - Roll over a filter log file.

```
[ ]> move
```

```
Enter the filter name, number, or range to move:
```

```
[ ]> 2
```

```
Enter the target filter position number or name:
```

```
[ ]> 1
```

```
1 filters moved.
```

```
Choose the operation you want to perform:
```

- NEW - Create a new filter.
- DELETE - Remove a filter.
- IMPORT - Import a filter script from a file.

```

- EXPORT - Export filters to a file
- MOVE - Move a filter to a different position.
- SET - Set a filter attribute.
- LIST - List the filters.
- DETAIL - Get detailed information on the filters.
- LOGCONFIG - Configure log subscriptions used by filters.
- ROLLOVERNOW - Roll over a filter log file.

[]> list

Num Active Valid Name
1 Y Y mailfrompm
2 Y Y no_mp3s
3 Y Y big_messages

Choose the operation you want to perform:
- NEW - Create a new filter.
- DELETE - Remove a filter.
- IMPORT - Import a filter script from a file.
- EXPORT - Export filters to a file
- MOVE - Move a filter to a different position.
- SET - Set a filter attribute.
- LIST - List the filters.
- DETAIL - Get detailed information on the filters.
- LOGCONFIG - Configure log subscriptions used by filters.
- ROLLOVERNOW - Roll over a filter log file.

[]>

mail3.example.com> commit

Please enter some comments describing your changes:

[]> entered and enabled 3 filters: no_mp3s, mailfrompm, big_messages

Do you want to save the current configuration for rollback? [Y]> n

Changes committed: Fri May 23 11:42:12 2014 GMT

```

Message Filter Examples

This section contains some real world examples of filters with a brief discussion of each.

Related Topics

- [Open-Relay Prevention Filter, on page 243](#)
- [Policy Enforcement Filters, on page 243](#)
- [Routing and Domain Spoofing, on page 247](#)

Open-Relay Prevention Filter

This filter bounces messages with addresses using % , extra @ , and ! characters in email addresses:

```
• user%otherdomain@validdomain
• user@otherdomain@validdomain:
• domain!user@validdomain

sourceRouted:

if (rcpt-to == "(%|@|!)(.*)@") {

bounce();

}
```

The appliances are not susceptible to these third party relay hacks that are often used to exploit traditional Sendmail/Qmail systems. As many of these symbols (for example %) can be part of a perfectly legal email address, appliances will accept these as valid addresses, verify them against the configured recipient lists, and pass them on to the next internal server. The appliances do not relay these messages to the world.

These filters are put in place to protect users who may have open-source MTAs that are misconfigured to allow relay of these types of messages.



Note You can also configure a listener to handle these types of addresses. See [Listening for Connection Requests by Creating a Listener Using Web Interface, on page 75](#) for more information.

Policy Enforcement Filters

- [Notify Based on Subject Filter, on page 244](#)
- [BCC and Scan Mail Sent to Competitors, on page 244](#)
- [Block Specific User Filter, on page 244](#)
- [Archive and Drop Messages Filter, on page 244](#)
- [Large “To:” Header Filter, on page 245](#)
- [Blank “From:” Filter, on page 245](#)
- [IP Reputation Filter, on page 246](#)
- [Alter IP Reputation Filter, on page 246](#)

- [Filename Regex Filter, on page 246](#)
- [Show IP Reputation Score in Header Filter, on page 246](#)
- [Insert Policy into Header Filter, on page 246](#)
- [Too Many Recipients Bounce Filter, on page 247](#)

Notify Based on Subject Filter

This filter sends notification based on whether the subject contains specific words:

```
search_for_sensitive_content:

if (Subject == "(?i)plaintiff|lawsuit|judge" ) {

notify ("admin@company.com");

}
```

BCC and Scan Mail Sent to Competitors

This filter scans and blind copies messages that are sent to competitors. Note that you could use a dictionary and the `header-dictionary-match()` rule to specify a more flexible list of competitors (see [Dictionary Rules, on page 167](#)):

```
competitorFilter:

if (rcpt-to == '@competitor1.com|@competitor2.com') {

bcc-scan('legal@example.com');

}
```

Block Specific User Filter

Use this filter to block email from a specific address:

```
block_harrasing_user:

if (mail-from == "ex-employee@hotmail\\.com") {

notify ("admin@company.com");

drop ();

}
```

Archive and Drop Messages Filter

Log and drop only the messages that have matching filetypes:

```
drop_attachments:

if (mail-from != "user@example.com") AND (attachment-filename ==
```

```
'(?i)\\. (asp|bas|bat|cmd|cpl|exe|hta|ins|isp|js)$')
{
archive("Drop_Attachments");
insert-header("X-Filter", "Dropped by: $FilterName MID: $MID");
drop-attachments-by-name("\\. (asp|bas|bat|cmd|cpl|exe|hta|ins|isp|js)$");
}
```

Large "To:" Header Filter

Find messages with very large "To" headers.

Use the `archive()` line for verification of proper action, with `drop()` enabled or disabled for extra safety:

```
toTooBig:
if(header('To') == "^.{500,}") {
archive('tooTooBigdropped');
drop();
}
```

Blank "From:" Filter

Identify blank "From" headers,

This filter can alleviate various forms of blank "from" addresses:

```
blank_mail_from_stop:
if (recv-listener == "InboundMail" AND header("From") == "^$|<\\s*>") {
drop ();
}
```

If you also want to drop messages with a blank envelope from, use this filter:

```
blank_mail_from_stop:
if (recv-listener == "InboundMail" AND (mail-from == "^$|<\\s*>" OR header ("From") ==
"^$|<\\s*>"))
{
drop ();
}
```

IP Reputation Filter

IP Reputation filter:

```
note_bad_reps:
if (reputation < -2) {
strip-header ('Subject');

insert-header ('Subject', '***BadRep $Reputation *** $Subject');
}
```

Alter IP Reputation Filter

Alter the IP Reputation Score threshold for certain domains:

```
mod_ipr:
if ( (rcpt-count == 1) AND (rcpt-to == "@domain\\.com$") AND (reputation < -2) ) {
drop ();
}
```

Filename Regex Filter

This filter specifies a range of size for the body of the message, and looks for an attachment that matches the regular expression (this matches files named “readme.zip”, “readme.exe”, “attach.exe”, and so forth.):

```
filename_filter:
if ( (body-size >= 9k) AND (body-size <= 20k) ) {
if (body-contains "(?i)(readme|attach|information)\\. (zip|exe)$") {
drop ();

}

}
```

Show IP Reputation Score in Header Filter

Remember to log the headers (see the “Logging” chapter) so they appear in the mail log:

```
Check_ipr:
if (true) {

insert-header('X-ipr', '$Reputation');

}
```

Insert Policy into Header Filter

Show which mail flow policy accepted the connection:

```
Policy_Tracker:
if (true) {
```

```
insert-header ('X-HAT', 'Sender Group $Group, Policy $Policy applied.');
```

```
}
```

Too Many Recipients Bounce Filter

Bounce all outbound email messages with more than 50 recipients from more than two unique domains:

```
bounce_high_rcpt_count:
```

```
if ( (rcpt-count > 49) AND (rcpt-to != "@example\\.com$") ) {
```

```
  bounce-profile ("too_many_rcpt_bounce"); bounce ();
```

```
}
```

Routing and Domain Spoofing

- [Using Virtual Gateways Filter, on page 247](#)
- [Same Listener for Deliver and Listener Filter, on page 247](#)
- [Single Listener Filter, on page 248](#)
- [Drop Spoofed Domain Filter \(Single Listener\), on page 248](#)
- [Drop Spoofed Domain Filter \(Multiple Listeners\), on page 248](#)
- [Another Drop Spoofed Domain Filter, on page 248](#)
- [Detect Looping Filter, on page 249](#)

Using Virtual Gateways Filter

Segment traffic using virtual gateways. Assuming you have two Interfaces on the system, 'public1' and 'public2', and the default delivery interface is 'public1'. This would force all of your outbound traffic over the second interface; since bounces and other similar types of mail do not go through filters, they will be delivered from public1:

```
virtual_gateways:
```

```
if (rcv-listener == "OutboundMail") {
```

```
  alt-src-host ("public2");
```

```
}
```

Same Listener for Deliver and Listener Filter

Use the same listener for delivery and receiving. This filter will allow you to send any messages received on the public listener "listener1" out the interface "listener1" (you will have to set up a unique filter for each public listener configured):

```
same_listener:
```

```
if (rcv-inj == 'listener1') {
```

```
alt-src-host('listener1');
}
```

Single Listener Filter

Make the filter work on a single listener. For example, specify a specific listener for message filter processing instead of being performed system wide.

```
textfilter-new:
if (recv-inj == 'inbound' and body-contains("some spammy message")) {
alt-rcpt-to ("spam.quarantine@spam.example.com");
}
```

Drop Spoofed Domain Filter (Single Listener)

Drop email with a spoofed domain (pretending to be from an internal address; works with a single listener). IP addresses below represent fictional domain for mycompany.com :

```
DomainSpoofed:
if (mail-from == "mycompany\\.com$") {
if ((remote-ip != "1.2.") AND (remote-ip != "3.4. ")) {
drop();
}
}
```

Drop Spoofed Domain Filter (Multiple Listeners)

As above, but works with multiple listeners:

```
domain_spoof:
if ((recv-listener == "Inbound") and (mail-from == "@mycompany\\.com")) {
archive('domain_spoof');
drop ();
}
```

Another Drop Spoofed Domain Filter

Summary: Anti domain spoof filter:

```
reject_domain_spoof:
```

```

if (recv-listener == "MailListener") {
insert-header("X-Group", "$Group");
if ((mail-from == "@test\\.mycompany\\.com") AND (header("X-Group") != "RELAYLIST")) {
notify("me@here.com");
drop();
strip-header("X-Group");
}
}

```

Detect Looping Filter

This filter is used to detect, stop, and determine what is causing, a mail loop. This filter can help determine a configuration issue on the Exchange server or elsewhere.

```

External_Loop_Count:
if (header("X-ExtLoop1")) {

if (header("X-ExtLoopCount2")) {
if (header("X-ExtLoopCount3")) {
if (header("X-ExtLoopCount4")) {
if (header("X-ExtLoopCount5")) {
if (header("X-ExtLoopCount6")) {
if (header("X-ExtLoopCount7")) {
if (header("X-ExtLoopCount8")) {
if (header("X-ExtLoopCount9")) {
notify ('joe@example.com');
drop();
}

else {insert-header("X-ExtLoopCount9", "from
$RemoteIP");}}

else {insert-header("X-ExtLoopCount8", "from $RemoteIP");}}
else {insert-header("X-ExtLoopCount7", "from $RemoteIP");}}
else {insert-header("X-ExtLoopCount6", "from $RemoteIP");}}
else {insert-header("X-ExtLoopCount5", "from $RemoteIP");}}
else {insert-header("X-ExtLoopCount4", "from $RemoteIP");}}
else {insert-header("X-ExtLoopCount3", "from $RemoteIP");}}
else {insert-header("X-ExtLoopCount2", "from $RemoteIP");}}

```

```
else {insert-header("X-ExtLoop1", "1");
}
```



Note By default, AsyncOS automatically detects mail loops and will drop messages after 100 loops.

Configuring Scan Behavior

You can control the behavior of body and attachment scanning, such as the attachment types to be skipped during a scan by configuring the scanning parameters. Use the Scan Behavior page or the `scanconfig` command to configure these parameters. Scan behavior settings are global settings, meaning that they affect the behavior of all the scans.



Note If you want to scan a MIME type that may be included in a zip or compressed file, you must include list 'compressed' or 'zip' or 'application/zip' in the scan list.

Procedure

Step 1 Click **Security Services > Scan Behavior**.

Step 2 Define the attachment type mapping. Do one of the following:

- Add a new attachment type mapping. Click **Add Mapping**.
- Import a list of attachment type mappings using a configuration file. Click **Import List**, and import the desired configuration file from the configuration directory.

Note To perform this step, the configuration file must be present in the configuration directory of your appliance. See [Managing the Configuration File, on page 995](#).

- Click **Edit** to modify an existing attachment type mapping.

Step 3 Configure the global settings. Do the following:

- a) Under Global Settings, click **Edit Global Settings**.
- b) Edit the required fields:

Field	Description
Action for attachments with MIME types / fingerprints in table above	Choose whether to scan or skip attachments types defined in the attachment type mapping.
Maximum depth of attachment recursion to scan	Specify the level up to which the recursive attachments are to be scanned.
Maximum attachment size to scan	Specify the maximum size of attachments to scan.

Field	Description
Attachment Metadata scan	Specify whether to scan or skip metadata of the attachments.
Attachment scanning timeout	Specify the scanning time-out period.
Assume attachment matches pattern if not scanned for any reason	Specify whether to consider unscanned attachments as match to the search pattern.
Action when message cannot be deconstructed to remove specified attachments	Specify the action to be taken when a message could not be deconstructed to remove specified attachments.
Bypass all filters in case of a content or message filter error	Specify whether to bypass all filters in case of a content or message filter error.
Encoding to use when none is specified	Specify the encoding to be used if no encoding is specified.
Convert opaque-signed messages to clear-signed (S/MIME unpacking)	Specify whether to convert opaque-signed messages to clear-signed (S/MIME unpacking).
Safe Print Settings	
Maximum File Size	Enter the maximum attachment size for a safe-printed attachment. Note If the 'Maximum File Size' value exceeds the 'Maximum Message Size to Scan' value configured for Outbreak Filters on your email gateway, then the message and the message attachment is not scanned by Outbreak Filters in the email pipeline.
Maximum Page Count	Enter the maximum number of pages that you want to safe print in a message attachment.
Document Quality	Select the Use Default Value (70) option to use the recommended image quality value for a safe-printed attachment. Note You can also select the Enter Custom Value option and enter a custom image quantity value for a safe-printed attachment.
File Type Selection	Select the required file types from the appropriate file groups (for example, "Microsoft Documents") that you can use to safe print a message attachment.

Field	Description
Watermark	Select Enabled option to add a watermark to a safe-printed attachment. Note You can enter a custom text for the watermark in the Enter Custom Text: field.
Cover Page	Select Enabled option to add a cover page to a safe-printed attachment. Note You can enter a custom text for the cover page in the Enter Custom Text field.
For more information, see How to Configure Email Gateway to Safe Print Message Attachments, on page 334 .	
Scanning of Password-protected Attachments	
Actions for Unscannable Messages due to decoding errors found during URL Filtering Actions	Specify the actions to take when a message cannot be scanned by the Content Scanner due to decoding errors found during URL filtering actions.
Action for unscannable messages due to extraction failures	Specify the actions to take when a message cannot be scanned by the Content Scanner because of an attachment extraction failure.
Action for unscannable messages due to RFC violations	Specify the actions to take when a message cannot be scanned by the Content Scanner because of an RFC violation.

c) Click **Submit**.

Step 4 (Optional) Manually update the Content Scanner files. Under **Current Content Scanner files**, click **Update Now**.

Usually, these files are automatically updated using update server.

Note You can also use the `contentsscannerupdate` in CLI to manually update these files.

Step 5 Commit the changes.

Configuring Message Handling Actions for Unscannable Messages

The Content Scanner in your appliance can now handle messages that are not scanned due to the following reasons:

- File extraction failure
- RFC violation
- Decoding errors found during URL Filtering actions

You can configure any one of the following message handling actions on messages that are not scanned by the Content Scanner:

- Drop the message
- Deliver the message as it is
- Send the message to the policy quarantine

You can click on the **Edit Global Settings** button in the Security Services > Scan Behavior page of the web interface, to enable and configure message handling actions on messages that are not scanned by the Content Scanner.

Delivering the Message

You can perform the following additional actions, if you choose to deliver the message:

- Modify the message subject
- Add a custom header to the message
- Modify the message recipient
- Send message to alternate destination host



Note These actions are not mutually exclusive; you can combine some or all of them differently within different incoming or outgoing policies for different processing needs for groups of users.

Modifying Message Subject

You can alter the text of messages that are not scanned by the Content Scanner by prepending or appending certain text strings to help users easily identify and sort identified messages.



Note White space is not ignored in the “Modify message subject” field. Add spaces after (if prepending) or before (if appending) the text you enter in this field to separate your added text from the original subject of the message. For example, add the text [WARNING: UNSCANNABLE EXTRACTION FAILURE] with a few trailing spaces if you are prepending.

The default text that is added to the subject of the message that is not scanned by the Content Scanner:

Reason	Default Text Added to Subject
Extraction failure	[WARNING: UNSCANNABLE EXTRACTION FAILED]
RFC Violation	[WARNING: UNSCANNABLE RFC NON-COMPLIANT]
Decoding errors found during URL Filtering actions	[WARNING: DECODING ERRORS WHEN APPLYING URL FILTERING ACTIONS]

Adding Custom Header to Message

You can define an additional, custom header to add to all messages that are not scanned by the Content Scanner. Click **Yes** and define the header name and text.

Modifying Message Recipient

You can modify the message recipient, causing the message that is not scanned by the Content Scanner to be delivered to a different address. Click **Yes** and enter the new recipient address.

Sending Message to Alternate Destination Host

You can choose to send the notification to a different recipient or destination host for messages that are not scanned by the Content Scanner. Click **Yes** and enter an alternate address or host.

For example, you can route messages that are not scanned by the Content Scanner to an administrator's mailbox or a special mail server for subsequent examination. In the case of a multi-recipient message, only a single copy is sent to the alternative recipient.

Sending Message to Policy Quarantine

When flagged for quarantine, the message that is not scanned by the Content Scanner continues through the rest of the email pipeline. When the message reaches the end of the pipeline, if the message has been flagged for one or more quarantines then it enters those queues. Note that if the message does not reach the end of the pipeline, it is not placed in a quarantine.

For example, a content filter can cause a message to be dropped or bounced, in which case the message will not be quarantined.



Note If a policy quarantine is not defined in your appliance, you cannot send the message to the quarantine.

You can perform the following additional actions, if you choose to send the message to the policy quarantine:

- Modify the message subject
- Add a custom header to the message

Modifying Message Subject Header

You can alter the text of messages that are sent to the policy quarantine by prepending or appending certain text strings to help users easily identify and sort identified messages.



Note White space is not ignored in the "Modify message subject" field. Add spaces after (if prepending) or before (if appending) the text you enter in this field to separate your added text from the original subject of the message. For example, add the text [WARNING: UNSCANNABLE EXTRACTION FAILURE] with a few trailing spaces if you are prepending.

The default text that is added to the subject of the message that is sent to the policy quarantine:

Reason	Default Text Added to Subject
Extraction failure	[WARNING: UNSCANNABLE EXTRACTION FAILED]
RFC Violation	[WARNING: UNSCANNABLE RFC NON-COMPLIANT]
Decoding errors found during URL Filtering actions	[WARNING: DECODING ERRORS WHEN APPLYING URL FILTERING ACTIONS]

Adding Custom Header to Message

You can define an additional, custom header to add to all messages that are sent to the policy quarantine. Click **Yes** and define the header name and text.



CHAPTER 10

Mail Policies

This chapter contains the following sections:

- [Overview of Mail Policies, on page 257](#)
- [How to Enforce Mail Policies on a Per-User Basis, on page 258](#)
- [Handling Incoming and Outgoing Messages Differently, on page 259](#)
- [Matching Users to a Mail Policy, on page 259](#)
- [Message Splintering, on page 261](#)
- [Configuring Mail Policies, on page 263](#)
- [Setting Priority for Message Headers, on page 268](#)

Overview of Mail Policies

The appliance enforces your organization's policies for messages sent to and from your users through the use of mail policies. These are sets of rules that specify the types of suspect, sensitive, or malicious content that your organization may not want entering or leaving your network. This content may include:

- spam
- legitimate marketing messages
- graymail
- viruses
- phishing and other targeted mail attacks
- confidential corporate data
- personally identifiable information

You can create multiple policies that satisfy the disparate security needs of the different user groups within your organization. The appliance uses the rules defined in these policies to scan each message and, if necessary, perform an action to protect your user. For example, policies can prevent the delivery of suspected spam messages to executives while allowing their delivery to IT staff but with a modified subject to warn them of the content, or drop dangerous executable attachments for all users except those in the System Administrator group.

How to Enforce Mail Policies on a Per-User Basis

Procedure

	Command or Action	Purpose
Step 1	Enable the content-scanning features that you want the appliance to use for incoming or outgoing messages.	The features you can enable and configure one or more of the following: <ul style="list-style-type: none"> • Anti-Virus, on page 341 • File Reputation Filtering and File Analysis, on page 457 (incoming messages only) • Managing Spam and Graymail, on page 359 • Graymail Detection and Safe Unsubscribe. See Managing Spam and Graymail, on page 359. • Outbreak Filters, on page 401 • Data Loss Prevention, on page 485 (outgoing messages only) • Content Filters, on page 271
Step 2	(Optional) Create content filters for actions to take on messages that contain specific data.	See Content Filters, on page 271
Step 3	(Optional) Define an LDAP group query in order to specify users to whom the mail policy rules apply.	See Using Group LDAP Queries to Determine if a Recipient is a Group Member, on page 770 .
Step 4	(Optional) Define the default mail policies for incoming or outgoing messages.	See Configuring the Default Mail Policy for Incoming or Outgoing Messages, on page 263 .
Step 5	Define the group of users for whom you want to set up user-specific mail policies.	Create an incoming or outgoing mail policy. See Configuring Mail Policies, on page 263 for more information.
Step 6	Configure the content security features and the content filter actions the appliance takes on messages.	Configure the different content security features for the mail policy. <ul style="list-style-type: none"> • Content Filters: Applying the Content Filter to Messages for a Certain User Group, on page 291 • Anti-Virus: Configuring Virus Scanning Actions for Users, on page 347 • File Reputation Filtering and File Analysis: File Reputation Filtering and File Analysis, on page 457 • Anti-Spam: Defining Anti-Spam Policies, on page 376

	Command or Action	Purpose
		<ul style="list-style-type: none"> • Graymail Detection and Safe Unsubscribe: Configuring the Incoming Mail Policy for Graymail Detection and Safe Unsubscribing, on page 371 • Outbreak Filters: The Outbreak Filters Feature and the Outbreak Quarantine, on page 419 • Data Loss Prevention: Using Outgoing Mail Policies to Assign DLP Policies to Senders and Recipients, on page 505.

Handling Incoming and Outgoing Messages Differently

The appliance uses two different sets of mail policies for message content security:

- *Incoming mail policies* for messages are messages received from connections that match an ACCEPT HAT policy in any listener.
- *Outgoing mail policies* for messages are messages from connections that match a RELAY HAT policy in any listener. This includes any connection that was authenticated with SMTP AUTH.

Having separate sets of policies allow you to define different security rules for messages sent to your users and messages sent from your users. You manage these policies using the **Mail Policies > Incoming Mail Policies** or **Outgoing Mail Policies** pages in the GUI, or the `policyconfig` command in the CLI.



Note

Some features can be applied only to incoming or to outgoing mail policies. For example, Data Loss Prevention scanning can only be performed on outgoing messages. Advanced Malware Protection (File Reputation scanning and File Analysis) is available in Incoming Mail Policies and Outgoing Mail Policies.

In certain installations, “internal” mail being routed through the Cisco appliance may be considered *outgoing*, even if all the recipients are addressed to internal addresses. For example, by default for C170 and C190 appliances, the system setup wizard will configure only one physical Ethernet port with one listener for receiving inbound email and relaying outbound email.

Matching Users to a Mail Policy

As messages are received by the appliance, the appliance attempts to match each message recipient and sender to a mail policy in the Incoming or Outgoing Mail Policies table, depending on whether it is an incoming or outgoing message.

Matches are based on the recipient’s address, the sender’s address, or both:

- *Recipient address* matches the Envelope Recipient address

When matching recipient addresses, the recipient addresses entered are the final addresses after processing by preceding parts of the email pipeline. For example, if enabled, the default domain, LDAP routing or masquerading, alias table, domain map, and message filters features can rewrite the Envelope Recipient address and may affect whether the message matches a mail policy.

- *Sender address* matches:
 - Envelope Sender (RFC821 MAIL FROM address)
 - Address found in the RFC822 From: header
 - Address found in the RFC822 Reply-To: header

Addresses may be matched on either a full email address, user, domain, or partial domain, and addresses may also match LDAP group membership.

Related Topics

- [First Match Wins, on page 260](#)
- [Examples of Policy Matching, on page 260](#)

First Match Wins

Each user (sender or recipient) is evaluated for each mail policy defined the appropriate mail policy table in a top-down fashion.

For each user, the first matching policy wins. If a user does not match any specific policy, user will automatically match the default policy of the table.

If a match is made based on a sender address, all remaining recipients of a message will match that policy. (This is because there can be only one sender per message.)

The envelope sender and the envelope recipient have a higher priority over the sender header when you match a message to a mail policy. If you configure a mail policy to match a specific user, the messages are automatically classified into the mail policy based on the envelope sender and the envelope recipient.

Examples of Policy Matching

The following examples help show how the policy tables are matched in a top-down fashion.

Given the following Incoming Mail Email Security Policy table shown in the following table, incoming messages will match different policies.

Table 30: Policy Matching Example

Order	Policy Name	Users	
		Sender	Recipient
1	special_people	ANY	joe@example.com ann@example.com
2	from_lawyers	@lawfirm.com	ANY
3	acquired_domains	ANY	@newdomain.com @anotherexample.com
4	engineering	ANY	PublicLDAP.ldapgroup: engineers

Order	Policy Name	Users	
5	sales_team	ANY	jim@john@larry@
6	Default Policy	ANY	ANY

Related Topics

- [Example 1, on page 261](#)
- [Example 2, on page 261](#)
- [Example 3, on page 261](#)

Example 1

A message from sender `bill@lawfirm.com` sent to recipient `jim@example.com` matches:

- Policy #2 when the user description matches the sender (`@lawfirm.com`) and the recipient (`ANY`).
- Policy #2 when the envelope sender is `bill@lawfirm.com`.
- Policy #5 when the header sender is `bill@lawfirm.com` but the envelope sender does not match `@lawfirm.com`.

Example 2

Sender `joe@yahoo.com` sends an incoming message with three recipients: `john@example.com`, `jane@newdomain.com`, and `bill@example.com` :

- The message for recipient `jane@newdomain.com` will receive the anti-spam, anti-virus, outbreak filters, and content filters defined in policy #3.
- The message for recipient `john@example.com` will receive the settings defined in policy #5.
- Because the recipient `bill@example.com` does not match the engineering LDAP query, the message will receive the settings defined by the default policy.

This example shows how messages with multiple recipients can incur *message splintering* . See [Message Splintering, on page 261](#) for more information.

Example 3

Sender `bill@lawfirm.com` (`bill@lawfirm.com` is used for envelope sender) sends a message to recipients `ann@example.com` and `larry@example.com` :

- The recipient `ann@example.com` will receive the anti-spam, anti-virus, outbreak filters, and content filters defined in policy #1.
- The recipient `larry@example.com` will receive the anti-spam, anti-virus, outbreak filters, and content filters defined in policy #2, because the sender (`@lawfirm.com`) and the recipient (`ANY`) matches.

Message Splintering

Intelligent message splintering is the mechanism that allows for differing recipient-based content security rules to be applied independently to message with multiple recipients.

Each recipient is evaluated for each policy in the appropriate mail policy table (Incoming or Outgoing) in a top-down fashion.

Each policy that matches a message creates a new message with those recipients. This process is defined as *message splintering* :

- If some recipients match different policies, the recipients are grouped according to the policies they matched, the message is split into a number of messages equal to the number of policies that matched, and the recipients are set to each appropriate “splinter.”
- If all recipients match the same policy, the message is not splintered. Conversely, a maximum splintering scenario would be one in which a single message is splintered for each message recipient.
- Each message splinter is then processed by anti-spam, anti-virus, Advanced Malware Protection (incoming messages only), DLP scanning (outgoing messages only), Outbreak Filters, and content filters independently in the email pipeline.

The following table illustrates the point at which messages are splintered in the email pipeline.

Work Queue	Message Filters (filters)	Email Security Manager Scanning (Per Recipient)	↓ Message for all recipients
	Anti-Spam (<code>antispamconfig</code> , <code>antispamupdate</code>)		Messages are splintered immediately <i>after</i> message filter processing but <i>before</i> anti-spam processing:
	Anti-Virus (<code>antivirusconfig</code> , <code>antivirusupdate</code>)		Message for all recipients matching policy 1
	File Reputation and Analysis (Advanced Malware Protection) (<code>ampconfig</code>)		Message for all recipients matching policy 2
	Graymail Management		Message for all other recipients (matching the default policy)
	Content Filters (<code>policyconfig -> filters</code>)		Note DLP scanning is only performed on outgoing messages.
	Outbreak Filters (<code>outbreakconfig</code> , <code>outbreakflush</code> , <code>outbreakstatus</code> , <code>outbreakupdate</code>)		
	Data Loss Prevention (<code>policyconfig</code>)		



Note New MIDs (message IDs) are created for each message splinter (for example, MID 1 becomes MID 2 and MID 3). For more information, see the “Logging” chapter. In addition, the `trace` function shows which policies cause a message to be split.

Policy matching and message splintering in Email Security Manager policies obviously affect how you manage the message processing available on the appliance .

Related Topics

- [Managed Exceptions, on page 263](#)

Managed Exceptions

Because the iterative processing of each splinter message impacts performance, Cisco recommends configuring your content security rules on a *managed exception* basis. In other words, evaluate your organization's needs and try to configure the feature so that the majority of messages will be handled by the default mail policy and the minority of messages will be handled by a few additional "exception" policies. In this manner, message splintering will be minimized and you are less likely to impact system performance from the processing of each splinter message in the work queue.

Configuring Mail Policies

Mail policies map different user groups to specific security settings, such as Anti-Spam or Anti-Virus.

Related Topics

- [Configuring the Default Mail Policy for Incoming or Outgoing Messages , on page 263](#)
- [Creating a Mail Policy for a Group of Senders and Recipients, on page 264](#)
- [Finding Which Policies Apply to a Sender or Recipient, on page 267](#)

Configuring the Default Mail Policy for Incoming or Outgoing Messages

The default mail policies apply to messages that are not covered by any other mail policy. If no other policies are configured, the default policies apply to all messages.

Before You Begin

Understand how you can define the individual security services for the mail policy. See [How to Enforce Mail Policies on a Per-User Basis, on page 258](#).

Procedure

-
- Step 1** Depending on your requirements, choose one of the following:
- **Mail Policies > Incoming Mail Policies**
 - **Mail Policies > Outgoing Mail Policies.**
- Step 2** Click the link for the security service you want to configure for the Default mail policy.
- Note** For default security service settings, the first setting on the page defines whether the service is enabled for the policy. You can click "Disable" to disable the service altogether.
- Step 3** Configure the settings for the security service.
- Step 4** Click **Submit**.

Step 5 Submit and commit your changes.

Creating a Mail Policy for a Group of Senders and Recipients

Before You Begin

- Understand how you can define the individual security services for the mail policy. See [How to Enforce Mail Policies on a Per-User Basis, on page 258](#).
- Remember that each recipient is evaluated for each policy in the appropriate table (incoming or outgoing) in a top-down fashion. See [First Match Wins, on page 260](#) for more information.
- (Optional) Define the delegated administrators who will be responsible for managing the mail policy. Delegated administrators can edit a policy's Anti-Spam, Anti-Virus, Advanced Malware Protection, and Outbreak Filters settings and enable or disable content filters for the policy. Only operators and administrators can modify a mail policy's name or its senders, recipients, or groups. Custom user roles that have full access to mail policies are automatically assigned to mail policies.

Procedure

- Step 1** Choose **Mail Policies > Incoming Mail Policies** or **Mail Policies > Outgoing Mail Policies**.
- Step 2** Click **Add Policy**.
- Step 3** Enter a name for the mail policy.
- Step 4** (Optional) Click the Editable by (Roles) link and select the custom user roles for the delegated administrators who will be responsible for managing the mail policy.
- Step 5** Define users for the policy. For instructions to define users, see [Defining Senders and Recipients for Mail Policies, on page 264](#).
- Step 6** Click **Submit**.
- Step 7** Click the link for the content security service you want to configure for the mail policy.
- Step 8** From the drop-down list, select the option to customize the settings for the policy instead of using the default settings.
- Step 9** Customize the security service settings.
- Step 10** Submit and commit your changes.
-

What to do next

Related Topics

- [Defining Senders and Recipients for Mail Policies, on page 264](#)
- [How to Configure the Appliance to Scan Messages for Spam, on page 360](#)

Defining Senders and Recipients for Mail Policies

You can define senders and recipients to whom the policy applies in the following ways:

- Full email address: `user@example.com`
- Partial email address: `user@`

- All users in a domain: @example.com
- All users in a partial domain: @.example.com
- By matching an LDAP Query



Note Entries for users are case-insensitive in both the GUI and CLI in AsyncOS. For example, if you enter the recipient `Joe@` for a user, a message sent to `joe@example.com` will match.

While defining senders and recipients for mail policies, keep in mind that:

- You must specify at least one sender and recipient.
- You can set the policy to match if,
 - The message is from any sender, one or more of the specified senders, or none of the specified senders.
 - The message is sent to any recipient, one or more of the specified recipients, or all of the specified recipients and none of the specified recipients.

Procedure

Step 1 Under **Users** section, click **Add User**.

Step 2 Define the senders for the policy. Choose one of the following options:

- **Any Sender**. The policy is matched if the message is from any sender.
- **Following Senders**. The policy is matched if the message is from one or more of the specified senders. Select this option and enter sender details in the text box or choose an LDAP group query.
- **Following Senders are Not**. The policy is matched if the message is not from none of the specified senders. Select this option and enter sender details in the text box or choose an LDAP group query.

To understand how sender conditions are set while choosing the above fields, see [Examples, on page 266](#).

Step 3 Define the recipients for the policy. Choose one of the following options:

- **Any Recipient**. The policy is matched if the message is sent to any recipient.
- **Following Recipients**. The policy is matched if the message is sent to the specified recipients. Select this option, enter the recipient details in the text box or choose an LDAP group query.

You can choose whether policy is matched if the message is sent to one or more of the specified recipients or all of the specified recipients. Choose one of the following options from the drop-down list: **If one more conditions match** or **Only if all conditions match**.

- **Following Recipients are Not**. The policy is matched if the message is sent to none of the specified recipients. Select this option, enter the recipient details in the text box or choose an LDAP group query.

Note You can configure this option only if you have selected **Following Recipients** and chosen **Only if all conditions match** from the drop-down list.

To understand how recipient conditions are set while choosing the above fields, see [Examples, on page 266](#).

Step 4 Click **Submit**.

Step 5 Review the selected conditions on the **Users** section.

What to do next

Related Topics

- [Creating a Mail Policy for a Group of Senders and Recipients, on page 264](#)
- [Examples, on page 266](#)

Examples

The following table describes how conditions are set when you choose various options on the Add User page.

Sender			Recipient			Condition
Any Sender	Following Senders	Following Senders are Not	Any Recipient	Following Recipients	Following Recipients are Not	
Selected	-	-	-	Selected (Default) Only if all conditions match option is selected Values: user1@, user2@	-	Sender: Any Recipient: user1@[AND]user2@
-	Selected Values: u1@a.com, u2@a.com	-	-	Selected (Default) Only if all conditions match option is selected Values: u1@b.com, u2@b.com	Selected Values: u3@b.com, u4@b.com	Sender: u1@a.com[OR]u2@a.com Recipient: [u1@b.com[AND]u2@b.com] [AND] [[NOT] [u3@b.com[AND]u4@b.com]]

-	-	Selected Values: u1@a.com, u2@a.com	-	Selected If one or more conditions match option is also selected Values: u1@b.com, u2@b.com	-	Sender: [NOT] [u1@a.com[OR]u2@a.com] Recipient: u1@b.com [OR] u2@b.com
---	---	--	---	--	---	--

Related Topics

- [Defining Senders and Recipients for Mail Policies, on page 264](#)

Finding Which Policies Apply to a Sender or Recipient

Use the Find Policies section at the top of the Mail Policies page to search for users already defined in incoming or outgoing mail policies.

For example, type bob@example.com and click the Find Policies button to display results showing which policies contain defined users that will match the policy.

Click the name of the policy to edit the users for that policy.

Note that the default policy will always be shown when you search for any user, because, by definition, if a sender or recipient does not match any other configured policies, it will *always* match the default policy.

Related Topics

- [Managed Exceptions, on page 263](#)

Managed Exceptions

Using the steps shown in the two examples above, you can begin to create and configure policies on a *managed exception* basis. In other words, after evaluating your organization's needs you can configure policies so that the majority of messages will be handled by the default policy. You can then create additional "exception" policies for specific users or user groups, managing the differing policies as needed. In this manner, message splintering will be minimized and you are less likely to impact system performance from the processing of each splinter message in the work queue.

You can define policies based on your organizations' or users' tolerance for spam, viruses, and policy enforcement. The following table outlines several example policies. "Aggressive" policies are designed to minimize the amount of spam and viruses that reach end-users mailboxes. "Conservative" policies are tailored to avoid false positives and prevent users from missing messages, regardless of policies.

Table 31: Aggressive and Conservative Email Security Manager Settings

	Aggressive Settings	Conservative Settings
Anti-Spam	Positively identified spam: Drop Suspected spam: Quarantine Marketing mail: Deliver and prepend “[Marketing]” to the subject messages	Positively identified spam: Quarantine Suspected spam: Deliver and prepend “[Suspected Spam]” to the subject of messages Marketing mail: Disabled
Anti-Virus	Repaired messages: Deliver Encrypted messages: Drop Unscannable messages: Drop Infectious messages: Drop	Repaired messages: Deliver Encrypted messages: Quarantine Unscannable messages: Quarantine Infectious messages: Drop
Advanced Malware Protection (File Reputation Filtering and File Analysis)	Unscanned attachments: Drop Messages with Malware Attachments: Drop Messages with pending File Analysis: Quarantine	Unscanned attachments: Deliver and prepend “[WARNING: ATTACHMENT UNSCANNED]” to the subject of messages. Messages with Malware Attachments: Drop Messages with pending File Analysis: Deliver and prepend “[WARNING: ATTACHMENT(S) MAY CONTAIN MALWARE]” to the subject of messages.
Virus Filters	Enabled, no specific filename extensions or domains allowed to bypass Enable message modification for all messages	Enabled with specific filename extensions or domains allowed to bypass Enable message modification for unsigned messages

Setting Priority for Message Headers

You can set the priority for a message header to match the incoming and outgoing messages in your appliance.



Important

You can set the priority in which the appliance checks for message headers in the incoming and outgoing messages. The appliance first checks for the message header with the highest priority for all the mail policies. If there is no header match in any of the mail policies, the appliance looks for the next message header in the priority list for all the mail policies. If none of the message headers match in any of the mail policies, the default mail policy settings are used.

Procedure

Step 1 Go to **Mail Policies > Mail Policy Settings**.

By default, the Envelope Sender header is set to a priority 1. You can click on the Envelope Sender link to change the priority.

- Step 2** Click **Add Priority** and check the appropriate header name (for example, Header “From”) check box to add a new priority.
- Step 3** Click **Submit** and commit your changes.
-



CHAPTER 11

Content Filters

This chapter contains the following sections:

- [Overview of Content Filters](#) , on page 271
- [How Content Filters Work](#), on page 271
- [Content Filter Conditions](#), on page 272
- [Content Filter Actions](#), on page 280
- [How to Filter Messages Based on Content](#), on page 289

Overview of Content Filters

Use content filters to customize handling of messages beyond the standard routine handling by the other content security features such as anti-virus scanning or DLP. For example, you can use a content filter if the content warrants quarantining for later examination, or because corporate policy requires certain messages to be encrypted before delivery.

How Content Filters Work

Content filters are similar to message filters, except that they are applied later in the email pipeline — after message filtering, after a message has been “splintered” into a number of separate messages for each matching mail policy, (see [Message Splintering](#), on page 261 for more information), and after the message has undergone anti-spam and anti-virus scanning.

A content filter scans either incoming or outgoing messages. You cannot define a filter that scans both types of messages. The appliance has a separate “primary list” of content filters for each type of message. The primary list also determines in which order the appliance runs the content filters. However, each individual mail policy determines which particular filters will be executed when a message matches the policy.

Content filters scan messages on a per-user (sender or recipient) basis.

Content filters have the following components:

- *conditions* that determine when the appliance uses a content filter to scan a message (optional)
- *actions* that the appliance takes on a message (required)
- *action variables* that the appliance can add to a message when modifying it (optional)

Related Topics

- [How to Scan Message Content Using a Content Filter, on page 272](#)
- [Content Filter Conditions, on page 272](#)
- [Content Filter Actions, on page 280](#)
- [Action Variables, on page 287](#)

How to Scan Message Content Using a Content Filter

Procedure

	Command or Action	Purpose
Step 1	(Optional) Define the supporting features for the content filter.	Create any of the following items that you want to use with your content filter: <ul style="list-style-type: none"> • Encryption Profile • Disclaimer template • Notification template • Policy quarantine • URL allowed lists
Step 2	Define the incoming or outgoing content filter.	A content filter may be comprised of: <ul style="list-style-type: none"> • Content Filter Conditions, on page 272 (optional) • Content Filter Actions, on page 280 • Action Variables, on page 287 (optional) Creating a Content Filter, on page 289
Step 3	Define the group of users for whom you want to set up content security rules.	Create an incoming or outgoing mail policy.
Step 4	Assign the content filter to the group of user whose incoming or outgoing messages you want to use the filter for.	See Mail Policies, on page 257

Content Filter Conditions

A condition is a “trigger” that determines whether the appliance uses the filter on a message that matches the associated mail policy. Specifying conditions for a content filter is optional. Content filters without a condition are applied to all messages that match the associated mail policy.

In the content filter conditions, when you add filter rules that search for certain patterns in the message body or attachments, you can specify the minimum threshold for the number of times the pattern must be found. When AsyncOS scans the message, it totals the “score” for the number of matches it finds in the message and attachments. If the minimum threshold is not met, the regular expression does not evaluate to true. You can specify this threshold for text, smart identifiers, or content dictionary terms.

Multiple conditions may be defined for each filter. When multiple conditions are defined, you can choose whether the conditions are tied together as a logical OR (“Any of the following conditions...”) or a logical AND (“All of the following conditions”).

Table 32: Content Filter Conditions

Condition	Description
(no conditions)	Specifying conditions in content filters is optional. If no conditions are specified, a true rule is implied. The true rule matches all messages, and the actions are always performed.
Message Body or Attachments	<p>Contains text: Does the message body contain text or an attachment that matches a specific pattern?</p> <p>Contains smart identifier: Does content in the message body or attachment match a smart identifier?</p> <p>Contains term in content dictionary: Does the message body contain any of the regular expressions or terms in the content dictionary named <i><dictionary name></i>?</p> <p>For this option to be enabled, the dictionary must already have been created. See Content Dictionaries, on page 619.</p> <p>Note The dictionary-related conditions are only available if you have one or more dictionaries enabled. For information about creating content dictionaries, see Content Dictionaries, on page 619.</p> <p>Number of matches required. Specify the number of matches required for the rule to evaluate to true. You can specify this threshold for text, smart identifiers, or content dictionary terms.</p> <p>This includes delivery-status parts and associated attachments.</p>

Condition	Description
Message Body	<p>Contains text: Does the message body contain text that matches a specific pattern?</p> <p>Contains smart identifier: Does content in the message body match a smart identifier? Smart identifiers can detect the following patterns:</p> <ul style="list-style-type: none"> • Credit card numbers • U.S. Social Security numbers • CUSIP (Committee on Uniform Security Identification Procedures) numbers • ABA (American Banking Association) routing numbers <p>Contains term in content dictionary: Does the message body contain any of the regular expressions or terms in the content dictionary named <i><dictionary name></i>?</p> <p>For this option to be enabled, the dictionary must already have been created. See Content Dictionaries, on page 619.</p> <p>Note The dictionary-related conditions are only available if you have one or more dictionaries enabled. For information about creating content dictionaries, see Content Dictionaries, on page 619.</p> <p>Number of matches required. Specify the number of matches required for the rule to evaluate to true. You can specify this threshold for text or smart identifiers.</p> <p>This rule applies to the body of the message only. It does not include attachments or headers.</p>
URL Category	See Filtering by URL Reputation or URL Category: Conditions and Rules , on page 433 and About URL Categories, on page 443 .
Message Size	Is the body size within a specified range? Body size refers to the size of the message, including both headers and attachments. The body-size rule selects those messages where the body size compares as directed to a specified number.
Macro Detection	Does the incoming or outgoing message contain macro-enabled attachments? You can use the Macro Detection condition to detect macro-enabled attachments in messages for the selected file type(s).

Condition	Description
Attachment Content	<p>Contains text. Does the message contain an attachment that contains text or another attachment that matches a specific pattern? This rule is similar to the <code>body-contains()</code> rule, but it attempts to avoid scanning the entire “body” of the message. That is, it attempts to scan only that which the user would view as being an attachment.</p> <p>Contains a smart identifier. Does content in the message attachment match the specified smart identifier?</p> <p>Contains terms in content dictionary. Does the attachment contain any of the regular expressions or terms in the content dictionary named <code><dictionary name></code>?</p> <p>To search for dictionary terms, the dictionary must already have been created. See Content Dictionaries, on page 619.</p> <p>Note The dictionary-related conditions are only available if you have one or more dictionaries enabled. For information about creating content dictionaries, see Content Dictionaries, on page 619.</p> <p>Number of matches required. Specify the number of matches required for the rule to evaluate to true. You can specify this threshold for text, smart identifier, or content dictionary matches.</p>

Condition	Description
Attachment File Info	<p>Filename. Does the message have an attachment with a filename that matches a specific pattern?</p> <p>Filename contains term in content dictionary. Does the message have an attachment with a filename that contains any of the regular expressions or terms in the content dictionary named <i><dictionary name></i> ?</p> <p>For this option to be enabled, the dictionary must already have been created. See Content Dictionaries, on page 619.</p> <p>Note The dictionary-related conditions are only available if you have one or more dictionaries enabled. For information about creating content dictionaries, see Content Dictionaries, on page 619.</p> <p>File type. Does the message have an attachment of a file type that matches a specific pattern based on its fingerprint (similar to a UNIX file command)?</p> <p>MIME type. Does the message have an attachment of a specific MIME type? This rule is similar to the attachment-type rule, except only the MIME type given by the MIME attachment is evaluated. (The appliance does not try to “guess” the type of the file by its extension if there is no explicit type given.)</p> <p>Image Analysis. Does the message have an image attachment that matches the image verdict specified? Valid image analysis verdicts include: <i>Suspect, Inappropriate, Suspect or Inappropriate, Unscannable</i> , or <i>Clean</i>.</p> <p>External Threat Feeds: Does the file match the threat information from the selected external threat feed source(s)?</p> <p>Select a File Hash Exception List: (Optional) Select the list of allow listed file hashes that you do not want the appliance to detect for threats.</p> <p>For more information, see Configuring Email Gateway to Consume External Threat Feeds, on page 295.</p> <p>Attachment is Corrupt. Does this message have an attachment that is corrupt?</p> <p>Note A corrupt attachment is an attachment that the scanning engine cannot scan and identified as corrupt.</p>
Attachment Protection	<p>Contains an attachment that is password-protected or encrypted.</p> <p>(For example, use this condition to identify attachments that are potentially unscannable.)</p> <p>Contains an attachment that is NOT password-protected or encrypted.</p>
Subject Header	<p>Subject Header: Does the subject header match a certain pattern?</p> <p>Contains terms in content dictionary: Does the subject header contain any of the regular expressions or terms in the content dictionary <i><dictionary name></i> ?</p> <p>To search for dictionary terms, the dictionary must already have been created. See Content Dictionaries, on page 619.</p> <p>Note The dictionary-related conditions are only available if you have one or more dictionaries enabled. For information about creating content dictionaries, see Content Dictionaries, on page 619.</p>

Condition	Description
Other Header	<p>Header name: Does the message contain a specific header?</p> <p>Header value: Does the value of that header match a certain pattern?</p> <p>Header value contains terms in the content dictionary. Does the specified header contain any of the regular expressions or terms in the content dictionary named <i><dictionary name></i> ?</p> <p>To search for dictionary terms, the dictionary must already have been created. See Content Dictionaries, on page 619</p> <p>Note The dictionary-related conditions are only available if you have one or more dictionaries enabled. For information about creating content dictionaries, see Content Dictionaries, on page 619.</p> <p>For an example showing how this option can be used, see Using Custom Headers to Redirect URLs in Suspected Spam to the Cisco Web Security Proxy: Configuration Example , on page 380.</p>
Envelope Sender	<p>Envelope Sender. Does the Envelope Sender (i.e., the Envelope From, <MAIL FROM>) match a given pattern?</p> <p>Matches LDAP group. Is the Envelope Sender, i.e., the Envelope From, <MAIL FROM>) in a given LDAP group?</p> <p>Contains term in content dictionary. Does the envelope sender contain any of the regular expressions or terms in the content dictionary named <i><dictionary name></i> ?</p> <p>To search for dictionary terms, the dictionary must already have been created. See Content Dictionaries, on page 619.</p> <p>Note The dictionary-related conditions are only available if you have one or more dictionaries enabled. For information about creating content dictionaries, see Content Dictionaries, on page 619.</p>

Condition	Description
Envelope Recipient	<p>Envelope Recipient. Does the Envelope Recipient, (i.e. the Envelope To, <RCPT TO>) match a given pattern?</p> <p>Matches LDAP group. Is the Envelope Recipient, (i.e. the Envelope To, <RCPT TO>) in a given LDAP group?</p> <p>Contains term in content dictionary. Does the envelope recipient contain any of the regular expressions or terms in the content dictionary named <i><dictionary name></i> ?</p> <p>To search for dictionary terms, the dictionary must already have been created. See Content Dictionaries, on page 619.</p> <p>Note The dictionary-related conditions are only available if you have one or more dictionaries enabled. For information about creating content dictionaries, see Content Dictionaries, on page 619.</p> <p> The Envelope Recipient rule is message-based. If a message has multiple recipients, only one recipient has to be found in a group for the specified action to affect the message to all recipients.</p> <p>Is the Envelope Sender (i.e., the Envelope From, <MAIL FROM>) in a given LDAP group?</p>
Receiving Listener	Did the message arrive via the named listener? The listener name must be the name of a listener currently configured on the system.
Remote IP	Was the message sent from a remote host that matches a given IP address or IP block? The Remote IP rule tests to see if the IP address of the host that sent that message matches a certain pattern. This can be an Internet Protocol version 4 (IPv4) or version 6 (IPv6) address. The IP address pattern is specified using the allowed hosts notation described in Sender Group Syntax, on page 95 , except for the SBO, IPR, dnslist notations and the special keyword ALL.
Reputation Score	What is the sender's IP Reputation Score? The Reputation Score rule checks the IP Reputation Score against another value.
DKIM Authentication	Did DKIM authentication pass, partially verify, return temporarily unverifiable, permanently fail, or were no DKIM results returned?

Condition	Description
Forged Email Detection	<p>Is the sender address of the message forged? The rule checks if the From: header in the message is similar to any of the users in the content dictionary.</p> <p>Select a content dictionary and enter the threshold value (1 through 100) for considering a message as potentially forged.</p> <p>The Forged Email Detection condition compares the From: header with the users in the content dictionary. During this process, depending on the similarity, the appliance assigns similarity score to each of the users in the dictionary. The following are some examples:</p> <ul style="list-style-type: none"> • If the From: header is <john.simons@example.com> and the content dictionary contains a user 'John Simons,' the appliance assigns a similarity score of 82 to the user. • If the From: header is <john.simons@diff-example.com> and the content dictionary contains a user 'John Simons,' the appliance assigns a similarity score of 100 to the user. <p>The higher the similarity score, the higher the probability that the message is forged. If the similarity score is greater than or equal to the specified threshold value, the filter action is triggered.</p> <p>If you want to skip the Forged email detection filter for messages from specific senders, choose the address list from the Exception List drop-down list.</p> <p>Note You can choose only the address lists that are created using the full email addresses. For more information, refer to Using a List of Sender Addresses for Incoming Connection Rules, on page 114.</p> <p>For more information, see Forged Email Detection, on page 616.</p>
SPF Verification	<p>What was the SPF verification status? This filter rule allows you to query for different SPF verification results. For more information about SPF verification, see the "Email Authentication" chapter.</p> <p>Note If you have configured an SPF verification content filter condition without an SPF identity and if a message contains different SPF identities with different verdicts, the condition is triggered if one of the verdicts in the message matches the condition.</p>
S/MIME Gateway Message	<p>Is the message S/MIME signed, encrypted, or signed and encrypted? For more information, see S/MIME Security Services, on page 529</p>
S/MIME Gateway Verified	<p>Is the S/MIME message successfully verified, decrypted, or decrypted and verified? For more information, see S/MIME Security Services, on page 529</p>

Condition	Description
Message Language	<p>Is the message (subject and body) in one of the selected languages? This condition will not check for the language in attachments and headers.</p> <p>How does language detection work?</p> <p>The appliance uses the built-in language detection engine to detect the language in a message. The appliance extracts the subject and the message body and passes it to the language detection engine.</p> <p>The language detection engine determines the probability of each language in the extracted text and passes it back to the appliance. The appliance considers the language with the highest probability as the language of the message. The appliance considers the language of the message as ‘undetermined’ in one of the following scenarios:</p> <ul style="list-style-type: none"> • If the detected language is not supported by appliance • If the appliance is unable to detect the language of the message • If the total size of the extracted text sent to the language detection engine is less than 50 bytes.
Duplicate Boundaries Verification	<p>Does the message contain duplicate MIME boundaries?</p> <p>If you want to take actions on messages that contain duplicate MIME boundaries, use this condition.</p> <p>Note Attachment-based conditions (for example, Attachment Content) or actions (for example, Strip Attachment by Content) will not work on malformed messages (with duplicate MIME boundaries).</p>
Geolocation	<p>Does the message originate from the selected countries?</p> <p>You can use the Geolocation condition to handle incoming messages from particular countries that you select.</p> <p>Note Enable the Anti-Spam engine on your appliance before you use the Geolocation content filter.</p>
Domain Reputation	<p>Does the sender domain match the specified criteria?</p> <ul style="list-style-type: none"> • Sender Domain Reputation • External Threat Feeds <p>For more information, see Configuring Email Gateway to Consume External Threat Feeds, on page 295 or Sender Domain Reputation Filtering, on page 313</p>

Content Filter Actions

The action is what the appliance does with a message that matches the content filter’s condition. Many different types of actions are available, including modifying the message, quarantining it, or dropping it. A “final action” performed on a message, delivering or dropping it, forces the Email Security appliance to perform the action immediately and forgo all further processing, such as Outbreak Filter or DLP scanning.

At least one action must be defined for each content filter.

Actions are performed in order on messages, so consider the order of actions when defining multiple actions for a content filter.

When you configure a quarantine action for messages that match Attachment Content conditions, Message Body or Attachment conditions, Message body conditions, or the Attachment content conditions, you can view the matched content in the quarantined message. When you display the message body, the matched content is highlighted in yellow. You can also use the `$MatchedContent` action variable to include the matched content in the message subject. For more information, see the Text Resources chapter.

Only one final action may be defined per filter, and the final action must be last action listed. Bounce, deliver, and drop are final actions. When entering actions for content filters, the GUI and CLI will force final actions to be placed last.

See also [Action Variables, on page 287](#).

Table 33: Content Filter Actions

Action	Description
Quarantine	<p>Quarantine. Flags the message to be held in one of the policy quarantine areas.</p> <p>Duplicate message: Sends a copy of the message to the specified quarantine and continues processing the original message. Any additional actions apply to the original message.</p>
Encrypt on Delivery	<p>The message continues to the next stage of processing. When all processing is complete, the message is encrypted and delivered.</p> <p>Encryption rule: Always encrypts the message or only encrypts it if an attempt to send it over a TLS connection first fails. See Using a TLS Connection as an Alternative to Encryption, on page 522 for more information.</p> <p>Encryption Profile. Once processing is complete, encrypts the message using the specified encryption profile, then delivers the message. This action is for use with a Cisco Encryption Appliance or a hosted key service.</p> <p>Subject. Subject for the encrypted message. By default, the value is <code>\$Subject</code>.</p>

Action	Description
Strip Attachment by Content	<p>Attachment contains. Drops all attachments on messages that contain the regular expression. Archive files (zip, tar) will be dropped if any of the files they contain match the regular expression pattern.</p> <p>Contains smart identifier. Drops all attachments on a message that contains the specified smart identifier.</p> <p>Attachment contains terms in the content dictionary. Does the attachment contain any of the regular expressions or terms in the content dictionary named <i><dictionary name></i> ?</p> <p>Number of matches required. Specify the number of matches required for the rule to evaluate to true. You can specify this threshold for text, smart identifier, or content dictionary matches.</p> <p>Replacement message. The optional comment serves as the means to modify the text used to replace the attachment that was dropped. Attachment footers simply append to the message.</p>

Action	Description
Strip Attachment by File Info	<p>File name. Drops all attachments on messages that have a filename that match the given regular expression. Archive file attachments (zip, tar) will be dropped if they contain a file that matches.</p> <p>File size. Drops all attachments on the message that, in raw encoded form, are equal to or greater than the size (in bytes) given. Note that for archive or compressed files, this action does not examine the uncompressed size, but rather the size of the actual attachment itself.</p> <p>File type. Drops all attachments on messages that match the given “fingerprint” of the file. Archive file attachments (zip, tar) will be dropped if they contain a file that matches.</p> <p>MIME type. Drops all attachments on messages that have a given MIME type.</p> <p>File Hash List. Drops all attachments on messages that match the file SHA-256 value in the selected file hash list. Select the required file hash list from the drop-down list.</p> <p>Note You can only select a file hash list that contains the SHA-256 file hash type.</p> <p>Image Analysis Verdict. Drops attachments for image attachments that match the image verdict specified. Valid image analysis verdicts include: <i>Suspect</i>, <i>Inappropriate</i>, <i>Suspect or Inappropriate</i>, <i>Unscannable</i> , or <i>Clean</i> .</p> <p>External Threat Feeds. Drops all message attachments on messages whose files are categorized as malicious by the ETF engine.</p> <p>Select a File Hash Exception List. (Optional) Select the list of allow listed file hashes that you do not want the Cisco Email Security Gateway to detect for threats.</p> <p>For more information, see Configuring Email Gateway to Consume External Threat Feeds, on page 295.</p> <p>Replacement message. The optional comment serves as the means to modify the text used to replace the attachment that was dropped. Attachment footers simply append to the message.</p>

Action	Description
Strip Attachment with Macro	<p>Drops all macro-enabled attachments of the specified file type.</p> <p>Note If an archive or embedded file contains macros, the parent file is dropped from the message.</p> <p>Custom Replacement Message (Optional): By default, a system generated message is added to the bottom of the message body when an attachment is dropped.</p> <p>The following is a sample system generated message when a macro-enabled attachment is dropped from the message:</p> <p>A MIME attachment of type <application/vnd.ms-excel> was removed here by a drop-macro-enabled-attachments filter rule on the host <mail.example.com>.</p> <p>The custom message that you enter in the Custom Replacement Message field replaces the system-generated message.</p>
URL Reputation	<p>See Modifying URLs in Messages: Using URL Reputation and URL Category Actions in Filters, on page 434 and Creating Allowed Lists for URL Filtering, on page 429.</p> <p>Use “No Score” to specify an action for URLs for which a reputation cannot be determined.</p> <p>Note The appliance considers a message signed if it is encrypted using S/MIME or it contains an S/MIME signature.</p>
URL Category	<p>See Modifying URLs in Messages: Using URL Reputation and URL Category Actions in Filters, on page 434 and About URL Categories, on page 443.</p> <p>Note The appliance considers a message signed if it is encrypted using S/MIME or it contains an S/MIME signature.</p>
Add Disclaimer Text	<p>Above. Add disclaimer above message (heading).</p> <p>Below. Add disclaimer below message (footer).</p> <p>Note: You must have already created disclaimer text in order to use this content filter action.</p> <p>See Disclaimer Template, on page 631 for more information.</p>
Bypass Outbreak Filter Scanning	Bypass Outbreak Filter scanning for this message.
Bypass DKIM Signing	Bypass DKIM signing for this message.
Send Copy (Bcc:)	<p>Email addresses. Copies the message anonymously to the specified recipients.</p> <p>Subject. Add a subject for the copied message.</p> <p>Return path (optional). Specify a return path.</p> <p>Alternate mail host (optional). Specify an alternate mail host.</p>

Action	Description
Notify	<p>Notify. Reports this message to the specified recipients. You can optionally notify the sender and recipients.</p> <p>Subject. Add a subject for the copied message.</p> <p>Return path (optional). Specify a return path.</p> <p>Use template. Select a template from the templates you created.</p> <p>Include original message as an attachment. Adds the original message as an attachment.</p>
Change Recipient to	<p>Email address. Changes the recipient of the message to the specified email address.</p>
Send to Alternate Destination Host	<p>Mail host. Changes the destination mail host for the message to the specified mail host.</p> <p>Note This action prevents a message classified as spam by an anti-spam scanning engine from being quarantined. This action overrides the quarantine and sends it to the specified mail host.</p>
Deliver from IP Interface	<p>Send from IP interface. Send from the specified IP Interface. The Deliver from IP Interface action changes the source host for the message to the source specified. The source host consists of the IP interface that the messages should be delivered from.</p>
Strip Header	<p>Header name. Remove the specified header from the message before delivering.</p>
Add/Edit Header	<p>Inserts a new header into the message or modifies an existing header.</p> <p>Header name. Name of new or existing header.</p> <p>Specify value of new header. Inserts a value for the new header into the message before delivering.</p> <p>Prepend to the Value of Existing Header. Prepends the value to the existing header before delivering.</p> <p>Append to the Value of Existing Header. Appends the value to the existing header before delivering.</p> <p>Search & Replace from the Value of Existing Header. Enter a search term to find the value you want to replace in the existing header in the Search for field. Enter the value you want to insert into the header in the Replace with field. You can use a regular expression to search for the value. Leave the Replace with field empty if you want to delete the value from the header.</p>
Forged Email Detection	<p>Strips the From: header from the forged message and replaces it with the Envelope Sender.</p> <p>See Forged Email Detection, on page 616.</p>

Action	Description
Add Message Tag	Inserts a custom term into the message to use with DLP policy filtering. You can configure a DLP policy to limit scanning to messages with the message tag. The message tag is not visible to recipients. For information on using messages tags in a DLP policy, see Policies for Data Loss Prevention, on page 488 .
Add Log Entry	Inserts customized text into the IronPort Text Mail logs at the INFO level. The text can include action variables. The log entry also appears in message tracking.
S/MIME Sign/Encrypt on Delivery	Performs an S/MIME signing or encryption of the message during the delivery. This means that the message continues to the next stage of processing, and when all processing is complete, the message is signed or encrypted and delivered. S/MIME Sending Profile: Performs an S/MIME signing or encryption using the specified S/MIME sending profile. See Managing S/MIME Sending Profiles, on page 539 .
Encrypt and Deliver Now (Final Action)	Encrypts and delivers the message, skipping any further processing. Encryption rule: Always encrypts the message or only encrypts it if an attempt to send it over a TLS connection first fails. See Using a TLS Connection as an Alternative to Encryption, on page 522 for more information. Encryption Profile. Encrypts the message using the specified encryption profile, then delivers the message. This action is for use with a Cisco Encryption Appliance or a hosted key service. Subject. Subject for the encrypted message. By default, the value is \$Subject .
S/MIME Sign/Encrypt (Final Action)	Performs an S/MIME signing or encryption and delivers the message, skipping any further processing. S/MIME Sending Profile: Performs an S/MIME signing or encryption using the specified S/MIME sending profile. See Managing S/MIME Sending Profiles, on page 539 .
Bounce (Final Action)	Sends the message back to the sender.
Skip Remaining Content Filters (Final Action)	Delivers the message to the next stage of processing, skipping any further content filters. Depending on configuration, this may mean deliver the message to recipient(s), quarantine, or begin Outbreak Filters scanning.
Drop (Final Action)	Drops and discards the message.

Action	Description
Safe Print	<p>Use the 'Safe Print' content filter action to safe print a message attachment.</p> <p>You can use the Safe Print content filter action in any one of the following ways:</p> <ul style="list-style-type: none"> • Safe print matching attachments: Use this option to safe print all message attachments that match a configured content filter condition. • Safe print all attachments: Use this option to safe print all message attachments when the configured content filter condition is true <p>Select Yes to strip a message attachment that is marked as unscannable.</p> <p>Note By default, a system generated message is added as an attachment text file when an attachment is unscannable. You can enter a custom message in the Custom Replacement Message field.</p> <p>For more information, see How to Configure Email Gateway to Safe Print Message Attachments, on page 334.</p>

Related Topics

- [Action Variables](#), on page 287

Action Variables

Headers added to messages processed by content filters can contain variables that will be automatically replaced with information from the original message when the action is executed. These special variables are called *action variables*. Your appliance supports the following set of action variables:

Table 34: Action Variables

Variable	Syntax	Description
All Headers	<code>\$AllHeaders</code>	Replaced by the message headers.
Body Size	<code>\$BodySize</code>	Replaced by the size, in bytes, of the message.
Date	<code>\$Date</code>	Replaced by the current date, using the format MM/DD/YYYY.
Dropped File Name	<code>\$dropped_filename</code>	Returns only the most recently dropped filename.
Dropped File Names	<code>\$dropped_filenames</code>	Same as <code>\$filenames</code> , but displays list of dropped files.
Dropped File Types	<code>\$dropped_filetypes</code>	Same as <code>\$filetypes</code> , but displays list of dropped file types.

Variable	Syntax	Description
Envelope Sender	<code>\$envelopefrom</code> or <code>\$envelopesender</code>	Replaced by the Envelope Sender (Envelope From, <MAIL FROM>) of the message.
Envelope Recipients	<code>\$EnvelopeRecipients</code>	Replaced by all Envelope Recipients (Envelope To, <RCPT TO>) of the message.
File Names	<code>\$filenames</code>	Replaced with a comma-separated list of the message's attachments' filenames.
File Sizes	<code>\$filesizes</code>	Replaced with a comma-separated list of the message's attachment's file sizes.
File Types	<code>\$filetypes</code>	Replaced with a comma-separated list of the message's attachments' file types.
Filter Name	<code>\$FilterName</code>	Replaced by the name of the filter being processed.
GMTTimeStamp	<code>\$GMTTimeStamp</code>	Replaced by the current time and date, as would be found in the Received: line of an email message, using GMT.
HAT Group Name	<code>\$Group</code>	Replaced by the name of the sender group the sender matched on when injecting the message. If the sender group had no name, the string ">Unknown<" is inserted.
Mail Flow Policy	<code>\$Policy</code>	Replaced by the name of the HAT policy applied to the sender when injecting the message. If no predefined policy name was used, the string ">Unknown<" is inserted.
Matched Content	<code>\$MatchedContent</code>	Replaced by the value (or values) that triggered a content-scanning filter. Matched content can be a content dictionary match, a smart identifier, or a match to a regular expression.
Header	<code>\$Header['string']</code>	Replaced by the value of the quoted header, if the original message contains a matching header. Note that double quotes may also be used.
Hostname	<code>\$Hostname</code>	Replaced by the hostname of the appliance .
Internal Message ID	<code>\$MID</code>	Replaced by the Message ID, or "MID" used internally to identify the message. Not to be confused with the RFC822 "Message-Id" value (use \$Header to retrieve that).
Receiving Listener	<code>\$RecvListener</code>	Replaced by the nickname of the listener that received the message.
Receiving Interface	<code>\$RecvInt</code>	Replaced by the nickname of the interface that received the message.

Variable	Syntax	Description
Remote IP Address	<code>RemoteIP</code>	Replaced by the IP address of the system that sent the message to the appliance .
Remote Host Address	<code>remotehost</code>	Replaced by the hostname of the system that sent the message to the appliance .
SenderBase Reputation Score	<code>Reputation</code>	Replaced by the SenderBase Reputation score of the sender. If there is no reputation score, it is replaced with “ None ”.
Subject	<code>Subject</code>	Replaced by the subject of the message.
Time	<code>Time</code>	Replaced by the current time, in the local time zone.
Timestamp	<code>Timestamp</code>	Replaced by the current time and date, as would be found in the Received: line of an email message, in the local time zone.

How to Filter Messages Based on Content

Related Topics

- [Creating a Content Filter, on page 289](#)
- [Enabling Content Filters for All Recipients by Default, on page 290](#)
- [Applying the Content Filter to Messages for a Certain User Group, on page 291](#)
- [Notes on Configuring Content Filters in the GUI, on page 291](#)

Creating a Content Filter

Before You Begin

- If you want to encrypt a message that matches the content filter, create an encryption profile.
- If you want to add a disclaimer to a matching message, create a disclaimer template to use for generating disclaimers.
- If you want to send a notification message to a user due to a matching message, create a notification template for generating notifications.
- If you want to quarantine a message, you create a new policy quarantine for these messages or use an existing one.

Procedure

Step 1 Click **Mail Policies > Incoming Mail Policies**

or

Mail Policies > Outgoing Mail Policies.

- Step 2** Click **Add Filter**.
- Step 3** Enter a name and description for the filter.
- Step 4** (X-REF) Click the **Editable By (Roles)** link, select the Policy Administrator and click **OK**.
Delegated administrators who belong to the Policy Administrator user role will be able to edit this content filter and use it in their mail policies.
- Step 5** (Optional) Add a condition for triggering the filter.
- Click Add Condition.
 - Select the condition type.
 - Define the condition's rules.
 - Click **OK**.
 - Repeat these steps for any additional conditions you want to add to the filter. When you define more than one condition for a content filter, you can define whether *all* of the defined actions (that is, a logical AND) or *any* of the defined actions (logical OR) need to apply in order for the content filter to be considered a match.
- Note** If you do not add a condition, the appliance will perform the content filter's action to any message that matches one of the mail policies associated with the filter.
- Step 6** Add an action for the appliance to take on a message that matches the filter's condition.
- Click Add Action.
 - Select the action type.
 - Define the action.
 - Click **OK**.
 - Repeat the previous steps for any additional actions you want the appliance to take.
 - For multiple actions, arrange the actions in the order that you want the appliance to apply them to the message. There can only be one "final" action per filter, and AsyncOS automatically moves the final action to the end of the order.
- Step 7** Submit and commit your changes.

What to do next

- You can enable the content filter in a default incoming or outgoing mail policy.
- You can enable the content filter in a mail policy for a specific group of users.

Enabling Content Filters for All Recipients by Default

Procedure

- Step 1** Click **Mail Policies > Incoming Mail Policies**
or
Mail Policies > Outgoing Mail Policies.
- Step 2** Click the link for the Content Filters security service in the default policy row.

Step 3 On the Content Filtering security service page, change the value Content Filtering for Default Policy from “Disable Content Filters” to “Enable Content Filters (Customize settings).”

The content filters defined in the primary list (which were created in [Overview of Content Filters](#), on page 271) are displayed on this page. When you change the value to “Enable Content Filters (Customize settings),” the checkboxes for each filter become enabled.

Step 4 Check the **Enable** checkbox for each content filter you want to enable.

Step 5 Submit and commit your changes.

Applying the Content Filter to Messages for a Certain User Group

Before You Begin

- Create an incoming or outgoing mail policy for the group of users whose messages for which you want to use the content filter. See [Creating a Mail Policy for a Group of Senders and Recipients](#), on page 264 for more information.

Procedure

Step 1 Click **Mail Policies > Incoming Mail Policies**

or

Mail Policies > Outgoing Mail Policies.

Step 2 Click the link for the Content Filters security service (the Content Filters column) for the mail policy to which you want to apply the content filter.

Step 3 On the Content Filtering security service page, change the value for Content Filtering for Policy: Engineering from “Enable Content Filtering (Inherit default policy settings)” to “Enable Content Filtering (Customize settings).”

Step 4 Select the checkboxes for the content filters you want to use.

Step 5 Submit and commit your changes.

Notes on Configuring Content Filters in the GUI

- It is not necessary to specify a condition when creating a content filter. When no action is defined, any actions defined will always apply in the rule. (Specifying no condition is equivalent to using the true() message filter rule — all messages will be matched if the content filter is applied to a policy.)
- If you do not assign a custom user role to a content filter, the content filter is public and can be used by any delegated administrator for their mail policies. See the “Common Administrative Tasks” chapter for more information on delegated administrators and content filters.
- Administrators and operators can view and edit all content filters on the appliance, even when the content filters are assigned to custom user roles.
- When entering text for filter rules and actions, the following meta characters have special meaning in regular expression matching: . ^ \$ * + ? { [] \ | ()

If you do not wish to use regular expression you should use a `\` (backslash) to escape any of these characters. For example: `"*Warning*"`

- You can test message splintering and content filters by creating “benign” content filters. For example, it is possible to create a content filter whose only action is “deliver.” This content filter will not affect mail processing; however, you can use this filter to test how Email Security Manager policy processing affects other elements in the system (for example, the mail logs).
- Conversely, using the “primary list” concept of the Incoming or Outgoing Content Filters, it is possible to create very powerful, wide-sweeping content filters that will immediately affect message processing for all mail handled by the appliance. The process for this is to:
 - Use the Incoming or Outgoing Content Filters page to create a new content filter whose order is 1.
 - Use the Incoming or Outgoing Mail Policies page to enable the new content filter for the default policy.
 - Enable the content filter for all remaining policies.
- The Bcc: and Quarantine actions available in Content Filters can help you determine the retention settings of quarantines you create. (See [Policy, Virus, and Outbreak Quarantines, on page 899](#)) You can create filters that would simulate mail flow into and out of your policy quarantines so that messages are not released too quickly from the system (that is, the quarantine areas do not fill their allotted disk space too quickly).
- Because it uses the same settings as the Scan Behavior page or the `scanconfig` command, the “Entire Message” condition does not scan a message’s headers; choosing the “Entire Message” will scan only the message body and attachments. Use the “Subject” or “Header” conditions to search for specific header information.
- Configuring users by LDAP query will only appear in the GUI if you have LDAP servers configured on the appliance (that is, you have configured the appliance to query specific LDAP servers with specific strings using the `ldapconfig` command).
- Some sections of the content filter rule builder will not appear in the GUI if the resource has not been preconfigured. For example, notification templates and message disclaimers will not appear as options if they have not been configured previously using the Text Resources page or the `textconfig` command in the CLI.
- Content filters features will recognize, can contain, and/or scan for text in the following character encodings:
 - Unicode (UTF-8)
 - Unicode (UTF-16)
 - Western European/Latin-1 (ISO 8859-1)
 - Western European/Latin-1 (Windows CP1252)
 - Traditional Chinese (Big 5)
 - Simplified Chinese (GB 2312)
 - Simplified Chinese (HZ GB 2312)
 - Korean (ISO 2022-KR)
 - Korean (KS-C-5601/EUC-KR)
 - Japanese (Shift-JIS (X0123))
 - Japanese (ISO-2022-JP)
 - Japanese (EUC)

You can mix and match multiple character sets within a single content filter. Refer to your web browser's documentation for help displaying and entering text in multiple character encodings. Most browsers can render multiple character sets simultaneously.

- On the Incoming or Outgoing Content Filters summary pages, use the links for “Description,” “Rules,” and “Policies” to change the view presented for the content filters:
 - The **Description** view shows the text you entered in the description field for each content filter. (This is the default view.)
 - The **Rules** view shows the rules and regular expressions build by the rule builder page.
 - The **Policies** shows the policies for which each content filter is enabled.



CHAPTER 12

Configuring Email Gateway to Consume External Threat Feeds

This chapter contains the following sections:

- [Overview of External Threat Feeds, on page 295](#)
- [How to Configure Email Gateway to Consume External Threat Feeds , on page 296](#)
- [Obtaining External Threat Feeds Feature Key , on page 296](#)
- [Enabling External Threat Feeds Engine on Email Gateway, on page 298](#)
- [Configuring an External Threat Feed Source, on page 298](#)
- [Handling Messages Containing Threats, on page 301](#)
- [Configuring a Sender Group for Handling Messages containing Threats , on page 302](#)
- [Configuring Content or Message Filters for Handling Messages Containing Threats, on page 302](#)
- [Attaching Content Filter to Incoming Mail Policy, on page 309](#)
- [External Threat Feeds and Clusters, on page 309](#)
- [Monitoring External Threat Feeds Engine Updates, on page 309](#)
- [Viewing Alerts, on page 310](#)
- [Displaying Threat Details in Message Tracking, on page 310](#)

Overview of External Threat Feeds

The External Threat Feeds (ETF) framework allows the email gateway to consume external threat information in STIX format communicated over TAXII protocol.

The ability to consume external threat information in the email gateway, helps an organization to:

- Proactively respond to cyber threats such as, malware, ransomware, phishing attacks, and targeted attacks.
- Subscribe to local and third-party threat intelligence sources.
- Improve the efficacy of the email gateway.

You need a valid feature key to use the ETF feature on your email gateway. For information on how to obtain a feature key, contact your Cisco sales representative.

STIX (Structured Threat Information eXpression) is the industry standard, structured language to represent cyber threat information. A STIX source consists of an indicator that contains a pattern used to detect malicious or suspicious cyber activity.

The following is a list of STIX Indicators of Compromise (IOCs) supported for this release:

- File Hash Watchlist (describes a set of hashes for suspected malicious files)
- IP Watchlist (describes a set of suspected malicious IP addresses)
- Domain Watchlist (describes a set of suspected malicious domains)
- URL Watchlist (describes a set of suspected malicious URLs)

TAXII (Trusted Automated eXchange of Indicator Information) defines a set of specifications to exchange cyber threat information via services (TAXII servers) across different organizations or product lines.

The following versions of STIX/TAXII are supported for this release - STIX 1.1.1 and 1.2 with TAXII 1.1.

How to Configure Email Gateway to Consume External Threat Feeds

Perform these steps in order:

Steps	Do This	More Information
Step 1	Obtain an External Threat Feeds feature key.	Obtaining External Threat Feeds Feature Key , on page 296
Step 2	Enable the ETF engine on your email gateway.	Enabling External Threat Feeds Engine on Email Gateway , on page 298
Step 3	Configure an ETF source to allow your email gateway to fetch threat feeds in STIX format from a TAXII server.	Configuring an External Threat Feed Source , on page 298
Step 4	Handle messages that contain threats using: <ul style="list-style-type: none"> • HAT • Content or Message filters 	Handling Messages Containing Threats , on page 301
Step 5	Attach the content filters that you configured to detect malicious domains, URLs, or file hashes in messages to an incoming mail policy.	Attaching Content Filter to Incoming Mail Policy , on page 309

Obtaining External Threat Feeds Feature Key

Managing Email Gateways using the Classic Licensing Mode

If you are an existing user using the Classic Licensing mode and you do not have an External Threat Feeds feature key, follow the given steps to contact the Cisco Global Licensing Operations (GLO) team to obtain the feature key:

Procedure

- Step 1** Send an email to the GLO team (licensing@cisco.com) with the message subject as "Request for External Threat Feeds Feature Key."
- Step 2** Provide your Product Authorization Key (PAK) file and Purchase order (PO) details in the email.
- The GLO team provisions the feature key manually and sends you an email with the license key to install on your email gateway.
-

What to do next



Note

- If you are an existing user using the hardware or virtual email gateway models and you can obtain feature keys or software licenses directly from the Cisco server, you are automatically provided with an External Threat Feeds feature key.
- If you are an existing user using the virtual email gateway models and are not able to obtain feature keys or licenses directly from the Cisco server, perform the following steps to obtain an External Threat Feeds feature key:
 1. Log in to the License Registration Portal (LRP) using your LRP user account credentials.
 2. Select Get License.
 3. Select Migration.
 4. Select Security Products
 5. Select Email Security (ESA)
 6. Enter the VLN Number and generate the license file.

The generated license file includes the ETF feature. You need to install the new license file in your email gateway to use the ETF feature.



Note

If you are not able to log in to your LRP account, contact the GLO team (licensing@cisco.com) to generate the license file.

Managing Email Gateways using the Smart Software Licensing Mode

If you are an existing or new user using the Smart Licensing mode on your email gateways, you are automatically provided with an External Threat Feeds feature key.

Enabling External Threat Feeds Engine on Email Gateway

Before you begin

Make sure that you have a valid feature key to use the ETF feature on your email gateway.

Procedure

Step 1 Click **Security Services > External Threat Feeds**.

Step 2 Click **Enable**.

Step 3 Scroll to the bottom of the license agreement page and click **Accept** to accept the agreement.

Note If you do not accept the license agreement, ETF is not enabled on your Cisco Email Security Gateway.

Step 4 Check **Enable External Threat Feeds**.

Step 5 (Optional) Select **Yes** to add a custom header to all messages that are not scanned for threats by the ETF engine because of an ETF engine lookup failure.

Step 6 Submit and commit your changes.

What to do next

Configure an ETF source. See [Configuring an External Threat Feed Source, on page 298](#).

Configuring an External Threat Feed Source

An ETF source is used to download information about a collection of threats that is available on a TAXII server. You need to configure an ETF source to allow your email gateway to fetch threat feeds in STIX format from a TAXII server.



Note You can configure a maximum of eight ETF sources in your email gateway.

You can configure an ETF source using the Poll service that consists of a 'polling path' and a 'collection name.'

Before you begin

- Make sure that you have enabled the ETF engine on your email gateway.
- Make sure that you open ports - 80 HTTP and 443 HTTPS on your firewall to allow your gateway to consume external threat feeds. For more information, see [Firewall Information, on page 1289](#).

Procedure

- Step 1** Click **Mail Policies > External Threat Feeds Manager**.
- Step 2** Click **Add Source**.
- Step 3** Enter the required parameters described in the following table to configure an ETF source.

Parameter Source Details	Description
Source Name	Enter a name for the ETF source.
Description	Enter a description for the ETF source.
TAXII Details	
Hostname	Enter the hostname of a fully qualified domain name or an IP address of a TAXII server.
Polling Path	Enter the polling path that identifies the polling service in a TAXII server, for example, /taxii-data.
Collection Name	Enter the name of a collection of threat feeds that is hosted on a TAXII server, for example, guest.Abuse_ch.
Polling Interval	Enter a polling interval to define the frequency of fetching threat feeds from a TAXII server. The minimum value is 15 minutes and the default value is 60 minutes.
Age of Threat Feeds	Enter the maximum age of a threat feed that can be fetched from a TAXII server. The value for the age must be between one through 365 days.



Parameter Source Details	Description
Time Span for Poll Segment	<p>Enter the time span for each poll segment.</p> <p>The minimum time span for a poll segment is 1 day. The maximum time span for a poll segment is the value entered in the 'Age of Threat Feeds' field.</p> <p>You can use the 'Time Span for Poll Segment' option in the following scenarios:</p> <ul style="list-style-type: none"> • If there is no known limitation on the age of threat feeds for a TAXII server, use the value entered in the 'Age of Threat Feeds' option. • If there is a known limitation on the age of threat feeds for a TAXII server, use the known limit value. • If you do not know the known limitation on the age of threat feeds for a TAXII server, use the default value of 30 days. • If the value you enter in the 'Age of Threat Feeds' option is not supported by the TAXII server, you can split the age of threat feeds into different poll segments based on the time span entered. <p>For example, if the age of the threat feeds is 100 days and the TAXII server has a fixed limit on the age of threat feeds (for example, '40 days'), enter 40 as the time span for poll segment</p> <p>Note If the time span for the poll segment is a small value (for example, '5 days'), the polling of the threat feed source can take a long time to complete, and this may impact the performance of your gateway.</p>
Use HTTPS	Select Yes if you want to connect to a TAXII server using HTTPS.
Configure Credentials	<p>Select Yes, if you want to access a TAXII server using the user credentials that you created in the TAXII server.</p> <p>Enter the username and password.</p>
Proxy Details	

Parameter Source Details	Description
Use Global Proxy	<p>Select Yes to connect the email gateway to a TAXII server using a proxy server.</p> <p>You can configure a proxy server in any one of the following ways:</p> <ul style="list-style-type: none"> • Security Services > Service Updates page in the web interface • <code>updateconfig</code> command in the CLI

Step 4 Submit and commit your changes.

After you configure an ETF source, your email gateway begins to fetch threat feeds from a TAXII source.

What to do next

- You can also configure an ETF source using the `threatfeedsconfig > sourceconfig` subcommand in the CLI.
- (Optional) Click **Suspend Polling** () icon in the Mail Policies > External Threat Feeds Manager page to suspend the polling service for a configured ETF source.
- (Optional) Click **Resume Polling** () icon in the Mail Policies > External Threat Feeds Manager page to resume the polling service for a configured ETF source.
- (Optional) Click **Poll Now** in the Mail Policies > External Threat Feeds Manager page to fetch the threat feeds from the last successful polling interval immediately.
- See [Handling Messages Containing Threats, on page 301](#).

Handling Messages Containing Threats

You can handle messages that contain threats in your email gateway using:

- HAT
- Content or Message filters

Related Topics

- [Configuring a Sender Group for Handling Messages containing Threats](#) , on page 302.
- [Configuring Content or Message Filters for Handling Messages Containing Threats, on page 302](#).

Configuring a Sender Group for Handling Messages containing Threats

You can configure an existing sender group to handle messages that originate from malicious IPs using the verdict obtained from the ETF engine.

Procedure

- Step 1** Go to **Mail Policies > HAT Overview** page.
 - Step 2** Click an existing sender group that you want to configure to handle messages that contain threats.
 - Step 3** Click **Edit Settings**.
 - Step 4** Select the required ETF source to filter malicious IP addresses.
 - Step 5** (Optional) Click **Add Row** to add another ETF source.
 - Step 6** Submit and commit your changes.
-

Configuring Content or Message Filters for Handling Messages Containing Threats

You can configure one or more of the following content or message filters, to take appropriate actions on messages that contain threats based on the verdicts obtained from the ETF engine:

- URL Reputation - to detect URLs categorized as malicious by the ETF engine.
- Domain Reputation - to detect domains categorized as malicious by the ETF engine.
- Attachment by File Info - to detect files categorised as malicious by the ETF engine based on the file hash.

Related Topics

- [Detecting Malicious Domains in Messages Using Content Filter, on page 303.](#)
- [Detecting Malicious Domains in Messages Using Message Filter, on page 304](#)
- [Detecting Malicious URLs in Messages Using Content Filter, on page 304](#)
- [Detecting Malicious URLs in Messages Using Message Filter, on page 306](#)
- [Detecting Malicious Files in Message Attachments Using Content Filter, on page 307.](#)
- [Detecting Malicious Files in Messages Attachments Using Message Filter , on page 227.](#)

Detecting Malicious Domains in Messages Using Content Filter

Use the 'Domain Reputation' content filter to detect domains categorized as malicious in messages by the ETF engine and take appropriate actions on such messages.

Before you begin

- (Optional) Create an address list that contains only domains. To create one, go to **Mail Policies > Address Lists** page in the web interface or use the `addresslistconfig` command in the CLI. For more information, see [Mail Policies, on page 257](#).
- (Optional) Create a Domain Exception List. For more information, see [Creating Domain Exception List](#).

Procedure

- Step 1** Go to **Mail Policies > Incoming Content Filters**.
 - Step 2** Click **Add Filter**.
 - Step 3** Enter a name and description for the content filter.
 - Step 4** Click **Add Condition**.
 - Step 5** Click **Domain Reputation**.
 - Step 6** Select **External Threat Feeds**.
 - Step 7** Select the ETF source(s) to detect malicious domain(s) in the header(s) of a message.
 - Step 8** Select the required headers to check for the reputation of the domain.
 - Step 9** (Optional) Select the list of allow listed domains that you do not want the email gateway to detect for threats for this content filter.
 - Step 10** Click **OK**.
 - Step 11** Click **Add Action** to configure an appropriate action to take on messages that contain malicious domains.
 - Step 12** Submit and commit your changes.
-

Creating Domain Exception List

A Domain Exception List consists of a list of addresses that contain only domains. You can use a Domain Exception List if you want the email gateway to skip the domain check for all configured Domain Reputation content or message filters.

Procedure

- Step 1** Go to **Security Services > Domain Reputation**.
 - Step 2** Click **Edit Settings** under Domain Exception List.
 - Step 3** Select the required address list that contains domains only.
 - Step 4** Submit and commit your changes.
-

What to do next

You can also create a Domain Exception List using the `domainrepconfig` command in the CLI. For more information, see the *CLI Reference Guide for AsyncOS 12.0 for Cisco Email Security Appliances*.

Detecting Malicious Domains in Messages Using Message Filter

As an example, use the following message filter rule syntax to detect malicious domains in messages using the ETF engine, and take appropriate actions on such messages.

Syntax:

```
quarantine_msg_based_on ETF: if (domain-external-threat-feeds (['etf_source1'],
  ['mail-from', 'from'], <'domain_exception_list'>)) { quarantine("Policy"); }
```

Where

- `'domain-external-threat-feeds'` is the Domain reputation message filter rule.
- `'etf_source1'` is the ETF source(s) used to detect malicious domain(s) in the header(s) of a message.
- `'mail-from', 'from'` are the required header(s) used to check for the reputation of the domain.
- `'domain_exception_list'` is the name of a domain exception list. If a domain exception list is not present it is displayed as "".

Example

In the following example, if the domain in the 'Errors To:' custom header is detected as malicious by the ETF engine, the message is quarantined.

```
Quarantining_Messages_with_Malicious_Domains: if domain-external-threat-feeds
(['threat_feed_source'], ['Errors-To'], "") { quarantine("Policy"); }
```

Detecting Malicious URLs in Messages Using Content Filter

Use the 'URL Reputation' content filter to detect URLs in messages categorized as malicious by the ETF engine and take appropriate actions on such messages.

You can configure the 'URL Reputation' content filter for ETF in any one of the following ways:

- Use the 'URL Reputation' condition with any appropriate action.
- Use the 'URL Reputation' action with any or no condition.
- Use the 'URL Reputation' condition and action.

The following procedure is used to detect malicious URLs using the 'URL Reputation' condition and action:

**Note**

- If you only want to use the 'URL Reputation' condition with any appropriate action, do not follow steps 11-20 of the procedure.
- If you only want to use the 'URL Reputation' action with any or no condition., do not follow steps 4-10 of the procedure.

Before you begin

- Make sure that you enable URL filtering on your email gateway. To enable URL filtering, go to *Security Services > URL Filtering* page in the web interface. For more information, see [Protecting Against Malicious or Undesirable URLs, on page 425](#).
- Make sure that you enable Outbreak Filters on your email gateway. To enable Outbreak Filters, go to *Security Services > Outbreak Filters* page in the web interface. For more information, see [Outbreak Filters, on page 401](#).
- Make sure that you enable Anti-Spam engine on your email gateway. To enable the Anti-Spam engine, go to *Security Services > Anti-Spam* page in the web interface. For more information, see [Managing Spam and Graymail, on page 359](#).
- (Optional) Create a URL list. To create one, go to *Mail Policies > URL Lists* page in the web interface. For more information, see [Protecting Against Malicious or Undesirable URLs, on page 425](#).

Procedure

- Step 1** Go to **Mail Policies > Incoming Content Filters**.
- Step 2** Click **Add Filter**.
- Step 3** Enter a name and description for the content filter.
- Step 4** Click **Add Condition**.
- Step 5** Click **URL Reputation**.
- Step 6** Select **External Threat Feeds**.
- Step 7** Select the ETF source(s) to detect malicious URLs.
- Step 8** (Optional) Select the list of allow listed URLs that you do not want the email gateway to detect for threats.
- Step 9** Select the required **Check URLs within** option to detect malicious URLs in the message body and subject and/or message attachments.
- Step 10** Click **OK**.
- Step 11** Click **Add Action**.
- Step 12** Click **URL Reputation**.
- Step 13** Select **External Threat Feeds**.
- Step 14** Make sure that you select the same ETF source(s) that you selected in the condition (Step 7).
- Step 15** (Optional) Select the same list of allow listed URLs that you selected in Step 8.
- Step 16** Select the required **Check URLs within** option to detect malicious URLs in the 'message body and subject' and/or 'message attachments'
- Step 17** Select the required action that you want to perform on the URLs within the message body and subject and/or message attachments.
- Note** In Step 16, if you choose the 'Check URLs within' option as 'Attachments', you can only strip the attachment from the message.
- Step 18** Select whether you want to take actions on all messages or unsigned messages.
- Step 19** Click **OK**.
- Step 20** Submit and commit your changes.

Note If you have configured URL Reputation content filters for Web Based Reputation Score (WBRS) and ETF on your email gateway, it is recommended to set the order of the WBRS URL Reputation content filter higher than the order of the ETF URL Reputation filter, to improve the performance of your email gateway.

Detecting Malicious URLs in Messages Using Message Filter

As an example, use the ‘URL Reputation’ message filter rule syntax to detect malicious URLs in messages using the ETF engine, and to defang the URL.

Syntax:

```
defang_url_in_message: if (url-external-threat-feeds (['etf_source1'],
<'URL_allowedlist'>,
<'message_attachments'> , <'message_body_subject'> ,))
{ url-etf-defang(['etf_source1'], "", 0); } <'URL_allowedlist'> ,
<'Preserve_signed'>}
```

Where

- ‘url-external-threat-feeds’ is the URL Reputation rule.
- ‘etf_source1’ is the ETF source(s) used to detect malicious URLs in the messages or message attachments.
- ‘URL_allowedlist’ is the name of a URL allowed list. If a URL allowed list is not present, it is displayed as “”.
- ‘message_attachments’ is used to check for malicious URLs in the message attachments. A value of ‘1’ is used to detect malicious URLs in the message attachments.
- ‘message_body_subject’ is used to check for malicious URLs in the message body and subject. A value of ‘1’ is used to detect malicious URLs in the message body and subject.



Note A value of “1,1” is used to detect malicious URLs in the message body, subject, and message attachments.

- ‘url-etf-defang’ is one of the actions that you can take on messages that contain malicious URLs.

The following examples are the ETF-based actions that you can apply on messages that contain malicious URLs:

- url-etf-strip(['etf_source1'], "None", 1)
- url-etf-defang-strip(['etf_source1'], "None", 1, "Attachment removed")
- url-etf-defang-strip(['etf_source1'], "None", 1)
- url-etf-proxy-redirect(['etf_source1'], "None", 1)
- url-etf-proxy-redirect-strip(['etf_source1'], "None", 1)
- url-etf-proxy-redirect-strip(['etf_source1'], "None", 1, " Attachment removed")

- url-etf-replace(['etf_source1'], "", "None", 1)
- url-etf-replace(['etf_source1'], "URL removed", "None", 1)
- url-etf-replace-strip(['etf_source1'], "URL removed ", "None", 1)
- url-etf-replace-strip(['etf_source1'], "URL removed*", "None", 1, "Attachment removed")
- 'Preserve_signed' is represented by '1' or '0'. '1' indicates that this action applies to unsigned messages only and '0' indicates that this action applies to all messages.

In the following example, if a URL in the message attachment is detected as malicious by the ETF engine, the attachment is stripped.

```
Strip_Malicious_URLs: if (true) {url-etf-strip(['threat_feed_source'], "", 0);}
```

Detecting Malicious Files in Message Attachments Using Content Filter

Use the 'Attachment File Info' content filter to detect files in message attachments categorized as malicious by the ETF engine, and take appropriate actions on such messages.



Note The ETF engine performs a lookup based on the file hash of a file.

You can configure the 'Attachment File Info' content filter for ETF in any one of the following ways:

- Use the 'Attachment File Info' condition with any appropriate action.
- Use the 'Strip Attachment by File Info' action with any or no condition.
- Use the 'Attachment File Info' condition and 'Strip Attachment by File Info' action.

The following procedure is used to detect malicious files in message attachments using the 'Attachment by File Info' condition and 'Strip Attachment by File Info' action:



- Note**
- If you only want to use the 'Attachment File Info' condition with any appropriate action, do not follow steps 10-15 of the procedure.
 - If you only want to use the 'Strip Attachment by File Info' action with any or no condition., do not follow steps 4-9 of the procedure.

Before you begin

(Optional) Create a File Hash Exception List. To create one, go to Mail Policies > File Hash Lists page in the web interface. For more information, see [Creating File Hash List, on page 308](#).

Procedure

- Step 1** Go to **Mail Policies > Incoming Content Filters**.
 - Step 2** Click **Add Filter**.
 - Step 3** Enter a name and description for the content filter.
 - Step 4** Click **Add Condition**.
 - Step 5** Click **Attachment File Info**.
 - Step 6** Select **External Threat Feeds**.
 - Step 7** Select the ETF source(s) to detect malicious files using file hashes.
 - Step 8** (Optional) Select the list of file hashes that you do not want the email gateway to detect for threats.
 - Step 9** Click **OK**.
 - Step 10** Click **Add Action**.
 - Step 11** Click **Strip Attachment by File Info**.
 - Step 12** Select **External Threat Feeds**.
 - Step 13** Make sure that you select the same ETF source(s) that you selected in the condition (Step 7).
 - Step 14** (Optional) Select the same list of file hashes that you selected in Step 8.
 - Step 15** Submit and commit your changes.
-

Creating File Hash List

Procedure

- Step 1** Go to **Mail Policies > File Hash Lists**.
 - Step 2** Click **Add File Hash List**.
 - Step 3** Check the required file hash type - 'SHA256' or 'MD5' or all of the above.
 - Step 4** Enter the file hashes (that you selected in Step 3) separated by commas or in new lines.
 - Step 5** Submit and commit your changes.
-

Detecting Malicious Files in Messages Attachments Using Message Filter

As an example, use the following message filter rule syntax to detect files in message attachments categorized as malicious by the ETF engine, and take appropriate actions on such messages.

Syntax:

```
Strip_malicious_files: if (file-hash-etf-rule (['etf_source1'], <'file_hash_exception_list'>))
{
  file-hash-etf-strip-attachment-action (['etf_source1'], <'file_hash_exception_list'>,
  "file stripped from message attachment");
}
```

Where:

- 'file-hash-etf-rule' is the Attachment File Info message filter rule

- `'etf_source1'` is the ETF source(s) used to detect malicious files in the messages based on the file hash.
- `'file_hash_exception_list'` is the name of a file hash exception list. If a file hash exception list is not present, it is displayed as `""`.
- `'file-hash-etf-strip-attachment-action'` is the name of the action that you want to apply on messages that contain malicious files.

In the following example, if a message contains a message attachment detected as malicious by the ETF engine, the attachment is stripped.

```
Strip_Malicious_Attachment: if (true) {file-hash-etf-strip-attachment-action  
(['threat_feed_source'], "", "Malicious message attachment has been stripped from  
the message.");}
```

Attaching Content Filter to Incoming Mail Policy

You can attach one or more of the content filters that you configured to detect malicious domains, URLs, or file hashes in messages to an incoming mail policy.

Procedure

-
- Step 1** Go to **Mail Policies > Incoming Mail Policies**.
 - Step 2** Click the link below **Content Filters** of a particular mail policy.
 - Step 3** Select **Enable Content Filters (Customize Settings)**.
 - Step 4** Select the Content Filters that you created for detecting malicious domains, URLs or file hashes.
 - Step 5** Submit and commit your changes.
-

What to do next

After you attach the content filter to an incoming mail policy, your email gateway begins to take actions on messages based on the verdicts received from the ETF engine.

External Threat Feeds and Clusters

If you use centralized management, you can enable the ETF engine and mail policies at the cluster, group, and machine level.

Monitoring External Threat Feeds Engine Updates

If you have enabled service updates, the ETF engine updates are retrieved from the Cisco update servers. However, in some scenarios (for example, you have disabled automatic service updates or automatic service update is not working), you might want to manually check for ETF engine updates.

You can manually update the ETF engine in any one of the following ways:

- Go to **Security Services > External Threat Feeds** page in the web interface, and click **Update Now**.
- Use the `threatfeedupdate` command in the CLI.

To know the details of the existing ETF engine, see the ‘External Threat Feeds Engine Updates’ section in the Security Services > External Threat Feeds page in the web interface or use the `threatfeedstatus` command in CLI.

Viewing Alerts

The following table lists the alerts generated by the ETF engine, including a description of the alert and the alert severity.

Component/Alert Name	Message and Description	Parameters
ETF ENGINE ALERT	Unable to fetch the observables from the source: \$source_name after 3 failed attempts. Reason for failure: \$reason	‘source’ - The name of the TAXII source. ‘reason’ - The reason why the polling failed.
	Information. Sent when polling feeds from a TAXII source fails.	
ETF ENGINE ALERT	The storage limit of \$count observables exceeded for the observable type: \$type.	\$count - The allowed number of observables per type. \$ type - The type of the observable.
	Information. Sent when the number of permitted observables exceeded.	

Displaying Threat Details in Message Tracking

You can view the message details that contain threats corresponding to the selected IOCs from the selected ETF source(s).

Before you begin

- Make sure that you enable the Message Tracking feature on the email gateway. To enable Message Tracking, go to **Security Services > Centralized Services > Message Tracking** page in the web interface.
- Content or Message filters for detecting threats in messages are operational.

Procedure

-
- Step 1** Go to **Monitor > Message Tracking**.
 - Step 2** Click **Advanced**.
 - Step 3** Check **External Threat Feeds** under Message Event.

- Step 4** Select the required IOC(s) to track messages containing threats corresponding to the selected IOCs.
- Step 5** (Optional) Select **All External Threat Feed Sources** to view the messages that contain threats based on the available and deleted ETF source(s) configured in the email gateway.
- Step 6** (Optional) Select **Current External Threat Feed Sources** and choose the required ETF source(s) to view the messages that contain threats based on the available ETF source(s) configured in the email gateway.
- Step 7** (Optional) Enter the name of a particular ETF source in the 'External Threat Feed Sources' field to view messages that contain threats based on this ETF source.
- Step 8** Click **Search**.
-



CHAPTER 13

Sender Domain Reputation Filtering

This chapter contains the following sections:

- [Overview of Sender Domain Reputation Filtering](#), on page 313
- [How to Filter Messages based on Sender Domain Reputation](#), on page 315
- [Enabling Sender Domain Reputation Filtering on Email Gateway](#), on page 316
- [Configuring Message or Content Filter for Handling Messages based on Sender Domain Reputation](#), on page 317
- [Attaching Content Filter to Incoming Mail Policy](#), on page 320
- [Sender Domain Reputation Filtering and Clusters](#), on page 321
- [Displaying Sender Domain Reputation Details in Message Tracking](#), on page 321
- [Viewing Alerts](#), on page 321
- [Viewing Logs](#), on page 322

Overview of Sender Domain Reputation Filtering

Cisco Talos Sender Domain Reputation (SDR) is a cloud service that provides a reputation verdict for email messages based on a sender's domain and other attributes.

The domain-based reputation analysis enables a higher spam catch rate by looking beyond the reputation of shared IP addresses, hosting or infrastructure providers, and derives verdicts based on features that are associated with fully qualified domain names (FQDNs) and other sender information in the Simple Mail Transfer Protocol (SMTP) conversation and message headers.

For more information, see the Cisco Talos Sender Domain Reputation (SDR) white paper in the Security Track of the Cisco Customer Connection program at <http://www.cisco.com/go/ccp>.



Note

- You must create a Cisco Customer Connection account to access the SDR white paper.
 - Like Cisco IPAS disputes, submit SDR disputes by opening a support request with the Cisco Technical Assistance Center (TAC).
-

SDR Verdicts

The following table lists the SDR verdict names, descriptions, and recommended actions:

Table 35: SDR Verdicts

Verdict Name	Description	Recommended Action
Awful	<p>The worst reputation verdict.</p> <p>Expect to see false-negatives (FN) if the blocking threshold is set to only this verdict, which prioritizes delivery over security.</p>	Block the message.
Poor	<p>The recommended blocking threshold.</p> <p>This balances the trade-offs between false-negatives (FN) and false-positives (FP). Talos tunes SDR so that messages that are blocked by SDR have either a poor or awful verdict.</p> <p>Not blocking on this verdict prioritizes delivery over security, but it results in false-negatives that the customer accepts when not blocking based on this verdict.</p>	Scan the message with the other engines configured on your email gateway.
Tainted	<p>The sender reputation is suspect.</p> <p>Blocking based on these verdicts is aggressive and not recommended by Talos. It promotes security over delivery, but it results in false-positives that you can accept when blocking based on this verdict.</p>	Scan the message with the other engines configured on your email gateway.
Weak	<p>A common verdict for many domains (including legitimate and mixed-use) associated with weak indicators that preclude a neutral verdict. Talos does not recommend blocking on this verdict.</p> <p>While this prioritizes security over Delivery, it results in an unacceptable number of False-Positives (as per Talos) when you block messages based on this verdict.</p>	Scan the message with the other engines configured on your email gateway.

Verdict Name	Description	Recommended Action
Unknown	<p>The sender is using a newly registered domain or one that SDR does not otherwise recognize. For domains in this undetermined state, Talos performs further analysis to establish a verdict quickly. Talos does not recommend blocking on this verdict. Blocking on this verdict results in many False Positives that you accept when adjusting their threshold to this verdict. Talos recommends quarantining messages with a verdict of “unknown.”</p> <p>The message delivery is slightly delayed to allow time for Talos to investigate the domain before scanning the message with subsequent engines.</p>	Scan the message with the other engines configured on your email gateway.
Neutral	The normal expected verdict when the sender is using a domain that is not new and adheres to the sender best practices. The following are the sender best practices - using SPF, DKIM-signing, not sending spam, etc.	Scan the message with the other engines configured on your email gateway.
Good	A rare verdict that indicates the sender is using a certified domain where messages are DKIM signed (aligned on the “FROM:” header domain).	Scan the message with the other engines configured on your email gateway.

How to Filter Messages based on Sender Domain Reputation

Steps	Do This	More Information
Step 1	<p>Enable SDR filtering on Cisco Email Security Gateway.</p> <p>Note After you upgrade to AsyncOS 12.0, SDR queries are enabled by default.</p>	Enabling Sender Domain Reputation Filtering on Email Gateway, on page 316

Steps	Do This	More Information
Step 2	Configure a message or content filter to handle messages based on SDR.	Configuring Message or Content Filter for Handling Messages based on Sender Domain Reputation, on page 317
Step 3	Attach the content filter that you configured to filter messages based on SDR to an incoming mail policy.	Attaching Content Filter to Incoming Mail Policy, on page 320

Enabling Sender Domain Reputation Filtering on Email Gateway



Note After you upgrade to AsyncOS 12.0, SDR queries are enabled by default.

Procedure

Step 1 Go to **Security Services > Domain Reputation**.

Step 2 Click **Enable**.

Step 3 Check **Enable Sender Domain Reputation Filtering**.

Step 4 (Optional) Check **Include Additional Attributes** if you want the SDR service to check for SDR based on additional attributes of the message.

If you enable this option, the following additional attributes of the message are included in the SDR check to improve the efficacy:

- Username part of the email address present in the 'Envelope From:', 'From:', and 'Reply-To:' headers.
- Display name in the 'From:' and 'Reply-To:' headers.

Step 5 (Optional) Enter the number of elapsed seconds before the SDR query times out.

Note Modifying the SDR query timeout value may impact the performance of mail processing.

Step 6 (Optional) Check **Match Domain Exception List based on Domain in Envelope From:** if you want the email gateway to skip the SDR check based on the domain in the Envelope From: header only.

Step 7 Click **Submit**.

Step 8 (Optional) Click **I Agree** if you want to accept the SDR Include Additional Attributes Agreement message.

Note The SDR Include Additional Attributes Agreement message appears only when you select the Include Additional Attributes option.

Step 9 Click **Commit** to commit your changes.

What to do next

Configure a content or message filter to handle messages based on SDR. See [Configuring Message or Content Filter for Handling Messages based on Sender Domain Reputation](#), on page 317.

Configuring Message or Content Filter for Handling Messages based on Sender Domain Reputation

You can use the 'Domain Reputation' message or content filter in any one of the following ways to filter messages based on SDR, and take appropriate actions on such messages:

- Sender Domain Verdict
- Sender Domain Age
- Sender Domain Unscannable

Related Topics

- [Filtering Messages based on Sender Domain Reputation using Message Filter](#), on page 317
- [Filtering Messages based on Sender Domain Reputation using Content Filter](#), on page 319

Filtering Messages based on Sender Domain Reputation using Message Filter

Filtering Messages based on Sender Domain Verdict



Note The recommended blocking threshold is "Awful." For more information about SDR verdicts, see [SDR Verdicts](#), on page 313.

Syntax:

```
drop_msg_based_on_sdr_verdict:  
if_sdr-reputation(['awful', 'poor'], "<domain_exception_list>")  
{drop();}
```

Where:

- 'drop_msg_based_on_sdr_verdict' is the name of the message filter.
- 'sdr-reputation' is the Domain Reputation message filter rule.
- 'awful', 'poor' is the range of the sender domain verdict used to filter messages based on SDR.
- 'domain_exception_list' is the name of a domain exception list. If a domain exception list is not present it is displayed as "".
- 'drop' is the action applied on the message.

Example

In the following message, if the SDR verdict is 'Unknown', the message is quarantined.

```
quarantine_unknown_sdr_verdicts:
if sdr-reputation (['unknown'], "")
{quarantine("Policy")}
```

Filtering Messages based on Sender Domain Age

Syntax:

```
<msg_filter_name>
if sdr-age (<'unit'>, <'operator'> <'actual value'>)
{<action>}
```

Where:

- 'sdr-reputation' is the Domain Reputation message filter rule.
- 'sdr_age' is the age of the sender domain used to filter messages based on SDR.
- 'unit' is the number of 'days,' 'years,' 'months,' or 'weeks' option used to filter messages based on the sender domain age.
- 'operator' are the following comparison operators used to filter messages based on the sender domain age:
 - --> (Greater than)
 - -->= (Greater than or equal to)
 - --< (Lesser than)
 - --<= (Lesser than or equal to)
 - --== (Equal to)
 - --!= (Not equal to)
 - -- Unknown
- 'actual value' is the number used to filter messages based on the sender domain age.

Examples

In the following message, if the age of the sender domain is unknown, the message is dropped.

```
Drop_Messages_Based_On_SDR_Age: if (sdr-age ("unknown", "")) {drop();}
```

In the following message, if the age of the sender domain is less than one month, the message is dropped.

```
Drop_Messages_Based_On_SDR_Age: if (sdr-age ("months", <, 1, "")) { drop(); }
```

Filtering Messages based on Sender Domain Unscannable

Syntax:

```
<msg_filter_name>
if sdr-unscannable (<'domain_exception_list'>)
{<action>}
```

Where:

- 'sdr-unscannable' is the Domain Reputation message filter rule.

'domain_exception_list' is the name of a domain exception list. If a domain exception list is not present it is displayed as "".

Example

In the following message, if the message failed the SDR check, the message is quarantined.

```
Quarantine_Messages_Based_On_Sender_Domain_Unscannable: if (sdr-unscannable (""))  
{quarantine("Policy");}
```

Filtering Messages based on Sender Domain Reputation using Content Filter

Before you begin

- (Optional) Create an address list that contains only domains. To create one, go to *Mail Policies > Address Lists* page in the web interface or use the `addresslistconfig` command in the CLI. For more information, see [Mail Policies, on page 257](#).
- (Optional) Create a Domain Exception List. For more information, see [Creating Domain Exception List, on page 320](#).

Procedure

- Step 1** Go to **Mail Policies > Incoming Content Filters**.
 - Step 2** Click **Add Filter**.
 - Step 3** Enter a name and description for the content filter.
 - Step 4** Click **Add Condition**.
 - Step 5** Click **Domain Reputation**.
 - Step 6** Choose any one of the following conditions to filter messages based on SDR:
 - Select **Sender Domain Reputation Verdict** to choose a verdict range to filter messages based on the verdict received from the SDR service.
Note The recommended blocking threshold is "Awful." For more information about SDR Verdicts, see [SDR Verdicts, on page 313](#).
 - Select **Sender Domain Age**, choose the comparison operator, enter a number, and choose the time period to filter messages based on the age of the sender domain.
 - Select **Sender Domain Reputation Unscannable** to filter messages that failed the SDR check.
 - Step 7** (Optional) Select the list of allow listed domains that you do not want the email gateway to filter messages based on SDR.
 - Step 8** Click **Add Action** to configure an appropriate action to take on messages based on SDR.
 - Step 9** Submit and commit your changes.
-

Creating Domain Exception List

A domain exception list consists of a list of addresses that contain only domains. You can use a domain exception list to skip the SDR check for all incoming messages, irrespective of the mail policies configured on your Cisco Email Security Gateway.



Note If you want to skip SDR content filter actions on incoming messages for specific mail policies, you need to select the domain exception list in the Domain Reputation content filter.

Criteria for using Domain Exception List

By default, to skip the SDR check, the domains in the `Envelope From:`, `From:`, and `Reply-To:` headers of the message must be the same and match the domain configured in the domain exception list. If you want to skip the SDR check based on the domain in the `Envelope From:` header only, select the 'Match Domain Exception List based on Domain in Envelope From:' option in the Domain Reputation settings page.

Procedure

- Step 1** Go to **Security Services > Domain Reputation**.
- Step 2** Click **Edit Settings** under Domain Exception List.
- Step 3** Select the required address list that contains domains only.
- Step 4** Submit and commit your changes.

What to do next

You can also create a Domain Exception List using the `domainreconfig` command in the CLI. For more information, see the *CLI Reference Guide for AsyncOS for Cisco Email Security Appliances*.

Attaching Content Filter to Incoming Mail Policy

You can attach the content filter that you configured to filter messages based on SDR to an incoming mail policy.

Procedure

- Step 1** Go to **Mail Policies > Incoming Mail Policies**.
- Step 2** Click the link below Content Filters.
- Step 3** Make sure to select '**Enable Content Filters (Customize Settings)**.'
- Step 4** Select the content filter that you created for filtering messages based on SDR.
- Step 5** Submit and commit your changes.

Sender Domain Reputation Filtering and Clusters

If you use centralized management, you can enable SDR filtering and mail policies at the cluster, group, and machine level.

Displaying Sender Domain Reputation Details in Message Tracking

You can use Message Tracking to view the message details based on SDR.

Before you begin

- Make sure that you enable the Message Tracking feature on the email gateway. To enable Message Tracking, go to **Security Services > Message Tracking** page in the web interface.
- Content or message filters for filtering messages based on SDR are operational.

Procedure

-
- Step 1** Go to **Monitor > Message Tracking**.
 - Step 2** Click **Advanced**.
 - Step 3** Check **Sender Domain Reputation** under Message Event.
 - Step 4** Select the required SDR verdict(s) to view messages based on the verdict received from the SDR service.
 - Step 5** (Optional) Check **Unscannable** to view messages when the SDR check failed.
 - Step 6** (Optional) Select the required SDR threat categories to view messages based on the threat category.
 - Step 7** Click **Search**.
-

Viewing Alerts

The following table lists the system alert generated for SDR, including a description of the alert and the alert severity.

Component/Alert Name	Message and Description	Parameters
MAIL.IMH.SENDER_DOMAIN_LOOKUP_FAILURE_ALERTS	The SDR lookup failed. Reason - <\$reason> Warning. Sent when a SDR query fails.	'reason' - The reason why the SDR query failed.

Viewing Logs

The SDR filtering information is posted to the Mail Logs. Most information is at the Info or Debug level.

Examples of SDR Filtering Log Entries

The SDR filtering information is posted to the Mail Logs. Most information is at the Info or Debug level.

- [Sender Domain Reputation Authentication Failure, on page 322](#)
- [Sender Domain Reputation Request Timeout, on page 322](#)
- [Sender Domain Reputation Invalid Host, on page 323](#)
- [Sender Domain Reputation General Errors, on page 323](#)

Sender Domain Reputation Authentication Failure

In this example, the log shows a message that was not filtered based on SDR because of an authentication failure when connecting to the SDR service.

```
Mon Jul 2 08:57:18 2018 Info: New SMTP ICID 3 interface Management (192.0.2.10) address
224.0.0.10 reverse dns host unknown verified no
Mon Jul 2 08:57:18 2018 Info: ICID 3 ACCEPT SG UNKNOWNLIST match ipr[none] ipr not enabled
country not enabled
Mon Jul 2 08:57:18 2018 Info: Start MID 3 ICID 3
Mon Jul 2 08:57:18 2018 Info: MID 3 ICID 3 From: <sender1@example.com>
Mon Jul 2 08:57:18 2018 Info: MID 3 ICID 3 RID 0 To: <recipient1@example.com>
Mon Jul 2 08:57:18 2018 Info: MID 3 Message-ID '<000001cba32e$f24ff2e0$d6efd8a0$@com>' Mon
Jul 2 08:57:18 2018 Info: MID 3 Subject 'Message 001'
Mon Jul 2 08:57:19 2018 Info: MID 3 SDR: Message was not scanned for Sender Domain Reputation.
Reason: Authentication failure.
```

Solution

Use the `sdradvancedconfig` command in the CLI to configure the required parameters when connecting your email gateway to the SDR service.

Sender Domain Reputation Request Timeout

In this example, the log shows a message that was not filtered based on SDR because of a request timeout error when communicating with the SDR service.

```
Mon Jul 2 09:00:13 2018 Info: New SMTP ICID 4 interface Management (192.0.2.10) address
224.0.0.10 reverse dns host unknown verified no
Mon Jul 2 09:00:13 2018 Info: ICID 4 ACCEPT SG UNKNOWNLIST match ipr[none] ipr not enabled
country not enabled
Mon Jul 2 09:00:13 2018 Info: Start MID 4 ICID 4
Mon Jul 2 09:00:13 2018 Info: MID 4 ICID 4 From: <sender1@example.com>
Mon Jul 2 09:00:13 2018 Info: MID 4 ICID 4 RID 0 To: <recipient1@example.com >
Mon Jul 2 09:00:13 2018 Info: MID 4 Message-ID '<000001cba32e$f24ff2e0$d6efd8a0$@com>'
Mon Jul 2 09:00:13 2018 Info: MID 4 Subject 'Message 001'
Mon Jul 2 09:00:13 2018 Info: MID 4 SDR: Message was not scanned for Sender Domain Reputation.
Reason: Request timed out.
```

Solution

When an SDR request times out, the message is marked as unscannable, and the configured actions are applied to the message.

Sender Domain Reputation Invalid Host

In this example, the log shows a message that was not filtered based on SDR because an invalid SDR service host was configured on your email gateway.

```
Mon Jul 2 09:04:08 2018 Info: ICID 7 ACCEPT SG UNKNOWNLIST match ipr[none] ipr not enabled
country not enabled
Mon Jul 2 09:04:08 2018 Info: Start MID 7 ICID 7
Mon Jul 2 09:04:08 2018 Info: MID 7 ICID 7 From: <sender1@example.com >
Mon Jul 2 09:04:08 2018 Info: MID 7 ICID 7 RID 0 To: <recipient1@example.com >
Mon Jul 2 09:04:08 2018 Info: MID 7 Message-ID '<000001cba32e$f24ff2e0$d6efd8a0$@com>' Mon
Jul 2 09:04:08 2018 Info: MID 7 Subject 'Message 001'
Mon Jul 2 09:04:08 2018 Info: MID 7 SDR: Message was not scanned for Sender Domain Reputation.
Reason: Invalid host configured.
```

Solution

Use the `sdradvancedconfig` command in the CLI to configure the required parameters when connecting your email gateway to the SDR service.

Sender Domain Reputation General Errors

In this example, the log shows a message that was not filtered based on SDR because of an unknown error.

```
Mon Jul 2 09:00:13 2018 Info: New SMTP ICID 4 interface Management (192.0.2.10) address
224.0.0.10 reverse dns host unknown verified no
Mon Jul 2 09:00:13 2018 Info: ICID 4 ACCEPT SG UNKNOWNLIST match ipr[none] ipr not enabled
country not enabled
Mon Jul 2 09:00:13 2018 Info: Start MID 4 ICID 4
Mon Jul 2 09:00:13 2018 Info: MID 4 ICID 4 From: <sender1@example.com >
Mon Jul 2 09:00:13 2018 Info: MID 4 ICID 4 RID 0 To: <recipient1@example.com >
Mon Jul 2 09:00:13 2018 Info: MID 4 Message-ID '<000001cba32e$f24ff2e0$d6efd8a0$@com>'
Mon Jul 2 09:00:13 2018 Info: MID 4 Subject 'Test mail'
Mon Jul 2 09:00:13 2018 Info: MID 4 SDR: Message was not scanned for Sender Domain Reputation.
Reason: Unknown error.
```

Solution

When an unknown error occurs, the message is marked as unscannable, and the configured actions are applied to the message.



CHAPTER 14

Integrating with Cisco Threat Response

This chapter contains the following sections:

- [Integrating the Appliance with Cisco Threat Response, on page 325](#)
- [Performing Threat Analysis using Casebooks, on page 327](#)
- [Improving User Experience of Email Gateway using Cisco Success Network, on page 330](#)

Integrating the Appliance with Cisco Threat Response

You can integrate your appliance with Cisco Threat Response, and perform the following actions in Cisco Threat Response:

- View the email reporting, message tracking, and web tracking data from multiple appliances in your organization.
- Identify, investigate and remediate threats observed in the email reports, message tracking, and web tracking.
- Resolve the identified threats rapidly and provide recommended actions to take against the identified threats.
- Document the threats to save the investigation, and enable collaboration of information among other devices.



Note In a clustered configuration, you can only register your logged-in appliance with Cisco Threat Response in the machine mode. If you have already registered your appliance with Cisco Threat Response in the standalone mode, make sure to deregister the appliance manually before you join it to a cluster.

To integrate your appliance with Cisco Threat Response, you need to register your appliance with Cisco Threat Response.

You can access Cisco Threat Response using any one of the following URLs:

- <https://visibility.amp.cisco.com>
- <https://visibility.eu.amp.cisco.com/>
- <https://visibility.apjc.amp.cisco.com>

Before you begin

- Make sure that you create a user account in Cisco Threat Response with admin access rights. To create a new user account, go to Cisco Threat Response login page using the following URL - <https://visibility.amp.cisco.com> and click **Create a Cisco Security account** in the login page. If you are unable to create a new user account, contact Cisco TAC for assistance.
- Make sure that you enable Cisco Threat Response integration on the Cisco Security Services Exchange (SSE) portal. For more information, go to <https://securex.us.security.cisco.com/settings/modules/available>, navigate to the module to integrate with Cisco Threat Response, click **Add New Module**, and see the instructions on the page.
- [Only if you are not using a proxy server.] Make sure that you open HTTPS (In and Out) 443 port on the firewall for the following FQDNs to register your appliance with Cisco Threat Response:
 - api-sse.cisco.com (applicable for Americas users only)
 - api.eu.sse.itd.cisco.com (applicable for European Union (EU) users only)
 - api.apj.sse.itd.cisco.com (applicable for APJC users only)
 - est.sco.cisco.com (applicable for Americas, EU, and APJC users)

For more information, see [Firewall Information, on page 1289](#).

Procedure

-
- Step 1** Log in to your appliance.
 - Step 2** Select **Networks > Cloud Service Settings**.
 - Step 3** Click **Edit Settings**.
 - Step 4** Check **Enable**.
 - Step 5** Choose the required Cisco Threat Response server to connect your appliance to Cisco Threat Response.
 - Step 6** Submit and commit your changes.
 - Step 7** Navigate back to the Cloud Service Settings page after few minutes to register your appliance with Cisco Threat Response.
 - Step 8** Obtain a registration token from Cisco Threat Response to register your appliance with Cisco Threat Response. For more information, go to <https://securex.us.security.cisco.com/settings/modules/available>, navigate to the module to integrate with Cisco Threat Response, click **Add New Module**, and see the instructions on the page.
 - Step 9** Enter the registration token obtained from Cisco Threat Response and click **Register**.
 - Step 10** Add your appliance as an integration module to Cisco Threat Response. For more information, go to <https://securex.us.security.cisco.com/settings/modules/available>, navigate to the module to integrate with Cisco Threat Response, click **Add New Module**, and see the instructions on the page.
-

What to do next

After you add your appliance as an integration module in Cisco Threat Response, you can view the email reporting, message tracking, and web tracking information from your appliance in Cisco Threat Response. For more information, go to <https://securex.us.security.cisco.com/settings/modules/available>, navigate to the

module to integrate with Cisco Threat Response, click **Add New Module**, and see the instructions on the page.



Note To deregister your appliance connection from Cisco Threat Response, click **Deregister** in the Cloud Services Settings page in your appliance.

Performing Threat Analysis using Casebooks

The casebook and pivot menu are widgets available in Cisco Threat Response.

Casebook - It is used to record, organize, and share sets of observables of interest primarily during an investigation and threat analysis. You can use a casebook to get the current verdicts or dispositions on the observables. For more information, see the Cisco Threat Response documentation at <https://visibility.amp.cisco.com/#/help/casebooks>.

Pivot Menu - It is used to pivot an observable to a new case, an existing case, or to other devices registered in Cisco Threat Response (for example, AMP for Endpoints, Cisco Umbrella, Cisco Talos Intelligence, and so on) to investigate for threat analysis. For more information, see the Cisco Threat Response documentation at <https://visibility.amp.cisco.com/#/help/pivot-menus>.

The Email Security appliance now includes the casebook and pivot menu widgets. You can perform the following actions in your appliance using the casebook and pivot menu widgets:

- Add an observable to a casebook to investigate for threat analysis.
- Pivot an observable to a new case, an existing case, or other devices registered in Cisco Threat Response (for example, AMP for Endpoints, Cisco Umbrella, Cisco Talos Intelligence, and so on) to investigate for threat analysis.

The following is a list of observables supported for this release:

- IP addresses
- Domains
- URLs
- File Hashes (SHA-256 only)



Note

- The pivot menu widget is positioned next to the observables in the email reporting pages of your appliance.
- The casebook widget is positioned at the bottom-right corner of the email reporting pages of your appliance.

Related Topics

- [Obtaining Client ID and Client Password Credentials, on page 328](#)
- [Adding Observable to Casebook for Threat Analysis, on page 329](#)

Obtaining Client ID and Client Password Credentials

You need the client ID and client password to access the casebook and pivot menu widgets on your appliance.

Before you begin

Make sure that you meet all the prerequisites mentioned in the ‘Before you begin’ section of [Integrating the Appliance with Cisco Threat Response, on page 325](#)

Procedure

-
- Step 1** Log in to the new web interface of your appliance. For more information, see [Accessing the Web-Based Graphical User Interface \(GUI\), on page 30](#).
- Step 2** Click the **Casebook**  button.
- Step 3** Add a new API Client.
- a) Click the **Threat Response API Clients** link.

When you click on the Threat Response API Clients link, it redirects you to Cisco Threat Response login page.
 - b) Log in to Cisco Threat Response.
 - c) Click **Add API Credentials**.
 - d) Enter the name of your appliance (for example, ‘Email_Security_Appliance’) as the client name.
 - e) Select the following scopes to provide full access to the casebook and pivot menu widgets:
 - Casebook
 - Enrich
 - Private Intelligence
 - Response
 - Inspect

Note

 - If you want to access the casebook widget only, select the following scopes - casebook, private intelligence, and inspect.
 - If you want to access the pivot menu widget only, select the following scopes - enrich and response.
 - f) Click **Add New Client**.
 - g) Copy the client ID and client password to the clipboard.

Note Make sure that you note the client ID and client password before you close the ‘Add New Client’ dialog box.
 - h) Click **Close**.

Note If you want to add a new API client, you do not need to delete the existing API client.

- Step 4** Enter the client ID and client password obtained in Step 3 in the ‘Login to use Casebook/Pivot Menu’ dialog box in your appliance.
- Step 5** Select the required Cisco Threat Response server in the ‘Login to use Casebook/Pivot Menu’ dialog box.
- Step 6** Click **Authenticate**.

Note If you want to edit the client ID, client password, and Cisco Threat Response server, right-click on the Casebook  button and add the details.

What to do next

Add an observable to a casebook to investigate for threat analysis. See [Adding Observable to Casebook for Threat Analysis, on page 329](#)

Adding Observable to Casebook for Threat Analysis



Before you begin

Make sure that you obtain the client ID and client password to access the casebook and pivot menu widgets on your appliance. For more information, see [Obtaining Client ID and Client Password Credentials, on page 328](#).

Procedure

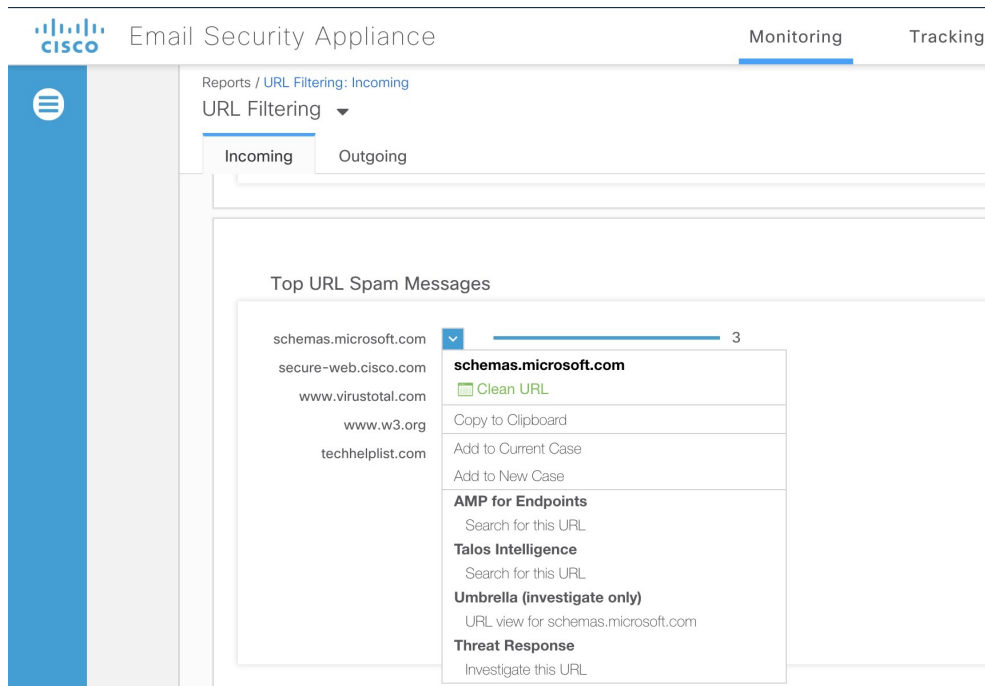
-
- Step 1** Log in to the new web interface of your appliance. For more information, see [Accessing the Web-Based Graphical User Interface \(GUI\), on page 30](#).
- Step 2** Navigate to the Email Reporting page, click on the pivot menu  button next to the required observable (for example, schemas.microsoft.com) and click **Add to New Case** or **Add to Current Case**.

**Note**

- Use the drag and drop  button next to the observable to drag and drop the observable into an existing case.
- Use the pivot menu  button to pivot an observable to other devices registered on the portal (for example, AMP for Endpoints) to investigate for threat analysis.

Step 3 Click the **Casebook**  button to check whether the observable is added to a new or an existing case.

Step 4 (Optional) Click  button to add a title, description, or notes to the casebook.

Step 5 Click **Investigate this Case** to investigate the observable for threat analysis. For more information, see the Cisco Threat Response documentation at <https://visibility.amp.cisco.com/#/help/introduction>.

Improving User Experience of Email Gateway using Cisco Success Network

Overview

You can use the Cisco Success Network (CSN) feature to send your email gateway and feature usage details to Cisco. These details are used by Cisco to identify the email gateway version and the features activated but not enabled on your email gateway.

The ability to send your email gateway and feature usage details to Cisco helps an organization to:

- Improve the effectiveness of the product in user networks by performing analytics on collected telemetry data and suggesting users with recommendations using a digital campaign.

- Improve user experience with email gateway.

The following table shows a sample data of email gateway and feature usage details sent to Cisco:

Statistics	Sample Data
Email Gateway Details	
UID	4215XXXXXXXXXXXXXXXXXX-XXXXXXXXXXXX
Model	C100V
sIVAN	Email Gateway (for a smart license) or null (for a classic license)
Deployment	Cluster/Standalone.
userAccountID	Enter SLPIID (in smart license) or VLNID (in classic license).
Version	1X.X.X-XXX
Install Date	1582535814000 (milli-seconds since epoch)
Feature Information	
Name	Email Gateway Feature
Enabled	Yes
Status	In Compliance
Expiry Date	1831591683 (seconds since epoch)
Feature ID	a4deXXXX-XXXX-XXXX-XXXX-XXXXXXXXXXXX

Related Topics

- [Enabling CSN on Email Gateway, on page 331](#)
- [Disabling CSN on Email Gateway, on page 332](#)

Enabling CSN on Email Gateway

Before you begin

Make sure that you enable and register your email gateway with Cisco Threat Response. For more information, see [Integrating with Cisco Threat Response, on page 325](#)

Procedure

-
- Step 1** Go to **Security Services > Cloud Service Settings**.

- Step 2** Click **Edit Settings** under Cisco Success Network. **Edit Global Settings**.
 - Step 3** Check the **Enable** checkbox.
 - Step 4** Submit and commit your changes.
-

Disabling CSN on Email Gateway

Procedure

- Step 1** Go to **Security Services > Cloud Service Settings**.
 - Step 2** Click **Edit Settings** under Cisco Success Network. **Edit Global Settings**.
 - Step 3** Uncheck the **Enable** checkbox.
 - Step 4** Submit and commit your changes.
-



CHAPTER 15

Configuring Email Gateway to Safe Print Message Attachments

This chapter contains the following sections:

- [Overview](#) , on page 333
- [How to Configure Email Gateway to Safe Print Message Attachments](#), on page 334
- [Configuring Safe Print Settings on Email Gateway](#), on page 334
- [Configuring Content Filter to Safe Print Message Attachments](#), on page 335
- [Attaching Content Filter to Incoming Mail Policy](#), on page 337
- [Safe Print Settings and Clusters](#), on page 338
- [Monitoring Messages with Safe-Printed Attachments](#), on page 338
- [Viewing Logs](#), on page 338
- [Displaying Safe Print Details in Message Tracking](#), on page 339

Overview

You can configure your email gateway to provide a safe view (safe-printed PDF version) of a message attachment detected as malicious or suspicious. The safe view of the message attachment is delivered to the end user and the original attachment is stripped from the message. You can use the 'Safe Print' content filter action to safe print all message attachments that match a configured content filter condition.

The ability to safe print message attachments in the email gateway helps an organization to:

- Prevent message attachments with malicious or suspicious content from entering an organization network.
- View malicious or suspicious message attachments without being affected by the malware.
- Deliver the original message attachment based on the end-user request.

The following languages are supported for the Safe-Print feature - English, Italian, Portuguese, Spanish, German, French, Japanese, Chinese (PRC and Taiwan), Russian, and Korean.

How to Configure Email Gateway to Safe Print Message Attachments

Steps	Do This	More Information
Step 1	Configure safe print settings on the email gateway.	Configuring Safe Print Settings on Email Gateway, on page 334
Step 2	Configure a content filter to safe print message attachments.	Configuring Content Filter to Safe Print Message Attachments, on page 335
Step 3	Attach the content filter that you configured to safe print message attachments to an incoming mail policy.	Attaching Content Filter to Incoming Mail Policy, on page 337

Configuring Safe Print Settings on Email Gateway

Procedure

- Step 1** Click **Security Services > Scan Behavior**.
- Step 2** Click **Edit Global Settings**.
- Step 3** Enter the required parameters described in the following table to configure safe print settings on the email gateway.

Parameter Source Details	Description
Safe Print Settings	
Maximum File Size	<p>Enter the maximum attachment size for a safe-printed attachment.</p> <p>Note Make sure that the 'Maximum File Size' value does not exceed the 'Maximum attachment size to scan' value configured in the Scan Behavior > Global Settings page.</p> <p>Note If the 'Maximum File Size' value exceeds the 'Maximum Message Size to Scan' value configured for Outbreak Filters on your email gateway, then the message and the message attachment is not scanned by Outbreak Filters in the email pipeline.</p>
Maximum Page Count	Enter the maximum number of pages that you want to safe print in a message attachment.

Parameter Source Details	Description
Document Quality	Select the Use Default Value (70) option to use the recommended image quality value for a safe-printed attachment. Note You can also select the Enter Custom Value option and enter a custom image quantity value for a safe-printed attachment.
File Type Selection	Select the required file types from the appropriate file groups (for example, "Microsoft Documents") that you can use to safe print a message attachment.
Watermark	Select Enabled option to add a watermark to a safe-printed attachment. Note You can enter a custom text for the watermark in the Enter Custom Text: field.
Cover Page	Select Enabled option to add a cover page to a safe-printed attachment. Note You can enter a custom text for the cover page in the Enter Custom Text field.

Step 4 Submit and commit your changes.

What to do next

Configure a content filter to safe print a message attachment. For more information, see [Configuring Content Filter to Safe Print Message Attachments, on page 335](#).

Configuring Content Filter to Safe Print Message Attachments

Use the 'Safe Print' content filter action to safe print a message attachment

You can use the Safe Print content filter action in any one of the following ways::

- Safe print matching attachments option
- Safe print all attachments option

Table 36:

Safe Print Action Option	Usage	Example	Supported Content Filter Conditions
Safe print matching attachments	Use the 'Safe print matching attachments' option to safe print all message attachments that match a configured content filter condition.	<p>Configure the 'Macro Detection' content filter condition and select the 'Safe Print Matching Attachments' option.</p> <p>If an incoming message contains three message attachments - 'docx1,' 'docx2,' and 'docx3' and the email gateway detects a macro in 'docx1,' then only 'docx1' is safe-printed.</p>	<p>The following are the content filter conditions that you can only use with the 'Safe print matching attachments' option:</p> <ul style="list-style-type: none"> • URL Reputation • URL Category • Macro Detection • Attachment Content • Attachment File Info
Safe print all attachments	Use the 'Safe print all attachments' option to safe print all message attachments when the configured content filter condition is true.	<p>Configure the 'Envelope Sender' content filter condition and select the 'Safe Print all attachments' option.</p> <p>If an incoming message from a sender 'user1@example.com' contains three message attachments - 'docx1,' 'docx2,' and 'ppt1' then all the message attachments - 'docx1,' 'docx2,' and 'ppt1' are safe-printed based on the following:</p> <ul style="list-style-type: none"> • File types selected in the Scan Behavior > Safe Print Settings page. • The user1@example.com sender matches the LDAP group directory configured in the 'Envelope Sender' content filter condition. 	<p>You can use any one of the content filter conditions available in your email gateway with the 'Safe print all attachments' option.</p>

As an example, use the following procedure to safe print message attachments that contain macros using the 'Macro Detection' condition and 'Safe Print' action.

Before you begin

Make sure that you have configured safe print settings on the email gateway. See [Configuring Safe Print Settings on Email Gateway, on page 334](#)

Procedure

- Step 1** Go to **Mail Policies > Incoming Content Filters**.
- Step 2** Click **Add Filter**.
- Step 3** Enter a name and description for the content filter.
- Step 4** Click **Add Condition**.
- Step 5** Click **Macro Detection**.
- Step 6** Select the file types that you want the email gateway to detect for macros and click **Add**.
- Step 7** Click **OK**.
- Step 8** Click **Add Action**.
- Step 9** Click **Safe Print**.
- Step 10** Select any one of the following actions to take on message attachments:
- Select **Safe print matching attachments** option to safe print all message attachments that match the configured Macro Detection content filter condition.
 - Select **Safe print all attachments** option to safe print all message attachments when the configured Macro Detection content filter condition is true
- Step 11** Select **Yes** to strip a message attachment that is marked as unscannable.
- A message attachment is marked as unscannable due to any one of the following reasons:
- Message contains an attachment that is encrypted.
 - Message contains an attachment that is corrupt.
 - I/O error occurs when performing a safe print action on the message attachment.
 - Timeout error occurs when performing a safe print action on the message attachment.
- Note** By default, a system generated message is added as an attachment text file when an attachment is unscannable. You can enter a custom message in the **Custom Replacement Message** field.
- Step 12** Click **OK**.
- Step 13** Submit and commit your changes.
-

Attaching Content Filter to Incoming Mail Policy

You can attach the content filter that you configured to safe print a message attachment to an incoming mail policy.

Procedure

- Step 1** Go to **Mail Policies > Incoming Mail Policies**.
- Step 2** Click the link below Content Filters.
- Step 3** Make sure to select '**Enable Content Filters (Customize Settings)**.'
- Step 4** Select the content filter that you created to safe print a message attachment.
- Step 5** Submit and commit your changes.
-

Safe Print Settings and Clusters

If you use centralized management, you can configure safe print settings on the email gateway and mail policies at the cluster, group, and machine level.

Monitoring Messages with Safe-Printed Attachments

You can use the Safe Print report page to view:

- Number of safe-printed attachments based on the file type in graphical format.
- Summary of safe-printed attachments based on the file type in tabular format.

In the 'Summary of Safe Print File Types' section, click the total number of safe-printed attachments to view the message details in Message Tracking.

Viewing Logs

The log information about safe print is posted to the Mail Logs. Most information is at the Info or Debug level.

Examples of Safe Print Log Entries

The safe print information is posted to the Mail Logs. Most information is at the Info or Debug level.

- I/O Errors
 - [Unable to Create Temporary Directory, on page 339](#)
 - [Unable to Create Safe-printed PDF Attachment, on page 339](#)
- [Corrupt File, on page 339](#)
- [Encrypted File, on page 339](#)
- [Timeout Error, on page 339](#)

Unable to Create Temporary Directory

In this example, the log shows that a message attachment was not safe-printed because your email gateway was unable to create a temporary directory to save the file.

```
Sat Jul 20 05:53:48 2019 Info: MID 5 Unable to safe print the attachment,
Filename:test_file.docx, Reason: IO error occurred during safeprinting of the attachment
Sat Jul 20 05:53:48 2019 Trace: MID 5 Unable to safe print the attachment,
Filename:test_file.docx, Exception: Unable to create tmp directory for safeprinting document:
[Errno 2] No such file or directory: '/tmp/test_file.docx'
```

Unable to Create Safe-printed PDF Attachment

In this example, the log shows that a message attachment was not safe-printed because your email gateway was unable to create a safe-printed PDF attachment.

```
Thu Jul 11 07:19:01 2019 Info: MID 132 Unable to safe print the attachment,
Filename:test_file.docx, Reason: IO error occurred during safeprinting of the attachment
Thu Jul 11 07:19:01 2019 Trace: MID 132 Unable to safe print the attachment,
Filename:test_file.docx, Exception: Error while creating safeprinted PDF document:
[Errno 2] No such file or directory: '/tmp/test_file.docx/safe_print_test_file.pdf'
```

Corrupt File

In this example, the log shows that a message attachment was not safe-printed because the file was corrupt

```
Thu Jul 11 08:34:31 2019 Info: MID 142 Unable to safe print the attachment,
Filename:corrupt_file=20(1).docx, Reason: The attachment is corrupted
```

Encrypted File

In this example, the log shows that a message attachment was not safe-printed because the file was encrypted.

```
Thu Jul 11 08:34:31 2019 Info: MID 142 Unable to safe print the attachment,
Filename:sept_subscription.pdf, Reason: The attachment is encrypted.
```

Timeout Error

In this example, the log shows that a message attachment was not safe-printed because of a timeout error.

```
Thu Jul 11 10:32:29 2019 Info: MID 165 Unable to safe print the attachment,
Filename:20_page.docx, Reason: A timeout error occurred when trying to safe print the
attachment
```

Displaying Safe Print Details in Message Tracking

Use Message Tracking to view the details of messages that contain safe-printed attachments.

Before you begin

- Make sure that you enable the Message Tracking feature on the email gateway. To enable Message Tracking, go to **Security Services > Message Tracking** page in the legacy web interface of your email gateway.
- Content filters configured to safe print message attachments are operational.

Procedure

- Step 1** [New Web Interface only] Go to **Tracking > Message Tracking**.
OR
[Legacy Web interface only] Go to **Monitor > Message Tracking**.
- Step 2** [New Web Interface] Click **Advanced Search**.
OR
[Legacy Web interface only] Click **Advanced**.
- Step 3** Check **Safe Print** under Message Event to view the details of messages that contain safe-printed attachments.
- Step 4** Enter the required search options and click **Search**.
-



CHAPTER 16

Anti-Virus

This chapter contains the following sections:

- [Anti-Virus Scanning Overview, on page 341](#)
- [Sophos Anti-Virus Filtering, on page 342](#)
- [McAfee Anti-Virus Filtering, on page 345](#)
- [How to Configure the Appliance to Scan for Viruses , on page 346](#)
- [Sending an Email to the Appliance to Test Anti-Virus Scanning , on page 355](#)
- [Updating Virus Definitions, on page 357](#)

Anti-Virus Scanning Overview

The appliance includes integrated virus scanning engines from third party companies Sophos and McAfee. You can obtain license keys for the appliance to scan messages for viruses using one or both of these virus scanning engines, and then configure your appliance to scan for viruses using either anti-virus scanning engine.

The McAfee and Sophos engines contain the program logic necessary to scan files at particular points, process and pattern-match virus definitions with data they find in your files, decrypt and run virus code in an emulated environment, apply heuristic techniques to recognize new viruses, and remove infectious code from legitimate files.

You can configure the appliance to scan messages for viruses (based on the matching incoming or outgoing mail policy), and, if a virus is found, to perform different actions on the message (including “repairing” the message of viruses, modifying the subject header, adding an additional X-header, sending the message to an alternate address or mailhost, archiving the message, or deleting the message).

If enabled, virus scanning is performed in the “work queue” on the appliance , immediately after Anti-Spam scanning. (See [Email Pipeline and Security Services, on page 62.](#))

By default, virus scanning is enabled for the default incoming and outgoing mail policies.

Related Topics

- [Evaluation Key, on page 342](#)
- [Scanning Messages with Multiple Anti-Virus Scanning Engines, on page 342](#)

Evaluation Key

Your appliance ships with a 30-day evaluation key for each available anti-virus scanning engine. You enable the evaluation key by accessing the license agreement in the System Setup Wizard or Security Services > Sophos/McAfee Anti-Virus pages (in the GUI) or running the `antivirusconfig` or `systemsetup` commands (in the CLI). Once you have accepted the agreement, the Anti-Virus scanning engine will be enabled, by default, for the default incoming and outgoing mail policies. For information on enabling the feature beyond the 30-day evaluation period, contact your Cisco sales representative. You can see how much time remains on the evaluation via the **System Administration > Feature Keys** page or by issuing the `featurekey` command. (For more information, see [Feature Keys, on page 986](#).)

Scanning Messages with Multiple Anti-Virus Scanning Engines

AsyncOS supports scanning messages with multiple anti-virus scanning engines — multi-layer anti-virus scanning. You can configure your appliance to use one or both of the licensed anti-virus scanning engines on a per mail policy basis. You could create a mail policy for executives, for example, and configure that policy to scan mail with both Sophos and McAfee engines.

Scanning messages with multiple scanning engines provides “defense in depth” by combining the benefits of both Sophos and McAfee anti-virus scanning engines. Each engine has leading anti-virus capture rates, but because each engine relies on a separate base of technology (discussed in [McAfee Anti-Virus Filtering, on page 345](#) and [Sophos Anti-Virus Filtering, on page 342](#)) for detecting viruses, the multi-scan approach can be even more effective. Using multiple scanning engines can lead to reduced system throughput, please contact your Cisco support representative for more information.

You cannot configure the order of virus scanning. When you enable multi-layer anti-virus scanning, the McAfee engine scans for viruses first, and the Sophos engine scans for viruses second. If the McAfee engine determines that a message is virus-free, the Sophos engine scans the message, adding a second layer of protection. If the McAfee engine determines that a message contains a virus, the appliance skips Sophos scanning and performs actions on the virus message based on settings you configured.

Sophos Anti-Virus Filtering

The appliance includes integrated virus-scanning technology from Sophos, Plc. Sophos Anti-Virus provides cross-platform anti-virus protection, detection and disinfection.

Sophos Anti-Virus provides a virus detection engine that scans files for viruses, Trojan horses, and worms. These programs come under the generic term of *malware*, meaning “malicious software.” The similarities between all types of malware allow anti-virus scanners to detect and remove not only viruses, but also all types of malicious software.

Related Topics

- [Virus Detection Engine, on page 343](#)
- [Virus Scanning, on page 343](#)
- [Detection Methods, on page 343](#)
- [Virus Descriptions, on page 344](#)
- [Sophos Alerts, on page 344](#)
- [When a Virus is Found, on page 344](#)

Virus Detection Engine

The Sophos virus detection engine lies at the heart of the Sophos Anti-Virus technology. It uses a proprietary architecture similar to Microsoft's COM (Component Object Model), consisting of a number of objects with well-defined interfaces. The modular filing system used by the engine is based on separate, self-contained dynamic libraries each handling a different "storage class," for example, file type. This approach allows virus scanning operations to be applied on generic data sources, irrespective of type.

Specialized technology for loading and searching data enables the engine to achieve very fast scanning speeds. Incorporated within it are:

- A full code emulator for detecting polymorphic viruses
- An on-line decompressor for scanning inside archive files
- An OLE2 engine for detecting and disinfecting macro viruses

The appliance integrates with the virus engine using SAV Interface.

Virus Scanning

In broad terms, the engine's scanning capability is managed by a powerful combination of two important components: a classifier that knows where to look, and the virus database that knows what to look for. The engine classifies the file by type rather than by relying on the extension.

The virus engine looks for viruses in the bodies and attachments of messages received by the system; an attachment's file type helps determine its scanning. For example, if a message's attached file is an executable, the engine examines the header which tells it where the executable code starts and it looks there. If the file is a Word document, the engine looks in the macro streams. If it is a MIME file, the format used for mail messaging, it looks in the place where the attachment is stored.

Detection Methods

How viruses are detected depends on their type. During the scanning process, the engine analyzes each file, identifies the type, and then applies the relevant technique(s). Underlying all methods is the basic concept of looking for certain types of instructions or certain ordering of instructions.

Related Topics

- [Pattern Matching, on page 343](#)
- [Heuristics, on page 344](#)
- [Emulation, on page 344](#)

Pattern Matching

In the technique of pattern matching, the engine knows the particular sequence of code and is looking for an exact match that will identify the code as a virus. More often, the engine is looking for sequences of code that are similar, but not necessarily identical, to the known sequences of virus code. In creating the descriptions against which files are compared during scanning, Sophos virus researchers endeavor to keep the identifying code as general as possible so that – using heuristics, as explained below – the engine will find not just the original virus but also its later derivatives.

Heuristics

The virus engine can combine basic pattern matching techniques with heuristics – a technique using general rather than specific rules – to detect several viruses in the same family, even though Sophos researchers might have analyzed only one virus in that family. The technique enables a single description to be created that will catch several variants of one virus. Sophos tempers its heuristics with other methods, minimizing the incidence of false positives.

Emulation

Emulation is a technique applied by the virus engine to polymorphic viruses. Polymorphic viruses are encrypted viruses that modify themselves in an effort to hide themselves. There is no visible constant virus code and the virus encrypts itself differently each time it spreads. When it runs, it decrypts itself. The emulator in the virus detection engine is used on DOS and Windows executables, while polymorphic macro viruses are found by detection code written in Sophos's Virus Description Language.

The output of this decryption is the real virus code and it is this output that is detected by the Sophos virus detection engine after running in the emulator.

Executables that are sent to the engine for scanning are run inside the emulator, which tracks the decryption of the virus body as it is written to memory. Normally the virus entry point sits at the front end of a file and is the first thing to run. In most cases, only a small amount of the virus body has to be decrypted in order for the virus to be recognized. Most clean executables stop emulating after only a few instructions, which reduces overhead.

Because the emulator runs in a restricted area, if the code does turn out to be a virus, the virus does not infect the appliance .

Virus Descriptions

Sophos exchanges viruses with other trusted anti-virus companies every month. In addition, every month customers send thousands of suspect files directly to Sophos, about 30% of which turn out to be viruses. Each sample undergoes rigorous analysis in the highly secure virus labs to determine whether or not it is a virus. For each newly discovered virus, or group of viruses, Sophos creates a description.

Sophos Alerts

Cisco encourages customers who enable Sophos Anti-Virus scanning to subscribe to Sophos alerts on the Sophos site at <http://www.sophos.com/virusinfo/notifications/>. Subscribing to receive alerts directly from Sophos will ensure you are apprised of the latest virus outbreaks and their available solutions.

When a Virus is Found

When a virus has been detected, Sophos Anti-Virus can repair (disinfect) the file. Sophos Anti-Virus can usually repair any file in which a virus has been found, after which the file can be used without risk. The precise action taken depends on the virus.

There can be limitations when it comes to disinfecting, because it is not always possible to return a file to its original state. Some viruses overwrite part of the executable program which cannot be reinstated. In this instance, you define how to handle messages with attachments that could not be repaired. You configure these settings on a per-recipient basis using the Email Security Feature: the **Mail Policies > Incoming or Outgoing**

Mail Policies pages (GUI) or the `policyconfig -> antivirus` command (CLI). For more information on configuring these settings, see [Configuring Virus Scanning Actions for Users, on page 347](#).

McAfee Anti-Virus Filtering

The McAfee® scanning engine:

- Scans files by pattern-matching virus signatures with data from your files.
- Decrypts and runs virus code in an emulated environment.
- Applies heuristic techniques to recognize new viruses.
- Removes infectious code from files.

Related Topics

- [Pattern-Matching Virus Signatures, on page 345](#)
- [Encrypted Polymorphic Virus Detection, on page 345](#)
- [Heuristics Analysis, on page 345](#)
- [When a Virus is Found, on page 344](#)

Pattern-Matching Virus Signatures

McAfee uses anti-virus definition (DAT) files with the scanning engine to detect particular viruses, types of viruses, or other potentially unwanted software. Together, they can detect a simple virus by starting from a known place in a file, then searching for a virus signature. Often, they must search only a small part of a file to determine that the file is free from viruses.

Encrypted Polymorphic Virus Detection

Complex viruses avoid detection with signature scanning by using two popular techniques:

- **Encryption.** The data inside the virus is encrypted so that anti-virus scanners cannot see the messages or computer code of the virus. When the virus is activated, it converts itself into a working version, then executes.
- **Polymorphism.** This process is similar to encryption, except that when the virus replicates itself, it changes its appearance.

To counteract such viruses, the engine uses a technique called emulation. If the engine suspects that a file contains such a virus, the engine creates an artificial environment in which the virus can run harmlessly until it has decoded itself and its true form becomes visible. The engine can then identify the virus by scanning for a virus signature, as usual.

Heuristics Analysis

Using only virus signatures, the engine cannot detect a new virus because its signature is not yet known. Therefore the engine can use an additional technique — heuristic analysis.

Programs, documents or email messages that carry a virus often have distinctive features. They might attempt unprompted modification of files, invoke mail clients, or use other means to replicate themselves. The engine analyzes the program code to detect these kinds of computer instructions. The engine also searches for legitimate

non-virus-like behavior, such as prompting the user before taking action, and thereby avoids raising false alarms.

By using these techniques, the engine can detect many new viruses.

When a Virus is Found

When a virus has been detected, Sophos Anti-Virus can repair (disinfect) the file. Sophos Anti-Virus can usually repair any file in which a virus has been found, after which the file can be used without risk. The precise action taken depends on the virus.

There can be limitations when it comes to disinfecting, because it is not always possible to return a file to its original state. Some viruses overwrite part of the executable program which cannot be reinstated. In this instance, you define how to handle messages with attachments that could not be repaired. You configure these settings on a per-recipient basis using the Email Security Feature: the **Mail Policies > Incoming or Outgoing Mail Policies** pages (GUI) or the `policyconfig -> antivirus` command (CLI). For more information on configuring these settings, see [Configuring Virus Scanning Actions for Users](#), on page 347.

How to Configure the Appliance to Scan for Viruses

How to Scan Messages for Viruses

	Do This	More Info
Step 1	Enable anti-virus scanning on the appliance .	Enabling Virus Scanning and Configuring Global Settings , on page 347
Step 2	Define the groups of users whose messages you want to scan for viruses.	Creating a Mail Policy for a Group of Senders and Recipients , on page 264
Step 3	(Optional) Configure how you want the virus quarantine to handle messages.	Configuring Policy, Virus, and Outbreak Quarantines , on page 903
Step 4	Determine how you want the appliance to handle messages with viruses.	Configuring Virus Scanning Actions for Users , on page 347
Step 5	Configure the anti-virus scanning rules for the user groups you defined.	Configuring the Anti-Virus Policies for Different Groups of Senders and Recipients , on page 352
Step 6	(Optional) Send an email message to test the configuration.	Sending an Email to the Appliance to Test Anti-Virus Scanning , on page 355

Related Topics

- [Enabling Virus Scanning and Configuring Global Settings](#) , on page 347
- [Configuring Virus Scanning Actions for Users](#), on page 347
- [Configuring the Anti-Virus Policies for Different Groups of Senders and Recipients](#), on page 352
- [Notes on Anti-Virus Configurations](#), on page 353
- [Flow Diagram for Anti-Virus Actions](#), on page 354

Enabling Virus Scanning and Configuring Global Settings

You may have enabled a virus scanning engine when you ran the System Setup Wizard. Regardless, configure settings using this procedure.



Note Depending on your feature keys, you can enable Sophos, McAfee, or both.

Procedure

- Step 1** Navigate to the **Security Services > McAfee** page.
Or
Navigate to the **Security Services > Sophos** page.
- Step 2** Click **Enable**.
- Note** Clicking **Enable** enables the feature globally for the appliance. However, you must later enable per-recipient settings in Mail Policies.
- Step 3** After reading the license agreement, scroll to the bottom of the page and click **Accept** to accept the agreement.
- Step 4** Click **Edit Global Settings**.
- Step 5** Choose a maximum virus scanning timeout value.
Configure a timeout value for the system to stop performing anti-virus scanning on a message. The default value is 60 seconds.
- Step 6** (Optional) Click **Enable Automatic Updates** to enable automatic update of the engine.
The appliance fetches the required updates for the particular engine from the update server.
- Step 7** Submit and commit your changes.
-

What to do next

Configure anti-virus settings on a per-recipient basis. See [Configuring Virus Scanning Actions for Users](#), on page 347.

Configuring Virus Scanning Actions for Users

The virus scanning engine integrated into the appliance processes messages for viruses for incoming and outgoing mail based on policies (configuration options) you configure using the Email Security Manager feature. You enable Anti-Virus actions on a per-recipient basis using the Mail Policies > Incoming or Outgoing Mail Policies pages (GUI) or the `policyconfig > antivir` command (CLI).

Related Topics

- [Message Scanning Settings](#), on page 348
- [Message Handling Settings](#), on page 348

- [Configuring Settings for Message Handling Actions, on page 349](#)

Message Scanning Settings

- Scan for Viruses Only:

Messages processed by the system are scanned for viruses. Repairs are *not* attempted for infected attachments. You can choose whether to drop attachments and deliver mail for messages that contain viruses or could not be repaired.

- Scan and Repair Viruses:

Messages processed by the system are scanned for viruses. If a virus is found in an attachment, the system will attempt to “repair” the attachment.

- Dropping Attachments

You can choose to drop infected attachments.

When infected attachments to messages have been scanned and *dropped* by the anti-virus scanning engine, the attachment is replaced with a new attachment called “Removed Attachment.” The attachment type is text/plain and contains the following:

```
This attachment contained a virus and was stripped.
```

```
Filename: filename
```

```
Content-Type: application/filetype
```

Users will always be notified if their messages were modified in any way because they were infected with a bad attachment. You can configure a secondary notification action, as well (see [Sending Notifications, on page 351](#)). The notify action is *not* needed to inform users that a message was modified if you choose to drop infected attachments.

- X-IronPort-AV Header

All messages that are processed by the Anti-Virus scanning engine on the appliance have the header X-IronPort-AV: added to messages. This header provides additional information to you when debugging issues with your anti-virus configuration, particularly with messages that are considered “unscannable.” You can toggle whether the X-IronPort-AV header is included in messages that are scanned. Including this header is recommended.

Message Handling Settings

You configure the virus scanning engine to handle four distinct classes of messages that are received by a listener, with separate actions for each. *Figure - Options for Handling Messages Scanned for Viruses* summarizes the actions the system performs when the virus scanning engine is enabled.

For each of the following message types, you can choose which actions are performed. The actions are described below (see [Configuring Settings for Message Handling Actions, on page 349](#)). For example, you can configure your anti- virus settings for virus-infected messages so that the infected attachment is dropped, the subject of the email is modified, and a custom alert is sent to the message recipient.

Repaired Message Handling

Messages are considered *repaired* if the message was completely scanned and all viruses have been repaired or removed. These messages will be delivered as is.

Encrypted Message Handling

Messages are considered encrypted if the engine is unable to finish the scan due to an encrypted or protected field in the message. Messages that are marked encrypted may also be repaired.

Note the differences between the encryption detection message filter rule (see [Encryption Detection Rule, on page 164](#)) and the virus scanning actions for “encrypted” messages. The encrypted message filter rule evaluates to “true” for any messages that are PGP or S/MIME encrypted. The encrypted rule can only detect PGP and S/MIME encrypted data. It does not detect password protected ZIP files, or Microsoft Word and Excel documents that include encrypted content. The virus scanning engine considers any message or attachment that is password protected to be “encrypted.”



Note If you upgrade from a 3.8 or earlier version of AsyncOS and you configured Sophos Anti-Virus scanning, you must configure the Encrypted Message Handling section after you upgrade.

Unscannable Message Handling

Messages are considered unscannable if a scanning timeout value has been reached, or the engine becomes unavailable due to an internal error. Messages that are marked unscannable may also be repaired.

Virus Infected Message Handling

The system may be unable to drop the attachment or completely repair a message. In these cases, you can configure how the system handles messages that could still contain viruses.

The configuration options are the same for encrypted messages, unscannable messages, and virus messages.

Configuring Settings for Message Handling Actions

- [Action to Apply, on page 349](#)
- [Quarantines and Anti-Virus Scanning, on page 350](#)
- [Modify the Message Subject Header, on page 350](#)
- [Archive Original Message, on page 350](#)
- [Sending Notifications, on page 351](#)
- [Add Custom Header to Message, on page 351](#)
- [Modify Message Recipient, on page 351](#)
- [Send Message to Alternate Destination Host, on page 351](#)
- [Send Custom Alert Notification, on page 352](#)

Action to Apply

Choose which overall action to take on each message type for encrypted, unscannable, or virus positive messages: drop the message, deliver the message as an attachment to a new message, deliver the message as is, or send the message to the anti-virus quarantine area ([Quarantines and Anti-Virus Scanning, on page 350](#)).

Configuring the appliance to deliver the infected messages as an attachment to a new message allows the recipient to choose how to deal with the original, infected attachment.

If you choose to deliver the message or deliver the message as an attachment to a new message, you can additionally:

- Modify message subject

- Archive original message
- Send generic notification
- Add custom header to message
- Modify message recipient
- Send message to alternate destination host
- Send custom alert notification



Note These actions are not mutually exclusive; you can combine some or all of them differently within different incoming or outgoing policies for different processing needs for groups of users. See the following sections and [Notes on Anti-Virus Configurations, on page 353](#) for more information on defining various scanning policies using these options.

Repaired messages have only two advanced options: Add custom header and Send custom alert notification. All other message types have access to all of the advanced options.

Quarantines and Anti-Virus Scanning

When flagged for quarantine, the message continues through the rest of the email pipeline. When the message reaches the end of the pipeline, if the message has been flagged for one or more quarantines then it enters those queues. Note that if the message does not reach the end of the pipeline, it is not placed in a quarantine.

For example, a content filter can cause a message to be dropped or bounced, in which case the message will not be quarantined.

Archive Original Message

You can archive messages the system has identified as containing (or possibly containing) viruses to the “avarchive” directory. The format is an mbox-format log file. You *must* configure an “Anti-Virus Archive” log subscription to archive messages with viruses or messages that could not be completely scanned. For more information, see [Logging, on page 1113](#)



Note In the GUI, you may need to click the “Advanced” link to reveal the “Archive original message” setting.

Modify the Message Subject Header

You can alter the text of identified messages by prepending or appending certain text strings to help users more easily identify and sort identified messages.



Note White space is not ignored in the “Modify message subject” field. Add spaces after (if prepending) or before (if appending) the text you enter in this field to separate your added text from the original subject of the message. For example, add the text [WARNING: VIRUS REMOVED] with a few trailing spaces if you are prepending.

The default text is:

Default Subject Line Text for Anti-Virus Subject Line Modification

Verdict	Default Text to Add to Subject
Encrypted	[WARNING: MESSAGE ENCRYPTED]
Infected	[WARNING: VIRUS DETECTED]
Repaired	[WARNING: VIRUS REMOVED]
Unscannable	[WARNING: A/V UNSCANNABLE]

Any message with multiple states causes a multi-part notification message informing users what actions the appliance performed on the message (for example, the user is notified that the message was repaired of a virus, but another part of the message was encrypted).

Sending Notifications

When the system has identified a message as containing viruses, you can send the default notification to the sender, the recipient, and/or additional users. When specifying additional users to notify, separate multiple addresses with commas (in both the CLI and the GUI). The default notification messages are:

Default Notifications for Anti-Virus Notifications

Verdict	Notification
Repaired	The following virus(es) was detected in a mail message: <virus name(s)> Actions taken: Infected attachment dropped (or Infected attachment repaired).
Encrypted	The following message could not be fully scanned by the anti-virus engine due to encryption.
Unscannable	The following message could not be fully scanned by the anti-virus engine.
Infectious	The following unrepairable virus(es) was detected in a mail message: <virus name(s)>.

Add Custom Header to Message

You can define an additional, custom header to be added to all messages that are scanned by the anti-virus scanning engine. Click **Yes** and define the header name and text.

You can also create filters that use the `skip-viruscheck` action so that certain messages bypass virus scanning. See [Bypass Anti-Virus System Action, on page 212](#).

Modify Message Recipient

You can modify the message recipient, causing the message to be delivered to a different address. Click **Yes** and enter the new recipient address.

Send Message to Alternate Destination Host

You can choose to send the notification to a different recipient or destination host for encrypted, unscannable, or virus infected messages. Click **Yes** and enter an alternate address or host.

For example, you could route suspected messages to an administrator's mailbox or a special mail server for subsequent examination. In the case of a multi-recipient message, only a single copy is sent to the alternative recipient.

Send Custom Alert Notification

You can send a custom notification to the sender, recipient, and/or other users (email addresses). To do so, you must first create the custom notification prior to configuring the settings. See [Understanding Text Resources, on page 627](#) for more information.

Figure 18: Options for Handling Messages Scanned for Viruses

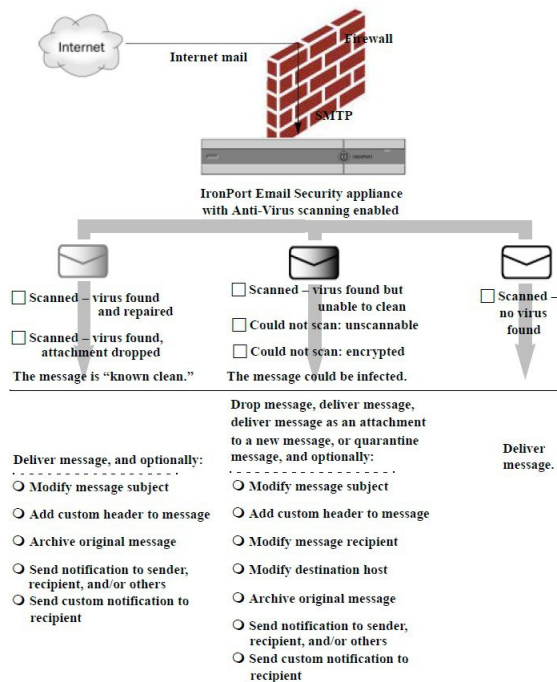

Note By default, Anti-Virus scanning is enabled in the \$TRUSTED mail flow policy for public listeners, which is referenced by the ALLOWED_LIST sender group. See [Defining Access Rules for Email Senders Using Mail Flow Policies, on page 99](#).

Configuring the Anti-Virus Policies for Different Groups of Senders and Recipients

The process for editing the per-user anti-virus settings for a mail policy is essentially the same for incoming or outgoing mail.

Individual policies (not the default) have an additional field to "Use Default" settings. Select this setting to inherit the default mail policy settings.

You enable anti-virus actions on a per-recipient basis using Incoming or Outgoing Mail Policies. You can configure mail policies in the GUI or in the CLI using the `policyconfig > antivirus` command. After you enable anti-virus settings globally, you configure these actions separately for each mail policy you create. You can configure different actions for different mail policies.

Procedure

- Step 1** Navigate to the Mail Policies > Incoming Mail Policies or Mail Policies > Outgoing Mail Policies page.
- Step 2** Click the link for the anti-virus security service for the policy you want to configure.
- Note** Click the link in the default row to edit the settings for the default policy.
- Step 3** Click **Yes** or **Use Default** to enable Anti-Virus Scanning for the policy.
- The first setting on the page defines whether the service is enabled for the policy. You can click **Disable** to disable the service altogether.
- For mail policies other than the default, choosing “Yes” enables the fields in the Repaired, Encrypted, Unscannable, and Virus Infected Messages areas to become active.
- Step 4** Select an Anti-Virus scanning engine. You can select McAfee or Sophos engines.
- Step 5** Configure Message Scanning settings.
- See [Message Scanning Settings, on page 348](#) for more information.
- Step 6** Configure settings for Repaired, Encrypted, Unscannable, and Virus Infected messages.
- See [Message Handling Settings, on page 348](#) and [Configuring Settings for Message Handling Actions, on page 349](#).
- Step 7** Click **Submit**.
- Step 8** Commit your changes.
-

Notes on Anti-Virus Configurations

The drop attachments flag makes a considerable difference in how anti-virus scanning works. When the system is configured to “Drop infected attachments if a virus is found and it could not be repaired,” any viral or unscannable MIME parts are removed from messages. The output from Anti-Virus scanning, then, is almost always a clean message. The action defined for *Unscannable Messages*, as shown in the GUI pane, rarely takes place.

In a “Scan for Viruses only” environment, these actions “clean” messages by dropping the bad message parts. Only if the RFC822 headers themselves are attacked or encounter some other problem would this result in the unscannable actions taking place. However, when Anti-Virus scanning is configured for “Scan for Viruses only” and “Drop infected attachments if a virus is found and it could not be repaired,” is *not* chosen, the unscannable actions are very likely to take place.

The following table lists some common Anti-Virus configuration options

Common Anti-Virus Configuration Options

Situation	Anti-Virus Configuration
<p>Widespread Virus Outbreak</p> <p>Any viral message is simply dropped from the system with little other processing taking place.</p>	<p>Drop-attachments: NO</p> <p>Scanning: Scan-Only</p> <p>Cleaned messages: Deliver</p> <p>Unscannable messages: DROP message</p> <p>Encrypted messages: Send to administrator or quarantine for review.</p> <p>Viral messages: Drop message</p>
<p>Liberal Policy</p> <p>As many documents as possible are sent.</p>	<p>Drop-attachments: YES</p> <p>Scanning: Scan and Repair</p> <p>Cleaned messages: [VIRUS REMOVED] and Deliver</p> <p>Unscannable messages: Forward as attachment</p> <p>Encrypted messages: Mark and forward</p> <p>Viral messages: Quarantine or mark and forward.</p>
<p>More Conservative Policy</p>	<p>Drop-attachments: YES</p> <p>Scanning: Scan and Repair</p> <p>Cleaned messages: [VIRUS REMOVED] and Deliver (Archive cleaned messages for a more cautious policy.)</p> <p>Unscannable messages: Send notification(s), quarantine, OR drop and archive.</p> <p>Encrypted messages: Mark and forward OR treat as unscannable</p> <p>Viral messages: Archive and drop</p>
<p>Conservative with Review</p> <p>Possible virus messages are sent to a quarantine mailbox so that an administrator can review the content.</p>	<p>Drop-attachments: NO</p> <p>Scanning: Scan-Only</p> <p>Cleaned messages: Deliver (this action won't normally be taken)</p> <p>Unscannable messages: Forward as attachment, alt-src-host , or alt-rcpt-to actions.</p> <p>Encrypted messages: Treat as unscannable</p> <p>Viral messages: Forward to quarantine or administrator.</p>

Flow Diagram for Anti-Virus Actions

The following figure explains how anti-virus actions and options affect messages processed by the appliance

Figure 19: Flow Diagram for Anti-Virus Actions

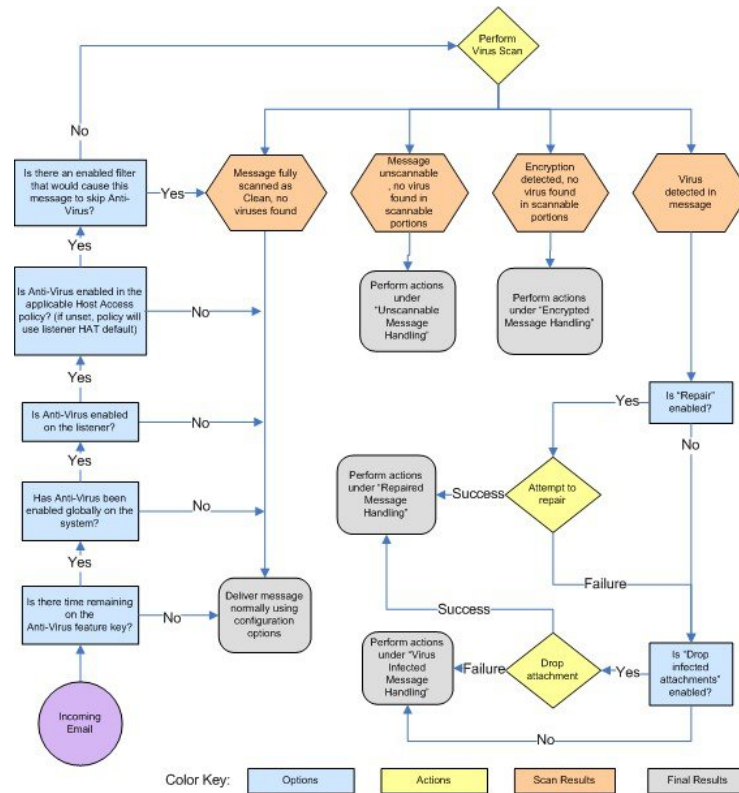

Note If you configure multi-layer anti-virus scanning, the Cisco appliance performs virus scanning with the McAfee engine first and the Sophos engine second. It scans messages using both engines, unless the McAfee engine detects a virus. If the McAfee engine detects a virus, the appliance performs the anti-virus actions (repairing, quarantining, etc.) defined for the mail policy.

Sending an Email to the Appliance to Test Anti-Virus Scanning

Procedure

Step 1 Enable virus scanning for a mail policy.

Use the **Security Services > Sophos/McAfee Anti-virus** page or the `antivirusconfig` command to set global settings, and then use the Email Security Manager pages (GUI) or the `antivirus` subcommand of `policyconfig` to configure the settings for a specific mail policy.

Step 2 Open a standard text editor, then type the following character string as *one line, with no spaces or line breaks*:

```
X50!P%@AP[4\PZX54(P^7CC)7}$EICAR-STANDARD-ANTIVIRUS-TEST-FILE!$H+H*
```

Note The line shown above should appear as one line in your text editor window, so be sure to maximize your text editor window and delete any line breaks. Also, be sure to type the letter O, not the number 0, in the “X5O...” that begins the test message.

If you are reading this manual on your computer, you can copy the line directly from the PDF file or HTML file and paste it into your text editor. If you copy the line, be sure to delete any extra carriage returns or spaces.

Step 3 Save the file with the name `EICAR.COM`.

The file size will be 68 or 70 bytes.

Note This file is not a virus — it cannot spread or infect other files, or otherwise harm your computer. However, you should delete the file when you have finished testing your scanner to avoid alarming other users.

Step 4 Attach the file `EICAR.COM` to an email message, and send it to the listener that will match the mail policy you configured in step 1.

Ensure that the recipient you specify in the test message will be accepted on the listener. (For more information, see [Adding Domains and Users For Which to Accept Messages, on page 127](#).)

Note that it may be difficult to email the file if you have virus scanning software installed for outgoing mail on a gateway other than the Cisco (for example, a Microsoft Exchange server).

Note The test file always scans as unrepairable.

Step 5 Evaluate the actions you configured for virus scanning on the listener and ensure they are enabled and working as expected.

This is most easily accomplished by performing one of the following actions:

- a. Configure the virus scanning settings to Scan and Repair mode or Scan only mode without dropping attachments.
 - Send an email with the Eicar test file as an attachment. Confirm that the actions taken match your configuration for Virus Infected Message Handling (the settings in [Virus Infected Message Handling, on page 349](#)).
- b. Configure the virus scanning settings to Scan and Repair mode or Scan only mode with dropping attachments.
 - Send an email with the Eicar test file as an attachment.
 - Confirm that the actions taken match your configuration for Repaired Message Handling (the settings in [Repaired Message Handling, on page 348](#)).

For more information obtaining virus files for testing anti-virus scanning, see:

http://www.eicar.org/anti_virus_test_file.htm

This page provides 4 files for downloading. Note that it may be difficult to download and extract these files if you have a client-side virus scanning software installed.

Updating Virus Definitions

Related Topics

- [About Retrieving Anti-Virus Updates via HTTP](#) , on page 357
- [Configuring Update Server Settings](#) , on page 357
- [Monitoring and Manually Checking for Anti-Virus Updates](#), on page 357
- [Verifying Anti-Virus Files Have Updated on the Appliance](#) , on page 358

About Retrieving Anti-Virus Updates via HTTP

Sophos and McAfee frequently update their virus definitions with newly-identified viruses. These updates must be passed to your appliance .

By default, the appliance is configured to check for updates every 5 minutes. For the Sophos and McAfee anti-virus engines, the server updates from a dynamic website.

The system does not timeout on updates as long as the update is actively downloading to the appliance . If the update download pauses for too long, then the download times out.

The maximum amount of time that the system waits for an update to complete before timing out is a dynamic value that is defined as 1 minute less than the anti-virus update interval (defined on Security Services > Service Updates). This configuration value aids appliances on slower connections while downloading large updates that may take longer than 10 minutes to complete.

Configuring Update Server Settings

You can configure virus update settings via the Security Services > Service Updates page. For example, you can configure how the system receives anti-virus updates and how often it checks for updates. For more information about these additional settings, see [Service Updates](#) , on page 1003.

Monitoring and Manually Checking for Anti-Virus Updates

You can use the **Security Services > Sophos or McAfee** page or the `antivirusstatus` CLI command to verify the appliance has the latest anti-virus engine and identity files installed, and to confirm when the last update was performed.

You can also manually perform updates. See [Manually Updating Anti-Virus Engines](#) , on page 357

Manually Updating Anti-Virus Engines

Procedure

- Step 1** Navigate to the Security Services > Sophos or McAfee Anti-Virus page.
- Step 2** Click **Update Now** in the Current McAfee/Sophos Anti-Virus Files table.

The appliance checks for and downloads the latest updates.

What to do next

You can also configure this in the command-line interface using the `antivirusstatus` and `antivirusupdate` command

Verifying Anti-Virus Files Have Updated on the Appliance

You can view the Updater Logs to verify whether or not the antivirus files have been successfully downloaded, extracted, or updated. Use the tail command to show the final entries in the Updater log subscription to ensure that virus updates were obtained.

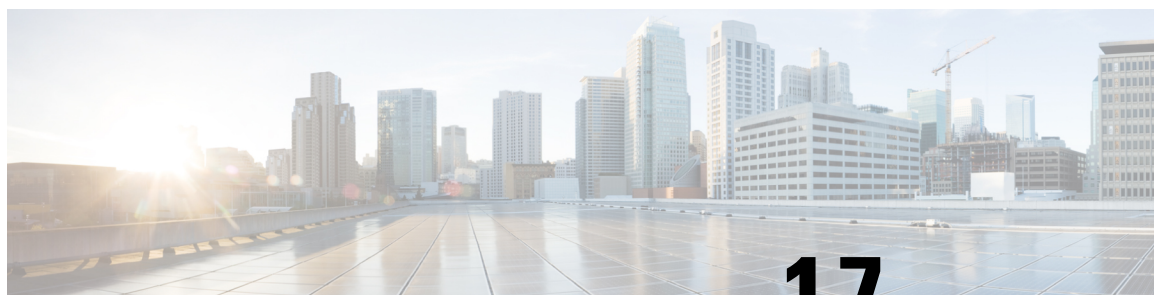

CHAPTER 17

Managing Spam and Graymail

This chapter contains the following sections:

- [Overview of Anti-Spam Scanning](#) , on page 359
- [How to Configure the Appliance to Scan Messages for Spam](#), on page 360
- [IronPort Anti-Spam Filtering](#), on page 361
- [Configuring Intelligent Multi-Scan and Graymail Detection](#), on page 365
- [Defining Anti-Spam Policies](#) , on page 376
- [Protecting Appliance -Generated Messages From the Spam Filter](#), on page 382
- [Headers Added During Anti-Spam Scanning](#) , on page 383
- [Reporting Incorrectly Classified Messages to Cisco](#), on page 383
- [Determining Sender IP Address In Deployments with Incoming Relays](#) , on page 388
- [Monitoring Rules Updates](#), on page 397
- [Testing Anti-Spam](#), on page 398

Overview of Anti-Spam Scanning

Anti-spam processes scan email for incoming (and outgoing) mail based on the mail policies that you configure.

- One or more scanning engines scan messages through their filtering modules.
- Scanning engines assign a score to each message. The higher the score, the greater the likelihood that the message is spam.
- Based on the score, each message is categorized as one of the following:
 - Not spam
 - Suspected spam
 - Positively-identified spam
- An action is taken based on the result.

Actions taken on messages positively identified as spam, suspected to be spam, or identified as unwanted marketing messages are not mutually exclusive; you can combine some or all of them differently within different incoming or outgoing policies for different processing needs for groups of users. You can also treat positively identified spam differently from suspected spam in the same policy. For example, you may want to drop messages positively identified as spam, but quarantine suspected spam messages.

For each mail policy, you can specify thresholds for some of the categories, and determine the action to take for each category. You can assign different users to different mail policies and define different scanning engines, spam-definition thresholds, and spam-handling actions for each policy.



Note For information about how and when anti-spam scanning is applied, see [Email Pipeline and Security Services, on page 62](#).

Related Topics

- [Anti-Spam Solutions](#) , on page 360

Anti-Spam Solutions

Your appliance offers the following anti-spam solutions:

- [IronPort Anti-Spam Filtering, on page 361](#).
- [Configuring Intelligent Multi-Scan and Graymail Detection, on page 365](#).

You can license and enable both these solutions on your appliance , but you can only use one in a particular mail policy. You can specify a different anti-spam solution for different groups of users.

How to Configure the Appliance to Scan Messages for Spam

Procedure

	Command or Action	Purpose
Step 1	Enable anti-spam scanning on the appliance .	<p>Note Remaining steps in this table apply to both scanning engine options.</p> <p>If you have feature keys for both Cisco IronPort Anti-Spam and Intelligent Multi-Scan, you can enable both solutions on the appliance .</p> <ul style="list-style-type: none"> • IronPort Anti-Spam Filtering, on page 361 • Configuring Intelligent Multi-Scan and Graymail Detection, on page 365
Step 2	Configure whether to quarantine spam on the local appliance or use an external quarantine on a Security Management appliance .	<ul style="list-style-type: none"> • Setting Up the Local Spam Quarantine, on page 920 • Working with an External Spam Quarantine , on page 1250
Step 3	Define the groups of users whose messages you want to scan for spam.	Creating a Mail Policy for a Group of Senders and Recipients, on page 264

	Command or Action	Purpose
Step 4	Configure the anti-spam scanning rules for the user groups you defined.	Defining Anti-Spam Policies , on page 376
Step 5	If you want certain messages to skip Cisco Anti-Spam scanning, create message filters that use the skip-spamcheck action.	Bypass Anti-Spam System Action , on page 211
Step 6	(Recommended) Enable IP Reputation Service scoring for each inbound mail flow policy, even if you are not rejecting connections based on IP Reputation Scores.	For each inbound mail flow policy, ensure that “Use SenderBase for Flow Control” is On. See Defining Rules for Incoming Messages Using a Mail Flow Policy , on page 107.
Step 7	If your appliance does not connect directly to external senders to receive incoming mail, but instead receives messages relayed through a mail exchange, mail transfer agent, or other machine on your network, ensure that relayed incoming messages include the original sender IP address.	Determining Sender IP Address In Deployments with Incoming Relays , on page 388
Step 8	Prevent alert and other messages generated by your appliance from being incorrectly identified as spam.	Protecting Appliance -Generated Messages From the Spam Filter , on page 382
Step 9	(Optional) Enable URL filtering to strengthen protection against malicious URLs in messages.	Enable URL Filtering , on page 427
Step 10	Test your configuration.	Testing Anti-Spam , on page 398
Step 11	(Optional) Configure settings for service updates (including anti-spam rules.)	Scanning rules for both anti-spam solutions are retrieved by default from the Cisco update servers. <ul style="list-style-type: none"> • Service Updates , on page 1003 • Updates Through a Proxy Server, on page 1007 • Configuring Server Settings for Downloading Upgrades and Updates , on page 1008

IronPort Anti-Spam Filtering

Related Topics

- [Evaluation Key](#), on page 362
- [Cisco Anti-Spam: an Overview](#) , on page 362
- [Configuring IronPort Anti-Spam Scanning](#), on page 363

Evaluation Key

Your appliance ships with a 30-day evaluation key for the Cisco Anti-Spam software. This key is not enabled until you accept the license agreement in the system setup wizard or Security Services > IronPort Anti-Spam pages (in the GUI) or the `systemsetup` or `antispanconfig` commands (in the CLI). Once you have accepted the agreement, Cisco Anti-Spam will be enabled, by default, for the default incoming Mail Policy. An alert is also sent to the administrator address you configured (see the System Setup Wizard, [Step 2: System](#), on [page 34](#)) noting that the Cisco Anti-Spam license will expire in 30 days. Alerts are sent 30, 15, 5, and 0 days prior to expiration. For information on enabling the feature beyond the 30-day evaluation period, contact your Cisco sales representative. You can see how much time remains on the evaluation via the System Administration > Feature Keys page or by issuing the `featurekey` command. (For more information, see [Feature Keys](#), on [page 986](#).)

Cisco Anti-Spam: an Overview

IronPort Anti-Spam addresses a full range of known threats including spam, phishing and zombie attacks, as well as hard-to-detect low volume, short-lived email threats such as “419” scams. In addition, IronPort Anti-Spam identifies new and evolving blended threats such as spam attacks distributing malicious content through a download URL or an executable.

To identify these threats, IronPort Anti-Spam examines the full context of a message—its content, methods of message construction, the reputation of the sender, the reputation of web sites advertised in the message, and more. IronPort Anti-Spam combines the power of email and web reputation data, leveraging the full power of the world’s largest email and web traffic monitoring network — SenderBase — to detect new attacks as soon as they begin.

IronPort Anti-Spam analyzes over 100,000 message attributes across the following dimensions:

- Email reputation — *who* is sending you this message?
- Message content — *what* content is included in this message?
- Message structure — *how* was this message constructed?
- Web reputation — *where* does the call to action take you?

Analyzing multi-dimensional relationships allows the system to catch a broad range of threats while maintaining accuracy. For example, a message that has content claiming to be from a legitimate financial institution but that is sent from an IP address on a consumer broadband network or that contains a URL hosted on a “zombie” PC will be viewed as suspicious. In contrast, a message coming from a pharmaceutical company with a positive reputation will not be tagged as spam even if the message contains words closely correlated with spam.

Related Topics

- [Spam Scanning for International Regions](#) , on page 362
- [URL-Related Protections and Controls](#) , on page 425

Spam Scanning for International Regions

Cisco Anti-Spam is effective world-wide and uses locale-specific content-aware threat detection techniques. You can also optimize anti-spam scanning for a specific region using a regional rules profile.

- If you receive a large quantity of spam from a particular region outside of the US, you may want to use a regional rules profile to help you stop spam from that region.

For example, China and Taiwan receive a high percentage of spam in traditional or modern Chinese. The Chinese regional rules are optimized for this type of spam. If you receive mail primarily for mainland China, Taiwan, and Hong Kong, Cisco strongly recommends you use the Chinese regional rules profile included with the anti-spam engine.

- If your spam comes primarily from the US or from no one particular region, do not enable regional rules because doing so may reduce capture rates for other types of spam. This is because the regional rules profile optimizes the anti-spam engine for a particular region.

You can enable the regional rules profile when you configure IronPort Anti-Spam Scanning.

Related Topics

- [Configuring IronPort Anti-Spam Scanning, on page 363](#)

Configuring IronPort Anti-Spam Scanning



Note When IronPort Anti-Spam is enabled during system setup, it is enabled for the default incoming mail policy with the default values for the global settings.

Before You Begin

- Determine whether you will use regional scanning. See [Spam Scanning for International Regions](#) , on page 362.

Procedure

-
- Step 1** Select **Security Services > IronPort Anti-Spam**.
- Step 2** If you have not enabled IronPort Anti-Spam in the system setup wizard:
- a) Click **Enable**.
 - b) Scroll to the bottom of the license agreement page and click **Accept** to accept the agreement.
- Step 3** Click **Edit Global Settings**.
- Step 4** Select the check box for **Enable IronPort Anti-Spam Scanning**.
Checking this box enables the feature globally for the appliance .
- Step 5** To optimize the throughput of your appliance while still being able to scan increasingly larger messages sent by spammers, configure the thresholds for message scanning by Cisco Anti-Spam.

Option	Description
Message Scanning Thresholds	<p>a. Enter a value for <i>Always scan messages smaller than</i> —The recommended value is 1 MB or less. Messages smaller than the <i>always scan</i> size will be fully scanned, except in cases of “early exit.” Messages larger than this size are partially scanned if they are smaller than the <i>never scan</i> size.</p> <p>Cisco advises not to exceed 3 MB for the <i>always scan</i> message size. A larger value may result in decreased performance.</p> <p>b. Enter a value for <i>Never scan messages larger than</i> —The recommended value is 2 MB or less. Messages larger than this size will not be scanned by Cisco Anti-Spam and the X-IronPort-Anti-Spam-Filtered: true header will not be added to the message.</p> <p>Cisco advises not to exceed 10 MB for the <i>never scan</i> message size. A larger value may result in decreased performance.</p> <p>For messages larger than the <i>always scan</i> size or smaller than the <i>never scan</i> size, a limited and faster scan is performed.</p> <p>Note If the Outbreak Filters maximum message size is greater than Cisco Anti-Spam’s <i>always scan</i> message, messages smaller than the Outbreak Filters maximum size are fully scanned.</p>
Timeout for Scanning Single Message	<p>Enter the number of seconds to wait for timeout when scanning a message.</p> <p>Enter an integer from 1 to 120. The default value is 60 seconds.</p>
Scanning Profile	<p>Choose from any of the following scanning profiles to catch spam messages:</p> <ul style="list-style-type: none"> • Normal - Enable this option for a balanced approach to block spam. • Aggressive - Enable this option to provide stronger emphasis to block spam. When enabled, tuning the Anti-Spam policy thresholds have more impact on spam detection than the Normal profile with a larger potential for false positives. <p>Note When using the new aggressive scanning profile mail policy adjustments to Anti-Spam thresholds have a larger impact than before. Therefore when enabling the aggressive profile, any Anti-Spam policy thresholds previously adjusted should be reset to default settings and then reevaluated for the best balance of spam catch rate vs. false positive potential.</p> <ul style="list-style-type: none"> • Regional (China) - Enable this only if you receive the bulk of your email from the specified region. The supported region is China. As this option optimizes the anti-spam engine for a particular region, it can reduce capture rates for other types of spam.

Step 6 Submit and commit your changes.

Configuring Intelligent Multi-Scan and Graymail Detection

This section describes how to configure Cisco Intelligent Multi-Scan and Graymail Detection and Safe Unsubscribing:

- [Configuring Cisco Intelligent Multi-Scan, on page 365](#)
- [Configuring Global Settings for Intelligent Multi-Scan and Graymail Detection, on page 375](#)
- [Managing Graymail, on page 366](#)

Configuring Cisco Intelligent Multi-Scan

Cisco Intelligent Multi-Scan incorporates multiple anti-spam scanning engines, including Cisco Anti-Spam, to provide a multi-layer anti-spam solution.

When processed by Cisco Intelligent Multi-Scan:

- A message is first scanned by third-party anti-spam engines.
- Cisco Intelligent Multi-Scan then passes the message and the verdicts of the third-party engines to Cisco Anti-Spam, which assumes responsibility for the final verdict.
- After Cisco Anti-Spam performs its scan, it returns a combined multi-scan score to AsyncOS.
- Combining the benefits of the third-party scanning engines and Cisco Anti-Spam results in more caught spam while maintaining Cisco Anti-Spam's low false positive rate.

You cannot configure the order of the scanning engines used in Cisco Intelligent Multi-Scan; Cisco Anti-Spam will always be the last to scan a message and Cisco Intelligent Multi-Scan will not skip it if a third-party engine determines that a message is spam.

Using Cisco Intelligent Multi-Scan can lead to reduced system throughput. Please contact your Cisco support representative for more information.



Note The Cisco Intelligent Multi-Scan feature key also enables Cisco Anti-Spam on the appliance, giving you the option of enabling either Cisco Intelligent MultiScan or Cisco Anti-Spam for a mail policy.



Important When Cisco Intelligent Multi-Scan is enabled during system setup, it is enabled for the default incoming mail policy with the default values for the global settings.

Before you begin

Activate the feature key for this feature. See [Feature Keys, on page 986](#). You will see the IronPort Intelligent Multi-Scan option only if you have done so.

Procedure

- Step 1** Select **Security Services > IMS and Graymail**.
- Step 2** If you have not enabled Cisco Intelligent Multi-Scan in the system setup wizard:
- Click **Enable**.
 - Scroll to the bottom of the license agreement page and click **Accept** to accept the agreement.
- Step 3** Click **Edit IMS Settings**.
- Step 4** Select the check box for **Enable Intelligent Multi-Scan** enable the feature globally for the appliance . However, you must still enable per-recipient settings in Mail Policies.
- Step 5** (Optional) Click **Edit Global Settings** to configure the threshold for message scanning. For more information about global settings, see [Configuring Global Settings for Intelligent Multi-Scan and Graymail Detection, on page 375](#).
- Step 6** Submit and commit your changes.
-

Managing Graymail

- [Overview of Graymail, on page 366](#)
- [Graymail Management Solution in Email Security Appliance , on page 366](#)
- [How Graymail Management Solution Works, on page 367](#)
- [Configuring Graymail Detection and Safe Unsubscribing, on page 370](#)
- [Troubleshooting Graymail Detection and Safe Unsubscribing, on page 375](#)

Overview of Graymail

Graymail messages are messages that do not fit the definition of spam, for example, newsletters, mailing list subscriptions, social media notifications, and so on. These messages were of use at some point in time, but have subsequently diminished in value to the point where the end user no longer wants to receive them.

The difference between graymail and spam is that the end user intentionally provided an email address at some point (for example, the end user subscribed to a newsletter on an e-commerce website or provided contact details to an organization during a conference) as opposed to spam, messages that the end user did not sign up for.

Graymail Management Solution in Email Security Appliance

The graymail management solution in the appliance comprises of two components: an integrated graymail scanning engine and a cloud-based Unsubscribe Service.

The graymail management solution allows organizations to:

- Identify graymail using the integrated graymail engine and apply appropriate policy controls.
- Provide an easy mechanism for end users to unsubscribe from unwanted messages using Unsubscribe Service.

In addition to these, the graymail management solution also help organizations to provide:

- **Secure unsubscribe option for end users.** Mimicking an unsubscribe option is a popular phishing technique. For this reason, the end users are generally wary of clicking unknown unsubscribe links. For such scenarios, the cloud-based Unsubscribe Service extracts the original unsubscribe URI, checks the reputation of the URI, and then performs the unsubscribe process on behalf of the end user. This protects end users from malicious threats masquerading as unsubscribe links.
- **Uniform subscription management interface for end users.** Different graymail senders use different layouts for displaying unsubscribe links to the users. The users must search for the unsubscribe link in the message body and perform the unsubscribing. Irrespective of the graymail senders, the graymail management solution provides a common layout for displaying unsubscribe links to the users.
- **Better visibility for administrators into various graymail categories.** The graymail engine classifies each graymail into three categories (see [Graymail Classification, on page 367](#)) and the administrators can set policy controls based on these categories.
- **Improved spam efficacy**

Related Topics

- [Graymail Classification, on page 367](#)

Graymail Classification

The graymail engine classifies each graymail into one of the following categories:

- **Marketing Email.** Advertising messages sent by professional marketing groups, for example, bulletins from Amazon.com with details about their newly launched products.
- **Social Network Email.** Notification messages from social networks, dating websites, forums, and so on. Examples include alerts from:
 - LinkedIn, for jobs that you may be interested in
 - CNET forums, when a user responds to your post.
- **Bulk Email.** Advertising messages sent by unrecognized marketing groups, for example, newsletters from TechTarget, a technology media company.

How Graymail Management Solution Works

The following steps illustrates the workflow of graymail management solution:

Figure 20: Graymail Management Solution Workflow

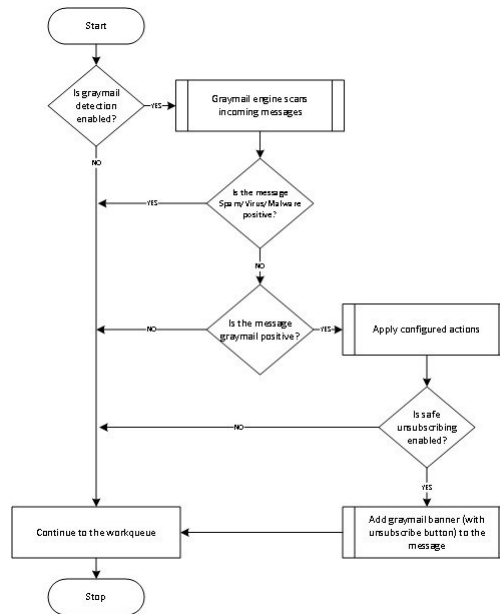

Workflow

Procedure

-
- Step 1** The appliance receives an incoming message.
- Step 2** The appliance checks if graymail detection is enabled. If graymail detection is enabled, go to Step 3. Else, go to Step 8
- Step 3** The appliance checks if the message is spam, virus, or malware positive. If positive, go to Step 8. Else, go to Step 4
- Step 4** The appliance checks if the message is graymail. If the message is graymail, go to Step 5. Else, go to Step 8
- Step 5** The appliance applies the configured policy actions such as, drop, deliver, bounce, or quarantine to the spam quarantine.
- Step 6** The appliance checks if safe unsubscribing enabled. If safe unsubscribing is enabled, go to Step 7. Else, go to Step 8.
- Step 7** The appliance adds a banner with unsubscribe button to the message. Also, the appliance rewrites the existing unsubscribe links in the message body.
- Step 8** The appliance processes the message through the next stages of its email work queue.
-

What to do next

For an overview of how email is processed through the system, from reception to routing to delivery, see [Understanding the Email Pipeline, on page 57](#)

Related Topics

- [How Safe Unsubscribing Works, on page 369](#)

- [Understanding the Email Pipeline, on page 57](#)

How Safe Unsubscribing Works

The following flow diagram shows how safe unsubscribing works.

Figure 21: Safe Unsubscribing Workflow

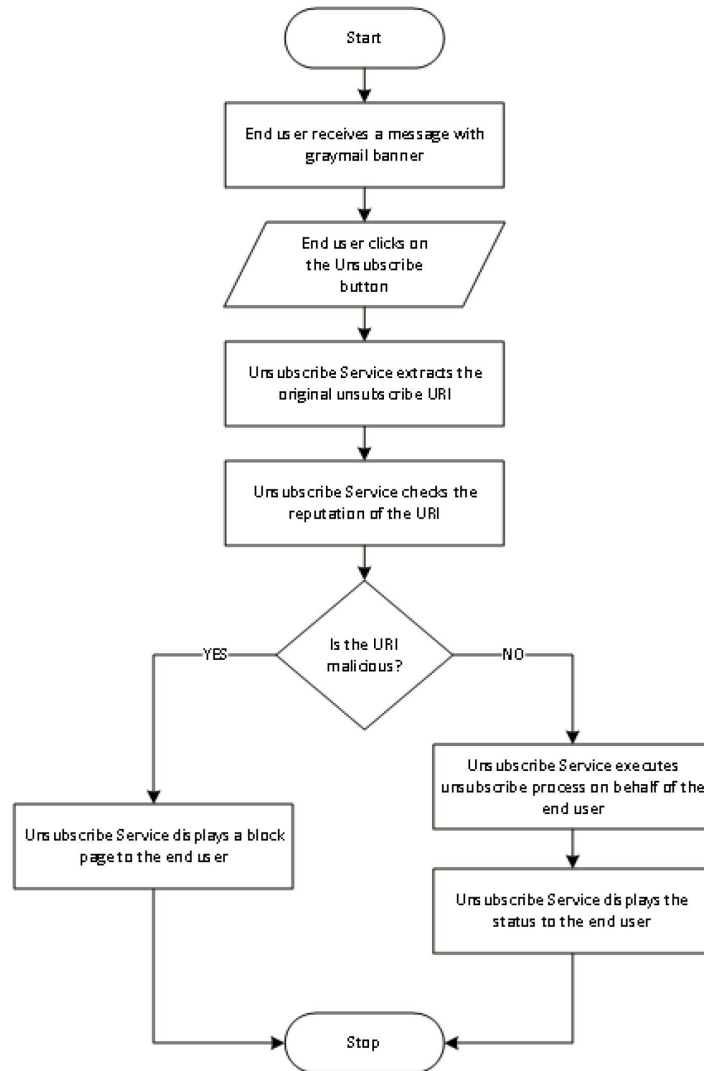

Workflow

Procedure

-
- Step 1** End user receives a message with the graymail banner.
 - Step 2** End user clicks on the Unsubscribe link.

- Step 3** Unsubscribe Service extracts the original unsubscribe URI.
- Step 4** Unsubscribe Service checks the reputation of the URI.
- Step 5** Depending on the reputation of the URI, the Unsubscribe Service performs one of the following actions:
- If the URI is malicious, the Unsubscribe Service will not perform the unsubscribe process and displays a block page to the end user.
 - If the URI is not malicious, depending on the URI type (http or mailto), the Unsubscribe Service sends an unsubscribe request to the graymail sender.
 - If the request is successful, the Unsubscribe Service displays the “Successfully unsubscribed” status to the end user.
 - If the first unsubscribe request fails, the Unsubscribe Service displays the “Unsubscribe process in progress” status and provides a URL that can be used to track the status of the unsubscribing.

End users can use this URL to track the status at a later point. After the first failed attempt, the Unsubscribe Service sends periodic unsubscribe requests for a duration of four hours.

If an end user checks the status of the unsubscribe process at a later point,
 - If one of the requests within the four hour duration (from the first failed attempt) is successful, the Unsubscribe Service displays the “Successfully unsubscribed” status to the end user.
 - If none of the requests within the four hour duration (from the first failed attempt) are successful, the Unsubscribe Service displays the “Unable to subscribe” status to the end user and provides a URL that can be used to unsubscribe from the graymail manually.

Configuring Graymail Detection and Safe Unsubscribing

- [Requirements for Graymail Detection and Safe Unsubscribing, on page 370](#)
- [Graymail Detection and Safe Unsubscribing in Cluster Configurations, on page 371](#)
- [Enable Graymail Detection and Safe Unsubscribing, on page 371](#)
- [Configuring the Incoming Mail Policy for Graymail Detection and Safe Unsubscribing, on page 371](#)
- [IronPort-PHdr Header Added During Graymail Scanning, on page 372](#)
- [Bypassing Graymail Actions using Message Filters, on page 373](#)
- [Monitoring Graymail, on page 373](#)
- [Updating Graymail Rules, on page 374](#)
- [Customizing the Appearance of Unsubscribe Page for End Users, on page 374](#)
- [End-User Safelist, on page 374](#)
- [Viewing Logs, on page 374](#)

Requirements for Graymail Detection and Safe Unsubscribing

- For graymail detection, anti-spam scanning must be enabled globally. This can be either the IronPort Anti-Spam, the Intelligent Multi-Scan feature, or Outbreak Filters. See [Managing Spam and Graymail, on page 359](#).
- For safe unsubscribing,
 - Add the safe unsubscribing feature key.

- The end user machines must be able to connect to the cloud-based Unsubscribe Service directly over the Internet.

Graymail Detection and Safe Unsubscribing in Cluster Configurations

You can enable Graymail Detection and Safe Unsubscribing at the machine, group or cluster level.

Enable Graymail Detection and Safe Unsubscribing

Procedure

- Step 1** Select **Security Services > IMS and Graymail**.
- Step 2** Click **Edit Graymail Settings**.
- Step 3** Check **Enable Graymail Detection**.
- Step 4** Check **Enable Safe Unsubscribe**.
- Step 5** (Optional) Check **Enable Automatic Updates** to enable automatic update of the engine.
The appliance fetches the required updates for the particular engine from the update server.
- Step 6** Click **Submit**.
- Step 7** (Optional) Click **Edit Global Settings** to configure the threshold for scanning the message. For more information, see [Configuring Global Settings for Intelligent Multi-Scan and Graymail Detection, on page 375](#).
- Step 8** Submit and commit your changes.
-

What to do next

To configure Graymail Detection and Safe Unsubscribing global settings in CLI, use the `imsandgraymailconfig` CLI command. For more information, see *CLI Reference Guide for AsyncOS for Cisco Email Security Appliances*.

Configuring the Incoming Mail Policy for Graymail Detection and Safe Unsubscribing

Before You Begin

[Enable Graymail Detection and Safe Unsubscribing, on page 371](#)

Procedure

- Step 1** Click **Mail Policies > Incoming Mail Policies**.
- Step 2** Click the link in the **Graymail** column of the mail policy to modify.
- Step 3** Depending on your requirements, choose the following options:
- Enable graymail detection
 - Enable safe unsubscribing
 - Choose whether to apply the above actions on all messages or only on unsigned messages.

Note The appliance considers a message signed if it is encrypted using S/MIME or it contains an S/MIME signature.

- Actions to be taken on various graymail categories (Marketing Email, Social Network Email, and Bulk Email):

- Drop, deliver, bounce, or quarantine (to the spam quarantine) the message

Note If you plan to use safe unsubscribing option, you must set the action to deliver or quarantine.

- Send the message to an alternate host
- Modify subject of the message
- Add custom headers
- Send the message to an alternate envelope recipient

Note If you are sending a graymail positive message to an alternate envelope recipient, banner will not be added.

- Archive the message

Note If you are planning only to monitor the detected graymail, you can enable graymail detection per policy without having to configure actions for various graymail categories. In this scenario, the appliance takes no action on the detected graymail.

Step 4 Submit and commit your changes.

What to do next



Note You can also configure outgoing mail policies for graymail detection. Keep in mind that, in this scenario, you cannot configure safe unsubscribing.

To configure policy settings for Graymail Detection and Safe Unsubscribing in CLI, use the **policyconfig** command. For more information, see *CLI Reference Guide for AsyncOS for Cisco Email Security Appliances*.

IronPort-PHdr Header Added During Graymail Scanning

The IronPort-PHdr header is added to all messages that are processed by the Graymail engine when:

- Graymail engine is enabled globally on the appliance .
- Graymail scanning is enabled for a specific mail policy.



Note If Graymail scanning is not enabled for a specific mail policy, the IronPort-PHdr header is still added to all messages, if the Graymail engine is enabled globally on the appliance .

The IronPort-PHdr header contains encoded proprietary information and is not customer-decodable. This header provides additional information about debugging issues with your Graymail configuration.



Note If Anti-Spam engine or Outbreak Filter is enabled for a specific mail policy, the IronPort-PHdr header is added to all messages that pass through the specific mail policy.

Bypassing Graymail Actions using Message Filters

If you do not want to apply graymail actions on certain messages, you can use the following message filters to bypass graymail actions:

Message Filter Action	Description
skip-marketingcheck	Bypass actions on marketing emails
skip-socialcheck	Bypass actions on social network emails
skip-bulkcheck	Bypass actions on bulk emails

The following example specifies that messages received on the listener “private_listener” must bypass graymail actions on social network emails.

```
internal_mail_is_safe:
if (recv-listener == 'private_listener')
{
skip-socialcheck
();
}
```

Monitoring Graymail

You can view data about detected graymail using the following reports.

Report	Contains the Following Graymail Data	More Info
Overview page > Incoming Mail Summary	The number of incoming graymail messages under each graymail category (Marketing, Social, and Bulk) and the total number of graymail messages.	Overview Page, on page 812
Incoming Mail page > Top Senders by Graymail Messages	The top graymail senders.	Incoming Mail Page, on page 815
Incoming Mail page > Incoming Mail Details	The number of incoming graymail messages under each graymail category (Marketing, Social, and Bulk) and the total number of graymail messages for all the IP addresses, domain names, or network owners.	
Incoming Mail page > Incoming Mail Details > Sender Profile (drill down view)	The number of incoming graymail messages under each graymail category (Marketing, Social, and Bulk) and the total number of graymail messages for a given IP address, domain name, or network owner.	

Report	Contains the Following Graymail Data	More Info
Internal Users page > Top Users by Graymail	The top end users who receive graymail.	Internal Users Page, on page 823
Internal Users page > User Mail Flow Details	The number of incoming graymail messages under each graymail category (Marketing, Social, and Bulk) and the total number of graymail messages for all the users.	
Internal Users page > User Mail Flow Details > Internal User (drill down view)	The number of incoming graymail messages under each graymail category (Marketing, Social, and Bulk) and the total number of graymail messages for a given user.	

If you had enabled Marketing Email Scanning under anti-spam settings for a mail policy, after upgrading to AsyncOS 9.5 or later, keep in mind that:

- The number of marketing messages is a sum of marketing messages detected before and after the upgrade.
- The total number of graymail messages does not include the number of marketing messages detected before the upgrade.
- The total number of attempted messages also includes the number of marketing messages detected before the upgrade.

Updating Graymail Rules

If you have enabled service updates, scanning rules for the graymail management solution is retrieved from the Cisco update servers. But in some scenarios (for example, you have disabled automatic service updates or automatic service update is not working), you may want to manually update graymail rules.

To manually update the graymail rules, do one of the following:

- In web interface, go to **Security Service > IMS and Graymail** page, and click **Update Now**.
- In CLI, run the `graymailupdate` command.

To know the details of existing graymail rules, see the **Rule Updates** section of the **IMS and Graymail** page in web interface or use the `graymailstatus` command in CLI.

Customizing the Appearance of Unsubscribe Page for End Users

When an end user clicks on unsubscribe link, the Unsubscribe Service displays a Cisco branded Unsubscribe page indicating the status of the unsubscribe process (see [How Safe Unsubscribing Works, on page 369](#)). You can customize the appearance of the Unsubscribe page and display your organization's branding (such as company logo, contact information, and so on) using **Security Services > Block Page Customization**. For instructions, see [Customizing the Notification That End Users See If a Site Is Malicious , on page 431](#).

End-User Safelist

If the end users in your organization have configured Safelist for their own email accounts, graymail messages from a sender in the safelist will not be scanned by the graymail scanning engine. For more information about Safelists, see [Using Safelists and Blocklists to Control Email Delivery Based on Sender , on page 925](#).

Viewing Logs

The graymail detection and safe unsubscribing information is posted to the following logs:

- **Graymail Engine Logs**. Contains information about the graymail engine, status, configuration, and so on. Most information is at Info or Debug level.

- **Graymail Archive.** Contains archived messages (the messages that are scanned and associated with the “archive message” action). The format is an mbox-format log file.
- **Mail Logs.** Contains information about graymail detection and addition of banner for safe unsubscribing. Most information is at Info or Debug level.

Troubleshooting Graymail Detection and Safe Unsubscribing

[Unable to Perform Safe Unsubscribing, on page 375](#)

Unable to Perform Safe Unsubscribing

Problem

After clicking on the Unsubscribe link, the end user sees the following message: “Unable to unsubscribe from...”

Solution

This problem can occur if the Unsubscribe Service is unable to perform the safe unsubscribe on behalf of the end user. The following are some of the common scenarios in which the Unsubscribe Service is unable to perform the safe unsubscribe:

- Unsubscribe URI or mailto address is wrong.
- Websites that require the end users’ credentials to unsubscribe.
- Websites that require the end users to confirm the request of unsubscribing by logging into their email accounts.
- Websites that require captcha to be solved and the Unsubscribe Service is unable to solve the captcha.
- Websites that require interactive unsubscribing.

The end users can use the URL provided at the bottom of the unsubscribe page to unsubscribe manually.

Configuring Global Settings for Intelligent Multi-Scan and Graymail Detection

To optimize the throughput of your appliance, you can configure the threshold and the timeout settings for scanning messages by Cisco Intelligent Multi-Scan and Graymail. These settings are common for both Cisco Intelligent Multi-Scan and Graymail configuration.

1. Select **Security Services > IMS and Graymail**
2. Click **Edit Global Settings**.
3. Select the thresholds for scanning with Cisco Intelligent Multi-Scan and Graymail Detection.

The default values are:

- Always scan 512K or less.



Note This setting is not applicable for Graymail Detection and Safe Unsubscribing.

- Never scan 1M or more.

4. Enter the number of seconds to wait for timeout when scanning a message.

When specifying the number of seconds, enter an integer from 1 to 120. The default value is 60 seconds.

Most users do not have to change the maximum message size to be scanned or the timeout value. That said, you may be able to optimize the throughput of your appliance by lowering the maximum message size setting.

5. Submit and commit your changes.

Defining Anti-Spam Policies

For each mail policy, you specify settings that determine which messages are considered spam and what action to take on those messages. You also specify which engine will scan messages that the policy applies to.

You can configure different settings for the default incoming and outgoing mail policies. If you need different anti-spam policies for different users, use multiple mail policies with different anti-spam settings. You can enable only one anti-spam solution per policy; you cannot enable both on the same policy.

Before You Begin

- Complete all steps to this point in the table in [How to Configure the Appliance to Scan Messages for Spam](#), on page 360.
- Familiarize yourself with the following:
 - [Understanding Positive and Suspect Spam Thresholds](#), on page 378
 - [Configuration Examples: Actions for Positively Identified versus Suspected Spam](#), on page 379
 - [Unwanted Marketing Messages From Legitimate Sources](#), on page 379
 - If you have enabled more than one anti-spam solution: [Enabling Different Anti-Spam Scanning Engines in Different Mail Policies: Configuration Example](#), on page 381
 - [Headers Added During Anti-Spam Scanning](#), on page 383
- If you will archive spam into the “Anti-Spam Archive” log, see also [Logging](#), on page 1113.
- If you will send messages to an alternate mailhost, see also [Alter Delivery Host Action](#), on page 206.

Procedure

- Step 1** Navigate to the **Mail Policies > Incoming Mail Policies** page.
Or
- Step 2** Navigate to the **Mail Policies > Outgoing Mail Policies** page.
- Step 3** Click the link under the **Anti-Spam** column for any mail policy.
- Step 4** In the **Enable Anti-Spam Scanning for This Policy** section, select the anti-spam solution you want to use for the policy.

Options you see depend on the anti-spam scanning solution(s) that you have enabled.

For mail policies other than the default: If you use settings from the default policy, all other options on the page are disabled.

You can also disable anti-spam scanning altogether for this mail policy.
- Step 5** Configure settings for positively identified spam, suspected spam, and marketing messages:

Option	Description
Enable Suspected Spam Scanning Enable Marketing Email Scanning	Choose an option. Positively-identified spam scanning is always enabled if anti-spam scanning is enabled.
Apply This Action to Message	Choose which overall action to take on positively identified spam, suspected spam, or unwanted marketing messages: <ul style="list-style-type: none"> • Deliver • Drop • Bounce • Quarantine
(Optional) Send to Alternate Host	You can send identified messages to an alternate destination mailhost (an email server other than the ones listed in SMTP Routes or DNS). Enter an IP address or hostname. If you enter a hostname, its Mail Exchange (MX) will be queried first. If none exists, the A record on the DNS server will be used (as with SMTP Routes). Use this option if you want to redirect messages, for example to a sandbox mail server for further examination. For additional important information, see Alter Delivery Host Action, on page 206 .
Add Text to Subject	You can alter text in the Subject of identified messages by prepending or appending certain text strings to help users more easily identify and sort spam and unwanted marketing messages. Note White space is not ignored in this field. Add spaces after (if prepending) or before (if appending) the text you enter in this field to separate your added text from the original subject of the message. For example, if you are prepending, add the text [SPAM] with a few trailing spaces. “Add Text to Subject” field only accepts US-ASCII characters.
Advanced Options (for custom header and message delivery)	
(Optional) Add Custom Header	You can add a custom header to identified messages. Click Advanced and define header and value. You can use a custom header in conjunction with a content filter to perform actions such as redirecting URLs in suspected spam messages so that they pass through the Cisco Web Security proxy service. For information, see Using Custom Headers to Redirect URLs in Suspected Spam to the Cisco Web Security Proxy: Configuration Example , on page 380.

Option	Description
(Optional) Send to an Alternate Envelope Recipient	You can have identified messages sent to an alternate envelope recipient address. Click Advanced and define an alternate address. For example, you could route messages identified as spam to an administrator’s mailbox for subsequent examination. In the case of a multi-recipient message, only a single copy is sent to the alternate recipient.
Archive Message	You can archive identified messages into the “Anti-Spam Archive” log. The format is an mbox-format log file.
Spam Thresholds	Use the default thresholds or enter a threshold value for positively identified spam and a value for suspected spam.

Step 6 Submit and commit your changes.

What to do next

If you enabled anti-spam scanning for outgoing mail, check the anti-spam settings of the relevant host access table, especially for a private listener. See [Defining Access Rules for Email Senders Using Mail Flow Policies](#), on page 99.

Related Topics

- [How to Configure the Appliance to Scan Messages for Spam](#), on page 360
- [Understanding Positive and Suspect Spam Thresholds](#), on page 378
- [Configuration Examples: Actions for Positively Identified versus Suspected Spam](#), on page 379
- [Unwanted Marketing Messages From Legitimate Sources](#), on page 379
- [Using Custom Headers to Redirect URLs in Suspected Spam to the Cisco Web Security Proxy: Configuration Example](#), on page 380
- [Enabling Different Anti-Spam Scanning Engines in Different Mail Policies: Configuration Example](#), on page 381

Understanding Positive and Suspect Spam Thresholds

When evaluating messages for spam, both anti-spam scanning solutions apply thousands of rules in order to arrive at an overall spam score for the message. The score is then compared to the thresholds specified in the applicable mail policy to determine whether the message is considered spam.

For highest accuracy, the threshold for positive identification as spam is quite high by default: Messages scoring between 90 and 100 are considered to be positively identified as spam. The default threshold for suspected spam is 50.

- Messages with scores below the suspected spam threshold will be considered legitimate.
- Messages above the suspected threshold but below the positive-identification threshold will be considered to be suspected spam.

You can configure your anti-spam solution to reflect the spam tolerance levels of your organization by customizing the Positive and Suspected spam thresholds in each mail policy.

You can change the positively identified spam threshold to a value between 50 and 99. You can change the threshold for suspected spam to any value between 25 and the value you specified for positively-identified spam.

When you change the thresholds:

- Specifying a lower number (a more aggressive configuration) identifies more messages as spam and may produce more false positives. This provides a lower risk that users will see spam but a higher risk of having legitimate mail marked as spam.
- Specifying a higher number (a more conservative configuration) identifies fewer messages as spam and may deliver more spam. This provides a higher risk of users seeing spam but less risk that legitimate mail will be withheld as spam. Ideally, if set up correctly, the message subject will identify the message as likely spam and message will be delivered.

You can define separate actions to take on positively-identified and suspected spam. For example, you may want to drop “positively identified” spam but quarantine “suspected” spam.

Related Topics

- [Anti-Spam Solutions](#) , on page 360
- [Configuration Examples: Actions for Positively Identified versus Suspected Spam](#) , on page 379

Configuration Examples: Actions for Positively Identified versus Suspected Spam

Spam	Sample Actions (Aggressive)	Sample Actions (Conservative)
Positively Identified	Drop	<ul style="list-style-type: none"> • Deliver with “ [Positive Spam] ” added to the subject of messages, or • Quarantine
Suspected	Deliver with “ [Suspected Spam] ” added to the subject of messages	Deliver with “ [Suspected Spam] ” added to the subject of messages

The aggressive example tags only suspected spam messages, while dropping those messages that are positively identified. Administrators and end-users can check the subject line of incoming message for false positives, and an administrator can adjust, if necessary, the suspected spam threshold.

In the conservative example, positively identified and suspected spam is delivered with an altered subject. Users can delete suspected and positively identified spam. This method is more conservative than the first.

For a further discussion of aggressive and conservative policies in mail policies, see [Managed Exceptions](#), on page 267.

Unwanted Marketing Messages From Legitimate Sources

If you had configured Marketing Email Settings under anti-spam settings for a mail policy, after upgrading to AsyncOS 9.5 for Email, Marketing Email Settings under anti-spam settings will be moved under graymail settings of the same policy. See [Managing Spam and Graymail](#), on page 359.

Using Custom Headers to Redirect URLs in Suspected Spam to the Cisco Web Security Proxy: Configuration Example

You can rewrite URLs in suspected spam so that when a recipient clicks a link in the message, the request is routed through the Cisco Web Security proxy service, which evaluates the safety of the site at click time and blocks access to known malicious sites.

Before You Begin

Enable the URL Filtering feature and its prerequisites. See [Setting Up URL Filtering, on page 426](#).

Procedure

- Step 1** Apply a custom header to suspected spam messages:
- Select **Mail Policies > Incoming Mail Policies**.
 - Click the link in the **Anti-Spam** column for a policy such as the Default policy.
 - In the Suspected Spam Settings section, enable suspected spam scanning.
 - Click **Advanced** to display the Add Custom Header option.
 - Add a custom header such as `url_redirect`.
 - Submit and commit your changes.
- Step 2** Create a content filter to redirect URLs in messages that have the custom header:
- Select **Mail Policies > Incoming Content Filters**.
 - Click **Add Filter**.
 - Name the filter `url_redirect`.
 - Click **Add Condition**.
 - Click **Other Header**.
 - Enter the header name: `url_redirect`.
- Make sure this exactly matches the header you created above.
- Select **Header exists**.
 - Click **OK**.
 - Click **Add Action**.
 - Click **URL Category**.
 - Select all categories in **Available Categories** and add them to **Selected Categories**.
 - For Action on URL, select **Redirect to Cisco Security Proxy**.
 - Click **OK**.
- Step 3** Add the content filter to the mail policy.
- Select **Mail Policies > Incoming Mail Policies**.
 - Click the link in the **Content Filters** column for the policy that you selected earlier in this procedure.
 - Select **Enable Content Filters** if it is not already selected.
 - Select the check box to enable the **url_filtering** content filter.
 - Submit and commit your changes.
-

What to do next**Related Topics**

- [Redirecting URLs, on page 405](#)
- [Content Filters, on page 271](#)

Enabling Different Anti-Spam Scanning Engines in Different Mail Policies: Configuration Example

When using the System Setup Wizard (or `systemsetup` command in the CLI), you are presented with option to enable either Cisco Intelligent Multi-Scan or the Cisco Anti-Spam engine. You cannot enable both during system setup, but after system setup is complete you can enable the anti-spam solution that you didn't choose, by using the Security Services menu.

After the system is set up, you can configure the anti-spam scanning solution for incoming mail policies via the **Mail Policies > Incoming Mail Policies** page. (Anti-spam scanning is typically disabled for outgoing mail policies.) You can even disable anti-spam scanning for a policy.

In this example, the default mail policy and the “Partners” policy are using the Cisco Anti-Spam scanning engine to quarantine positive and suspected spam.

Figure 22: Mail Policies - Anti-spam Engine Per Recipient

Incoming Mail Policies

Find Policies

Email Address:

 Recipient
 Sender

Find Policies

Policies

Add Policy...

Order	Policy Name	Anti-Spam	Anti-Virus	Content Filters	Virus Outbreak Filters	Delete
1	Partners	(use default)	(use default)	(use default)	(use default)	
	Default Policy	IronPort Anti-Spam Positive: Quarantine Suspected: Quarantine	Sophos Encrypted: Deliver Unscannable: Deliver Virus Positive: Drop	Disabled	Enabled	

Key: Default Custom Disabled

To change the Partners policy to use Cisco Intelligent Multi-Scan and scan for unwanted marketing messages, click on the entry in the Anti-Spam column corresponding with the Partners row (“use default”).

Select Cisco Intelligent Multi-Scan for the scanning engine, and select Yes to enable unwanted marketing message detection. Use the default settings for unwanted marketing message detection.

The following figure shows Cisco Intelligent Multi-Scan and unwanted marketing message detection enabled in a policy.

Figure 23: Mail Policies - Enabling Cisco Intelligent Multi-scan

The screenshot shows the configuration for the 'Test' mail policy. It is divided into four main sections:

- Anti-Spam Settings:** 'Enable Anti-Spam Scanning for This Policy:' is checked. The 'Use IronPort Intelligent Multi-Scan' option is selected, with a note 'Spam scanning built on IronPort Anti-Spam.'
- Positively-Identified Spam Settings:** 'Apply This Action to Message:' is set to 'Deliver'. 'Add Text to Subject:' is set to 'Prepend' with '[SPAM]'.
- Suspected Spam Settings:** 'Enable Suspected Spam Scanning:' is checked. 'Apply This Action to Message:' is set to 'Deliver'. 'Add Text to Subject:' is set to 'Prepend' with '[SUSPECTED SPAM]'.
- Marketing Email Settings:** 'Enable Marketing Email Scanning:' is checked. 'Apply This Action to Message:' is set to 'Deliver'. 'Add Text to Subject:' is set to 'Prepend' with '[MARKETING]'.

After submitting and committing the changes, the mail policy looks like this:

Figure 24: Mail Policies - Intelligent Multi-Scan Enabled in Policy

Incoming Mail Policies

Find Policies

Email Address: Recipient Sender

Order	Policy Name	Anti-Spam	Anti-Virus	Content Filters	Virus Outbreak Filters	Delete
1	Partners	IronPort Intelligent Multi-Scan Positive: Deliver Suspected: Deliver Marketing Messages: Deliver	(use default)	(use default)	(use default)	
	Default Policy	IronPort Anti-Spam Positive: Deliver Suspected: Deliver Marketing Messages: Disabled	Not Available	Disabled	Not Available	

Key:

Protecting Appliance -Generated Messages From the Spam Filter

Because automated email messages that are sent from the appliance (such as email alerts and scheduled reports) may contain URLs or other information that may cause them to be incorrectly identified as spam, you should do the following to ensure their delivery:

Include senders of these messages in an incoming mail policy that bypasses anti-spam scanning. See [Creating a Mail Policy for a Group of Senders and Recipients, on page 264](#) and [Bypass Anti-Spam System Action, on page 211](#).

Headers Added During Anti-Spam Scanning

- If either anti-spam scanning engine is enabled for a mail policy, each message that passes through that policy will have the following headers added to the message:

X-IronPort-Anti-Spam-Filtered: true

X-IronPort-Anti-Spam-Result

The second header contains information that allows Cisco Support to identify the rules and engine version used to scan the message. Result information is encoded proprietary information and is not customer-decodable.

- Cisco Intelligent Multi-Scan also adds headers from the third-party anti-spam scanning engines.
- You can define additional custom headers to be added to all messages for a given mail policy that are positively identified as spam, suspected to be spam, or identified as unwanted marketing mail. See [Defining Anti-Spam Policies](#) , on page 376.

Related Topics

- [Using Custom Headers to Redirect URLs in Suspected Spam to the Cisco Web Security Proxy: Configuration Example](#) , on page 380

Reporting Incorrectly Classified Messages to Cisco

Messages that appear to be incorrectly classified may be reported to Cisco for analysis. The reported messages are used to enhance the accuracy and effectiveness of the product.

You can report incorrectly classified messages that belong to the following categories:

- Missed spam
- Message marked as a spam, but is not a spam
- Missed marketing message
- Message marked as a marketing message, but is not a marketing message
- Missed phishing message

Related Topics

- [How to Report Incorrectly Classified Messages to Cisco](#), on page 383
- [How to Track Your Submissions](#), on page 388

How to Report Incorrectly Classified Messages to Cisco

Before You Begin

Before you start reporting incorrectly classified messages to Cisco, you must perform the following steps. Perform this step only once.

Procedure

Step 1

Register as an administrator on Cisco Talos Email Status Portal can be done in any one of the following ways:

Note Cisco Talos Email Status Portal is a web-based tool that allows email administrators to view and track email submissions on the portal.

- Registering when you are the first administrator in your organization to access the portal:
 - a. Log in to Cisco Talos Email Status Portal (https://talosintelligence.com/email_status_portal) using your Cisco credentials.
 - b. Click **Manage Account**.
 - c. Click **Add Domain**.
 - d. Enter your organization's domain name in the **Domain** field to register your domain with the portal.

Note Make sure that you enter a valid domain name, for example, `example.com` is the domain name in the following email address: `user@example.com`. If you have multiple domains in your organization, make sure that you add all the domains.

- e. Check the **I own this domain** check box if you are the owner of the domain entered in step 'd.'

Note If you do not check the 'I own this domain' check box, then you will only have domain view access rights. For more information, see the Cisco Talos Email Status Portal Help page at https://talosintelligence.com/tickets/email_submissions/help

- f. Click **Submit**.

After you click Submit, an email with a 6-digit character verification code is automatically sent to `postmaster@domain.com` (where `domain.com` is the domain you entered in step 'd') to confirm the domain ownership.

If your organization is not using `postmaster@domain.com` or your administrator does not have access to the postmaster mailbox, create a message filter (on all your appliances) to redirect messages from `SubmissionPortal@cisco.com` sent to `postmaster@domain.com` to a different email address. The following is a sample message filter:

```
redirect_postmaster: if (rcpt-to == "postmaster@domain.com") AND (mail-from ==
"^SubmissionPortal@cisco.com$") { alt-rcpt-to ("admin@domain.com"); }
```

- g. Enter the 6-digit character verification code in the **Domain Ownership Verification Code** dialog box to confirm the domain ownership.
- h. Click **Submit Verification Code**.

After you click the Submit Verification Code button, you are automatically provided with admin access rights. A registration ID is auto generated that can be viewed in the Manage Accounts section of the portal. You can use the registration ID for all the appliances in your organization.

Note A registration ID is a unique identifier to identify submissions made from the Cisco Email Security Gateways that belong to a particular organization.

- Registering when an administrator in your organization is already registered on the portal:

- a. Log in to Cisco Talos Email Status Portal (https://talosintelligence.com/email_status_portal) using your Cisco credentials.
- b. Click **Manage Account**.
- c. Click **Add Domain**.
- d. Enter your organization's domain name in the **Domain** field to register your domain with the portal.
Note Make sure that you enter a valid domain name, for example, `example.com` is the domain name in the following email address: `user@example.com`. If you have multiple domains in your organization, make sure that you add all the domains.
- e. Click **Submit**.

After you click Submit, an email notification is sent to the administrator who is already registered on the portal. This administrator must log in to the portal, and click **Approve** in the Permission Requests section of Manage Accounts to approve your registration request.

After your registration request is approved, a registration ID is auto generated that can be viewed in the Manage Accounts section of the portal. You can use the registration ID for all the appliances in your organization.

Note A registration ID is a unique identifier to identify submissions made from the Cisco Email Security Gateways that belong to a particular organization.

Step 2 Add the registration ID generated from Cisco Talos Email Status Portal for all the appliances in your organization.

- a. Log in to your appliances using the web interface.
- b. Go to **System Administration > Cisco Talos Email Status Portal Registration**.
- c. If your appliance is part of a cluster, set the mode to cluster level.
- d. Click **Set Registration ID**.
- e. Enter the registration ID obtained from the Cisco Talos Email Status Portal in the **Registration ID** field.
- f. Submit and commit your changes.
- g. If your appliance is not part of a cluster, you must repeat steps 1 through 6 on all the appliances in your organization.

You can also use the `portalregistrationconfig` command in CLI to set the registration ID.

How to Report Incorrectly Classified Messages to Cisco

For more information, see:

- How to Submit Email Messages to Cisco document at <https://www.cisco.com/c/en/us/support/docs/security/email-security-appliance/214133-how-to-submit-email-messages-to-cisco.html#anc5>.
- Cisco Talos Email Status Portal Help page at https://talosintelligence.com/tickets/email_submissions/help.

Procedure

Step 1 Perform the steps mentioned in **Before You Begin** section of [How to Report Incorrectly Classified Messages to Cisco](#), on page 383 .

Step 2 Report incorrectly classified messages to Cisco using one of the following methods:

- [Using Cisco Email Security Plug-In](#), on page 386
- [Forwarding Incorrectly Classified Message as an Attachment](#), on page 386

After you report an incorrectly classified message to Cisco, you will receive an email notification based on the option you select under the Email Notification and Reports button in the Manage Account section of the portal.

Note The 'My Submission Notifications' and 'My Submission Reports' options under the 'Email Notification and Reports' button are set to off by default. For more information, see the Cisco Talos Email Status Portal Help page at https://talosintelligence.com/tickets/email_submissions/help

What to do next

[How to Track Your Submissions](#), on page 388

Using Cisco Email Security Plug-In

Cisco Email Security Plug-In is a tool that allows users (email administrators and end users) to report incorrectly classified messages to Cisco using Microsoft Outlook. When you deploy this plug-in as part of Microsoft Outlook, a reporting menu is added to the Microsoft Outlook web interface. You can use the plug-in menu to report incorrectly classified messages.

Additional Information

- You can download Cisco Email Security Plug-In from the following page: <https://software.cisco.com/portal/pub/download/portal/select.html?&mdfid=284900944&flowid=41782&softwareid=283090986>.
- For more information, see the Cisco Email Security Plug-In Administrator Guide <http://www.cisco.com/c/en/us/support/security/email-encryption/products-user-guide-list.html>.

Forwarding Incorrectly Classified Message as an Attachment

Depending on the category of the message, you can forward each incorrectly classified message as an RFC 822 attachment to the following addresses as shown in the table below:

Email Submission	Definition	Submission Method	User Consideration for Submitting
Spam / Phish	Unsolicited and undesired. Spam/Phish is never legitimate and may also be malicious (phish, virus, malware, scams, etc.)	spam@access. ironport.com phish@access. ironport.com virus@access. ironport.com Outlook Plugin 'Spam', 'Phish', or 'Virus' button	Delivered to the user's inbox, but user considers message to be spam or Phish. Detected as spam, but user considers message legitimate.
Legitimate	Legitimate (good) email, not spam. Also known as 'Ham.'	ham@access. ironport.com Outlook Plugin 'Not Spam' button	Marketing/graymail messages not detected as marketing/graymail.
Marketing / Graymail	Marketing is legitimate (not Spam) email that is commercial bulk email. Usually subscription based, sometimes unwanted. Users may have knowingly or unknowingly solicited mail from the sender. For example swiping a badge at a conference or making an online purchase, etc. Legitimate subscription based marketing email will have a working unsubscribe mechanism. Graymail is a broader category that includes Marketing as well as other legitimate bulk mail.	ads@access. ironport.com Outlook Plugin 'Marketing' button	Detected as spam, but user considers message legitimate
Not Marketing / Graymail	Legitimate email (not Spam) that is not bulk and not subscription based. Usually person-to-person and/or transactional.	not_ads@access. ironport.com	Detected as Marketing/Graymail, but user considers the message to be transactional or otherwise not Marketing/Graymail.

You can achieve best results if you use one of the following email programs to forward the message:

- Apple Mail
- Microsoft Outlook for Mac
- Microsoft Outlook Web App
- Mozilla Thunderbird

**Caution**

If you are using Microsoft Outlook 2010, 2013, or 2016 for Microsoft Windows, you must use the Cisco Email Security Plug-In or the Microsoft Outlook Web App to report incorrectly classified messages. This is because Outlook for Windows may not forward the message with the required headers intact. Also, use the mobile platforms only if you can forward the original message as an attachment.

How to Track Your Submissions

After you receive an email notification with the submission details, you can view and track your submission on Cisco Talos Email Status Portal.

Procedure

- Step 1** Log in to Cisco Talos Email Status Portal (https://talosintelligence.com/email_status_portal) using your Cisco credentials.
- Step 2** Click **Submissions** on Cisco Talos Email Status Portal.
- Step 3** Click **Filter Options** and select appropriate filter option(s).
- Step 4** (Optional) Click the calendar button to choose the specific date.

What to do next

For more information, see the Cisco Talos Email Status Portal Help page at https://talosintelligence.com/tickets/email_submissions/help.

Determining Sender IP Address In Deployments with Incoming Relays

If one or more mail exchange/transfer agents (MX or MTA), filtering servers, etc. stand at the edge of your network, between your appliance and the external machines that are sending incoming mail, then your appliance cannot determine the IP addresses of the sending machines. Instead, mail appears to originate from the local MX/MTA. However, IronPort Anti-Spam and Cisco Intelligent Multi-Scan (using the IP Reputation Service) depend on accurate IP addresses for external senders.

The solution is to configure your appliance to work with incoming relays. You specify the names and IP addresses of all of the internal MX/MTAs connecting to the appliance, as well as the header used to store the originating IP address.

Related Topics

- [Example Environments with Incoming Relays](#), on page 389
- [Configuring the Appliance to Work with Incoming Relays](#), on page 390
- [How Incoming Relays Affect Functionality](#), on page 395
- [Configuring Logs to Specify Which Headers Are Used](#), on page 397

Example Environments with Incoming Relays

The following figure shows a very basic example of an incoming relay. Mail from IP address 7.8.9.1 appears to come from IP address 10.2.3.4 because the local MX/MTA is relaying mail to the appliance .

Figure 25: Mail Relayed by MX/MTA — Simple

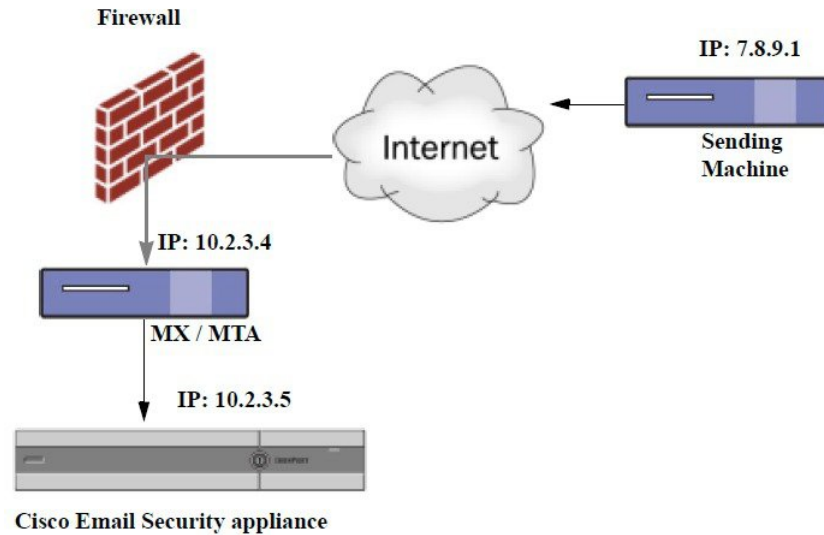

The following figure shows two other, slightly more complicated examples of how mail may be relayed inside the network and how mail may be processed by several servers within the network before it is passed to the appliance . In example A, mail from 7.8.9.1 passes through the firewall and is processed by an MX and an MTA before being delivered to the appliance . In example B, mail from 7.8.9.1 is sent to a load balancer or other type of traffic shaping appliance and is sent to any one of a range of MXs prior to being delivered to the appliance .

Figure 26: Mail Relayed by MX/MTA — Advanced

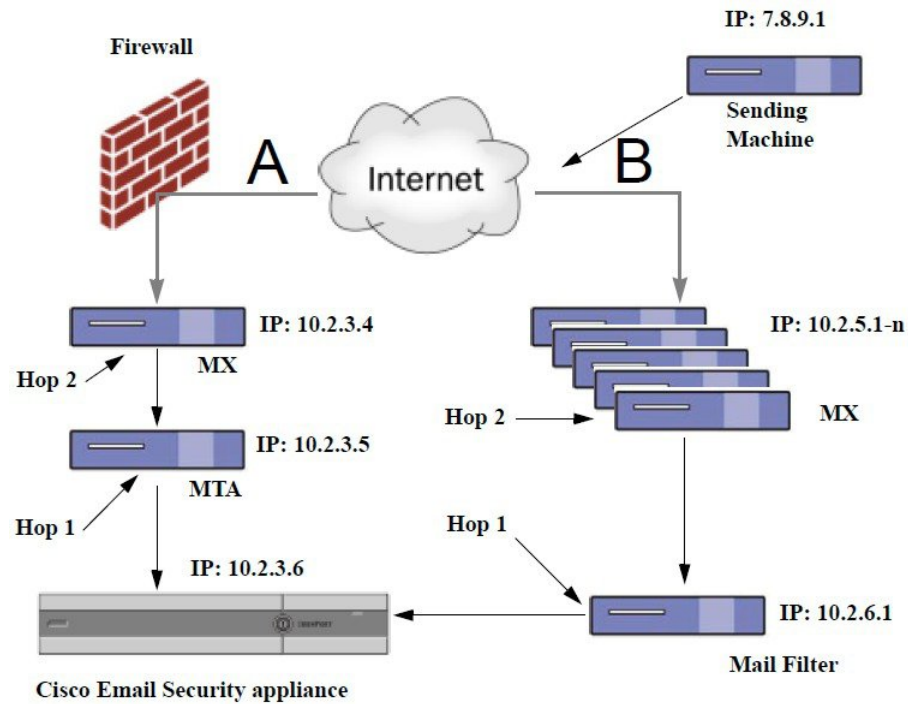

Configuring the Appliance to Work with Incoming Relays

Related Topics

- [Enabling the Incoming Relays Feature](#) , on page 390
- [Adding an Incoming Relay](#) , on page 391
- [Message Headers for Relayed Messages](#) , on page 392

Enabling the Incoming Relays Feature



Note You should only enable the incoming relays feature if a local MX/MTA relays mail to your appliance .

Procedure

- Step 1** Select **Network > Incoming Relays**.
- Step 2** Click **Enable**.
- Step 3** Commit your changes.

Adding an Incoming Relay

Add incoming relays to identify:

- Each machine on your network that will relay incoming messages to your appliance , and
- The header that will label the IP address of the original external sender.

Before You Begin

For information needed to complete these prerequisites, see [Message Headers for Relayed Messages](#) , on page 392.

- Determine whether you will use custom or received headers to identify the IP address of the original external sender.
- If you will use custom headers:
 - Determine the exact header that will label the originating IP address of relayed messages.
 - For each MX, MTA, or other machine that connects to original external senders, set up that machine to add the header name and the IP address of the original external sender to incoming messages.

Procedure

-
- Step 1** Select **Network > Incoming Relays**.
- Step 2** Click **Add Relay**.
- Step 3** Enter a name for this relay.
- Step 4** Enter the IP address of the MTA, MX, or other machine that connects to the appliance to relay incoming messages.

You can use IPv4 or IPv6 addresses, standard CIDR format, or an IP address range. For example, if you have several MTAs at the edge of your network receiving email, you might want to enter a range of IP addresses to include all of your MTAs, such as 10.2.3.1/8 or 10.2.3.1-10.

For IPv6 addresses, AsyncOS supports the following formats:

- 2620:101:2004:4202::0-2620:101:2004:4202::ff
- 2620:101:2004:4202::
- 2620:101:2004:4202::23
- 2620:101:2004:4202::/64

- Step 5** Specify the header that will identify the IP address of the original external sender.

When entering a header, you do not need to enter the trailing colon.

- a) Select the header type:

Choose custom headers (recommended) or Received headers.

- b) For custom headers:

Enter the header name that you configured the relaying machine to add to relayed messages.

For example:

SenderIP

or

X-CustomHeader

c) For Received headers:

Enter the character or string after which the IP address will appear. Enter the number for the “hop” to check for the IP address.

Step 6 Submit and commit your changes.

What to do next

Consider doing the following:

- Add the relaying machine to a sender group with a mail flow policy that has unlimited messages for DHAP. For an explanation, see [Incoming Relays and Directory Harvest Attack Prevention, on page 396](#).
- To facilitate tracking and troubleshooting, configure the appliance logs to show which header is used. See [Configuring Logs to Specify Which Headers Are Used, on page 397](#).

Related Topics

- [How to Configure the Appliance to Scan Messages for Spam, on page 360](#)

Message Headers for Relayed Messages

You will configure your appliance to use one of the following types of header to identify the original sender of a relayed message:

- [Custom Header, on page 392](#)
- [Received Header, on page 393](#)

Custom Header

Using custom headers is the recommended method of identifying original senders. The machine connecting to the original sender needs to add this custom header. The value of the header is expected to be the IP address of the external sending machine. For example:

SenderIP: 7.8.9.1

X-CustomHeader: 7.8.9.1

If your local MX/MTA can receive mail from a variable number of hops, inserting a custom header is the only way to enable the Incoming Relays feature. For example, in the following figure, both path C and D lead to IP address 10.2.3.5; however, path C has two hops and path D has one. Because the number of hops can vary in this situation, you must use a custom header in order to have Incoming Relays configured correctly.

Figure 27: Mail Relayed by MX/MTA — Variable Number of Hops

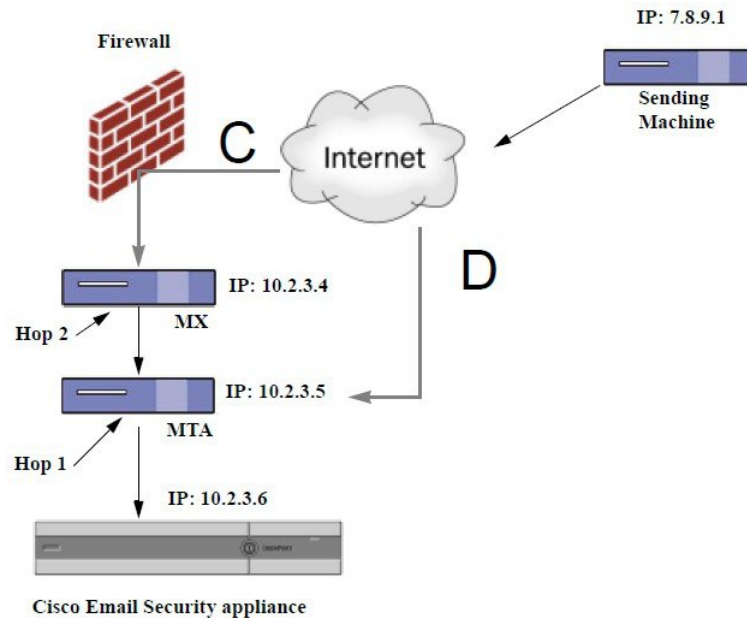

Related Topics

- [Adding an Incoming Relay](#) , on page 391

Received Header

If configuring the MX/MTAs to include a custom header containing the sending IP address is not an option, you can configure the incoming relays feature to attempt to determine the sending IP address by examining the “Received:” headers in the message. Using the “Received:” header will only work if the number of network “hops” will always be constant for an IP address. In other words, the machine at the first hop (10.2.3.5 in *Figure - Mail Relayed by MX/MTA — Advanced*) should always be the same number of hops away from the edge of your network. If incoming mail can take different paths (resulting in a different number of hops, as described in *Figure - Mail Relayed by MX/MTA — Variable Number of Hops*) to the machine connecting to your appliance , you must use a custom header (see [Custom Header](#) , on page 392).

Specify a parsing character or string and the number of network hops (or Received: headers) back to look. A hop is basically the message traveling from one machine to another (being received by the appliance does not count as a hop. See [Configuring Logs to Specify Which Headers Are Used](#) , on page 397 for more information). AsyncOS looks for the first IP address following the first occurrence of the parsing character or string in the Received: header corresponding to the number of specified hops. For example, if you specify two hops, the second Received: header, working backward from the appliance is parsed. If neither the parsing character nor a valid IP address is found, the appliance uses the real IP address of the connecting machine.

For the following example mail headers, if you specify an opening square bracket ([) and two hops, the IP address of the external machine is 7.8.9.1. However, if you specify an closing parenthesis ()) as the parsing character, a valid IP address will not be found. In this case, the Incoming Relays feature is treated as disabled, and the IP of the connecting machine is used (10.2.3.5).

In the example in *Figure - Mail Relayed by MX/MTA — Advanced* the incoming relays are:

- Path A — 10.2.3.5 (with 2 hops when using received headers) and

- Path B — 10.2.6.1 (with 2 hops when using received headers)

The following table shows example email headers for a message as it moves through several hops on its way to the appliance as in *Figure - Mail Relayed by MX/MTA — Advanced*. This example shows extraneous headers (ignored by your appliance) which are present once the message has arrived in the recipient's inbox. The number of hops to specify would be two.

Table 37: A Series of Received: Headers (Path A Example 1)

1	<pre>Microsoft Mail Internet Headers Version 2.0 Received: from smemail.rand.org ([10.2.2.7]) by smmail5.customerdoamin.org with Microsoft SMTPSVC(5.0.2195.6713); Received: from ironport.customerdomain.org ([10.2.3.6]) by smemail.customerdoamin.org with Microsoft SMTPSVC(5.0.2195.6713);</pre>
2	<pre>Received: from mta.customerdomain.org ([10.2.3.5]) by ironport.customerdomain.org with ESMTP; 21 Sep 2005 13:46:07 -0700</pre>
3	<pre>Received: from mx.customerdomain.org (mx.customerdomain.org) [10.2.3.4]) by mta.customerdomain.org (8.12.11/8.12.11) with ESMTP id j8LKkWu1008155 for <joefoo@customerdomain.org></pre>
4	<pre>Received: from sending-machine.spamham.com (sending-machine.spamham.com [7.8.9.1]) by mx.customerdomain.org (Postfix) with ESMTP id 4F3DA15AC22 for <joefoo@customerdomain.org></pre>
5	<pre>Received: from linux1.thespammer.com (HELO linux1.thespammer.com) ([10.1.1.89]) by sending-machine.spamham.com with ESMTP; Received: from exchange1.thespammer.com ([10.1.1.111]) by linux1.thespammer.com with Microsoft SMTPSVC(6.0.3790.1830); Subject: Would like a bigger paycheck? Date: Wed, 21 Sep 2005 13:46:07 -0700 From: "A. Sender" <asend@otherdomain.com> To: <joefoo@customerdomain.org></pre>

Notes for the above table:

- The appliance ignores these headers.
- The appliance receives the message (not counted as a hop).
- First hop (and incoming relay).
- Second hop. This is the sending MTA. The IP address is 7.8.9.1.
- The appliance ignores these Microsoft Exchange headers.

The following table shows the headers for the same email message, without the extraneous headers

Table 38: A Series of Received: Headers (Path A Example 2)

1	Received: from mta.customerdomain.org ([10.2.3.5]) by ironport.customerdomain.org with ESMTP; 21 Sep 2005 13:46:07 -0700
2	Received: from mx.customerdomain.org (mx.customerdomain.org) [10.2.3.4] by mta.customerdomain.org (8.12.11/8.12.11) with ESMTP id j8LKkWu1008155 for <joefoo@customerdomain.org>;
3	Received: from sending-machine.spamham.com (sending-machine.spamham.com [7.8.9.1]) by mx.customerdomain.org (Postfix) with ESMTP id 4F3DA15AC22 for <joefoo@customerdomain.org>;

The following figure shows the incoming relay for path A (above) as configured in the Add Relay page in the GUI:

Figure 28: A Configured Incoming Relay with Received Header

Add Relay

The screenshot shows the 'Add Relay' configuration interface. Under the 'Incoming Relay' heading, there are several fields:

- Name:** IncomingRelayOne
- IP Address:** 10.2.3.5
- Header:** There are two radio button options: 'Specify a custom header' (unselected) and 'Parse the "Received" header' (selected).
- Begin parsing after:** A text input field containing '['.
- Hop:** A dropdown menu set to '2'.

Related Topics

- [Adding an Incoming Relay](#) , on page 391

How Incoming Relays Affect Functionality

- [Incoming Relays and Filters](#), on page 395
- [Incoming Relays, HAT, IP Reputation Score, and Sender Groups](#), on page 396
- [Incoming Relays and Directory Harvest Attack Prevention](#), on page 396
- [Incoming Relays and Trace](#), on page 396
- [Incoming Relays and Email Security Monitor \(Reporting\)](#) , on page 396
- [Incoming Relays and Message Tracking](#), on page 396
- [Incoming Relays and Logging](#) , on page 396

Incoming Relays and Filters

The Incoming Relays feature provides the various IP Reputation Service related filter rules (reputation, no-reputation) with the correct IP Reputation score.

Incoming Relays, HAT, IP Reputation Score, and Sender Groups

HAT policy groups do not currently use information from Incoming Relays. However, because the Incoming Relays feature does supply the Reputation score, you can simulate HAT policy group functionality via message filters and the \$reputation variable.

Incoming Relays and Directory Harvest Attack Prevention

If a remote host attempts a directory harvest attack by sending messages to the MX or MTA serving as an incoming relay on your network, the appliance drops the connection from the incoming relay if the relay is assigned to a sender group with a mail flow policy with Directory Harvest Attack Prevention (DHAP) enabled. This prevents all messages from the relay, including legitimate messages, from reaching the appliance. The appliance does not have the opportunity to recognize the remote host as the attacker and the MX or MTA that's acting as the incoming relay continues to receive mail from the attacking host. To work around this issue and continue receiving messages from the incoming relay, add the relay to a sender group with a mail flow policy that has unlimited messages for DHAP.

Incoming Relays and Trace

Trace returns the Incoming Relay's IP Reputation Score in its results instead of the reputation score for the source IP address.

Incoming Relays and Email Security Monitor (Reporting)

When using Incoming Relays:

- Email Security Monitor reports include data for both the external IP and the MX/MTA. For example, if an external machine (IP 7.8.9.1) sent 5 emails through the internal MX/MTA (IP 10.2.3.4), Mail Flow Summary will show 5 messages coming from IP 7.8.9.1 and 5 more coming from the internal relay MX/MTA (IP 10.2.3.5).
- The IP Reputation score is not reported correctly in the Email Security Monitor reports. Also, sender groups may not be resolved correctly.

Incoming Relays and Message Tracking

When using Incoming Relays, the Message Tracking Details page displays the relay's IP address and the relay's IP Reputation Score for a message instead of the IP address and reputation score of the original external sender.

Incoming Relays and Logging

In the following log example, the IP Reputation score for the sender is reported initially on line 1. Later, once the Incoming Relay is processed, the correct IP Reputation score is reported on line 5.

1	Fri Apr 28 17:07:29 2006 Info: ICID 210158 ACCEPT SG UNKNOWNLIST match nx.domain IPR rfc1918
2	Fri Apr 28 17:07:29 2006 Info: Start MID 201434 ICID 210158
3	Fri Apr 28 17:07:29 2006 Info: MID 201434 ICID 210158 From: <joe@sender.com>
4	Fri Apr 28 17:07:29 2006 Info: MID 201434 ICID 210158 RID 0 To: <mary@example.com>

5	Fri Apr 28 17:07:29 2006 Info: MID 201434 IncomingRelay(senderdotcom): Header Received found, IP 192.192.108.1 being used, IPR 6.8
6	Fri Apr 28 17:07:29 2006 Info: MID 201434 Message-ID '<7.0.1.0.2.20060428170643.0451be40@sender.com>'
7	Fri Apr 28 17:07:29 2006 Info: MID 201434 Subject 'That report...'
8	Fri Apr 28 17:07:29 2006 Info: MID 201434 ready 2367 bytes from <joe@sender.com>
9	Fri Apr 28 17:07:29 2006 Info: MID 201434 matched all recipients for per-recipient policy DEFAULT in the inbound table
10	Fri Apr 28 17:07:34 2006 Info: ICID 210158 close
11	Fri Apr 28 17:07:35 2006 Info: MID 201434 using engine: CASE spam negative
12	Fri Apr 28 17:07:35 2006 Info: MID 201434 antivirus negative
13	Fri Apr 28 17:07:35 2006 Info: MID 201434 queued for delivery

Incoming Relays and Mail Logs

The following example shows a typical log entry containing Incoming Relay information:

```
Wed Aug 17 11:20:41 2005 Info: MID 58298 IncomingRelay(myrelay): Header Received found, IP 192.168.230.120 being used
```

Configuring Logs to Specify Which Headers Are Used

Your appliance only examines the headers that were present when the message was received. So, additional headers added locally (such as Microsoft Exchange headers, etc.) or when the message is received by the appliance are not processed. One way to help determine which headers are used is to configure AsyncOS logging to include the headers you use.

To configure logging settings for headers, see [Configuring Global Settings for Logging, on page 1174](#).

Monitoring Rules Updates

Once you have accepted the license agreement, you can view the most recent Cisco Anti-Spam and Cisco Intelligent Multi-Scan rules updates.

Procedure

-
- Step 1** Select **Security Services > IronPort Anti-Spam**.
- or
- Step 2** Select **Security Services > IMS and Graymail**.
- Step 3** Look at the **Rule Updates** section and:

To	More Information
See the most recent update for each component	If an update has not occurred, or a server has not been configured, “Never Updated” is displayed.
See if an update is available	—
Update rules if updates are available	Click Update Now .

What to do next

Related Topics

- [Service Updates](#) , on page 1003
- [Updates Through a Proxy Server](#), on page 1007
- [Configuring Server Settings for Downloading Upgrades and Updates](#) , on page 1008

Testing Anti-Spam

To	Do This	More Information
Test your configuration.	Test your configuration using the <code>X-advertisement: spam</code> header. For testing purposes, Cisco Anti-Spam considers any message with an X-header formatted as <code>X-Advertisement: spam to be spam</code> .	The test message you send with this header is flagged by Cisco Anti-Spam, and you can confirm that the actions you configured for the mail policy (Defining Anti-Spam Policies , on page 376) are performed. Use this header with one of the following: <ul style="list-style-type: none"> • Use SMTP commands to send a test message with this header. See Sending an Email to the Appliance to Test Cisco Anti-Spam, on page 399. • Use the trace command and include this header. See Debugging Mail Flow Using Test Messages: Trace, on page 1213.
Evaluate Anti-Spam engine efficacy.	Evaluate the product using a live mail stream directly from the Internet.	For a list of ineffective evaluation approaches that you should avoid, see Ways Not to Test Anti-Spam Efficacy , on page 400.

Related Topics

- [Sending an Email to the Appliance to Test Cisco Anti-Spam](#), on page 399
- [Ways Not to Test Anti-Spam Efficacy](#), on page 400

Sending an Email to the Appliance to Test Cisco Anti-Spam

Before You Begin

Review the example in [Testing Anti-Spam Configuration: Example Using SMTP, on page 399](#).

Procedure

- Step 1** Enable Cisco Anti-Spam on a mail policy.
- Step 2** Send a test email that includes the following header to a user in that mail policy: X-Advertisement: spam
Use SMTP commands with Telnet to send this message to an address to which you have access.
- Step 3** Check the mailbox of the test account and confirm that the test message was correctly delivered based upon the actions you configured for the mail policy.

For example:

- Was the subject line altered?
- Was your additional custom header added?
- Was the message delivered to an alternate address?
- Was the message dropped?

Related Topics

- [Testing Anti-Spam Configuration: Example Using SMTP, on page 399](#)
-

Testing Anti-Spam Configuration: Example Using SMTP

For this example, the mail policy must be configured to receive messages for the test address and the HAT must accept the test connection.

```
# telnet IP_address_of_IronPort_Appliance_with_IronPort_Anti-Spam port

220 hostname ESMTTP

helo example.com

250 hostname

mail from: <test@example.com>

250 sender <test@example.com> ok

rcpt to: <test@address>

250 recipient <test@address>
ok

data

354 go ahead

Subject: Spam Message Test
```

```
X-Advertisement: spam  
  
spam test  
  
.  
  
250 Message MID accepted  
  
221 hostname  
  
quit
```

Ways Not to Test Anti-Spam Efficacy

Because IronPort AntiSpam and Cisco Intelligent Multi-Scan rules are added quickly to prevent active spam attacks and quickly expire once attacks have passed, you should not test efficacy using any of the following methods:

- Evaluating using resent or forwarded mail or cut-and-pasted spam messages.
Mail lacking the proper headers, connecting IP, signatures, etc. will result in inaccurate scores.
- Testing “hard spam” only.
Removing the “easy spam” using IP Reputation Service, blocked lists, message filters, etc. will result in a lower overall catch rate percentage.
- Resending spam caught by another anti-spam vendor.
- Testing older messages.
The scanning engine adds and removes rules rapidly based on current threats. Testing using old messages will therefore lead to inaccurate test results.



CHAPTER 18

Outbreak Filters

This chapter contains the following sections:

- [Overview of Outbreak Filters, on page 401](#)
- [How Outbreak Filters Work, on page 401](#)
- [How the Outbreak Filters Feature Works, on page 408](#)
- [Managing Outbreak Filters, on page 411](#)
- [Monitoring Outbreak Filters, on page 421](#)
- [Troubleshooting The Outbreak Filters Feature, on page 422](#)

Overview of Outbreak Filters

Outbreak Filters protects your network from large-scale virus outbreaks and smaller, non-viral attacks, such as phishing scams and malware distribution, as they occur. Unlike most anti-malware security software, which cannot detect new outbreaks until data is collected and a software update is published, Cisco gathers data on outbreaks as they spread and sends updated information to your appliance in real-time to prevent these messages from reaching your users.

Cisco uses global traffic patterns to develop rules that determine if an incoming message is safe or part of an outbreak. Messages that may be part of an outbreak are quarantined until they're determined to be safe based on updated outbreak information from Cisco or new anti-virus definitions are published by Sophos and McAfee.

Messages used in small-scale, non-viral attacks use a legitimate-looking design, the recipient's information, and custom URLs that point to phishing and malware websites that have been online only for a short period of time and are unknown to web security services. Outbreak Filters analyzes a message's content and searches for URL links to detect this type of non-viral attack. Outbreak Filters can rewrite URLs to redirect traffic to potentially harmful websites through a web security proxy, which either warns users that the website they are attempting to access may be malicious or blocks the website completely.

How Outbreak Filters Work

Related Topics

- [Delaying, Redirecting, and Modifying Messages, on page 402](#)
- [Threat Categories, on page 402](#)
- [Cisco Security Intelligence Operations, on page 403](#)

- [Context Adaptive Scanning Engine, on page 404](#)
- [Delaying Messages, on page 404](#)
- [Redirecting URLs, on page 405](#)
- [Modifying Messages, on page 406](#)
- [Types of Rules: Adaptive and Outbreak, on page 406](#)
- [Outbreaks, on page 407](#)
- [Threat Levels, on page 407](#)

Delaying, Redirecting, and Modifying Messages

The Outbreak Filters feature uses three tactics to protect your users from outbreaks:

- **Delay.** Outbreak Filters quarantines messages that may be part of a virus outbreak or non-viral attack. While quarantined, the appliance receives updated outbreak information and rescans the message to confirm whether it's part of an attack.



Note If a spam positive message is identified as outbreak positive by Outbreak Filters, the message is not sent to Outbreak Quarantine.

- **Redirect.** Outbreak Filters rewrites the URLs in non-viral attack messages to redirect the recipient through the Cisco web security proxy if they attempt to access any of the linked websites. The proxy displays a splash screen that warns the user that the website may contain malware, if the website is still operational, or displays an error message if the website has been taken offline. See [Redirecting URLs, on page 405](#) for more information on redirecting URLs.
- **Modify.** In addition to rewriting URLs in non-viral threat messages, Outbreak Filters can modify a message's subject and add a disclaimer above the message body to warn users about the message's content. See [Modifying Messages, on page 406](#) for more information.

Threat Categories

The Outbreak Filters feature provides protection from two categories of message-based outbreaks: *virus outbreaks*, which are messages with never-before-seen viruses in their attachments, and *non-viral threats*, which includes phishing attempts, scams, and malware distribution through links to an external website.

By default, the Outbreak Filters feature scans your incoming and outgoing messages for possible viruses during an outbreak. You can enable scanning for non-viral threats in addition to virus outbreaks if you enable anti-spam scanning on the appliance.



Note Your appliance needs a feature key for Anti-Spam or Intelligent Multi-Scan in order for Outbreak Filters to scan for non-viral threats.

Related Topics

- [Virus Outbreaks, on page 403](#)
- [Phishing, Malware Distribution, and Other Non-Viral Threats, on page 403](#)

Virus Outbreaks

The Outbreak Filters feature provides you with a head start when battling virus outbreaks. An outbreak occurs when messages with attachments containing never-before-seen viruses or variants of existing viruses spread quickly through private networks and the Internet. As these new viruses or variants hit the Internet, the most critical period is the window of time between when the virus is released and when the anti-virus vendors release an updated virus definition. Having advanced notice — even a few hours — is vital to curbing the spread of the malware or virus. During that vulnerability window, the newly-found virus can propagate globally, bringing email infrastructure to a halt.

Phishing, Malware Distribution, and Other Non-Viral Threats

Messages containing non-viral threats are designed to look like a message from a legitimate sources and often sent out to a small number of recipients. These messages may have one or more of the following characteristics in order to appear trustworthy:

- The recipient's contact information.
- HTML content designed to mimic emails from legitimate sources, such as social networks and online retailers.
- URLs pointing to websites that have new IP addresses and are online only for a short time, which means that email and web security services do not have enough information on the website to determine if it is malicious.
- URLs pointing to URL shortening services.

All of these characteristics make these messages more difficult to detect as spam. The Outbreak Filters feature provides a multi-layer defense from these non-viral threats to prevent your users from downloading malware or providing personal information to suspicious new websites.

If CASE discovers URLs in the message, it compares the message to existing Outbreak Rules to determine if the message is part of a small-scale non-viral outbreak and then assigns a threat level. Depending on the threat level, the appliance delays delivery to the recipient until more threat data can be gathered and rewrites the URLs in the message to redirect the recipient to the Cisco web security proxy if they attempt to access the website. The proxy displays a splash page warning the user that the website may contain malware.

Cisco Security Intelligence Operations

Cisco Security Intelligence Operations (SIO) is a security ecosystem that connects global threat information, reputation-based services, and sophisticated analysis to appliances to provide stronger protection with faster response times.

SIO consists of three components:

- SenderBase. The world's largest threat monitoring network and vulnerability database.
- Threat Operations Center (TOC). A global team of security analysts and automated systems that extract actionable intelligence gathered by SenderBase.
- Dynamic Update. Real-time updates automatically delivered to appliances as outbreaks occur.

SIO compares real-time data from the global SenderBase network to common traffic patterns to identify anomalies that are proven predictors of an outbreak. TOC reviews the data and issues a threat level of the possible outbreak. The appliances download updated threat levels and Outbreak Rules and use them to scan incoming and outgoing messages, as well as messages already in the Outbreak quarantine.

Information about current virus outbreaks can be found on SenderBase's website here:

<http://www.senderbase.org/>

The SIO website provides a list of current non-viral threats, including spam, phishing, and malware distribution attempts:

<http://tools.cisco.com/security/center/home.x>

Context Adaptive Scanning Engine

Outbreak Filters are powered by Cisco's unique Context Adaptive Scanning Engine (CASE). CASE leverages over 100,000 adaptive message attributes tuned automatically and on a regular basis, based on real-time analysis of messaging threats.

For virus outbreaks, CASE analyzes the message content, context and structure to accurately determine likely Adaptive Rule triggers. CASE combines Adaptive Rules and the real-time Outbreak Rules published by SIO to evaluate every message and assign a unique threat level.

To detect non-viral threats, CASE scans messages for URLs and uses Outbreak Rules from SIO to evaluate a message's threat level if one or more URLs are found.

Based on the message's threat level, CASE recommends a period of time to quarantine the message to prevent an outbreak. CASE also determines the rescan intervals so it can reevaluate the message based on updated Outbreak Rules from SIO. The higher the threat level, the more often it rescans the message while it is quarantined.

CASE also rescans messages when they're released from the quarantine. A message can be quarantined again if CASE determines that it is spam or contains a virus upon rescan.

For more information about CASE, see [Cisco Anti-Spam: an Overview](#), on page 362.

Delaying Messages

The period between when an outbreak or email attack occurs and when software vendors release updated rules is when your network and your users are the most vulnerable. A modern virus can propagate globally and a malicious website can deliver malware or collect your users' sensitive information during this period. Outbreak Filters protects your users and network by quarantining suspect messages for a limited period of time, giving Cisco and other vendors time to investigate the new outbreak.

When a virus outbreak occurs, suspicious messages with attachments are quarantined until updated Outbreak Rules and new anti-virus signatures prove the email's attachment is clean or a virus.

Small scale, non-viral threats contain URLs to malicious websites that may be online for a short period of time in order to evade detection by web security services or through URL shortening services in order to circumvent web security by putting a trustworthy website in the middle. By quarantining messages containing URLs that meet your threat level threshold, not only does CASE have the opportunity to reevaluate the message's content based on updated Outbreak Rules from SIO, but the messages can remain in the quarantine long enough that the linked website may go offline or be blocked by a web security solution.

See [Dynamic Quarantine](#), on page 409 for more information on how Outbreak Filters quarantine suspicious messages.

Redirecting URLs

When CASE scans a message at the Outbreak Filters stage, it searches for URLs in the message body in addition to other suspicious content. CASE uses published Outbreak Rules to evaluate whether the message is a threat and then scores the message with the appropriate threat level. Depending on the threat level, Outbreak Filters protects the recipient by rewriting all the URLs to redirect the recipient to the Cisco web security proxy, except for URLs pointing to bypassed domains, and delaying the delivery of the message in order for TOC to learn more about the website if it appears to be part of a larger outbreak. See [URL Rewriting and Bypassing Domains, on page 418](#) for more information on bypassing URLs for trusted domains.

After the appliance releases and delivers the message, any attempt by the recipient to access the website is redirected through the Cisco web security proxy. This is an external proxy hosted by Cisco that displays a splash screen that warns the user that the website may be dangerous, if the website is still operational. If the website has been taken offline, the splash screen displays an error message.

If the recipient decides to click the message's URLs, the Cisco web security proxy displays a splash screen in the user's web browser to warn the user about the content of the message. The following figure shows an example of the splash screen warning. The recipient can either click **Ignore this warning** to continue on to the website or **Exit** to leave and safely close the browser window.

Figure 29: Cisco Security Splash Screen Warning (proxy_splash_screen)



The only way to access the Cisco web security proxy is through a rewritten URL in a message. You cannot access the proxy by typing a URL in your web browser.



Note You can customize the appearance of this splash screen and display your organization's branding such as company logo, contact information, and so on. See [Customizing the Notification That End Users See If a Site Is Malicious, on page 431](#).



Tip To redirect all URLs in suspected spam messages to the Cisco Web Security proxy service, see [Using Custom Headers to Redirect URLs in Suspected Spam to the Cisco Web Security Proxy: Configuration Example, on page 380](#).

Modifying Messages

The Outbreak Filters feature modifies the message body of a non-viral threat message not only to rewrite the URLs but to alert the user that the message is a suspected threat. The Outbreak Filters feature can modify the subject header and add a disclaimer about the message's content above the message body. See [Message Modification, on page 417](#) for more information.

The threat disclaimer is created using the Disclaimer template through the Mail Policies > Text Resources page. See [Overview of Text Resource Management, on page 628](#) for more information.

Types of Rules: Adaptive and Outbreak

Two types of rules are used by Outbreak Filters to detect potential outbreaks: Adaptive and Outbreak. The Outbreak Filters feature uses these two rule sets to provide the highest efficacy and the most focused set of criteria for threat detection to ensure that filters can be laser focused on a particular outbreak. The Outbreak Filters rules and actions are visible to the administrator, not hidden away behind the scenes, providing instant access to quarantined messages and the reason why they were quarantined.

Related Topics

- [Adaptive Rules, on page 406](#)
- [Outbreak Rules, on page 406](#)

Outbreak Rules

Outbreak Rules are generated by the Cisco Threat Operations Center (TOC), which is a part of the Cisco Security Intelligence Operations, and focus on the message as a whole, rather than just attachment filetypes. Outbreak Rules use SenderBase data (real time and historical traffic data) and any combination of message parameters such as attachment file type, file name keywords, or anti-virus engine update to recognize and prevent outbreaks in real time. Outbreak Rules are given a unique ID used to refer to the rule in various places in the GUI (such as the Outbreak quarantine).

Real-time data from the global SenderBase network is then compared to this baseline, identifying anomalies that are proven predictors of an outbreak. The TOC reviews the data and issues a threat indicator or Threat Level. The Threat Level is a numeric value between 0 (no threat) and 5 (extremely risky), and measures the likelihood that a message is a threat for which no other gateway defense is widely deployed by Cisco customers (for more information, see [Threat Levels, on page 407](#)). Threat Levels are published as Outbreak Rules by the TOC.

Some example characteristics that can be combined in Outbreak Rules include:

- File Type, File Type & Size, File Type & File Name Keyword, etc.
- File Name Keyword & File Size
- File Name Keyword
- Message URL
- File Name & Sophos IDE

Adaptive Rules

Adaptive Rules are a set of rules within CASE that accurately compare message attributes to attributes of known virus outbreak messages. These rules have been created after studying known threat messages and known good messages within an extensive virus corpus. Adaptive Rules are updated often as the corpus is

evaluated. They complement existing Outbreak Rules to detect outbreak messages at all times. While Outbreak Rules take effect when a possible outbreak is occurring, Adaptive Rules (once enabled) are “always on,” catching outbreak messages locally before the full anomaly has formed on a global basis. Additionally, Adaptive Rules continuously respond to small and subtle changes in email traffic and structure, providing updated protection to customers.

Outbreaks

A Outbreak Filter rule is basically a Threat Level (e.g. 4) associated with a set of characteristics for an email message and attachment — things such as file size, file type, file name, message content, and so on. For example, assume the Cisco SIO notices an increase in the occurrences of a suspicious email message carrying a .exe attachment that is 143 kilobytes in size, and whose file name includes a specific keyword (“hello” for example). An Outbreak Rule is published increasing the Threat Level for messages matching this criteria. Your appliance checks for and downloads newly published Outbreak and Adaptive Rules every 5 minutes by default (see [Updating Outbreak Filter Rules, on page 415](#)). Adaptive Rules are updated less frequently than Outbreak Rules. On the appliance, you set a threshold for quarantining suspicious messages. If the Threat Level for a message equals or exceeds the quarantine threshold, the message is sent to the *Outbreak* quarantine area. You can also set up a threshold for modifying non-viral threat messages to rewrite any URLs found in suspicious messages or add a notification at the top of message body.

Threat Levels

The following table provides a basic set of guidelines or definitions for each of the various levels.

Level	Risk	Meaning
0	None	There is no risk that the message is a threat.
1	Low	The risk that the message is a threat is low.
2	Low/Medium	The risk that the message is a threat is low to medium. It is a “suspected” threat.
3	Medium	Either the message is part of a confirmed outbreak or there is a medium to large risk of its content being a threat.
4	High	Either the message is confirmed to be part of a large scale outbreak or its content is very dangerous.
5	Extreme	The message’s content is confirmed to part of an outbreak that is either extremely large scale or large scale and extremely dangerous.

For more information about threat levels and outbreak rules, see [Outbreak Filters Rules, on page 414](#).

Related Topics

- [Guidelines for Setting Your Quarantine Threat Level Threshold, on page 407](#)
- [Containers: Specific and Always Rules, on page 408](#)

Guidelines for Setting Your Quarantine Threat Level Threshold

The quarantine threat level threshold allows administrators to be more or less aggressive in quarantining suspicious messages. A low setting (1 or 2) is more aggressive and will quarantine more messages; conversely,

a higher score (4 or 5) is less aggressive and will only quarantine messages with an extremely high likelihood of being malicious.

The same threshold applies to both virus outbreaks and non-virus threats, but you can specify different quarantine retention times for virus attacks and other threats. See [Dynamic Quarantine, on page 409](#) for more information.

Cisco recommends the default value of 3.

Containers: Specific and Always Rules

Container files are files, such as zipped (.zip) archives, that contain other files. The TOC can publish rules that deal with specific files within archive files.

For example, if a virus outbreak is identified by TOC to consist of a .zip file containing a .exe, a specific Outbreak Rule is published that sets a threat level for .exe files within .zip files (.zip(exe)), but does not set a specific threat level for any other file type contained within .zip files (e.g. .txt files). A second rule (.zip(*)) covers all other file types within that container file type. An Always rule for a container will always be used in a message's Threat Level calculation regardless of the types of files that are inside a container. An always rule will be published by the SIO if all such container types are known to be dangerous.

Table 39: Fallback Rules and Threat Level Scores

Outbreak Rule	Threat Level	Description
.zip(exe)	4	This rule sets a threat level of 4 for .exe files within .zip files.
.zip(doc)	0	This rule sets a threat level of 0 for .doc files within .zip files.
zip(*)	2	This rule sets a threat level of 2 for all .zip files, regardless of the types of files they contain.

How the Outbreak Filters Feature Works

Email messages pass through a series of steps, the “email pipeline,” when being processed by your appliance (for more information about the email pipeline, see [Understanding the Email Pipeline, on page 57](#)). As the messages proceed through the email pipeline, they are run through the anti-spam and anti-virus scanning engines if those engines are enabled for that mail policy. In other words, known spam or messages containing recognized viruses are not scanned by the Outbreak Filters feature because they will have already been removed from the mail stream — deleted, quarantined, etc. — based on your anti-spam and anti-virus settings. Messages that arrive at the Outbreak Filters feature have therefore been marked spam- and virus-free. Note that a message quarantined by Outbreak Filters may be marked as spam or containing a virus when it is released from the quarantine and rescanned by CASE, based on updated spam rules and virus definitions.



Note Messages that skip anti-spam and anti-virus scanning due to filters or the engines being disabled will still be scanned by Outbreak Filters.

Related Topics

- [Message Scoring, on page 409](#)

- [Dynamic Quarantine, on page 409](#)

Message Scoring

When a new virus attack or non-viral threat is released into the wild, no anti-virus or anti-spam software is able to recognize the threat yet, so this is where the Outbreak Filters feature can be invaluable. Incoming messages are scanned and scored by CASE using the published Outbreak and Adaptive Rules (see [Types of Rules: Adaptive and Outbreak, on page 406](#)). The message score corresponds with the message's threat level. Based on which, if any, rules the message matches, CASE assigns the corresponding threat level. If there is no associated threat level (the message does not match any rules), then the message is assigned a threat level of 0.

Once that calculation has been completed, the appliance checks whether the threat level of that message meets or exceeds your quarantine or message modification threshold value and quarantines message or rewrites its URLs. If the threat level is below the thresholds, it will be passed along for further processing in the pipeline.

Additionally, CASE reevaluates existing quarantined messages against the latest rules to determine the latest threat level of a message. This ensures that only messages that have a threat level consistent with an outbreak message stay within the quarantine and messages that are no longer a threat flow out of the quarantine after an automatic reevaluation.

In the case of multiple scores for an outbreak message — one score from an Adaptive Rule (or the highest score if multiple Adaptive Rules apply), and another score from an Outbreak Rule (or the highest score if multiple Outbreak Rules apply) — intelligent algorithms are used to determine the final threat level.

It is possible to use the Outbreak Filters feature without having enabled anti-virus scanning on the appliance. The two security services are designed to complement each other, but will also work separately. That said, if you do not enable anti-virus scanning on your appliance, you will need to monitor your anti-virus vendor's updates and manually release or re-evaluate some messages in the Outbreak quarantine. When using Outbreak Filters without anti-virus scanning enabled, keep the following in mind:

- You should disable Adaptive Rules
- Messages will get quarantined by Outbreak Rules
- Messages will get released if the threat level is lowered or time expires

Downstream anti-virus vendors (desktops/groupware) may catch the message on release.



Note Anti-spam scanning needs to be enabled globally on an appliance for the Outbreak Filters feature to scan for non-viral threats.

Dynamic Quarantine

The Outbreak Filters feature's Outbreak quarantine is a temporary holding area used to store messages until they're confirmed to be threats or it's safe to deliver to users. (See [Outbreak Lifecycle and Rules Publishing, on page 410](#) for more information.) Quarantined messages can be released from the Outbreak quarantine in several ways. As new rules are downloaded, messages in the Outbreak quarantine are reevaluated based on a recommended rescan interval calculated by CASE. If the revised threat level of a message falls under the quarantine retention threshold, the message will automatically be released (regardless of the Outbreak quarantine's settings), thereby minimizing the time it spends in the quarantine. If new rules are published while messages are being re-evaluated, the rescan is restarted.

Please note that messages quarantined as virus attacks are not automatically released from the outbreak quarantine when new anti-virus signatures are available. New rules may or may not reference new anti-virus signatures; however, messages will not be released due to an anti-virus engine update unless an Outbreak Rule changes the threat level of the message to a score lower than your Threat Level Threshold.

Messages are also released from the Outbreak quarantine after CASE's recommended retention period has elapsed. CASE calculates the retention period based on the message's threat level. You can define separate maximum retention times for virus outbreaks and non-viral threats. If CASE's recommended retention time exceeds the maximum retention time for the threat type, the appliance releases messages when the maximum retention time elapses. For viral messages the default maximum quarantine period is 1 day. The default period for quarantining non-viral threats is 4 hours. You can manually release messages from the quarantine.

The appliance also releases messages when the quarantine is full and more messages are inserted (this is referred to as overflow). Overflow only occurs when the Outbreak quarantine is at 100% capacity, and a new message is added to the quarantine. At this point, messages are released in the following order of priority:

- Messages quarantined by Adaptive Rules (those scheduled to be released soonest are first)
- Messages quarantined by Outbreak Rules (those scheduled to be released soonest are first)

Overflow releases stop the moment the Outbreak quarantine is below 100% capacity. For more information about how quarantine overflow is handled, see [Retention Time for Messages in Quarantines](#), on page 902 and [Default Actions for Automatically Processed Quarantined Messages](#), on page 903.

Messages released from the Outbreak quarantine are scanned by the anti-virus and anti-spam engines again if they're enabled for the mail policy. If it is now marked as a known virus or spam, then it will be subject to your mail policy settings (including a possible second quarantining in the Virus quarantine or Spam quarantine). For more information, see [The Outbreak Filters Feature and the Outbreak Quarantine](#), on page 419.

Thus it is important to note that in a message's lifetime, it may actually be quarantined twice — once due to the Outbreak Filters feature, and once when it is released from the Outbreak quarantine. A message will not be subject to a second quarantine if the verdicts from each scan (prior to Outbreak Filters, and when released from the Outbreak quarantine) match. Also note that the Outbreak Filters feature does not take any final actions on messages. The Outbreak Filters feature will either quarantine a message (for further processing) or move the message along to the next step in the pipeline.

Related Topics

- [Outbreak Lifecycle and Rules Publishing](#), on page 410

Outbreak Lifecycle and Rules Publishing

Very early in a virus outbreak's life cycle, broader rules are used to quarantine messages. As more information becomes available, increasingly focused rules are published, narrowing the definition of what is quarantined. As the new rules are published, messages that are no longer considered possible virus messages are released from quarantine (messages in the outbreak quarantine are rescanned as new rules are published).

Table 40: Example Rules for an Outbreak Lifecycle

Time	Rule Type	Rule Description	Action
T=0	Adaptive Rule (based on past outbreaks)	A consolidated rule set based on over 100K message attributes, which analyzes message content, context and structure	Messages are automatically quarantined if they match Adaptive Rules

Time	Rule Type	Rule Description	Action
T=5 min	Outbreak Rule	Quarantine messages containing .zip (exe) files	Quarantine all attachments that are .zips containing a .exe
T=10 min	Outbreak Rule	Quarantine messages that have .zip (exe) files greater than 50 KB	Any message with .zip (exe) files that are less than 50 KB would be released from quarantine
T=20 min	Outbreak Rule	Quarantine messages that have .zip (exe) files between 50 to 55 KB, and have "Price" in the file name	Any message that does not match this criteria would be released from quarantine
T=12 hours	Outbreak Rule	Scan against new signature	All remaining messages are scanned against the latest anti-virus signature

Managing Outbreak Filters

Log in to the Graphical User Interface (GUI), select Security Services in the menu, and click Outbreak Filters.

Figure 30: Outbreak Filters Main Page

Outbreak Filters

Outbreak Filters Overview

Global Status:	Enabled
Adaptive Rules:	Enabled
Maximum Message Size to Scan:	512K
Receive Emailed Alerts:	No

[Edit Global Settings...](#)

Outbreak Filter Rules

Rule Updates		
Rule Type	Last Update	Current Version
CASE Core Files	Never Updated	3.1.0-012
CASE Utilities	Never Updated	3.1.0-012
Virus Outbreak Rules	Never Updated	20050718_000000

Outbreak Filter Rules (higher number indicates greater risk. 1= lowest threat, 5= highest threat)

Threat Level	Rule ID	Description
3	OUTBREAK_0003427	We are seeing unusual volume for file extension(s) pif. We are raising the Threat Level to 3. We wil...
3	OUTBREAK_0003428	We are seeing unusual volume for file extension(s) exe. We are raising the Threat Level to 3. We wil...
3	OUTBREAK_0003429	We are seeing unusual volume for file extension(s) zip(exe), zip:e(exe). We are raising the Threat L...
3	OUTBREAK_0003430	We are seeing suspicious url(s) propagating through multiple sources. We are raising the Threat Leve...
3	OUTBREAK_0003431	We are seeing suspicious url(s) propagating through multiple sources. We are raising the Threat Leve...

Rules last updated: Wed May 25 22:36:12 2011

[Update Rules Now](#) [Clear Current Rules](#)

The Outbreak Filters page shows two sections: the Outbreak Filters Overview and a listing of current Outbreak Filter Rules (if any).

In the figure above, Outbreak Filters are enabled, Adaptive Scanning is enabled, and the maximum message size is set to 512k. To change these settings, click **Edit Global Settings**. For more information about editing Global Settings, see [Configuring Outbreak Filters Global Settings, on page 412](#).

The Outbreak Filter Rules section lists the time, date, and version of the latest update for various components (the rules engine as well as the rules themselves), as well as a listing of the current Outbreak Filter rules with threat level.

For more information about Outbreak Rules, see [Outbreak Filters Rules, on page 414](#).

Related Topics

- [Configuring Outbreak Filters Global Settings, on page 412](#)
- [Outbreak Filters Rules, on page 414](#)
- [The Outbreak Filters Feature and Mail Policies, on page 415](#)
- [The Outbreak Filters Feature and the Outbreak Quarantine, on page 419](#)

Configuring Outbreak Filters Global Settings

Procedure

- Step 1** Click **Security Services > Outbreak Filters**.
- Step 2** Click **Edit Global Settings**.
- Step 3** Depending on your requirements, do the following:
- Enable Outbreak Filters globally
 - Enable Adaptive Rules scanning
 - Set a maximum size for files to scan (note that you are entering the size in *bytes*)
 - Enable alerts for the Outbreak Filter
 - Enable Web Interaction Tracking. See [Web Interaction Tracking , on page 428](#).
- Step 4** Submit and commit your changes.
-

What to do next

This functionality is also available via the `outbreakconfig` CLI command (see the CLI Reference Guide for AsyncOS for Cisco Email Security Appliances). After you make your changes, submit and commit them.



Note You cannot enable the logging of URLs using the web interface. For instructions to enable logging of URLs using CLI, see [Enabling Logging of URLs and Message Tracking Details for URLs , on page 413](#) .

Related Topics

- [Enabling the Outbreak Filters Feature, on page 413](#)
- [Enabling Adaptive Rules, on page 413](#)
- [Enabling Alerts for Outbreak Filters, on page 413](#)
- [Enabling Logging of URLs and Message Tracking Details for URLs , on page 413](#)

Enabling the Outbreak Filters Feature

To enable the Outbreak Filters feature globally, check the box next to Enable Outbreak Filters on the Outbreak Filters Global Settings page, and click **Submit**. You must have agreed to the Outbreak Filters license agreement first.

Once enabled globally, the Outbreak Filters feature can then be enabled or disabled individually for each incoming and outgoing mail policy, including the default policies. For more information, see [The Outbreak Filters Feature and Mail Policies, on page 415](#).

The Outbreak Filters feature uses the Context Adaptive Scanning Engine (CASE) to detect viral threats, regardless of whether anti-spam scanning is enabled, but you do need to have Anti-Spam or Intelligent Multi-Scan enabled globally on the appliance to scan for non-viral threats.



Note If you have not already agreed to the license during system setup (see [Step 4: Security, on page 39](#)), you must click **Enable** on the Security Services > Outbreak Filters page, and then read and agree to the license.

Enabling Adaptive Rules

Adaptive Scanning enables the use of Adaptive Rules in Outbreak Filters. A set of factors or traits (file size, etc.) are used to determine the likelihood of a message being part of an outbreak when no virus signature or spam criteria relating to the message's content is available. To enable Adaptive Scanning, check the box next to Enable Adaptive Rules on the Outbreak Filters Global Settings page, and click **Submit**.

Enabling Alerts for Outbreak Filters

Check the box labeled "Emailed Alerts" to enable alerting for the Outbreak Filters feature. Enabling emailed alerts for Outbreak Filters merely enables the alerting engine to send alerts regarding Outbreak Filters. Specifying which alerts are sent and to which email addresses is configured via the Alerts page in the System Administration tab. For more information on configuring alerts for Outbreak Filters, see [Alerts, SNMP Traps, and Outbreak Filters, on page 422](#).

Enabling Logging of URLs and Message Tracking Details for URLs

Logging of URL-related logs, and display of this information in Message Tracking details, is disabled by default. This includes the logs for the following events:

- Category of any URL in the message matches the URL category filters
- Reputation score of any URL in the message matches URL reputation filters
- Outbreak Filter rewrites any URL in the message

To enable logging of these events, use the `outbreakconfig` command in the command-line interface (CLI).

Related Topics

- [Example: Enabling Logging of URLs Using the outbreakconfig Command](#), on page 413
- [Managing Outbreak Filter Rules, on page 415](#)
- [Example: Enabling Logging of URLs Using the outbreakconfig Command](#), on page 413

Example: Enabling Logging of URLs Using the outbreakconfig Command

The following example shows how to enable logging of URLs using the `outbreakconfig` command

```

mail.example.com> outbreakconfig

Outbreak Filters: Enabled

Choose the operation you want to perform:

- SETUP - Change Outbreak Filters settings.

[]> setup

Outbreak Filters: Enabled

Would you like to use Outbreak Filters? [Y]>

Outbreak Filters enabled.

Outbreak Filter alerts are sent when outbreak rules cross the threshold (go above or back
down below), meaning that new messages of

certain types could be quarantined or will no longer be quarantined, respectively.

Would you like to receive Outbreak Filter alerts? [N]>

What is the largest size message Outbreak Filters should scan?

[524288]>

Do you want to use adaptive rules to compute the threat level of messages? [Y]>

Logging of URLs is currently disabled.

Do you wish to enable logging of URL's? [N]> Y

Logging of URLs has been enabled.

The Outbreak Filters feature is now globally enabled on the system. You must use the
'policyconfig' command in the CLI or the Email

Security Manager in the GUI to enable Outbreak Filters for the desired Incoming and Outgoing
Mail Policies.

Choose the operation you want to perform:

- SETUP - Change Outbreak Filters settings.

[]>

```

Outbreak Filters Rules

Outbreak Rules are published by the Cisco Security Intelligence Operations and your appliance checks for and downloads new outbreak rules every 5 minutes. You can change this update interval. See [Configuring Server Settings for Downloading Upgrades and Updates](#), on page 1008 for more information.

Related Topics

- [Managing Outbreak Filter Rules, on page 415](#)

Managing Outbreak Filter Rules

Because the Outbreak Filters Rules are automatically downloaded for you, there really is no management needed on the part of the user.

However, if for some reason your appliance is not able to reach Cisco's update servers for new rules over a period of time, it is possible that your locally-cached scores are no longer valid, i.e., if a known viral attachment type now has an update in the anti-virus software and/or is no longer a threat. At this time, you may wish to no longer quarantine messages with these characteristics.

You can manually download updated outbreak rules from Cisco's update servers by clicking **Update Rules Now**.



Note The **Update Rules Now** button does not “flush” all existing outbreak rules on the appliance . It only replaces outbreak rules that have been updated. If there are no updates available on Cisco's update servers, then the appliance will not download any outbreak rules when you click this button.

Related Topics

- [Updating Outbreak Filter Rules, on page 415](#)

Updating Outbreak Filter Rules

By default, your appliance will attempt to download new Outbreak Filters rules every 5 minutes. You can change this interval via the Security Services > Service Updates page. For more information, see [Service Updates , on page 1003](#).

The Outbreak Filters Feature and Mail Policies

The Outbreak Filters feature has settings that can be set per mail policy. The Outbreak Filters feature can be enabled or disabled for each mail policy on the appliance . Specific file extensions and domains can be exempted from processing by the Outbreak Filters feature, per mail policy. This functionality is also available via the policyconfig CLI command (see the CLI Reference Guide for AsyncOS for Cisco Email Security Appliances).



Note Anti-Spam or Intelligent Multi-Scan scanning needs to be enabled globally on an appliance for the Outbreak Filters feature to scan for non-viral threats.

To modify the Outbreak Filters feature settings for a specific mail policy, click the link in the Outbreak Filters column of the policy to change.

To enable and customize the Outbreak Filters feature for a particular mail policy, select **Enable Outbreak Filtering (Customize Settings)**.

You can configure the following Outbreak Filter settings for a mail policy:

- Quarantine threat level
- Maximum quarantine retention time
- Deliver non-viral threat messages immediately without adding them to quarantine
- File extension types for bypassing

- Message modification threshold
- Alter subject header using custom text and Outbreak Filter variables such as \$threat_verdict , \$threat_category , \$threat_type , \$threat_description , and \$threat_level .
- Include the following email headers:
 - X-IronPort-Outbreak-Status
 - X-IronPort-Outbreak-Description
- Send the message to an alternate destination such as an appliance or an exchange server.
- URL rewriting
- Threat disclaimer

Select **Enable Outbreak Filtering (Inherit Default mail policy settings)** to use the Outbreak Filters settings that are defined for the default mail policy. If the default mail policy has the Outbreak Filters feature enabled, all other mail policies use the same Outbreak Filter settings unless they are customized.

Once you have made your changes, commit your changes.

Related Topics

- [Setting a Quarantine Level Threshold, on page 416](#)
- [Maximum Quarantine Retention, on page 416](#)
- [Bypassing File Extension Types, on page 416](#)
- [Message Modification, on page 417](#)

Setting a Quarantine Level Threshold

Select a Quarantine Threat Level threshold for outbreak threats from the list. A smaller number means that you will be quarantining more messages, while a larger number results in fewer messages quarantined. Cisco recommends the default value of 3.

For more information, see [Guidelines for Setting Your Quarantine Threat Level Threshold, on page 407](#).

Maximum Quarantine Retention

Specify the maximum amount of time that messages stay in the Outbreak Quarantine. You can specify different retention times for messages that may contain viral attachments and messages that may contain other threats, like phishing or malware links. For non-viral threats, check the **Deliver messages without adding them to quarantine** check box to deliver the messages immediately without adding them to quarantine.



Note

You cannot quarantine non-viral threats unless you enable Message Modification for the policy.

CASE recommends a quarantine retention period when assigning the threat level to the message. The appliance keeps the message quarantined for the length of time that CASE recommends unless it exceeds the maximum quarantine retention time for its threat type.

Bypassing File Extension Types

You can modify a policy to bypass specific file types. Bypassed file extensions are not included when CASE calculates the threat level for the message; however, the attachments are still processed by the rest of the email security pipeline.

To bypass a file extension, click **Bypass Attachment Scanning**, select or type in a file extension, and click **Add Extension**. AsyncOS displays the extension type in the File Extensions to Bypass list.

To remove an extension from the list of bypassed extensions, click the trash can icon next to the extension in the File Extensions to Bypass list.

Related Topics

- [Bypassing File Extensions: Container File Types, on page 417](#)

Bypassing File Extensions: Container File Types

When bypassing file extensions, files within container files (a .doc file within a .zip, for example) are bypassed if the extension is in the list of extensions to bypass. For example, if you add .doc to the list of extensions to bypass, all .doc files, even those within container files are bypassed.

Message Modification

Enable Message Modification if you want the appliance to scan messages for non-viral threats, such as phishing attempts or links to malware websites.

Based on the message's threat level, AsyncOS can modify the message to rewrite all of the URLs to redirect the recipient through the Cisco web security proxy if they attempt to open the website from the message. The appliance can also add a disclaimer to the message to alert the user that the message's content is suspicious or malicious.

You need to enable message modification in order to quarantine non-viral threat messages.

Related Topics

- [Message Modification Threat Level, on page 417](#)
- [Message Subject, on page 417](#)
- [Outbreak Filters Email Headers, on page 418](#)
- [Alternate Destination Mail Host, on page 418](#)
- [URL Rewriting and Bypassing Domains, on page 418](#)
- [Threat Disclaimer, on page 419](#)

Message Modification Threat Level

Select a Message Modification Threat Level threshold from the list. This setting determines whether to modify a message based on the threat level returned by CASE. A smaller number means that you will be modifying more messages, while a larger number results in fewer messages being modified. Cisco recommends the default value of 3.

Message Subject

You can alter the text of the subject header on non-viral threat messages containing modified links to notify users that the message has been modified for their protection. Prepend or append the subject header with custom text, Outbreak Filter variables such as `$threat_verdict` , `$threat_category` , `$threat_type` , `$threat_description` , and `$threat_level` , or a combination of both. To insert variables, click **Insert Variables**, and select from the list of variables.

White space is not ignored in the Message Subject field. Add spaces after (if prepending) or before (if appending) the text you enter in this field to separate your added text from the original subject of the message. For example, add the text `[MODIFIED FOR PROTECTION]` with a few trailing spaces if you are prepending.



Note The Message Subject field only accepts US-ASCII characters.

Outbreak Filters Email Headers

You can add the following additional headers to the message:

Header	Format	Example	Options
X-IronPort-Outbreak-Status	X-IronPort-Outbreak-Status: \$threat_verdict, level \$threat_level, \$threat_category - \$threat_type	X-IronPort-Outbreak-Status: Yes, level 4, Phish - Password	<ul style="list-style-type: none"> • Enable for all messages • Enable only for non-viral outbreak • Disable
X-IronPort-Outbreak-Description	X-IronPort-Outbreak-Description: \$threat_description	X-IronPort-Outbreak-Description: It may trick victims into submitting their username and password on a fake website.	<ul style="list-style-type: none"> • Enable • Disable



Note If you want to filter messages based on these headers, you must send the Outbreak Filter processed messages back to an appliance (by configuring an alternate destination mail host), and scan them using a content filter that matches these headers.

Alternate Destination Mail Host

If you want to perform a content filter-based scan on the Outbreak Filter processed messages, you must configure the Outbreak Filter to send the processed messages back to an appliance. This is because, in the processing pipeline, the Outbreak Filter scan is performed after the content filter scan.

In the **Alternate Destination Mail Host** field, enter the IP address (IPv4 or IPv6) or the FQDN of the appliance where you want to send the processed messages for further scans.

URL Rewriting and Bypassing Domains

If the message's threat level exceeds the message modification threshold, the Outbreak Filters feature rewrites all URLs in the message to redirect the user to the Cisco web security proxy's splash page if they click on any of them. (See [Redirecting URLs, on page 405](#) for more information.) If the message's threat level exceeds the quarantine threshold, the appliance also quarantines the message. If a small scale, non-viral outbreak is in progress, quarantining the message gives TOC time to analyze any suspect websites linked from possible outbreak messages and determine whether the websites are malicious. CASE uses updated Outbreak Rules from SIO to rescan the message to determine if it is part of the outbreak. After the retention period expires, the appliance releases the message from the quarantine.

AsyncOS rewrites all of the URLs inside a message except for the ones pointing to bypassed domains.

The following options are available for URL rewriting:

- **Enable only for unsigned messages.** This option allows AsyncOS to rewrite URLs in unsigned messages that meet or exceed the message modification threshold, but not signed messages. Cisco recommends using this setting for URL rewriting.



Note The appliance may rewrite URLs in a DomainKeys/DKIM-signed message and invalidate the message's signature if a server or appliance on your network other than the Email Security appliance is responsible for verifying the DomainKeys/DKIM signature.

The appliance considers a message signed if it is encrypted using S/MIME or it contains an S/MIME signature.

- **Enable for all messages.** This option allows AsyncOS to rewrite URLs in all messages that meet or exceed the message modification threshold, including signed ones. If AsyncOS modifies a signed message, the signature becomes invalid.
- **Disable.** This option disables URL rewriting for Outbreak Filters.

You can modify a policy to exclude URLs to certain domains from modification. To bypass domains, enter the IPv4 address, IPv6 address, CIDR range, hostname, partial hostname or domain in the Bypass Domain Scanning field. Separate multiple entries using commas.

The Bypass Domain Scanning feature is similar to, but independent of, the global allowed list used by URL filtering. For more information about that allowed list, see [Creating Allowed Lists for URL Filtering](#), on page 429.

Threat Disclaimer

The appliance can append a disclaimer message above the heading of a suspicious message to warn the user of its content. This disclaimer can be in HTML or plain text, depending on the type of message.

Select the disclaimer text you want to use from the Threat Disclaimer list or click the Mail Policies > Text Resources link to create a new disclaimer using the Disclaimer Template. The Disclaimer Template includes variables for outbreak threat information. You can see a preview of the threat disclaimer by clicking Preview Disclaimer. For custom disclaimer messages, you can use variables to display the threat level, the type of threat, and a description of the threat in the message. For information on creating a disclaimer message, see [Overview of Text Resource Management](#), on page 628.

The Outbreak Filters Feature and the Outbreak Quarantine

Messages quarantined by the Outbreak Filters feature are sent to the Outbreak quarantine. This quarantine functions like any other quarantine (for more information about working with quarantines, see [Policy, Virus, and Outbreak Quarantines](#), on page 899) except that it has a “summary” view, useful for deleting or releasing all messages from the quarantine, based on the rule used to place the message in the quarantine (for Outbreak Rules, the Outbreak ID is shown, and for Adaptive Rules, a generic term is shown). For more information about the summary view, see [Outbreak Quarantine and the Manage by Rule Summary View](#), on page 420.

Related Topics

- [Monitoring the Outbreak Quarantine](#), on page 420
- [Outbreak Quarantine and the Manage by Rule Summary View](#), on page 420

Monitoring the Outbreak Quarantine

Though a properly configured quarantine requires little if any monitoring, it is a good idea to keep an eye on the Outbreak Quarantine, especially during and after virus outbreaks when legitimate messages may be delayed.

If a legitimate message is quarantined, one of the following occurs depending on the settings for the Outbreak quarantine:

- If the quarantine's Default Action is set to Release, the message will be released when the retention time period expires or when the quarantine overflows. You can configure the Outbreak quarantine so that the following actions are performed on messages before they are released due to overflow: strip attachments, modify the subject, and add an X-Header. For more information about these actions, see [Default Actions for Automatically Processed Quarantined Messages](#), on page 903.
- If the quarantine's Default Action is set to Delete, the message will be deleted when the retention time period expires, or when the quarantine overflows.
- Overflow occurs when the quarantine is full and more messages are added. In this case the messages closest to their expiration date (not necessarily the oldest messages) are released first, until enough room is available for the new messages. You can configure the Outbreak quarantine so that the following actions are performed on messages before they are released due to overflow: strip attachments, modify the subject, add an X-Header.

Because quarantined messages are rescanned whenever new rules are published, it is very likely that messages in the Outbreak quarantine will be released prior to the expiration time.

Still, it can be important to monitor the Outbreak quarantine if the Default Action is set to Delete. Cisco recommends most users to not set the default action to Delete. For more information about releasing messages from the Outbreak quarantine, or changing the Default Action for the Outbreak Quarantine, see [Default Actions for Automatically Processed Quarantined Messages](#), on page 903.

Conversely, if you have messages in your Outbreak quarantine that you would like to keep in the quarantine longer while you wait for a new rule update, for example, you can delay the expiration of those messages. Keep in mind that increasing the retention time for messages can cause the size of the quarantine to grow.



Note If anti-virus scanning is disabled globally (not via a mail policy) while a message is in the Outbreak quarantine, the message is not anti-virus scanned when it leaves the quarantine, even if anti-virus scanning is re-enabled prior to the message leaving the quarantine.



Note You can use the Outbreak Filters feature without having enabled anti-virus scanning on the appliance. However, Outbreak Filters cannot scan for non-viral threats if anti-spam scanning is not enabled on the appliance.

Outbreak Quarantine and the Manage by Rule Summary View

You can view the contents of the Outbreak quarantine by clicking on the name of the quarantine in the listing on the Monitor menu in the GUI. The Outbreak quarantine has an additional view as well, the Outbreak Quarantine Manage by Rule Summary link.

Figure 31: The Outbreak Quarantine Manage by Rule Summary Link

Quarantines

Quarantine	Messages	Default Action	Status	Settings
Spam Quarantine	2565	Retain 14 days then Delete	2% Full	Edit
Outbreak Manage by Rule Summary	0	Retention Varies Action: Release	0% Full	Edit
Policy	0	Retain 10 days then Delete	0% Full	Edit
Virus	0	Retain 30 days then Delete	0% Full	Edit

Related Topics

- [Using the Summary View to Perform Message Actions on Messages in the Outbreak Quarantine Based on Rule ID.](#), on page 421

Using the Summary View to Perform Message Actions on Messages in the Outbreak Quarantine Based on Rule ID.

Click on the Manage by Rule Summary link to see a listing of the contents of the Outbreak quarantine, grouped by rule ID:

Figure 32: The Outbreak Quarantine Manage by Rule Summary View

Outbreak Quarantine Summary

Manage by Rule Summary					
All Select	Rule ID	Number of messages	Average message size	Total size	Capacity
<input type="checkbox"/>	EXE_BAGL	4	16 KB	0.1 MB	0.0%
Totals		4	16 KB		
Select Action...		Submit			

From this view, you can choose to release, delete, or delay the exit for all messages pertaining to a specific outbreak or adaptive rule, rather than selecting individual messages. You can also search through or sort the listing.

This functionality is also available via the quarantineconfig -> outbreakmanage CLI command. For more information, see the CLI Reference Guide for AsyncOS for Cisco Email Security Appliances .

Monitoring Outbreak Filters

The appliance includes several tools to monitor the performance and activity of the Outbreak Filters feature.

Related Topics

- [Outbreak Filters Report](#), on page 421
- [Outbreak Filters Overview and Rules Listing](#), on page 422
- [Outbreak Quarantine](#), on page 422
- [Alerts, SNMP Traps, and Outbreak Filters](#), on page 422

Outbreak Filters Report

The Outbreak Filters report to view the current status and configuration of Outbreak Filters on your appliance as well as information about recent outbreaks and messages quarantined due to Outbreak Filters. View this

information on the Monitor > Outbreak Filters page. For more information, see the “Email Security Monitor” chapter.

Outbreak Filters Overview and Rules Listing

The overview and rules listing provide useful information about the current status of the Outbreak Filters feature. View this information via the Security Services > Outbreak Filters page.

Outbreak Quarantine

Use the outbreak quarantine to monitor how many messages are being flagged by your Outbreak Filters threat level threshold. Also available is a listing of quarantined messages by rule. For information, see [Outbreak Quarantine and the Manage by Rule Summary View, on page 420](#) and [Policy, Virus, and Outbreak Quarantines, on page 899](#)

Alerts, SNMP Traps, and Outbreak Filters

The Outbreak Filters feature supports two different types of notifications: regular AsyncOS alerts and SNMP traps.

SNMP traps are generated when a rule update fails. For more information about SNMP traps in AsyncOS, see the “Managing and Monitoring via the CLI” chapter.

AsyncOS has two types of alerts for the Outbreak Filter feature: size and rule

AsyncOS alerts are generated whenever the Outbreak quarantine’s size goes above 5, 50, 75, and 95 of the maximum size. The alert generated for the 95% threshold has a severity of CRITICAL, while the remaining alert thresholds are WARNING. Alerts are generated when the threshold is crossed as the quarantine size increases. Alerts are not generated when thresholds are crossed as the quarantine size decreases. For more information about alerts, see [Alerts, on page 1021](#).

AsyncOS also generates alerts when rules are published, the threshold changes, or when a problem occurs while updating rules or the CASE engine.

Troubleshooting The Outbreak Filters Feature

This section provides some basic troubleshooting tips for the Outbreak Filters feature.

Related Topics

- [Reporting Incorrectly Classified Messages to Cisco , on page 422](#)
- [Multiple Attachments and Bypassed Filetypes, on page 423](#)
- [Message and Content Filters and the Email Pipeline, on page 423](#)

Reporting Incorrectly Classified Messages to Cisco

Use the checkbox on the Manage Quarantine page for the Outbreak quarantine to notify Cisco of misclassifications.

Multiple Attachments and Bypassed Filetypes

Bypassed file types are only excluded if a message's only attachment is of that type, or in the case of multiple attachments, if the other attachments do not yet have existing rules. Otherwise the message is scanned.

Message and Content Filters and the Email Pipeline

Message and content filters are applied to messages prior to scanning by Outbreak Filters. Filters can cause messages to skip or bypass the Outbreak Filters scanning.



CHAPTER 19

Protecting Against Malicious or Undesirable URLs

This chapter contains the following sections:

- [URL-Related Protections and Controls](#) , on page 425
- [Setting Up URL Filtering](#), on page 426
- [Taking Action Based on the Reputation or Category of URLs in Messages](#) , on page 432
- [Handling Unscannable Messages for URL Filtering](#), on page 436
- [Detecting Malicious URLs in Messages Using Content Filter](#), on page 436
- [Detecting Malicious URLs in Messages Using Message Filter](#), on page 438
- [Monitoring URL Filtering Results](#) , on page 439
- [Displaying URL Details in Message Tracking](#) , on page 439
- [Troubleshooting URL Filtering](#), on page 439
- [About URL Categories](#), on page 443

URL-Related Protections and Controls

Control and protection against malicious or undesirable links is incorporated into the anti-spam, outbreak, content, and message filtering processes in the work queue. These controls:

- Increase the effectiveness of protection from malicious URLs in messages and attachments.

URL filtering is incorporated into Outbreak Filtering. This strengthened protection is useful even if your organization already has a Cisco Web Security Appliance or similar protection from web-based threats, because it blocks threats at the point of entry.

You can also use content or message filters to take action based on the Web Based Reputation Score (WBRS) of URLs in messages.



Note As a best practice, Cisco recommends rewriting URLs with a questionable, neutral, and favorable or unknown reputation to redirect them to the Cisco Web Security Proxy for click-time evaluation of their safety.

- Better identify spam

The appliance uses the reputation and category of links in messages, in conjunction with other spam-identification algorithms, to help identify spam. For example, if a link in a message belongs to a marketing web site, the message is more likely to be a marketing message.

- Support enforcement of corporate acceptable use policies

The category of URLs (for example, Adult Content or Illegal Activities) can be used in conjunction with content and message filters to enforce corporate acceptable use policies.

- Allow you to identify users in your organization who most frequently clicked a URL in a message that has been rewritten for protection, as well as links that have most frequently been clicked.

Related Topics

- [Which URLs Are Evaluated](#) , on page 426
- [Web Interaction Tracking Page](#) , on page 830

Which URLs Are Evaluated

URLs in incoming and outgoing messages (including attachments) are evaluated. Any valid string for a URL is evaluated, including strings with the following:

- http, https, or www
- domain or IP address
- port number preceded by a colon (:)
- uppercase or lowercase letters

When evaluating URLs to determine whether a message is spam, if necessary for load management, the system prioritizes screening of incoming messages over outgoing messages.

Setting Up URL Filtering

- [Requirements for URL Filtering](#) , on page 426
- [Enable URL Filtering](#) , on page 427
- [About the Connection to Talos Intelligence Services](#) , on page 428
- [Web Interaction Tracking](#) , on page 428
- [URL Filtering in Cluster Configurations](#) , on page 429
- [Creating Allowed Lists for URL Filtering](#) , on page 429
- [Customizing the Notification That End Users See If a Site Is Malicious](#) , on page 431

Requirements for URL Filtering

In addition to enabling URL filtering, you must enable other features depending on desired functionality.

For enhanced protection against spam:

- Anti-spam scanning must be enabled globally and per applicable mail policy. This can be either the IronPort Anti-Spam or the Intelligent Multi-Scan feature. See the anti-spam chapter.

For enhanced protection against malware:

- The Outbreak Filters feature must be enabled globally and per applicable mail policy. See the Outbreak Filters chapter.

To take action based on URL reputation, or to enforce acceptable use policies using message and content filters:

- The Outbreak Filters feature must be enabled globally. See the Outbreak Filters chapter.

Enable URL Filtering

You can enable URL filtering using the **Security Services > URL Filtering** page in the web interface or the `websecurityconfig` command in CLI.

Before You Begin

- Ensure that the requirements for the individual URL filtering features that you want to use have been met. See [Requirements for URL Filtering](#) , on page 426.
- (Optional) Create a list of URLs that you want all URL filtering functionalities to ignore. See [Creating Allowed Lists for URL Filtering](#) , on page 429.

Procedure

- Step 1** Select **Security Services > URL Filtering**.
- Step 2** Click **Enable**.
- Step 3** Select the **Enable URL Category and Reputation Filters** check box.
- Step 4** (Optional) If you have created a list of URLs to exempt from URL filtering when evaluating messages for spam and malware, and from all content and message filtering, select that list.
- This setting does not cause the message to bypass anti-spam or Outbreak Filters processing generally.
- Step 5** (Optional) Enable Web Interaction Tracking. See [Web Interaction Tracking](#) , on page 428.
- Step 6** Submit and commit your changes.

If you have met the applicable prerequisites, and you have already configured Outbreak Filters and Anti-Spam protection, then you do not need to make additional configurations to benefit from enhanced automatic detection of spam and malicious URLs.

What to do next

- To take action based on the reputation of URLs in messages, see [Taking Action Based on the Reputation or Category of URLs in Messages](#) , on page 432.
- To use URL categories in content and message filters, for example to enforce acceptable use policies, see [Taking Action Based on the Reputation or Category of URLs in Messages](#) , on page 432.
- To redirect all URLs in suspected spam messages to the Cisco Web Security proxy service, see [Using Custom Headers to Redirect URLs in Suspected Spam to the Cisco Web Security Proxy: Configuration Example](#) , on page 380.
- (Optional) To customize the appearance of end user notification page, see [Customizing the Notification That End Users See If a Site Is Malicious](#) , on page 431.

- Ensure that you receive alerts about issues related to this feature. See [Future URL Category Set Changes](#), on page 456, the release notes for your AsyncOS release, and [Adding Alert Recipients](#), on page 1022.

About the Connection to Talos Intelligence Services

URL reputation and category are provided by cloud-based Talos Intelligence Services.

The appliance connects to the Talos Intelligence Services either directly or through a web proxy, using the port specified for URL filtering services in [Firewall Information](#), on page 1289. Communication is over HTTPS with mutual certificate authentication. Certificates are updated automatically (see [Service Updates](#), on page 1003.) For additional information about required certificates, see the Release Notes available from the location specified in [Certificates for URL Filtering Features](#), on page 428.

If an HTTP or HTTPS proxy has been configured on the **Security Services > Service Updates** page, the appliance will use it when communicating with Talos Intelligence Services. For more information about using a proxy server, see [Configuring Server Settings for Downloading Upgrades and Updates](#), on page 1008.



Note Certificates are not saved with a configuration file.

Related Topics

- [Certificates for URL Filtering Features](#), on page 428
- [Alert: Beaker Connector: Error Fetching Enrollment Certificate](#), on page 440
- [Alert: Beaker Connector: Certificate Is Invalid](#), on page 440

Certificates for URL Filtering Features

AsyncOS is designed to automatically deploy and update the certificates needed for communications with cloud services used for URL filtering features. However, if for any reason the system is unable to update these certificates, you will receive an alert that requires action from you.

Ensure that the appliance is configured to send you these alerts (System type, Warning severity). For instructions, see [Alerts](#), on page 1021.

If you receive an alert about an invalid certificate, contact Cisco TAC, which can provide the required replacement certificate. For instructions to use the replacement certificate, see [Manually Configuring a Certificate for Communication with Talos Intelligence Services](#), on page 443.

Web Interaction Tracking

The web interaction tracking feature provides information about the end users who clicked on rewritten URLs and the action (allowed, blocked, or unknown) associated with each user click. Once you enable this feature, you can use the Web Interaction Tracking report to view information such as top malicious URLs clicked, top users who clicked on malicious URLs, and so on. For more information about the Web Interaction Tracking report, see [Web Interaction Tracking Page](#), on page 830.

Web Interaction Tracking data is provided by a cloud-based Cisco Aggregator Server.

Related Topics

- [Configuring Web Interaction Tracking](#), on page 429

- [About the Connection to Cisco Aggregator Server, on page 429](#)

Configuring Web Interaction Tracking

Depending on your requirements, you can enable web interaction tracking on one of the global settings pages:

- **Outbreak Filters.** Track end users who clicked URLs rewritten by Outbreak Filters. See [Configuring Outbreak Filters Global Settings, on page 412](#).
- **URL Filtering.** Track end users who clicked URLs rewritten by policies (using content and message filters). See [Enable URL Filtering, on page 427](#).

About the Connection to Cisco Aggregator Server

The appliance connects to the Cisco Aggregator Server every 30 minutes (non-configurable), either directly or through a web proxy, using the port specified for URL filtering services in [Firewall Information, on page 1289](#) Communication is over HTTPS with mutual certificate authentication. Certificates are updated automatically (see [Service Updates , on page 1003](#).)

If an HTTP or HTTPS proxy has been configured on the **Security Services > Service Updates** page, the appliance will use it when communicating with the Cisco Aggregator Server. For more information about using a proxy server, see [Configuring Server Settings for Downloading Upgrades and Updates , on page 1008](#).



Note Certificates are not saved with a configuration file.

URL Filtering in Cluster Configurations

- You can enable URL filtering at the machine, group or cluster level.
- If URL filtering is enabled at machine level, URL allowed lists and web interaction tracking can be configured at machine, group or cluster level.
- If URL filtering is enabled at group level, URL allowed lists and web interaction tracking must be configured at group or cluster level.
- If URL filtering is enabled at cluster level, URL allowed lists and web interaction tracking must be configured at cluster level.
- The standard rules for clusters for Message Filters and Content Filters apply.

Creating Allowed Lists for URL Filtering

If you specify a global allowed list when configuring the URL Filtering feature, then URLs on the allowed list are not evaluated for reputation or category, for anti-spam, Outbreak Filtering, or content and message filtering. However, the messages that contain these URLs are evaluated as usual by anti-spam scanning and Outbreak Filters. You can also specify a URL allowed list in each URL Filtering condition (rule) and action in content and message filters, to supplement the global URL allowed list.

To categorize allowed list URLs from Outbreak Filtering generally, use the Bypass Domain Scanning option that you configure on the Mail Policies: Outbreak Filters page. URL allowed lists for URL filtering are similar to, but independent of, Bypass Domain Scanning. For more information about that feature, see [URL Rewriting and Bypassing Domains, on page 418](#).

There is no relationship between URL filtering allowed lists described in this section and the allowed list used for sender reputation filtering based on IP Reputation score.

Before You Begin

Consider importing a list of URLs instead of creating one in the web interface. See [Importing a URL List](#), on page 430.

Procedure

Step 1 Select **Mail Policies > URL Lists**.

Step 2 Select **Add URL List** or click a list to edit.

Be sure all URLs that you want to designate globally as an allowed list are in a single list. You can select only one global allowed list for URL filtering.

Step 3 Create and submit the URL list.

To view a list of supported URL formats, enter a semicolon (;) into the **URLs** box and click **Submit**. Then click the **more...** link that appears.

Each URL, domain, or IP address can be on a separate line, or separate each with a comma.

Step 4 Commit your changes.

What to do next

- To designate a URL list as the global allowed list, see [Enable URL Filtering](#), on page 427.
- To designate a URL list as the allowed list for a specific condition (rule) or action in a content or message filter, see [Taking Action Based on the Reputation or Category of URLs in Messages](#), on page 432 and [Content Filter Actions](#), on page 280. For message filters, see also [URL Category Actions](#), on page 216 and [URL Category Rule](#), on page 179.

Related Topics

- [Importing a URL List](#), on page 430

Importing a URL List

You can import a URL list to use as a allowed list for URL filtering.

Procedure

Step 1 Create the text file to import:

- The first line must be the name of the URL list.
- Each URL must be on a separate line.

Step 2 Upload the file to the `/configuration` directory on the appliance.

Step 3 Use the `urllistconfig > new` command in the command-line interface.

Customizing the Notification That End Users See If a Site Is Malicious

If an end user clicks a malicious URL identified by Outbreak Filtering or a Policy (using Content or Message Filters), the Cisco Web Security proxy displays a notification in the end user's web browser. This notification states that the site is malicious and access to it has been blocked.

When an end user clicks on a URL rewritten using Outbreak Filtering, the notification page is displayed for 10 seconds and then is redirected to the Cisco Web Security proxy for click-time evaluation.

You can customize the appearance of this notification page and display your organization's branding such as company logo, contact information, and so on.



Note If you do not customize the notification page, end users see a Cisco branded notification page.

Before You Begin

- Enable URL filtering. See [Enable URL Filtering, on page 427](#).

Procedure

Step 1 Select **Security Services > Block Page Customization**.

Step 2 Click **Enable**.

Step 3 Check the **Enable Block Page customization** check box and enter the following details:

- URL of the organization's logo. It is recommended that the logo image is hosted on a publicly accessible server.
- Organization's name
- Organization's contact information

Step 4 Choose the language of the notification. You can choose any one of the languages supported by the web interface.

Note The default language of the end user's browser takes precedence over the language you have selected here. Also, if the default language of the end user's browser is not supported by AsyncOS, then the notification is displayed in the language you have selected here.

Step 5 (Optional) Preview the notification page by clicking **Preview Block Page Customization** link.

Step 6 Submit and commit your changes.

Next Steps

Set up URL rewriting in one of the following ways:

- Using Outbreak Filters. See [Redirecting URLs, on page 405](#).

- Using Content or Message Filters. See [Taking Action Based on the Reputation or Category of URLs in Messages](#) , on page 432.

Taking Action Based on the Reputation or Category of URLs in Messages

You can take action based on the reputation or category of URL links in the message body or message attachment using message filters and content filters in incoming and outgoing mail policies.

Because Outbreak Filters take many factors into consideration when evaluating messages for malware, and URL reputation alone may not trigger aggressive message handling, you may want to create filters based on URL reputation.

For example, you can use URL Reputation filters to:

- (For URLs in message body only) Rewrite URLs of neutral or unknown reputation to redirect them to the Cisco cloud Web Security proxy service for click-time evaluation.
- Drop messages that include URLs that have reputation scores in the Malicious range.

You can use URL Category filters to:

- Filter categories of URLs to enforce organizational policies for acceptable web use, for example to prevent users from visiting adult or gambling sites while at the office.
- Provide enhanced protection from malicious sites, which may not exist long enough to be classified. (For URLs in message body only) You can redirect all URLs in the Unclassified category to the Cisco cloud Web Security proxy service for evaluation at the time a user clicks a link.

Related Topics

- [Using URL-Related Conditions \(Rules\) and Actions](#) , on page 432
- [Filtering by URL Reputation or URL Category: Conditions and Rules](#) , on page 433
- [Modifying URLs in Messages: Using URL Reputation and URL Category Actions in Filters](#) , on page 434
- [Redirected URLs: What Does the End User Experience?](#) , on page 435

Using URL-Related Conditions (Rules) and Actions

To	Example	Do This
Take action on the message as a whole.	Drop or quarantine messages.	Create a URL Reputation or URL Category condition or rule, then pair it with any action other than a URL Reputation or URL Category action. Exception: Do not pair a URL Reputation condition or rule with a Bounce action.

To	Example	Do This
(For URLs in message body only) Modify URLs in a message, or modify their behavior.	Replace a URL in the message with a text note, or make the URL unclickable.	Create a URL Reputation or URL Category action only; do not use a separate URL filtering condition.

As always, you must specify a content filter in a mail policy in order to use it.

Related Topics

- [Filtering by URL Reputation or URL Category: Conditions and Rules](#) , on page 433
- [Modifying URLs in Messages: Using URL Reputation and URL Category Actions in Filters](#) , on page 434

Filtering by URL Reputation or URL Category: Conditions and Rules

You can perform actions on messages based on the reputation or category of URLs in the message body and message attachments. If you want to perform any action other than modifying URLs or their behavior, add a **URL Reputation** or **URL Category** condition and select the reputation scores or URL categories for which you want to apply the action.

For example, if you want to apply the **Drop (Final Action)** action to all messages that include URLs in the Adult category, add a condition of type **URL Category** with the **Adult** category selected.

If you do not specify a category, the action you choose is applied to all messages.

URL reputation score ranges for clean, neutral, and malicious URLs are predefined and not editable. However, you can specify a custom range instead. The specified endpoints are included in the range you specify. For example, if you create a custom range from -8 to -10, then -8 and -10 are included in the range. Use “No Score” for URLs for which a reputation score cannot be determined.



Note Neutral URL reputation means that URLs are currently clean, but may turn malicious in future, as they are prone to attacks. For such URLs, administrators can create non-blocking policies, for example, redirecting them to the Cisco Web Security Proxy for click-time evaluation.

URLs that are included on the selected URL allowed list or on the global URL allowed list not evaluated.

The action that you pair with this condition is taken if any URL in the message matches the reputation score or any category specified in the condition.

If you want to modify URLs in a message, or modify their behavior, configure only a URL Reputation or URL Category action. You do not need a separate URL Reputation or URL Category condition or rule for this purpose.



Note Do not pair a URL Reputation condition with a Bounce action.



Tip To check the category of a particular URL, visit the link in [Reporting Uncategorized and Misclassified URLs](#), on page 456.

Related Topics

- [Creating Allowed Lists for URL Filtering](#), on page 429
- [Content Filters](#), on page 271

Modifying URLs in Messages: Using URL Reputation and URL Category Actions in Filters

Use a URL Reputation or URL Category action to modify URLs in a message, or their behavior, based on the reputation or category of the URL.

URL Reputation and URL Category actions do not require a separate condition. Instead, the selected action is applied based on the reputation or categories that you select in the URL Reputation or URL Category action.

The action is applied only to URLs that meet the criteria specified in the action. Other URLs in the message are not modified.

If you do not specify a category, the action you choose is applied to all messages.

URL reputation score ranges for clean, neutral, and malicious URLs are predefined and not editable. However, you can specify a custom range instead. The specified endpoints are included in the range you specify. For example, if you create a custom range from -8 to -10, then -8 and -10 are included in the range. Use “No Score” for URLs for which a reputation score cannot be determined.



Note Neutral URL reputation means that URLs are currently clean, but may turn malicious in future, as they are prone to attacks. For such URLs, administrators can create non-blocking policies, for example, redirecting them to the Cisco Web Security Proxy for click-time evaluation.

The following URL-related actions are only applicable for URLs in the message body::

- Defang a URL so that it is unclickable. Message recipients can still see and copy the URL.
- Redirect a URL so that if the message recipient clicks the link, the transaction is routed to a Cisco web security proxy in the cloud, which blocks access if the site is malicious.

Example: You might want to redirect all URLs in the **Uncategorized** category to the Cisco Cloud Web Security proxy service, as malicious sites used in phishing attacks often do not exist long enough to be classified.

See also [Redirected URLs: What Does the End User Experience?](#), on page 435.

To redirect URLs to a different proxy, see the example in the following bullet.



Note The Cisco Cloud Web Security proxy service has no configurable options in this release. For example, there is no threat score threshold to adjust or action to specify based on threat score.

- Replace the URL with any text.

To include the original URL in the text that appears in the message, use the \$URL variable.

Examples:

- Replace all URLs in the **Illegal Downloads** category with a note:

```
Message from your system administrator: A link to an illegal downloads web site has been removed from this message.
```

- Include the original URL along with a warning:

```
WARNING! The following URL may contain malware: $URL
```

This becomes: WARNING: The following URL may contain malware: http://example.com.

- Redirect to a custom proxy or web security service:

```
http://custom_proxy/$URL
```

This becomes: http://custom_proxy/http://example.com

The reputation and category of URLs that are included on the selected URL allowed list or on the global URL allowed list are not evaluated.

If you defang or replace URLs, you can choose to ignore URLs in signed messages.

Pairing a URL Reputation or URL Category action with a URL Reputation or URL Category condition (or rule) is not recommended. If you pair a condition (rule) and action that include different categories, then no match occurs.



Tip To check the category of a particular URL, visit the link in [Reporting Uncategorized and Misclassified URLs](#), on page 456.

Related Topics

- [Creating Allowed Lists for URL Filtering](#), on page 429
- [Using Custom Headers to Redirect URLs in Suspected Spam to the Cisco Web Security Proxy: Configuration Example](#), on page 380
- [Content Filters](#), on page 271
- [URL Reputation Rules](#), on page 178
- [URL Category Rule](#), on page 179

Redirected URLs: What Does the End User Experience?

Based on the evaluation by the Cisco Cloud Web Security proxy service:

- If the site is benign, the user is directed to the target web site and has no knowledge that the link has been redirected.
- If the site is malicious, the user sees a notice that the site is malicious and access to it has been blocked.

You can customize the appearance of end user notification page and display your organization's branding such as company logo, contact information, and so on. See [Customizing the Notification That End Users See If a Site Is Malicious](#), on page 431.

- If communication with the Cisco Cloud Web Security proxy service times out, the user is allowed to access the target web site.
- If any other error occurs, the user sees a notice.

Related Topics

- [Modifying URLs in Messages: Using URL Reputation and URL Category Actions in Filters](#), on page 434

Handling Unscannable Messages for URL Filtering

In the following scenarios, the URL filtering scanning fails, and the following header - *X-URL-LookUp-ScanningError* is added to the message:

- Unable to obtain the URL Reputation and Category
- Unable to expand the shortened URLs in the message
- Number of URLs in the message body or message attachments exceeds the maximum URL scan limit

You can add a content filter, select the *X-URL-LookUp-ScanningError* header in the Other Header condition, and configure appropriate actions to take on the message.

Detecting Malicious URLs in Messages Using Content Filter

Use the 'URL Reputation' content filter to detect URLs in messages categorized as malicious by the ETF engine and take appropriate actions on such messages.

You can configure the 'URL Reputation' content filter for ETF in any one of the following ways:

- Use the 'URL Reputation' condition with any appropriate action.
- Use the 'URL Reputation' action with any or no condition.
- Use the 'URL Reputation' condition and action.

The following procedure is used to detect malicious URLs using the 'URL Reputation' condition and action:



Note

- If you only want to use the 'URL Reputation' condition with any appropriate action, do not follow steps 11-20 of the procedure.
- If you only want to use the 'URL Reputation' action with any or no condition., do not follow steps 4-10 of the procedure.

Before you begin

- Make sure that you enable URL filtering on your email gateway. To enable URL filtering, go to *Security Services > URL Filtering* page in the web interface. For more information, see [Protecting Against Malicious or Undesirable URLs, on page 425](#).
- Make sure that you enable Outbreak Filters on your email gateway. To enable Outbreak Filters, go to *Security Services > Outbreak Filters* page in the web interface. For more information, see [Outbreak Filters, on page 401](#).
- Make sure that you enable Anti-Spam engine on your email gateway. To enable the Anti-Spam engine, go to *Security Services > Anti-Spam* page in the web interface. For more information, see [Managing Spam and Graymail, on page 359](#).
- (Optional) Create a URL list. To create one, go to *Mail Policies > URL Lists* page in the web interface. For more information, see [Protecting Against Malicious or Undesirable URLs, on page 425](#).

Procedure

- Step 1** Go to **Mail Policies > Incoming Content Filters**.
- Step 2** Click **Add Filter**.
- Step 3** Enter a name and description for the content filter.
- Step 4** Click **Add Condition**.
- Step 5** Click **URL Reputation**.
- Step 6** Select **External Threat Feeds**.
- Step 7** Select the ETF source(s) to detect malicious URLs.
- Step 8** (Optional) Select the list of allow listed URLs that you do not want the email gateway to detect for threats.
- Step 9** Select the required **Check URLs within** option to detect malicious URLs in the message body and subject and/or message attachments.
- Step 10** Click **OK**.
- Step 11** Click **Add Action**.
- Step 12** Click **URL Reputation**.
- Step 13** Select **External Threat Feeds**.
- Step 14** Make sure that you select the same ETF source(s) that you selected in the condition (Step 7).
- Step 15** (Optional) Select the same list of allow listed URLs that you selected in Step 8.
- Step 16** Select the required **Check URLs within** option to detect malicious URLs in the 'message body and subject' and/or 'message attachments'
- Step 17** Select the required action that you want to perform on the URLs within the message body and subject and/or message attachments.
- Note** In Step 16, if you choose the 'Check URLs within' option as 'Attachments', you can only strip the attachment from the message.
- Step 18** Select whether you want to take actions on all messages or unsigned messages.
- Step 19** Click **OK**.
- Step 20** Submit and commit your changes.

Note If you have configured URL Reputation content filters for Web Based Reputation Score (WBR) and ETF on your email gateway, it is recommended to set the order of the WBR URL Reputation content filter higher than the order of the ETF URL Reputation filter, to improve the performance of your email gateway.

Detecting Malicious URLs in Messages Using Message Filter

As an example, use the 'URL Reputation' message filter rule syntax to detect malicious URLs in messages using the ETF engine, and to defang the URL.

Syntax:

```
defang_url_in_message: if (url-external-threat-feeds (['etf_source1'],
<'URL_allowedlist'>,
<'message_attachments'> , <'message_body_subject'> ,))
{ url-etf-defang(['etf_source1'], "", 0); } <'URL_allowedlist'> ,
<'Preserve_signed'>}
```

Where

- 'url-external-threat-feeds' is the URL Reputation rule.
- 'etf_source1' is the ETF source(s) used to detect malicious URLs in the messages or message attachments.
- 'URL_allowedlist' is the name of a URL allowed list. If a URL allowed list is not present, it is displayed as "".
- 'message_attachments' is used to check for malicious URLs in the message attachments. A value of '1' is used to detect malicious URLs in the message attachments.
- 'message_body_subject' is used to check for malicious URLs in the message body and subject. A value of '1' is used to detect malicious URLs in the message body and subject.



Note A value of "1,1" is used to detect malicious URLs in the message body, subject, and message attachments.

- 'url-etf-defang' is one of the actions that you can take on messages that contain malicious URLs.

The following examples are the ETF-based actions that you can apply on messages that contain malicious URLs:

- url-etf-strip(['etf_source1'], "None", 1)
- url-etf-defang-strip(['etf_source1'], "None", 1, "Attachment removed")
- url-etf-defang-strip(['etf_source1'], "None", 1)
- url-etf-proxy-redirect(['etf_source1'], "None", 1)
- url-etf-proxy-redirect-strip(['etf_source1'], "None", 1)
- url-etf-proxy-redirect-strip(['etf_source1'], "None", 1, " Attachment removed")

- `url-etf-replace(['etf_source1'], "", "None", 1)`
 - `url-etf-replace(['etf_source1'], "URL removed", "None", 1)`
 - `url-etf-replace-strip(['etf_source1'], "URL removed ", "None", 1)`
 - `url-etf-replace-strip(['etf_source1'], "URL removed*", "None", 1, "Attachment removed")`
- `'Preserve_signed'` is represented by '1' or '0'. '1' indicates that this action applies to unsigned messages only and '0' indicates that this action applies to all messages.

In the following example, if a URL in the message attachment is detected as malicious by the ETF engine, the attachment is stripped.

```
Strip_Malicious_URLs: if (true) {url-etf-strip(['threat_feed_source'], "", 0);}
```

Monitoring URL Filtering Results

To view data about malicious and neutral URLs detected, select **Monitor > URL Filtering**. For important information about the data on this page, see [URL Filtering Page](#), on page 829.

Displaying URL Details in Message Tracking

To display details in Message Tracking for URLs caught by outbreak filters and relevant content filters:

- Message Tracking must be enabled.
- Outbreak filters and/or content filters based on URL reputation or URL Category must be operational.
- For outbreak filters, URL Rewriting must be enabled. See [URL Rewriting and Bypassing Domains](#), on page 418.
- URL logging must be enabled. See [Enabling Logging of URLs and Message Tracking Details for URLs](#), on page 413.

For more information about the data displayed, see [Message Tracking Details](#), on page 894.

To manage administrative user access to these potentially sensitive details, see [Controlling Access to Sensitive Information in Message Tracking](#), on page 953.

Troubleshooting URL Filtering

Related Topics

- [Viewing Logs](#), on page 440
- [Alert: Beaker Connector: Error Fetching Enrollment Certificate](#), on page 440
- [Alert: Beaker Connector: Certificate Is Invalid](#), on page 440
- [Unable to Connect to Talos Intelligence Services](#), on page 441
- [Alert: Unable to Connect to the Cisco Aggregator Server](#), on page 441
- [Alert: Unable to Retrieve Web Interaction Tracking Information from the Cisco Aggregator Server](#), on page 441

- [Using the websecurityadvancedconfig Command](#) , on page 442
- [Message Tracking Search Does Not Find Messages with Specified Category](#) , on page 442
- [Malicious URLs and Marketing Messages Are Not Caught by Anti-Spam or Outbreak Filters](#) , on page 442
- [URLs in a Filtered Category Are Not Handled Correctly](#) , on page 442
- [End User Reaches Malicious Site via Rewritten URL](#) , on page 443
- [Manually Configuring a Certificate for Communication with Talos Intelligence Services](#) , on page 443

Viewing Logs

URL filtering information is posted to the following logs:

- Mail Logs (mail_logs). Information related to the result of scanning a URL (action taken of a message depending on the URL) is posted to this log.
- URL Filtering Logs (web_client). Information related to errors, timeouts, network issues, and so on while attempting the URL lookup are posted this log.

Most information is at Info or Debug level.

Logs do not include information about what happens when a user clicks a redirected link in a message.

"SDS" and in logs refers to URL reputation services. "Beaker Connector" refers to Talos engine.

Alert: Beaker Connector: Error Fetching Enrollment Certificate

Problem

You receive an info-level alert about an error fetching the enrollment client certificate.

Solution

This certificate is required to connect to the following cloud-based services: Talos Intelligence Services (to obtain URL reputation and category) and Cisco Aggregator Server (to obtain web interaction tracking data). Try the following:

1. Check for networking issues such as incorrect proxy settings or firewall issues.
2. Verify that your URL Filtering feature key is valid and active.
3. If the problem persists, contact Cisco TAC.

Alert: Beaker Connector: Certificate Is Invalid

Problem

You receive a critical alert about an invalid Beaker connector certificate.

Solution

This certificate is required to connect to Talos Intelligence Services in the cloud in order to obtain URL reputation and category.

To obtain and manually install a certificate, see [Manually Configuring a Certificate for Communication with Talos Intelligence Services](#) , on page 443.

Unable to Connect to Talos Intelligence Services

Problem

The **Security Services > URL Filtering** page persistently indicates an issue connecting to Talos Intelligence Services.

Solution

- If you have enabled URL filtering but have not yet committed the change, commit the change.
- Check for recent alerts related to the connection with Talos Intelligence Services. See [Viewing Recent Alerts, on page 1024](#). If applicable, see [Alert: Beaker Connector: Error Fetching Enrollment Certificate, on page 440](#) and [Alert: Beaker Connector: Certificate Is Invalid, on page 440](#).
- If you are connecting via a proxy specified in **Security Services > Service Updates**, verify that this is configured and working properly.
- Check for other network issues that might prevent connection.
- If you see errors in the URL Filtering Logs related to timed out requests to the Talos client, use the `websecuritydiagnostics` command and the `websecurityadvancedconfig` command in the command-line interface to investigate and make changes:
 - If the diagnostics show that Response Time is not less than the configured URL Lookup Timeout, increase the URL Lookup Timeout value accordingly.
- Check the URL Filtering Logs for non-timeout errors in communications with the URL scanner, Cisco Web Security Services, or Talos client. "Talos client" in logs represents Talos Intelligence Services. If you see such log messages, contact TAC.

Alert: Unable to Connect to the Cisco Aggregator Server

Problem

You receive the following warning alert: Unable to Connect to the Cisco Aggregator Server.

Solution

Do the following:

1. Check the connectivity between the appliance and the Cisco Aggregator Server by pinging the hostname of the server from the appliance. Use the `aggregatorconfig` command in CLI to view the hostname of the Cisco Aggregator Server.
2. If you are connecting via a proxy specified in **Security Services > Service Updates**, verify that this is configured and working properly.
3. Check for other network issues that might prevent connection.
4. Check if the DNS service is running.
5. If the problem persists, contact Cisco TAC.

Alert: Unable to Retrieve Web Interaction Tracking Information from the Cisco Aggregator Server

Problem

You receive the following warning alert: Unable to retrieve web interaction tracking information from the Cisco Aggregator Server.

Solution

Do the following:

1. If you are connecting via a proxy specified in **Security Services > Service Updates**, verify that this is configured and working properly.
2. Check for other network issues that might prevent connection.
3. Check if the DNS service is running.
4. If the problem persists, contact Cisco TAC.

Using the `websecurityadvancedconfig` Command

Except for changes explicitly described in this document, make no other changes using the `websecurityadvancedconfig` command without guidance from TAC.

Message Tracking Search Does Not Find Messages with Specified Category

Problem

Messages that contain URLs in a particular category are not found when searching by that category.

Solution

See [Expected Messages Are Missing from Search Results](#) , on page 897.

Malicious URLs and Marketing Messages Are Not Caught by Anti-Spam or Outbreak Filters

Problem

Malicious URLs and messages containing marketing links are not caught by the anti-spam or outbreak filters.

Solution

- This can occur because web site reputation and category are only two among many criteria that anti-spam and outbreak filters use to determine their verdicts. You can increase the sensitivity of these filters by lowering the thresholds required to take action such as rewriting or replacing URLs with text, or quarantining or dropping messages. For details, see [The Outbreak Filters Feature and Mail Policies](#), on page 415 and [Defining Anti-Spam Policies](#) , on page 376. Alternatively, create content or message filters based on URL reputation score.
- This can also occur if the appliance is unable to connect to the Talos Intelligence Services. See [Unable to Connect to Talos Intelligence Services](#), on page 441.

URLs in a Filtered Category Are Not Handled Correctly

Problem

The defined action in a content or message filter based on URL category is not applied.

Solution

- Use the Trace feature (described in the Troubleshooting chapter) to follow the message processing path.

- This can occur if the appliance is unable to connect to the Talos Intelligence Services. See [Unable to Connect to Talos Intelligence Services, on page 441](#).
- If there are no connection issues, the URLs may not yet be categorized, or may be miscategorized. See [Reporting Uncategorized and Misclassified URLs, on page 456](#). You can use this site to determine the category of a URL.

End User Reaches Malicious Site via Rewritten URL

Problem

A malicious URL was redirected to the Cisco Web Security Proxy, but the end user was able to access the site anyway.

Solution

This can occur if:

- The site was not yet identified as a malicious site.
- The connection to the Cisco Web Security Proxy timed out, which should be a rare occurrence. Ensure that network issues are not interfering with the connection.

Manually Configuring a Certificate for Communication with Talos Intelligence Services

Use this procedure if the appliance is unable to automatically obtain a certificate for communication with Talos Intelligence Services.

Procedure

-
- | | |
|---------------|---|
| Step 1 | Obtain the required certificate. |
| Step 2 | Upload the certificate using Network > Certificates , or use the <code>certconfig</code> command in the command-line interface. |
| Step 3 | In the command-line interface, enter the <code>websecurityconfig</code> command. |
| Step 4 | Follow the prompts to set the client certificate for Talos Intelligence Services Authentication. |
-

About URL Categories

Related Topics

- [URL Category Descriptions, on page 444](#)
- [Determining the Category of a URL, on page 456](#)
- [Reporting Uncategorized and Misclassified URLs, on page 456](#)
- [Future URL Category Set Changes, on page 456](#)

URL Category Descriptions

These URL categories are the same categories that are used on recent releases of AsyncOS for Web Security appliances.

URL Category	Abbreviation	Code	Description	Example URLs
Adult	adlt	1006	Directed at adults, but not necessarily pornographic. May include adult clubs (strip clubs, swingers clubs, escort services, strippers); general information about sex, non-pornographic in nature; genital piercing; adult products or greeting cards; information about sex not in the context of health or disease.	www.adultentertainmentexpo.com www.adultnetline.com
Advertisements	adv	1027	Banner and pop-up advertisements that often accompany a web page; other advertising websites that provide advertisement content. Advertising services and sales are classified as "Business and Industry."	www.adforce.com www.doubleclick.com
Alcohol	alc	1077	Alcohol as a pleasurable activity; beer and wine making, cocktail recipes; liquor sellers, wineries, vineyards, breweries, alcohol distributors. Alcohol addiction is classified as "Health and Nutrition." Bars and restaurants are classified as "Dining and Drinking."	www.samueladams.com www.whisky.com
Arts	art	1002	Galleries and exhibitions; artists and art; photography; literature and books; performing arts and theater; musicals; ballet; museums; design; architecture. Cinema and television are classified as "Entertainment."	www.moma.org www.nga.gov
Astrology	astr	1074	Astrology; horoscope; fortune telling; numerology; psychic advice; tarot.	www.astro.com www.astrology.com
Auctions	auct	1088	Online and offline auctions, auction houses, and classified advertisements.	www.craigslist.com www.ebay.com

URL Category	Abbrevia-tion	Code	Description	Example URLs
Business and Industry	busi	1019	Marketing, commerce, corporations, business practices, workforce, human resources, transportation, payroll, security and venture capital; office supplies; industrial equipment (process equipment), machines and mechanical systems; heating equipment, cooling equipment; materials handling equipment; packaging equipment; manufacturing: solids handling, metal fabrication, construction and building; passenger transportation; commerce; industrial design; construction, building materials; shipping and freight (freight services, trucking, freight forwarders, truckload carriers, freight and transportation brokers, expedited services, load and freight matching, track and trace, rail shipping, ocean shipping, road feeder services, moving and storage).	www.freightcenter.com www.staples.com
Chat and Instant Messaging	chat	1040	Web-based instant messaging and chat rooms.	www.icq.com www.meebo.com
Cheating and Plagiarism	plag	1051	Promoting cheating and selling written work, such as term papers, for plagiarism.	www.bestessays.com www.superiorpapers.com
Child Abuse Content	cprn	1064	Worldwide illegal child sexual abuse content.	—
Computer Security	csec	1065	Offering security products and services for corporate and home users.	www.computersecurity.com www.symantec.com

URL Category	Abbreviation	Code	Description	Example URLs
Computers and Internet	comp	1003	Information about computers and software, such as hardware, software, software support; information for software engineers, programming and networking; website design; the web and Internet in general; computer science; computer graphics and clip art. "Freeware and Shareware" is a separate category.	www.xml.com www.w3.org
Dating	date	1055	Dating, online personals, matrimonial agencies.	www.eharmony.com www.match.com
Digital Postcards	card	1082	Enabling sending of digital postcards and e-cards.	www.all-yours.net www.delivr.net
Dining and Drinking	food	1061	Eating and drinking establishments; restaurants, bars, taverns, and pubs; restaurant guides and reviews.	www.hideawaybrewpub.com www.restaurantrow.com
Dynamic and Residential	dyn	1091	IP addresses of broadband links that usually indicates users attempting to access their home network, for example for a remote session to a home computer.	http://109.60.192.55 http://dynalink.co.jp http://ipadsl.net
Education	edu	1001	Education-related, such as schools, colleges, universities, teaching materials, and teachers' resources; technical and vocational training; online training; education issues and policies; financial aid; school funding; standards and testing.	www.education.com www.greatschools.org
Entertainment	ent	1093	Details or discussion of films; music and bands; television; celebrities and fan websites; entertainment news; celebrity gossip; entertainment venues. Compare with the "Arts" category.	www.eonline.com www.ew.com

URL Category	Abbrevia-tion	Code	Description	Example URLs
Extreme	extr	1075	Material of a sexually violent or criminal nature; violence and violent behavior; tasteless, often gory photographs, such as autopsy photos; photos of crime scenes, crime and accident victims; excessive obscene material; shock websites.	www.car-accidents.com www.crime-scene-photos.com
Fashion	fash	1076	Clothing and fashion; hair salons; cosmetics; accessories; jewelry; perfume; pictures and text relating to body modification; tattoos and piercing; modeling agencies. Dermatological products are classified as "Health and Nutrition."	www.fashion.net www.findabeautysalon.com
File Transfer Services	fts	1071	File transfer services with the primary purpose of providing download services and hosted file sharing	www.rapidshare.com www.yousendit.com
Filter Avoidance	filt	1025	Promoting and aiding undetectable and anonymous web usage, including cgi, php and glype anonymous proxy services.	www.bypassschoolfilter.com www.filterbypass.com
Finance	fnnc	1015	Primarily financial in nature, such as accounting practices and accountants, taxation, taxes, banking, insurance, investing, the national economy, personal finance involving insurance of all types, credit cards, retirement and estate planning, loans, mortgages. Stock and shares are classified as "Online Trading."	finance.yahoo.com www.bankofamerica.com
Freeware and Shareware	free	1068	Providing downloads of free and shareware software.	www.freewarehome.com www.shareware.com

URL Category	Abbreviation	Code	Description	Example URLs
Gambling	gamb	1049	Casinos and online gambling; bookmakers and odds; gambling advice; competitive racing in a gambling context; sports booking; sports gambling; services for spread betting on stocks and shares. Websites dealing with gambling addiction are classified as “Health and Nutrition.” Government-run lotteries are classified as “Lotteries”.	www.888.com www.gambling.com
Games	game	1007	Various card games, board games, word games, and video games; combat games; sports games; downloadable games; game reviews; cheat sheets; computer games and Internet games, such as role-playing games.	www.games.com www.shockwave.com
Government and Law	gov	1011	Government websites; foreign relations; news and information relating to government and elections; information relating to the field of law, such as attorneys, law firms, law publications, legal reference material, courts, dockets, and legal associations; legislation and court decisions; civil rights issues; immigration; patents and copyrights; information relating to law enforcement and correctional systems; crime reporting, law enforcement, and crime statistics; military, such as the armed forces, military bases, military organizations; anti-terrorism.	www.usa.gov www.law.com
Hacking	hack	1050	Discussing ways to bypass the security of websites, software, and computers.	www.hackthissite.org www.gohacking.com

URL Category	Abbrevia-tion	Code	Description	Example URLs
Hate Speech	hate	1016	Websites promoting hatred, intolerance, or discrimination on the basis of social group, color, religion, sexual orientation, disability, class, ethnicity, nationality, age, gender, gender identity; sites promoting racism; sexism; racist theology; hate music; neo-Nazi organizations; supremacism; Holocaust denial.	www.kkk.com www.nazi.org
Health and Nutrition	hlth	1009	Health care; diseases and disabilities; medical care; hospitals; doctors; medicinal drugs; mental health; psychiatry; pharmacology; exercise and fitness; physical disabilities; vitamins and supplements; sex in the context of health (disease and health care); tobacco use, alcohol use, drug use, and gambling in the context of health (disease and health care); food in general; food and beverage; cooking and recipes; food and nutrition, health, and dieting; cooking, including recipe and culinary websites; alternative medicine.	www.health.com www.webmd.com
Humor	lol	1079	Jokes, sketches, comics and other humorous content. Adult humor likely to offend is classified as "Adult."	www.humor.com www.jokes.com
Illegal Activities	ilac	1022	Promoting crime, such as stealing, fraud, illegally accessing telephone networks; computer viruses; terrorism, bombs, and anarchy; websites depicting murder and suicide as well as explaining ways to commit them.	www.ekran.no www.thedisease.net

URL Category	Abbreviation	Code	Description	Example URLs
Illegal Downloads	ildl	1084	Providing the ability to download software or other materials, serial numbers, key generators, and tools for bypassing software protection in violation of copyright agreements. Torrents are classified as “Peer File Transfer.”	www.keygenguru.com www.zcrack.com
Illegal Drugs	drug	1047	Information about recreational drugs, drug paraphernalia, drug purchase and manufacture.	www.cocaine.org www.hightimes.com
Infrastructure and Content Delivery Networks	infr	1018	Content delivery infrastructure and dynamically generated content; websites that cannot be classified more specifically because they are secured or otherwise difficult to classify.	www.akamai.net www.webstat.net
Internet Telephony	voip	1067	Telephonic services using the Internet.	www.evaphone.com www.skype.com
Job Search	job	1004	Career advice; resume writing and interviewing skills; job placement services; job databanks; permanent and temporary employment agencies; employer websites.	www.careerbuilder.com www.monster.com
Lingerie and Swimsuits	ling	1031	Intimate apparel and swim wear, especially when modeled.	www.swimsuits.com www.victoriassecret.com
Lotteries	lotr	1034	Sweepstakes, contests and state-sponsored lotteries.	www.calottery.com www.flalottery.com
Mobile Phones	cell	1070	Short Message Services (SMS); ring tones and mobile phone downloads. Cellular carrier websites are included in the “Business and Industry” category.	www.cbfsms.com www.zedge.net

URL Category	Abbreviation	Code	Description	Example URLs
Nature	natr	1013	Natural resources; ecology and conservation; forests; wilderness; plants; flowers; forest conservation; forest, wilderness, and forestry practices; forest management (reforestation, forest protection, conservation, harvesting, forest health, thinning, and prescribed burning); agricultural practices (agriculture, gardening, horticulture, landscaping, planting, weed control, irrigation, pruning, and harvesting); pollution issues (air quality, hazardous waste, pollution prevention, recycling, waste management, water quality, and the environmental cleanup industry); animals, pets, livestock, and zoology; biology; botany.	www.enature.com www.nature.org
News	news	1058	News; headlines; newspapers; television stations; magazines; weather; ski conditions.	www.cnn.com news.bbc.co.uk
Non-Governmental Organizations	ngo	1087	Non-governmental organizations such as clubs, lobbies, communities, non-profit organizations and labor unions.	www.panda.org www.unions.org
Non-Sexual Nudity	nsn	1060	Nudism and nudity; naturism; nudist camps; artistic nudes.	www.artenuda.com www.naturistsociety.com
Online Communities	comm	1024	Affinity groups; special interest groups; web newsgroups; message boards. Excludes websites classified as “Professional Networking” or “Social Networking.”	www.igda.org www.ieee.org
Online Storage and Backup	osb	1066	Offsite and peer-to-peer storage for backup, sharing, and hosting.	www.adrive.com www.dropbox.com

URL Category	Abbreviation	Code	Description	Example URLs
Online Trading	trad	1028	Online brokerages; websites that enable the user to trade stocks online; information relating to the stock market, stocks, bonds, mutual funds, brokers, stock analysis and commentary, stock screens, stock charts, IPOs, stock splits. Services for spread betting on stocks and shares are classified as "Gambling." Other financial services are classified as "Finance."	www.tdameritrade.com www.scottrade.com
Organizational Email	pem	1085	Websites used to access business email (often via Outlook Web Access).	—
Parked Domains	park	1092	Websites that monetize traffic from the domain using paid listings from an ad network, or are owned by "squatters" hoping to sell the domain name for a profit. These also include fake search websites which return paid ad links.	www.domainzaar.com www.parked.com
Peer File Transfer	p2p	1056	Peer-to-peer file request websites. This does not track the file transfers themselves.	www.bittorrent.com www.limewire.com
Personal Sites	pers	1081	Websites about and from private individuals; personal homepage servers; websites with personal contents; personal blogs with no particular theme.	www.karymullis.com www.stallman.org
Photo Searches and Images	img	1090	Facilitating the storing and searching for, images, photographs, and clip-art.	www.flickr.com www.photobucket.com
Politics	pol	1083	Websites of politicians; political parties; news and information on politics, elections, democracy, and voting.	www.politics.com www.thisnation.com

URL Category	Abbreviation	Code	Description	Example URLs
Pornography	porn	1054	Sexually explicit text or depictions. Includes explicit anime and cartoons; general explicit depictions; other fetish material; explicit chat rooms; sex simulators; strip poker; adult movies; lewd art; web-based explicit email.	www.redtube.com www.youporn.com
Professional Networking	pnet	1089	Social networking for the purpose of career or professional development. See also “Social Networking.”	www.linkedin.com www.europeanpwn.net
Real Estate	rest	1045	Information that would support the search for real estate; office and commercial space; real estate listings, such as rentals, apartments, and homes; house building.	www.realtor.com www.zillow.com
Reference	ref	1017	City and state guides; maps, time; reference sources; dictionaries; libraries.	www.wikipedia.org www.yellowpages.com
Religion	rel	1086	Religious content, information about religions; religious communities.	www.religionfacts.com www.religioustolerance.org
SaaS and B2B	saas	1080	Web portals for online business services; online meetings.	www.netsuite.com www.salesforce.com
Safe for Kids	kids	1057	Directed at, and specifically approved for, young children.	kids.discovery.com www.nickjr.com
Science and Technology	sci	1012	Science and technology, such as aerospace, electronics, engineering, mathematics, and other similar subjects; space exploration; meteorology; geography; environment; energy (fossil, nuclear, renewable); communications (telephones, telecommunications).	www.physorg.com www.science.gov
Search Engines and Portals	srch	1020	Search engines and other initial points of access to information on the Internet.	www.bing.com www.google.com

URL Category	Abbreviation	Code	Description	Example URLs
Sex Education	sxed	1052	Factual websites dealing with sex; sexual health; contraception; pregnancy.	www.avert.org www.scarleteen.com
Shopping	shop	1005	Bartering; online purchasing; coupons and free offers; general office supplies; online catalogs; online malls.	www.amazon.com www.shopping.com
Social Networking	snet	1069	Social networking. See also "Professional Networking."	www.facebook.com www.twitter.com
Social Science	socs	1014	Sciences and history related to society; archaeology; anthropology; cultural studies; history; linguistics; geography; philosophy; psychology; women's studies.	www.archaeology.org www.anthropology.net
Society and Culture	scty	1010	Family and relationships; ethnicity; social organizations; genealogy; seniors; child-care.	www.childcare.gov www.familysearch.org
Software Updates	swup	1053	Websites that host updates for software packages.	www.softwarepatch.com www.versiontracker.com
Sports and Recreation	sprt	1008	All sports, professional and amateur; recreational activities; fishing; fantasy sports; public parks; amusement parks; water parks; theme parks; zoos and aquariums; spas.	www.espn.com www.recreation.gov
Streaming Audio	aud	1073	Real-time streaming audio content including Internet radio and audio feeds.	www.live-radio.net www.shoutcast.com
Streaming Video	vid	1072	Real-time streaming video including Internet television, web casts, and video sharing.	www.hulu.com www.youtube.com
Tobacco	tob	1078	Pro-tobacco websites; tobacco manufacturers; pipes and smoking products (not marketed for illegal drug use). Tobacco addiction is classified as "Health and Nutrition."	www.bat.com www.tobacco.org

URL Category	Abbrevia-tion	Code	Description	Example URLs
Transportation	trns	1044	Personal transportation; information about cars and motorcycles; shopping for new and used cars and motorcycles; car clubs; boats, airplanes, recreational vehicles (RVs), and other similar items. Note, car and motorcycle racing is classified as “Sports and Recreation.”	www.cars.com www.motorcycles.com
Travel	trvl	1046	Business and personal travel; travel information; travel resources; travel agents; vacation packages; cruises; lodging and accommodation; travel transportation; flight booking; airfares; car rental; vacation homes.	www.expedia.com www.lonelyplanet.com
Unclassified	—	—	Websites which are not in the Cisco database are recorded as unclassified for reporting purposes. This may include mistyped URLs.	—
Weapons	weap	1036	Information relating to the purchase or use of conventional weapons such as gun sellers, gun auctions, gun classified ads, gun accessories, gun shows, and gun training; general information about guns; other weapons and graphic hunting sites may be included. Government military websites are classified as “Government and Law.”	www.coldsteel.com www.gunbroker.com
Web Hosting	whst	1037	Website hosting; bandwidth services.	www.bluehost.com www.godaddy.com
Web Page Translation	tran	1063	Translation of web pages between languages.	babelfish.yahoo.com translate.google.com

URL Category	Abbreviation	Code	Description	Example URLs
Web-Based Email	mail	1038	Public web-based email services. Websites enabling individuals to access their company or organization's email service are classified as "Organizational Email."	mail.yahoo.com www.hotmail.com

Determining the Category of a URL

To look up the category of a particular URL, visit the site shown in [Reporting Uncategorized and Misclassified URLs](#), on page 456.

Reporting Uncategorized and Misclassified URLs

To report URLs that have been miscategorized, and URLs that are not categorized but should be, visit:

https://talosintelligence.com/reputation_center/support

To check the status of submitted URLs, click the **Status on Submitted URLs** tab on this page.

Future URL Category Set Changes

Rarely, the set of URL categories may change as a result of emerging trends and technologies. For example, a category may be added or removed, renamed, merged with another category, or split into two categories. These changes can affect the results from existing filters, so if changes occur, the appliance will send an alert (System type, Warning severity). If you receive such an alert, you should evaluate and possibly update content and message filters to work with the updated categories. Existing filters will not automatically be changed. To ensure that you receive these alerts, see [Adding Alert Recipients](#), on page 1022.

The following changes do not require category set changes and will not generate alerts:

- Routine categorization of newly-categorized sites.
- Recategorization of misclassified sites.



CHAPTER 20

File Reputation Filtering and File Analysis

This chapter contains the following sections:

- [Overview of File Reputation Filtering and File Analysis](#) , on page 457
- [Configuring File Reputation and Analysis Features](#), on page 461
- [File Reputation and File Analysis Reporting and Tracking](#) , on page 478
- [Taking Action When File Threat Verdicts Change](#) , on page 480
- [Troubleshooting File Reputation and Analysis](#) , on page 480

Overview of File Reputation Filtering and File Analysis

Advanced Malware Protection protects against zero-day and targeted file-based threats in email attachments by:

- Obtaining the reputation of known files.
- Analyzing behavior of certain files that are not yet known to the reputation service.
- Continuously evaluating emerging threats as new information becomes available, and notifying you about files that are determined to be threats after they have entered your network.

This feature is available for incoming messages and outgoing messages.

The file reputation and file analysis services have options for either public- or private-cloud (on-premises).

- The private-cloud file reputation service is provided by Cisco AMP Virtual Private Cloud appliance, operating in either “proxy” or “air-gap” (on-premises) mode. See [Configuring an On-premises File Reputation Server](#), on page 462.
- The private-cloud file analysis service is provided by an on-premises Cisco AMP Threat Grid appliance. See [Configuring an On-Premises File Analysis Server](#) , on page 462.

File Threat Verdict Updates

Threat verdicts can change as new information emerges. A file may initially be evaluated as unknown or clean, and the file may therefore be released to the recipient. If the threat verdict changes as new information becomes available, you will be alerted, and the file and its new verdict appear in the AMP Verdict Updates report. You can investigate the point-of-entry message as a starting point to remediating any impacts of the threat.

Verdicts can also change from malicious to clean.

When no dynamic content is found in a file after file analysis, the verdict is Low Risk. The file is not sent for file analysis, and the message continues through the email pipeline.

When the appliance processes subsequent instances of the same file, the updated verdict is immediately applied.

Information about the timing of verdict updates is included in the file-criteria document referenced in [Supported Files for File Reputation and Analysis Services](#) , on page 459.

Related Topics

- [File Reputation and File Analysis Reporting and Tracking](#) , on page 478
- [Taking Action When File Threat Verdicts Change](#) , on page 480

File Processing Overview

Evaluation of file reputation and sending of files for analysis occur immediately after anti-virus scanning, regardless of verdicts from previous scanning engines, unless a final action has been taken on the message.



Note By default, if a message has malformed MIME headers, the file reputation service returns a verdict of “unscannable.” The appliance will also attempt to extract the attachments from this message. If the appliance is unable to extract the attachments, verdict will remain as “unscannable.” If the appliance is able to extract the attachments, the file reputation of the attachments is evaluated. If the attachments are malicious, the verdict is changed from “unscannable” to “malicious.”

Communications between the appliance and the file reputation service are encrypted and protected from tampering.

After a file’s reputation is evaluated:

- If a message does not contain any attachments, the file reputation service will return a verdict of “skipped.”
- If the file is known to the file reputation service and is determined to be clean, the message continues through the workqueue.
- If the file reputation service returns a verdict of malicious, for any attachment in the message, then the appliance applies the action that you have specified in the applicable mail policy.
- If the file is known to the reputation service but there is insufficient information for a definitive verdict, the reputation service returns a reputation score based on characteristics of the file such as threat fingerprint and behavioral analysis. If this score meets or exceeds the configured reputation threshold, the appliance applies the action that you have configured in the mail policy for files that contain malware .
- If the reputation service has no information about the file, and the file does not meet the criteria for analysis (see [Supported Files for File Reputation and Analysis Services](#) , on page 459), the file is considered clean and the message continues through the workqueue.
- If you have enabled the File Analysis service, and the reputation service has no information about the file, and the file meets the criteria for files that can be analyzed (see [Supported Files for File Reputation and Analysis Services](#) , on page 459), then the message can be quarantined (see [Quarantining Messages with Attachments Sent for Analysis](#), on page 473) and the file sent for analysis. If you have not configured the appliance to quarantine messages when attachments are sent for analysis, or the file is not sent for analysis, then the message is released to the user.
- For deployments with on-premises file analysis, the reputation evaluation and file analysis occur simultaneously. If the reputation service returns a verdict, that verdict is used, as the reputation service

includes inputs from a wider range of sources. If the file is unknown to the reputation service, the file the file analysis verdict is used.

- If the file reputation verdict information is unavailable because the connection with the server timed out, the file is considered as Unscannable and the actions configured are applied.

Figure 33: Advanced Malware Protection Workflow for Public-Cloud File Analysis Deployments

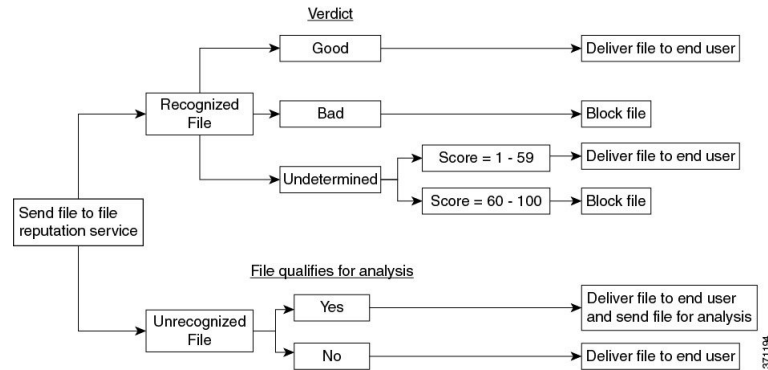

If the file is sent for analysis:

- If the file is sent to the cloud for analysis: Files are sent over HTTPS.
- Analysis normally takes minutes, but may take longer.
- A file that is flagged as malicious after File Analysis may not be identified as malicious by the reputation service. File reputation is determined by a variety of factors over time, not necessarily by a single file analysis verdict.
- Results for files analyzed using an on premises Cisco AMP Threat Grid appliance are cached locally.

For information about verdict updates, see [File Threat Verdict Updates](#) , on page 457.

Supported Files for File Reputation and Analysis Services

The reputation service evaluates most file types. File type identification is determined by file content and is not dependent on the filename extension.

Some files with unknown reputation can be analyzed for threat characteristics. When you configure the file analysis feature, you choose which file types are analyzed. New types can be added dynamically; you will receive an alert when the list of uploadable file types changes, and can select added file types to upload.

Details about what files are supported by the reputation and analysis services are available only to registered Cisco customers. For information about which files are evaluated and analyzed, see *File Criteria for Advanced Malware Protection Services for Cisco Content Security Products*, available from <https://www.cisco.com/c/en/us/support/security/email-security-appliance/products-user-guide-list.html>. The criteria for evaluating a file's reputation and for sending files for analysis may change at any time.

In order to access this document, you must have a Cisco customer account with a support contract. To register, visit <https://tools.cisco.com/RPF/register/register.do>.

You should configure policies to block delivery of files that are not addressed by Advanced Malware Protection.



Note A file (either in incoming mail or outgoing mail) that has already been uploaded for analysis from any source will not be uploaded again. To view analysis results for such a file, search for the SHA-256 from the File Analysis reporting page.

Related Topics

- [Enabling and Configuring File Reputation and Analysis Services](#) , on page 463
- [Ensuring That You Receive Alerts About Advanced Malware Protection Issues](#), on page 477
- [Archive or Compressed File Processing](#), on page 460

Archive or Compressed File Processing

If the file is compressed or archived,

- Reputation of the compressed or archive file is evaluated.

For information about which archived and compressed files are examined, including file formats, see the information linked from [Supported Files for File Reputation and Analysis Services](#) , on page 459.

In this scenario,

- If one of the extracted files is malicious, the file reputation service returns a verdict of Malicious for the compressed or the archive file.
- If the compressed or archive file is malicious and all the extracted files are clean, the file reputation service returns a verdict of Malicious for the compressed or the archive file.
- If the verdict of any of the extracted files is unknown, the extracted files are optionally (if configured and the file type is supported for file analysis) sent for file analysis.
- If the verdict of any of the extracted files or attachments is low risk, the file is not sent for file analysis.
- If the extraction of a file fails while decompressing a compressed or an archive file, the file reputation service returns a verdict of Unscannable for the compressed or the archive file. Keep in mind that, in this scenario, if one of the extracted files is malicious, the file reputation service returns a verdict of Malicious for the compressed or the archive file (Malicious verdict takes precedence over Unscannable verdict).
- An archive or compressed file is treated as unscannable in the following scenarios:
 - The data compression ratio is more than 20.
 - The archive file contains more than five levels of nesting.
 - The archive file contains more than 200 child files.
 - The archive file size is more than 50 MB.
 - The archive file is password protected or unreadable.



Note Reputation of the extracted files with safe MIME types, for example, text/plain, are not evaluated.

Privacy of Information Sent to the Cloud

- Only the SHA that uniquely identifies a file is sent to the reputation service in the cloud. The file itself is not sent.
 - If you are using the file analysis service in the cloud and a file qualifies for analysis, the file itself is sent to the cloud.
 - Information about every file that is sent to the cloud for analysis and has a verdict of "malicious" is added to the reputation database. This information is used along with other data to determine a reputation score.
- Information about files analyzed by an on premises Cisco AMP Threat Grid appliance is not shared with the reputation service.

Configuring File Reputation and Analysis Features

- [Requirements for Communication with File Reputation and Analysis Services](#) , on page 461
- [Configuring an On-premises File Reputation Server](#) , on page 462
- [Configuring an On-Premises File Analysis Server](#) , on page 462
- [Enabling and Configuring File Reputation and Analysis Services](#) , on page 463
- [\(Public Cloud File Analysis Services Only\) Configuring Appliance Groups](#) , on page 469
- [Configuring the Mail Policy for File Reputation Scanning and File Analysis](#) , on page 471
- [Quarantining Messages with Attachments Sent for Analysis](#) , on page 473
- [Using the File Analysis Quarantine](#) , on page 474
- [Centralized File Analysis Quarantine](#) , on page 476
- [X-Headers for File Reputation and Analysis](#) , on page 476
- [Sending Notifications to End Users about Dropped Messages or Attachments](#) , on page 476
- [Advanced Malware Protection and Clusters](#) , on page 476
- [Ensuring That You Receive Alerts About Advanced Malware Protection Issues](#) , on page 477
- [Configuring Centralized Reporting for Advanced Malware Protection Features](#) , on page 477

Requirements for Communication with File Reputation and Analysis Services

- All Email Security appliances that use these services must be able to connect to them directly over the internet (excluding File Analysis services configured to use an on-premises Cisco AMP Threat Grid Appliance.)
- By default, communication with file reputation and analysis services .
- By default, communication with file reputation and cloud-based analysis services is routed through the interface that is associated with the default gateway. To route this traffic through a different interface, create a static route for each address in the Advanced section of the Security Services > File Reputation and Analysis page.
- The following firewall ports must be open:

Firewall Ports	Description	Protocol	In/Out	Hostname	Appliance Interface
32137 (default) or 443	Access to cloud services for obtaining file reputation.	TCP	Out	As configured in Security Services > Anti-Malware and Reputation, Advanced section, Cloud Server Pool parameter.	Management, unless a static route is configured to route this traffic through a data port.
443	Access to cloud services for file analysis.	TCP	Out	As configured in Security Services > Anti-Malware and Reputation, Advanced section.	

Configuring an On-premises File Reputation Server

If you will use a Cisco AMP Virtual Private Cloud appliance as a private-cloud file analysis server:

- You can obtain the Cisco Advanced Malware Protection Virtual Private Cloud Appliance documentation, including the Installation and Configuration of FireAMP Private Cloud guide, from <http://www.cisco.com/c/en/us/support/security/fireamp-private-cloud-virtual-appliance/tsd-products-support-series-home.html>

Use that documentation to perform the tasks described in this topic.

Additional documentation is available using the Help link in the AMP Virtual Private Cloud appliance.

- Set up and configure the Cisco AMP Virtual Private Cloud appliance in either “proxy” or “air-gap” (on-premises) mode.
- Ensure the Cisco AMP Virtual Private Cloud appliance software version is 2.2, which enables integration with Cisco Email Security appliance.
- Download the AMP Virtual Private Cloud certificate and keys on that appliance for upload to this Email Security appliance
- Use the **Root Certificate** option to skip standard validation when the root authority, trusted by the Email Security Appliance, does not sign the tunnel proxy server certificate.



Note After you have set up the on-premises file-reputation server, you will configure connection to it from this Email Security appliance; see Step 6 of [Enabling and Configuring File Reputation and Analysis Services](#), on page 463

Configuring an On-Premises File Analysis Server

If you will use a Cisco AMP Threat Grid Appliance as a private-cloud file analysis server:

- Obtain the Cisco AMP Threat Grid Appliance Setup and Configuration Guide and the Cisco AMP Threat Grid Appliance Administration Guide. Cisco AMP Threat Grid Appliance documentation is available from <http://www.cisco.com/c/en/us/support/security/amp-threat-grid-appliances/products-installation-guides%20-list.html>.

Use this documentation to perform the tasks described in this topic.

Additional documentation is available from the Help link in the AMP Threat Grid appliance.

In the Administration Guide, search for information about all of the following: integrations with other Cisco appliances, CSA, Cisco Sandbox API, ESA, and Email Security Appliances, .

- Set up and configure the Cisco AMP Threat Grid Appliance.
- If necessary, update your Cisco AMP Threat Grid Appliance software to version 1.2.1, which supports integration with Cisco Email Security appliances.

See the AMP Threat Grid documentation for instructions for determining the version number and for performing the update.

- Ensure that your appliances can communicate with each other over your network. Cisco Email Security appliances must be able to connect to the CLEAN interface of the AMP Threat Grid appliance.
- If you will deploy a self-signed certificate: Generate a self-signed SSL certificate from the Cisco AMP Threat Grid appliance to be used on your Email Security appliance . See instructions for downloading SSL certificates and keys in the administrator's guide for your AMP Threat Grid appliance. Be sure to generate a certificate that has the hostname of your AMP Threat Grid appliance as CN. The default certificate from the AMP Threat Grid appliance does NOT work.
- Registration of your Email Security appliance with your Threat Grid appliance occurs automatically when you submit the configuration for File Analysis, as described in [Enabling and Configuring File Reputation and Analysis Services](#) , on page 463. However, you must activate the registration as described in the same procedure.

Enabling and Configuring File Reputation and Analysis Services

Before you begin

- Acquire feature keys for the file reputation service and the file analysis service and transfer them to this appliance.
- Meet the [Requirements for Communication with File Reputation and Analysis Services](#) , on page 461.
- Verify connectivity to the update servers configured on the Updates page .
- If you will use a Cisco AMP Virtual Private Cloud Appliance as a private cloud file reputation server, see [Configuring an On-premises File Reputation Server](#), on page 462.
- If you will use a Cisco AMP Threat Grid Appliance as a private cloud file analysis server, see [Configuring an On-Premises File Analysis Server](#) , on page 462.

Procedure

Step 1 Select **Security Services > File Reputation and Analysis**.

Step 2 Click **Edit Global Settings**.

Step 3 Click **Enable File Reputation Filtering** and optionally **Enable File Analysis**.

- If **Enable File Reputation Filtering** is checked, you must configure the section **File Reputation Server** (in **Step 6**), by either choosing the URL of an external public-reputation cloud server, or by providing the Private reputation cloud server connection information.
- Similarly, if **Enable File Analysis** is checked, you must configure the section **File Analysis Server URL** (in **Step 7**), providing either the URL of an external cloud server, or the Private analysis cloud connection information.

Note New file types may be added after an upgrade and are not enabled by default. If you have enabled file analysis, and require the new file types to be included in analysis, you must enable them.

Step 4 Accept the license agreement if presented.

Step 5 In the **File Analysis** section, select the required file types from the appropriate file groups (for example, “Microsoft Documents”) to send for file analysis.

For information about supported file types, see the document described in [Supported Files for File Reputation and Analysis Services](#) , on page 459

Note Cisco periodically checks for potentially malicious file types to prevent zero day threats. If new threats are identified, details of such file types are sent to your appliance through updater servers. Select the **Other potentially malicious file types** option to enable this functionality. If you enable this functionality, your appliance will send such file types for analysis in addition to the file types you have selected.

Step 6 Expand the **Advanced Settings for File Reputation** panel and adjust the following options as needed:

Option	Description
Cloud Domain	The name of the domain to be used for file reputation queries.
File Reputation Server	<p>Choose either: the host name of the public reputation cloud server, or Private reputation cloud.</p> <p>If you choose Private reputation cloud, provide the following:</p> <ul style="list-style-type: none"> • Server – The host name or IP address of the Cisco AMP Virtual Private Cloud appliance. • Public Key – Provide a valid public key for encrypted communications between this appliance and your private cloud appliance. This must be the same key used by the private cloud server: locate the key file on this appliance, and then click Upload File. <p>Note You must have already downloaded the key file from the server to this appliance.</p>
AMP for Endpoints Console Integration	Click Register the Appliance with AMP for Endpoints to integrate your appliance with AMP for Endpoints console. For detailed instructions, see Integrating the Appliance with AMP for Endpoints Console , on page 467.

Option	Description
SSL Communication for File Reputation	<p>Check Use SSL (Port 443) to communicate on port 443 instead of the default port, 32137. Refer to the Cisco AMP Virtual Private Cloud Appliance user guide for information about enabling SSH access to the server.</p> <p>Note SSL communication over port 32137 may require you to open that port in your firewall.</p> <p>This option also allows you to configure an upstream proxy for communication with the file reputation service. If checked, provide the appropriate Server, Username and Password information.</p> <p>When Use SSL (Port 443) is selected, you can also check Relax Certificate Validation to skip standard certificate validation if the tunnel proxy server's certificate is not signed by a trusted root authority. For instance, select this option if using a self-signed certificate on a trusted internal tunnel proxy server.</p> <p>Note If you checked Use SSL (Port 443) in the SSL Communication for File Reputation section of the Advanced Settings for File Reputation, you must add the AMP on-premises reputation server CA certificate to the certificate store on this appliance, using either the CLI command <code>certconfig > CERTAUTHORITY > CUSTOM</code>, or Network > Certificates (Custom Certificate Authorities) in the Web interface. Obtain this certificate from the server (Configuration > SSL > Cloud server > download).</p>
Heartbeat Interval	The frequency, in minutes, with which to ping for retrospective events.
Query Timeout	The number of elapsed seconds before the reputation query times out.
Processing Timeout	The number of elapsed seconds before the file processing times out.
File Reputation Client ID	The client ID for this appliance on the File Reputation server (read-only).
File Retrospective	Check Suppress the retrospective verdict alerts to suppress the retrospective verdict alerts for messages that are not delivered to the message recipient, dropped or quarantined.

Note Do not change any other settings in this section without guidance from Cisco support.

Step 7

If you will use the cloud service for file analysis, expand the Advanced Settings for File Analysis panel and adjust the following options as needed:

Option	Description
File Analysis Server URL	<p>Choose either: the name (URL) of an external cloud server, or Private analysis cloud.</p> <p>If specifying an external cloud server, choose the server that is physically nearest to your appliance. Newly available servers will be added to this list periodically using standard update processes.</p> <p>Choose Private analysis cloud to use an on-premises Cisco AMP Threat Grid appliance for file analysis, and provide the following:</p> <ul style="list-style-type: none"> • TG Servers – Enter the IPv4 address or hostname of the standalone or clustered Cisco AMP Threat Grid appliances. You can add a maximum of seven Cisco AMP Threat Grid appliances. <p>Note The Serial Number indicates the order in which you add the standalone or clustered Cisco AMP Threat Grid appliances. It does not denote the priority of the appliances.</p> <p>Note You cannot add standalone and cluster servers in one instance. It must be either standalone or cluster.</p> <p>You can add only one standalone server in an instance. If it is a cluster mode, you can add multiple servers upto seven and all the servers must belong to the same cluster. You cannot add multiple clusters.</p> <ul style="list-style-type: none"> • Certificate Authority – Choose either Use Cisco Default Certificate Authority, or Use Uploaded Certificate Authority. <p>If you choose Use Uploaded Certificate Authority, click Browse to upload a valid certificate file for encrypted communications between this appliance and your private cloud appliance. This must be the same certificate used by the private cloud server.</p> <p>Note If you have configured the Cisco AMP Threat Grid portal on your appliance for file analysis, you can access the Cisco AMP Threat Grid portal (for example, https://panacea.threatgrid.eu) to view and track the files submitted for file analysis. For more information on how to access the Cisco AMP Threat Grid portal, contact Cisco TAC.</p>
File Analysis Client ID	The client ID for this appliance on the File Analysis server (read-only).

Step 8 (Optional) Expand the Cache Settings panel, if you want to configure the cache expiry period for File Reputation disposition values.

Step 9 Expand the Threshold Settings panel, if you want to set the upper limit for the acceptable file analysis score. The score above this threshold indicates that the file is infected. Choose any one of the following options:

- Use value from Cloud Service (95)
- Enter Custom Value – defaults to 95

Step 10 Submit and commit your changes.

Step 11

If you are using an on-premises Cisco AMP Threat Grid appliance, activate the account for this appliance on the AMP Threat Grid appliance.

Complete instructions for activating the “user” account are available in the AMP Threat Grid documentation.

- a) Note the File Analysis Client ID that appears at the bottom of the page section. This identifies the “user” that you will activate.
- b) Sign in to the AMP Threat Grid appliance.
- c) Select **Welcome... > Manage Users** and navigate to User Details.
- d) Locate the “user” account based on the File Analysis Client ID of your Email Security appliances.
- e) Activate this “user” account for your appliance.

Integrating the Appliance with AMP for Endpoints Console

You can integrate your appliance with AMP for Endpoints console, and perform the following actions in AMP for Endpoints console:

- Create a simple custom detection list.
- Add new malicious file SHAs to the simple custom detection list.
- Create an application allowed list.
- Add new file SHAs to the application allowed list.
- Create a custom policy.
- Attach the simple custom detection list and the application allowed list to the custom policy.
- Create a custom group.
- Attach the custom policy to the custom group.
- Move your registered appliance from the default group to the custom group.
- View the file trajectory details of a particular file SHA.

To integrate your appliance with AMP for Endpoints console, you need to register your appliance with the console.

After the integration, when a file SHA is sent to the File Reputation server, the verdict obtained for the file SHA from the File Reputation Server is overridden by the verdict already available for the same file SHA in the AMP for Endpoints console.

If a file SHA is already marked as malicious globally, and if the same file SHA is added to the blocked list in AMP for Endpoints console, the file disposition is malicious.

The Advanced Malware Protection report page includes a new section - **Incoming Malware Files by Category** to view the percentage of block listed file SHAs received from the AMP for Endpoints console that are displayed as **Custom Detection**. The threat name of a block listed file SHA is displayed as **Simple Custom Detection** in the Incoming Malware Threat Files section of the report. You can click the link in the More Details section of the report to view the file trajectory details of a block listed file SHA in the AMP for Endpoints console.

Before you begin

Make sure you have a user account in AMP for Endpoints console with admin access rights. For more details on how to create an AMP for Endpoints console user account, contact Cisco TAC.

[For clustered configuration] In a clustered configuration, you can only register your logged-in appliance with AMP for Endpoints console. If you have already registered your appliance with AMP for Endpoints console in the standalone mode, make sure to deregister the appliance manually before you join it to a cluster.

Make sure you have enabled and configured File Reputation Filtering. See [Enabling and Configuring File Reputation and Analysis Services](#), on page 463 to know how to enable and configure File Reputation Filtering.

Procedure

- Step 1** Select **Security Services > File Reputation and Analysis**.
- Step 2** Click **Edit Global Settings**.
- Step 3** Click **Register Appliance with AMP for Endpoints** in the Advanced Settings panel for File Reputation in the File Reputation and File Analysis page of the web interface.
- Once you click Register Appliance with AMP for Endpoints, the AMP for Endpoints console login page appears.
- Step 4** Log in to the AMP for Endpoints console with your user credentials.
- Step 5** Click **Allow** in the AMP for Endpoints authorization page to register your appliance.
- Once you click Allow, the registration is complete, and it redirects you to the File Reputation and Analysis page of your appliance. Your appliance name is displayed in the AMP for Endpoints Console Integration field. You can use the appliance name to customize your appliance settings in the AMP for Endpoints console page.
-

What to do next

Next Steps:

- You can go to Accounts > Applications section of the AMP for Endpoints console page, to verify whether your appliance is registered with AMP for Endpoints console. Your appliance name is displayed in the Applications section of the AMP for Endpoints console page.
- After registration, your appliance is added to the default group (Audit Group) which has a default policy (Network Policy) attached to it. The default policy contains file SHAs that are added to the blocked list or the allowed list. If you want to customize the AMP for Endpoints settings for your appliance, and add your own file SHAs that are added to the blocked list or the allowed list, see the AMP for Endpoints user documentation at <https://console.amp.cisco.com/docs>.
- Make sure that the 'File Reputation Client ID' value in the File Reputation Settings page and the 'Device GUID' value of your registered appliance in the AMP for Endpoints console portal is the same. If the values are different, the integration of your appliance with AMP for Endpoints will not work properly at the machine or cluster level. You will need to deregister and register your appliance again to use the AMP for Endpoints functionality.
- To deregister your appliance connection from AMP for Endpoints console, you can click **Deregister** in the Advanced Settings for File Reputation section in your appliance, or you need to go to the AMP for

Endpoints console page at <https://console.amp.cisco.com/>. For more information, see the AMP for Endpoints user documentation at <https://console.amp.cisco.com/docs>.



Note When you change your File Reputation server to a different data center, your appliance is automatically deregistered from the AMP for Endpoints console. You must re-register your appliance with AMP for Endpoints console with the same data center selected for the File Reputation server.



Note If you change your file reputation server at the cluster level, your logged-in appliance is automatically deregistered from the AMP for Endpoints console. Ensure that you deregister all the other machines in the cluster. You must re-register all your appliances with AMP for Endpoints console with the same data center selected for the File Reputation server.



Note If a malicious file SHA gets a clean verdict, then verify whether the same file SHA is added to the allowed list in AMP for Endpoints console.

Important! Changes Needed in File Analysis Setting

If you plan to use a new public cloud File Analysis service, make sure you read the following instructions to maintain datacenter isolation:

- The existing appliance grouping information is not preserved in the new File Analysis server. You must regroup your appliances on the new File Analysis server.
- Messages that are quarantined to the File Analysis Quarantine are retained until the retention period. After the quarantine retention period, the messages are released from the File Analysis Quarantine, and re-scanned by the AMP engine. The file is then uploaded to the new File Analysis server for analysis but the message is not sent to the File Analysis Quarantine again.

For more details, refer to the Cisco AMP Thread Grid documentation from <http://www.cisco.com/c/en/us/support/security/amp-threat-grid-appliances/products-installation-guides-list.html>.

(Public Cloud File Analysis Services Only) Configuring Appliance Groups

In order to allow all content security appliances in your organization to view file analysis result details in the cloud for files sent for analysis from any appliance in your organization, you need to join all appliances to the same appliance group.



Note You can configure appliance groups at the machine level. The appliance groups cannot be configured at the cluster level.

Procedure

- Step 1** Select **Security Services > File Reputation and Analysis**.
- Step 2** In the Appliance Grouping for File Analysis Cloud Reporting section, enter the File Analysis Group ID.
- If this is the first appliance being added to the group, provide a useful identifier for the group.
 - This ID is case-sensitive, and cannot contain spaces.
 - The ID you provide must be identical on all appliances that will share data about files that are uploaded for analysis. However, the ID is not validated on subsequent group appliances.
 - If you enter the Group ID incorrectly or need to change it for any other reason, you must open a case with Cisco TAC.
 - This change takes effect immediately; it does not require a Commit.
 - All appliances in the group must be configured to use the same File Analysis server in the cloud.
 - An appliance can belong to only one group.
 - You can add a machine to a group at any time, but you can do it only once.
- Step 3** Click **Group Now**.
-

Which Appliances Are In the Analysis Group?

Procedure

- Step 1** Select **Security Services > File Reputation and Analysis**.
- Step 2** In the Appliance Grouping for File Analysis Cloud Reporting section, click **View Appliances**.
- Step 3** To view the **File Analysis Client ID** of a particular appliance, look in the following location:

Appliance	Location of File Analysis Client ID
Email Security appliance	Advanced Settings for File Analysis section on the Security Services > File Reputation and Analysis page.
Web Security appliance	Advanced Settings for File Analysis section on the Security Services > Anti-Malware and Reputation page.
Security Management appliance	At the bottom of the Management Appliance > Centralized Services > Security Appliances page.

Configuring the Mail Policy for File Reputation Scanning and File Analysis

Procedure

- Step 1** Select **Mail Policies > Incoming Mail Policies** or **Mail Policies > Outgoing Mail Policies**, whichever is applicable.
- Step 2** Click the link in the **Advanced Malware Protection** column of the mail policy to modify.
- Step 3** Choose options.
- If you do not have an on-premises Cisco AMP Threat Grid Appliance and you do not want to send files to the cloud, for example for confidentiality reasons, uncheck **Enable File Analysis**.
 - Select the actions that the appliance must perform if an attachment is considered as Unscannable. Attachments are considered Unscannable when the appliance is unable to scan the file for the following reasons:
 - **Message Errors:**
 - Password-protected archived or compressed file
 - Messages with RFC violation.
 - Messages that contain more than 200 child files
 - Messages that contain more than five nested levels of child files
 - Messages with extraction failure
 - **Rate Limit** - The files that are not scanned by the File Analysis server because the appliance has reached the file upload limit.
 - **AMP Service not available:**
 - File Reputation service is not available
 - File Analysis service is not available
 - File reputation query timeout
 - File upload query timeout
 - You can configure any one of the following message handling actions on messages that are not scanned by the AMP engine:
 - Drop the message
 - Deliver the message as it is
 - Send the message to the policy quarantine
 - Select the following additional actions, if you choose to deliver the message:
 - Whether to archive the original message. Archived messages are stored as an mbox-format log file in the amparchive directory on the appliance. The preconfigured AMP Archive (amparchive) log subscription is required.

- Whether to warn the end user by modifying the message subject, for example, [WARNING: ATTACHMENT(S) MAY CONTAIN MALWARE].
 - Whether to add a custom header to provide granular controls to the administrator.
 - Whether to modify the message recipient causing the message to be delivered to a different address. Click **Yes** and enter the new recipient address.
 - Whether to send the unscannable messages to an alternate destination host. Click **Yes** and enter an alternate IP address or hostname.
- Select the following additional actions, if you choose to send the message to the policy quarantine:
 - Whether to select a policy quarantine from the drop-down. When flagged for quarantine, the message is placed in the quarantine when it reaches the end of the email pipeline, and is scanned by all the other engines in the email pipeline.
 - Whether to archive the original message. Archived messages are stored as an mbox-format log file in the amparchive directory on the appliance. The preconfigured AMP Archive (amparchive) log subscription is required.
 - Whether to warn the end user by modifying the message subject, for example, [WARNING: ATTACHMENT(S) MAY CONTAIN MALWARE].
 - Whether to add a custom header to provide granular controls to the administrator.
- Select the actions that AsyncOS must perform if an attachment is considered Malicious. Select the following:
 - Whether to deliver or drop the message.
 - Whether to archive the original message. Archived messages are stored as an mbox-format log file in the amparchive directory on the appliance. The preconfigured AMP Archive (amparchive) log subscription is required.
 - Whether to deliver the message after removing the malware attachments.
 - Whether to warn the end user by modifying the message subject, for example, [WARNING: MALWARE DETECTED IN ATTACHMENT(S)].
 - Whether to add a custom header to provide granular controls to the administrator.
 - Whether to modify the message recipient causing the message to be delivered to a different address. Click **Yes** and enter the new recipient address.
 - Whether to send the malicious messages to an alternate destination host. Click **Yes** and enter an alternate IP address or hostname.
- Select the actions that AsyncOS must perform if an attachment is sent for File Analysis. Select the following:
 - Whether to deliver or quarantine the message.
 - Whether to archive the original message. Archived messages are stored as an mbox-format log file in the amparchive directory on the appliance. The preconfigured AMP Archive (amparchive) log subscription is required.

- Whether to warn the end user by modifying the message subject, for example, “[WARNING: ATTACHMENT(S) MAY CONTAIN MALWARE].”
 - Whether to add a custom header to provide granular controls to the administrator.
 - Whether to modify the message recipient causing the message to be delivered to a different address. Click **Yes** and enter the new recipient address.
 - Whether to send the messages that are sent for file analysis to an alternate destination host. Click **Yes** and enter an alternate IP address or hostname.
- (For Incoming Mail Policy only) Configure the remedial actions to be performed on messages delivered to end users when the threat verdict changes to malicious. Select Enable Mailbox Auto Remediation and select one of the following actions:
- Forward to an email address. Select this option to forward the message with malicious attachment to a specified user, for example, an email administrator.
 - Delete the message. Select this option to permanently delete the message with malicious attachment from the end user’s mailbox.
 - Forward to an email address and delete the message. Select this option to forward the message with malicious attachment to a specified user, for example, an email administrator and permanently delete that message from the end user’s mailbox.
- Note** Messages from certain folders (for example, Deleted Items) cannot be deleted as Office 365 services do not support deletion of messages from these folders.
- Important** Before configuring the Mailbox Auto Remediation settings, review [Remediating Messages in Mailboxes, on page 553](#)

Step 4 Submit and commit your changes.

Quarantining Messages with Attachments Sent for Analysis

You can configure the appliance to quarantine files sent for analysis instead of releasing them immediately to the workqueue. Quarantined messages and their attachments are rescanned for threats upon release from quarantine. If the message is released after file analysis results are available to the reputation scanner, any identified threats will be caught during rescanning.

Procedure

- Step 1** Select **Mail Policies > Incoming Mail Policies** or **Mail Policies > Outgoing Mail Policies**, whichever is applicable.
- Step 2** Click the link in the **Advanced Malware Protection** column of the mail policy to modify.
- Step 3** Under Messages with File Analysis Pending section, select **Quarantine** from the Action Applied to Message drop-down.

The quarantined messages are stored in the File Analysis quarantine. See [Using the File Analysis Quarantine, on page 474](#).

Step 4 (Optional) Under Messages with File Analysis Pending section, choose the following options:

- Whether to archive the original message. Archived messages are stored as an mbox-format log file in the amparchive directory on the appliance. The preconfigured AMP Archive (amparchive) log subscription is required.
- Whether to warn the end user by modifying the message subject, for example, “ [WARNING: ATTACHMENT(S) MAY CONTAIN MALWARE] .”
- Whether to add a custom header to provide granular controls to the administrator.

Note The above actions mentioned in step4 are applicable only when a message is released from the quarantine and not when the message is sent to the quarantine:

- Archiving the original message.
- Modifying a message subject.
- Adding a custom header.

Step 5 Submit and commit your changes.

What to do next

Related Topics

[Using the File Analysis Quarantine, on page 474](#)

Using the File Analysis Quarantine

- [Edit File Analysis Quarantine Settings, on page 474](#)
- [Manually Processing Messages in the File Analysis Quarantine, on page 475](#)

Edit File Analysis Quarantine Settings

Procedure

Step 1 Select **Monitor > Policy, Virus, and Outbreak Quarantines**.

Step 2 Click the **File Analysis** quarantine link.

Step 3 Specify the retention period.

Changing the default from one hour is not recommended.

Step 4 Specify the default action that AsyncOS must take after the retention period has passed.

Step 5 If you do *not* want messages in this quarantine to be processed before the end of the Retention Period you specify, even when quarantine disk space is full, deselect **Free up space by applying default action on messages upon space overflow**.

- Step 6** If you select **Release** as the Default Action, optionally specify additional actions to apply to messages that are released before their retention period has passed:

Option	Information
Modify Subject	Type the text to add and specify whether to add it to the beginning or the end of the original message subject. For example, you might want to warn the recipient that the message may contain malware attachments. Note In order for a subject with non-ASCII characters to display correctly it must be represented according to RFC 2047.
Add X-Header	An X-Header can provide a record of actions taken on a message. This can be helpful for example when handling inquiries about why a particular message was delivered. Enter a name and value. Example: Name = Inappropriate-release-early Value = True
Strip Attachments	Stripping attachments protects against malware attachments in messages.

- Step 7** Specify the users who can access this quarantine:

User	Information
Local Users	The list of local users includes only users with roles that can access quarantines. The list excludes users with Administrator privileges, because all Administrators have full access to quarantines.
Externally Authenticated Users	You must have configured external authentication.
Custom User Roles	You see this option only if you have created at least one custom user role with quarantine access.

- Step 8** Submit and commit your changes.

Manually Processing Messages in the File Analysis Quarantine

Procedure

- Step 1** Select **Monitor > Policy, Virus, and Outbreak Quarantines**.
- Step 2** In the row for File Analysis quarantine, click the blue number in the Messages column of the table.
- Step 3** Depending on your requirements, perform the following actions on messages:

- Delete
- Release
- Delay Scheduled Exit from quarantine
- Send a copy of messages to email addresses that you specify

Centralized File Analysis Quarantine

For information about the centralized File Analysis quarantine, see chapter "Centralized Policy, Virus and Outbreak Quarantine" of the *Cisco Email Security Appliance Guide*.

X-Headers for File Reputation and Analysis

You can use X-Headers to mark messages with actions and results of message processing steps. You tag messages with X-Headers in mail policies, then use content filters to choose handling options and final actions for these messages.

Values are case-sensitive.

Header Name	Possible Values (Case Sensitive)	Description
X-Amp-Result	Clean Malicious Unscannable	Verdict applied to messages processed by the file reputation service.
X-Amp-Original-Verdict	file unknown verdict unknown	Verdict before adjustment based on reputation threshold. This header exists only if the original verdict is one of the possible values.
X-Amp-File-Uploaded	true false	If any file attached to a message was sent for analysis, this header is "true."

Sending Notifications to End Users about Dropped Messages or Attachments

To send notifications to end users when a suspect attachment or its parent message has been dropped based on file reputation scanning, use an X-header or Custom Header and Content Filters.

Advanced Malware Protection and Clusters

If you use centralized management, you can enable Advanced Malware Protection and mail policies at the cluster, group and machine level.

Feature keys must be added at the machine level.

Appliance Groups should not be configured at cluster level.

Ensuring That You Receive Alerts About Advanced Malware Protection Issues

Ensure that the appliance is configured to send you alerts related to Advanced Malware Protection.

You will receive alerts when:

Alert Description	Type	Severity
You are setting up a connection to an on-premises (private cloud) Cisco AMP Threat Grid appliance and you need to activate the account as described in Enabling and Configuring File Reputation and Analysis Services , on page 463	Anti-Malware	Warning
Feature keys expire	(As is standard for all features)	
The file reputation or file analysis service is unreachable.	Anti-Virus and AMP	Warning
Communication with cloud services is established.	Anti-Virus and AMP	Info
The reputation and analysis engine is restarted by a watchdog service	Anti-Virus and AMP	Info
A file reputation verdict changes.	Anti-Virus and AMP	Info
File types that can be sent for analysis have changed. You may want to enable upload of new file types.	Anti-Virus and AMP	Info
Analysis of some file types is temporarily unavailable.	Anti-Virus and AMP	Warning
Analysis of all supported file types is restored after a temporary outage.	Anti-Virus and AMP	Info
Invalid File Analysis service key. You need to contact Cisco TAC with the file analysis id details to fix this error.	AMP	Error

Related Topics

- [Several Alerts About Failure to Connect to File Reputation or File Analysis Servers](#) , on page 481
- [Taking Action When File Threat Verdicts Change](#) , on page 480

Configuring Centralized Reporting for Advanced Malware Protection Features

If you will centralize reporting on a Security Management appliance, see important configuration requirements in the Advanced Malware Protection sections in the email reporting chapter of the online help or user guide for your management appliance.

File Reputation and File Analysis Reporting and Tracking

- [Identifying Files by SHA-256 Hash](#) , on page 478
- [#unique_845](#)
- [Viewing File Reputation Filtering Data in Other Reports](#) , on page 479
- [About Message Tracking and Advanced Malware Protection Features](#) , on page 479

Identifying Files by SHA-256 Hash

Because filenames can easily be changed, the appliance generates an identifier for each file using a Secure Hash Algorithm (SHA-256). If an appliance processes the same file with different names, all instances are recognized as the same SHA-256. If multiple appliances process the same file, all instances of the file have the same SHA-256 identifier.

In most reports, files are listed by their SHA-256 value (in an abbreviated format

File Reputation and File Analysis Report Pages

Report	Description
Advanced Malware Protection	<p>Shows file-based threats that were identified by the file reputation service.</p> <p>For files with changed verdicts, see the AMP Verdict updates report. Those verdicts are not reflected in the Advanced Malware Protection report.</p> <p>If a file extracted from a compressed or archived file is malicious, only the SHA value of the compressed or archived file is included in the Advanced Malware Protection report.</p> <p>The Incoming Malware Files by Category section shows the percentage of file SHAs on the blocked list received from the AMP for Endpoints console that are categorised as Custom Detection.</p> <p>The threat name of file SHA on the blocked list obtained from AMP for Endpoints console is displayed as Simple Custom Detection in the Incoming Malware Threat Files section of the report.</p> <p>You can click the link in the More Details section of the report to view the file trajectory details about file SHA on the blocked list in the AMP for Endpoints console.</p> <p>You can view the Low Risk verdict details in the Incoming Files Handed by AMP section of the report.</p>

Report	Description
Advanced Malware Protection File Analysis	<p>Displays the time and verdict (or interim verdict) for each file sent for analysis. The appliance checks for analysis results every 30 minutes.</p> <p>To view more than 1000 File Analysis results, export the data as a .csv file.</p> <p>Drill down to view detailed analysis results, including the threat characteristics for each file.</p> <p>You can also search for additional information about an SHA, or click the link at the bottom of the file analysis details page to view additional details on the server that analyzed the file.</p> <p>Note If extracted files from a compressed or an archive file are sent for file analysis, only SHA values of these extracted files are included in the File Analysis report.</p>
Advanced Malware Protection Reputation	<p>Because Advanced Malware Protection is focused on targeted and zero-day threats, threat verdicts can change as aggregated data provides more information.</p> <p>The AMP Reputation report lists the files processed by this appliance for which the verdict has changed since the message was received. For more information about this situation, see File Threat Verdict Updates , on page 457.</p> <p>To view more than 1000 verdict updates, export the data as a .csv file.</p> <p>In the case of multiple verdict changes for a single SHA-256, this report shows only the latest verdict, not the verdict history.</p> <p>To view all affected messages for a particular SHA-256 within the maximum available time range (regardless of the time range selected for the report) click a SHA-256 link.</p>

Viewing File Reputation Filtering Data in Other Reports

Data for file reputation and analysis is available in other reports where relevant. A "Detected by Advanced Malware Protection" column may be hidden by default in applicable reports. To display additional columns, click the Columns link below the table.

About Message Tracking and Advanced Malware Protection Features

When searching for file threat information in Message Tracking, keep the following points in mind:

- To search for malicious files found by the file reputation service, select **Advanced Malware Protection Positive** for the Message Event option in the Advanced section in Web Message Tracking.
- Message Tracking includes only information about file reputation processing and the original file reputation verdicts returned at the time a transaction message was processed. For example, if a file was initially

found to be clean, then a verdict update found the file to be malicious, only the clean verdict appears in Tracking results.

In Message Tracking details, the Processing Details section shows:

- The SHA-256 of each attachment in the message, and
 - The final Advanced Malware Protection verdict for the message as a whole, and
 - Any attachments which were found to contain malware.
- Verdict updates are available only in the AMP Verdict Updates report. The original message details in Message Tracking are not updated with verdict changes. To see transactions messages that have a particular attachment, click a SHA-256 in the verdict updates report.
 - Information about File Analysis, including analysis results and whether or not a file was sent for analysis, are available only in the File Analysis report.

Additional information about an analyzed file may be available from the cloud or on-premises File Analysis server. To view any available File Analysis information for a file, select **Reporting Monitor > File Analysis** and enter the SHA-256 to search for the file . If the File Analysis service has analyzed the file from any source, you can see the details. Results are displayed only for files that have been analyzed.

If the appliance processed a subsequent instance of a file that was sent for analysis, those instances will appear in Message Tracking search results.

Taking Action When File Threat Verdicts Change

Procedure

- Step 1** View the AMP Verdict Updates report.
 - Step 2** Click the relevant SHA-256 link to view message tracking data for all messages that contained that file that may have been delivered to end users.
 - Step 3** Using the tracking data, identify the users that may have been compromised, as well as information such as the file names involved in the breach and sender of the file.
 - Step 4** Check the File Analysis report to see if this SHA-256 was sent for analysis, to understand the threat behavior of the file in more detail.
-

What to do next

Related Topics

[File Threat Verdict Updates](#) , on page 457

Troubleshooting File Reputation and Analysis

- [Log Files](#) , on page 481

- [Using Trace](#) , on page 481
- [Several Alerts About Failure to Connect to File Reputation or File Analysis Servers](#) , on page 481
- [API Key Error \(On-Premises File Analysis\)](#) , on page 482
- [Files are Not Uploaded As Expected](#) , on page 482
- [Alerts about File Types That Can Be Sent for Analysis](#) , on page 482

Log Files

In logs:

- `AMP` and `amp` refer to the file reputation service or engine.
- `Retrospective` refers to verdict updates.
- `VRT` and `sandboxing` refer to the file analysis service.

Information about Advanced Malware Protection including File Analysis is logged in AMP Engine Logs.

File reputation filtering and analysis events are logged in AMP Engine logs and Mail logs.

In the log message “Response received for file reputation query” possible values for “upload action” are:

- 1: SEND. In this case, you must send the file for File Analysis.
- 2: DON'T SEND. In this case, you do not send the file for File Analysis.
- 3: SEND ONLY METADATA. In this case, you send only the metadata and not the entire file for File Analysis.
- 0: NO ACTION. In this case, no other action is required.

For “Disposition” in mail logs:

- 1: No malware detected or presumed clean (treated as clean)
- 2: Clean
- 3: Malware

Spyname is threat name.

Using Trace

Trace is not available for the file reputation filtering and analysis features. Instead, send a test message from an account outside your organization.

Several Alerts About Failure to Connect to File Reputation or File Analysis Servers

Problem

You receive several alerts about failures to connect to the file reputation or analysis services in the cloud. (A single alert may indicate only a transient issue.)

Solution

- Ensure that you have met the requirements in [Requirements for Communication with File Reputation and Analysis Services](#) , on page 461.

- Check for network issues that may prevent the appliance from communicating with the cloud services.
- Increase the Query Timeout value:

Select **Security Services > File Reputation and Analysis**. The Query Timeout value is in the Advanced settings area .

API Key Error (On-Premises File Analysis)

Problem

You receive an API key alert when attempting to view File Analysis report details, or the Email Security appliance is unable to connect to the AMP Threat Grid server to upload files for analysis.

Solution

This error can occur if you change the hostname of the AMP Threat Grid server and you are using a self-signed certificate from the AMP Threat Grid server, as well as possibly under other circumstances. To resolve the issue:

- Generate a new certificate from the AMP Threat Grid appliance that has the new hostname.
- Upload the new certificate to the Email Security appliance.
- Reset the API key on the AMP Threat Grid appliance. For instructions, see the online help on the AMP Threat Grid appliance.

Related Topics

- [Enabling and Configuring File Reputation and Analysis Services](#) , on page 463

Files are Not Uploaded As Expected

Problem

Files are not evaluated or analyzed as expected. There is no alert or obvious error.

Solution

Consider the following:

- The file may have been sent for analysis by another appliance and thus already be present on the File Analysis server or in the cache of the appliance that is processing the file.

Alerts about File Types That Can Be Sent for Analysis

Problem

You receive alerts of severity Info about file types that can be sent for file analysis.

Solution

This alert is sent when supported file types change, or when the appliance checks to see what file types are supported. This can occur when:

- You or another administrator changes the file types selected for analysis.

- Supported file types change temporarily based on availability in the cloud service. In this case, support for the file types selected on the appliance will be restored as soon as possible. Both processes are dynamic and do not require any action from you.
- The appliance restarts, for example as part of an AsyncOS upgrade.



CHAPTER 21

Data Loss Prevention

This chapter contains the following sections:

- [Overview of Data Loss Prevention](#) , on page 485
- [System Requirements for Data Loss Prevention](#) , on page 486
- [How to Set Up Data Loss Prevention](#) , on page 487
- [Enabling Data Loss Prevention \(DLP\)](#) , on page 488
- [Policies for Data Loss Prevention](#), on page 488
- [Message Actions](#), on page 506
- [Displaying Sensitive DLP Data in Message Tracking](#) , on page 511
- [About Updating the DLP Engine and Content Matching Classifiers](#), on page 512
- [Working with DLP Incident Messages and Data](#) , on page 513
- [Troubleshooting Data Loss Prevention](#), on page 514

Overview of Data Loss Prevention

The Data Loss Prevention (DLP) feature secures your organization’s proprietary information and intellectual property and enforces compliance with government regulations by preventing users from maliciously or unintentionally emailing sensitive data from your network. You define the types of data that your employees are not allowed to email by creating DLP policies that are used to scan outgoing messages for any data that may violate laws or corporate policies.

Related Topics

- [Overview of the DLP Scanning Process](#) , on page 485
- [How Data Loss Prevention Works](#) , on page 486

Overview of the DLP Scanning Process

	Action	More Information
1.	A user in your organization sends an email message to a recipient outside of your organization.	The appliance processes messages that are entering or leaving your network. Messages sent to other users within your network are not scanned.

	Action	More Information
2.	The appliance processes the message through the stages of its email “work queue” before it reaches the DLP scanning stage.	Pre-DLP-scanning processes ensure, for example, that the message includes no spam or malware. To see where DLP processing occurs in the workqueue, see the workqueue flow diagram in Email Pipeline Flows, on page 57 .
3.	The appliance scans the message body, header, and attachments for sensitive content that you have identified in DLP Policies.	See How Data Loss Prevention Works , on page 486 .
4.	If sensitive content is found, the appliance takes action to protect the data, such as quarantining the message, dropping it, or delivering it with restrictions. Otherwise, the message continues through the appliance's work queue and if no issues are found, the appliance delivers it to the recipient.	You define the actions to be taken. See Message Actions, on page 506 .

How Data Loss Prevention Works

When someone in your organization sends a message to a recipient outside your organization, the appliance determines which outgoing mail policy applies to the sender or recipient of that message, based on rules that you defined. The appliance evaluates the content of the message using the DLP policies that are specified in that outgoing mail policy.

Specifically, the appliance scans the message content (including headers and attachments) for text that matches words, phrases, predefined patterns such as social security numbers, or a regular expression that you identified as sensitive content in an applicable DLP policy.

The appliance also evaluates the context of disallowed content in order to minimize false positive matches. For example, a number matching a credit card number pattern is only a violation if it is accompanied by an expiration date, credit card company name (Visa, AMEX, etc.), or a person’s name and address.

If message content matches more than one DLP policy, the first matching DLP policy in the list applies, based on the order that you specified. If an outgoing mail policy has multiple DLP policies that use the same criteria to determine whether content is a violation, all policies use the result from a single content scan.

When potentially sensitive content appears in a message, the appliance assigns a risk factor score between 0 - 100 to the potential violation. This score indicates the likelihood that the message contains a DLP violation.

The appliance then assigns the severity level (such as Critical or Low) that you have defined for that risk factor score, and performs the message action that you have specified for that severity level in the applicable DLP Policy.

System Requirements for Data Loss Prevention

Data Loss Prevention is supported on all supported C-Series and X-Series appliances except appliances using D-Mode licenses.

How to Set Up Data Loss Prevention

Perform these steps in order:

Procedure

	Command or Action	Purpose
Step 1	Enable the DLP feature.	Enabling Data Loss Prevention (DLP) , on page 488
Step 2	Define the possible actions that can be taken for messages in which violations are found or suspected. For example, you can quarantine such messages.	Message Actions , on page 506
Step 3	Create DLP policies, which: <ul style="list-style-type: none"> • identify the content that must not be emailed from your organization, and • specify which actions will be taken for each violation. 	Choose a method: <ul style="list-style-type: none"> • Setting Up DLP Prevention Using a Wizard, on page 489 • Creating a DLP Policy Using a Predefined Template, on page 491 • Creating a Custom DLP Policy (Advanced), on page 492
Step 4	Set the order of the DLP policies to determine which DLP policy is used to evaluate messages for DLP violations when the content could match more than one DLP policy.	Arranging the Order of the Email DLP Policies for Violation Matching , on page 505
Step 5	Ensure that you have created Outgoing Mail Policies for each group of senders and recipients whose messages will be scanned for DLP violations.	See Mail Policies , on page 257 To further refine permitted and restricted message senders and recipients in individual DLP policies, see Filtering Messages for DLP Policies , on page 503.
Step 6	Specify which DLP policies apply to which senders and recipients by assigning DLP policies to Outgoing Mail Policies.	Associating DLP Policies with Outgoing Mail Policies , on page 505
Step 7	Configure settings for storage of and access to sensitive DLP information.	<ul style="list-style-type: none"> • Displaying Sensitive DLP Data in Message Tracking, on page 511 • Controlling Access to Sensitive Information in Message Tracking, on page 953

Enabling Data Loss Prevention (DLP)

Procedure

- Step 1** Select **Security Services > Data Loss Prevention**.
- Step 2** Click **Enable**.
- Step 3** Scroll to the bottom of the license agreement page and click **Accept** to accept the agreement.
- Note** If you do not accept the license agreement, DLP is not enabled on the appliance .
- Step 4** Under **Data Loss Prevention Global Settings**, select **Enable Data Loss Prevention**.
- Step 5** (Recommended) For now, deselect the other options on this page.
You can change these settings later, following instructions discussed elsewhere in this chapter.
- Step 6** Submit and commit your changes.
-

What to do next

See [How to Set Up Data Loss Prevention](#) , on page 487.

Related Topics

- [Displaying Sensitive DLP Data in Message Tracking](#) , on page 511
- [Setting Up DLP Prevention Using a Wizard](#) , on page 489
- [About Updating the DLP Engine and Content Matching Classifiers](#), on page 512

Policies for Data Loss Prevention

Related Topics

- [DLP Policy Description](#) , on page 489
- [Predefined DLP Policy Templates](#), on page 489
- [Setting Up DLP Prevention Using a Wizard](#) , on page 489
- [Creating a DLP Policy Using a Predefined Template](#) , on page 491
- [Creating a Custom DLP Policy \(Advanced\)](#) , on page 492
- [About Defining Disallowed Content Using Content Matching Classifiers](#) , on page 493
- [Filtering Messages for DLP Policies](#), on page 503
- [About Assessing Violation Severity](#) , on page 504
- [Arranging the Order of the Email DLP Policies for Violation Matching](#) , on page 505
- [Associating DLP Policies with the Default Outgoing Mail Policy](#) , on page 505
- [Important Information About Editing or Deleting DLP Policies](#) , on page 506

DLP Policy Description

A DLP policy includes:

- a set of conditions that determine whether an outgoing message contains sensitive data, and
- the actions to be taken when a message contains such data.

You specify how message content is evaluated, based on:

- Specific disallowed content or patterns of information. Depending on the policy, you may need to create a regular expression to search for identification numbers. See [About Defining Disallowed Content Using Content Matching Classifiers](#), on page 493.
- A list of specific senders and recipients for filtering messages. See [Filtering Messages for DLP Policies](#), on page 503.
- A list of attachment file types for filtering messages. See [Filtering Messages for DLP Policies](#), on page 503.
- Settings that allow different actions to occur based on the severity of the violation. See [About Assessing Violation Severity](#), on page 504.

You determine the message senders and recipients that each policy applies to when you enable DLP policies in Outgoing Mail Policies.

Predefined DLP Policy Templates

To simplify creation of DLP policies, your appliance includes a large collection of predefined policy templates.

Template categories include:

- **Regulatory Compliance.** These templates identify messages and attachments that contain personally identifiable information, credit information, or other protected or non-public information.
- **Acceptable Use.** These templates identify messages sent to competitors or restricted recipients that contain sensitive information about an organization.
- **Privacy Protection.** These templates identify messages and attachments that contain identification numbers for financial accounts, tax records, or national IDs.
- **Intellectual Property Protection.** These templates identify popular publishing and design document file types that may contain intellectual property that an organization would want to protect.
- **Company Confidential.** These templates identify documents and messages that contain information about corporate accounting information and upcoming mergers and acquisitions.
- **Custom Policy.** This “template” lets you create your own policy from scratch using either pre-defined content matching classifiers or violation identification criteria specified by your organization. This option is considered advanced and should be used only in the rare cases when the predefined policy templates do not meet the unique requirements of your network environment.

Some of these templates require customization.

Setting Up DLP Prevention Using a Wizard

The DLP Assessment Wizard helps you configure commonly-used DLP policies and enable them in the appliance's default outgoing mail policy.



Note By default, DLP policies added using the DLP Assessment Wizard deliver all messages, regardless of the severity of detected DLP violations. You will need to edit the policies created using the wizard.

Before You Begin

- Remove any existing DLP policies from the appliance . You can only use the DLP Assessment Wizard if there are no existing DLP policies on the appliance .
- If you need to detect messages that include student identification numbers or account numbers other than credit card numbers, US Social Security numbers, and US Drivers License numbers, create a regular expression that identifies those numbers. For more information, see [Regular Expressions for Identifying Identification Numbers](#) , on page 497.

Procedure

Step 1 Choose **Security Services > Data Loss Prevention**.

Step 2 Click **Edit Settings**.

Step 3 Select the **Enable and configure DLP using the DLP Assessment Wizard** check box.

Step 4 Click **Submit**.

Step 5 Complete the wizard.

Keep the following in mind:

- Any business that operates in California and owns or licenses computerized personally identifying information (PII) data for California residents, regardless of their physical location, is required to comply with **US State Regulations (California SB-1386)**. This law is one of the policy choices in the wizard.
- If you do not enter an email address to receive automatically-generated scheduled DLP Incident Summary report, the report will not be generated.
- When you review your configured settings, if you return to a step to make a change, you must proceed through the remaining steps until you reach the review page again. All settings that you previously entered will be remembered.
- When you complete the wizard, the **Outgoing Mail Policies** page displays, with your DLP policies enabled in the default outgoing mail policy. A summary of your DLP policy configuration is displayed at the top of the page.

Step 6 Commit your changes.

What to do next

- (Optional) To edit these DLP policies, create additional policies, change the overall action on messages, or change the severity level settings, choose **Mail Policies > DLP Policy Manager**. For information, see [Creating a DLP Policy Using a Predefined Template](#) , on page 491, [Creating a Custom DLP Policy \(Advanced\)](#) , on page 492, and [Adjusting the Severity Scale](#) , on page 504.
- (Optional) To enable existing DLP policies for other outgoing mail policies, see [Using Outgoing Mail Policies to Assign DLP Policies to Senders and Recipients](#) , on page 505.

Related Topics

- [Creating a DLP Policy Using a Predefined Template](#) , on page 491

- [Creating a Custom DLP Policy \(Advanced\)](#) , on page 492

Creating a DLP Policy Using a Predefined Template

Procedure

- Step 1** Select **Mail Policies > DLP Policy Manager**.
- Step 2** Click **Add DLP Policy**.
- Step 3** Click the name of a category to display a list of the available DLP policy templates.
- Note** To view descriptions of each template, click **Display Policy Descriptions**.
- Step 4** Click **Add** for the DLP policy template that you want to use.
- Step 5** (Optional) Change the predefined name and description of the template.
- Step 6** If the policy requires or recommends customizing one or more content matching classifiers, enter a regular expression to define the pattern of your organization's identification numbering system and a list of words or phrases related to the identification numbers that identify them as such or are typically associated with them.
- For information, see:
- [About Defining Disallowed Content Using Content Matching Classifiers](#) , on page 493 and [Regular Expressions for Identifying Identification Numbers](#) , on page 497.
- Note** You cannot add or remove content matching classifiers for policies based on a predefined template.
- Step 7** (Optional) Apply the DLP policy only to messages with specific recipients, senders, attachment types, or previously-added message tags.
- For more information, see [Filtering Messages for DLP Policies](#), on page 503.
- You can separate multiple entries using a line break or a comma.
- Step 8** In the Severity Settings section:
- Choose an action to take for each level of violation severity. For more information, see [About Assessing Violation Severity](#) , on page 504.
 - (Optional) Click **Edit Scale** to adjust the violation severity scale for the policy. For more information, see [Adjusting the Severity Scale](#) , on page 504.
- Step 9** Submit and commit your changes.
-

What to do next

Related Topics

- [Setting Up DLP Prevention Using a Wizard](#) , on page 489
- [Creating a Custom DLP Policy \(Advanced\)](#) , on page 492

Creating a Custom DLP Policy (Advanced)



Note Creating custom policies is very complex; create custom policies only if the predefined DLP policy templates do not meet the needs of your organization.

You can create a custom DLP policy from scratch using the Custom Policy template and add either a predefined content matching classifier or a custom classifier to the policy.

Custom policies can return a DLP violation if the content matches a single classifier or all classifiers, depending on how the policy is defined.

Before You Begin

Suggested: Define the criteria that identify a content violation. See [Creating a Content Matching Classifier for Custom DLP Policies](#), on page 495. You can also define these criteria from within this procedure.

Procedure

-
- Step 1** Select **Mail Policies > DLP Policy Manager**.
- Step 2** Click **Add DLP Policy**.
- Step 3** Click **Custom Policy**.
- Step 4** Click **Add** for the Custom Policy template.
- Step 5** Enter a name and description for the policy.
- Step 6** Identify the content and context that constitute a DLP violation:
- a) Select a content matching classifier.
 - b) Click **Add**.
 - If you selected **Create a Classifier**, see [Creating a Content Matching Classifier for Custom DLP Policies](#), on page 495.
 - Otherwise, the selected classifier is added to the table.
 - c) (Optional) Add additional classifiers to the policy.

For example, you might be able to eliminate known likely false positive matches by adding another classifier and selecting NOT.
 - d) If you added multiple classifiers: Choose an option in the table heading to specify whether **any** or **all** of the classifiers must match in order to count the instance as a violation.
- Step 7** (Optional) Apply the DLP policy only to messages with specific recipients, senders, attachment types, or previously-added message tags.
- For more information, see [Filtering Messages for DLP Policies](#), on page 503.
- You can separate multiple entries using a line break or a comma.
- Step 8** In the Severity Settings section:
- Choose an action to take for each level of violation severity. For more information, see [About Assessing Violation Severity](#), on page 504.

- (Optional) Click **Edit Scale** to adjust the violation severity scale for the policy. For more information, see [Adjusting the Severity Scale](#) , on page 504

Step 9 Submit and commit your changes.

What to do next

Related Topics

- [Setting Up DLP Prevention Using a Wizard](#) , on page 489
- [Creating a DLP Policy Using a Predefined Template](#) , on page 491

About Defining Disallowed Content Using Content Matching Classifiers

Content matching classifiers define the content that cannot be emailed and optionally the context in which that content must occur in order to be considered a data loss prevention violation.

Suppose you want to prevent patient identification numbers from being emailed from your organization.

In order for the appliance to recognize these numbers, you must specify the patterns of the record numbering system used by your organization, using one or more regular expressions. You can also add a list of words and phrases that might accompany the record number as supporting information. If the classifier detects the number pattern in an outgoing message, it searches for the supporting information to verify that the pattern is an identification number and not a random number string. Including context matching information results in fewer false positive matches.

For this example, you might create a DLP policy that uses the HIPAA and HITECH template. This template includes the Patient Identification Numbers content matching classifier, which you can customize to detect a patient's identification number. To detect numbers in the pattern of 123-CL456789, you would enter the regular expression `[0-9]{3}\-[A-Z]{2}[0-9]{6}` for the classifier. Enter "Patient ID" for a related phrase. Finish creating the policy and enable it in an outgoing mail policy. Submit and commit your changes. Now, if the policy detects the number pattern in an outgoing message with the phrase "Patient ID" in close proximity to the number pattern, the DLP policy returns a DLP violation.

About Using Content Matching Classifiers in DLP Policies

Many of the predefined DLP policy templates include content matching classifiers. Some of these classifiers require customization in order to identify the patterns that are used for data in your organization.

If you create a custom DLP policy you can choose a predefined classifier or create one of your own.

Related Topics

- [Content Matching Classifier Examples](#), on page 494
- [Creating a Content Matching Classifier for Custom DLP Policies](#) , on page 495
- [Classifier Detection Rules for Identifying Sensitive Content \(Custom DLP Policies Only\)](#) , on page 496
- [Regular Expressions for Identifying Identification Numbers](#) , on page 497
- [Using Custom Dictionaries of Sensitive DLP Terms \(Custom DLP Policies Only\)](#) , on page 498
- [Determiners of the Risk Factor of a Suspected Violation](#) , on page 500
- [Viewing the Policies in Which Custom Content Classifiers are Used](#) , on page 503

Content Matching Classifier Examples

The following examples show how classifiers match message content:

- [Credit Card Number](#), on page 494
- [US Social Security Number](#), on page 494
- [ABA Routing Numbers](#), on page 494
- [Driver License Numbers \(US\)](#), on page 494
- [National Provider IDs \(US\)](#), on page 495
- [Academic Records \(English\)](#), on page 495
- [Financial Statements \(English\)](#), on page 495

Credit Card Number

Several DLP policy templates include the Credit Card Number classifier. The credit card number itself is subject to various constraints, such as the pattern of digits and punctuation, the issuer-specific prefix, and the final check digit. The classifier requires additional supporting information to make a match, such as an expiration date, or the name of the card issuer. This reduces the number of false positives.

Examples:

- 378734493671000 (No match because of no supporting information)
- 378734493671000 VISA (Match)
- 378734493671000 exp: 12/2019 (Match)

US Social Security Number

The US Social Security Number classifier requires a properly formatted number as well as supporting data, such as a date of birth, name, or the string SSN .

Examples:

- 321-02-3456 (No match because of no supporting information)
- SSN: 132-45-6788 (Match)

ABA Routing Numbers

The ABA Routing Number classifier is similar to the Credit Card Number classifier.

Examples:

- 119999992 (No match because of no supporting information)
- ABA No. 800000080 (Match)

Driver License Numbers (US)

Many policies use a US Drivers License classifier. By default, this classifier searches for drivers licenses issued in the US. US state-specific policies such as California AB-1298 and Montana HB-732 search for their respective state US drivers' licenses only.

The individual state classifiers match against the patterns for that state, and require the corresponding state name or abbreviation, and additional supporting data.

Examples:

- CA DL# C3452362 (Match because it has the correct pattern for the number and supporting data)
- California DL# C3452362 (Match)

- DL: C3452362 (No match because there is not enough supporting data)
- California C3452362 (No match because there is not enough supporting data)
- OR DL# C3452362 (Match)
- OR DL# 3452362 (Match because it is the correct pattern for Oregon)
- WV DL# D654321 (Match because it is the correct pattern for West Virginia)
- WV DL# G654321 (Match)

National Provider IDs (US)

The US National Provider Identifier classifier scans for a US National Provider Identifier (NPI) numbers, which is a 10-digit number with a check digit.

Examples:

- NPI No. 1245319599 (Match for NPI)
- NPI No. 1235678996 (Match for NPI)
- 3459872347 (No match because of no supporting information)
- NPI: 3459872342 (No match because of incorrect check digit)

Academic Records (English)

The predefined FERPA (Family Educational Rights and Privacy Act) DLP policy template uses the Student Records classifier. Combine it with a customized Student Identification Number classifier to detect specific student ID patterns for better accuracy.

Example:

- Fall Semester Course Numbers: CHEM101, ECON102, MATH103 (Match)

Financial Statements (English)

The predefined Sarbanes-Oxley (SOX) policy template uses the Corporate Financials classifier to search for non-public corporate financial information.

Example:

Gross Profits, Current Assets, and Cash Flow Statement for the Quarter ended June 30, 2016.
(Match)

Creating a Content Matching Classifier for Custom DLP Policies

Custom classifiers that you create are added to the list of classifiers that you can use when creating custom DLP policies.

Procedure

	Command or Action	Purpose
Step 1	Understand how content matching classifiers are used to identify potential DLP violations.	See: <ul style="list-style-type: none"> • About Defining Disallowed Content Using Content Matching Classifiers, on page 493 • Content Matching Classifier Examples, on page 494

	Command or Action	Purpose
Step 2	Select Mail Policies > DLP Policy Customizations and click Add Custom Classifier . Enter a classifier name and description.	—
Step 3	Enter a proximity and a minimum total score.	See Determiners of the Risk Factor of a Suspected Violation , on page 500
Step 4	Choose one of the following detection rule types and define the associated content matching criteria: <ul style="list-style-type: none"> • words or phrases • text from a dictionary • a regular expression, or • an existing data loss prevention entity 	See: <ul style="list-style-type: none"> • Classifier Detection Rules for Identifying Sensitive Content (Custom DLP Policies Only) , on page 496 • Using Custom Dictionaries of Sensitive DLP Terms (Custom DLP Policies Only) , on page 498 • Regular Expressions for Identifying Identification Numbers , on page 497
Step 5	(Optional) Add additional rules by clicking Add Rule .	For information about Weight and Max Score, see Determiners of the Risk Factor of a Suspected Violation , on page 500.
Step 6	If you include multiple rules, specify whether All or Any rules must match.	This setting is at the top of the Rules section.
Step 7	Submit and commit your changes.	—

What to do next

Use your custom content classifier in a custom DLP Policy. See [Creating a Custom DLP Policy \(Advanced\)](#) , on page 492.

Related Topics

- [Viewing the Policies in Which Custom Content Classifiers are Used](#) , on page 503

Classifier Detection Rules for Identifying Sensitive Content (Custom DLP Policies Only)

Content matching classifiers require rules for detecting DLP violations in a message or document. Classifiers can use one or more of the following detection rules:

- **Words or Phrases.** A list of words and phrases for which the classifier should look. Separate multiple entries with a comma or line break.
- **Regular Expression.** A regular expression to define a search pattern for a message or attachment. You can also define a pattern to exclude from matching to prevent false positives. See [Regular Expressions for Identifying Identification Numbers](#) , on page 497 and [Examples of Regular Expressions for Identifying Identification Numbers](#) , on page 498 for more information.
- **Dictionary.** A dictionary of related words and phrases. Your appliance includes pre-defined dictionaries, or you can create your own. See [Using Custom Dictionaries of Sensitive DLP Terms \(Custom DLP Policies Only\)](#) , on page 498.

- **Entity.** A predefined pattern that identifies common types of sensitive data, such as credit card numbers, addresses, social security numbers, or ABA routing numbers. For descriptions of the entities, go to **Mail Policies > DLP Policy Manager**, click **Add DLP Policy**, click **Privacy Protection**, then click **Display Policy Descriptions**.

Regular Expressions for Identifying Identification Numbers

Some policy templates require customization of one or more content matching classifiers, which involves creating a regular expression to search for identification numbers that may be linked to confidential information, such as a custom account number, patient identification number or Student ID. You can use the **Perl Compatible Regular Expression (PCRE2)** syntax to add regular expressions for content matching classifiers or the DLP policy templates. The regular expressions are validated for PCRE2 compatibility only when the DLP feature is enabled on your appliance .



Note Regular expressions are case sensitive, so they should include upper and lower case, such as `[a-zA-Z]` . If only certain letters are used, you can define the regular expression accordingly.

The less specific the pattern, such as an 8-digit number, the more likely you will want the policy to search for additional words and phrases to distinguish a random 8-digit number from an actual customer number.

Use the following table as a guide for creating regular expressions for classifiers:

Element	Description
Regular expression (abc)	Regular expressions for classifiers match a string if the sequence of directives in the regular expression match any part of the string. For example, the regular expression ACC matches the string ACCOUNT as well as ACCT .
[]	Use brackets to indicate a set of characters. Characters can defined individually or within a range. For example, [a-z] matches all lowercase letters from a to z , while [a-zA-Z] matches all uppercase and lowercase letters from A to Z . [xyz] matches only the letters x , y , or z .
Backslash special characters (\)	The backslash character <i>escapes</i> special characters. Thus the sequence <code>\.</code> only matches a literal period, the sequence <code>\\$</code> only matches a literal dollar sign, and the sequence <code>\^</code> only matches a literal caret symbol. The backslash character also begins tokens, such as <code>\d</code> . Important Note: The backslash is also a special escape character for the parser. As a result, if you want to include a backslash in your regular expression, you must use <i>two</i> backslashes — so that after parsing, only one “real” backslash remains, which is then passed to the regular expression system.

Element	Description
<code>\d</code>	Token that matches a digit (0 - 9). To match more than one digit, enter an integer in {} to define the length of the number. For example, <code>\d</code> matches only a single digit such as 5 , but not 55 . Using <code>\d{2}</code> matches a number consisting of two digits, such as 55 , but not 5 .
<code>\D</code>	Token that matches any non-digit character. To match more than one non-digit character, enter an integer in {} to define the length.
<code>\w</code>	Token that matches any alphanumeric character and the underscore (a - z , A - Z , 0 - 9 , and _).
Number of repetitions {min,max}	The regular expression notation that indicates the number of repetitions of the previous token is supported. For example, the expression “ <code>\d{8}</code> ” matches 12345678 and 11223344 but not 8 .
Or ()	Alternation, or the “or” operator. If A and B are regular expressions, the expression “ <code>A B</code> ” will match any string that matches either “A” or “B.” Can be used to combine number patterns in a regular expression. For example, the expression “ <code>foo bar</code> ” will match either foo or bar , but not foobar .

Related Topics

- [Examples of Regular Expressions for Identifying Identification Numbers , on page 498](#)

Examples of Regular Expressions for Identifying Identification Numbers

Simple regular expressions that describe patterns of numbers and letters in identification or account numbers might look like the following:

- An 8-digit number: `\d{8}`
- Identification code with hyphens between sets of numbers: `\d{3}-\d{4}-\d{4}`
- Identification code that begins with a single letter that can be upper or lower case: `[a-zA-Z]\d{7}`
- Identification code that begins with three digits and is followed by nine uppercase letters: `\d{3}[A-Z]{9}`
- Using | to define two different number patterns to search for: `\d{3}[A-Z]{9}|\d{2}[A-Z]{9}-\d{4}`

Using Custom Dictionaries of Sensitive DLP Terms (Custom DLP Policies Only)

AsyncOS comes with a set of predefined dictionaries, but you can also create custom DLP dictionaries to specify terms for the DLP scanning feature to match.

You can create a custom DLP dictionary in several ways:

- [Adding Custom DLP Dictionaries Directly , on page 499](#)
- [Creating DLP Dictionaries as Text Files , on page 499](#) and then [Importing DLP Dictionaries , on page 499](#).
- [Exporting DLP Dictionaries , on page 499](#) from another appliance and then [Importing DLP Dictionaries , on page 499](#).

Adding Custom DLP Dictionaries Directly

Procedure

- Step 1** Select **Mail Policies > DLP Policy Manager**.
 - Step 2** In the **Advanced Settings** section, click the link beside **Custom DLP Dictionaries**.
 - Step 3** Click **Add Dictionary**.
 - Step 4** Enter a name for the custom dictionary.
 - Step 5** Enter new dictionary entries (words and phrases) into the list of terms.
Dictionary terms are case-sensitive and can contain non-ASCII characters.
When entering multiple entries, separate the entries with line breaks.
 - Step 6** Click **Add**.
 - Step 7** Submit and commit your changes.
-

Creating DLP Dictionaries as Text Files

You can create your own dictionary as a text file on your local machine and import it onto the appliance . Use line breaks for each term in the dictionary text file. Dictionary terms are case-sensitive and can contain non-ASCII characters.

Exporting DLP Dictionaries



Note Predefined DLP dictionaries cannot be exported.

Procedure

- Step 1** Select **Mail Policies > DLP Policy Manager**.
 - Step 2** Click the link for the **Custom DLP Dictionaries** section under Advanced Settings.
 - Step 3** Click **Export Dictionary**.
 - Step 4** Select a dictionary to export.
 - Step 5** Enter a file name for the dictionary.
 - Step 6** Choose where to save the exported dictionary, either on your local computer or in the configuration directory on the appliance .
 - Step 7** Select an encoding for the file.
 - Step 8** Click **Submit** and save the file.
-

Importing DLP Dictionaries

Before You Begin

If you will import a file that you exported from a non-DLP dictionary on an appliance, you must first strip the weight values from the text file and convert any regular expressions to words or phrases.

Procedure

- Step 1** Select **Mail Policies > DLP Policy Manager**.
 - Step 2** In the **Advanced Settings** section, click the link beside **Custom DLP Dictionaries**.
 - Step 3** Click **Import Dictionary**.
 - Step 4** Select a file to import from either your local machine or the configuration directory on the appliance.
 - Step 5** Select an encoding.
 - Step 6** Click **Next**.
A “Success” message appears and the imported dictionary is displayed in the Add Dictionary page. However, the process is not yet complete.
 - Step 7** Name and edit the dictionary.
 - Step 8** Click **Submit**.
-

Determiners of the Risk Factor of a Suspected Violation

When the appliance scans a message for DLP violations, it assigns a risk factor score to the message. This score indicates the likelihood that the message contains a DLP violation. A score of 0 means the message almost certainly does not contain a violation. A score of 100 means it almost certainly does contain a violation.

For DLP Policies Based On Predefined Templates

You cannot view or modify risk factor scoring parameters for DLP policies created from predefined templates. However, if there are too many false positive matches for a particular DLP policy, you can adjust the severity scale for that policy. See [About Assessing Violation Severity](#), on page 504. For policies based on templates that do not have a content matching classifier, such as the SOX (Sarbanes-Oxley) template, the scanning engine always returns a risk factor value of “75” when a message violates the policy.

For Custom DLP Policies

When you create content matching classifiers for custom DLP policies, you specify values that are used to determine the risk factor score:

- **Proximity.** How close the rule matches must occur in the message or attachment to count as a violation. For example, if a numeric pattern similar to a social security number appears near the top of a long message and an address appears in the sender’s signature at the bottom, they are presumed to be unrelated and the data does not count as a match.
- **Minimum Total Score.** The minimum risk factor score required for sensitive content to be labeled a DLP violation. If the score of a message’s matches does not meet the minimum total score, its data is not considered sensitive.
- **Weight.** For each custom rule you create, you specify a “weight” to indicate the importance of the rule. A score is obtained by multiplying the number of detection rule matches by the weight of the rule. Two instances of a rule with a weight of 10 results in a score of 20. If one rule is more important for the classifier than the others, it should be assigned a greater weight.

- **Maximum Score.** A rule's maximum score prevents a large number of matches for a low-weight rule from skewing the final score of the scan.
- **Minimum Score.** You can use the recommended minimum score or choose to use the weight depending on the **Use recommended minimum scores for entity-based rules** check box selected in the Custom Classifiers Settings section of the DLP Policy Customizations page. For more information, see [Using Minimum Score for Entity-based Rules \(Custom DLP Policies Only\)](#), on page 502

To calculate the risk factor, the classifier multiplies the number of matches for a detection rule by the weight of the rule. If this value exceeds the detection rule's maximum score, the classifier uses the maximum score value. If the classifier has more than one detection rule, it adds the scores for all of its detection rules into a single value. The classifier maps the detection rules score (10 - 10000) on a scale of 10 -100 using the logarithmic scale shown in the following table to create the risk factor:

Table 41: How Risk Factor Scores Are Calculated From Detection Rule Scores

Rule Scores	Risk Factor
0	0
1	1
2	2
3	3
5	6
6	7
7	8
8	9
9	10
10	11
15	16
20	20
25	24
30	26
40	32
50	36
75	44
100	50
125	54

Rule Scores	Risk Factor
150	58
257	67
300	70
400	75
500	78
750	84
1000	87
5000	98
8000	99
10000	99
20000	100

Using Minimum Score for Entity-based Rules (Custom DLP Policies Only)

Procedure

Step 1 Go to **Mail Policies > DLP Policy Customizations**.

Step 2 In the **Custom Classifiers Settings** section, select the **Use recommended minimum scores for entity-based rules** check box.

If you select this option, the score for the entity-based rule is calculated using the configured minimum score instead of the weight.

For example, when you disable this option and a message has five rule matches of a certain entity with the weight configured as 10, the rule calculates the score as five matches times 10 occurrences, which is 50. If you enable this option with a minimum score for an entity as 10, the score is calculated based on the configured minimum score and the number of partial and full matches.

Note You must review the minimum total score of all the classifiers with entity-based rules when you select the Use recommended minimum scores for entity-based rules option.

Step 3 Click **Submit** and commit your changes.

After you enable this option, you must review the minimum scores for entity-based rules of a custom classifier. For more information, see [Creating a Content Matching Classifier for Custom DLP Policies](#), on page 495.

Viewing the Policies in Which Custom Content Classifiers are Used

Procedure

-
- Step 1** Select **Mail Policies > DLP Policy Customizations**.
- Step 2** In the **Custom Classifiers** section, click the **Policies** link in the heading of the Custom Classifiers table.
-

What to do next

Related Topics

- [Creating a Content Matching Classifier for Custom DLP Policies](#) , on page 495

Filtering Messages for DLP Policies

To improve performance or accuracy, you can limit a DLP policy to apply only to certain messages based on the following criteria:

Option	Description
Filtering by Senders and Recipients	<p>You can limit the DLP policy to apply to messages that do or do not include recipients or senders that you specify using one of the following:</p> <ul style="list-style-type: none"> • Full email address: <code>user@example.com</code> • Partial email address: <code>user@</code> • All users in a domain: <code>@example.com</code> • All users in a partial domain: <code>@.example.com</code> <p>Separate multiple entries using a line break or a comma.</p> <p>AsyncOS first matches the recipient or sender of an outgoing message to an outgoing mail policy, then matches the sender or recipient to the sender and recipient filters specified in the DLP policies enabled for that mail policy.</p> <p>For example, you might want to disallow all senders from sending a certain type of information, except to recipients in a partner domain. You would create a DLP policy for that information, including a filter that exempts all users in the partner domain, then include this DLP policy in an Outgoing Mail Policy that applies to all senders.</p>
Filtering by Attachment Types	<p>You can limit the DLP policy to scanning only messages that do or do not include specific attachment types. Choose an attachment category, then a predefined file type, or specify file types that are not listed. If you specify a file type that is not predefined, AsyncOS searches for the file type based on the attachment's extension.</p> <p>You can also limit DLP scanning to attachments with a minimum file size.</p>

Option	Description
Filtering by Message Tag	If you want to limit a DLP policy to messages containing a specific phrase, you can use a message or content filter to search outgoing messages for the phrase and insert a custom message tag into the message. For more information, see Content Filter Actions, on page 280 and Using Message Filters to Enforce Email Policies, on page 131

About Assessing Violation Severity

When the DLP scanning engine detects a potential DLP violation, it calculates a risk factor score that represents the likelihood that the instance actually is a DLP violation. The policy compares the risk factor score to the Severity Scale defined in that policy in order to determine the severity level (for example, Low or Critical.) You specify the action to take for violations at each severity level (except Ignore, for which no action is ever taken.) You can adjust the risk factor scores required to reach each severity level.

Related Topics

- [Adjusting the Severity Scale , on page 504](#)

Adjusting the Severity Scale

All policies have a default severity scale. You can adjust this scale for each policy.

For example, by default, a violation has a severity level of Critical if its risk factor score is between 90 and 100. However, for violations that match a particular policy, you may want increased sensitivity to potential data loss. For this DLP policy, you could change the Critical severity level to any violation with a risk factor score between 75 and 100.

Procedure

-
- Step 1** Select **Mail Policies > DLP Policy Manager**.
 - Step 2** Click the name of the policy to edit.
 - Step 3** In the **Severity Settings** section, click **Edit Scale**.
 - Step 4** Use the scale's arrows to adjust the scores for the severity levels.
 - Step 5** Click **Done**.
 - Step 6** In the Severity Scale table, verify that your scores are as you want them.
 - Step 7** Click **Submit**.
-

What to do next

Related Topics

- [About Assessing Violation Severity , on page 504](#)

Arranging the Order of the Email DLP Policies for Violation Matching

If a DLP violation matches more than one of the DLP policies enabled in the outgoing mail policy, only the first matching DLP policy in the list is used.

Procedure

- Step 1** On the DLP Policy Manager page, click **Edit Policy Order**.
 - Step 2** Click on the row for a policy you want to move and drag it to a new position in the order.
 - Step 3** Once you have finished reordering the policies, submit and commit your changes.
-

Associating DLP Policies with Outgoing Mail Policies

Related Topics

- [Associating DLP Policies with the Default Outgoing Mail Policy](#) , on page 505
- [Using Outgoing Mail Policies to Assign DLP Policies to Senders and Recipients](#) , on page 505

Associating DLP Policies with the Default Outgoing Mail Policy

The default outgoing mail policy is used when no other outgoing mail policy matches the sender or a recipient.

Before You Begin

Complete all activities up to this point in the table in [How to Set Up Data Loss Prevention](#) , on page 487. For example, ensure that you have created the DLP policies that you want to include in the default Outgoing Mail Policy.

Procedure

- Step 1** Choose **Mail Policies > Outgoing Mail Policies**.
 - Step 2** In the **Default Policy** row of the table, click the **Disabled** link in the **DLP** column.
 - Step 3** Select **Enable DLP (Customize Settings)**.
 - Step 4** Select the DLP policies to enable for the default outgoing mail policy.
 - Step 5** Submit and commit your changes.
-

What to do next

Choose the DLP policies for additional Outgoing Mail Policies. See [Using Outgoing Mail Policies to Assign DLP Policies to Senders and Recipients](#) , on page 505.

Using Outgoing Mail Policies to Assign DLP Policies to Senders and Recipients

Specify which DLP policies apply to which senders and recipients by enabling them in outgoing mail policies. You can use DLP policies only in outgoing mail policies.

Before You Begin

Configure the DLP policy settings for the default Outgoing Mail policy. See [Associating DLP Policies with the Default Outgoing Mail Policy](#) , on page 505.

Procedure

-
- Step 1** Choose **Mail Policies > Outgoing Mail Policies**.
 - Step 2** Click the link in the DLP column in any row of the table.
 - Step 3** Select the DLP policies to associate with this outgoing mail policy.
 - Step 4** Submit your changes.
 - Step 5** Repeat as needed for other Outgoing Mail Policies.
 - Step 6** Commit your changes.
-

What to do next

See [How to Set Up Data Loss Prevention](#) , on page 487.

Important Information About Editing or Deleting DLP Policies

Action	Information
Editing a DLP policy	If you rename a policy, you must re-enable it in your outgoing mail policies.
Deleting a DLP policy	If you delete a policy, you will receive a notification if the DLP policy is used in one or more outgoing mail policies. Deleting a DLP policy removes it from these mail policies.

Message Actions

You specify primary and secondary actions that the appliance will take when it detects a possible DLP violation in an outgoing message. Different actions can be assigned for different violation types and severities.

Primary actions include:

- Deliver
- Drop
- Quarantine

Secondary actions include:

- Sending a copy to a policy quarantine if you choose to deliver the message. The copy is a perfect clone of the original, including the Message ID. Quarantining a copy allows you to test the DLP system before deployment in addition to providing another way to monitor DLP violations. When you release the copy from the quarantine, the appliance delivers the copy to the recipient, who will have already received the original message.

- Encrypting messages. The appliance only encrypts the message body. It does not encrypt the message headers.
- Altering the subject header of messages containing a DLP violation.
- Adding disclaimer text to messages.
- Sending messages to an alternate destination mailhost.
- Sending copies (bcc) of messages to other recipients. (For example, you could copy messages with critical DLP violations to a compliance officer's mailbox for examination.)
- Sending a DLP violation notification message to the sender or other contacts, such as a manager or DLP compliance officer. See [Drafting DLP Notifications](#) , on page 509.



Note These actions are not mutually exclusive: you can combine some of them within different DLP policies for various processing needs for different user groups. You can also configure different treatments based on the different severity levels in the same policy. For example, you may want to quarantine messages with critical DLP violations and send a notification to a compliance officer, but you may want to deliver messages with low severity levels.

Related Topics

- [Defining Actions to Take for DLP Violations \(Message Actions\)](#) , on page 507
- [Viewing and Editing Message Actions](#) , on page 508
- [Drafting DLP Notifications](#) , on page 509

Defining Actions to Take for DLP Violations (Message Actions)

Before You Begin

- Create at least one dedicated quarantine to hold messages (or copies of messages) that violate DLP policies.

This can be a local quarantine on an appliance or a centralized quarantine on a Security Management appliance .

For information, see [Policy, Virus, and Outbreak Quarantines](#), on page 899
- If you want to encrypt messages before delivery, make sure you have set up an encryption profile. See [Cisco Email Encryption](#), on page 515
- To include disclaimer text when delivering messages with DLP violations or suspected violations, specify disclaimer text in **Mail Policies > Text Resources**. For information, see [Disclaimer Template](#), on page 631
- To send a notification to the sender of a DLP violation or to another person such as a compliance officer, first create the DLP notification template. See [Drafting DLP Notifications](#) , on page 509.

Procedure

- Step 1** Select **Mail Policies > DLP Policy Customizations**.
- Step 2** In the **Message Actions** section, click **Add Message Action**.
- Step 3** Enter a name for the message action.

- Step 4** Enter a description of the message action.
- Step 5** Choose whether to drop, deliver, or quarantine messages containing DLP violations.
- Note** If you select Deliver, you can choose to have a copy of the message sent to a policy quarantine. The copy of the message is a perfect clone, including the Message ID.
- Step 6** If you want to encrypt the message upon delivery or its release from quarantine, select the **Enable Encryption** check box and select the following options:
- **Encryption Rule.** Always encrypts the message or only encrypt it if an attempt to send it over a TLS connection first fails.
 - **Encryption Profile.** Encrypts the message using the specified encryption profile and delivers it if you use a Cisco IronPort Encryption Appliance or a hosted key service.
 - **Encrypted Message Subject.** Subject for the encrypted message. Use the value is **\$Subject** to keep the existing message subject.
- Step 7** If you select Quarantine as the action, choose the policy quarantine that you want to use for messages containing DLP violations.
- Step 8** Click **Advanced** if you want to modify the message using any of the following options:
- Add a custom header
 - Modify the message subject
 - Deliver it to alternate host
 - Send a copy (bcc) to another recipient
 - Send a DLP notification message
- Step 9** Submit and commit your changes.
-

Viewing and Editing Message Actions

Procedure

- Step 1** Select **Mail Policies > DLP Policy Customizations**.
- Step 2** In the **Message Actions** section, choose an action:

To	Do This
View the mail policies to which each action is assigned	Click the Policies link in the heading of the Message Actions table.
View the description that you entered for each action	Click the Description link in the heading of the Message Actions table.
View or edit details of a Message Action	Click the name of the Message Action.

To	Do This
Delete a Message Action	Click the trash can icon next to the message action you want to delete. A confirmation message notifies you if the message action is used in one or more DLP policies.
Duplicate a Message Action You can use this feature to create a backup copy of a Message Action before changing it, or to use as a starting point for a new, similar Message Action.	Click the Duplicate icon next to the message action that you want to duplicate.

Step 3 Submit and commit any changes.

Drafting DLP Notifications

Use this procedure to create a template for the notification that will be sent when an email message contains information that violates your organization's data loss prevention policies. You can send this notification to the sender of the message that violated DLP policy, or to another address, for example a manager or DLP Compliance officer.

Before You Begin

- Familiarize yourself with the [DLP Notification Template Variable Definitions, on page 510](#). You can use these variables to customize the notification with specific details about each violation.

Procedure

Step 1 Select **Mail Policies > Text Resources**.

Step 2 Click **Add Text Resource**.

Step 3 For **Type**, select **DLP Notification Template**.

DLP variables are not available for the plain Notification template.

Step 4 Enter notification text and variables.

The notification should inform its recipients that an outgoing message may contain sensitive data that violates your organization's data loss prevention policies.

What to do next

Specify this DLP notification template in a Message Action in a DLP policy in the DLP Policy Manager.

Related Topics

- [DLP Notification Template Variable Definitions, on page 510](#)

DLP Notification Template Variable Definitions

Use the following variables to include specific information about each DLP violation in the notification.

Variable	Substituted With
\$DLPPolicy	Replaced by the name of the email DLP policy violated.
\$DLPSeverity	Replaced by the severity of violation. Can be “Low,” “Medium,” “High,” or “Critical.”
\$DLPRiskFactor	Replaced by the risk factor of the message’s sensitive material (score 0 - 100).
\$To	Replaced by the message To: header (not the Envelope Recipient).
\$From	Replaced by the message From: header (not the Envelope Sender).
\$Subject	Replaced by the subject of the original message.
\$Date	Replaced by the current date, using the format MM/DD/YYYY.
\$Time	Replaced by the current time, in the local time zone.
\$GMTimestamp	Replaced by the current time and date, as would be found in the Received: line of an email message, using GMT.
\$MID	Replaced by the Message ID, or “MID” used internally to identify the message. Not to be confused with the RFC822 “Message-Id” value (use \$Header to retrieve that).
\$Group	Replaced by the name of the sender group the sender matched on when injecting the message. If the sender group had no name, the string “>Unknown<” is inserted.
\$Reputation	Replaced by the IP Reputation score of the sender. If there is no reputation score, it is replaced with “None”.
\$filenames	Replaced with a comma-separated list of the message’s attachments’ filenames.
\$filetypes	Replaced with a comma-separated list of the message’s attachments’ file types.
\$filesizes	Replaced with a comma-separated list of the message’s attachment’s file sizes.
\$remotehost	Replaced by the hostname of the system that sent the message to the Cisco appliance.
\$AllHeaders	Replaced by the message headers.
\$EnvelopeFrom	Replaced by the Envelope Sender (Envelope From, <MAIL FROM>) of the message.
\$Hostname	Replaced by the hostname of the appliance .
\$bodysize	Replaced by the size, in bytes, of the message.
\$header[‘string ’]	Replaced by the value of the quoted header, if the original message contains a matching header. Note that double quotes may also be used.
\$remoteip	Replaced by the IP address of the system that sent the message to the appliance .
\$recvlistener	Replaced by the nickname of the listener that received the message.

Variable	Substituted With
\$dropped_filenames	Same as \$filenames , but displays list of dropped files.
\$dropped_filename	Returns only the most recently dropped filename.
\$recvint	Replaced by the nickname of the interface that received the message.
\$timestamp	Replaced by the current time and date, as would be found in the Received: line of an email message, in the local time zone.
\$Time	Replaced by the current time, in the local time zone.
\$orgid	Replaced by the SenderBase Organization ID (an integer value).
\$enveloperecipients	Replaced by all Envelope Recipients (Envelope To, <RCPT TO>) of the message.
\$dropped_filetypes	Same as \$filetypes , but displays list of dropped file types.
\$dropped_filetype	Returns only the file type of the most recently dropped file.

Displaying Sensitive DLP Data in Message Tracking

DLP deployment offers the option to log the content that violates your DLP policies, along with the surrounding content, which can then be viewed in Message Tracking. This content may include sensitive data such as credit card numbers and social security numbers.

Before You Begin

Enable Message Tracking. See [Enabling Message Tracking, on page 887](#)

Procedure

-
- Step 1** Select **Security Services > Data Loss Prevention**.
 - Step 2** Click **Edit Settings**.
 - Step 3** Select the **Enable Matched Content Logging** check box.
 - Step 4** Submit and commit your changes.
-

What to do next

Specify which administrative users can view this information. See [Controlling Access to Sensitive Information in Message Tracking, on page 953](#).

Related Topics

- [Message Tracking Details , on page 894](#)

About Updating the DLP Engine and Content Matching Classifiers

Updates for the Cisco DLP engine and the predefined content matching classifiers on your appliance are independent of updates for other security services.

Related Topics

- [Determining the Current Version of the DLP Engine](#) , on page 512
- [Updating the DLP Engine and Content Matching Classifiers Manually](#) , on page 512
- [Enabling Automatic Updates \(Not Recommended\)](#) , on page 513
- [DLP Updates on Centralized \(Clustered\) Appliances](#) , on page 513

Determining the Current Version of the DLP Engine

Procedure

Step 1 Select **Security Services > Data Loss Prevention**.

Step 2 Look in the **Current DLP Version Files** section.

Note You can also use the `dlpstatus` CLI command to view the current version of the DLP engine. See the *CLI Reference Guide for AsyncOS for Cisco Email Security Appliances* for more information.

Updating the DLP Engine and Content Matching Classifiers Manually

Before you Begin

See the following:

- (If applicable) [DLP Updates on Centralized \(Clustered\) Appliances](#) , on page 513

Procedure

Step 1 Select **Security Services > Data Loss Prevention**.

Step 2 Click **Update Now** in the **Current DLP Version Files** section.

This button is available only when there are new updates available for download.

Note You can also use the `dlpupdate` CLI command to update the DLP engine. See the *CLI Reference Guide for AsyncOS for Cisco Email Security Appliances* for more information.

Enabling Automatic Updates (Not Recommended)

Use this procedure to enable the appliance to check for and download updates at a regular interval.



Note Cisco recommends that you do not enable automatic updates. These updates may change the content matching classifiers used in your DLP policies. Instead, manually download DLP updates and test them in a lab environment before updating appliances used in production.

Before You Begin

- On the **Security Settings > Service Updates** page, make sure you have enabled automatic updates and specified an update interval for all service updates.
- See [DLP Updates on Centralized \(Clustered\) Appliances](#), on page 513.

Procedure

- Step 1** Select **Security Services > Data Loss Prevention**.
- Step 2** Click **Edit Settings**.
- Step 3** Select the **Enable automatic updates** check box.
- Step 4** Submit and commit your changes.

DLP Updates on Centralized (Clustered) Appliances

Note the following:

- You cannot enable automatic DLP updates for appliances in clustered deployments.
- DLP updates are always performed at the machine level, irrespective of DLP configured at the cluster, machine or group level.
- You can only check the status of an appliance's DLP engine using the `dlpstatus` CLI command at the machine level.

Working with DLP Incident Messages and Data



Note See also the documentation for the Security Management appliance, as applicable to your deployment.

To	Do This
Search for messages containing DLP violations using criteria such as DLP policy name, violation severity, and action taken, and view details of messages found	See Tracking Messages , on page 887.

To	Do This
View or manage messages that have been quarantined as suspected DLP violations	See Working with Messages in Policy, Virus, or Outbreak Quarantines , on page 909.
View a summary of DLP incidents	See information about DLP Incident Summary reports in Using Email Security Monitor , on page 807.
View information about DLP violations discovered in outgoing mail	See information about DLP Incident reports in Using Email Security Monitor , on page 807.

Related Topics

- [Displaying Sensitive DLP Data in Message Tracking](#) , on page 511
- [Controlling Access to Sensitive Information in Message Tracking](#), on page 953

Troubleshooting Data Loss Prevention

- [DLP Fails to Detect Violations in Email Attachments](#), on page 514

DLP Fails to Detect Violations in Email Attachments

Problem

When using predefined DLP policies, DLP fails to detect violations in email attachments. This can be caused by:

- The small value of the proximity parameter in the predefined DLP policies



Note You cannot change the proximity of a predefined DLP policy.

- The high severity scale parameter defined in the predefined DLP policies

Solution

- Create a custom policy and adjust the proximity as required. See [Creating a Custom DLP Policy \(Advanced\)](#) , on page 492
- Lower the severity scale parameter of the predefined DLP policy. See [Adjusting the Severity Scale](#) , on page 504



CHAPTER 22

Cisco Email Encryption

This chapter contains the following sections:

- [Overview of Cisco Email Encryption, on page 515](#)
- [How to Encrypt Messages with a Local Key Server, on page 516](#)
- [Encrypting Messages using the Email Security Appliance , on page 517](#)
- [Determining Which Messages to Encrypt, on page 522](#)
- [Inserting Encryption Headers into Messages, on page 525](#)

Overview of Cisco Email Encryption

AsyncOS supports using encryption to secure inbound and outbound email. To use this feature, you create an encryption profile that specifies characteristics of the encrypted message and connectivity information for the key server. The key server may either be:

- The Cisco Registered Envelope Service (managed service), or
- An Cisco Encryption appliance (locally managed server)

Next, you create content filters, message filters, and Data Loss Prevention policies to determine which messages to encrypt.

1. An outgoing message that meets the filter condition is placed in a queue on the appliance for encryption processing.
2. Once the message is encrypted, the key used to encrypt it is stored on the key server specified in the encryption profile and the encrypted message is queued for delivery.
3. If a temporary condition exists that prohibits the encryption of emails in the queue (i.e., temporary C-Series busyness or Cisco Secure Email Encryption Service unavailability), messages are re-queued and retried at a later time.



Note You can also set up the appliance to first attempt to send a message over a TLS connection before encrypting it. For more information, see [Using a TLS Connection as an Alternative to Encryption, on page 522](#).

How to Encrypt Messages with a Local Key Server

Table 42: How to Encrypt Messages with a Local Key Server

Steps	Do This	More Info
Step 1	Set up the Cisco IronPort Encryption appliance on the network.	See Setup and Installation , on page 17
Step 2	Enable message encryption.	Enabling Message Encryption on the Email Security Appliance , on page 518.
Step 3	Specify the encryption key server to use and the security settings for the encrypted messages by creating an encryption profile.	Configuring How a Key Service Handles Encrypted Messages , on page 518.
Step 4	Define the conditions that messages must meet in order for the appliance to encrypt them.	Determining Which Messages to Encrypt , on page 522.
Step 5	Determine when to encrypt messages in the email workflow.	<ul style="list-style-type: none"> • Encrypting and Immediately Delivering Messages using a Content Filter, on page 523. <p style="text-align: center;">or</p> <ul style="list-style-type: none"> • Encrypting a Message upon Delivery using a Content Filter, on page 524.
Step 6	(Optional) Flag messages for additional security.	Inserting Encryption Headers into Messages , on page 525.
Step 7	Define groups of users for whom you want to encrypt messages.	Create a mail policy. See Mail Policies , on page 257
Step 8	Associate the encryption actions that you defined with the user groups you defined.	Associate the content filter with the mail policy. See Mail Policies , on page 257

Related Topics

- [Encryption Workflow](#), on page 516

Encryption Workflow

When using email encryption, the appliance encrypts a message and stores the message key on a local key server or a hosted key service. When the recipient opens an encrypted message, the recipient is authenticated by the key service, and the decrypted message is displayed.

Figure 34: Encryption Workflow

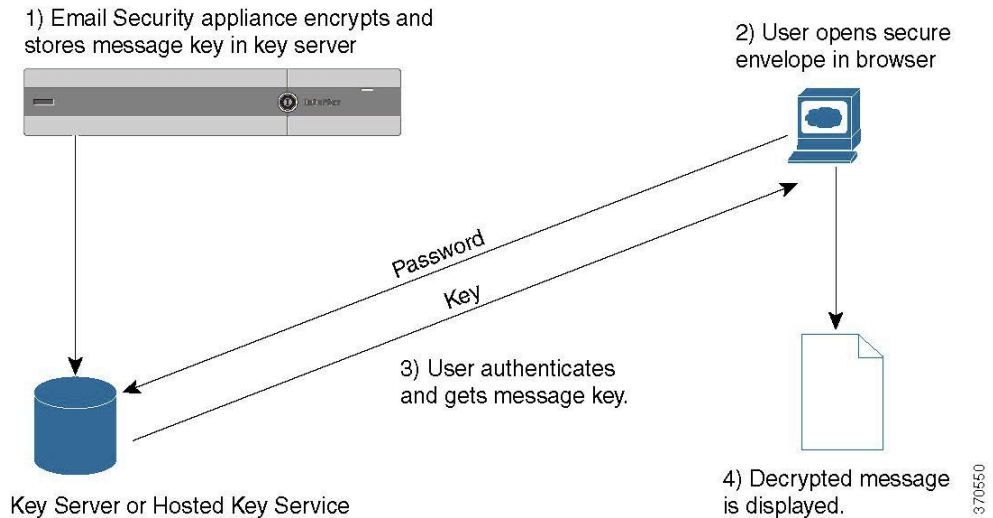

The basic workflow for opening encrypted messages is:

1. When you configure an encryption profile, you specify the parameters for message encryption. For an encrypted message, the appliance creates and stores a message key on a local key server or on the hosted key service (Cisco Registered Envelope Service).
2. The recipient opens the secure envelope in a browser.
3. When a recipient opens an encrypted message in a browser, a password may be required to authenticate the recipient's identity. The key server returns the encryption key associated with the message.



Note When opening an encrypted email message for the first time, the recipient is required to register with the key service to open the secure envelope. After registering, the recipient may be able to open encrypted messages without authenticating, depending on settings configured in the encryption profile. The encryption profile may specify that a password isn't required, but certain features will be unavailable.

4. The decrypted message is displayed.

Encrypting Messages using the Email Security Appliance

To use encryption with the appliance, you must configure an encryption profile. You can enable and configure an encryption profile using the `encryptionconfig` CLI command, or via Security Services > Cisco IronPort Email Encryption in the GUI.



Note If PXE and S/MIME encryption is enabled on the appliance, AsyncOS encrypts messages using S/MIME first, and then using PXE.

Related Topics

- [Enabling Message Encryption on the Email Security Appliance](#), on page 518

- [Configuring How a Key Service Handles Encrypted Messages, on page 518](#)
- [Configuring the Default Locale of the Envelope, on page 521](#)
- [Updating to the Latest Version of the PXE Engine, on page 522](#)

Enabling Message Encryption on the Email Security Appliance

Procedure

Step 1 Click **Security Services > Cisco IronPort Email Encryption**.

Step 2 Click **Enable**.

Step 3 (Optional) Click **Edit Settings** to configure the following options:

- The maximum message size to encrypt. Cisco's recommended message size is 10 MB. The maximum message size the appliance will encrypt is 25 MB.

Note Encrypting messages larger than the recommended 10 MB limit may slow down the performance of the appliance. If you are using the Cisco Registered Envelope Service, message recipients will be unable to reply to an encrypted message that has attachments larger than 10 MB.

- Email address of the encryption account administrator. When you provision an Encryption Profile, this email address is registered automatically with the encryption server.
- Configure a proxy server.

Configuring How a Key Service Handles Encrypted Messages

You can create one or more encryption profiles if you use a key service. You might want to create different encryption profiles if you want to use different levels of security for different groups of email. For example, you might want messages containing sensitive material to be sent with high security, but other messages to be sent with medium security. In this case, you might create a high security encryption profile to associate with the messages containing certain key words (such as 'confidential'), and create another encryption profile for other outgoing messages.

You can assign an encryption profile to a custom user role to allow delegated administrators assigned to that role to use the encryption profile with their DLP policies and content filters. Only administrators, operators, and delegated users can use encryption profiles when configuring DLP policies and content filters. Encryption profiles that are not assigned to a custom role are available for use by all delegated administrators with mail or DLP policy privileges. See [Distributing Administrative Tasks, on page 949](#) for more information.



Note You can configure multiple encryption profiles for a hosted key service. If your organization has multiple brands, this allows you to reference different logos stored on the key server for the PXE envelopes.

An encryption profile stores the following settings:

- **Key server settings.** Specify a key server and information for connecting to that key server.

- **Envelope settings.** Specify details about the message envelope, such as the level of security, whether to return read receipts, the length of time a message is queued for encryption before it times out, the type of encryption algorithm to use, and whether to enable a decryption applet to run on the browser.
- **Message settings.** Specify details about messages, such as whether to enable secure message forwarding and secure Reply All.
- **Notification settings.** Specify the notification template to use for text and HTML notifications, as well as encryption failure notifications. You create the templates in text resources and select the templates when creating the encryption profile. You can also localize envelopes and specify a message subject for encryption failure notifications. For more information about notifications, see [Encryption Notification Templates, on page 640](#) and [Bounce and Encryption Failure Notification Templates, on page 639](#).

Procedure

- Step 1** In the Email Encryption Profiles section, click **Add Encryption Profile**.
- Step 2** Enter a name for the Encryption Profile.
- Step 3** Click the **Used By (Roles)** link, select the custom user role you want to have access to the encryption profile, and click **OK**.
- Delegated administrators assigned to this custom role can use the encryption profile for any DLP policies and content filters for which they are responsible.
- Step 4** In the Key Server Settings section, select from the following key servers:
- Cisco Encryption appliance (in network)
 - Cisco Registered Envelope Service (hosted key service)
- Step 5** If you select the Cisco Encryption appliance (local key service), enter the following settings:
- **Internal URL.** This URL is used by the appliance to contact the in-network Cisco Encryption appliance.
 - **External URL.** This URL is used when the recipient's message accesses keys and other services on the Cisco Encryption appliance. The recipient uses this URL to make inbound HTTP or HTTPS requests.
- Step 6** If you select the Cisco Registered Envelope Service, enter the URL for the hosted key service. The key service URL is `https://res.cisco.com`.
- Step 7** Click **Advanced** under Key Server Settings to specify whether to use HTTP or HTTPS for transferring the envelope's encrypted payload when the recipient opens the envelope. Choose from one of the following:
- **Use the Key Service with HTTP.** Transfers the encrypted payload from the key service using HTTP when the recipient opens the envelope. If you are using Cisco Registered Envelope Service, this is the URL you specified in Step 6. If you are using the Cisco Encryption appliance, this is the external URL you specified in Step 5.
 - Since the payload is already encrypted, transporting it over HTTP is safe and faster than sending over HTTPS. This provides better performance than sending image requests over HTTPS.
 - **Use the Key Service with HTTPS.** Transfers the encrypted payload from the key service using HTTPS when the recipient opens the envelope. If you are using Cisco Registered Envelope Service, this is the URL you specified in Step 6. If you are using the Cisco Encryption appliance, this is the external URL you specified in Step 5.

- **Specify a separate URL for payload transport.** If you don't want to use the key server for your encrypted payload, you can use another URL and specify whether to use HTTP or HTTPS for the payload transfer.

Step 8 In the Envelope Settings section, select the level of message security:

- **High Security.** The recipient must always enter a passphrase to open encrypted messages.
- **Medium Security.** The recipient does not need to enter credentials to open the encrypted message if the recipient credentials are cached.
- **No Passphrase Required.** This is the lowest level of encrypted message security. The recipient does not need to enter a passphrase to open the encrypted message. You can still enable the read receipts, Secure Reply All, and Secure Message Forwarding features for envelopes that are not passphrase-protected.

Step 9 To enable users to open your organization's URL by clicking its logo, you can add a link to the logo. Choose from the following options:

- **No link.** A live link is not added to the message envelope.
- **Custom link URL.** Enter the URL to add a live link to the message envelope.

Step 10 (Optional) Enable read receipts. If you enable this option, the sender receives a receipt when recipients open the secure envelope.

Step 11 (Optional) Click **Advanced** under Envelope Settings to configure the following settings:

- Enter the length of time (in seconds) that a message can be in the encryption queue before timing out. Once a message times out, the appliance bounces the message and sends a notification to the sender.
- Select an encryption algorithm - 'AES 192' or 'AES 256.'

Note AES provides stronger encryption but also takes longer to decrypt, introducing delays for recipients. AES is typically used in government and banking applications.

- Enable or disable the decryption applet. Enabling this option causes the message attachment to be opened in the browser environment. Disabling this option causes message attachments to be decrypted at the key server. If you disable this option, messages may take longer to open, but are not dependent on the browser environment.

Step 12 In the Message Settings section, do the following:

- To enable secure reply all feature, check the **Enable Secure Reply All** check box.
- To enable secure message forwarding feature, check the **Enable Secure Message Forwarding** check box.

Step 13 (Optional) If you have selected Cisco Registered Envelope Service and this service supports localization of envelopes, enable localization of envelopes. In Notification Settings section, check the **Use Localized Envelope** check box.

Note If you enable localization of envelopes, you cannot select encrypted message HTML or text notification.

If you want to set the default locale of the envelope, see [Configuring the Default Locale of the Envelope, on page 521](#).

Step 14 Select the HTML and text notification templates.

Note The key server uses an HTML or text notification based on the recipient's email application. You must configure notifications for both.

Do the following:

- a) Select an HTML notification template. Choose from HTML notifications you configured in text resources. If you did not configure a template, the system uses the default template.
- b) Select a text notification template. Choose from text notifications you configured in text resources. If you did not configure a template, the system uses the default template.

Note These options are unavailable if you use localized envelopes.

- Step 15** Enter a subject header for encryption failure notifications. The appliance sends a notification if the encryption process times out.
- Step 16** Select an encryption failure notification template for the message body. Choose from an encryption failure notification template you configured in text resources. If you did not configure a template, the system uses the default template.
- Step 17** Submit and commit your changes.
- Step 18** If you use Cisco Registered Envelope Service, you must take the additional step of provisioning your appliance. Provisioning the appliance registers the encryption profile with the hosted key service. To provision the appliance, click the **Provision** button for the encryption profile you want to register.
-

Configuring the Default Locale of the Envelope

The default locale of the envelope is English. If you have selected Cisco Registered Envelope Service and this service supports localization of envelopes, you can change the locale of the envelope to any one of the following:

- English
- French
- German
- Japanese
- Portuguese
- Spanish
- Italian
- Korean
- Dutch
- Polish
- Russian
- Chinese

Before You Begin

- Create an encryption profile with Cisco Registered Envelope Service as Key Service Type and envelope localization enabled. See [Configuring How a Key Service Handles Encrypted Messages, on page 518](#).
- Make sure that Cisco Registered Envelope Service supports localization of envelopes.

Procedure

- Step 1** Click **Security Services > Cisco IronPort Email Encryption**.
 - Step 2** Open an existing encryption profile.
 - Step 3** In the **Notification Settings** section, choose the locale from the **Localized Envelopes** drop-down list.
 - Step 4** Click **Submit**.
 - Step 5** Click **Commit Changes**.
-

Updating to the Latest Version of the PXE Engine

The Cisco Email Encryption Settings page displays the current versions of the PXE engine and the Domain Mappings file used by your appliance . You can use the **Security Services > Service Updates** page (or the `updateconfig` command in the CLI) to configure the appliance to automatically update the PXE engine. For more information, see [Service Updates , on page 1003](#).

You can also manually update the engine using the **Update Now** button of the PXE Engine Updates section of IronPort Email Encryption Settings page (or the `encryptionupdate` command in the CLI).

Determining Which Messages to Encrypt

After you create an encryption profile, you need to create an outgoing content filter that determines which email messages should be encrypted. The content filter scans outgoing email and determines if the message matches the conditions specified. Once the content filter determines a message matches the condition, the appliance encrypts the message and sends the generated key to the key server. It uses settings specified in the encryption profile to determine the key server to use and other encryption settings.

You can also encrypt messages after they are released after Data Loss Prevention scanning. For more information, see [Defining Actions to Take for DLP Violations \(Message Actions\) , on page 507](#).

Related Topics

- [Using a TLS Connection as an Alternative to Encryption, on page 522](#)
- [Encrypting and Immediately Delivering Messages using a Content Filter, on page 523](#)
- [Encrypting a Message upon Delivery using a Content Filter, on page 524](#)

Using a TLS Connection as an Alternative to Encryption

Based on the destination controls specified for a domain, your appliance can securely relay a message over a TLS connection instead of encrypting it, if a TLS connection is available. The appliance decides whether to encrypt the message or send it over a TLS connection based on the TLS setting in the destination controls (Required, Preferred, or None) and the action defined in the encryption content filter.

When creating the content filter, you can specify whether to always encrypt a message or to attempt to send it over a TLS connection first, and if a TLS connection is unavailable, to encrypt the message. The following table shows you how an appliance will send a message based on the TLS settings for a domain's destination controls, if the encryption control filter attempts to send the message over a TLS connection first.

Table 43: TLS Support on ESA Appliances

Destination Controls TLS Setting	Action if TLS Connection Available	Action if TLS Connection Unavailable
None	Encrypt envelope and send	Encrypt envelope and send
TLS Preferred	Send over TLS	Encrypt envelope and send
TLS Required	Send over TLS	Retry/bounce message

For more information about enabling TLS on destination controls, see [Configuring the Gateway to Receive Email](#), on page 69.

Encrypting and Immediately Delivering Messages using a Content Filter

Before You Begin

- To understand the concept of building conditions for content filters, see [Overview of Content Filters](#), on page 271.
- (Optional) See [Inserting Encryption Headers into Messages](#), on page 525.

Procedure

-
- Step 1** Go to **Mail Policies > Outgoing Content Filters**.
 - Step 2** In the Filters section, click **Add Filter**.
 - Step 3** In the Conditions section, click **Add Condition**.
 - Step 4** Add a condition to filter the messages that you want to encrypt. For example, to encrypt sensitive material, you might add a condition that identifies messages containing particular words or phrases, such as “Confidential,” in the subject or body.
 - Step 5** Click **OK**.
 - Step 6** Optionally, click **Add Action** and select **Add Header** to insert an encryption header into the messages to specify an additional encryption setting.
 - Step 7** In the Actions section, click **Add Action**.
 - Step 8** Select **Encrypt and Deliver Now (Final Action)** from the **Add Action** list.
 - Step 9** Select whether to always encrypt messages that meet the condition or to only encrypt messages if the attempt to send it over a TLS connection fails.
 - Step 10** Select the encryption profile to associate with the content filter.

The encryption profile specifies settings about the key server to use, levels of security, formatting of the message envelope, and other message settings. When you associate an encryption profile with the content filter, the content filter uses these stored settings to encrypt messages.
 - Step 11** Enter a subject for the message.

Step 12 Click **OK**.

The content filter in the following figure shows a content filter that searches for ABA content in the message body. The action defined for the content filter specifies that the email is encrypted and delivered.

Figure 35: Encryption Content Filter

Content Filter Settings

Name: sensitive_content

Currently Used by Policies: No policies currently use this rule.

Description: encrypt messages that contain sensitive material

Order: 2 (of 2)

Conditions

Order	Condition	Rule	Delete
1	Message Body	only-body-contains("*aba", 1)	

Actions

Order	Action	Rule	Delete
1	Encrypt and Deliver (Final Action)	encrypt("encrypt_sensitive", "\$Subject")	

Cancel Submit

Step 13 After you add the encrypt action, click **Submit**.

Step 14 Commit your changes.

What to do next

After you add the content filter, you need to add the filter to an outgoing mail policy. You may want to enable the content filter on the default policy, or you may choose to apply the filter to a specific mail policy, depending on your organization's needs. For information about working with mail policies, see [Overview of Mail Policies](#), on page 257.

Encrypting a Message upon Delivery using a Content Filter

Create a content filter to encrypt a message on delivery, which means that the message continues to the next stage of processing, and when all processing is complete, the message is encrypted and delivered.

Before You Begin

- To understand the concept of building conditions for content filters, see [Overview of Content Filters](#), on page 271.
- (Optional) See [Inserting Encryption Headers into Messages](#), on page 525.

Procedure

Step 1 Go to **Mail Policies > Outgoing Content Filters**.

Step 2 In the Filters section, click **Add Filter**.

Step 3 In the Conditions section, click **Add Condition**.

Step 4 Add a condition to filter the messages that you want to encrypt. For example, to encrypt sensitive material, you might add a condition that identifies messages containing particular words or phrases, such as "Confidential," in the subject or body.

- Step 5** Click **OK**.
- Step 6** Optionally, click **Add Action** and select **Add Header** to insert an encryption header into the messages to specify an additional encryption setting.
- Step 7** In the Actions section, click **Add Action**.
- Step 8** Select **Encrypt on Delivery** from the **Add Action** list.
- Step 9** Select whether to always encrypt messages that meet the condition or to only encrypt messages if the attempt to send it over a TLS connection fails.
- Step 10** Select the encryption profile to associate with the content filter.
- The encryption profile specifies settings about the key server to use, levels of security, formatting of the message envelope, and other message settings. When you associate an encryption profile with the content filter, the content filter uses these stored settings to encrypt messages.
- Step 11** Enter a subject for the message.
- Step 12** Click **OK**.
- Step 13** After you add the encrypt action, click **Submit**.
- Step 14** Commit your changes.

What to do next

After you add the content filter, you need to add the filter to an outgoing mail policy. You may want to enable the content filter on the default policy, or you may choose to apply the filter to a specific mail policy, depending on your organization's needs. For information about working with mail policies, see [Overview of Mail Policies, on page 257](#).

Inserting Encryption Headers into Messages

AsyncOS enables you to add encryption settings to a message by inserting an SMTP header into a message using either a content filter or a message filter. The encryption header can override the encryption settings defined in the associated encryption profile, and it can apply specified encryption features to messages.



Note The Cisco Ironport Encryption appliance must be set up to handle flagged messages.

Procedure

- Step 1** Go to **Mail Policies > Outgoing Content Filters** or **Incoming Content Filters**.
- Step 2** In the Filters section, click **Add Filter**.
- Step 3** In the Actions section, click **Add Action** and select **Add/Edit Header** to insert an encryption header into the messages to specify an additional encryption setting.

For example, if you want a Registered Envelope to expire in 24 hours after you send it, type X-PostX-ExpirationDate as the header name and +24:00:00 as the header value.

What to do next**Related Topics**

- [Encryption Headers, on page 526](#)
- [Encryption Headers Examples, on page 527](#)
- For more information about creating an encryption content filter, see [Encrypting and Immediately Delivering Messages using a Content Filter, on page 523](#).
- For information about inserting a header using a message filter, see [Using Message Filters to Enforce Email Policies, on page 131](#).

Encryption Headers

The following table displays the encryption headers that you can add to messages.

Table 44: Email Encryption Headers

MIME Header	Description	Value
X-PostX-Reply-Enabled	Indicates whether to enable secure reply for the message and displays the Reply button in the message bar. This header adds an encryption setting to the message.	A Boolean for whether to display the Reply button. Set to true to display the button. The default value is false .
X-PostX-Reply-All-Enabled	Indicates whether to enable secure “reply all” for the message and displays the Reply All button in the message bar. This header overrides the default profile setting.	A Boolean for whether to display Reply All button. Set to true to display the button. The default value is false .
X-PostX-Forward-Enabled	Indicates whether to enable secure message forwarding and displays the Forward button in the message bar. This header overrides the default profile setting.	A Boolean for whether to display the Forward button. Set to true to display the button. The default value is false .
X-PostX-Send-Return-Receipt	Indicates whether to enable read receipts. The sender receives a receipt when recipients open the Secure Envelope. This header overrides the default profile setting.	A Boolean for whether to send a read receipt. Set to true to display the button. The default value is false .
X-PostX-Expiration Date	<p>Defines a Registered Envelope’s expiration date before sending it. The key server restricts access to the Registered Envelope after the expiration date. The Registered Envelope displays a message indicating that the message has expired. This header adds an encryption setting to the message.</p> <p>If you use Cisco Registered Envelope Service, you can log in to the website at http://res.cisco.com and use the message management features to set, adjust, or eliminate the expiration dates of messages after you send them.</p>	A string value containing relative date or time. Use the +HH:MM:SS format for relative hours, minutes, and seconds, and the +D format for relative days. By default, there is no expiration date.

MIME Header	Description	Value
X-PostX-ReadNotification-Date	Defines the Registered Envelope's "read by" date before sending it. The local key server generates a notification if the Registered Envelope has not been read by this date. Registered Envelopes with this header do not work with Cisco Registered Envelope Service, only a local key server. This header adds an encryption setting to the message.	A string value containing relative date or time. Use the +HH:MM:SS format for relative hours, minutes, and seconds, and the +D format for relative days. By default, there is no expiration date.
X-PostX-Suppress-Applet-For-Open	Indicates whether to disable the decryption applet. The decryption applet causes message attachments to be opened in the browser environment. Disabling the applet causes the message attachment to be decrypted at the key server. If you disable this option, messages may take longer to open, but they are not dependent on the browser environment. This header overrides the default profile setting.	A Boolean for whether to disable the decryption applet. Set to true to disable the applet. The default value is false .
X-PostX-Use-Script	Indicates whether to send JavaScript-free envelopes. A JavaScript-free envelope is a Registered Envelope that does not include the JavaScript that is used to open envelopes locally on the recipient's computer. The recipient must use either the Open Online method or the Open by Forwarding method to view the message. Use this header if a recipient domain's gateway strips JavaScript and makes the encrypted message unopenable. This header adds an encryption setting to the message.	A Boolean for whether the JavaScript applet should be included or not. Set to false to send a JavaScript-free envelope. The default value is true .
X-PostX-Remember-Envelope-Key-Checkbox	Indicates whether to allow envelope-specific key caching for offline opening of envelopes. With envelope key caching, the decryption key for a particular envelope is cached on the recipient's computer when the recipient enters the correct passphrase and selects the "Remember the password for this envelope" check box. After that, the recipient does not need to enter a passphrase again to reopen the envelope on the computer. This header adds an encryption setting to the message.	A Boolean for whether to enable envelope key caching and display the "Remember the password for this envelope" check box. The default value is false .

Encryption Headers Examples

This section provides examples of encryption headers.

Related Topics

- [Enabling JavaScript-Free Envelopes, on page 528](#)
- [Enabling Envelope Key Caching for Offline Opening, on page 528](#)
- [Enabling Message Expiration, on page 528](#)

- [Disabling the Decryption Applet, on page 528](#)

Enabling Envelope Key Caching for Offline Opening

To send a Registered Envelope with envelope key caching enabled, insert the following header into the message:

```
X-PostX-Remember-Envelope-Key-Checkbox: true
```

The “Remember the password for this envelope” check box is displayed on the Registered Envelope.

Enabling JavaScript-Free Envelopes

To send a Registered Envelope that is JavaScript-free, insert the following header into the message:

```
X-PostX-Use-Script: false
```

When the recipient opens the securedoc.html attachment, the Registered Envelope is displayed with an Open Online link, and the Open button is disabled.

Enabling Message Expiration

To configure a message so that it expires 24 hours after you send it, insert the following header into the message:

```
X-PostX-ExpirationDate: +24:00:00
```

The recipient can open and view the content of the encrypted message during the 24-hour period after you send it. After that, the Registered Envelope displays a message indicating that the envelope has expired.

Disabling the Decryption Applet

To disable the decryption applet and have the message attachment decrypted at the key server, insert the following header into the message:

```
X-PostX-Suppress-Applet-For-Open: true
```



Note

The message may take longer to open when you disable the decryption applet, but it is not dependent on the browser environment.



CHAPTER 23

S/MIME Security Services

This chapter contains the following sections:

- [Overview of S/MIME Security Services, on page 529](#)
- [S/MIME Security Services in Email Security Appliance , on page 529](#)
- [Signing, Encrypting, or Signing and Encrypting Outgoing Messages using S/MIME, on page 533](#)
- [Verifying, Decrypting, or Decrypting and Verifying Incoming Messages using S/MIME, on page 543](#)
- [S/MIME Certificate Requirements, on page 549](#)
- [Managing Public Keys, on page 550](#)

Overview of S/MIME Security Services

Secure/Multipurpose Internet Mail Extensions (S/MIME) is a standards-based method for sending and receiving secure, verified email messages. S/MIME uses public/private key pair to encrypt or sign messages. This way,

- If the message is encrypted, only the message recipient can open the encrypted message.
- If the message is signed, the message recipient can validate the identity of the sender's domain and can be assured that the message has not been altered while in transit.

For more information about S/MIME, review the following RFCs:

- RFC 5750: Secure/Multipurpose Internet Mail Extensions (S/MIME) Version 3.2 - Certificate Handling
- RFC 5751: Secure/Multipurpose Internet Mail Extensions (S/MIME) Version 3.2 - Message Specification
- RFC 3369: Cryptographic Message Syntax

S/MIME Security Services in Email Security Appliance

Organizations may want to communicate securely using S/MIME without requiring that all end users possess their own certificates. For such organizations, the appliance supports S/MIME security services (signing, encryption, verification, and decryption) at the gateway level using certificates that identify the organization rather than the individual user.

The appliance provides the following S/MIME security services for Business-to-Business (B2B) and Business-to-Consumer (B2C) scenarios:

- Sign, encrypt, or sign and encrypt messages using S/MIME. See [Signing, Encrypting, or Signing and Encrypting Outgoing Messages using S/MIME, on page 533](#).

- Verify, decrypt, or decrypt and verify messages using S/MIME. See [Verifying, Decrypting, or Decrypting and Verifying Incoming Messages using S/MIME](#), on page 543.

Related Topics

- [Understanding How S/MIME Security Services Works](#), on page 530

Understanding How S/MIME Security Services Works

- [Scenario: Business-to-Business](#), on page 530
- [Scenario: Business-to-Consumer](#), on page 532

Scenario: Business-to-Business

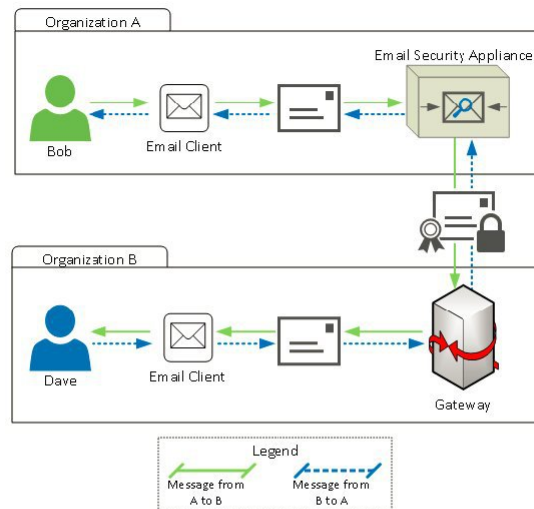

Organizations A and B want all the messages communicated between them to be signed and encrypted using S/MIME. Organization A has configured Email Security appliance to perform S/MIME security services at the gateway level. Organization B has configured a third-party application to perform S/MIME security services at the gateway level.



Note The current example assumes that organization B is using a third-party application to perform S/MIME security services. In the real world, this can be any application or appliance (including Email Security appliance) that can perform S/MIME security services at the gateway level.

Organization A sending a message to Organization B:

1. Bob (Organization A) uses an email client to send an unsigned and unencrypted message to Dave (Organization B).
2. Email Security appliance in the Organization A signs and encrypts the messages and sends it to Organization B.
3. The third-party application at the gateway of Organization B decrypts and verifies the message.
4. Dave receives an unencrypted and signed message.

Organization B sending a message to Organization A:

1. Dave (Organization B) uses an email client to send an unsigned and unencrypted message to Bob (Organization A).
2. The third-party application at the gateway of Organization B signs and encrypts the message and sends it to Organization A.
3. Email Security appliance in the Organization A decrypts and verifies the message.
4. Bob receives an unencrypted and signed message.

Scenario: Business-to-Consumer

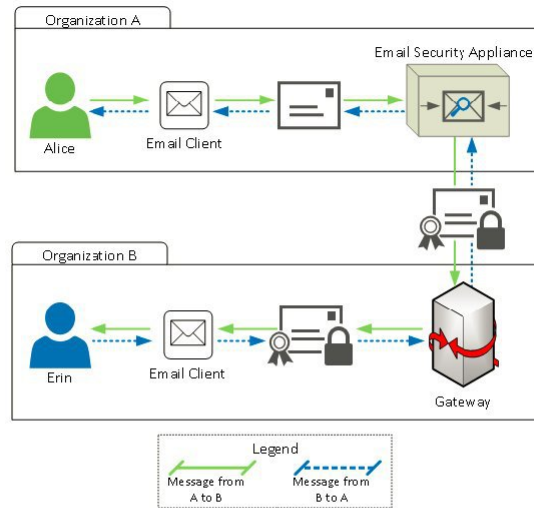

Organizations A and B want all the messages communicated between them to be signed and encrypted using S/MIME. Organization A has configured Email Security appliance to perform S/MIME security services at the gateway level. Organization B has configured the email clients of all the users to perform S/MIME security services.

Organization A sending a message to Organization B:

1. Alice (Organization A) uses an email client to send an unsigned and unencrypted message to Erin (Organization B).
2. Email Security appliance in the Organization A signs and encrypts the messages and sends it to Organization B.
3. The email client in the Organization B decrypts and verifies the message and displays it to Erin.

Organization B sending a message to Organization A:

1. Erin (Organization B) uses the email client to sign and encrypt a message and sends it to Alice (Organization A).
2. Email Security appliance in the Organization A decrypts and verifies the message.
3. Alice receives an unencrypted and unsigned message.

Signing, Encrypting, or Signing and Encrypting Outgoing Messages using S/MIME

- [S/MIME Signing and Encryption Workflow in Email Security Appliance](#) , on page 533
- [How to Sign, Encrypt, or Sign and Encrypt Outgoing Messages using S/MIME](#), on page 534
- [Setting Up Certificates for S/MIME Signing](#), on page 535
- [Setting Up Public Keys for S/MIME Encryption](#), on page 537
- [Managing S/MIME Sending Profiles](#), on page 539
- [Determining Which Messages to Sign, Encrypt, or Sign and Encrypt](#), on page 541
- [Signing, Encrypting, or Signing and Encrypting and Immediately Delivering Messages using a Content Filter](#), on page 542
- [Signing, Encrypting, or Signing and Encrypting a Message upon Delivery using a Content Filter](#), on page 542



Note You can use the appliance to sign, encrypt, and sign and encrypt outgoing and incoming messages.

S/MIME Signing and Encryption Workflow in Email Security Appliance

- [S/MIME Signing Workflow](#), on page 533
- [S/MIME Encryption Workflow](#), on page 533

S/MIME Signing Workflow

The following process describes how the appliance performs S/MIME signing.

1. Apply a hash algorithm to the message to create a message digest.
2. Encrypt the message digest using private key of the appliance's S/MIME certificate.
3. Create a PKCS7 signature with the encrypted message digest and public key of the appliance's S/MIME certificate.
4. Sign the message by attaching the PKCS7 signature to the message.
5. Send the signed message to the recipient.

S/MIME Encryption Workflow

The following process describes how the appliance performs S/MIME encryption.

1. Create a pseudo-random session key.
2. Encrypt the message body using the session key.
3. Encrypt the session key using the public key of the recipient's (gateway or consumer) S/MIME certificate.
4. Attach the encrypted session key to the message.
5. Send the encrypted message to the recipient.



Note If PXE and S/MIME encryption is enabled on the appliance, it encrypts messages using S/MIME first, and then using PXE.

How to Sign, Encrypt, or Sign and Encrypt Outgoing Messages using S/MIME

Steps	Do This	More Info
Step 1	Understand the S/MIME certificate requirements.	See S/MIME Certificate Requirements , on page 549.
Step 2	Depending on your requirements, do one of the following: <ul style="list-style-type: none"> For S/MIME signing, set up an S/MIME signing certificate. For S/MIME encryption, set up the public key of the recipient's S/MIME certificate. For S/MIME signing and encryption, set up an S/MIME signing certificate and the public key of the recipient's S/MIME certificate, respectively. 	See: <ul style="list-style-type: none"> Setting Up Certificates for S/MIME Signing, on page 535 Setting Up Public Keys for S/MIME Encryption, on page 537
Step 3	Create a profile for signing, encrypting, or signing and encrypting messages.	See Create an S/MIME Sending Profile for Signing, Encrypting, or Signing and Encrypting Messages , on page 540.
Step 4	Define the conditions that messages must meet in order for the appliance to sign, encrypt, or sign and encrypt them.	See Determining Which Messages to Sign, Encrypt, or Sign and Encrypt , on page 541.
Step 5	Determine when in the email workflow to sign, encrypt, or sign and encrypt messages.	See: <ul style="list-style-type: none"> Signing, Encrypting, or Signing and Encrypting and Immediately Delivering Messages using a Content Filter, on page 542 Signing, Encrypting, or Signing and Encrypting a Message upon Delivery using a Content Filter, on page 542
Step 6	Define groups of users for whom you want to sign or encrypt messages.	Create a mail policy. See Mail Policies , on page 257
Step 7	Associate the signing or encryption actions that you defined with the user groups you defined.	Associate the content filter with the mail policy. See Mail Policies , on page 257



Note If you want to perform S/MIME signing, encryption, or signing and encryption using CLI, use the `smimeconfig` command. See *CLI Reference Guide for AsyncOS for Cisco Email Security Appliances*.

Setting Up Certificates for S/MIME Signing

You must set up an S/MIME certificate for signing messages. The appliance allows you to set up S/MIME signing certificates using one of the following methods:

- Create a self-signed S/MIME certificate using the appliance. See [Creating a Self-Signed S/MIME Certificate, on page 535](#).
- Import an existing S/MIME certificate to the appliance. See [Importing an S/MIME Signing Certificate, on page 536](#).



Note Cisco recommends that you use self-signed S/MIME certificates for sending signed messages to the users within your organization or in a testing environment. For sending signed messages to external users or in a production environment, use a valid S/MIME certificate obtained from a trusted CA.

For understanding the certificate requirements for S/MIME, see [S/MIME Certificate Requirements, on page 549](#).

Creating a Self-Signed S/MIME Certificate

You can generate self-signed S/MIME certificates that are compliant to RFC 5750 (Secure/Multipurpose Internet Mail Extensions (S/MIME) Version 3.2 - Certificate Handling) using the web interface or CLI.



Note Cisco recommends that you use self-signed S/MIME certificates for sending signed messages to the users within your organization or in a testing environment.

Procedure

- Step 1** Click **Network > Certificates**.
- Step 2** Click **Add Certificate**.
- Step 3** Choose **Create Self-Signed S/MIME Certificate**.
- Step 4** Enter the following information for the self-signed certificate:

Common Name	The fully qualified domain name.
Organization	The exact legal name of the organization.
Organizational Unit	Section of the organization.
City (Locality)	The city where the organization is legally located.

Common Name	The fully qualified domain name.
State (Province)	The state, county, or region where the organization is legally located.
Country	The two letter ISO abbreviation of the country where the organization is legally located.
Duration before expiration	The number of days before the certificate expires.
Subject Alternative Name(Domains)	If you configure this field, any user from the specified domain can send signed messages. Name of the domain from which you plan to send signed messages. Examples include domain.com and *.domain.net . For multiple entries, use a comma-separated list.
Subject Alternative Name(Email)	If you configure this field, only the specified users can send signed messages. Email address of the user who is planning to send signed messages, for example, user@somedomain.com . For multiple entries, use a comma-separated list.
Private Key Size	Size of the private key to generate the certificate signing request (CSR).

Note An S/MIME signing certificate can contain both Subject Alternative Name (Domains) and Subject Alternative Name (Email).

Step 5 Click **Next** to view the certificate and signature information.

Step 6 Depending on your requirements, do the following:

- Enter a name for the certificate.
- If you want to submit a CSR for the self-signed certificate to a certificate authority, click **Download Certificate Signing Request** to save the CSR in PEM format to a local or network machine.

Step 7 Submit and commit your changes.

What to do next



Note Use the `certconfig` command to generate self-signed S/MIME certificates using CLI.

Importing an S/MIME Signing Certificate

If you already have an S/MIME certificate for signing messages, you can add it to the appliance by importing it.

Before You Begin

Make sure that the S/MIME certificate that you plan to import meets the requirements described in [S/MIME Certificate Requirements, on page 549](#).

Procedure

- Step 1** Click **Network > Certificates**.
 - Step 2** Click **Add Certificate**.
 - Step 3** Choose **Import Certificate**.
 - Step 4** Enter the path to the certificate file on your network or local machine.
 - Step 5** Enter the passphrase for the file.
 - Step 6** Click **Next** to view the certificate's information.
 - Step 7** Enter a name for the certificate.
 - Step 8** Submit and commit your changes.
-

What to do next



Note Use the `certconfig` command to import S/MIME certificates using CLI.

Setting Up Public Keys for S/MIME Encryption

You must add the public key of the recipient's S/MIME certificate to the appliance for encrypting messages. Depending on your organizational policies and processes, you can use one of the following methods to add the public key to the appliance :

- Request the recipient to send the public key using an electronic channel, for example, email. You can then add the public key using the web interface or CLI.

For instructions to add the public key, see [Adding a Public Key for S/MIME Encryption, on page 537](#).

- Enable public key harvesting using the web interface or CLI and request the recipient to send a signed message. The Email Security appliance can harvest the public key from the signed message.

For instructions to harvest public key from an incoming signed message, see [Harvesting Public Keys, on page 538](#).

Adding a Public Key for S/MIME Encryption

Before You Begin

- Make sure that the public key meets the requirements described in [S/MIME Certificate Requirements, on page 549](#).
- Make sure that the public key is in PEM format.

Procedure

- Step 1** Click **Mail Policies > Public Keys**.
 - Step 2** Click **Add Public Key**.
 - Step 3** Enter the name of the public key.
 - Step 4** Enter the public key.
 - Step 5** Submit and commit your changes.
-

What to do next



Note Use the `smimeconfig` command to add public keys using CLI.

S/MIME Harvested Public Keys

You can configure the appliance to retrieve (harvest) public keys from the incoming S/MIME signed messages and use the harvested keys to send encrypted messages to the owners (business or consumer) of the harvested keys.

Public key harvesting can be enabled on the Mail Flow Policies. All the harvested public keys are listed on the S/MIME Harvested Public Keys page.

Related Topic

- [Harvesting Public Keys, on page 538](#)

Harvesting Public Keys

You can configure the appliance to retrieve (harvest) public key from the incoming S/MIME signed messages and use it to send encrypted messages to the owner (business or consumer) of the harvested key.



Note By default, public keys from expired or self-signed S/MIME certificates are not harvested.

Before You Begin

Make sure that the public key of the sender's S/MIME certificate meets the requirements described in [S/MIME Certificate Requirements, on page 549](#).

Procedure

- Step 1** Click **Mail Policies > Mail Flow Policies**.
- Step 2** Create a new Mail Flow Policy or modify an existing one.
- Step 3** Scroll down to the **Security Features** section.
- Step 4** Under S/MIME Public Key Harvesting, do the following:

- Enable S/MIME public key harvesting.
- (Optional) Choose whether to harvest public keys if the verification of the incoming signed messages fail.
- (Optional) Choose whether to harvest updated public keys.

Note If an appliance receives more than one updated public key from the same domain or message within 48 hours, it sends out a warning alert.

Step 5 Submit and commit your changes.

What to do next



Note The size of the harvested public key repository on the appliance is 512 MB. If repository is full, the appliance will automatically remove unused public keys.

Use the `listenerconfig` command to enable key harvesting using CLI.

Next Step

Request the recipient to send a signed message to the appliance administrator. The appliance will harvest the public key from the signed message and displays it on the Mail Policies > Harvested Public Keys page.

Related Topics

- [S/MIME Harvested Public Keys, on page 538](#)

Managing S/MIME Sending Profiles

An S/MIME sending profile allows you define parameters such as:

- S/MIME mode to use, for example, sign, encrypt, and so on.
- S/MIME certificate for signing
- S/MIME signing mode to use, for example, opaque or detached.
- Action to take if the public key of the recipient's S/MIME certificate is not available on the appliance .

For example, one organization requires all the messages sent to them be signed and another one requires all the messages sent to them be signed and encrypted. In this scenario, you must create two sending profiles, one for signing alone and one for signing and encryption.

You can create, edit, delete, import, export, and search S/MIME sending profiles using the web interface or CLI.

Related Topics

- [Create an S/MIME Sending Profile for Signing, Encrypting, or Signing and Encrypting Messages, on page 540](#)
- [Edit an S/MIME Sending Profile, on page 541](#)

Create an S/MIME Sending Profile for Signing, Encrypting, or Signing and Encrypting Messages

Procedure

Step 1 Click **Mail Policies > Sending Profiles**.

Step 2 Click **Add Profile**.

Step 3 Configure the following fields:

S/MIME Profile Name	Enter the name of the sending profile.
S/MIME Mode	<p>Choose the S/MIME mode. Possible values are:</p> <ul style="list-style-type: none"> • Sign • Encrypt • Sign/Encrypt. Sign and then encrypt • Triple. Sign, encrypt, and then sign again <p>Note If you are using one of the following S/MIME modes: Sign, Sign/Encrypt, or Triple, messages will be bounced to the sender if the signing fails.</p>
Signing Certificate	<p>Choose the signing certificate to use.</p> <p>Note You need to set this field only if you choose one of the following S/MIME modes: Sign, Sign/Encrypt, or Triple.</p>
S/MIME Sign Mode	<p>Choose the mode of S/MIME signing. Possible values are:</p> <ul style="list-style-type: none"> • Opaque. An opaque-signed message contains the message and signature combined in a single part and can be read only by verifying the signature. • Detached. The signature information is separate from the text being signed. The MIME type for this is multipart/signed with the second part having a MIME subtype of application/(x-)pkcs7-signature. <p>Note You need to set this field only if you choose one of the following S/MIME modes: Sign, Sign/Encrypt, or Triple.</p>

S/MIME Profile Name	Enter the name of the sending profile.
S/MIME Action	<p>Choose the action that the appliance must take if the recipient's public key is not available. Possible values are:</p> <ul style="list-style-type: none"> • Bounce. The message is bounced to the sender if any one of the recipient's public key is not available. • Drop. The message is dropped if any one of the recipient's public key is not available. • Split. The message is split. The message to the recipients whose public keys are not available are delivered without encryption and the message to the recipients whose public keys are available are encrypted and delivered. <p>Example: Assume that you are sending a message to bob@example1.com and dave@example2.com and the public key of dave@example2.com is not available. In this scenario, if you have selected Split, the appliance will:</p> <ul style="list-style-type: none"> • Deliver the message to bob@example1.com after encrypting it. • Deliver the message to dave@example2.com without encrypting it. <p>Note You need to set this field only if you choose one of the following S/MIME modes: Encrypt, Sign/Encrypt, or Triple.</p>

Step 4 Submit and commit your changes.

What to do next



Note Use the `smimeconfig` command to create sending profiles using CLI.

Edit an S/MIME Sending Profile

Procedure

- Step 1** Click **Mail Policies > Sending Profiles**.
 - Step 2** Click on the sending profile that you want to modify.
 - Step 3** Edit the fields as described in [Create an S/MIME Sending Profile for Signing, Encrypting, or Signing and Encrypting Messages, on page 540](#).
 - Step 4** Submit and commit your changes.
-

Determining Which Messages to Sign, Encrypt, or Sign and Encrypt

After you create a sending profile, you need to create an outgoing content filter that determines which email messages should be signed, encrypted, or signed and encrypted. The content filter scans outgoing email and

determines if the message matches the conditions specified. Once the content filter determines a message matches the condition, the appliance signs, encrypts, or signs or encrypts the message.

Related Topics

- [How to Filter Messages Based on Content, on page 289](#)

Signing, Encrypting, or Signing and Encrypting and Immediately Delivering Messages using a Content Filter

Before You Begin

Understand the concept of building conditions for content filters. See [How Content Filters Work, on page 271](#).

Procedure

- Step 1** Go to **Mail Policies > Outgoing Content Filters**.
- Step 2** In the Filters section, click **Add Filter**.
- Step 3** In the Conditions section, click **Add Condition**.
- Step 4** Add a condition to filter the messages that you want to sign, encrypt, or sign and encrypt. For example, to encrypt sensitive material, you might add a condition that identifies messages containing particular words or phrases, such as “Confidential,” in the subject or body.
- Step 5** Click **OK**.
- Step 6** In the Actions section, click **Add Action**.
- Step 7** Select **S/MIME Sign/Encrypt (Final Action)** from the **Add Action** list.
- Step 8** Select the sending profile to associate with the content filter.
- Step 9** Click **OK**.
- Step 10** Submit and commit your changes.
-

What to do next

After you add the content filter, you need to add the filter to an outgoing mail policy. You may want to enable the content filter on the default policy, or you may choose to apply the filter to a specific mail policy, depending on your organization’s needs. For information about working with mail policies, see [Overview of Mail Policies, on page 257](#).

Signing, Encrypting, or Signing and Encrypting a Message upon Delivery using a Content Filter

Create a content filter to sign, encrypt, or sign and encrypt a message on delivery, which means that the message continues to the next stage of processing, and when all processing is complete, the message is signed, encrypted, or signed and encrypted, and delivered.

Before You Begin

- Understand the concept of building conditions for content filters. See [Overview of Content Filters](#) , on page 271.

Procedure

- Step 1** Go to **Mail Policies > Outgoing Content Filters**.
- Step 2** In the Filters section, click **Add Filter**.
- Step 3** In the Conditions section, click **Add Condition**.
- Step 4** Add a condition to filter the messages that you want to sign, encrypt, or sign and encrypt. For example, to encrypt sensitive material, you might add a condition that identifies messages containing particular words or phrases, such as “Confidential,” in the subject or body.
- Step 5** Click **OK**.
- Step 6** In the Actions section, click **Add Action**.
- Step 7** Select **S/MIME Sign/Encrypt on Delivery** from the **Add Action** list.
- Step 8** Select the sending profile to associate with the content filter.
- Step 9** Click **OK**.
- Step 10** Submit and commit your changes.
-

What to do next

After you add the content filter, you need to add the filter to an outgoing mail policy. You may want to enable the content filter on the default policy, or you may choose to apply the filter to a specific mail policy, depending on your organization’s needs. For information about working with mail policies, see [Overview of Mail Policies](#), on page 257.

Verifying, Decrypting, or Decrypting and Verifying Incoming Messages using S/MIME

- [S/MIME Verification and Decryption Workflow in Email Security Appliance](#) , on page 543
- [How to Verify, Decrypt, or Decrypt and Verify Incoming Messages Using S/MIME](#), on page 544
- [Setting Up Certificates for Decrypting Messages](#), on page 545
- [Setting Up Public Keys for Verifying Signed Messages](#), on page 546
- [Enabling S/MIME Decryption and Verification](#), on page 548
- [Configuring an Action for S/MIME Decrypted or Verified Message](#), on page 548



Note You can use the appliance S/MIME security services to verify, decrypt, or decrypt and verify outgoing and incoming messages.

S/MIME Verification and Decryption Workflow in Email Security Appliance

- [S/MIME Verification Workflow](#), on page 544

- [S/MIME Decryption Workflow, on page 544](#)

S/MIME Verification Workflow

The following process describes how the appliance performs S/MIME verification.

1. Apply a hash algorithm to the signed message to create a message digest.
2. Decrypt the PKCS7 signature attached to the signed message using the public key of the sender's S/MIME certificate, and get the message digest.
3. Compare the generated message digest with the message digest retrieved from the signed message. If the message digests match, the message is verified.
4. Validate the S/MIME certificate of the sender domain with the Certificate Authority.

S/MIME Decryption Workflow

The following process describes how the appliance performs S/MIME decryption.

1. Decrypt the session key using the private key of the appliance's S/MIME certificate
2. Decrypt the message body using the session key.

How to Verify, Decrypt, or Decrypt and Verify Incoming Messages Using S/MIME

Steps	Do This	More Info
Step 1	Understand the S/MIME certificate requirements.	See S/MIME Certificate Requirements, on page 549 .
Step 2	Depending on your requirements, do one of the following: <ul style="list-style-type: none"> • For S/MIME decryption, add your organization's S/MIME certificate (that contains the private key required to perform decryption) to the appliance . • For S/MIME verification, add the public key of the sender's S/MIME certificate required to perform verification to the appliance . • For S/MIME decryption and verification, add the following to the appliance : <ul style="list-style-type: none"> • Your organization's S/MIME certificate (that contains the private key required to perform decryption) to the appliance . • Certificate Authority of the sender domain. • Public key of the sender's S/MIME certificate required to perform verification. 	See <ul style="list-style-type: none"> • Setting Up Certificates for Decrypting Messages, on page 545 • Setting Up Public Keys for Verifying Signed Messages, on page 546 • Importing a Custom Certificate Authority List, on page 669
Step 3	Configure your mail flow policies to verify, decrypt, or decrypt and verify incoming messages using S/MIME.	See Enabling S/MIME Decryption and Verification, on page 548 .

Steps	Do This	More Info
Step 4	(Optional) Define the action that the appliance takes on decrypted or verified messages.	See Configuring an Action for S/MIME Decrypted or Verified Message , on page 548.



Note If you want to perform S/MIME verification, decryption, or decryption and verification using CLI, use the `listenerconfig > hostaccess` command. See the CLI inline help for more details.

Setting Up Certificates for Decrypting Messages

You must add your organization's S/MIME certificate (that contains the private key required to perform decryption) to the appliance .

Before You Begin

- Share the public key of the appliance's S/MIME certificate with the sender (business or consumer) in one of the following ways:
 - Send the public key using an electronic channels, for example, email.
 - Request the sender to retrieve the public key using key harvesting.

The sender can use this public key to send encrypted messages to your appliance .



Note In a B2C scenario, if your organization's S/MIME certificate is a domain certificate, some email clients (for example, Microsoft Outlook) may not be able to send encrypted messages using the public key of your organization's S/MIME certificate. This is because these email clients do not support encryption using public keys of domain certificates.

- Make sure that the S/MIME certificate that you plan to import meets the requirements described in [S/MIME Certificate Requirements](#), on page 549.

Procedure

- Step 1** Click **Network > Certificates**.
- Step 2** Click **Add Certificate**.
- Step 3** Choose **Import Certificate**.
- Step 4** Enter the path to the certificate file on your network or local machine.
- Step 5** Enter the passphrase for the file.
- Step 6** Click **Next** to view the certificate's information.
- Step 7** Enter a name for the certificate.
- Step 8** Submit and commit your changes.

What to do next

Note Use the `certconfig` command to add the S/MIME certificates using CLI.

Setting Up Public Keys for Verifying Signed Messages

You must add the public key of the sender's S/MIME certificate to the appliance for verifying signed messages. Depending on your organizational policies and processes, you can use one of the following methods to add the public key to the appliance :

- Request the sender to send their public key using an electronic channels, for example, email. You can then add the public key using the web interface or CLI.

For instructions to add the public key, see [Adding a Public Key for S/MIME Encryption, on page 537](#).

- Retrieve the public key using key harvesting. See [Harvesting Public Keys, on page 538](#).

Adding a Public Key for S/MIME Verification

Before You Begin

- Make sure that the public key meets the requirements described in [S/MIME Certificate Requirements, on page 549](#).
- Make sure that the public key is in PEM format.

Procedure

-
- Step 1** Click **Mail Policies > Public Keys**.
 - Step 2** Click **Add Public Key**.
 - Step 3** Enter the name of the public key.
 - Step 4** Enter the public key.
 - Step 5** Submit and commit your changes.
-

What to do next

Note Use the `smimeconfig` command to add public keys using CLI.

Harvesting Public Keys for S/MIME Verification

You can configure the appliance to retrieve (harvest) public key from the incoming S/MIME signed messages and use it to verify signed messages from the owner (business or consumer) of the harvested key.



Note By default, public keys from expired or self-signed S/MIME certificates are not harvested.

1. Enable public key harvesting using the web interface or CLI. See [Enabling Public Key Harvesting, on page 547](#).
2. Request the sender to send a signed message.
3. After the harvesting is complete, add the harvested public key to the appliance. See [Adding a Harvested Public Key for S/MIME Verification, on page 547](#).

This step is to ensure that the message is verified at the gateway level.

Enabling Public Key Harvesting

Procedure

- Step 1** Click **Mail Policies > Mail Flow Policies**.
- Step 2** Create a new Mail Flow Policy or modify an existing one.
- Step 3** Scroll down to the **Security Features** section.
- Step 4** Under S/MIME Public Key Harvesting, do the following:
- Enable S/MIME public key harvesting.
 - (Optional) Choose whether to harvest public keys if the verification of the incoming signed messages fail.
 - (Optional) Choose whether to harvest updated public keys.
- Note** If an appliance receives more than one updated public key from the same domain or message within 48 hours, it sends out a warning alert.
- Step 5** Submit and commit your changes.
-

What to do next



Note The size of the harvested public key repository on the appliance is 512 MB. If the repository is full used, the appliance automatically removes unused public keys.

Use the `listenerconfig` command to enable key harvesting using CLI.

Adding a Harvested Public Key for S/MIME Verification

Procedure

- Step 1** Click **Mail Policies > Harvested Public Keys**.
- Step 2** Click on the intended harvested public key and copy the public key.

- Step 3** Add the public key to the appliance . See [Adding a Public Key for S/MIME Verification, on page 546](#).
- Step 4** Submit and commit your changes.
-

Enabling S/MIME Decryption and Verification

Procedure

- Step 1** Click **Mail Policies > Mail Flow Policies**.
- Step 2** Create a new Mail Flow Policy or modify an existing one.
- Step 3** Scroll down to the **Security Features** section.
- Step 4** Under S/MIME Decryption/Verification, do the following:
- Enable S/MIME decryption and verification.
 - Choose whether to retain or remove the digital signature from the messages after S/MIME verification. If you do not want your end users to know about S/MIME gateway verification, select **Remove**.
- For triple wrapped messages, only the inner signature is retained or removed.
- Step 5** Submit and commit your changes.
-

What to do next



- Tip** If S/MIME Decryption and Verification is enabled in the Mail Flow Policies, all the S/MIME messages are delivered irrespective of the status of the decryption and verification. If you want to configure an action for handling S/MIME Decrypted or Verified Messages, you can use the message filter rules—smime-gateway-verified and smime-gateway . For more information, see [Configuring an Action for S/MIME Decrypted or Verified Message, on page 548](#).
-

Configuring an Action for S/MIME Decrypted or Verified Message

After the appliance performs S/MIME decryption, verification, or both, you may want to take different actions depending on the results. You can use the message filter rules—smime-gateway-verified and smime-gateway to perform actions on the messages based on the result of decryption, verification, or both. For more information, see [Using Message Filters to Enforce Email Policies, on page 131](#)



- Note** You can also use the content filter conditions—**S/MIME Gateway Message** and **S/MIME Gateway Verified** to perform actions on the messages based on the result of decryption, verification, or both. For more information, see [Content Filters, on page 271](#)
-

Example: Quarantine S/MIME Messages that failed Verification, Decryption, or Both

The following message filter checks if the message is an S/MIME message and quarantines it if the verification or decryption using S/MIME fails.

```
quarantine_smime_messages:if (smime-gateway-message and not smime-gateway-verified)
{ quarantine("Policy"); }
```

S/MIME Certificate Requirements

- [Certificate Requirements for Signing, on page 549](#)
- [Certificate Requirements for Encryption, on page 550](#)

Certificate Requirements for Signing

The S/MIME certificate for signing must contain the following information:

Common Name	The fully qualified domain name.
Organization	The exact legal name of the organization.
Organizational Unit	Section of the organization.
City (Locality)	The city where the organization is legally located.
State (Province)	The state, county, or region where the organization is legally located.
Country	The two letter ISO abbreviation of the country where the organization is legally located.
Duration before expiration	The number of days before the certificate expires.
Subject Alternative Name(Domains)	Name of the domain from which you plan to send signed messages. Examples include domain.com and *.domain.net . For multiple entries, use a comma-separated list.
Subject Alternative Name(Email)	Email address of the user who is planning to send signed messages, for example, user@somedomain.com . For multiple entries, use a comma-separated list.
Private Key Size	Size of the private key to generate for the CSR.
Key Usage	Key usage is a restriction method that determines what a certificate can be used for. If the key usage extension is specified, the following bits: digitalSignature and nonRepudiation must be set. If the key usage extension is not specified, receiving clients must presume that the digitalSignature and nonRepudiation bits are set.

For detailed information about S/MIME certificates, see RFC 5750: Secure/Multipurpose Internet Mail Extensions (S/MIME) Version 3.2 - Certificate Handling.

Certificate Requirements for Encryption

The S/MIME certificate for encryption must contain the following information:

Common Name	The fully qualified domain name.
Organization	The exact legal name of the organization.
Organizational Unit	Section of the organization.
City (Locality)	The city where the organization is legally located.
State (Province)	The state, county, or region where the organization is legally located.
Country	The two letter ISO abbreviation of the country where the organization is legally located.
Duration before expiration	The number of days before the certificate expires.
Subject Alternative Name(Domains)	Name of the domain to which you plan to send encrypted messages. Examples include domain.com and *.domain.net . For multiple entries, use a comma-separated list. If you plan to send encrypted messages to all the users in a domain, the public key should include a SAN Domain.
Subject Alternative Name(Email)	Email address of the user to whom you plan to send encrypted messages, for example, user@somedomain.com . For multiple entries, use a comma-separated list.
Private Key Size	Size of the private key to generate for the CSR.
Key Usage	Key usage is a restriction method that determines what a certificate can be used for. The key usage extension must be specified and the following bit must be set: keyEncipherment .

For detailed information about S/MIME certificates, see RFC 5750: Secure/Multipurpose Internet Mail Extensions (S/MIME) Version 3.2 - Certificate Handling.

Managing Public Keys

the appliance requires:

- The public key of the recipient's S/MIME encryption certificate for encrypting the outgoing messages.
- The public key of the sender's S/MIME signing certificate for verifying incoming signed messages.

You can add public keys to your appliance in one of the following ways:

- If you have the intended public key in PEM format, you can add it using the web interface or CLI. See [Adding a Public Key, on page 551](#).
- If you have an export file that contains the intended public keys, you can copy the export file to the /configuration directory and import it using the web interface or CLI. See [Importing Public Keys from an Existing Export File, on page 551](#).

The appliance also supports key harvesting (automatically retrieving public keys from incoming signed messages). For more information, see [S/MIME Harvested Public Keys, on page 538](#).

Adding a Public Key

Before You Begin

- Make sure that the public key meets the requirements described in [S/MIME Certificate Requirements, on page 549](#).
- Make sure that the public key is in PEM format.

Procedure

- Step 1** Click **Mail Policies > Public Keys**.
- Step 2** Click **Add Public Key**.
- Step 3** Enter the name of the public key.
- Step 4** Enter the public key.
- Step 5** Submit and commit your changes.
-

What to do next



Note Use the `smimeconfig` command to add public keys using CLI.

Importing Public Keys from an Existing Export File

Before You Begin

Copy the export file to the /configuration directory of the appliance. For instructions to create an export file, see [Exporting Public Keys, on page 552](#).

Procedure

- Step 1** Click **Mail Policies > Public Keys**.
- Step 2** Click **Import Public Keys**.
- Step 3** Select the export file and click **Submit**.

Note The import process may take longer if you are importing a file with large number of public keys. Make sure that you adjust the web interface or CLI inactivity timeout accordingly.

- Step 4** Commit your changes.
-

Exporting Public Keys

All public keys on the appliance are exported together in a single text file and stored in the /configuration directory.

Procedure

- Step 1** Choose **Mail Policies > Public Keys**.
 - Step 2** Click **Export Public Keys**.
 - Step 3** Enter a name for the file and click **Submit**.
-



CHAPTER 24

Remediating Messages in Mailboxes

This chapter contains the following sections:

- [Overview, on page 553](#)
- [Workflow, on page 554](#)
- [Performing Remedial Actions on Messages in Mailboxes , on page 556](#)
- [Configuring Mailbox Remediation on Cisco Email Security Appliance , on page 562](#)
- [Upgrading to AsyncOS 13.0 and Later Releases, on page 571](#)
- [Monitoring Mailbox Remediation Results, on page 571](#)
- [Viewing Mailbox Remediation Details in Message Tracking, on page 572](#)
- [Troubleshooting Mailbox Remediation, on page 572](#)

Overview

The appliance provides the capability to remediate the malicious messages that are already delivered to the user mailbox. You can configure your appliance to remediate the messages in the following ways:

- automatically remediate the messages when the AMP sends the retrospective alert to your appliance
- manually search and remediate the messages using the Message Tracking filter

A file can turn malicious anytime, even after it has reached user's mailbox. AMP can identify this as new information emerges and push retrospective alerts to your appliance . You can configure your appliance to perform auto-remedial actions on the messages in user mailbox when the threat verdict changes. For example, you can configure your appliance to delete the message from the recipient's mailbox when the verdict of the attachment changes from clean to malicious.

You can also use the Message Tracking page to search and remediate the messages that are delivered to the user mailbox. The Message Tracking page is a unified place to search for all messages delivered to the mailboxes. From the search result, you can choose the messages you want to remediate and apply the action you want to perform on the messages.

The appliance can perform remedial actions(manually or automatically) on the messages in the following mailbox deployments:

- Microsoft Exchange online – mailbox hosted on Microsoft Office 365
- Microsoft Exchange on-premise – a local Microsoft Exchange server

- Hybrid/Multiple tenant configuration – a combination of mailboxes configured across Microsoft Exchange online and Microsoft Exchange on-premise deployments

Workflow

Mailbox Auto Remediation Workflow

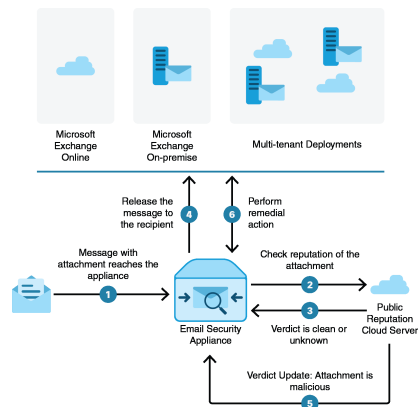

1. Message with an attachment reaches the appliance .
2. The appliance queries the public file reputation cloud server to evaluate the reputation of the attachment.
3. The public file reputation cloud server sends the verdict to the appliance . The verdict is clean or unknown.
4. The appliance releases the message to the recipient.
5. After a certain period, the appliance receives a verdict update from the public file reputation cloud server. The new verdict is malicious.
6. The appliance performs the configured remedial action on the message (with malicious attachment) residing in the recipient's mailbox.

Search and Remediate Messages Workflow

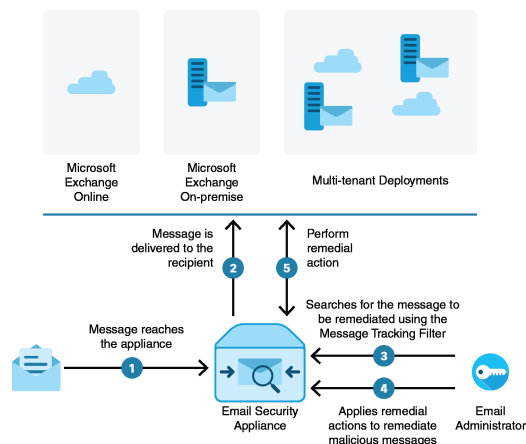

1. Message reaches the appliance .
2. Message is delivered to the recipient.
3. The administrator searches for the message delivered to the recipient using the Message Tracking filter.

4. The user selects the message to be remediated from the recipient's mailbox and applies the remedial action on the message.
5. The appliance performs the configured remedial action on the message residing in the recipient's mailbox.

How the Appliance Performs Auto-Remedial Actions

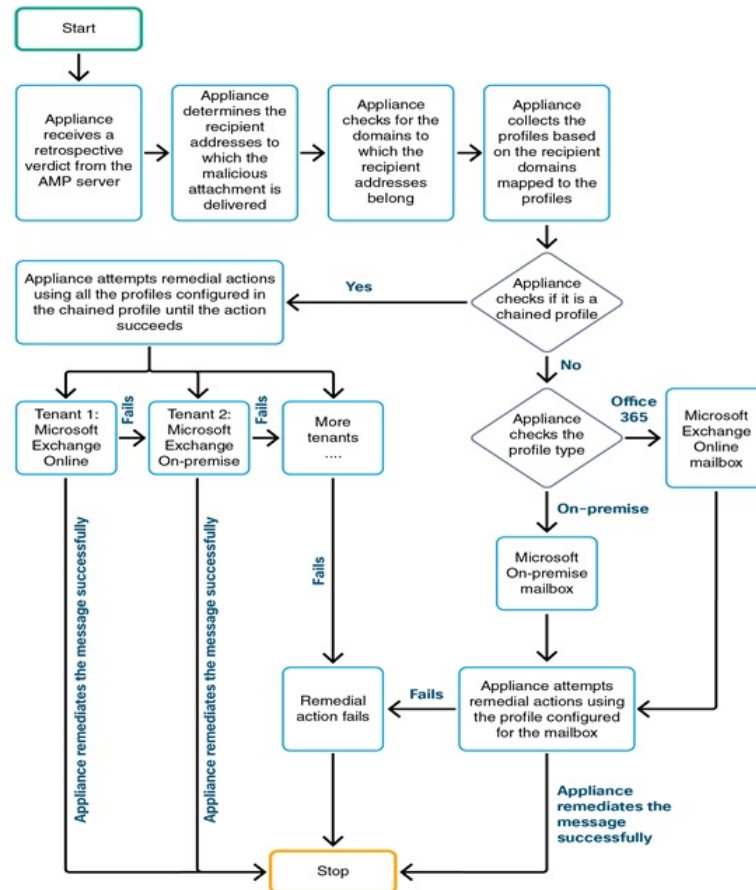

1. [Only to search and remediate messages] The user searches for the messages delivered to the user mailbox using the Message Tracking filter.
2. [Only to search and remediate messages] The user selects the messages to be remediated and applies remedial action on the messages.
3. [Only to automatically remediate messages] When the appliance receives a retrospective verdict from the public file reputation cloud server, the appliance initiates the mailbox remediation process.
4. [Only to automatically remediate messages] The appliance determines the email addresses to which the malicious message was delivered.

5. The appliance identifies the recipient domains to which the email addresses belong.
6. Based on the recipient domains, the appliance collects the account profile that is mapped to the domains.
An account profile defines the mailbox settings that are used by the appliance to connect to the mailbox and perform the auto-remedial actions. You must create an account profile and map it to the recipient domains to successfully remediate the message from the mailbox.
7. The appliance checks for the profile mapped to the domains:
 - [Only for hybrid or multi-tenant deployment] If it is a chained profile, the appliance attempts to perform remedial actions using all the account profiles in the chained profile.
A chained profile is a combination of multiple account profiles. In case of a hybrid or multi-tenant deployment, where there are mailboxes present across multiple deployments, you must create a chained profile to combine all the profiles defined for mailboxes in the deployment. The appliance attempts to perform remedial actions based on the order in which the account profiles are added in the chained profile.
 - If it is not a chained profile, the appliance checks the profile type to know if it is an Microsoft Exchange online profile or an Microsoft Exchange on-premise profile.
8. The appliance performs remedial actions using the identified profile and remediates the message.



Note Mailbox remediation may fail for various reasons. For more information, see [Troubleshooting Mailbox Remediation, on page 572](#).

Contents

- [Performing Remedial Actions on Messages in Microsoft Exchange Online Mailboxes, on page 557](#)
- [Performing Remedial Actions on Messages in Microsoft Exchange On-Premise Mailboxes , on page 558](#)
- [Performing Remedial Actions on Messages in Mailboxes on Hybrid Deployment, on page 560](#)

Performing Remedial Actions on Messages in Mailboxes

You can perform remedial actions on messages in the following mailbox deployments:

- Microsoft Exchange Online (Office 365) - [Performing Remedial Actions on Messages in Microsoft Exchange Online Mailboxes, on page 557](#)
- Microsoft Exchange On-Premise - [Performing Remedial Actions on Messages in Microsoft Exchange On-Premise Mailboxes , on page 558](#)
- Hybrid/Multi-tenant Deployment - [Performing Remedial Actions on Messages in Mailboxes on Hybrid Deployment, on page 560](#)

Performing Remedial Actions on Messages in Microsoft Exchange Online Mailboxes

You can configure your appliance to perform remediation of messages from user mailbox.

If your organization is using Microsoft Exchange online to manage mailboxes, you can configure your appliance to perform auto-remedial actions on the messages in user mailbox when the threat verdict changes. For example, you can configure your appliance to delete the message from the recipient's mailbox when the verdict of the attachment changes from clean to malicious.

You can perform remedial actions manually on messages that are already delivered to the user mailbox. For example, an administrator monitoring the incoming messages can perform remedial actions on messages in the user mailbox using the Message Tracking filter.

Contents

- [How to Configure Remedial Action on Messages in Microsoft Exchange Online Mailboxes, on page 557](#)

How to Configure Remedial Action on Messages in Microsoft Exchange Online Mailboxes

	Do This	More Info
Step 1	Review the prerequisites.	Prerequisites for Remediating Messages in Microsoft Exchange Online Mailboxes, on page 562
Step 2	Register appliance as an application on Azure AD (Azure Management Portal).	Registering Your Appliance as an Application on Azure AD, on page 564
Step 3	Enable the account settings on your appliance .	Enable mailbox remediation on your appliance . Enabling Account Settings on Cisco Email Security Appliance , on page 566

	Do This	More Info
Step 4	Create an account profile of type Office 365/Hybrid (Graph API) on your appliance	<p>Create an Office 365 profile for the user mailbox and define the mailbox settings on the appliance</p> <p>Before you Begin, make sure that you have:</p> <ul style="list-style-type: none"> • Acquired the private key of the certificate in .pem format. See Certificate for Secure Communication. • The values of the following parameters: <ul style="list-style-type: none"> • Client ID and Tenant ID of the application that you registered on the Azure Management Portal. • See Step 9 of Registering Your Appliance as an Application on Azure AD. • Certificate thumbprint (\$base64Thumbprint). See Step 8 of Registering Your Appliance as an Application on Azure AD. <p>See Creating an Account Profile , on page 566.</p>
Step 5	Add the recipient domain and map the domain to the Office 365 profile.	<p>Add the domain that the recipient mailbox belongs and map the domain to the Office 365 account profile.</p> <p>See Mapping Domains to the Account Profile , on page 568.</p>
Step 6	[Only to automatically remediate messages] Configure your appliance to perform remedial actions on messages delivered to end users when the threat verdict changes to malicious.	Configure Auto-Remedial Actions on Messages in the Mailboxes , on page 569
Step 7	[Only to search and remediate messages] Configure your appliance to perform remedial actions manually on messages delivered to end users.	Search and Remediate Messages in the Mailboxes , on page 570

Performing Remedial Actions on Messages in Microsoft Exchange On-Premise Mailboxes

You can configure the appliance to remediate messages from a mailbox on an Exchange on-premise server. The messages can be remediated automatically by the appliance or manually by the user using the Message Tracking filter.

The appliance uses a user account with impersonator privileges to access the Exchange on-premise mailbox and perform remedial actions on the message. You must create this user account with impersonator privileges on the mail exchange server to which the appliance has to connect and remediate the message.



Note Cisco has validated Mailbox Auto Remediation only on Microsoft Exchange 2013, 2016, and 2019.

Contents

- [How to Configure Remedial Actions on Messages in Microsoft Exchange On-Premise Mailboxes](#), on page 559

How to Configure Remedial Actions on Messages in Microsoft Exchange On-Premise Mailboxes

	Do This	More Info
Step 1	Review the prerequisites.	Prerequisites for Remediating Messages in an On-Premise Account , on page 563
Step 2	Enable the account settings on your appliance .	Enable mailbox remediation on your appliance . Enabling Account Settings on Cisco Email Security Appliance , on page 566
Step 3	Create an account profile of type On-Premise on your appliance .	Create an On-Premise profile for the user mailbox and define the mailbox settings on your appliance . Before you begin, make sure that you have: <ul style="list-style-type: none"> • The impersonator user account details • The host name of the local mail exchange server Creating an Account Profile , on page 566.
Step 4	Add the recipient domain and map the domain to the On-premise account profile.	Add the domain that the recipient mailbox belongs and map the domain to the On-premise account profile. See Mapping Domains to the Account Profile , on page 568.
Step 5	[Only to automatically remediate messages] Configure your appliance to perform remedial actions on messages delivered to end users when the threat verdict changes to malicious.	Configure Auto-Remedial Actions on Messages in the Mailboxes , on page 569
Step 6	[Only to search and remediate messages] Configure remedial actions on messages in the on premise mailbox.	Search and Remediate Messages in the Mailboxes , on page 570

Performing Remedial Actions on Messages in Mailboxes on Hybrid Deployment

You can configure a single appliance to remediate messages from a hybrid exchange deployment or multiple exchange tenants. For example, if your organization is in a process of moving the mailbox from Microsoft Exchange on-premise to Microsoft Exchange online, there will be mailboxes deployed on Microsoft Exchange online and Microsoft Exchange on-premise until the migration is complete. The messages can be remediated automatically by the appliance or manually by the user using the Message Tracking filter.

To automatically remediate messages from multiple mailboxes configured across different deployments, create a chained profile. A chained profile combines all the account profiles of a hybrid or multi-tenant deployment. The order in which the profiles are added to the chained profile defines the priority in which the appliance checks the profile to remediate messages.

When the appliance receives a retrospective verdict from the AMP server, the appliance attempts to perform the remediation action using each profile present in the chained profile in the order of priority defined in the chained profile.

To manually search and remediate the messages that are delivered to the user mailbox, use the Message Tracking filter. You can use this filter to select the messages you want to remediate, configure the remedial action, and apply the remedial action on the messages.

Contents

- [How to Perform Remedial Actions on Messages in Mailboxes on Hybrid Deployment, on page 560](#)

How to Perform Remedial Actions on Messages in Mailboxes on Hybrid Deployment

	Do This	More Info
Step 1	Review the prerequisites.	Ensure that all the prerequisites for performing auto-remedial actions on Microsoft Exchange online and Microsoft Exchange on-premise mailboxes are met for a hybrid or multi-tenant deployment. See Prerequisites, on page 562 .
Step 2	Register appliance as an application on Azure AD (Azure Management Portal).	Registering Your Appliance as an Application on Azure AD, on page 564
Step 3	Enable the account settings on your appliance .	Enable mailbox remediation on your appliance . See Enabling Account Settings on Cisco Email Security Appliance , on page 566 .

	Do This	More Info
Step 4	Create account profiles for all the mailboxes in the hybrid/multi-tenant deployment.	<p>Create account profiles for the user mailboxes and define mailbox settings on the appliance .</p> <p>Before you Begin, make sure that you have:</p> <ul style="list-style-type: none"> • Acquired the private key of the certificate in .pem format. See Certificate for Secure Communication. • The values of the following parameters: <ul style="list-style-type: none"> • Client ID and Tenant ID of the application that you registered on the Azure Management Portal. • See Step 9 of Registering Your Appliance as an Application on Azure AD. • Certificate thumbprint (\$base64Thumbprint). See Step 8 of Registering Your Appliance as an Application on Azure AD. • The impersonator user account details • The host name of the local mail exchange server <p>See Creating an Account Profile , on page 566.</p>
Step 5	Create a chained profile.	<p>Create a chained profile and add all the profiles of a hybrid/multi- tenant deployment.</p> <p>See Creating a Chained Profile , on page 568.</p>
Step 6	Add the recipients' domains and map them to the chained profile.	<p>Add the domains that the recipients' mailboxes belong and map the domains to the chained profile.</p> <p>See Mapping Domains to the Account Profile , on page 568.</p>
Step 7	[Only to automatically remediate messages] Configure your appliance to perform remedial actions on messages delivered to end users when the threat verdict changes to malicious.	<p>Configure Auto-Remedial Actions on Messages in the Mailboxes, on page 569</p>
Step 8	[Only to search and remediate messages] Apply the remedial actions on the messages.	<p>Search and Remediate Messages in the Mailboxes, on page 570</p>

Configuring Mailbox Remediation on Cisco Email Security Appliance

- [Prerequisites, on page 562](#)
- [Registering Your Appliance as an Application on Azure AD, on page 564](#)
- [Enabling Account Settings on Cisco Email Security Appliance , on page 566](#)
- [Creating an Account Profile , on page 566](#)
- [Creating a Chained Profile , on page 568](#)
- [Mapping Domains to the Account Profile , on page 568](#)
- [Configure Auto-Remedial Actions on Messages in the Mailboxes, on page 569](#)
- [Search and Remediate Messages in the Mailboxes, on page 570](#)

Prerequisites

- [Prerequisites for Remediating Messages in Microsoft Exchange Online Mailboxes, on page 562](#)
- [Prerequisites for Remediating Messages in an On-Premise Account, on page 563](#)

Prerequisites for Remediating Messages in Microsoft Exchange Online Mailboxes

- [Only for Mailbox Auto Remediation] - [Feature Keys for File Reputation Service and the File Analysis Service, on page 562](#)
- [Office 365 Accounts, on page 562](#)
- [Certificate for Secure Communication, on page 563](#)

Feature Keys for File Reputation Service and the File Analysis Service



Note The File Reputation Service and the File Analysis Service feature keys are not required for performing Search and Remediate actions on messages in the user mailbox.

To configure remedial actions for Mailbox Auto Remediation on messages in the user mailbox, make sure that you have:

- Added the feature keys for the file reputation service and the file analysis service to you appliance .
- Enabled File Reputation and Analysis feature on your appliance . See [File Reputation Filtering and File Analysis, on page 457](#).

Office 365 Accounts

Make sure that you have the following accounts that are required to register your appliance with Azure AD:

- An Office 365 business account
- An Azure AD subscription associated with your Office 365 business account

For more information, contact your Office 365 administrator.

Certificate for Secure Communication

To secure the communication between Office 365 services and your appliance , you must set up a certificate in one of the following ways: create a self-signed certificate or obtain a certificate from a trusted CA.

You must have:

- A public key in .crt or .p12 format. Make sure that the emailAddress is set to the email address of the Office 365 administrator (<admin_username>@<domain>.com).
- An associated private key in .pem format, with keysize at least 2048 bit.

For more information, see <https://www.cisco.com/c/en/us/support/docs/security/email-security-appliance/211404-How-to-configure-Azure-AD-and-Office-365.html>.



Note Private keys with passphrase are not supported in this release.

Prerequisites for Remediating Messages in an On-Premise Account

- [Only for Mailbox Auto Remediation] - [Feature Keys for File Reputation Service and the File Analysis Service, on page 562](#)
- (Optional) [Import Microsoft Exchange Web Service \(EWS\) Certificate, on page 563](#)
- [Add a User to the Impersonator Role, on page 564](#)

Feature Keys for File Reputation Service and the File Analysis Service



Note The File Reputation Service and the File Analysis Service feature keys are not required for performing Search and Remediate actions on messages in the user mailbox.

To configure remedial actions for Mailbox Auto Remediation on messages in the user mailbox, make sure that you have:

- Added the feature keys for the file reputation service and the file analysis service to you appliance .
- Enabled File Reputation and Analysis feature on your appliance . See [File Reputation Filtering and File Analysis, on page 457](#).

(Optional) Import Microsoft Exchange Web Service (EWS) Certificate

If you are using a self-signed certificate on an Microsoft Exchange on-premise server for the EWS service, you must import the certificate from the Microsoft Exchange on-premise server into the appliance . To import a certificate, see [Importing a Certificate , on page 656](#).

Add a User to the Impersonator Role

The appliance uses a user account that has impersonator privileges to access the Microsoft Exchange on-premise mailbox. The mail exchange administrator must create a user account with impersonator privileges on the local exchange server. The appliance used this user account to remediate messages from the mailbox.

Procedure

-
- Step 1** Create a user account for which impersonator privileges must be assigned. This user account is used by the appliance to access and operate the mailbox to remediate the messages.
 - Step 2** Log in to the Microsoft Exchange Control Panel interface using administrator credentials.
 - Step 3** Navigate to **Permissions -> Admin Roles**.
 - Step 4** Create a role and assign the 'ApplicationImpersonation' privileges for the role.
 - Step 5** Add the user account for which the impersonator privileges must be assigned as a member of this new role.
-

Registering Your Appliance as an Application on Azure AD

Office 365 services use Azure Active Directory (Azure AD) to provide secure access to users' mailboxes. For your appliance to access the Office 365 mailboxes, you must register your appliance with Azure AD. The following are the high level steps you need to perform to register your appliance with Azure AD. For detailed instructions, see Microsoft documentation (<https://docs.microsoft.com/en-us/azure/active-directory/develop/quickstart-register-app>).

Before You Begin

Perform the tasks described in [Prerequisites for Remediating Messages in Microsoft Exchange Online Mailboxes, on page 562](#).

Procedure

-
- Step 1** Sign into the Azure Management Portal using your Office 365 business account credentials.
 - Step 2** Add a new application to the directory linked to your Office 365 subscription.
 - Step 3** Navigate to **App Registrations > New Registration** to add a new application.
 - Step 4** While adding a new application, make sure that you:
 - Specify the application name and the account types the application must support.
 - (Optional) Select the application type as Web and provide the URL where users can sign-in and use your appliance .
 - Step 5** Assign the permissions that the application requires. Click **API permissions** on the navigation pane and click **Add a permission**.
 - Step 6** Select **Microsoft Graph >Application permissions** and assign the following permissions:
 - Mail.Read – Read mail in all mailboxes
 - Mail. ReadWrite - Read and write mail in all mailboxes

- Mail.Send - Send mail as any user
- Directory.Read.All - Read user or group information from Azure Active Directory to store them on an LDAP server configured on the Cisco Cloud environment.

Step 7 Grant admin consent for all the requested permissions for all accounts in the organization.

Step 8 Secure the communication between the Office 365 services and the appliance by updating the application manifest with the key credentials from the public key certificate. Perform the following steps:

- a) Using a Windows PowerShell prompt, get the values for `$base64Thumbprint`, `$base64Value`, and `$keyid` from the public key certificate. See the example below. From the Windows PowerShell prompt, navigate to the directory containing the public key certificate and run the following:

Example:

```
$cer = New-Object System.Security.Cryptography.X509Certificates.X509Certificate2
$cer.Import(".\mycer.cer")
$bin = $cer.GetRawCertData()
$base64Value = [System.Convert]::ToBase64String($bin)
$bin = $cer.GetCertHash()
$base64Thumbprint = [System.Convert]::ToBase64String($bin)
$keyid = [System.Guid]::NewGuid().ToString()
```

After running the above commands, run the following commands to extract their values:

```
$keyid
$base64Value
$base64Thumbprint
```

- b) Click **Manifest** on left pane of the registered application pane to open the manifest of the application.
c) In the manifest text editor, replace the empty KeyCredentials property with the following JSON:

Example:

```
"keyCredentials": [
{
"customKeyIdentifier": "$base64Thumbprint_from_step_1",
"keyId": "$keyid_from_step1",
"type": "AsymmetricX509Cert",
"usage": "Verify",
"value": "$base64Value_from_step1"
}
],
```

Example:

In the above JSON snippet, make sure that you replace the values of `$base64Thumbprint`, `$base64Value`, and `$keyid` with the values you obtained in step a. Each value must be entered in a single line

Step 9 After registering your appliance with Azure AD, note down the following details from the Azure Management Portal from the Overview pane of the registered application:

- Client ID
- Tenant ID. The Tenant ID is the unique value that will be available on all the URLs listed on this page. For instance, the URLs listed on this page are:
 - <https://login.microsoftonline.com/abcd1234-bcdd-469d-8545-a0662708cbc3/federationmetadata/2007-06/federationmetadata.xml>
 - <https://login.microsoftonline.com/abcd1234-bcdd-469d-8545-a0662708cbc3/wsfed>

- <https://login.microsoftonline.com/abcd1234-bcdd-469d-8545-a0662708cbc3/saml2>

In this case, the Tenant ID is abcd1234-bcdd-469d-8545-a0662708cbc3 .

What to do next

[Enabling Account Settings on Cisco Email Security Appliance](#) , on page 566

Enabling Account Settings on Cisco Email Security Appliance

Before You Begin

Make sure that you have:

- [Required only for Mailbox Auto Remediation] Enabled File Reputation and Analysis feature on your appliance . See [File Reputation Filtering and File Analysis](#), on page 457.

Procedure

- Step 1** Log in to the appliance .
 - Step 2** Click **System Administration** > **Account Settings**.
 - Step 3** Click **Enable**.
 - Step 4** Select **Enable Account Settings**.
 - Step 5** (Optional) Enter the maximum number of attempts the appliance makes to connect to the mailbox to remediate the message. The value must be an integer from 1 to 5.
 - Step 6** (Optional) Enter the number of seconds the appliance must wait before the connection times out to the hybrid mail exchange server. The value must be an integer from 15 to 90.
 - Step 7** (Optional) Enter the number of seconds the appliance must wait before the connection times out to the local mail exchange server. The value must be an integer from 15 to 90.
 - Step 8** Submit and commit your changes.
-

What to do next

[Creating an Account Profile](#) , on page 566

Creating an Account Profile

An account profile defines the mailbox parameters that are required for the appliance to connect to the mailbox and perform remedial actions when the thread verdict of the message in the mailbox turns malicious.

Each profile credentials are related to one single tenant. If you want to perform remediation across multiple tenants, then you have to configure one profile for each tenant and chain them together using a chained profile. However, if you are using a load balancer for a multi-tenant deployment, you can still configure a single profile and use the hostname of the load balancer while creating a profile.

Before You Begin

Make sure that you have:

- Enabled the account settings. See [Enabling Account Settings on Cisco Email Security Appliance](#) , on page 566.
- A valid email address in the Microsoft Exchange online or Microsoft Exchange on-premise server.
- The parameters required to configure the Microsoft Exchange online or Microsoft Exchange on-premise account.

Procedure

- Step 1** Log in to the appliance .
- Step 2** Click **System Administration > Account Settings**.
- Step 3** Click **Create Account Profile**.
- Step 4** Enter a name and description for the profile.
- Step 5** Select the profile type based on the mailbox deployment:
- **Office 365/Hybrid (Graph API)** – Select this to configure a mailbox deployed on Microsoft Exchange online and enter the following details: Client ID and Tenant ID of the application that you registered on the Azure Management Portal.
 - Client ID and Tenant ID of the application that you registered on the Azure Management Portal.
 - Thumbprint of the certificate (value of \$base64Thumbprint).
 - Upload the private key of the certificate. Click **Choose File** and select the .pem file.
 - (Optional) If you want the credentials configured in this profile to be used by the Office 365 LDAP connector, select **Use for LDAP synchronization**. LDAP connector uses this credentials to synchronize LDAP entries from Azure Active Directory to the local LDAP server.
 - **Exchange On-premise** - Select this to configure a mailbox deployed on Microsoft Exchange on-premise and enter the following details:
 - Enter the username and password of the user account with impersonator privileges. For more information, see [Add a User to the Impersonator Role, on page 564](#).
 - Enter the hostname of the Microsoft Exchange on-premise server.
 - Note** If you are using a load balancer for a multi-tenant deployment, you must configure the hostname of your load balancer.
- Step 6** Verify whether the appliance can connect to the Microsoft Exchange online or Exchange on-premise server.
- a) Click **Test Connection**.
 - b) Enter an email address. This must be a valid email address in the Microsoft Exchange online or Microsoft Exchange on-premise.
 - c) Click **Test Connection**.
The status is displayed confirming whether your appliance can connect to the mailbox server.
 - d) 4. Click **Done**. For troubleshooting the errors, see [Troubleshooting Mailbox Remediation, on page 572](#).

Step 7 Submit and commit your changes.

What to do next

- [Creating a Chained Profile](#) , on page 568
- [Mapping Domains to the Account Profile](#) , on page 568

Creating a Chained Profile

This task is mandatory only if you want to remediate messages in a mailbox on a hybrid or multi-tenant deployments.

Before You Begin

Make sure that you have at least one account profile added on your appliance :

Procedure

Step 1 Log in to the appliance .

Step 2 Click **System Administration** > **Account Settings**.

Step 3 Click **Create Chained Profile**.

Step 4 Enter a name and description for the chained profile.

Step 5 Select the account profile you want to add to the chained profile from the drop-down menu. To add more profiles, click **Add Account Profile**.

- Note**
- You must add the profiles in the order of priority in which you want the appliance to check the profile for remediating the message.
 - You can create a maximum of five chained profiles at a time on your appliance .
 - You can add a maximum of 10 account profiles per chained profile.

Step 6 Submit and commit your changes.

What to do next

[Mapping Domains to the Account Profile](#) , on page 568

Mapping Domains to the Account Profile

You must define the domain to which the recipient's mailbox belongs. The domain is then mapped to the account profile which is used by the appliance to remediate message in the mailbox.

**Note**

- You can edit the domain mapping to add new domains to the existing domain mapped to the profile.
- The domain mapping is unique to a profile. Domains mapped to one profile cannot be mapped to another.

Before You Begin

Make sure that you have at least one account profile added on your appliance .

Procedure

- Step 1** Log in to the appliance .
- Step 2** Click **System Administration > Account Settings**.
- Step 3** Click **Create Domain Mapping**.
- Step 4** Enter the domain names separated by commas. If you want to map the profile to all the domains, type the string 'ALL'.
- Step 5** Select the profile to be mapped to the domain(s). You can also map a chained profile to the domain(s).
- Step 6** Submit and commit your changes.

What to do next

- [Configure Auto-Remedial Actions on Messages in the Mailboxes, on page 569](#)
- [Search and Remediate Messages in the Mailboxes, on page 570](#)

Configure Auto-Remedial Actions on Messages in the Mailboxes

**Note**

Perform the following steps if you want to configure remedial actions for Mailbox Auto Remediation on messages in the mailboxes.

Before You Begin

Make sure that you have enabled Mailbox Auto Remediation and configured the account settings on your appliance. See [Enabling Account Settings on Cisco Email Security Appliance , on page 566](#).

Procedure

- Step 1** Select **Mail Policies > Incoming Mail Policies**.
- Step 2** Click the link in the **Advanced Malware Protection** column of the mail policy to modify.
- Step 3** Select **Enable Mailbox Auto Remediation**.
- Step 4** Specify the action to be taken on messages delivered to end users when the threat verdict changes to malicious. Depending on your requirements, choose one of the following remedial actions:

- Forward to an email address. Select this option to forward the message with malicious attachment to a specified user, for example, an email administrator.
- Delete the message. Select this option to permanently delete the message with malicious attachment from the end user's mailbox.
- Forward to an email address and delete the message. Select this option to forward the message with malicious attachment to a specified user, for example, an email administrator and permanently delete that message from the end user's mailbox.

Step 5 Submit and commit your changes.

What to do next

Related Topics

- [Monitoring Mailbox Remediation Results, on page 571](#)
- [Viewing Mailbox Remediation Details in Message Tracking, on page 572](#)
- [Troubleshooting Mailbox Remediation, on page 572](#)

Search and Remediate Messages in the Mailboxes

Before You Begin

- Make sure that you have enabled mailbox remediation and configured the account settings on your appliance . See [Enabling Account Settings on Cisco Email Security Appliance , on page 566](#).
- Enable Message Tracking on your appliance . See [Enabling Message Tracking, on page 887](#).
- If you are using the Centralized Message Tracking service, make sure that you have enabled the trailblazer port and AsyncOS API HTTP port on the managed Cisco Email Security Gateway and the Cisco Content Security Management appliance can access the trailblazer port. If the trailblazer port is disabled, ensure that the Cisco Content Security Management appliance can access the AsyncOS API HTTP port on the managed Cisco Email Security Gateway .



Note You can perform the following steps only in the new web interface of the appliance .

Procedure

- Step 1** Click the Email Security Appliance is getting a new look. Try it!! link on the legacy web interface. See [Accessing the Web-Based Graphical User Interface \(GUI\), on page 30](#).
- Step 2** Click the **Tracking** tab.
- Step 3** Click the **Messages** tab to narrow your search results. For more information, see [Searching for Email Messages on the New Web Interface, on page 891](#).
- Step 4** Select the messages you want to remediate. You can select a maximum of 1000 messages at a time. You can remediate the messages that are only in the delivered state.
- Step 5** Click **Remediate**.
- Step 6** Enter the following details:

- Enter a batch name for the remediation.
- Select anyone of the following remediation action:
 - Delete the messages. Select this option to permanently delete the malicious messages from the end user's mailbox.
 - Forward to an email address or multiple email addresses separated by a semicolon(;). Select this option to forward the malicious messages to a specified user, for example, an email administrator.
 - Forward to an email address or multiple email addresses separated by a semicolon(;) and delete the messages. Select this option to forward the malicious messages to a specified user, for example, an email administrator and permanently delete that messages from the end user's mailbox.

Step 7 Click **Apply**.

What to do next

Related Topics

- [Monitoring Mailbox Remediation Results, on page 571](#)
- [Viewing Mailbox Remediation Details in Message Tracking, on page 572](#)
- [Troubleshooting Mailbox Remediation, on page 572](#)

Upgrading to AsyncOS 13.0 and Later Releases

The mailbox settings defined in the previous AsyncOS versions are migrated seamlessly during the upgrade. This mailbox is created with the profile name as 'Default' and mapped to 'ALL' domains. This profile can be edited as required after the upgrade. Ensure that your application has access to Microsoft Graph API on Azure Active Directory to remediate messages from Microsoft Exchange online mailboxes. For more information, see [Registering Your Appliance as an Application on Azure AD, on page 564](#).

Monitoring Mailbox Remediation Results

You can view the details of the mailbox remediation results using the Remediation report page. To view the report:

1. Click the **Email Security Appliance is getting a new look. Try it!!** link on the legacy web interface.
2. Click the **Monitoring** tab.
3. Click the **Reports** drop-down menu and select **Remediation Report**.

Use this report to view the following details:

- Total number of messages attempted for remediation using Mailbox Auto Remediation and Mailbox Search and Remediate.
- Number of messages successfully remediated for a configured remedial action.
- Number of messages for which the remediation failed.
- Details about the messages for which the remediation was attempted.

For more information, refer to the section [Remediation Report Page, on page 878](#).

Viewing Mailbox Remediation Details in Message Tracking

You can view the details of messages remediating using Mailbox Search and Remediate in Message Tracking page. Before you begin the remediation, ensure that the Message Tracking is enabled.



Note Messages attempted for remediation using Mailbox Auto Remediation are not included in the tracking search results.

For more information about the data displayed, see [Message Tracking Details](#), on page 894.

Troubleshooting Mailbox Remediation

- [Connection Errors](#), on page 572
- [Viewing Logs](#), on page 574
- [Alerts](#), on page 574
- [Configured Remedial Actions Are Not Performed](#), on page 574

Connection Errors

Problem

While trying to check the connection between your appliance and recipient mailbox on the Account Settings page (**System Administration** > **Account Settings**), you receive an error message: `Connection Unsuccessful`.

Solution

Depending on the response from the server, do one of the following:

Error Message	Reason and Solution
The SMTP address has no mailbox associated with it	You have entered an email address that is not part of the associated mail domain. Enter a valid email address and check the connection again.
The mailbox cannot be accessed using this profile or the required permissions may be missing	Verify that: <ul style="list-style-type: none"> • You have the required permission to access the user mailbox. The Microsoft Exchange online account can be accessed only using the Microsoft Graph API and the Microsoft Exchange on-premise account using an user account with impersonator privileges. • You have selected the incorrect profile type. Modify the profile details on the Edit Account Profile page and check the connection again.
Access is denied. Check credentials and try again	The Office 365 application configured in Microsoft Azure does not have the required permission to access the Microsoft Exchange online mailbox.

Error Message	Reason and Solution
Application with identifier '<client_id>' was not found in the directory <tenant_id>	You have entered an invalid Client ID. Modify the Client ID on the Account Profile page and check the connection again.
No service namespace named '<tenant_id>' was found in the data store.	You have entered an invalid Tenant ID. Modify the Tenant ID on the Account Profile page and check the connection again.
Error validating credentials. Credential validation failed	You have entered an invalid certificate thumbprint. Modify the certificate thumbprint on the Account Profile page and check the connection again.
Error validating credentials. Client assertion contains an invalid signature.	You have entered an incorrect certificate thumbprint or you have uploaded an invalid or incorrect certificate private key. Verify that: <ul style="list-style-type: none"> You have entered the correct thumbprint. You have uploaded the correct certificate private key. The certificate private key is not expired. The time zone of your appliance matches the time zone in the certificate private key.
The requested user <email address> is invalid	The email address entered does not match with the profile type of the account profile. Enter a valid email address or modify the account profile on the Account Profile page and check the connection again.
Failed to verify exchange server('<host name>') certificate. If self-signed certificate is used on exchange server install its custom CA certificate	<ul style="list-style-type: none"> You have entered an invalid CA or self-signed certificate on the Microsoft Exchange on-premise server. Verify the certificate and check the connection again. <p>Note Ensure that the certificate you are using corresponds to the hostname provided in the profile. For example, if you have provided the IP address of the exchange server in your profile setting and the certificate is based on the hostname, then the connection will fail.</p> <ul style="list-style-type: none"> You have not imported the self-signed certificate from the Microsoft Exchange on-premise server to your appliance . For more information, see Importing a Certificate , on page 656.
Invalid username or password entered for exchange server ('<email address>')	You have entered an invalid user name or password for the impersonator user account that is used to connect to the Microsoft Exchange on-premise mailbox.)
The account does not have permission to impersonate the requested user	The user account used to connect to the Microsoft Exchange on-premise mailbox is not a member of the impersonator role (does not have impersonator privileges).

Error Message	Reason and Solution
Please check host <hostname> is valid exchange server address.	You have entered an incorrect hostname of the Microsoft Exchange on-premise server. Modify the hostname on the Account Profile page and check the connection again.

Viewing Logs

Mailbox remediation information is posted to the following logs:

- Mail Logs (mail_logs). The time at which the mailbox remediation process started is posted to this log. Information about Mailbox Auto Remediation or Mailbox Search and Remediate action:
 - The time at which the mailbox remediation process started is posted to this log.
 - The remediation status.
 - The reason for the unsuccessful remediation.
 - The recipients for whom the remediation was successful and unsuccessful.
 - The source from which the Search and Remediate action is initiated.
 - The user who initiated the Search and Remediate action.
 - The remedial action attempted on the messages.
- Remediation Logs. Information related to remediation status, actions performed, errors and so on are posted to this log.

Alerts

Alert: Connectivity Issues Between Appliance and Microsoft Exchange Services Detected

Problem

You receive an info-level alert indicating that there are connectivity issues between your appliance and Microsoft Exchange online or Microsoft Exchange on-premise services and the appliance is unable to perform the configured remedial action.

Solution

Do the following:

- Check for network issues that might prevent the communication between your appliance and Microsoft Exchange online or Microsoft Exchange on-premise services.

Review the network settings of your appliance . See [Changing Network Settings, on page 1043](#).
- Ensure that your application has access to Microsoft Graph API on Azure Active Directory.
- Ensure that the user account used to access the Exchange on-premise mailbox has impersonator privileges.
- Verify that the parameters configured in the corresponding profiles are valid and test the connection.
- Check for firewall issues. See [Firewall Information, on page 1289](#).
- Check whether the Microsoft Exchange online or Microsoft Exchange on-premise services are operational.

Configured Remedial Actions Are Not Performed

Problem

After receiving a retrospective alert from the AMP server, configured remedial actions are not performed on the malicious messages in Exchange online and Exchange on-premise mailboxes.

Or

The user is unable to remediate the messages manually using the Remediate option on the Message Tracking page.

Solution

Do the following:

- Test the connection between your appliance and Exchange online and Exchange on-premise services. See [Creating an Account Profile](#), on page 566.
- [Only for Mailbox Auto Remediation] Check whether you have received the following alert: Connectivity Issues Between Appliance and Exchange online and Exchange on-premise Services Detected. See [Alerts](#), on page 574.



CHAPTER 25

Email Authentication

This chapter contains the following sections:

- [Email Authentication Overview, on page 577](#)
- [Configuring DomainKeys and DKIM Signing, on page 579](#)
- [How to Verify Incoming Messages Using DKIM, on page 592](#)
- [Overview of SPF and SIDF Verification, on page 597](#)
- [How to Verify Incoming Messages Using SPF/SIDF, on page 599](#)
- [Enabling SPF and SIDF, on page 600](#)
- [Determining the Action to Take for SPF/SIDF Verified Mail, on page 604](#)
- [Testing the SPF/SIDF Results, on page 607](#)
- [DMARC Verification, on page 608](#)
- [Forged Email Detection, on page 616](#)

Email Authentication Overview

AsyncOS supports email verification and signing to prevent email forgery. To verify incoming mail, AsyncOS supports Sender Policy Framework (SPF), Sender ID Framework (SIDF), DomainKeys Identified Mail (DKIM), Domain-based Message Authentication, Reporting and Conformance (DMARC), and Forged Email Detection. To authenticate outbound mail, AsyncOS supports DomainKeys and DKIM signing.

Related Topics

- [DomainKeys and DKIM Authentication, on page 577](#)
- [Overview of SPF and SIDF Verification, on page 597](#)
- [DMARC Verification, on page 608](#)
- [Forged Email Detection, on page 616](#)

DomainKeys and DKIM Authentication

With DomainKeys or DKIM email authentication, the sender signs the email using public key cryptography. The verified domain can then be used to detect forgeries by comparing it with the domain in the From: (or Sender:) header of the email.

DomainKeys and DKIM consist of two main parts: signing and verification. AsyncOS supports the “signing” half of the process for DomainKeys, and it supports both signing and verification for DKIM. You can also enable bounce and delay messages to use DomainKeys and DKIM signing.

Related Topics

- [DomainKeys and DKIM Authentication Workflow, on page 578](#)
- [DomainKeys and DKIM Signing in AsyncOS, on page 578](#)

DomainKeys and DKIM Authentication Workflow

Figure 36: Authentication Work Flow

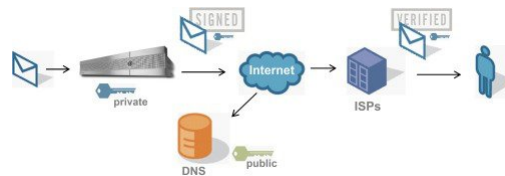

1. Administrator (domain owner) publishes a public key into the DNS name space.
2. Administrator loads a private key in the outbound Mail Transfer Agent (MTA).
3. Email submitted by an authorized user of that domain is digitally signed with the respective private key. The signature is inserted in the email as a DomainKey or DKIM signature header and the email is transmitted.
4. Receiving MTA extracts the DomainKeys or DKIM signature from the header and the claimed sending domain (via the Sender: or From: header) from the email. The public key is retrieved from the claimed signing domain which is extracted from DomainKeys or DKIM signature header fields.
5. The public key is used to determine whether the DomainKeys or DKIM signature was generated with the appropriate private key.

To test your outgoing DomainKeys signatures, you can use a Yahoo! or Gmail address, as these services are free and provide validation on incoming messages that are DomainKeys signed.

DomainKeys and DKIM Signing in AsyncOS

DomainKeys and DKIM signing in AsyncOS is implemented via domain profiles and enabled via a mail flow policy (typically, the outgoing “relay” policy). For more information, see the “Configuring the Gateway to Receive Mail” chapter. Signing the message is the last action performed by the appliance before the message is sent.

Domain profiles associate a domain with domain key information (signing key and related information). As email is sent via a mail flow policy on the appliance, sender email addresses that match any domain profile are DomainKeys signed with the signing key specified in the domain profile. If you enable both DKIM and DomainKeys signing, the DKIM signature is used. You implement DomainKeys and DKIM profiles via the `domainkeysconfig` CLI command or via the Mail Policies > Domain Profiles and the Mail Policies > Signing Keys pages in the GUI.

DomainKeys and DKIM signing works like this: a domain owner generates two keys — a public key stored in the public DNS (a DNS TXT record associated with that domain) and a private key that is stored on the appliance is used to sign mail that is sent (mail that originates) from that domain.

As messages are received on a listener used to send messages (outbound), the appliance checks to see if any domain profiles exist. If there are domain profiles created on the appliance (and implemented for the mail flow policy), the message is scanned for a valid Sender: or From: address. If both are present, the Sender: header is always used for Domain Keys and DKIM Signing, but the From: header is also required even though it is not used for DKIM signing. When only the Sender: header is present, the DomainKeys or DKIM Signing profiles are not matched. The From: header is only used when:

- There is no Sender: header.
- You select the Use From Header for DKIM Signing option in the DKIM Global Setting page in the web interface.



Note From AsyncOS 10.0 and later, you can select whether you want to use the From: header for DKIM Signing option in the DKIM Global Settings page of the web interface. It is mainly important to use the From: header with DKIM Signing for proper DMARC verification.

If a valid address is not found, the message is not signed and the event is logged in the mail_logs.



Note If you create both a DomainKey and DKIM profile (and enable signing on a mail flow policy), AsyncOS signs outgoing messages with both a DomainKeys and DKIM signature.

If a valid sending address is found, the sending address is matched against the existing domain profiles. If a match is found, the message is signed. If not, the message is sent without signing. If the message has an existing DomainKeys (a “DomainKey-Signature:” header) the message is only signed if a new sender address has been added after the original signing. If a message has an existing DKIM signature, a new DKIM signature is added to the message.

AsyncOS provides a mechanism for signing email based on domain as well as a way to manage (create new or input existing) signing keys.

The configuration descriptions in this document represent the most common uses for signing and verification. You can also enable DomainKeys and DKIM signing on a mail flow policy for inbound email, or enable DKIM verification on a mail flow policy for outbound email.



Note When you configure domain profiles and signing keys in a clustered environment, note that the Domain Key Profile settings and Signing Key settings are linked. Therefore, if you copy, move or delete a signing key, the same action is taken on the related profile.

Configuring DomainKeys and DKIM Signing

Related Topics

- [Signing Keys, on page 580](#)
- [Public Keys, on page 580](#)
- [Domain Profiles, on page 581](#)

- [Enabling Signing for Bounce and Delay Messages, on page 582](#)
- [Enabling Signing for Outgoing Mail, on page 582](#)
- [Configuring DomainKeys/DKIM Signing \(GUI\), on page 583](#)
- [Domain Keys and Logging, on page 591](#)

Signing Keys

A signing key is the private key stored on the appliance . When creating a signing key, you specify a key size. Larger key sizes are more secure; however, larger keys also can impact performance. The appliance supports keys from 512 bits up to 2048 bits. The 768 - 1024 bit key sizes are considered secure and used by most senders today. Keys based on larger key sizes can impact performance and are not supported above 2048 bits. For more information about creating signing keys, see [Creating or Editing a Signing Key, on page 586](#).

If you are entering an existing key, simply paste it into the form. Another way to use existing signing keys is to import the key as a text file. For more information about adding existing signing keys, see [Importing or Entering Existing Signing Keys , on page 587](#).

Once a key is entered, it is available for use in domain profiles, and will appear in the Signing Key drop-down list in the domain profile.

Related Topics

- [Exporting and Importing Signing Keys, on page 580](#)

Exporting and Importing Signing Keys

You can export your signing keys to a text file on the appliance . When you export keys, all of the keys currently existing on the appliance are put into a text file. For more information about exporting keys, see [Exporting Signing Keys, on page 587](#).

You can import keys that have been exported as well.



Note

Importing keys causes all of the current keys on the appliance to be replaced.

For more information, see [Importing or Entering Existing Signing Keys , on page 587](#).

Public Keys

Once you have associated a signing key with a domain profile, you can create DNS text record which contains your public key. You do this via the Generate link in the DNS Text Record column in the domain profile listing (or via `domainkeysconfig -> profiles -> dnstxt` in the CLI):

For more information about generating a DNS Text Record, see [Generating a DNS Text Record , on page 588](#).

You can also view the public key via the View link on the Signing Keys page:

Figure 37: View Public Key Link on Signing Keys Page

Signing Keys

Signing Keys				
Add Key...		Clear All Keys Import Keys...		
Name	Key Size (Bits)	Public Key	Domain Profiles	All Delete
TestKey	768	View	ExampleProfile	<input type="checkbox"/>
Export Keys...				Delete

Domain Profiles

A domain profile associates a sender domain with a signing key, along with some other information needed for signing.

- A name for the domain profile.
- A domain name (the domain to be included in the “d=” header).
- A selector (a selector is used to form the query for the public key. In the DNS query type, this value is prepended to the “_domainkey.” namespace of the sending domain).
- A canonicalization method (the method by which the headers and content are prepared for presentation to the signing algorithm). AsyncOS supports both “simple” and “nofws” for DomainKeys and “relaxed” and “simple” for DKIM.
- A signing key (see [Signing Keys, on page 580](#) for more information).
- A list of headers and the body length to sign (DKIM only).
- A list of tags you want to include in the signature’s header (DKIM only). These tags store the following information:
 - The identity of the user or agent (e.g., a mailing list manager) on whose behalf the message is signed.
 - A comma-separated list of query methods used to retrieve the public key.
 - The timestamp of when the signature was created.
 - The expiration time of the signature, in seconds.
 - A vertical bar-separated (i.e., |) list of header fields present when the message was signed.
- The tags you want to include in the signature (DKIM only).
- A list of Profile Users (addresses allowed to use the domain profile for signing).



Note The domain in the addresses specified in the profile users must match the domain specified in the Domain field.

You can search through all of your existing domain profiles for a specific term. See [Searching Domain Profiles, on page 591](#) for more information.

Additionally, you can choose whether to:

- Sign system-generated messages with DKIM signatures
- Use From header for DKIM signing

For instructions, see [Editing DKIM Global Settings, on page 591](#).

Related Topics

- [Exporting and Importing Domain Profiles, on page 582](#)

Exporting and Importing Domain Profiles

You can export your existing domain profiles to a text file on the appliance. When you export the domain profiles, all of the profiles existing on the appliance are put into a single text file. See [Exporting Domain Profiles, on page 589](#).

You can import domain profiles that you have previously exported. Importing domain profiles causes all of the current domain profiles on the machine to be replaced. See [Importing Domain Profiles, on page 590](#).

Enabling Signing for Outgoing Mail

DomainKeys and DKIM signing is enabled on mail flow policies for outbound mail. For more information, see the “Configuring the Gateway to Receive Mail” chapter.

Procedure

- Step 1** On the Mail Flow Policies page (from the Mail Policies menu), click on the RELAYED mail flow policy (outgoing).
- Step 2** From the Security Features section, enable DomainKeys/DKIM Signing by selecting On.
- Step 3** Submit and commit your changes.
-

Enabling Signing for Bounce and Delay Messages

In addition to signing outbound messages, you may want to sign bounce and delay messages. You may want to do this to alert recipients that the bounce and delay messages they receive from your company are legitimate. To enable DomainKeys and DKIM signing for bounce and delay messages, you enable DomainKeys/DKIM signing for the bounce profile associated with the public listener.

Procedure

- Step 1** On the bounce profile associated with the public listener where you will send signed outbound messages, go to Hard Bounce and Delay Warning Messages.
- Step 2** Enable “Use Domain Key Signing for Bounce and Delay Messages”:

Note You must have completed all steps listed in [Configuring DomainKeys/DKIM Signing \(GUI\), on page 583](#) to sign bounced and delay messages.

The From: address in the domain profile must match the address used for the bounce return address. To ensure these addresses match, you can configure a return address for the bounce profile (System Administration > Return Addresses), and then use the same name in the Profile Users list in the domain profile. For example, you would configure a return address of MAILER-DAEMON@example.com for the bounce return address, and add MAILER-DAEMON@example.com as a profile user in the domain profile.

It is recommended that you avoid changing return addresses on Cloud Email Security appliances.

Configuring DomainKeys/DKIM Signing (GUI)

Procedure

- Step 1** Create a new or import an existing private key. For information on creating or importing signing keys, see [Signing Keys, on page 580](#).
- Step 2** Create a domain profile and associate the key with the domain profile. For information on creating a domain profile, see [Domain Profiles, on page 581](#).
- Step 3** Create the DNS text record. For information about creating the DNS text record, see [Generating a DNS Text Record , on page 588](#).
- Step 4** If you have not already done so, enable DomainKeys/DKIM signing on a mail flow policy for outbound mail (see [Enabling Signing for Outgoing Mail, on page 582](#)).
- Step 5** Optionally, enable DomainKeys/DKIM signing for bounced and delay messages. For information about enabling signing for bounce and delay messages, see [Enabling Signing for Bounce and Delay Messages, on page 582](#).
- Step 6** Send email. Mail sent from a domain that matches a domain profile will be DomainKeys/DKIM signed. In addition, bounce or delay messages will be signed if you configured signing for bounce and delay messages.
- Note** If you create both a DomainKey and DKIM profile (and enable signing on a mail flow policy), AsyncOS signs outgoing messages with both a DomainKeys and DKIM signature.
-

What to do next

Related Topics

- [Creating Domain Profiles for DomainKeys Signing, on page 583](#)
- [Creating a New Domain Profile for DKIM Signing, on page 584](#)
- [Creating or Editing a Signing Key, on page 586](#)
- [Importing or Entering Existing Signing Keys , on page 587](#)
- [Testing Domain Profiles, on page 589](#)
- [Editing DKIM Global Settings, on page 591](#)

Creating Domain Profiles for DomainKeys Signing

Procedure

- Step 1** Choose **Mail Policies > Signing Profiles**.
- Step 2** In the **Domain Signing Profiles** section, click **Add Profile**.
- Step 3** Enter a name for the profile.
- Step 4** For the **Domain Key Type**, choose **Domain Keys**.

Additional options appear on the page.

- Step 5** Enter the domain name.
- Step 6** Enter a selector. Selectors are arbitrary names prepended to the "_domainkey" namespace, used to help support multiple concurrent public keys per sending domain. A selector value and length must be legal in the DNS namespace and in email headers with the additional provision that they cannot contain a semicolon.
- Step 7** Select the canonicalization (no forwarding whitespaces or simple).
- Step 8** If you have already created a signing key, select a signing key. Otherwise, skip to the next step. You must create (or import) at least one signing key in order to have signing keys to choose from in the list. See [Creating or Editing a Signing Key, on page 586](#).
- Step 9** Enter users (email addresses, hosts, etc.) that will use the domain profile for signing.
- Step 10** Submit and commit your changes.
- Step 11** At this point (if you have not already) you should enable DomainKeys/DKIM signing on an outgoing mail flow policy (see [Enabling Signing for Outgoing Mail, on page 582](#)).
- Note** If you create both a DomainKeys and DKIM profile, AsyncOS performs both DomainKeys and DKIM signing on outgoing mail.

Creating a New Domain Profile for DKIM Signing

Procedure

- Step 1** Choose **Mail Policies > Signing Profiles**.
- Step 2** In the **Domain Signing Profiles** section, click **Add Profile**.
- Step 3** Enter a name for the profile.
- Step 4** For the **Domain Key Type**, choose **DKIM**.
- Additional options appear on the page.
- Step 5** Enter the domain name.
- Step 6** Enter a selector. Selectors are arbitrary names prepended to the "_domainkey." namespace, used to help support multiple concurrent public keys per sending domain. A selector value and length must be legal in the DNS namespace and in email headers with the additional provision that they cannot contain a semicolon.
- Step 7** Select the canonicalization for the header. Choose from the following options:
- **Relaxed.** The “relaxed” header canonicalization algorithm performs the following: header names are changed to lowercase, headers are unfolded, linear white spaces are reduced to a single space, leading and trailing spaces are stripped.
 - **Simple.** No changes to headers are made.
- Step 8** Select the canonicalization for the body. Choose from the following options:
- **Relaxed.** The “relaxed” header canonicalization algorithm performs the following: empty lines are stripped at the end of the body, white spaces are reduced to a single space within lines, and trailing white spaces are stripped in lines.
 - **Simple.** Empty lines at the end of the body are stripped.

Step 9 If you have already created a signing key, select a signing key. Otherwise, skip to the next step. You must create (or import) at least one signing key in order to have signing keys to choose from in the list. See [Creating or Editing a Signing Key, on page 586](#).

Step 10 Select the list of headers to sign. You can select from the following headers:

- **All.** AsyncOS signs all the headers present at the time of signature. You may want to sign all headers if you do not expect headers to be added or removed in transit.
- **Standard.** You may want to select the standard headers if you expect that headers may be added or removed in transit. AsyncOS signs only the following standard headers (if the header is not present in the message, the DKIM signature indicates a null value for the header):
 - From
 - Sender, Reply To-
 - Subject
 - Date, Message-ID
 - To, Cc
 - MIME-Version
 - Content-Type, Content-Transfer-Encoding, Content-ID, Content-Description
 - Resent-Date, Resent-From, Resent-Sender, Resent-To, Resent-cc, Resent-Message-ID
 - In-Reply-To, References
 - List-Id, List-Help, List-Unsubscribe, List-Subscribe, List-Post, List-Owner, List-Archive

Note When you select “Standard”, you can add additional headers to sign.

Step 11 Specify how to sign the message body. You can choose to sign the message body, and/or how many bytes to sign. Select one of the following options:

- **Whole Body Implied.** Do not use the “l=” tag to determine body length. The entire message is signed and no changes are allowed.
- **Whole Body Auto-determined.** The entire message body is signed, and appending some additional data to the end of body is allowed during transit.
- **Sign first _ bytes.** Sign the message body up to the specified number of bytes.

Step 12 Select the tags you want to include in the message signature’s header field. The information stored in these tags are used for message signature verification. Select one or more of the following options:

- **“i” Tag.** The identity of the user or agent (e.g., a mailing list manager) on behalf of which this message is signed. Enter the domain name prepended with the @ symbol, such as the domain @example.com .
- **“q” Tag.** A colon-separated list of query methods used to retrieve the public key. Currently, the only valid value is dns/txt.
- **“t” Tag.** A timestamp for when the signature was created.
- **“x” Tag.** The absolute date and time when the signature expires. Specify an expiration time (in seconds) for the signature. The default is 31536000 seconds.
- **“z” Tag.** A vertical bar-separated (i.e., |) list of header fields present when the message was signed. This includes the names of the header fields and their values. For example:

```
z=From:admin@example.com|To:joe@example.com|
Subject:test%20message|Date:Date:August%2026,%202011%205:30:02%20PM%20-0700
```

Step 13 Enter users (email addresses, hosts, etc.) that will use the domain profile for signing.

Note When you create domain profiles, be aware that a hierarchy is used in determining the profile to associate with a particular user. For example, you create a profile for example.com and another profile for joe@example.com. When mail is sent from joe@example.com, the profile for joe@example.com is used. However, when mail is sent from adam@example.com, the profile for example.com is used.

Step 14 Submit and commit your changes.

Step 15 At this point (if you have not already) you should enable DomainKeys/DKIM signing on an outgoing mail flow policy (see [Enabling Signing for Outgoing Mail, on page 582](#)).

Note If you create both a DomainKeys and DKIM profile, AsyncOS performs both DomainKeys and DKIM signing on outgoing mail.

Creating or Editing a Signing Key

- [Create a New Signing Key, on page 586](#)
- [Edit an Existing Signing Key, on page 586](#)

Create a New Signing Key

Signing keys are required for domain profiles for DomainKeys and DKIM signing.

Procedure

Step 1 Choose **Mail Policies > Signing Keys**.

Step 2 Click **Add Key**.

Step 3 Enter a name for the key.

Step 4 Click **Generate** and select a key size.

Step 5 Submit and commit your changes.

Note If you have not done so already, you may need to edit your domain profile to assign the key.

Edit an Existing Signing Key

Procedure

Step 1 Choose **Mail Policies > Signing Keys**.

Step 2 Click the intended signing key.

Step 3 Edit the intended fields as described in [Create a New Signing Key, on page 586](#).

- Step 4** Submit and commit your changes.
-

Exporting Signing Keys

All keys on the appliance are exported together in a single text file.

Procedure

- Step 1** Choose **Mail Policies > Signing Keys**.
- Step 2** Click **Export Keys**.
- Step 3** Enter a name for the file and click **Submit**.
-

Importing or Entering Existing Signing Keys

Related Topics

- [Pasting a Key](#) , on page 587
- [Importing Keys from an Existing Export File](#) , on page 587

Pasting a Key

Procedure

- Step 1** Choose **Mail Policies > Signing Keys**.
- Step 2** Click **Add Key**.
- Step 3** Paste the key into the Paste Key field (must be PEM-formatted and must be RSA keys only).
- Step 4** Submit and commit your changes.
-

Importing Keys from an Existing Export File



- Note** To obtain a key file, see [Exporting Signing Keys](#), on page 587.
-

Procedure

- Step 1** Choose **Mail Policies > Signing Keys**.
- Step 2** Click **Import Keys**.
- Step 3** Select the file that contains the exported signing keys.

- Step 4** Click **Submit**. You are warned that importing will replace all existing signing keys. All of the keys in the text file are imported.
- Step 5** Click **Import**.
-

Deleting Signing Keys

Related Topics

- [Removing Selected Signing Keys](#) , on page 588
- [Removing All Signing Keys](#) , on page 588

Removing Selected Signing Keys

Procedure

- Step 1** Choose **Mail Policies > Signing Keys**.
- Step 2** Mark the checkbox to the right of each signing key to remove.
- Step 3** Click **Delete**.
- Step 4** Confirm the deletion.
-

Removing All Signing Keys

Procedure

- Step 1** Choose **Mail Policies > Signing Keys**.
- Step 2** Click **Clear All Keys** on the Signing Keys page.
- Step 3** Confirm the deletion.
-

Generating a DNS Text Record

Procedure

- Step 1** Choose **Mail Policies > Signing Profiles**.
- Step 2** In the Domain Signing Profiles section, in the DNS Text Record column, click the **Generate** link for the corresponding domain profile.
- Step 3** Mark the checkbox for the attributes you wish to include in the DNS text record.
- Step 4** Click **Generate Again** to re-generate the key with any changes you have made.
- Step 5** The DNS text record is displayed in the text field at the bottom of the window (where you can now copy it). In some cases, multi-string DNS text records are generated. See [Multi-string DNS Text Records](#), on page 589.

Step 6 Click **Done**.

What to do next

Related Topics

- [Multi-string DNS Text Records, on page 589](#)

Multi-string DNS Text Records

Multi-string DNS text records may be generated if the key size of the signing key used to generate the DNS text records are larger than 1024 bits. This is because not more than 255 characters are allowed in a single string of a DNS text record. The DKIM authentication may fail as some of the DNS servers do not accept or serve multi-string DNS text records.

To avoid this scenario, it is recommended that you use double quotes to break up the multi-string DNS text record into smaller strings not exceeding 255 bytes. The following is an example.

```
s._domainkey.domain.com. IN TXT "v=DKIM1;"
"p=MIIBIjANBgkqhkiG9w0BAQEFAAOCAQ8AMIIBCgKCAQE"
"A4Vbhjq2n/3DbEk6EHdeVXlIXFT7OE181amoZLbvWMX+bej"
"CdxcsFV3uS7G8oOJSWBP0z++nTQmy9ZDWfaiopU6k7tzoI"
"+oRDlKkhCQrM4oP2B2F5sTDkYwPY3Pen2jgC2OgbPnbo3o"
"m3c1wMWgSoZxozUE4ly5kPuK9fTtpeJHNiZAqkFICiev4yrkL"
"R+SmFsJn9MYH5+lchyZ74BVm+16Xq2mptWXEwpiwOxWI"
"YHXsZo2zRjedrQ45vmgb8xUx5ioYY9/yBLHudGc+GUKTj1i4"
"mQg48yCD/HVNfsSRXaPinliEkypH9cSngvWuIYUQz0dHU;"
```

DKIM implementations reassemble DNS text records broken down this way into the full original single string before processing them.

Testing Domain Profiles

Once you have created a signing key, associated it with a domain profile, and generated and inserted the DNS text into your authorized DNS, you can test your domain profile.

Procedure

- Step 1** Choose **Mail Policies > Signing Profiles**.
- Step 2** In the **Domain Signing Profiles** section, in the Test Profile column, click the **Test** link for the domain profile.
- Step 3** A message is displayed at the top of the page, indicating success or failure. If the test fails, a warning message is displayed, including the error text.
-

Exporting Domain Profiles

All domain profiles on the appliance are exported together in a single text file.

Procedure

- Step 1** Choose **Mail Policies > Signing Profiles**.
 - Step 2** Click **Export Domain Profiles**.
 - Step 3** Enter a name for the file and click **Submit**.
-

Importing Domain Profiles

Procedure

- Step 1** Choose **Mail Policies > Signing Profiles**.
 - Step 2** Click **Import Domain Profiles**.
 - Step 3** Select the file that contains the exported domain profiles.
 - Step 4** Click **Submit**. You are warned that importing will replace all existing domain profiles. All of the domain profiles in the text file are imported.
 - Step 5** Click **Import**.
-

Deleting Domain Profiles

Related Topics

- [Removing Selected Domain Profiles](#) , on page 590
- [Removing All Domain Profiles](#) , on page 590

Removing Selected Domain Profiles

Procedure

- Step 1** Choose **Mail Policies > Signing Profiles**.
 - Step 2** Mark the checkbox to the right of each domain profile to remove.
 - Step 3** Click **Delete**.
 - Step 4** Confirm the deletion.
-

Removing All Domain Profiles

Procedure

- Step 1** Choose **Mail Policies > Signing Profiles**.
- Step 2** Click **Clear All Profiles**.

Step 3 Confirm the deletion.

Searching Domain Profiles

Procedure

Step 1 Choose **Mail Policies > Signing Profiles**.

Step 2 In the Find Domain Profiles section, specify the search term.

Step 3 Click **Find Profiles**.

Step 4 The search scans the following fields for each domain profile: email, domain, selector, and signing key name.

Note If you do not enter search terms, the search engine returns all domain profiles.

Editing DKIM Global Settings

You can use the DKIM Global Settings to choose whether to:

- Sign system-generated messages with a DKIM signature. The appliance will sign the following messages:
 - Cisco IronPort Spam Quarantine notifications
 - Content filter-generated notifications
 - Configuration messages
 - Support requests
- Use From header for DKIM signing

Procedure

Step 1 Choose **Mail Policies > Signing Profiles**.

Step 2 Under DKIM Global Settings, click **Edit Settings**.

Step 3 Depending on your requirements, configure the following fields:

- DKIM Signing of System Generated Messages
- Use From header for DKIM Signing

Note If you are not using From header for DKIM signing or if a valid From header is missing, Sender header will be used. For DMARC verification of DKIM signed messages, you must use the From header during DKIM signing.

Step 4 Submit and commit your changes.

Domain Keys and Logging

Lines such as the following are added to the mail logs upon DomainKeys signing:

```
Tue Aug 28 15:29:30 2007 Info: MID 371 DomainKeys: signing with dk-profile - matches
user123@example.com
Tue Aug 28 15:34:15 2007 Info: MID 373 DomainKeys: cannot sign - no profile matches
user12@example.com
```

Lines such as these are added to the mail logs upon DKIM signing:

```
Tue Aug 28 15:29:54 2007 Info: MID 372 DKIM: signing with dkim-profile - matches
user@example.com
Tue Aug 28 15:34:15 2007 Info: MID 373 DKIM: cannot sign - no profile matches
user2@example.com
```

How to Verify Incoming Messages Using DKIM

How to Verify Incoming Messages Using DKIM

	Do This	More Info
Step 1	Create a profile for verifying messages using DKIM.	Creating a DKIM Verification Profile, on page 594
Step 2	(Optional) Create a custom mail flow policy to use for verifying incoming messages using DKIM.	Defining Rules for Incoming Messages Using a Mail Flow Policy, on page 107
Step 3	Configure your mail flow policies to verify incoming messages using DKIM.	Configuring DKIM Verification on the Mail Flow Policy, on page 596
Step 4	Define the action that the appliance takes on verified messages.	Configuring an Action for DKIM Verified Mail, on page 597
Step 5	Associate the action with groups of specific senders or recipients.	Configuring Mail Policies, on page 263

Related Topics

- [DKIM Verification Checks Performed by AsyncOS, on page 592](#)
- [Managing DKIM Verification Profiles, on page 593](#)
- [Configuring DKIM Verification on the Mail Flow Policy, on page 596](#)
- [Configuring an Action for DKIM Verified Mail, on page 597](#)

DKIM Verification Checks Performed by AsyncOS

When you configure an AsyncOS appliance for DKIM verification, the following checks are performed:

Procedure

- Step 1** AsyncOS checks for the DKIM-Signature field in incoming mail, the syntax of the signature header, valid tag values, and required tags. If the signature fails any of these checks, AsyncOS returns a *permfail*.

- Step 2** After the signature check is performed, the public key is retrieved from the public DNS record, and the TXT record is validated. If errors are encountered during this process, AsyncOS returns a *permfail*. A *tempfail* occurs if the DNS query for the public key fails to get a response.
- Step 3** After retrieving the public key, AsyncOS checks the hashed values and verifies the signature. If any failures occur during this step, AsyncOS returns a *permfail*.
- Step 4** If the checks all pass, AsyncOS returns a *pass*.

Note When the message body is greater than the specified length, AsyncOS returns the following verdict:

```
dkim = pass (partially verified [x bytes])
```

where X represents the number of bytes verified.

The final verification result is entered as an *Authentication-Results* header. For example, you might get a header that looks like one of the following:

```
Authentication-Results: example1.com
```

```
header.from=From:user123@example.com; dkim=pass (signature verified)
```

```
Authentication-Results: example1.com
```

```
header.from=From:user123@example.com; dkim=pass (partially verified [1000 bytes])
```

```
Authentication-Results: example1.com
```

```
header.from=From:user123@example.com; dkim=permfail (body hash did not verify)
```

Note Current DKIM verification stops at the first valid signature. It is not possible to verify using the last signature encountered. This functionality may be available in a later release.

When the domain has its DNS TXT record in DKIM Test Mode ($t=y$), the appliance completely skips any DKIM Verifications and Actions.

Managing DKIM Verification Profiles

A DKIM verification profile is a list of parameters that the appliance's mail flow policies use for verifying DKIM signatures. For example, you can create two verification profiles, one that allows 30 seconds before a query times out and a second that allows only 3 seconds before a query times out. You can assign the second verification profile to the Throttled mail flow policy to prevent connection starvation in case of a DDoS. A verification profile consists of the following information:

- A name for the verification profile.
- The smallest and largest acceptable public key size. The default key sizes are 512 and 2048, respectively.
- The maximum number of signatures in the message to verify. If a message has more signatures than the maximum amount you defined, the appliance skips verification of the remaining signatures and continues to process the message. The default is 5 signatures.
- The maximum allowed difference in time (in seconds) between the sender's system time and verifier's. For example, if the message signature expires at 05:00:00 and the verifier's system time is 05:00:30, the message signature is still valid if the allowed difference in time is 60 seconds but it is invalid if the allowed difference is 10 seconds. The default is 60 seconds.
- An option whether to use a body length parameter.
- The SMTP action to take in case of a temporary failure.

- The SMTP action to take in case of a permanent failure.

You can search through all of your existing verification profiles by the profile name.

You can export your DKIM verification profiles as a text file in your appliance's configure directory. When you export the verification profiles, all of the profiles existing on the appliance are put into a single text file. See [Exporting DKIM Verification Profiles, on page 595](#) for more information.

You can import DKIM verification profiles that you previously exported. Importing DKIM verification profiles causes all of the current DKIM verification profiles on the machine to be replaced. See [Importing DKIM Verification Profiles, on page 595](#) for more information.

Related Topics

- [Creating a DKIM Verification Profile, on page 594](#)
- [Exporting DKIM Verification Profiles, on page 595](#)
- [Importing DKIM Verification Profiles, on page 595](#)
- [Deleting DKIM Verification Profiles, on page 595](#)
- [Searching DKIM Verification Profiles, on page 596](#)

Creating a DKIM Verification Profile

Procedure

-
- Step 1** Click **Mail Policies > Verification Profiles**.
- Step 2** Click **Add Profile**.
- Step 3** Enter the name of the profile.
- Step 4** Select the minimum key size you want the appliance to accept for signing keys.
- Step 5** Select the maximum key size you want the appliance to accept for signing keys.
- Step 6** Select the maximum number of signatures to verify in a single message. The default is five signatures.
- Step 7** Select the number of seconds before the key query times out. The default is 10 seconds.
- Step 8** Select maximum allowed difference in time (in seconds) between the sender's system time and verifier's. The default is 60 seconds.
- Step 9** Select whether to use the body-length parameter in the signature to verify the message.
- Step 10** Select whether the appliance accepts or rejects the message if there is a temporary failure when verifying its signature. If you want the appliance to reject the message, you can choose to have it send the default 451 SMTP response code or another SMTP response code and text.
- Step 11** Select whether the appliance accepts or rejects the message if there is a permanent failure when verifying its signature. If you want the appliance to reject the message, you can choose to have it send the default 451 SMTP response code or another SMTP response code and text.
- Step 12** Submit your changes.
The new profile appears in the DKIM Verification Profiles table.
- Step 13** Commit your changes.
- Step 14** At this point you should enable DKIM verification on an incoming mail flow policy and select the verification profile you want to use.
-

Exporting DKIM Verification Profiles

All DKIM verification profiles on the appliance are exported as a single text file and saved in the configuration directory on the appliance .

Procedure

- Step 1** Choose **Mail Policies > Verification Profiles**.
 - Step 2** Click **Export Profiles**.
 - Step 3** Enter a name for the file and click **Submit**.
-

Importing DKIM Verification Profiles

Procedure

- Step 1** Choose **Mail Policies > Verification Profiles**.
 - Step 2** Click **Import Profiles**.
 - Step 3** Select the file that contains the DKIM verification profiles.
 - Step 4** Click **Submit**. You are warned that importing will replace all existing DKIM verification profiles.
 - Step 5** Click **Import**.
-

Deleting DKIM Verification Profiles

Related Topics

- [Removing Selected DKIM Verification Profiles](#) , on page 595
- [Removing All DKIM Verification Profiles](#), on page 596

Removing Selected DKIM Verification Profiles

Procedure

- Step 1** Choose **Mail Policies > Verification Profiles**.
 - Step 2** Mark the checkbox to the right of each DKIM verification profile you want to delete.
 - Step 3** Click **Delete**.
 - Step 4** Confirm the deletion.
-

Removing All DKIM Verification Profiles

Procedure

- Step 1** Choose **Mail Policies > Verification Profiles**.
 - Step 2** Click **Clear All Profiles**.
 - Step 3** Confirm the deletion.
-

Searching DKIM Verification Profiles

To search all DKIM verification profiles for a specific term in the profile name:

Procedure

- Step 1** Choose **Mail Policies > Verification Profiles**.
- Step 2** In the **Search DKIM Verification Profiles** section, specify the search term.
- Step 3** Click **Find Profiles**.

The search scans the profile name for each DKIM verification profile.

If you do not enter search terms, the search engine returns all DKIM verification profiles.

Configuring DKIM Verification on the Mail Flow Policy

DKIM verification is enabled on mail flow policies for incoming email.

Procedure

- Step 1** Choose **Mail Policies > Mail Flow Policies**.
 - Step 2** Click the incoming mail policy for the listener where you want to perform verification.
 - Step 3** In the Security Features section of the mail flow policy, enable DKIM Verification by selecting **On**.
 - Step 4** Select the DKIM verification profile that you want to use for the policy.
 - Step 5** Commit your changes.
-

What to do next

Related Topics

- [DKIM Verification and Logging, on page 597](#)

DKIM Verification and Logging

Lines such as the following are added to the mail logs upon DKIM verification:

```
mail.current:Mon Aug 6 13:35:38 2007 Info: MID 17 DKIM: no signature
mail.current:Mon Aug 6 15:00:37 2007 Info: MID 18 DKIM: verified pass
```

Configuring an Action for DKIM Verified Mail

When you verify DKIM mail, an *Authentication-Results* header is added to the mail, but the mail is accepted regardless of the authentication result. To configure actions based on these authentication results, you can create a content filter to perform actions on the DKIM-verified mail. For example, if DKIM verification fails, you may want configure the mail to be delivered, bounced, dropped, or sent to a quarantine. To do this, you must configure an action using a content filter.

Procedure

- Step 1** Choose **Mail Policies > Incoming Content Filters**.
 - Step 2** Click **Add Filter**.
 - Step 3** In the Conditions section, click **Add Condition**.
 - Step 4** Select **DKIM Authentication** from the list of conditions.
 - Step 5** Choose a DKIM condition. Select one of the following options:
 - **Pass**. The message passed the authentication tests.
 - **Neutral**. Authentication was not performed.
 - **Temperror**. A recoverable error occurred.
 - **Permerror**. An unrecoverable error occurred.
 - **Hardfail**. The authentication tests failed.
 - **None**. The message was not signed.
 - Step 6** Select an action to associate with the condition. For example, if the DKIM verification fails, you may want to notify the recipient and bounce the message. Or, if DKIM verification passes, you may want to deliver the message immediately without further processing.
 - Step 7** Submit the new content filter.
 - Step 8** Enable the content filter on the appropriate incoming mail policy.
 - Step 9** Commit your changes.
-

Overview of SPF and SIDF Verification

AsyncOS supports Sender Policy Framework (SPF) and Sender ID Framework (SIDF) verification. SPF and SIDF are methods for verifying authenticity of email based on DNS records. SPF and SIDF allow the owner of an Internet domain to use a special format of DNS TXT records to specify which machines are authorized

to transmit email for that domain. Compliant mail receivers then use the published SPF records to test the authorization of the sending Mail Transfer Agent's identity during a mail transaction.

When you use SPF/SIDF authentication, the senders publish SPF records specifying which hosts are permitted to use their names, and compliant mail receivers use the published SPF records to test the authorization of the sending Mail Transfer Agent's identity during a mail transaction.



Note Because SPF checks require parsing and evaluation, AsyncOS performance may be impacted. In addition, be aware that SPF checks increase the load on your DNS infrastructure.

When you work with SPF and SIDF, note that SIDF is similar to SPF, but it has some differences. To get a full description of the differences between SIDF and SPF, see RFC 4406. For the purposes of this documentation, the two terms are discussed together except in the cases where only one type of verification applies.



Note AsyncOS does not support SPF for incoming relays.

Related Topics

- [A Note About Valid SPF Records, on page 598](#)

A Note About Valid SPF Records

To use SPF and SIDF with an appliance, publish the SPF record according to the RFCs 4406, 4408, and 7208. Review RFC 4407 for a definition of how the PRA identity is determined. You may also want to refer to the following website to view common mistakes made when creating SPF and SIDF records:

http://www.openspf.org/FAQ/Common_mistakes

Related Topics

- [Valid SPF Records, on page 598](#)
- [Valid SIDF Records, on page 598](#)
- [Testing Your SPF Records, on page 599](#)

Valid SPF Records

To pass the SPF HELO check, ensure that you include a “v=spf1 a –all” SPF record for each sending MTA (separate from the domain). If you do not include this record, the HELO check will likely result in a None verdict for the HELO identity. If you notice that SPF senders to your domain return a high number of None verdicts, these senders may not have included a “v=spf1 a –all” SPF record for each sending MTA.

Valid SIDF Records

To support the SIDF framework, you need to publish both “v=spf1” and “spf2.0” records. For example, your DNS record may look like the following example:

```
example.com. TXT "v=spf1 +mx a:colo.example.com/28 -all"
smtp-out.example.com TXT "v=spf1 a -all"
example.com. TXT "spf2.0/mfrom,pra +mx a:colo.example.com/28 -all"
```

SIDF does not verify the HELO identity, so in this case, you do not need to publish SPF v2.0 records for each sending MTA.



Note If you choose not to support SIDF, publish an “spf2.0/pr a ~all” record.

Testing Your SPF Records

In addition to reviewing the RFCs, it is a good idea to test your SPF records before you implement SPF verification on an appliance. There are several testing tools available on the [openspf.org](http://www.openspf.org) website:

<http://www.openspf.org/Tools>

You can use the following tool to determine why an email failed an SPF record check:

<http://www.openspf.org/Why>

In addition, you can enable SPF on a test listener and use Cisco’s trace CLI command (or perform trace from the GUI) to view the SPF results. Using trace, you can easily test different sending IPs.

How to Verify Incoming Messages Using SPF/SIDF

	Do This	More Info
Step 1	(Optional) Create a custom mail flow policy to use for verifying incoming messages using SPF/SIDF.	Defining Rules for Incoming Messages Using a Mail Flow Policy, on page 107
Step 2	Configure your mail flow policies to verify incoming messages using SPF/SIDF.	Enabling SPF and SIDF, on page 600
Step 3	Define the action that the appliance takes on verified messages.	Determining the Action to Take for SPF/SIDF Verified Mail, on page 604
Step 4	Associate the action with groups of specific senders or recipients.	Configuring Mail Policies, on page 263
Step 5	(Optional) Test the results of message verification.	Testing the SPF/SIDF Results, on page 607



Caution Although Cisco strongly endorses email authentication globally, at this point in the industry's adoption, Cisco suggests a cautious disposition for SPF/SIDF authentication failures. Until more organizations gain greater control of their authorized mail sending infrastructure, Cisco urges customers to avoid bouncing emails and instead quarantine emails that fail SPF/SIDF verification.



Note The AsyncOS command line interface (CLI) provides more control settings for SPF level than the web interface. Based on the SPF verdict, the appliance can accept or reject a message, in SMTP conversation, on a per listener basis. You can modify the SPF settings when editing the default settings for a listener's Host Access Table using the listenerconfig command. See the [Enabling SPF and SIDF via the CLI, on page 601](#) for more information on the settings.

Enabling SPF and SIDF

To use SPF/SIDF, you must enable SPF/SIDF for a mail flow policy on an incoming listener. You can enable SPF/SIDF on the listener from the default mail flow policy, or you can enable it for particular incoming mail flow policies.

Procedure

- Step 1** Choose **Mail Policies > Mail Flow Policy**.
- Step 2** Click **Default Policy Parameters**.
- Step 3** In the default policy parameters, view the Security Features section.
- Step 4** In the **SPF/SIDF Verification** section, click **On**.
- Step 5** Set the level of conformance (the default is SIDF-compatible). This option allows you to determine which standard of SPF or SIDF verification to use. In addition to SIDF conformance, you can choose SIDF-compatible, which combines SPF and SIDF

SPF/SIDF Conformance Levels

Conformance Level	Description
SPF	The SPF/SIDF verification behaves according to RFC4408 and RFC7208. - No purported responsible address (PRA) identity verification takes place. NOTE: Select this conformance option to test against the HELO identity.
SIDF	The SPF/SIDF verification behaves according to RFC4406. -The PRA Identity is determined with full conformance to the standard. - SPF v1.0 records are treated as spf2.0/mfrom,pra. - For a nonexistent domain or a malformed identity, a verdict of Fail is returned.
SIDF Compatible	The SPF/SIDF verification behaves according to RFC4406 <i>except for</i> the following differences: - SPF v1.0 records are treated as spf2.0/mfrom. - For a nonexistent domain or a malformed identity, a verdict of None is returned. NOTE: This conformance option was introduced at the request of the OpenSPF community (www.openspf.org).

Note More settings are available via the CLI. See [Enabling SPF and SIDF via the CLI, on page 601](#) for more information.

Step 6 If you choose a conformance level of SIDF-compatible, configure whether the verification downgrades a Pass result of the PRA identity to None if there are Resent-Sender: or Resent-From: headers present in the message. You might choose this option for security purposes.

Step 7 If you choose a conformance level of SPF, configure whether to perform a test against the HELO identity. You might use this option to improve performance by disabling the HELO check. This can be useful because the spf-passed filter rule checks the PRA or the MAIL FROM Identities first. The appliance only performs the HELO check for the SPF conformance level.

What to do next

Related Topics

- [The Received-SPF Header, on page 603](#)
- [Enabling SPF and SIDF via the CLI, on page 601](#)

Enabling SPF and SIDF via the CLI

The AsyncOS CLI supports more control settings for each SPF/SIDF conformance level. When configuring the default settings for a listener's Host Access Table, you can choose the listener's SPF/SIDF conformance level and the SMTP actions (ACCEPT or REJECT) that the appliance performs, based on the SPF/SIDF verification results. You can also define the SMTP response that the appliance sends when it rejects a message.

Depending on the conformance level, the appliance performs a check against the HELO identity, MAIL FROM identity, or PRA identity. You can specify whether the appliance proceeds with the session (ACCEPT) or terminates the session (REJECT) for each of the following SPF/SIDF verification results for each identity check:

- **None.** No verification can be performed due to the lack of information.
- **Neutral.** The domain owner does not assert whether the client is authorized to use the given identity.
- **SoftFail.** The domain owner believes the host is not authorized to use the given identity but is not willing to make a definitive statement.
- **Fail.** The client is not authorized to send mail with the given identity.
- **TempError.** A transient error occurred during verification.
- **PermError.** A permanent error occurred during verification.

The appliance accepts the message for a Pass result unless you configure the SIDF Compatible conformance level to downgrade a Pass result of the PRA identity to None if there are Resent-Sender: or Resent-From: headers present in the message. The appliance then takes the SMTP action specified for when the PRA check returns None.

If you choose not to define the SMTP actions for an identity check, the appliance automatically accepts all verification results, including Fail.

The appliance terminates the session if the identity verification result matches a REJECT action for any of the enabled identity checks. For example, an administrator configures a listener to accept messages based on

all HELO identity check results, including Fail, but also configures it to reject messages for a Fail result from the MAIL FROM identity check. If a message fails the HELO identity check, the session proceeds because the appliance accepts that result. If the message then fails the MAIL FROM identity check, the listener terminates the session and then returns the SMTP response for the REJECT action.

The SMTP response is a code number and message that the appliance returns when it rejects a message based on the SPF/SIDF verification result. The TempError result returns a different SMTP response from the other verification results. For TempError, the default response code is 451 and the default message text is #4.4.3 Temporary error occurred during SPF verification. For all other verification results, the default response code is 550 and the default message text is #5.7.1 SPF unauthorized mail is prohibited. You can specify your own response code and message text for TempError and the other verification results.

Optionally, you can configure the appliance to return a third-party response from the SPF publisher domain if the REJECT action is taken for Neutral, SoftFail, or Fail verification result. By default, the appliance returns the following response:

```
550-#5.7.1 SPF unauthorized mail is prohibited.
```

```
550-The domain example.com explains:
```

```
550 <Response text from SPF domain publisher>
```

To enable these SPF/SIDF settings, use the `listenerconfig -> edit` subcommand and select a listener. Then use the `hostaccess -> default` subcommand to edit the Host Access Table's default settings.

The following SPF control settings are available for the Host Access Table

SPF Control Settings via the CLI

Conformance Level	Available SPF Control Settings
SPF Only	<ul style="list-style-type: none"> • Whether to perform HELO identity check • SMTP actions taken based on the results of the following identity checks: <ul style="list-style-type: none"> • HELO identity (if enabled) • MAIL FROM Identity • SMTP response code and text returned for the REJECT action • Verification time out (in seconds)

Conformance Level	Available SPF Control Settings
SIDF Compatible	<ul style="list-style-type: none"> • Whether to perform a HELO identity check • Whether the verification downgrades a Pass result of the PRA identity to None if the Resent-Sender: or Resent-From: headers are present in the message. • SMTP actions taken based on the results of the following identity checks: <ul style="list-style-type: none"> • HELO identity (if enabled) • MAIL FROM Identity • PRA Identity • SMTP response code and text returned for the REJECT action. • Verification timeout (in seconds)
SIDF Strict	<ul style="list-style-type: none"> • SMTP actions taken based on the results of the following identity checks: <ul style="list-style-type: none"> • MAIL FROM Identity • PRA Identity • SMTP response code and text returned in case of SPF REJECT action. • Verification timeout (in seconds)

The appliance performs the HELO identity check and accepts the None and Neutral verification results and rejects the others. The CLI prompts for the SMTP actions are the same for all identity types. The user does not define the SMTP actions for the MAIL FROM identity. The appliance automatically accepts all verification results for the identity. The appliance uses the default reject code and text for all REJECT results.

You can also configure this in the command-line interface using the `listenerconfig` command.

The Received-SPF Header

When you configure AsyncOS for SPF/SIDF verification, it places an SPF/SIDF verification header (`Received-SPF`) in the email. The `Received-SPF` header contains the following information:

- **verification result** - the SPF verification result (see [Verification Results, on page 604](#)).
- **identity** - the identity that SPF verification checked: HELO, MAIL FROM, or PRA.
- **receiver** - the verifying host name (which performs the check).
- **client IP address** - the IP address of the SMTP client.
- **ENVELOPE FROM** - the envelope sender mailbox. (Note that this may be different from the MAIL FROM identity, as the MAIL FROM identity cannot be empty.)
- **x-sender** - the value of the HELO, MAIL FROM, or PRA identity.
- **x-conformance** - the level of conformance (see *Table - SPF/SIDF Conformance Levels*) and whether a downgrade of the PRA check was performed.

The following example shows a header added for a message that passed the SPF/SIDF check:

```
Received-SPF: Pass identity=pra; receiver=box.example.com;
client-ip=1.2.3.4; envelope-from="alice@foo.com";
x-sender="alice@company.com"; x-conformance=sidf_compatible
```



Note The `spf-status` and `spf-passed` filter rules use the received-SPF header to determine the status of the SPF/SIDF verification.

Determining the Action to Take for SPF/SIDF Verified Mail

When you receive SPF/SIDF verified mail, you may want to take different actions depending on the results of the SPF/SIDF verification. You can use the following message and content filter rules to determine the status of SPF/SIDF verified mail and perform actions on the messages based on the verification results:

- `spf-status`. This filter rule determines actions based on the SPF/SIDF status. You can enter a different action for each valid SPF/SIDF return value.
- `spf-passed`. This filter rule generalizes the SPF/SIDF results as a Boolean value.



Note The `spf-passed` filter rule is only available in message filters.

You can use the `spf-status` rule when you want to address more granular results, and use the `spf-passed` rule when you want to create a simple Boolean.

Related Topics

- [Verification Results, on page 604](#)
- [Using the spf-status Filter Rule in the CLI, on page 605](#)
- [spf-status Content Filter Rule in the GUI, on page 606](#)
- [Using the spf-passed Filter Rule, on page 606](#)

Verification Results

If you use the `spf-status` filter rule, you can check against the SPF/SIDF verification results using the following syntax:

```
if (spf-status == "Pass")
```

If you want a single condition to check against multiple status verdicts, you can use the following syntax:

```
if (spf-status == "PermError, TempError")
```

You can also check the verification results against the HELO, MAIL FROM, and PRA identities using the following syntax:

```
if (spf-status("pra") == "Fail")
```



Note You can only use the `spf-status` message filter rule to check results against HELO, MAIL FROM, and PRA identities. You cannot use the `spf-status` content filter rule to check against identities. The `spf-status` content filter checks only the PRA identity.

You can receive any of the following verification results:

- None - no verification can be performed due to the lack of information.
- Pass - the client is authorized to send mail with the given identity.
- Neutral - the domain owner does not assert whether the client is authorized to use the given identity.
- SoftFail - the domain owner believes the host is not authorized to use the given identity but is not willing to make a definitive statement.
- Fail - the client is not authorized to send mail with the given identity.
- TempError - a transient error occurred during verification.
- PermError - a permanent error occurred during verification.

Using the spf-status Filter Rule in the CLI

The following example shows the `spf-status` message filter in use:

```
skip-spam-check-for-verified-senders:

if (sendergroup == "TRUSTED" and spf-status == "Pass"){

skip-spamcheck();

}

quarantine-spf-failed-mail:

if (spf-status("pra") == "Fail") {

if (spf-status("mailfrom") == "Fail"){

# completely malicious mail

quarantine("Policy");

} else {

if(spf-status("mailfrom") == "SoftFail") {

# malicious mail, but tempting

quarantine("Policy");

}

}

} else {

if(spf-status("pra") == "SoftFail"){

if (spf-status("mailfrom") == "Fail"
```

```

or spf-status("mailfrom") == "SoftFail"){
# malicious mail, but tempting
quarantine("Policy");
}
}
}

stamp-mail-with-spf-verification-error:
if (spf-status("pra") == "PermError, TempError"
or spf-status("mailfrom") == "PermError, TempError"
or spf-status("helo") == "PermError, TempError"){
# permanent error - stamp message subject
strip-header("Subject");
insert-header("Subject", "[POTENTIAL PHISHING] $Subject");
}
.

```

spf-status Content Filter Rule in the GUI

You can also enable the `spf-status` rule from the content filters in the GUI. However, you cannot check results against HELO, MAIL FROM, and PRA identities when using the `spf-status` content filter rule.

To add the `spf-status` content filter rule from the GUI, click **Mail Policies > Incoming Content Filters**. Then add the SPF Verification filter rule from the Add Condition dialog box. Specify one or more verification results for the condition.

After you add the SPF Verification condition, specify an action to perform based on the SPF status. For example, if the SPF status is `SoftFail`, you might quarantine the message.

Using the spf-passed Filter Rule

The `spf-passed` rule shows the results of SPF verification as a Boolean value. The following example shows an `spf-passed` rule used to quarantine emails that are not marked as `spf-passed`:

```

quarantine-spf-unauthorized-mail:

if (not spf-passed) {

quarantine("Policy");

}

```



Note Unlike the `spf-status` rule, the `spf-passed` rule reduces the SPF/SIDF verification values to a simple Boolean. The following verification results are treated as not passed in the `spf-passed` rule: None, Neutral, Softfail, TempError, PermError, and Fail. To perform actions on messages based on more granular results, use the `spf-status` rule.

Testing the SPF/SIDF Results

Test the results of SPF/SIDF verification and use these results to determine how to treat SPF/SIDF failures because different organizations implement SPF/SIDF in different ways. Use a combination of content filters, message filters, and the Email Security Monitor - Content Filters report to test the results of the SPF/SIDF verification.

Your degree of dependence on SPF/SIDF verification determines the level of granularity at which you test SPF/SIDF results.

Related Topics

- [Basic Granularity Test of SPF/SIDF Results, on page 607](#)
- [Greater Granularity Test of SPF/SIDF Results, on page 607](#)

Basic Granularity Test of SPF/SIDF Results

To get a basic measure of the SPF/SIDF verification results for incoming mail, you can use content filters and the Email Security Monitor - Content Filters page. This test provides a view of the number of messages received for each type of SPF/SIDF verification result.

Procedure

- Step 1** Enable SPF/SIDF verification for a mail flow policy on an incoming listener, and use a content filter to configure an action to take. For information on enabling SPF/SIDF, see [Enabling SPF and SIDF, on page 600](#).
- Step 2** Create an `spf-status` content filter for each type of SPF/SIDF verification. Use a naming convention to indicate the type of verification. For example, use “SPF-Passed” for messages that pass SPF/SIDF verification, or “SPF-TempErr” for messages that weren’t passed due to a transient error during verification. For information about creating an `spf-status` content filter, see [spf-status Content Filter Rule in the GUI, on page 606](#).
- Step 3** After you have processed a number of SPF/SIDF verified messages, click **Monitor** > **Content Filters** to see how many messages triggered each of the SPF/SIDF verified content filters.

Greater Granularity Test of SPF/SIDF Results

For more comprehensive information about SPF/SIDF verification results, only enable SPF/SIDF verification for specific groups of senders, and review the results for those specific senders. Then, create a mail policy for that particular group and enable SPF/SIDF verification on the mail policy. Create content filters and review the Content Filters report as explained in [Basic Granularity Test of SPF/SIDF Results, on page 607](#). If you

find that the verification is effective, then you can use SPF/SIDF verification as a basis for deciding whether to drop or bounce emails for this specified group of senders.

Procedure

-
- Step 1** Create a mail flow policy for SPF/SIDF verification. Enable SPF/SIDF verification for the mail flow policy on an incoming listener. For information about enabling SPF/SIDF, see [Enabling SPF and SIDF, on page 600](#).
 - Step 2** Create a sender group for SPF/SIDF verification and use a naming convention to indicate SPF/SIDF verification. For information about creating sender groups, see the “Configuring the Gateway to Receive Mail” chapter.
 - Step 3** Create an **spf-status** content filter for each type of SPF/SIDF verification. Use a naming convention to indicate the type of verification. For example, use “SPF-Passed” for messages that pass SPF/SIDF verification, or “SPF-TempErr” for messages that weren’t passed due to a transient error during verification. For information about creating an **spf-status** content filter, see [spf-status Content Filter Rule in the GUI, on page 606](#).
 - Step 4** After you process a number of SPF/SIDF-verified messages, click **Monitor > Content Filters** to see how many messages triggered each of the SPF/SIDF-verified content filters.
-

DMARC Verification

Domain-based Message Authentication, Reporting and Conformance (DMARC) is a technical specification created to reduce the potential for email-based abuse. DMARC standardizes how email receivers perform email authentication using SPF and DKIM mechanisms. To pass DMARC verification, an email must pass at least one of these authentication mechanisms, and the Authentication Identifiers must comply with RFC 5322.

The appliance allows you to:

- Verify incoming emails using DMARC.
- Define profiles to override (accept, quarantine, or reject) domain owners’ policies.
- Send feedback reports to domain owners, which helps to strengthen their authentication deployments.
- Send delivery error reports to the domain owners if the DMARC aggregate report size exceeds 10 MB or the size specified in the RUA tag of the DMARC record.

AsyncOS can handle emails that are compliant with the DMARC specification as submitted to Internet Engineering Task Force (IETF) on March 31, 2013. For more information, see <http://tools.ietf.org/html/draft-kucherawy-dmarc-base-02>.



Note The appliance will not perform DMARC verification of messages from domains with malformed DMARC records. However, the appliance can receive and process such messages.

Related Topics

- [DMARC Verification Workflow, on page 609](#)
- [How to Verify Incoming Messages Using DMARC, on page 609](#)

DMARC Verification Workflow

The following describes how AsyncOS performs DMARC verification.

1. A listener configured on AsyncOS receives an SMTP connection.
2. AsyncOS performs SPF and DKIM verification on the message.
3. AsyncOS fetches the DMARC record for the sender's domain from the DNS.
 - If no record is found, AsyncOS skips the DMARC verification and continues processing.
 - If the DNS lookup fails, AsyncOS takes action based on the specified DMARC verification profile.
4. Depending on DKIM and SPF verification results, AsyncOS performs DMARC verification on the message.



Note If DKIM and SPF verification is enabled, DMARC verification reuses the DKIM and SPF verification results.

5. Depending on the DMARC verification result and the specified DMARC verification profile, AsyncOS accepts, quarantines, or rejects the message. If the message is not rejected due to DMARC verification failure, AsyncOS continues processing.
6. AsyncOS sends an appropriate SMTP response and continues processing.
7. If sending of aggregate reports is enabled, AsyncOS gathers DMARC verification data and includes it in the daily report sent to the domain owners. For more information about the DMARC aggregate feedback report, see [DMARC Aggregate Reports, on page 614](#).



Note If the aggregate report size exceeds 10 MB or the size specified in the RUA tag of the DMARC record, AsyncOS sends delivery error reports to the domain owners.

How to Verify Incoming Messages Using DMARC

How to Verify Incoming Messages Using DMARC

	Do This	More Information
Step 1	Create a new DMARC verification profile or modify the default DMARC verification profile to meet your requirements.	Create a DMARC Verification Profile, on page 610 Edit a DMARC Verification Profile, on page 611
Step 2	(Optional) Configure global DMARC settings to meet your requirements.	Configure Global DMARC Settings, on page 612
Step 3	Configure your mail flow policies to verify incoming messages using DMARC.	Configuring DMARC Verification on the Mail Flow Policy, on page 613
Step 4	(Optional) Configure a return address for DMARC feedback reports.	Configure a Return Address for DMARC Feedback Reports, on page 614

	Do This	More Information
Step 5	(Optional) Review the following: <ul style="list-style-type: none"> DMARC Verification and Incoming Mail reports Messages that failed DMARC verification using Message Tracking 	<ul style="list-style-type: none"> DMARC Verification Page, on page 826 Incoming Mail Page, on page 815 Searching for Messages on the Legacy Interface, on page 888

Related Topics

- [Managing DMARC Verification Profiles, on page 610](#)
- [DMARC Aggregate Reports, on page 614](#)
- [Configure Global DMARC Settings, on page 612](#)
- [Configuring DMARC Verification on the Mail Flow Policy, on page 613](#)
- [Configure a Return Address for DMARC Feedback Reports, on page 614](#)

Managing DMARC Verification Profiles

A DMARC verification profile is a list of parameters that the mail flow policies of the appliance use for verifying DMARC. For example, you may want to create a stringent profile that rejects all non-compliant messages from a particular domain and a less stringent profile that quarantines all non-compliant messages from another domain.

A DMARC verification profile consists of the following information:

- A name for the verification profile.
- Message action to take when the policy in the DMARC record is reject.
- Message action to take when the policy in the DMARC record is quarantine.
- Message action in case of a temporary failure.
- Message action in case of a permanent failure.

Related Topics

- [Create a DMARC Verification Profile, on page 610](#)
- [Edit a DMARC Verification Profile, on page 611](#)
- [Exporting DMARC Verification Profiles, on page 612](#)
- [Importing DMARC Verification Profiles, on page 612](#)
- [Deleting DKIM Verification Profiles, on page 595](#)

Create a DMARC Verification Profile

Use this procedure to create a new DMARC verification profile.



Note

By default, AsyncOS provides a default DMARC verification profile. If you do not want to create a new DMARC verification profile, you can use the default DMARC verification profile. The default DMARC verification profile is available on **Mail Policies > DMARC** page. For instructions to edit the default DMARC verification profile, see [Edit a DMARC Verification Profile, on page 611](#).

Procedure

- Step 1** Choose **Mail Policies > DMARC**.
- Step 2** Click **Add Profile**.
- Step 3** Enter the name of the profile.
- Step 4** Set the message action that AsyncOS takes when the policy in the DMARC record is reject. Choose one of the following:
- **No Action.** AsyncOS does not take any action on the messages that fail DMARC verification.
 - **Quarantine.** AsyncOS quarantines the messages that fail DMARC verification to a specified quarantine.
 - **Reject.** AsyncOS rejects all messages that fail DMARC verification and returns a specified SMTP code and response. The default values are, respectively: 550 and #5.7.1 DMARC unauthenticated mail is prohibited.
- Step 5** Set the message action that AsyncOS takes when the policy in the DMARC record is quarantine. Choose one of the following:
- **No Action.** AsyncOS does not take any action on the messages that fail DMARC verification.
 - **Quarantine.** AsyncOS quarantines the messages that fail DMARC verification to a specified quarantine.
- Step 6** Set the message action that AsyncOS takes on the messages that result in temporary failure during DMARC verification. Choose one of the following:
- **Accept.** AsyncOS accepts messages that result in temporary failure during DMARC verification.
 - **Reject.** AsyncOS rejects messages that result in temporary failure during DMARC verification and returns a specified SMTP code and response. The default values are, respectively: 451 and #4.7.1 Unable to perform DMARC verification.
- Step 7** Set the message action that AsyncOS takes on the messages that result in permanent failure during DMARC verification. Choose one of the following:
- **Accept.** AsyncOS accepts messages that result in permanent failure during DMARC verification.
 - **Reject.** AsyncOS rejects messages that result in permanent failure during DMARC verification, and returns a specified SMTP code and response. The default values are, respectively: 550 and #5.7.1 DMARC verification failed.
- Step 8** Submit and commit your changes.
-

Edit a DMARC Verification Profile

Procedure

- Step 1** Choose **Mail Policies > DMARC**.
- Step 2** Click the intended verification profile name.
- Step 3** Edit the intended fields as described in [Create a DMARC Verification Profile, on page 610](#).
- Step 4** Submit and commit your changes.
-

Exporting DMARC Verification Profiles

You can export all DMARC verification profiles on your appliance to a single text file in the configuration directory.

Procedure

- Step 1** Choose **Mail Policies > DMARC**.
 - Step 2** Click **Export Profiles**.
 - Step 3** Enter a name for the file.
 - Step 4** Click **Submit**.
-

Importing DMARC Verification Profiles

Procedure

- Step 1** Choose **Mail Policies > DMARC**.
 - Step 2** Click **Import Profiles**.
 - Step 3** Choose the file that contains the DMARC verification profiles.
 - Step 4** Click **Submit**. You are warned that importing will replace all existing DMARC verification profiles.
 - Step 5** Click **Import**.
 - Step 6** Commit your changes.
-

Deleting DMARC Verification Profiles

Procedure

- Step 1** Choose **Mail Policies > DMARC**.
 - Step 2** Select the verification profiles that you want to delete.
 - Step 3** Click **Delete**.
 - Step 4** Confirm the deletion.
-

Configure Global DMARC Settings

Procedure

- Step 1** Choose **Mail Policies > DMARC**.
- Step 2** Click **Edit Global Settings**.
- Step 3** Make changes to the settings defined in the following table.

DMARC Global Settings

Global Setting	Description
Specific senders bypass address list	<p>Skip DMARC verification of messages from specific senders. Choose an address list from the drop-down list.</p> <p>Note Address lists that are created using full email addresses or domains only can be used to bypass DMARC verification. For more information, see Using a List of Sender Addresses for Incoming Connection Rules, on page 114.</p>
Bypass verification for messages with headers	<p>Skip DMARC verification of messages that contain specific headers. For example, use this option to skip DMARC verification of messages from mailing lists and trusted forwarders.</p> <p>Enter a header or multiple headers separated by commas.</p>
Schedule for report generation	<p>The time when you want AsyncOS to generate DMARC aggregate reports. For example, you can choose non-peak hours for generating aggregate reports to avoid impact on mail flow.</p>
Entity generating reports	<p>The entity generating DMARC aggregate reports. This helps the domain owners who receive DMARC aggregate reports to identify the entity that generated the report.</p> <p>Enter a valid domain name.</p>
Additional contact information for reports	<p>Additional contact information, for example, details of your organization's customer support, if the domain owners who receive DMARC aggregate reports want to contact the entity that generated the report.</p>
Send copy of all aggregate reports to	<p>Send a copy of all DMARC aggregate reports to specific users, for example, internal users who perform analysis on the aggregate reports.</p> <p>Enter an email address or multiple addresses separated by commas.</p>
Error Reports	<p>Send delivery error reports to the domain owners if the DMARC aggregate report size exceeds 10 MB or the size specified in the RUA tag of the DMARC record.</p> <p>Check the check box.</p>

Step 4 Submit and commit your changes.

Configuring DMARC Verification on the Mail Flow Policy

Procedure

- Step 1** Choose **Mail Policies > Mail Flow Policies**.
- Step 2** Click the incoming mail policy for the listener where you want to perform verification.
- Step 3** In the Security Features section of the mail flow policy, enable DMARC Verification by choosing **On**.

- Step 4** Select the DMARC verification profile that you want to use for the policy.
- Step 5** (Optional) Enable sending of DMARC aggregate feedback reports to email addresses in the RUA tag of DMARC-enabled domains from whom messages are received.
- Aggregate feedback reports are generated daily.
- Step 6** Submit and commit your changes.
-

What to do next

Related Topics

- [DMARC Verification Logs, on page 614](#)

DMARC Verification Logs

Log messages are added to the mail logs during the following stages of DMARC verification.

- DMARC verification attempted on a message
- DMARC verification is complete
- DMARC verification details including DKIM and SPF alignment results
- DMARC verification on a message is skipped
- DMARC record is fetched and parsed or DNS failures
- DMARC aggregate report delivery for a domain failed
- Error report generated for a domain
- Error report delivery for a domain succeeded
- Error report delivery for a domain failed

Configure a Return Address for DMARC Feedback Reports

Procedure

- Step 1** Choose **System Administration > Return Addresses**.
- Step 2** Click **Edit Settings**.
- Step 3** Provide a return address for DMARC aggregate feedback reports.
- Step 4** Submit and commit your changes.
-

DMARC Aggregate Reports

DMARC relies on a feedback mechanism to enforce domain owner policies safely and in a scalable manner. This feedback mechanism helps the domain owners to strengthen their authentication deployments.

If you are using AsyncOS to perform DMARC verification and you have enabled sending of aggregate feedback reports in the mail flow policy, AsyncOS generates aggregate feedback reports daily, and sends it to the domain owners. These reports are in XML format and are archived into a GZip file.



Note All DMARC aggregate feedback reports that AsyncOS generates are DMARC compliant.

A DMARC aggregate feedback report contains the following sections:

- Metadata of the report sender such as email address and report ID number.
- Details of the published DMARC policy.
- Details of DMARC policy disposition such as source IP address and disposition summary.
- Domain identifiers
- DMARC verification results and authentication summary.

Related Topics

- [Sample DMARC Aggregate Feedback Report, on page 615](#)

Sample DMARC Aggregate Feedback Report

```
<?xml version="1.0" encoding="UTF-8" ?>
<feedback>
  <version>1.0</version>
  <report_metadata>
    <org_name>cisco.com</org_name>
    <email>noreply-dmarc-support@cisco.com</email>
    <extra_contact_info>http://cisco.com/dmarc/support</extra_contact_info>
    <report_id>b1d92554ecceab=0694614b826605cd@cisco.com</report_id>
    <date_range>
      <begin>1335571200</begin>
      <end>1335657599</end>
    </date_range>
  </report_metadata>
  <policy_published>
    <domain>example.com</domain>
    <adkim>r</adkim>
    <aspf>r</aspf>
    <p>none</p>
    <sp>none</sp>
    <pct>100</pct>
  </policy_published>
  <record>
    <row>
      <source_ip>1.1.1.1</source_ip>
      <count>2</count>
      <policy_evaluated>
        <disposition>none</disposition>
        <dkim>fail</dkim>
        <spf>pass</spf>
      </policy_evaluated>
    </row>
    <identifiers>
      <envelope_from>example.com</envelope_from>
      <header_from>example.com</header_from>
    </identifiers>
    <auth_results>
      <dkim>
        <domain>example.com</domain>
        <selector>ny</selector>
        <result>fail</result>
      </dkim>
    </auth_results>
  </record>
</feedback>
```

```

    <dkim>
      <domain>example.net</domain>
    </selector></selector>
    <result>pass</result>
  </dkim>
  <spf>
    <domain>example.com</domain>
  </scope>mfrom</scope>
  <result>pass</result>
  </spf>
</auth_results>
</record>
</feedback>

```

Forged Email Detection

Email forging (also known as spoofing, CEO fraud, or business email compromise) is the process of altering the message header to hide the real identity of the sender and to make it look like a legitimate message from someone you know. Assume that a fraudster impersonating as an executive of an organization, is sending a forged message to an employee asking to send a list of clients and their personally identifiable information (PII). The employee, unaware of the real identity of the sender, provides a list of clients and their PII. The fraudster uses the PII to perform identity theft.

The appliance can detect fraudulent messages with forged sender address (From: header) and perform specified actions on such messages. For example, your appliance can detect messages with forged sender address and replace the From: header with the Envelope Sender. In this case, the employee will see the email address of the real sender (fraudster's) instead of the forged email address.

Related Topics

- [Setting Up Forged Email Detection, on page 616](#)
- [Monitoring Forged Email Detection Results, on page 617](#)
- [Displaying Forged Email Detection Details in Message Tracking, on page 618](#)

Setting Up Forged Email Detection

1. Identify the users in your organization (for example, executives) whose messages are likely to be forged. Create a new content dictionary and add the names of the identified users to it.

While creating a content dictionary,

- Enter the name of the user and not the email address. For example, enter “ Olivia Smith ” instead of “ olivia.smith@example.com .”
- Do not configure Advanced Matching and Smart Identifiers.
- Do not choose weight for the terms used.
- Do not use regular expressions.

The following figure shows a sample content dictionary created for Forged Email Detection.

Figure 38: Content Dictionary for Forged Email Detection

Dictionary Properties

Name: FED

Advanced Matching: Match whole words
 Case Sensitive

Smart Identifiers: [?](#) Match specific patterns such as social security numbers and credit card numbers.

Dictionary Number of terms: 6

Add Terms:

Separate multiple entries with line breaks.

Weight: [?](#) 1 [v](#) [Add](#)

Term	Weight	Delete
Matthew Johnson	1	🗑️
Kristine Hansen	1	🗑️
Olivia Smith	1	🗑️
Allen Williams	1	🗑️
John Simons	1	🗑️
Viola Hatton	1	🗑️

For instructions to configure a content dictionary, see [Adding Dictionaries, on page 623](#).

2. Create an incoming content or message filter to detect forged messages and the actions that the appliance must take on such messages. Use the following:

- **Condition/Rule:** Forged Email Detection (See [Content Filter Conditions, on page 272](#) and [Message Filter Rules, on page 132](#))



Note If you want to skip the Forged email detection filter for messages from specific senders, choose the address list from the **Exception List** drop-down list. You can choose only the address lists that are created using the full email addresses. For more information on adding exception address list, refer to [Using a List of Sender Addresses for Incoming Connection Rules, on page 114](#).

- **Action:** Forged Email Detection or any other actions based on your requirement. (See [Content Filter Conditions, on page 272](#) and [Message Filter Rules, on page 132](#))

3. Add the newly created content filter to an incoming mail policy. See [How to Enforce Mail Policies on a Per-User Basis, on page 258](#).

Monitoring Forged Email Detection Results

To view data about forged messages detected, see the Forged Email Matches report page (**Monitor > Forged Email Matches**). This report page includes the following reports:

- **Top Forged Email Matches.** Displays the top ten users in the content dictionary that matched the forged From: header in the incoming messages.
- **Forged Email Matches: Details.** Displays a list of all the users in the content dictionary that matched the forged From: header in the incoming messages and for a given user, the number of messages matched. Click on the number to view a list of messages in Message Tracking.

Displaying Forged Email Detection Details in Message Tracking

To display details of forged messages detected by the appliance in Message Tracking, make sure that:

- Message Tracking is enabled. See [Tracking Messages, on page 887](#).
- Content or message filters for detecting forged messages are operational.



CHAPTER 26

Text Resources

This chapter contains the following sections:

- [Overview of Text Resources, on page 619](#)
- [Content Dictionaries, on page 620](#)
- [Using and Testing the Content Dictionaries Filter Rules, on page 625](#)
- [Understanding Text Resources, on page 627](#)
- [Overview of Text Resource Management, on page 628](#)
- [Using Text Resources, on page 631](#)

Overview of Text Resources

This chapter discusses creating and managing various text resources, such as content dictionaries, disclaimers, and templates.

Related Topics

- [Content Dictionaries, on page 619](#)
- [Text Resources, on page 620](#)
- [Message Disclaimer Stamping, on page 620](#)
- [Using Custom Dictionaries of Sensitive DLP Terms \(Custom DLP Policies Only\) , on page 498](#)

Content Dictionaries

Content dictionaries are groups of words or entries that work in conjunction with the Body Scanning feature on the appliance and are available to both content and message filters. Use the dictionaries you define to scan messages, message headers, and message attachments for terms included in the dictionary in order to take appropriate action in accordance with your corporate policies. For example, you could create a list of confidential or profane words, and, using a filter rule to scan messages that contain words in the list, drop, archive, or quarantine the message.

The AsyncOS operating system includes the ability to define a total of 100 content dictionaries using the GUI (Mail Policies > Dictionaries) or the CLI's **dictionaryconfig** command. You can create, delete, and view dictionaries; add and delete entries from a dictionary; and import and export entire dictionaries.

You can use content dictionaries to scan messages against message or content filters in order to take appropriate action in accordance with your corporate policies. You can create, delete, and view dictionaries; add and

delete entries from a dictionary; and import and export entire dictionaries. You can also determine case sensitivity and word boundary detection for each dictionary. For example, you could create a list of confidential or profane words, and, using a filter rule to scan messages for words in the list, drop or archive messages containing matching words. And you can add a “weight” terms in a dictionary so that certain terms trigger a filter action more easily.

Dictionaries can contain non-ASCII characters.

Note that, for efficient processing, the following content dictionary entries are treated as words:

- Entries containing only alphanumeric characters
- Email addresses containing the following characters: 0-9, A-Z, a-z, dot, underscore, hyphen, and at symbol
- Domain names containing the following characters: 0-9, A-Z, a-z, dot, underscore, hyphen, and at symbol

If you want the appliance to treat such a word as a regular expression, enclose the word in parenthesis, for example, (user@example.com) .

Related Topics

- [Dictionary Content, on page 621](#)
- [Importing and Exporting Dictionaries as Text Files, on page 622](#)
- [Adding Dictionaries, on page 623](#)
- [Deleting Dictionaries, on page 624](#)
- [Importing Dictionaries, on page 624](#)
- [Exporting Dictionaries, on page 625](#)

Text Resources

Text resources are text objects, such as disclaimers, notification templates, and anti-virus templates. You can create new objects for use in various components of AsyncOS. You can import and export text resources.

Message Disclaimer Stamping

Message disclaimer stamping allows you to add a disclaimer text resource to messages. For example, you could append a copyright statement, promotional message, or disclaimer to every message sent from within your enterprise.

Content Dictionaries

Content dictionaries are groups of words or entries that work in conjunction with the Body Scanning feature on the appliance and are available to both content and message filters. Use the dictionaries you define to scan messages, message headers, and message attachments for terms included in the dictionary in order to take appropriate action in accordance with your corporate policies. For example, you could create a list of confidential or profane words, and, using a filter rule to scan messages that contain words in the list, drop, archive, or quarantine the message.

The AsyncOS operating system includes the ability to define a total of 100 content dictionaries using the GUI (Mail Policies > Dictionaries) or the CLI's **dictionaryconfig** command. You can create, delete, and view dictionaries; add and delete entries from a dictionary; and import and export entire dictionaries.

You can use content dictionaries to scan messages against message or content filters in order to take appropriate action in accordance with your corporate policies. You can create, delete, and view dictionaries; add and delete entries from a dictionary; and import and export entire dictionaries. You can also determine case sensitivity and word boundary detection for each dictionary. For example, you could create a list of confidential or profane words, and, using a filter rule to scan messages for words in the list, drop or archive messages containing matching words. And you can add a “weight” terms in a dictionary so that certain terms trigger a filter action more easily.

Dictionaries can contain non-ASCII characters.

Note that, for efficient processing, the following content dictionary entries are treated as words:

- Entries containing only alphanumeric characters
- Email addresses containing the following characters: 0-9, A-Z, a-z, dot, underscore, hyphen, and at symbol
- Domain names containing the following characters: 0-9, A-Z, a-z, dot, underscore, hyphen, and at symbol

If you want the appliance to treat such a word as a regular expression, enclose the word in parenthesis, for example, (user@example.com) .

Related Topics

- [Dictionary Content, on page 621](#)
- [Importing and Exporting Dictionaries as Text Files, on page 622](#)
- [Adding Dictionaries, on page 623](#)
- [Deleting Dictionaries, on page 624](#)
- [Importing Dictionaries, on page 624](#)
- [Exporting Dictionaries, on page 625](#)

Dictionary Content

Words in dictionaries are created with one text string per line, and entries can be in plain text or in the form of regular expressions. Dictionaries can also contain non-ASCII characters. Defining dictionaries of regular expressions can provide more flexibility in matching terms, but doing so requires you to understand how to delimit words properly. For a more detailed discussion of Python style regular expressions, consult the Python Regular Expression HOWTO, accessible from

<http://www.python.org/doc/howto/>



Note To use the special character # at the beginning of a dictionary entry, you can use a character class [#] to prevent it being treated as a comment.

For each term, you specify a “weight,” so that certain terms can trigger filter conditions more easily. When AsyncOS scans messages for the content dictionary terms, it “scores” the message by multiplying the number of term instances by the weight of term. Two instances of a term with a weight of three would result in a score of six. AsyncOS then compares this score with a threshold value associated with the content or message filter to determine if the message should trigger the filter action.

You can also add smart identifiers to a content dictionary. Smart identifiers are algorithms that search for patterns in data that correspond to common numeric patterns, such as social security numbers and ABA routing numbers. These identifiers can be useful for policy enforcement. For more information about regular expressions,

see “Regular Expressions in Rules” in the “Using Message Filters to Enforce Email Policies” chapter. For more information about smart identifiers, see “Smart Identifiers” in the “Using Message Filters to Enforce Email Policies” chapter.



Note Dictionaries containing non-ASCII characters may or may not display properly in the CLI on your terminal. The best way to view and change dictionaries that contain non-ASCII characters is to export the dictionary to a text file, edit that text file, and then import the new file back into the appliance . For more information, see [Importing and Exporting Dictionaries as Text Files, on page 622](#).

Related Topics

- [Word Boundaries and Double-byte Character Sets, on page 622](#)

Word Boundaries and Double-byte Character Sets

In some languages (double-byte character sets), the concepts of a word or word boundary, or case do not exist. Complex regular expressions that depend on concepts like what is or is not a character that would compose a word (represented as “w” in regex syntax) cause problems when the locale is unknown or if the encoding is not known for certain. For that reason, you may want to disable word-boundary enforcement.

Importing and Exporting Dictionaries as Text Files

The content dictionary feature also includes, by default, the following text files located in the configuration directory of the appliance :

- `config.dtd`
- `profanity.txt`
- `proprietary_content.txt`
- `sexual_content.txt`

These text files are intended to be used in conjunction with the content dictionaries feature to aid you in creating new dictionaries. These content dictionaries are weighted and use smart identifiers to better detect patterns in data and trigger filters when the patterns indicate compliance issues.



Note Importing and exporting dictionaries does not preserve the Match Whole Words and Case Sensitive settings. This settings are only preserved in the configuration file.

See [FTP, SSH, and SCP Access, on page 1261](#) for more information accessing on the configuration directory.

You can also create your own dictionary files and import them onto the appliance . The best way to add non-ASCII characters to dictionaries is to add the terms into the dictionary in a text file off the appliance , move that file onto the appliance , and then import that file as a new dictionary. For more information about importing dictionaries, see [Importing Dictionaries, on page 624](#). For information about exporting dictionaries, see [Exporting Dictionaries, on page 625](#).



Caution These text files contain terms that some persons may consider obscene, indecent or offensive. If you import terms from these files into your content dictionaries, the terms will be displayed when you later view the content dictionaries you have configured on the appliance .

Adding Dictionaries

Procedure

-
- Step 1** Navigate to the **Mail Policies > Dictionaries** page.
- Step 2** Click **Add Dictionary**.
- Step 3** Type a name for the dictionary.
- Step 4** (Optional) Configure Advanced Matching.
- Note** AsyncOS preserves the **Match Whole Words** and **Case Sensitive** settings when you save them in the configuration file. AsyncOS does not preserve these settings when importing and exporting dictionaries.
- Step 5** (Optional) Add a smart-identifier to the dictionary.
- Smart identifiers are algorithms that search for patterns in data that correspond to common numeric patterns, such as social security numbers and ABA routing numbers. For more information about smart identifiers, see the “Using Message Filters to Enforce Email Policies” chapter.
- Step 6** Enter new dictionary entries into the list of terms.
- If you have multiple new entries to add, and you want them to be equally likely trigger a filter action, put each new term on its own line.
- Note** Content dictionary entries with the regular expression: “. * ” at the beginning or end will cause the system to lock if a match for the “word” MIME part is found. Cisco Systems recommends you do not use “. * ” at the beginning or end of a content dictionary entry.
- Step 7** Specify a weight for the term(s).
- You can “weight” a dictionary term so that it is more likely than other terms to trigger a filter action. For more information about how this weight is used to determine filter actions, see “Threshold Scoring for Content Dictionaries” in the “Using Message Filters to Enforce Email Policies” chapter.
- Step 8** Click **Add**.
- Step 9** Submit and commit your changes.
-

What to do next

Related Topics

- [Dictionary Content, on page 621.](#)

Deleting Dictionaries

Before You Begin

Be aware that AsyncOS marks any message filter that references the deleted dictionary as invalid. AsyncOS leaves any content filter that references the deleted dictionary enabled, but will evaluate them to false.

Procedure

- Step 1** Navigate to the **Mail Policies > Dictionaries** page.
 - Step 2** Click the trash can icon next to the dictionary to delete in the dictionary listing.
A confirmation message lists any filters that are currently referencing the dictionary.
 - Step 3** Click **Delete** in the confirmation message.
 - Step 4** Commit your changes.
-

Importing Dictionaries

Before You Begin

Verify that the file to import is present in the configuration directory on the appliance .

Procedure

- Step 1** Navigate to the **Mail Policies > Dictionaries** page.
 - Step 2** Click **Import Dictionary**.
 - Step 3** Select the location to import from.
 - Step 4** Select the file to import.
 - Step 5** Select the default weight to use for dictionary terms.
AsyncOS will assign a default weight to any terms with unspecified weights. You can edit the weights after importing the file.
 - Step 6** Select an encoding.
 - Step 7** Click **Next**.
 - Step 8** Name and edit the dictionary.
 - Step 9** Submit and commit your changes.
-

Exporting Dictionaries

Procedure

Step 1 Navigate to the **Mail Policies** > Dictionaries page.

Step 2 Click **Export Dictionary**.

Step 3 Select the dictionary to export.

Step 4 Enter a file name for the exported dictionary.

This is the name of the file that will be created in the configuration directory on the appliance .

Step 5 Select the location to export to.

Step 6 Select an encoding for the text file.

Step 7 Submit and commit your changes.

Using and Testing the Content Dictionaries Filter Rules

Dictionaries can be used along with the various `dictionary-match()` message filter rules and with content filters.

Related Topics

- [Dictionary Match Filter Rule, on page 625](#)

Dictionary Match Filter Rule

The message filter rule named `dictionary-match(<dictionary_name>)` (and its counterparts) evaluates to true if the message body contains any of the regular expressions in the content dictionary named `dictionary_name` . If that dictionary does not exist, the rule evaluates to false.

Note that the `dictionary-match()` rule functions similarly to the `body-contains()` body scanning rule: it only scans the body and attachments of messages, and not the headers.

For scanning headers, you can use the appropriate `*-dictionary-match()` -type rule (there are rules for specific headers, such as `subject-dictionary-match()` and a more generic rule, `header-dictionary-match()` , in which you can specify any header including custom headers). See “Dictionary Rules” in the “Using Message Filters to Enforce Email Policies” chapter for more information about dictionary matching.

Table 45: Message Filter Rules for Content Dictionaries

Rule	Syntax	Description
Dictionary Match	<code>dictionary-match(<dictionary_name>)</code>	Does the message contain a word that matches all the regular expressions listed in the named dictionary?

In the following example, a new message filter using the `dictionary-match()` rule is created to blind carbon copy the administrator when the appliance scans a message that contains any words within the dictionary

named “secret_words” (created in the previous example). Note that because of the settings, only messages that contain the whole word “codename” matching the case exactly will evaluate to true for this filter.

```
bcc_codenames:

if (dictionary-match ('secret_words'))

{

bcc('administrator@example.com');

}
```

In this example, we send the message to the Policy quarantine:

```
quarantine_codenames:

if (dictionary-match ('secret_words'))

{

quarantine('Policy');

}
```

Related Topics

- [Example Dictionary Entries, on page 626](#)
- [Testing Content Dictionaries, on page 626](#)

Example Dictionary Entries

Table 46: Example Dictionary Entries

Description	Example
Wildcard	
Anchors	Ends with: foo \$ Begins with: ^ foo
Email address(Do not escape the period)	foo@example.com , @example.com example.com\$ (ends with) @example.*
Subject	An email subject (keep in mind when using the ^ anchor in email subjects that subjects are often prepended with “RE:” or “FW:” and the like)

Testing Content Dictionaries

The `trace` function can provide quick feedback on message filters that use the `dictionary-match()` rule. See [Debugging Mail Flow Using Test Messages: Trace, on page 1213](#) for more information. You can also use the `quarantine()` action to test filters, as in the `quarantine_codenames` filter example above.

Understanding Text Resources

Text resources are text templates that can be attached to messages or sent as messages. Text resources can be one of the following types:

- **Message disclaimers** — Text that is added to messages. For more information, see [Disclaimer Template, on page 631](#).
- **Notification templates** — Messages that are sent as notifications, used with the `notify()` and `notify-bcc()` actions. For more information, see [Notification Templates, on page 636](#).
- **Anti-virus Notification templates** — Messages that are sent as notifications when a virus is found in a message. You can create a template for a container (which appends the original message), or as a notice that is sent without the appended message. For more information, see [Anti-Virus Notification Templates, on page 637](#).
- **Bounce and Encryption Failure Notification templates** — Messages that are sent as notifications when a message is bounced or message encryption fails. For more information, see [Bounce and Encryption Failure Notification Templates, on page 639](#).
- **Encryption Notification Templates** — Messages that are sent when you configure the appliance to encrypt outgoing email. The message notifies recipients that they have received an encrypted message and provides instructions for reading it. For more information, see [Encryption Notification Templates, on page 640](#).

You can use the CLI (`textconfig`) or the GUI to manage text resources, including: adding, deleting, editing, importing, and exporting. For information on managing text resources using the GUI, see [Overview of Text Resource Management, on page 628](#).

Text resources can contain non-ASCII characters.

**Note**

Text resources containing non-ASCII characters may or may not display properly in the CLI on your terminal. To view and change text resources that contain non-ASCII characters, export the text resource to a text file, edit that text file, and then import the new file back into the appliance . For more information, see [Importing and Exporting Dictionaries as Text Files, on page 622](#).

Related Topics

- [Importing and Exporting Dictionaries as Text Files, on page 622](#)

Importing and Exporting Text Resources as Text Files

You must have access to the configuration directory on the appliance . Imported text files must be present in the configuration directory on the appliance . Exported text files are placed in the configuration directory.

See [FTP, SSH, and SCP Access, on page 1261](#) for more information on accessing the configuration directory.

To add non-ASCII characters to text resources, add the terms into the text resource in a text file off the appliance , move that file onto the appliance , and then import that file as a new text resource. For more information about importing text resources, see [Importing Text Resources, on page 629](#). For information about exporting text resources, see [Exporting Text Resources, on page 629](#).

Overview of Text Resource Management

You can manage text resources using either the GUI or the CLI. This section focuses on the GUI.

Manage text resources from the CLI using the `textconfig` command.

Text resource management includes these tasks:

- Adding
- Editing and deleting
- Exporting, and importing
- Defining plain text messages for all text resource types
- Defining HTML-based messages for some text resource types

Related topics

- [Adding Text Resources, on page 628](#)
- [Deleting Text Resources, on page 628](#)
- [Exporting Text Resources, on page 629](#)
- [Importing Text Resources, on page 629](#)
- [Overview of HTML-Based Text Resources, on page 630.](#)

Adding Text Resources

Procedure

Step 1 Navigate to **Mail Policies > Text Resources**

Step 2 Click **Add Text Resource**.

Step 3 Enter a name for the text resource in the **Name** field.

Step 4 Select the type of text resource from the **Type** field.

Step 5 Enter the message text in either the **Text** or the **HTML and Plain Text** field.

If the text resource allows only plain text messages, use the **Text** field. If the text resource allows both HTML and plain text messages, use the **HTML and Plain Text** fields.

Step 6 Submit and commit your changes.

What to do next

Related topics

- [Overview of HTML-Based Text Resources, on page 630.](#)

Deleting Text Resources

Before you begin

Note the impact of deleting text resources:

- Any message filters that reference the deleted text resource are marked as invalid.
- Any content filters that reference the deleted text resource are left enabled, but will evaluate to false.

Procedure

- Step 1** On the **Mail Policies > Text Resources** page, click the trash can icon under the Delete column for the text resource you want to delete. A confirmation message is displayed.
- Step 2** Click **Delete** to delete the text resource.
- Note** You cannot delete a text resource that is referenced in any of the content or message filter configurations.
- Step 3** Commit your changes.
-

Importing Text Resources

Before you begin

Ensure that the file to import is in the configuration directory on the appliance .

Procedure

- Step 1** On the **Mail Policies > Text Resources** page, click **Import Text Resource**.
- Step 2** Select a file to import.
- Step 3** Specify an encoding.
- Step 4** Click **Next**.
- Step 5** Choose a name, edit, and select the text resource type.
- Step 6** Submit and commit your changes.
-

Exporting Text Resources

Before you begin

Be aware that when you export a text resource, a text file is created in the configuration directory on the appliance .

Procedure

- Step 1** On the **Mail Policies > Text Resources** page, click **Export Text Resource**.
- Step 2** Select a text resource to export.
- Step 3** Enter a file name for the text resource.

- Step 4** Select an encoding for the text file.
- Step 5** Click **Submit** to create the text file containing the text resource in the configuration directory.
-

Overview of HTML-Based Text Resources

You can create some text resources with both HTML-based and plain text messages, such as Disclaimers. When a text resource containing both HTML-based and plain text messages is applied to an email message, the HTML-based text resource message is applied to the text/html part of the email message, and the plain text message is applied to the text/plain part of the email message.

When you add or edit an HTML-based text resource, the GUI includes a rich text edit that allows you to enter rich text without having to manually write HTML code.

Consider the following information when adding and editing an HTML-based text resource:

- You can choose to have the plain text version of the message to be automatically generated based on the HTML version, or you can define the plain text version independently.
- You can switch between the rich text editor and HTML code by clicking the **Code View** button.
- To enter HTML code that is not supported in the rich text editor in the GUI, switch to code view and manually enter HTML code. For example, you might want to do this to insert a reference to an image file located on an external server using the `` HTML tag.

Related Topics

- [Importing and Exporting HTML-Based Text Resources, on page 630](#)

Importing and Exporting HTML-Based Text Resources

You can export to and import from a text file HTML-based text resources. When you export an HTML-based text resource to a file, the file contains the following sections for each version of the text resource:

- [html_version]
- [text_version]

The order of these sections does not matter.

For example, an exported file might contain the following text:

```
[html_version]
<p>Sample <i>message.</i></p>
[text_version]
Sample message.
```

Consider the following rules and guidelines when exporting and importing HTML-based text resources:

- When you export an HTML-based text resource whose plain text message is automatically generated from the HTML version, the exported file does not contain the [text_version] section.
- When you import from a text file, any HTML code under the [html_version] section is converted to the HTML message in the created text resource if the text resource type supports HTML messages. Similarly, any text under the [text_version] section is converted to the plain text message in the created text resource.

- When you import from a file that contains an empty or nonexistent `[html_version]` section to create a HTML-based text resource, the appliance creates both an HTML and plain text message using the text in the `[text_version]` section.

Using Text Resources

All types of text resources are created in the same way, using the Text Resources page or the `textconfig` CLI command. Once created, each type is used in a different way. Disclaimers and notification templates are used with filters and listeners, while anti-virus notification templates are used with mail policies and anti-virus settings.

Related Topics

- [Disclaimer Template, on page 631](#)
- [Disclaimer Stamping and Multiple Encodings, on page 634](#)
- [Notification Templates, on page 636](#)
- [Anti-Virus Notification Templates, on page 637](#)
- [Bounce and Encryption Failure Notification Templates, on page 639](#)
- [Encryption Notification Templates, on page 640](#)

Disclaimer Template

The appliance can add a default disclaimer above or below the text (heading or footer) for some or all messages received by a listener. You can add disclaimers to messages on the appliance using the following methods:

- Via a listener, using the GUI or the `listenerconfig` command (see [Adding Disclaimer Text via a Listener, on page 632](#)).
- Using the content filter action, `Add Disclaimer Text` (see [Content Filter Actions, on page 280](#)).
- Using the message filter action, `add-footer()` (see the “Using Message Filters to Enforce Email Policies” chapter).
- Using a data loss prevention profile (see [Data Loss Prevention, on page 485](#)).
- Using message modification for Outbreak Filters to alert the user that the message may be an attempt at phishing or malware distribution (see [Modifying Messages, on page 406](#)). Disclaimers added for this type of notification are added above the text.

For example, you can append a copyright statement, promotional message, or disclaimer to every message sent from within your enterprise.

Prior to using disclaimer text you have to create the disclaimer template. Use the Text Resources page in the GUI (see [Adding Text Resources, on page 628](#)) or the `textconfig` command (see the CLI Reference Guide for AsyncOS for Cisco Email Security Appliances) to create and manage a set of text strings to be used.

Related Topics

- [Adding Disclaimers via Filters, on page 632](#)
- [Adding Disclaimer Text via a Listener, on page 632](#)
- [Disclaimers and Filter Action Variables, on page 632](#)

Adding Disclaimer Text via a Listener

Once you have disclaimer text resources created, select which text strings will be appended to messages received by the listener. You can add disclaimer text above or below a message. This feature is available on both public (inbound) and private (outbound) listeners.

If you send a message that consists of text and HTML (Microsoft Outlook calls this type of message a “multipart alternative”), the appliance will stamp the disclaimer on both parts of the message. However, if your message has signed content, the content will not be modified because the modification will invalidate the signature. Instead, a new part is created with a disclaimer stamp that says “Content-Disposition inline attachment.” For more information on multipart messages, see “Message Bodies vs. Message Attachments” in the “Using Message Filters to Enforce Email Policies” chapter.

Adding Disclaimers via Filters

You can also append specific, predefined text strings to the disclaimers of messages using the filter action `add-footer()` or the content filter action “Add Disclaimer Text.” For example, the following message filter rule appends the text string named `legal.disclaimer` to all messages sent from users in the LDAP group “Legal:”

```
Add-Disclaimer-For-Legal-Team:

if (mail-from-group == 'Legal')
{
add-footer('legal.disclaimer');
}
```

Disclaimers and Filter Action Variables

You can also use message filter action variables (see “Action Variables” in the “Using Message Filters to Enforce Email Policies” chapter for more information).

The following variables are available for the Disclaimer Template:

Table 47: Anti-Virus Notification Variables

Variable	Substituted With
\$To	Replaced by the message To: header (not the Envelope Recipient).
\$From	Replaced by the message From: header (not the Envelope Sender).
\$Subject	Replaced by the subject of the original message.
\$Date	Replaced by the current date, using the format MM/DD/YYYY.
\$Time	Replaced by the current time, in the local time zone.
\$GMTimestamp	Replaced by the current time and date, as would be found in the Received: line of an email message, using GMT.
\$MID	Replaced by the Message ID, or “MID” used internally to identify the message. Not to be confused with the RFC822 “Message-Id” value (use \$Header to retrieve that).

Variable	Substituted With
\$Group	Replaced by the name of the sender group the sender matched on when injecting the message. If the sender group had no name, the string ">Unknown<" is inserted.
\$Policy	Replaced by the name of the HAT policy applied to the sender when injecting the message. If no predefined policy name was used, the string ">Unknown<" is inserted.
\$Reputation	Replaced by the IP Reputation score of the sender. If there is no reputation score, it is replaced with "None".
\$filenames	Replaced with a comma-separated list of the message's attachments' filenames.
\$filetypes	Replaced with a comma-separated list of the message's attachments' file types.
\$filesizes	Replaced with a comma-separated list of the message's attachment's file sizes.
\$remotehost	Replaced by the hostname of the system that sent the message to the appliance .
\$AllHeaders	Replaced by the message headers.
\$EnvelopeFrom	Replaced by the Envelope Sender (Envelope From, <MAIL FROM>) of the message.
\$Hostname	Replaced by the hostname of the appliance .
\$header['string ']	Replaced by the value of the quoted header, if the original message contains a matching header. Note that double quotes may also be used.
\$envelope recipients	Replaced by all Envelope Recipients (Envelope To, <RCPT TO>) of the message.
\$bodysize	Replaced by the size, in bytes, of the message.
\$FilterName	Returns the name of the filter being processed.
\$MatchedContent	Returns the content that triggered a scanning filter rule (including filter rules such as body-contains and content dictionaries).
\$DLPPolicy	Replaced by the name of the email DLP policy violated.
\$DLPSeverity	Replaced by the severity of violation. Can be "Low," "Medium," "High," or "Critical."
\$DLPRiskFactor	Replaced by the risk factor of the message's sensitive material (score 0 - 100).
\$threat_category	Replaced with the type of Outbreak Filters threat, such as phishing, virus, scam, or malware.
\$threat_type	Replaced by a subcategory of the Outbreak Filters threat category. For example, can be a charity scam, a financial phishing attempt, a fake deal, etc.
\$threat_description	Replaced by a description of the Outbreak Filters threat.
\$threat_level	Replaced by the message's threat level (score 0 - 5).

Variable	Substituted With
\$threat_verdict	Replaced by Yes or No, depending on the Message Modification Threat Level threshold. If the viral or non-viral threat level of a message is greater than or equal to the message modification threat level threshold, the value of this variable is set to Yes.

To use message filter action variables in disclaimers, create a message disclaimer (via the Text Resource page in the GUI or the **textconfig** command), and reference the variable:

The add-footer() action supports non-ASCII text by adding the footer as an inline, UTF-8 coded, quoted printable attachment.

Disclaimer Stamping and Multiple Encodings

AsyncOS includes a setting used to modify the way disclaimer stamping with different character encodings works. By default, AsyncOS attempts to place the disclaimers it attaches within the body part of an email message. You can use a setting configured within the `localeconfig` command to configure the behavior if the encodings of the body part and the disclaimer are different. To understand this setting, it is helpful to view an email message as consisting of several parts:

To: joe@example.com From: mary@example.com Subject: Hi!	Headers
<blank line>	
Hello!	Body part
This message has been scanned...	First attachment part
Example.zip	Second attachment part

The message body after the first blank line may contain many MIME parts. The second and following parts are often called “attachments,” while the first is often called the “body” or “text.”

A disclaimer can be included in an email as either an attachment (above) or as part of the body

To: joe@example.com From: mary@example.com Subject: Hi!	Headers
<blank line>	
Hello!	Body part
This message has been scanned...	Disclaimer now included in body part

Example.zip	First attachment part
-------------	-----------------------

Typically, when there is an encoding mismatch between the message body and a disclaimer, AsyncOS attempts to encode the entire message in the same encoding as the message body so that the disclaimer will be included in the body (“inline”) and not included as a separate attachment. In other words, the disclaimer will be included inline if the encoding of the disclaimer matches that of the body, or if the text in the disclaimer contains characters that can be displayed inline (in the body). For example, it is possible to have a ISO-8859-1 encoded disclaimer that only contains US-ASCII characters; consequently, this will display “inline” without problems.

However, if the disclaimer cannot be combined with the body, you can use the `localeconfig` command to configure AsyncOS to attempt to promote, or convert, the body text to match the encoding of the disclaimer so that the disclaimer can be included in the body of the message:

```
example.com> localeconfig
```

```
Behavior when modifying headers: Use encoding of message body
Behavior for untagged non-ASCII headers: Impose encoding of message body
Behavior for mismatched footer or heading encoding: Try both body and footer or heading
encodings
Behavior when decoding errors found: Disclaimer is displayed as inline content and the
message body is added as an attachment.
```

```
Choose the operation you want to perform:
- SETUP - Configure multi-lingual settings.
[]> setup
```

```
If a header is modified, encode the new header in the same encoding as the message body?
(Some MUAs incorrectly handle headers encoded in a different encoding than the body.
However, encoding a modified header in the same encoding as the message body may cause
certain
characters in the modified header to be lost.) [Y]>
```

```
If a non-ASCII header is not properly tagged with a character set and is being used or
modified,
impose the encoding of the body on the header during processing and final representation
of the message?
(Many MUAs create non-RFC-compliant headers that are then handled in an undefined way.
Some MUAs handle headers encoded in character sets that differ from that of the main body
in an incorrect way.
Imposing the encoding of the body on the header may encode the header more precisely.
This will be used to interpret the content of headers for processing, it will not modify
or rewrite the
header unless that is done explicitly as part of the processing.) [Y]>
```

```
Disclaimers (as either footers or headings) are added in-line with the message body whenever
possible.
However, if the disclaimer is encoded differently than the message body, and if imposing a
single encoding
will cause loss of characters, it will be added as an attachment. The system will always
try to use the
message body's encoding for the disclaimer. If that fails, the system can try to edit the
message body to
use an encoding that is compatible with the message body as well as the disclaimer. Should
the system try to
re-encode the message body in such a case? [Y]>
```

```
If the disclaimer that is added to the footer or header of the message generates an error
when decoding the message body,
it is added at the top of the message body. This prevents you to rewrite a new message
content that must merge with
the original message content and the header/footer-stamp. The disclaimer is now added as
```

an additional MIME part that displays only the header disclaimer as an inline content, and the rest of the message content is split into separate email attachments. Should the system try to ignore such errors when decoding the message body? [N]>

Behavior when modifying headers: Use encoding of message body

Behavior for untagged non-ASCII headers: Impose encoding of message body

Behavior for mismatched footer or heading encoding: Try both body and footer or heading encodings

Behavior when decoding errors found: Disclaimer is displayed as inline content and the message body is added as an attachment.

Choose the operation you want to perform:
 - SETUP - Configure multi-lingual settings.
 []>

For more information about the `localeconfig` command, see the “Configuring the Appliance to Receive Mail” chapter.

Notification Templates

Notification templates are used with the `notify()` and `notify-copy()` filter actions. Notification templates may contain non-ascii text and action variables (see “Action Variables” in the “Using Message Filters to Enforce Email Policies” chapter), including the anti-virus-related variables used by anti-virus notifications. For example, you could use the `$Allheaders` action variable to include the headers from the original message. You can configure the From: address for notifications, see [Configuring the Return Address for Appliance Generated Messages, on page 1019](#).

Once you have created a notification template, you can refer to it in content and message filters. The following figure shows a content filter where the `notify-copy()` filter action is set to send the “grape_text” notification to “grapewatchers@example.com.”

Figure 39: Notify Example in a Content Filter

Edit Content Filter

Edit Filter	
Name:	grapecheck
Currently used by policies:	DEFAULT
Description:	Looking for grapes.
Order:	1
Apply filter:	<input checked="" type="radio"/> If one or more conditions match <input type="radio"/> Only if ALL conditions match
Conditions	
Select New Condition...	Add Condition
Condition	Delete
body-contains("grape")	
Actions	
Select New Action...	Add Action
Action	Delete
notify-copy ("grapewatchers@example.com", "Found one!", "", "grape_text")	
Cancel	Submit

Anti-Virus Notification Templates

There are two types of anti-virus notification templates:

- **anti-virus notification template.** The anti-virus notification template is used when the original message is not attached to the virus notification.
- **anti-virus container template.** The container template is used when the original message is sent as an attachment.

Anti-virus notification templates are used in basically the same way as notification templates except that they are used with the anti-virus engine instead of filters. You can specify a custom notification to send while editing a mail policy. You can configure the From: address for anti-virus notifications. For information, see [Configuring the Return Address for Appliance Generated Messages, on page 1019](#).

Related Topics

- [Custom Anti-Virus Notification Templates, on page 637](#)

Custom Anti-Virus Notification Templates

The following figure shows a mail policy where a custom anti-virus notification is specified.

Figure 40: Anti-Virus Container Template Notification Example in a Mail Policy

Virus Infected Messages:	
Action Applied to Message:	Deliver as Attachment (RFC822) to New Message
Archive Original Message:	<input type="radio"/> No <input checked="" type="radio"/> Yes
Modify Message Subject:	<input type="radio"/> No <input checked="" type="radio"/> Prepend <input type="radio"/> Append
	[WARNING : VIRUS DETECTED]
Advanced	Add Custom Header to Message: <input checked="" type="radio"/> No <input type="radio"/> Yes Header: <input type="text"/> Value: <input type="text"/>
	Container Notification: anti_virus_container Preview Message Body <small>(see Mail Policies > Text Resources > Anti-Virus Container Template)</small>

Related Topics

- [Anti-Virus Notification Variables, on page 637](#)

Anti-Virus Notification Variables

When creating an anti-virus notification, you can use any of the notification variables listed in the following table:

Table 48: Anti-Virus Notification Variables

Variable	Substituted With
\$To	Replaced by the message To: header (not the Envelope Recipient).
\$From	Replaced by the message From: header (not the Envelope Sender).
\$Subject	Replaced by the subject of the original message.

Variable	Substituted With
\$AV_VIRUSES	Replaced by the list of all the viruses found anywhere in the message: “Unix/Apache.Trojan”, “W32/Bagel-F”
\$AV_VIRUS_TABLE	Replaced by the table of MIME-Part/Attachment names and viruses in each part: “HELLO.SCR” : “W32/Bagel-F” <unnamed part of the message> : “Unix/Apache.Trojan”
\$AV_VERDICT	Replaced by the anti-virus verdict.
\$AV_DROPPED_TABLE	Replaced by the table of attachments that were dropped. Each row is composed of a part or filename followed by the list of viruses associated with that part: “HELLO.SCR” : “W32/Bagel-f”, “W32/Bagel-d” “Love.SCR” : “Netsky-c”, “W32/Bagel-d”
\$AV_REPAIRED_VIRUSES	Replaced by the list of all the viruses found and repaired.
\$AV_REPAIRED_TABLE	Replaced by the table of all parts and viruses found and repaired: “HELLO.SCR” : “W32/Bagel-F”
\$AV_DROPPED_PARTS	Replaced by the list of filenames that were dropped: “HELLO.SCR”, “CheckThisOut.exe”
\$AV_REPAIRED_PARTS	Replaced by the list of filenames or parts that were repaired.
\$AV_ENCRYPTED_PARTS	Replaced by the list of filenames or parts that were encrypted.
\$AV_INFECTED_PARTS	Replaced by a comma-separated list of filenames for the files that contained a virus.
\$AV_UNSCANNABLE_PARTS	Replaced by the list of filenames or parts that were unscannable.
\$Date	Replaced by the current date, using the format MM/DD/YYYY.
\$Time	Replaced by the current time, in the local time zone.
\$GMTimestamp	Replaced by the current time and date, as would be found in the Received: line of an email message, using GMT.
\$MID	Replaced by the Message ID, or “MID” used internally to identify the message. Not to be confused with the RFC822 “Message-Id” value (use \$Header to retrieve that).
\$Group	Replaced by the name of the sender group the sender matched on when injecting the message. If the sender group had no name, the string “>Unknown<” is inserted.
\$Policy	Replaced by the name of the HAT policy applied to the sender when injecting the message. If no predefined policy name was used, the string “>Unknown<” is inserted.

Variable	Substituted With
\$Reputation	Replaced by the IP Reputation score of the sender. If there is no reputation score, it is replaced with “None”.
\$filenames	Replaced with a comma-separated list of the message’s attachments’ filenames.
\$filetypes	Replaced with a comma-separated list of the message’s attachments’ file types.
\$filesizes	Replaced with a comma-separated list of the message’s attachment’s file sizes.
\$remotehost	Replaced by the hostname of the system that sent the message to the appliance .
\$AllHeaders	Replaced by the message headers.
\$EnvelopeFrom	Replaced by the Envelope Sender (Envelope From, <MAIL FROM>) of the message.
\$Hostname	Replaced by the hostname of the appliance .



Note Variable names are not case-sensitive. For example, specifying “\$to” is equivalent to specifying “\$To” in the text resource. If an “AV_” variable is empty in the original message, the string <None> is substituted.

After the text resource has been defined, use the **Mail Policies > Incoming/Outgoing Mail Policies > Edit Anti-Virus Settings** page or the `policyconfig -> edit -> antivirus` command to specify that the original message is to be included as an RFC 822 attachment for Repaired, Unscannable, Encrypted, or Virus Positive messages. See [Send Custom Alert Notification, on page 352](#) for more information.

Bounce and Encryption Failure Notification Templates

Bounce and encryption failure notification templates are used in basically the same way as notification templates except that they are used with bounce notifications and message encryption failure notifications. You can specify a custom bounce notification to send while editing a bounce profile and a custom message encryption failure notification while editing an encryption profile.

The following figure shows a bounce notification template specified in a bounce profile.

Figure 41: Bounce Notification Example in a Bounce Profile

Send Delay Warning Messages:

Use Default (No) Yes No

Message Composition

Message Subject:

Notification Template:

Minimum Interval Between Messages: seconds

Maximum Number of Messages to Send:



Note You must use RFC-1891 DSNs to use custom templates.

The following figure shows an encryption failure template specified in an encryption profile.

Figure 42: Encryption Failure Notification Example in an Encryption Profile

Notification Settings	
<i>Use system generated notifications by default or create custom notification templates can be configured in Mail Policies > Text Resources</i>	
HTML Notification:	System Generated Preview Message
Text Notification:	System Generated Preview Message
Encryption Failure Notification:	Message Subject: <input type="text" value="[[ENCRYPTION FAILURE]]"/> Message Body: <input type="text" value="MaxSize"/>

Related Topics

- [Bounce and Encryption Failure Notification Variables, on page 640](#)

Bounce and Encryption Failure Notification Variables

When creating a bounce or encryption failure notification, you can use any of the notification variables listed in the following table:

Table 49: Bounce Notification Variables

Variable	Substituted With
\$Subject	The subject of the original message.
\$Date	Replaced by the current date, using the format MM/DD/YYYY.
\$Time	Replaced by the current time, in the local time zone.
\$GMTTimeStamp	Replaced by the current time and date, as would be found in the Received: line of an email message, using GMT.
\$MID	Replaced by the Message ID, or “MID” used internally to identify the message. Not to be confused with the RFC822 “Message-Id” value (use \$Header to retrieve that).
\$BouncedRecipient	Bounced recipient address
\$BounceReason	Reason for this notification
\$remotehost	Replaced by the hostname of the system that sent the message to the appliance .

Encryption Notification Templates

Encryption notification templates are used when you configure Cisco Email Encryption to encrypt outbound email. The notification informs recipients that they have received an encrypted message and provides

instructions for reading it. You can specify a custom encryption notification to send with encrypted messages. You specify both an HTML and a text encryption notification when you create an encryption profile. Therefore, if you want to create a custom profile, you should create both text and HTML notifications.



CHAPTER 27

Validating Recipients Using an SMTP Server

This chapter contains the following sections:

- [Overview of SMTP Call-Ahead Recipient Validation, on page 643](#)
- [SMTP Call-Ahead Recipient Validation Workflow, on page 643](#)
- [How to Validate Recipients Using an External SMTP Server, on page 645](#)
- [Enabling a Listener to Validate Incoming Mail Via the SMTP Server, on page 648](#)
- [Configuring LDAP Routing Query Settings, on page 648](#)
- [SMTP Call-Ahead Query Routing, on page 649](#)
- [Bypassing SMTP Call-Ahead Validation for Certain Users or Groups, on page 649](#)

Overview of SMTP Call-Ahead Recipient Validation

The SMTP call-ahead recipient validation feature queries an external SMTP server before accepting incoming mail for a recipient. Use this feature to validate recipients when you cannot use LDAP Accept or the Recipient Access Table (RAT). For example, suppose you host mail for many mailboxes, each using a separate domain, and your LDAP infrastructure does not allow you to query the LDAP server to validate each recipient. In this case, the appliance can query the SMTP server and validate the recipient before continuing the SMTP conversation.

You can use SMTP call-ahead recipient validation in order to reduce processing on messages for invalid recipients. Typically, a message for an invalid recipient progresses through the work queue before it can be dropped. Instead, an invalid message can be dropped or bounced during the incoming/receiving part of the email pipeline without requiring additional processing.

SMTP Call-Ahead Recipient Validation Workflow

When you configure your appliance for SMTP call-ahead recipient validation, the appliance suspends the SMTP conversation with the sending MTA while it “calls ahead” to the SMTP server to verify the recipient. When the appliance queries the SMTP server, it returns the SMTP server’s response to the Email Security appliance, and depending on the settings you have configured, you can accept the mail or drop the connection with a code and custom response.

The following figure shows the basic workflow of the SMTP call-head validation conversation.

Figure 43: SMTP Call Ahead Server Conversation Workflow

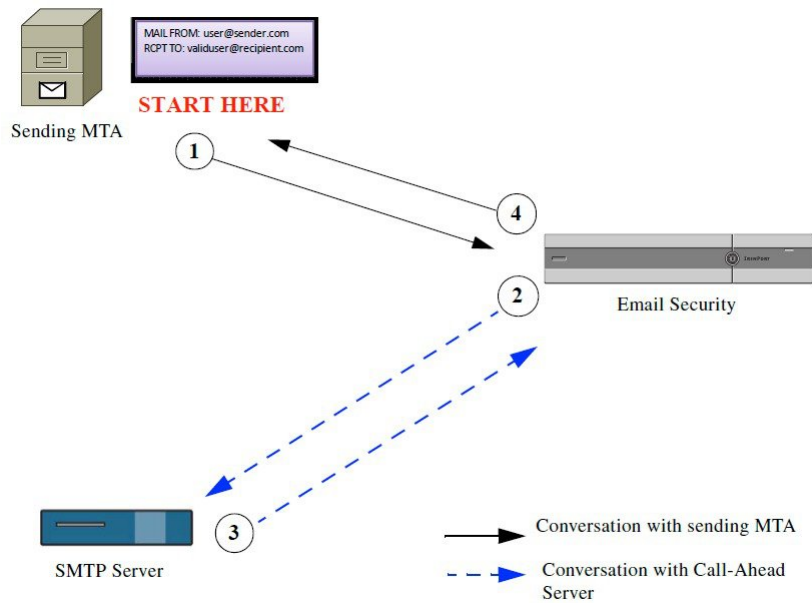

1. The sending MTA initiates an SMTP conversation.
2. The appliance suspends the SMTP conversation while it sends a query to the SMTP server to verify the recipient, *validuser@recipient.com*.



Note If SMTP routes or LDAP routing queries are configured, these routes will be used to query the SMTP server.

3. The SMTP Server returns a query response to the appliance.
4. The appliance resumes the SMTP conversation and sends a response to the sending MTA, allowing the conversation to continue or dropping the connection based on the SMTP server response (and settings you configure in the SMTP Call-Ahead profile).

Due to the order of processes in the email pipeline, if the message for a given recipient is rejected by the RAT, then the SMTP call-ahead recipient validation will not occur. For example, if you specified in the RAT that only mail for *example.com* is accepted, then mail for *recipient@domain2.com* is rejected before SMTP call-ahead recipient validation can occur.



Note If you have configured Directory Harvest Attack Prevention (DHAP) in the HAT, be aware that SMTP call-ahead server rejections are part of the number of rejections included in the maximum invalid recipients per hour that you specify. You may need to adjust this number to account for additional SMTP server rejections. For more information about DHAP, see the “Configuring the Gateway to Receive Email” chapter.

How to Validate Recipients Using an External SMTP Server

	Do This	More Info
Step 1	Determine how the appliance connects to the SMTP server and interprets the server's responses.	Configuring the Call-Ahead Server Profile, on page 645
Step 2	Configure a public listener to use the SMTP server to validate recipients	Enabling a Listener to Validate Incoming Mail Via the SMTP Server, on page 648
Step 3	(Optional) Update your LDAP Routing query to determine the SMTP server to use when routing mail to a different host.	Configuring LDAP Routing Query Settings, on page 648
Step 4	(Optional) Configure the appliance to bypass call-ahead validation for certain recipients	Bypassing SMTP Call-Ahead Validation for Certain Users or Groups, on page 649

Related Topics

- [Configuring the Call-Ahead Server Profile, on page 645](#)

Configuring the Call-Ahead Server Profile

When you configure the SMTP Call-Ahead Server Profile, you specify the settings that determine how the appliance connects with the SMTP server and how it interprets the responses sent back from the SMTP server.

Procedure

-
- Step 1** Click **Network > SMTP Call-Ahead**.
 - Step 2** Click **Add Profile**.
 - Step 3** Enter the settings for the profile. For more information, see *Table - SMTP Call-Ahead Server Profile Settings*.
 - Step 4** Configure the advanced settings for the profile. For more information, see *Table - SMTP Call-Ahead Server Profile Advanced Settings*.
 - Step 5** Submit and commit your changes.
-

What to do next

- [SMTP Call-Ahead Server Profile Settings, on page 645](#)
- [Call Ahead Server Responses, on page 647](#)

SMTP Call-Ahead Server Profile Settings

When you configure the SMTP Call-Ahead Server Profile, you need to configure settings that determine how the appliance connects with the SMTP server.

Table 50: SMTP Call-Ahead Server Profile Settings

Setting	Description
Profile Name	Name of the call-ahead server profile.
Call-Ahead Server Type	<p>Choose from one of the following methods for connecting to the call-ahead server:</p> <ul style="list-style-type: none"> • Use Delivery Host. Select this option to specify that the host for the delivery email address is used for the SMTP call-ahead query. For example, if the mail recipient address is <i>recipient@example.com</i>, the SMTP query is executed against the SMTP server associated with <i>example.com</i>. If you have configured SMTP routes or LDAP routing queries, these routes are used to determine the SMTP server to query. For details about configuring LDAP routing queries, see Configuring LDAP Routing Query Settings, on page 648. • Static Call-Ahead Server. Use this option to create a static list of call-ahead servers to query. You may want to use this option if you do not expect the names and locations of the call-ahead servers to change often. When you use this option, the appliance queries the hosts in a round-robin fashion, starting with the first static call-ahead server listed. <p>Note Note that when you choose the static call-ahead server type, no SMTP routes are applied to the query. Instead an MX lookup is performed, and then an A lookup is performed on the hosts to obtain the call-ahead IP addresses for the static servers.</p>
Static Call-Ahead Servers	<p>If you choose to use the static call-ahead server type, enter a list of host and port combinations in this field. List the server and port using the following syntax:</p> <p>ironport.com:25</p> <p>Separate multiple entries with a comma.</p>

The following table describes the SMTP Call-Ahead Server Profile advanced settings:

Table 51: SMTP Call-Ahead Server Profile Advanced Settings

Setting	Description
Interface	<p>The interface used to initiate the SMTP conversation with the SMTP server. Choose to use the Management interface or Auto. When you select Auto, the appliance attempts to automatically detect an interface to use. The Cisco IronPort interface attempts to connect to the SMTP server in the following ways:</p> <ul style="list-style-type: none"> • If the call-ahead server is on the same subnet as one of the configured interfaces, then the connection is initiated by the matching interface. • Any configured SMTP routes are used to route the query. • Otherwise, the interface that is on the same subnet as the default gateway are used.

Setting	Description
MAIL FROM Address	The MAIL FROM: address to be used for the SMTP conversation with the SMTP server.
Validation Request Timeout	The number of seconds to wait for a result from the SMTP server. This timeout value is for a single recipient validation request which may involve contacting multiple call-ahead servers. See Call Ahead Server Responses, on page 647 .
Validation Failure Action	The action to be taken when a recipient validation request fails (due to a timeout, server failure, network issue, or unknown response). You can configure how you want the appliance to handle the different responses. See Call Ahead Server Responses, on page 647 .
Temporary Failure Action	The action to be taken when a recipient validation request temporarily fails (and a 4xx response is returned from the remote SMTP server). This can occur when the mailbox is full, the mailbox is not available, or the service is not available. See Call Ahead Server Responses, on page 647 .
Max. Recipients per Session	Maximum number of recipients to be validated in a single SMTP session. Specify between 1 - 25,000 sessions.
Max. Connections per Server	Maximum number of connections to a single call-ahead SMTP server. Specify between 1-100 connections.
Cache	Size of the cache for SMTP responses. Specify between 100-1,000,000 entries
Cache TTL	Time-to-live value for entries in the cache. This field defaults to 900 seconds. Specify between 60 - 86400 seconds.

Call Ahead Server Responses

The SMTP server may return the following responses:

- **2xx**: When an SMTP code starting with 2 is received from the call-ahead server, the recipient is accepted. For example, a response of 250 allows the mailing action to continue.
- **4xx**: An SMTP code starting with a 4 means that a temporary failure has occurred in processing the SMTP request. A retry may later be processed successfully. For example, a response of 451 means the requested action was aborted or there was a local error in processing.
- **5xx**: An SMTP code starting with 5 means a permanent failure in processing the SMTP request occurred. For example, a response of 550 means the requested action was not taken or the mailbox was unavailable.
- **Timeout**. If no response is returned from the call-ahead server, you can configure how long to attempt to retry before a timeout occurs.
- **Connection error**. If a connection to the call-ahead server fails, you can configure whether to accept or reject a connection for the recipient address.
- **Custom Response**. You can configure to reject a connection with custom SMTP response (code and text) for validation failures and temporary failures.

Enabling a Listener to Validate Incoming Mail Via the SMTP Server

Once you create the SMTP Call-Ahead Server Profile, you need to enable it on a listener to allow the listener to validate incoming mail via the SMTP server. SMTP call-ahead functionality is only available on public listeners, as recipient validation is not necessary for private listeners.

Procedure

-
- Step 1** Go to **Network > Listeners**.
 - Step 2** Click the name of the listener where you want to enable SMTP call-ahead functionality.
 - Step 3** In the **SMTP Call Ahead Profile** field, select the SMTP Call-Ahead profile you want to enable.
 - Step 4** Submit and commit your changes.
-

Configuring LDAP Routing Query Settings

If you use an LDAP routing query to route mail to a different mail host, AsyncOS uses the Alternate Mailhost Attribute to determine the SMTP server to query. However, there are cases where you may not want that to occur. For example, in the following schema, note that the mail host attribute (mailHost) has a different SMTP address than the servers listed in the call-ahead SMTP server attribute (callAhead):

```
dn: mail=cisco.com, ou=domains
mail: cisco.com
mailHost: smtp.mydomain.com
policy: ASAV
callAhead: smtp2.mydomain.com,smtp3.mydomain.com:9025
```

In this case, you can use the **SMTP Call-Ahead** field to create a routing query that directs the SMTP call-ahead query to the servers listed in the callAhead attribute. For example, you might create a routing query with the following attributes:

Figure 44: LDAP Routing Query Configured for SMTP Call-Ahead

Routing Query	
Name:	LDAP1.routing
Query String:	{mail={d}} Test Query
Recipient Email to Rewrite the Envelope Recipient:	
Alternative Mailhost Attribute:	mailHost
SMTP Call-Ahead Server Attribute (optional):	callAhead <small><i>This attribute is used only if an SMTP Call-Ahead server is configured. Go to Network > SMTP Call-Ahead.</i></small>

In this query, the {d} represents the domain part of the recipient address, and the SMTP Call-Ahead Server Attribute returns the values for the call-ahead servers and the port that should be used for the query: smtp2.mydomain.com, smtp3.mydomain.com on port 9025.



Note This example shows just one way to configure a query that enables you to use the LDAP routing query to direct SMTP call-ahead queries to the correct SMTP servers. You are not required to use the query string or specific LDAP attributes described in this example.

SMTP Call-Ahead Query Routing

When routing an SMTP call-ahead query, AsyncOS checks for information in the following order:

1. Checks the domain name.
2. Checks for LDAP Routing queries.
3. Checks for SMTP Routes.
4. Performs a DNS Lookup (First an MX Lookup is performed, followed by an A lookup).

If there is no LDAP routing query or no SMTP Routes configured for the domain, the result of preceding state is passed to next stage. In any case where there is no SMTP Route present, a DNS lookup is performed.

When you use an LDAP Routing query for an SMTP call-ahead query and you also have SMTP routes configured, the routing behavior depends upon the values returned by the routing query.

- If the LDAP routing query returns a single hostname without a port, the SMTP call-ahead query applies SMTP routes. If the SMTP routes only lists the destination host as the hostname, a DNS lookup is performed to obtain the IP address of the SMTP server.
- If the LDAP routing query returns a single hostname with a port, the SMTP route is used, but the port returned by the LDAP query is used over any ports specified in SMTP routes. If the SMTP routes only lists the destination host as the hostname, a DNS lookup is performed to obtain the IP address of the SMTP server.
- If the LDAP routing query returns multiple hosts with or without ports, SMTP routes are applied, but the ports returned by the LDAP routing query are used over those present in SMTP routes. If the SMTP routes only lists the destination host as the hostname, a DNS lookup is performed to obtain the IP address of the SMTP server.

Bypassing SMTP Call-Ahead Validation for Certain Users or Groups

You may want to enable SMTP call-ahead validation on a listener but skip the SMTP call-ahead validation for certain users or groups of users.

You may want to skip SMTP call-ahead validation for recipients for whom mail should not be delayed during SMTP call-ahead queries. For example, you could add a RAT entry for a customer service alias that you know is valid and will likely need immediate attention.

To configure bypassing SMTP call-ahead validation via the GUI, select **Bypass SMTP Call-Ahead** when you add or edit the RAT entry



CHAPTER 28

Encrypting Communication with Other MTAs

This chapter contains the following sections:

- [Overview of Encrypting Communication with Other MTAs, on page 651](#)
- [Working with Certificates, on page 652](#)
- [Enabling TLS on a Listener's HAT, on page 657](#)
- [Enabling TLS and Certificate Verification on Delivery, on page 660](#)
- [DNS-based Authentication of Named Entities, on page 663](#)
- [Managing Lists of Certificate Authorities, on page 667](#)
- [Enabling a Certificate for HTTPS, on page 669](#)

Overview of Encrypting Communication with Other MTAs

Enterprise Gateways (or Message Transfer Agents, i.e. MTAs) normally communicate “in the clear” over the Internet. That is, the communications are not encrypted. In several scenarios, malicious agents can intercept this communication without the knowledge of the sender or the receiver. Communications can be monitored and even altered by a third party.

Transport Layer Security (TLS) is an improved version of the Secure Socket Layer (SSL) technology. It is a widely used mechanism for encrypting SMTP conversations over the Internet. AsyncOS supports the STARTTLS extension to SMTP (Secure SMTP over TLS), described in RFC 3207 (which obsoletes RFC 2487).

The TLS implementation in AsyncOS provides privacy through encryption. It allows you to import an X.509 certificate and private key from a certificate authority service or create a self-signed certificate to use on the appliance. AsyncOS supports separate TLS certificates for public and private listeners, secure HTTP (HTTPS) management access on an interface, the LDAP interface, and all outgoing TLS connections.

Related Topics

- [How to Encrypt SMTP Conversations using TLS, on page 651](#)

How to Encrypt SMTP Conversations using TLS

How to Encrypt SMTP Conversations using TLS

	Do This	More Info
Step 1	Obtain an X.509 certificate and private key from a recognized certificate authority.	Working with Certificates, on page 652
Step 2	Install the certificate on the appliance	Install a certificate by either: <ul style="list-style-type: none"> • Creating a Self-Signed Certificate , on page 654 • Importing a Certificate , on page 656
Step 3	Enable TLS for receiving messages, delivering messages, or both	<ul style="list-style-type: none"> • Enabling TLS on a Listener's HAT, on page 657 • Enabling TLS and Certificate Verification on Delivery, on page 660
Step 4	(Optional) Customize the list of trusted certificate authorities that the appliance uses to verify a certificate from a remote domain to establish the domain's credentials.	Managing Lists of Certificate Authorities, on page 667
Step 5	(Optional) Configure the appliance to send an alert when it's unable to deliver messages to a domain that requires a TLS connection.	Sending Alerts When a Required TLS Connection Fails, on page 662

Working with Certificates

To use TLS, the appliance must have an X.509 certificate and matching private key for receiving and delivery. You may use the same certificate for both SMTP receiving and delivery and different certificates for HTTPS services on an interface, the LDAP interface, and all outgoing TLS connections to destination domains, or use one certificate for all of them.

You can view the entire list of certificates on the Network > Certificates page in the web interface and in the CLI by using the print command after you configure the certificates using certconfig . Note that the print command does not display intermediate certificates.



Caution

Your appliance ships with a demonstration certificate to test the TLS and HTTPS functionality, but enabling either service with the demonstration certificate is not secure and is not recommended for general use. When you enable either service with the default demonstration certificate, a warning message is printed in the CLI.

Related Topics

- [Deploying a Signed Certificate , on page 653](#)
- [Deploying Self-Signed Certificates , on page 653](#)

Deploying a Signed Certificate

Use a signed certificate when you cannot exchange self-signed certificates between the appliance and the other machine, for example because that machine is not in your domain. Your corporate security department may have other requirements.

	Do This	More Info
Step 1	If you are deploying in a cluster, follow instructions.	Certificates and Centralized Management, on page 654
Step 2	Generate a self-signed certificate and Certificate Signing Request (CSR).	Creating a Self-Signed Certificate , on page 654
Step 3	Send the generated certificate to a recognized Certificate Authority for signing.	About Sending a Certificate Signing Request (CSR) to a Certificate Authority , on page 655
Step 4	Upload the signed certificate.	Uploading a Certificate Signed by a Certificate Authority , on page 656
Step 5	Ensure that the certificate authority that signed the certificate is on the list of trusted authorities.	Managing Lists of Certificate Authorities, on page 667
Step 6	If applicable, use an intermediate certificate.	Intermediate Certificates, on page 654

Deploying Self-Signed Certificates

You can generally use self-signed certificates for communications between appliances that are behind your corporate firewall. Your corporate security department may have other requirements.

	Do This	More Info
Step 1	If you are deploying in a cluster, follow instructions.	Certificates and Centralized Management, on page 654
Step 2	Generate a self-signed certificate from the appliance .	Creating a Self-Signed Certificate , on page 654
Step 3	Export the self-signed certificate.	Exporting a Certificate , on page 657
Step 4	Import the self-signed certificate to the machine with which the appliance will communicate.	See the documentation for the other machine.
Step 5	Generate and export a self-signed certificate from the other machine.	See the documentation for the other machine.

	Do This	More Info
Step 6	Import the self-signed certificate from the other machine into the appliance .	Importing a Certificate , on page 656 or See the chapter in this guide for configuring communication with that machine. For example, to configure secure communications with a Cisco AMP Threat Grid Appliance, see instructions for configuring Advanced settings in Configuring an On-Premises File Analysis Server , on page 462.

Certificates and Centralized Management

A certificate usually uses the local machine's hostname for the certificate's common name. If your appliances are part of a cluster, you will need to import a certificate for each cluster member as the machine level, with the exception of a wild card certificate or a Subject Alternative Name (SAN) certificate that you can install at the cluster level. Each cluster member's certificate must use the same certificate name so the cluster can refer to it when a member's listener is communicating with another machine.

Intermediate Certificates

In addition to root certificate verification, AsyncOS supports the use of intermediate certificate verification. Intermediate certificates are certificates issued by a trusted root certificate authority which are then used to create additional certificates - effectively creating a chained line of trust. For example, a certificate may be issued by godaddy.com who, in turn, is granted the rights to issue certificates by a trusted root certificate authority. The certificate issued by godaddy.com must be validated against godaddy.com's private key as well as the trusted root certificate authority's private key.

Creating a Self-Signed Certificate

You might want to create a self-signed certificate on the appliance for any of the following reasons:

- To encrypt SMTP conversations with other MTAs using TLS (both inbound and outbound conversations).
- To enable the HTTPS service on the appliance for accessing the GUI using HTTPS.
- Use as a client certificate for LDAPS if the LDAP server asks for a client certificate.
- To allow secure communication between the appliance and a Cisco AMP Threat Grid Appliance.

To create a self-signed certificate using the CLI, use the certconfig command.

Procedure

-
- Step 1** Select **Network > Certificates**.
- Step 2** Click **Add Certificate**.
- Step 3** Select **Create Self-Signed Certificate**.
- Step 4** Enter the following information for the self-signed certificate:

Common Name	The fully qualified domain name.
Organization	The exact legal name of the organization.

Common Name	The fully qualified domain name.
Organizational Unit	Section of the organization.
City (Locality)	The city where the organization is legally located.
State (Province)	The state, county, or region where the organization is legally located.
Country	The two letter ISO abbreviation of the country where the organization is legally located.
Duration before expiration	The number of days before the certificate expires.
Private Key Size	Size of the private key to generate for the CSR. Only 2048-bit and 1024-bit are supported.

- Step 5** Click **Next**.
- Step 6** Enter a name for the certificate. By default, AsyncOS assigns the common name previously entered.
- Step 7** If you will submit this certificate as a Certificate Signing Request (CSR), click **Download Certificate Signing Request** to save the CSR in PEM format to a local or network machine.
- Step 8** Submit and commit your changes.

What to do next

See the appropriate next step:

- [Deploying a Signed Certificate](#) , on page 653
- [Deploying Self-Signed Certificates](#) , on page 653

About Sending a Certificate Signing Request (CSR) to a Certificate Authority

A certificate authority is a third-party organization or company that issues digital certificates used to verify identity and distributes public keys. This provides an additional level of assurance that the certificate is issued by a valid and trusted identity. You may purchase certificates and private keys from a recognized certificate authority. Cisco does not recommend one service over another.

The appliance can create a self-signed certificate and generate a Certificate Signing Request (CSR) to submit to a certificate authority to obtain the public certificate. The certificate authority will return a trusted public certificate signed by a private key. Use the **Network > Certificates** page in the web interface or the `certconfig` command in the CLI to create the self-signed certificate, generate the CSR, and install the trusted public certificate.

If you are acquiring or creating a certificate for the first time, search the Internet for “certificate authority services SSL Server Certificates,” and choose the service that best meets the needs of your organization. Follow the service’s instructions for obtaining a certificate.

What To Do Next

See [Deploying a Signed Certificate](#) , on page 653.

Uploading a Certificate Signed by a Certificate Authority

When the certificate authority returns the trusted public certificate signed by a private key, upload the certificate to the appliance .

You can use the certificate with a public or private listener, an IP interface's HTTPS services, the LDAP interface, or all outgoing TLS connections to destination domains.

Procedure

-
- Step 1** Make sure that the trusted public certificate that you receive is in PEM format or a format that you can convert to PEM using before uploading to the appliance . (Tools for doing this are included with OpenSSL, free software from <http://www.openssl.org>.)
- Step 2** Upload the signed certificate to the appliance :
- Note** Uploading the certificate from the certificate authority overwrites the existing self-signed certificate.
- Select **Network > Certificates**.
 - Click the name of the certificate that you sent to the Certificate Authority for signing.
 - Enter the path to the file on your local machine or network volume.
- Step 3** You can also upload an intermediate certificate related to the self-signed certificate.
-

What to do next

Related Topics

- [Deploying a Signed Certificate](#) , on page 653

Importing a Certificate

AsyncOS also allows you to import certificates from other machines that are saved in the PKCS #12 format to use on your appliance .

To import a certificate using the CLI, use the `certconfig` command.



Note If you are deploying a signed certificate, do not use this procedure to import the signed certificate. Instead, see [Uploading a Certificate Signed by a Certificate Authority](#) , on page 656 .

Procedure

-
- Step 1** Select **Network > Certificates**.
- Step 2** Click **Add Certificate**.
- Step 3** Select the **Import Certificate** option.
- Step 4** Enter the path to the certificate file on your network or local machine.
- Step 5** Enter the passphrase for the file.
- Step 6** Click **Next** to view the certificate's information.

- Step 7** Enter a name for the certificate.
AsyncOS assigns the common name by default.
- Step 8** Submit and commit your changes.
-

What to do next

- If you are deploying self-signed certificates, see [Deploying Self-Signed Certificates](#) , on page 653.

Exporting a Certificate

AsyncOS also allows you to export certificates and save them in the PKCS #12 format.



Note If you are deploying a signed certificate, do not use this procedure to generate a Certificate Signing Request (CSR). Instead, see [Deploying a Signed Certificate](#) , on page 653.

Procedure

- Step 1** Navigate to the **Network > Certificates** page.
- Step 2** Click **Export Certificate**.
- Step 3** Select the certificate you want to export.
- Step 4** Enter the file name for the certificate.
- Step 5** Enter and confirm the passphrase for the certificate file.
- Step 6** Click **Export**.
- Step 7** Save the file to a local or network machine.
- Step 8** You can export additional certificates or click **Cancel** to return to the Network > Certificates page.
-

What to do next

- If you are deploying self-signed certificates, see [Deploying Self-Signed Certificates](#) , on page 653.

Enabling TLS on a Listener's HAT

You must enable TLS for any listeners where you require encryption. You may want to enable TLS on listeners facing the Internet (that is, public listeners), but not for listeners for internal systems (that is, private listeners). Or, you may want to enable encryption for all listeners.

You can specify the following settings for TLS on a listener.

Table 52: TLS Settings for a Listener

TLS Setting	Meaning
1. No	TLS is not allowed for incoming connections. No connections to the listener will require encrypted SMTP conversations. This is the default setting for all listeners you configure on the appliance .
2. Preferred	TLS is allowed for incoming connections to the listener from MTAs.
3. Required	TLS is allowed for incoming connections to the listener from MTAs, and until a <code>STARTTLS</code> command is received, the appliance responds with an error message to every command other than <code>NOOP</code> , <code>EHLO</code> , or <code>QUIT</code> . This behavior is specified by RFC 3207, which defines the SMTP Service Extension for Secure SMTP over Transport Layer Security. “Requiring” TLS means that email which the sender is not willing to encrypt with TLS will be refused by the appliance before it is sent, thereby preventing it from being transmitted in the clear.

By default, neither private nor public listeners allow TLS connections. You must enable TLS in a listener’s HAT to enable TLS for either inbound (receiving) or outbound (sending) email. In addition, all default mail flow policy settings for private and public listeners have the `tls` setting set to “off.”

You can assign a specific certificate for TLS connections to individual public listeners when creating a listener. For more information, see [Listening for Connection Requests by Creating a Listener Using Web Interface, on page 75](#).

Related Topics

- [Assigning a Certificate to a Public or Private Listener for TLS Connections Using the GUI, on page 658](#)
- [Assigning a Certificate to a Public or Private Listener for TLS Connections Using the CLI, on page 659](#)
- [Logging, on page 663](#)
- [GUI Example: Changing the TLS setting for Listeners HAT, on page 659](#)
- [CLI Example: Changing the TLS Setting for Listeners HAT, on page 659](#)

Assigning a Certificate to a Public or Private Listener for TLS Connections Using the GUI

Procedure

-
- Step 1** Navigate to the Network > Listeners page.
 - Step 2** Click the name of the Listener to edit.
 - Step 3** In the Certificate field, choose a certificate.
 - Step 4** Submit and commit your changes.
-

Assigning a Certificate to a Public or Private Listener for TLS Connections Using the CLI

Procedure

- Step 1** Use the `listenerconfig -> edit` command to choose a listener you want to configure.
- Step 2** Use the `certificate` command to see the available certificates.
- Step 3** Choose the certificate you want to assign to the listener when prompted.
- Step 4** When you are finished configuring the listener, issue the `commit` command to enable the change.
-

Logging

The Email Security appliance will note in the mail logs instances when TLS is required but could not be used by the listener. The mail logs will be updated when the following conditions are met:

- TLS is set to “required” for a listener.
- The Email Security appliance has sent a “Must issue a STARTTLS command first” command.
- The connection is closed without having received any successful recipients.

Information on why the TLS connection failed will be included in the mail logs.

GUI Example: Changing the TLS setting for Listeners HAT

Procedure

- Step 1** Navigate to the Mail Policies > Mail Flow Policies page.
- Step 2** Choose a listener whose policies you want to modify, and then click the link for the name of policy to edit. (You can also edit the Default Policy Parameters.)
- Step 3** In the “Encryption and Authentication” section, for the “TLS:” field, choose the level of TLS you want for the listener.
- Step 4** Submit and commit your changes
- The mail flow policy for the listener is updated with the TLS setting you chose
-

CLI Example: Changing the TLS Setting for Listeners HAT

Procedure

- Step 1** Use the `listenerconfig -> edit` command to choose a listener you want to configure.

Step 2 Use the `hostaccess -> default` command to edit the listener's default HAT settings.

Step 3 Change the TLS setting by entering one of the following choices when you are prompted with the following questions:

```
Do you want to allow encrypted TLS connections?
```

1. No
2. Preferred
3. Required

```
[1]> 3
```

```
You have chosen to enable TLS. Please use the 'certconfig' command to ensure that there is a valid certificate configured.
```

Step 4 Note that this example asks you to use the `certconfig` command to ensure that there is a valid certificate that can be used with the listener. If you have not created any certificates, the listener uses the demonstration certificate that is pre-installed on the appliance. You may enable TLS with the demonstration certificate for testing purposes, but it is not secure and is not recommended for general use. Use the `listenerconfig -> edit -> certificate` command to assign a certificate to the listener. Once you have configured TLS, the setting will be reflected in the summary of the listener in the CLI.

```
Name: Inboundmail
```

```
Type: Public
```

```
Interface: PublicNet (192.168.2.1/24) TCP Port 25
```

```
Protocol: SMTP
```

```
Default Domain:
```

```
Max Concurrency: 1000 (TCP Queue: 50)
```

```
Domain map: disabled
```

```
TLS: Required
```

Step 5 Issue the `commit` command to enable the change

Enabling TLS and Certificate Verification on Delivery

You can require that TLS is enabled for email delivery to specific domains using the Destination Controls page or the `destconfig` command.

In addition to TLS, you can require that the domain's server certificate is verified. This domain verification is based on a digital certificate used to establish the domain's credentials. The validation process involves two validation requirements:

- The chain of issuer certificates for the SMTP session ends in a certificate issued by a trusted certificate authority (CA)
- The Common Name (CN) listed on the certificate matches either the receiving machine's DNS name or the message's destination domain.

-or-

The message's destination domain matches one of the DNS names in the certificate's Subject Alternative Name (subjectAltName) extension, as described in RFC 2459. The matching supports wildcards as described in section 3.1 of RFC 2818.

- [Optional - Only if FQDN validation enabled in SSL Configuration settings]: Check whether the 'Common Name,' 'SAN: DNS Name' fields, or both present in the server certificate, are in the FQDN format.

A trusted CA is a third-party organization or company that issues digital certificates used to verify identity and distributes public keys. This provides an additional level of assurance that the certificate is issued by a valid and trusted identity.

You can configure your appliance to send messages to a domain over a TLS connection as an alternative to envelope encryption. See the “Cisco Email Encryption” chapter for more information.

You can specify a certificate for the appliance to use for all outgoing TLS connections. To specify the certificate, click **Edit Global Settings** on the Destination Controls page or use `destconfig -> setup` in the CLI. The certificate is a global setting, not a per-domain setting.

You can specify 5 different settings for TLS for a given domain when you include a domain using the Destination Controls page or the `destconfig` command. In addition to specifying whether exchanges with a domain are required or preferred to be TLS encoded, you can dictate whether validation of the domain is necessary. See the following table for an explanation of the settings:

Table 53: TLS Settings for Delivery

TLS Setting	Meaning
Default	The default TLS setting set using the Destination Controls page or the <code>destconfig -> default</code> subcommand used for outgoing connections from the listener to the MTA for the domain. The value “Default” is set if you answer “no” to the question: “Do you wish to apply a specific TLS setting for this domain?”
1. No	TLS is not negotiated for outgoing connections from the interface to the MTA for the domain.
2. Preferred	TLS is negotiated from the appliance interface to the MTA(s) for the domain. However, if the TLS negotiation fails (prior to receiving a 220 response), the SMTP transaction does not fall back to clear text. No attempt is made to verify if the certificate originates from a trusted certificate authority. If an error occurs and the TLS negotiation fails after the 220 response is received, the SMTP transaction will continue "in the clear" (not encrypted).
3. Required	TLS is negotiated from the appliance interface to MTA(s) for the domain. No attempt is made to verify the domain’s certificate. If the negotiation fails, no email is sent through the connection. If the negotiation succeeds, the mail is delivered via an encrypted session.

TLS Setting	Meaning
4. Preferred (Verify)	<p>TLS is negotiated from the appliance to the MTA(s) for the domain. The appliance attempts to verify the domain's certificate.</p> <p>Three outcomes are possible:</p> <ul style="list-style-type: none"> • TLS is negotiated and the certificate is verified. The mail is delivered via an encrypted session. • TLS is negotiated, but the certificate is not verified. The mail is delivered via an encrypted session. • No TLS connection is made and, subsequently the certificate is not verified. The email message is delivered in plain text.
5. Required (Verify)	<p>TLS is negotiated from the appliance to the MTA(s) for the domain. Verification of the domain certificate is required. The following outcomes are possible:</p> <ul style="list-style-type: none"> • A TLS connection is negotiated and the certificate is verified. The email message is delivered via an encrypted session. • A TLS connection is negotiated, but the certificate is not verified by a trusted Certificate Authority (CA). The mail is not delivered. • A TLS connection is not negotiated. The mail is not delivered.
6. Required - Verify Hosted Domains	<p>The difference between TLS Required - Verify and TLS Required - Verify Hosted Domain options lays in identity verification process. The way how the presented identity is processed and what type of reference identifiers are allowed to be used make a difference about a final result.</p> <p>The presented identity is first derived from <code>subjectAltName</code> extension of type <code>dNSName</code>. If there is no match between the <code>dNSName</code> and one of accepted reference identities (<code>REF-ID</code>), the verification fails no matter if <code>CN</code> exist in subject field and could pass further identity verification. The <code>CN</code> derived from subject field is validated only when the certificate does not contain any of <code>subjectAltName</code> extension of type <code>dNSName</code>.</p>

If there is no specific entry for a given recipient domain in the good neighbor table, or if there is a specific entry but there is no specific TLS setting for the entry, then the behavior is whatever is set using the Destination Controls page or the `destconfig -> default` subcommand (“No,” “Preferred,” “Required,” “Preferred (Verify),” or “Required (Verify)”).

Related Topics

- [Sending Alerts When a Required TLS Connection Fails, on page 662](#)
- [Logging, on page 663](#)
- [Managing Lists of Certificate Authorities, on page 667](#)

Sending Alerts When a Required TLS Connection Fails

You can specify whether the appliance sends an alert if the TLS negotiation fails when delivering messages to a domain that requires a TLS connection. The alert message contains name of the destination domain for the failed TLS negotiation. The appliance sends the alert message to all recipients set to receive Warning

severity level alerts for System alert types. You can manage alert recipients via the System Administration > Alerts page in the GUI (or via the `alertconfig` command in the CLI).

Related Topics

- [Enabling TLS Connection Alerts , on page 663](#)

Enabling TLS Connection Alerts

Procedure

- Step 1** Navigate to the Mail Policies Destination Controls page.
- Step 2** Click **Edit Global Settings**.
- Step 3** Click **Enable** for “Send an alert when a required TLS connection fails.”
- This is a global setting, not a per-domain setting. For information on the messages that the appliance attempted to deliver, use the Monitor > Message Tracking page or the mail logs.
- Step 4** Submit and commit your changes.
-

What to do next

You can also configure this in the command-line interface using the `destconfig -> setup` command to enable TLS connection alerts using the CLI

Logging

The appliance will note in the mail logs instances when TLS is required for a domain but could not be used. Information on why the TLS connection could not be used will be included. The mail logs will be updated when any of the following conditions are met:

- The remote MTA does not support ESMTP (for example, it did not understand the EHLO command from the appliance).
- The remote MTA supports ESMTP but “STARTTLS” was not in the list of extensions it advertised in its EHLO response.
- The remote MTA advertised the “STARTTLS” extension but responded with an error when the appliance sent the STARTTLS command.

DNS-based Authentication of Named Entities

- [Overview of SMTP DNS-based Authentication of Named Entities, on page 664](#)
- [Enabling TLS for Delivery with DANE Support, on page 666](#)
- [Sending Alerts When DANE Fails, on page 667](#)

Overview of SMTP DNS-based Authentication of Named Entities

TLS connections that are authenticated using certificates can become vulnerable to a security breach in any one of the following ways:

- A trusted Certificate Authority (CA) can issue certificates to any domain name.
- An attacker can use a man-in-the-middle (MITM) attack to downgrade a TLS connection to plain text communication.
- If DNSSEC is not configured on the DNS server, an attacker can forge a DNS response with fake DNS MX records and redirect messages to an insecure server which can lead to DNS cache poisoning attacks.
- Self-signed certificates or certificates issued by a private Certificate Authority (CA) can be used when a receiving Mail Transfer Agent (MTA) is not configured with a list of trusted Certificate Authority.

The SMTP DNS-based Authentication of Named Entities (DANE) protocol validates your X.509 certificates with DNS names using a Domain Name System Security (DNSSEC) extension configured on your DNS server and a DNS resource record, also known as a TLSA record.

The TLSA record is added in the certificate that contains details about either the Certificate Authority (CA), the end entity certificate, or the trust anchor used for the DNS name described in *RFC 6698*. For more information, see [Creating TLSA Record, on page 665](#). The Domain Name System Security (DNSSEC) extensions provide added security on the DNS by addressing vulnerabilities in DNS security. DNSSEC using cryptographic keys and digital signatures ensures that the lookup data is correct and connects to legitimate servers.

The following are the benefits of using SMTP DANE for outgoing TLS connections:

- Provides secure delivery of messages by preventing Man-in-the-Middle (MITM) downgrade attacks, eavesdropping and DNS cache poisoning attacks.
- Provides authenticity of TLS certificates and DNS information, when secured by DNSSEC.

Related Topics

- [SMTP DANE Workflow, on page 664](#)
- [Creating TLSA Record, on page 665](#)
- [Enabling TLS for Delivery with DANE Support, on page 666](#)
- [Sending Alerts When DANE Fails, on page 667](#)

SMTP DANE Workflow

The following figure describes flow of messages using outgoing TLS connection with DANE support:

Figure 45: Message Delivery Using TLS with DANE Support

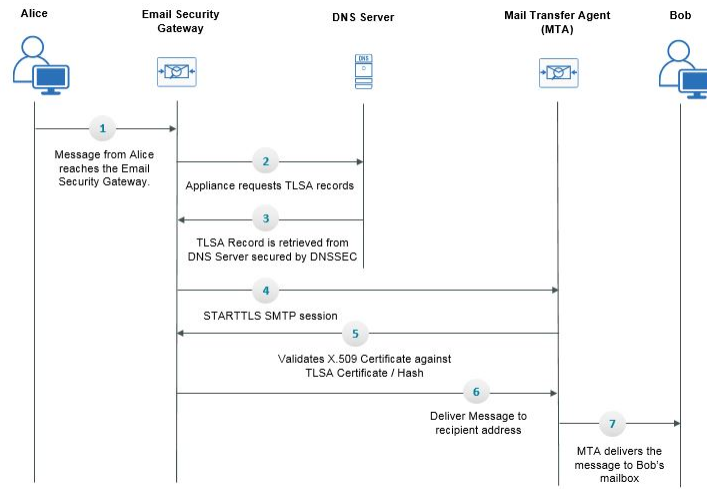

1. Sender (Alice) sends a message to a recipient (Bob) outside the organization.
2. The message reaches the email gateway.
3. The email gateway requests for a DNS resource record, also known as a TLSA record of the DNS from the DNS server.
4. The certificates and a TLSA record is retrieved from the DNS server, secured by DNSSEC.
5. The email gateway establishes a STARTTLS SMTP session to the recipient's address.
6. The X.509 certificates are validated against the complete TLSA record or hash value of the TLSA record, of the recipient's address. After successful validation, the message is delivered to the recipient's Mail Transfer Agent (MTA). If certificate verification fails, the message is delivered at a later time or the message is bounced.
7. The MTA delivers the message to recipient's mailbox.

Creating TLSA Record

You can create a TLSA record of your preferred certificate authority (CA) on the DNS record signed with DNSSEC. Below is a sample TLSA record for a Fully Qualified Domain Name (FQDN) `www.example.com`:

```

_443._tcp.www.example.com. IN TLSA (0 0 1
91751cee0a1ab8414400238a761411daa29643ab4b8243e9a91649e25be53ada)

```

The above example TLSA record has the following fields that are encrypted:

- **Certificate Usage:** Specifies the type of certificate.
 - In the given sample, the first '0' digit specifies the CA certificate that must be matched to the PKIX certification path, as described in RFC 6698.
 - If it is '1', it specifies the end entity certificate that must be matched to the end entity certificate given by the server in TLS.

- If it is '2', it specifies a certificate that must be used as a trust anchor while validating the end entity certificate given by the server in TLS.
- If it is '3', it specifies a certificate that must match the end entity certificate given by the server in TLS.
- **Selector Field:** Specifies the part of TLS certificate that is matched with the association data.
 - In the given sample, the second '0' specifies that the full certificate must be matched.
 - If it is '1', it specifies that only the 'SubjectPublicKeyInfo' field must be matched.
- **Matching Type:** Specifies the type of HASH value that is used.
 - In the given sample, the third '1' specifies the SHA-256 hash of the selected content.
 - If it is '0', it specifies the exact match on the selected content.
 - If it is '2' it specifies the SHA-512 hash of the selected content.

Enabling TLS for Delivery with DANE Support

Before you begin

- Ensure that the envelope sender and the TLSA resource record is DNSSEC verified.
- Ensure that you enable TLS to configure DANE on your appliance . For more information, see [Enabling TLS and Certificate Verification on Delivery, on page 660](#).

Procedure

- Step 1** Go to **Mail Policies > Destination Controls** page.
- Step 2** Click **Add Destination Controls** or modify an existing entry.
- Step 3** From the **TLS Support** field, you must select **Preferred, Required** or **Mandatory** to enable DANE support on your appliance .
- Step 4** From the **DANE Support** field, you can specify the following settings for DANE for a given TLS connection.

DANE Setting	Description
Default	The default DANE setting set using the Destination Controls page is used for outgoing TLS connections from the listener to the MTA for the domain. The "Default" DANE setting is inherited from the default TLS settings in Destination Controls. You can override this setting to the custom Destination Control entry.
None	Select "None", if you do not want DANE to be used for negotiating outgoing connections from the interface to the MTA for the domain.

DANE Setting	Description
Opportunistic	<p>If you select "Opportunistic" and the remote host does not support DANE, opportunistic TLS is used for encrypting SMTP conversations.</p> <p>If you select "Opportunistic" and the remote host supports DANE, it becomes the preferred mode for encrypting SMTP conversations.</p>
Mandatory	<p>If you select "Mandatory" and the remote host does not support DANE, no connection is established to the destination host.</p> <p>If you select "Mandatory" and the remote host supports DANE, it becomes the preferred mode for encrypting SMTP conversations.</p>

Step 5 Submit and Commit your changes.

Sending Alerts When DANE Fails

You can specify whether the appliance sends an alert if the DANE verification fails to all MX hosts when delivering messages to a domain that requires a TLS connection with DANE support. The appliance sends the alert message to all recipients set to receive Warning severity level alerts for System alert types.

Enabling DANE Alerts

Procedure

- Step 1** Go to **System Administration > Alerts** page.
- Step 2** Select the alert recipient you want to enable the alert.
- Step 3** Select the **Message Delivery** check box corresponding to the alert type.
- Step 4** Submit and commit your changes.

Managing Lists of Certificate Authorities

The appliance uses stored trusted certificate authorities that it uses to verify a certificate from a remote domain to establish the domain's credentials. You can configure the appliance to use the following trusted certificate authorities:

- **Pre-installed list.** The appliance has a pre-installed list of trusted certificate authorities. This is called the system list.
- **User-defined list.** You can customize a list of trusted certificate authorities and then import the list onto the appliance .

You can use either the system list or the customized list, and you can also use both lists to verify certificate from a remote domain.

Manage the lists using the Network > Certificates > Edit Certificate Authorities page in the GUI or the certconfig > certauthority command in the CLI.

On the Network > Certificates > Edit Certificate Authorities page, you can perform the following tasks:

- **View the system list (pre-installed) of certificate authorities.** For more information, see [Viewing the Pre-Installed list of Certificate Authorities, on page 668](#).
- **Choose whether or not to use the system list.** You can enable or disable the system list. For more information, see [Disabling the System Certificate Authority List, on page 668](#).
- **Choose whether or not to use a custom certificate authority list.** You can enable the appliance to use a custom list and then import the list from a text file. For more information, see [Importing a Custom Certificate Authority List, on page 669](#).
- **Export the list of certificate authorities to a file.** You can export either the system or customized list of certificate authorities to a text file. For more information, see [Exporting a Certificate Authorities List, on page 669](#).

Related Topics

- [Viewing the Pre-Installed list of Certificate Authorities, on page 668](#)
- [Disabling the System Certificate Authority List, on page 668](#)
- [Importing a Custom Certificate Authority List, on page 669](#)
- [Exporting a Certificate Authorities List, on page 669](#)

Viewing the Pre-Installed list of Certificate Authorities

Procedure

-
- Step 1** Navigate to the Network > Certificates page.
 - Step 2** Click **Edit Settings** in the Certificate Authorities section.
 - Step 3** Click **View System Certificate Authorities**.
-

Disabling the System Certificate Authority List

The pre-installed system certificate authorities list cannot be removed from the appliance, but you can enable or disable it. You might want to disable it to allow the appliance to only use your custom list to verify certificates from remote hosts.

Procedure

-
- Step 1** Navigate to the Network > Certificates page.
 - Step 2** Click **Edit Settings** in the Certificate Authorities section.
 - Step 3** Click **Disable** for the System List.

- Step 4** Submit and commit your changes.
-

Importing a Custom Certificate Authority List

You can create a custom of list trusted certificate authorities and import it onto the appliance . The file must be in the PEM format and include certificates for the certificate authorities that you want the appliance to trust.

Procedure

- Step 1** Navigate to the Network > Certificates page.
- Step 2** Click **Edit Settings** in the Certificate Authorities section.
- Step 3** Click **Enable** for the Custom List.
- Step 4** Enter the full path to the custom list on a local or network machine.
- Step 5** Submit and commit your changes.
-

Exporting a Certificate Authorities List

If you want to use only a subset of the trusted certificate authorities in the system or edit an existing custom list, you can export the list to a .txt file and edit it to add or remove certificate authorities. After you have finished editing the list, import the file back onto the appliance as a custom list.

Procedure

- Step 1** Navigate to the Network > Certificates page.
- Step 2** Click **Edit Settings** in the Certificate Authorities section.
- Step 3** Click **Export List**.
- AsyncOS displays the Export Certificate Authority List page.
- Step 4** Select the list you want to export.
- Step 5** Enter a filename for the list.
- Step 6** Click **Export**.
- AsyncOS displays a dialog box asking if want to open or save the list as a .txt file.
-

Enabling a Certificate for HTTPS

You can enable a certificate for HTTPS services on an IP interface using either the **Network > IP Interfaces** page in the GUI or the `interfaceconfig` command in the CLI.

Procedure

- Step 1** Navigate to the **Network > IP Interfaces** page.
- Step 2** Select the interface you want to enable the HTTPS service.
- Step 3** Under Appliance Management, check the **HTTPS** check box and enter the port number.
- Step 4** Submit and commit your changes.
-

What to do next



- Note** The demonstration certificate that is pre-installed on the appliance . You may enable HTTPS services with the demonstration certificate for testing purposes, but it is not secure and is not recommended for general use. You can enable HTTPS services using the System Setup Wizard in the GUI. For more information , see [Setup and Installation, on page 17](#).
-



CHAPTER 29

Configuring Routing and Delivery Features

This chapter contains the following sections:

- [Routing Email for Local Domains, on page 671](#)
- [Rewriting Addresses, on page 676](#)
- [Creating Alias Tables, on page 677](#)
- [Configuring Masquerading, on page 684](#)
- [The Domain Map Feature, on page 694](#)
- [Directing Bounced Email, on page 700](#)
- [Controlling Email Delivery Using Destination Controls, on page 708](#)
- [Bounce Verification, on page 716](#)
- [Set Email Delivery Parameters, on page 720](#)
- [Configuring Mail Gateways for all Hosted Domains Using Virtual Gateway™ Technology, on page 723](#)
- [Using Global Unsubscribe, on page 731](#)
- [Review: Email Pipeline, on page 734](#)

Routing Email for Local Domains

In [Configuring the Gateway to Receive Email, on page 69](#) you customized private and public listeners to service SMTP connections for an Enterprise Gateway configuration. Those listeners were customized to handle specific connections (via HAT modification) and receive mail for specific domains (via RAT modification of public listeners).

The appliance routes mail to local domains to hosts specified via the **Network > SMTP Routes** page (or the `smtproutes` command). This feature is similar to the `sendmail mailertable` feature.



Note If you have completed the GUI's System Setup Wizard (or the Command Line Interface `systemsetup` command) as described in the “Setup and Installation” chapter and committed the changes, you defined the first SMTP route entries on the appliance for each RAT entry you entered at that time.

Related Topics

- [SMTP Routes Overview, on page 672](#)
- [Default SMTP Route, on page 672](#)

- [Defining an SMTP Route, on page 673](#)
- [SMTP Routes Limits, on page 673](#)
- [SMTP Routes and DNS, on page 673](#)
- [SMTP Routes and Alerts, on page 674](#)
- [SMTP Routes, Mail Delivery, and Message Splintering, on page 674](#)
- [SMTP Routes and Outbound SMTP Authentication, on page 674](#)
- [Managing SMTP Routes to Send Outbound Email Using the GUI, on page 674](#)

SMTP Routes Overview

SMTP Routes allow you to redirect all email for a particular domain to a different mail exchange (MX) host. For example, you could make a mapping from `example.com` to `groupware.example.com`. This mapping causes any email with `@example.com` in the Envelope Recipient address to go instead to `groupware.example.com`. The system performs an “MX” lookup on `groupware.example.com`, and then performs an “A” lookup on the host, just like a normal email delivery. This alternate MX host does not need to be listed in DNS MX records and it does not even need to be a member of the domain whose email is being redirected. The AsyncOS operating system allows up to forty thousand (40,000) SMTP Route mappings to be configured for your appliance. (See [SMTP Routes Limits, on page 673](#))

This feature also allows host “globbing.” If you specify a partial domain, such as `.example.com`, then any domain ending in `example.com` matches the entry. For instance, `fred@foo.example.com` and `wilma@bar.example.com` both match the mapping.

If a host is not found in the SMTP Routes table, an MX lookup is performed using DNS. The result is not re-checked against the SMTP Routes table. If the DNS MX entry for `foo.domain` is `bar.domain`, any email sent to `foo.domain` is delivered to the host `bar.domain`. If you create a mapping for `bar.domain` to some other host, email addressed to `foo.domain` is not affected.

In other words, recursive entries are not followed. If there is an entry for `a.domain` to redirect to `b.domain`, and a subsequent entry to redirect email for `b.domain` to `a.domain`, a mail loop will *not* be created. In this case, email addressed to `a.domain` will be delivered to the MX host specified by `b.domain`, and conversely email addressed to `b.domain` will be delivered to the MX host specified by `a.domain`.

The SMTP Routes table is read from the top down for every email delivery. The most specific entry that matches a mapping wins. For example, if there are mappings for both `host1.example.com` and `.example.com` in the SMTP Routes table, the entry for `host1.example.com` will be used because it is the more specific entry — even if it appears after the less specific `.example.com` entry. Otherwise, the system performs a regular MX lookup on the domain of the Envelope Recipient.

Default SMTP Route

You can also define a default SMTP route with the special keyword `ALL`. If a domain does not match a previous mapping in the SMTP Routes list, it defaults to being redirected to the MX host specified by the `ALL` entry.

When you print the SMTP Routes entries, the default SMTP route is listed as `ALL:`. You cannot delete the default SMTP route; you may only clear any values entered for it.

Configure the default SMTP route via the Network > SMTP Routes page or the `smtproutes` command.

Defining an SMTP Route

Use the Network > SMTP Routes page (or the `smtproutes` command) to construct routes. When you create a new route, you first specify the domain or partial domain for which you want to create a permanent route. You then specify destination hosts. Destination hosts can be entered as fully-qualified hostnames or as IP addresses. IP addresses can be either Internet Protocol version 4 (IPv4) or version 6 (IPv6).

For IPv6 addresses, AsyncOS supports the following formats:

- `2620:101:2004:4202::0-2620:101:2004:4202::ff`
- `2620:101:2004:4202::`
- `2620:101:2004:4202::23`
- `2620:101:2004:4202::/64`

You can also specify a special destination host of `/dev/null` to drop the messages that match the entry. (So, in effect, specifying `/dev/null` for the default route will ensure that no mail received by the appliance is ever delivered.)

A receiving domain can have multiple destination hosts, each assigned a priority number, much like an MX record. The destination host with the lowest number identifies as the primary destination host for the receiving domain. Other destination hosts listed will be used as backup.

Destinations with identical priority will be used in a “round-robin” fashion. The round-robin process is based on SMTP connections, and is not necessarily message-based. Also, if one or more of the destination hosts are not responding, messages will be delivered to one of the reachable hosts. If all the configured destination hosts are not responding, mail is queued for the receiving domain and delivery to the destination hosts is attempted later. (It does not fail over to using MX records).

When constructing routes using the `smtproutes` command in the CLI, you can prioritize each destination host by using `/pri=`, followed by an integer between 0 and 65535 to assign priority (0 is the highest priority) after the hostname or IP address. For example, `host1.example.com/pri=0` has a higher priority than `host2.example.com/pri=10`. Separate multiple entries with commas.

SMTP Routes Limits

You can define up to 40,000 routes. The final default route of ALL is counted as a route against this limit. Therefore, you can define up to 39,999 custom routes and one route that uses the special keyword ALL.

SMTP Routes and DNS

Use the special keyword `USEDNS` to tell the appliance to do MX lookups to determine next hops for specific domains. This is useful when you need to route mail for subdomains to a specific host. For example, if mail to `example.com` is to be sent to the company’s Exchange server, you might have something similar to the following SMTP route:

```
example.com exchange.example.com
```

However, for mail to various subdomains (`foo.example.com`), add an SMTP route that looks like this:

```
.example.com USEDNS
```

SMTP Routes and Alerts

Alerts sent from the appliance to addresses specified in the System Administration > Alerts page (or the alertconfig command) follow SMTP Routes defined for those destinations.

SMTP Routes, Mail Delivery, and Message Splintering

Incoming: if one message has 10 recipients and they are all on the same Exchange server, AsyncOS will open one TCP connection and present exactly one message to the mail store, not 10 separate messages.

Outgoing: works similarly, but if one message is going to 10 recipients in 10 different domains, AsyncOS will open 10 connections to 10 MTAs and deliver them one email each.

Splintering: if one incoming message has 10 recipients and they are each in separate Incoming Policy groups (10 groups), the message will splinter even if all 10 recipients are on the same Exchange server. Thus, 10 separate emails will be delivered over a single TCP connection.

SMTP Routes and Outbound SMTP Authentication

If an Outbound SMTP Authentication profile has been created, you can apply it to an SMTP Route. This allows authentication for outgoing mail in cases where the appliance sits behind a mail relay server that is at the edge of the network. For more information about Outbound SMTP Authentication, see [Outgoing SMTP Authentication, on page 785](#).

Managing SMTP Routes to Send Outbound Email Using the GUI

Use the Network > SMTP Routes page to manage SMTP Routes on your appliance. You can add, modify, and delete mappings in the table. You can export or import the SMTP Routes entries.

Related Topics

- [Adding SMTP Routes, on page 674](#)
- [Exporting SMTP Routes, on page 675](#)
- [Importing SMTP Routes, on page 675](#)

Adding SMTP Routes

Procedure

-
- Step 1** Click **Add Route** on the Network > SMTP Routes page.
- Step 2** Enter a receiving domain. This can be a hostname, domain, IPv4 address, or IPv6 address.
- Step 3** Enter a destination host. This can be a hostname, IPv4 address, or IPv6 address. You can add multiple destination hosts by clicking **Add Row** and entering the next destination host in the new row.
- Note** You can specify a port number by adding “:<port number>” to the destination host: example.com:25.
- Step 4** If you add multiple destination hosts, enter an integer between 0 and 65535 to assign priority to the hosts. 0 is the highest priority. See [Defining an SMTP Route, on page 673](#) for more information.

- Step 5** Submit and commit your changes.
-

Exporting SMTP Routes

Similar to the Host Access Table (HAT) and the Recipient Access Table (RAT), you can also modify SMTP routes mappings by exporting and importing a file. To export the SMTP Routes:

Procedure

- Step 1** Click **Export SMTP Routes** on the SMTP Routes page.
- Step 2** Enter a name for the file and click **Submit**.
-

Importing SMTP Routes

Similar to the Host Access Table (HAT) and the Recipient Access Table (RAT), you can also modify SMTP routes mappings by exporting and importing a file. To import SMTP Routes:

Procedure

- Step 1** Click **Import SMTP Routes** on the SMTP Routes page.
- Step 2** Select the file that contains the exported SMTP Routes.
- Step 3** Click **Submit**. You are warned that importing will replace all existing SMTP Routes. All of the SMTP Routes in the text file are imported.
- Step 4** Click **Import**.

You can place “comments” in the file. Lines that begin with a ‘#’ character are considered comments and are ignored by AsyncOS. For example:

```
# this is a comment, but the next line is not  
ALL:
```

What to do next

At this point, our Email Gateway configuration looks like this:

Figure 46: SMTP Routes Defined for a Public Listener

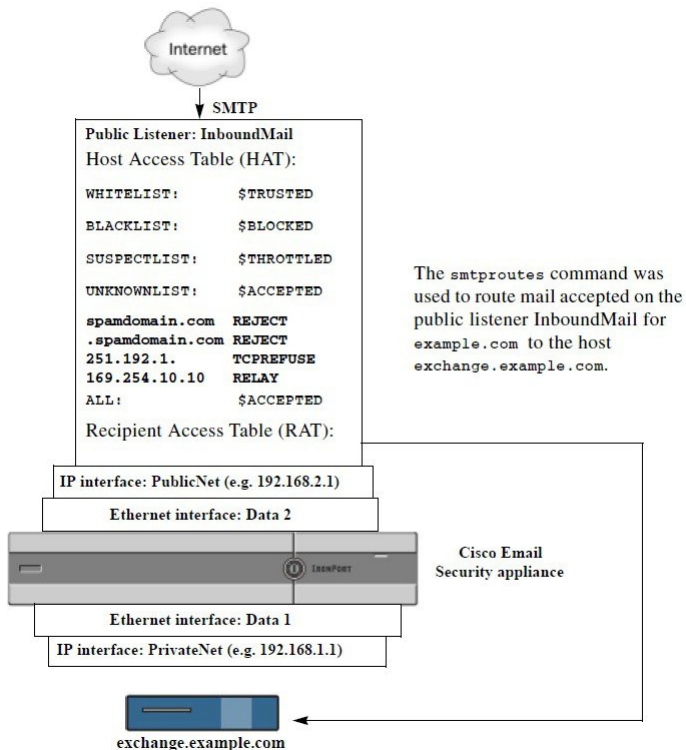

Rewriting Addresses

AsyncOS provides several methods for rewriting Envelope Sender and Recipient addresses in the email pipeline. Rewriting addresses can be used, for example, to redirect mail sent to a partner domain or to hide (“mask”) your internal infrastructure.

The following table provides an overview of the various features used for rewriting sender and recipient email addresses.

Table 54: Methods for Rewriting Addresses

Original Address	Change to	Feature	Works on
*@anydomain	user@domain	Alias Tables (see Creating Alias Tables, on page 677)	<ul style="list-style-type: none"> • Envelope Recipients only • Applied globally • Maps aliases to email addresses or other aliases
*@olddomain	*@newdomain	Domain Mapping (see The Domain Map Feature, on page 694)	<ul style="list-style-type: none"> • Envelope Recipients only • Applied per listener

Original Address	Change to	Feature	Works on
*@olddomain	*@newdomain	Masquerading (see Configuring Masquerading, on page 684)	<ul style="list-style-type: none"> Envelope Sender and the To:, From:, and/or CC: headers Applied per listener

Creating Alias Tables

Alias tables provide a mechanism to redirect messages to one or more recipients. You can construct a mapping table of aliases to usernames and other aliases in a similar fashion to the `/etc/mail/aliases` feature of a sendmail configuration on some Unix systems.

When the Envelope Recipient (also known as the Envelope To, or `RCPT TO`) of an email accepted by a listener matches an alias as defined in an alias table, the Envelope Recipient address of the email will be rewritten.



Note A listener checks the alias table and modifies the recipients *after* checking the RAT and *before* message filters. See the “Understanding the Email Pipeline” chapter.



Note The Alias Table functionality actually rewrites the Envelope Recipient of the email. This is different than the `smtproutes` command (see [Directing Bounced Email, on page 700](#)), which does not rewrite the Envelope Recipient of the email, but instead simply reroutes the email to specified domains.

Related Topics

- [Configuring an Alias Table from the Command Line, on page 677](#)
- [Exporting and Importing an Alias Table, on page 678](#)
- [Deleting Entries from the Alias Table, on page 679](#)

Configuring an Alias Table from the Command Line

Alias tables are defined in sections as follows: each section is headed by a domain context, which is a list of domains that the section is relevant to, followed by a list of maps.

A domain context is a list of one or more domains or partial domains, separated by commas and enclosed in square brackets ('[' and ']'). A domain is a string containing letters, digits hyphens, and periods as defined in RFC 1035, section 2.3.1., “Preferred name syntax.” A partial domain, such as `.example.com` is a domain that begins with a period. All domains that end with a substring matching the partial domain are considered a match. For example, the domain context `.example.com` would match `mars.example.com` and `venus.example.com`. Below the domain context is a list of maps, which are aliases followed by a list of recipients. A map is constructed as follows:

Table 55: Alias Table Syntax

Left-hand Side (LHS)	Separator	Right-hand Side (RHS)
a list of one or more aliases to match	the colon character (“ : ”)	a list of one or more recipient addresses or aliases

An alias in the **left-hand side** can contain the following formats:

<code>username</code>	Specifies an alias to match. There must be a preceding “domains” attribute specified in the table. The lack of this parameter will produce an error.
<code>user@domain</code>	Specifies an exact email address to match on.

You can enter multiple aliases, separated by commas on a single left-hand side line.

Each recipient in the **right-hand side** can be a full `user@domain` email address, or another alias.

An alias file can contain “global” aliases (aliases that are applied globally instead of to a specific domain) with no implied domain, domain contexts within which aliases have one or more implied domains, or both.

“Chains” (or recursive entries) of aliases may be created, but they must end in a full email address.

A special destination of `/dev/null` is supported to drop the message in order to be compatible with context of a sendmail configuration. If a message is mapped to `/dev/null` via an alias table, the dropped counter is increased. (See the “Managing and Monitoring via the CLI” chapter.) The recipient is accepted but not enqueued.

Related Topics

- [Example Alias Table, on page 679](#)
- [Example aliasconfig Command, on page 681](#)

Exporting and Importing an Alias Table

To import an alias table, first see [FTP, SSH, and SCP Access, on page 1261](#) to ensure that you can access the appliance .

Use the `export` subcommand of the `aliasconfig` command to save any existing alias table. A file (whose name you specify) will be written to the `/configuration` directory for the listener. You can modify this file outside of the CLI and then re-import it. (If you have malformed entries in the file, errors are printed when you try to import the file.)

Place the alias table file in the `/configuration` directory, and then use the `import` subcommand of the `aliasconfig` command to upload the file.

Comment out lines in the table using a number symbol (`#`) at the beginning of each line.

Remember to issue the `commit` command after you import an alias table file so that the configuration changes take effect.

Deleting Entries from the Alias Table

If you delete entries from the alias table from the command line interface (CLI), you are prompted to choose a domain group first. Choose the “ALL (any domain)” entry to see a numbered list of aliases that apply to all domains. Then choose the number(s) of the aliases you want to delete.

Example Alias Table



Note All entries in this example table have been commented out.

```
# sample Alias Table file

# copyright (c) 2001-2005, IronPort Systems, Inc.

#

# Incoming Envelope To addresses are evaluated against each
# entry in this file from top to bottom. The first entry that
# matches will be used, and the Envelope To will be rewritten.

#

# Separate multiple entries with commas.

#

# Global aliases should appear before the first domain
# context. For example:

#

# admin@example.com: administrator@example.com
# postmaster@example.net: administrator@example.net

#

# This alias has no implied domain because it appears
# before a domain context:

#

# someaddr@somewhere.dom: specificperson@here.dom

#

# The following aliases apply to recipients @ironport.com and
# any subdomain within .example.com because the domain context
# is specified.

#

# Email to joe@ironport.com or joe@foo.example.com will
```

```
# be delivered to joseph@example.com.
#
# Similarly, email to fred@mx.example.com will be
# delivered to joseph@example.com
#
# [ironport.com, .example.com]
#
# joe, fred: joseph@example.com
#
# In this example, email to partygoers will be sent to
# three addresses:
#
# partygoers: wilma@example.com, fred@example.com, barney@example.com
#
# In this example, mail to help@example.com will be delivered to
# customercare@otherhost.dom. Note that mail to help@ironport.com will
# NOT be processed by the alias table because the domain context
# overrides the previous domain context.
#
# [example.com]
#
# help: customercare@otherhost.dom
#
# In this example, mail to nobody@example.com is dropped.
#
# nobody@example.com: /dev/null
#
# "Chains" may be created, but they must end in an email address.
# For example, email to "all" will be sent to 9 addresses:
#
# [example.com]
#
```

```
# all: sales, marketing, engineering
# sales: joe@example.com, fred@example.com, mary@example.com
# marketing:bob@example.com, advertising
# engineering:betty@example.com, miles@example.com, chris@example.com
# advertising:richard@example.com, karen@advertising.com
```

Example aliasconfig Command

In this example, the `aliasconfig` command is used to construct an alias table. First, the domain context of **example.com** is specified. Then, an alias of **customercare** is constructed so that any email sent to `customercare@example.com` is redirected to `bob@example.com`, `frank@example.com`, and `sally@example.com`. Next, a global alias of **admin** is constructed so that an email sent to `admin` is redirected to `administrator@example.com`. Finally, the alias table is printed to confirm.

Note that when the table is printed, the global alias for `admin` appears *before* the first domain context of `example.com`.

```
mail3.example.com> aliasconfig

No aliases in table.

Choose the operation you want to perform:

- NEW - Create a new entry.
- IMPORT - Import aliases from a file.

[ ]> new

How do you want your aliases to apply?

1. Globally
2. Add a new domain context

[1]> 2

Enter new domain context.

Separate multiple domains with commas.

Partial domains such as .example.com are allowed.

[ ]> example.com

Enter the alias(es) to match on.

Separate multiple aliases with commas.

Allowed aliases:

- "user" - This user in this domain context.
- "user@domain" - This email address.
```

```
[ ]> customercare

Enter address(es) for "customercare".

Separate multiple addresses with commas.

[ ]> bob@example.com, frank@example.com, sally@example.com

Adding alias customercare: bob@example.com,frank@example.com,sally@example.com

Do you want to add another alias? [N]> n

There are currently 1 mappings defined.

Choose the operation you want to perform:

- NEW - Create a new entry.
- EDIT - Modify an entry.
- DELETE - Remove an entry.
- PRINT - Display the table.
- IMPORT - Import aliases from a file.
- EXPORT - Export table to a file.
- CLEAR - Clear the table.

[ ]> new

How do you want your aliases to apply?

1. Globally
2. Add a new domain context
3. example.com

[1]> 1

Enter the alias(es) to match on.

Separate multiple aliases with commas.

Allowed aliases:

- "user@domain" - This email address.
- "user" - This user for any domain
- "@domain" - All users in this domain.
- "@.partialdomain" - All users in this domain, or any of its sub domains.

[ ]> admin

Enter address(es) for "admin".

Separate multiple addresses with commas.
```



```
[ ]> administrator@example.com
Adding alias admin: administrator@example.com
Do you want to add another alias? [N]> n

There are currently 2 mappings defined.
Choose the operation you want to perform:
- NEW - Create a new entry.
- EDIT - Modify an entry.
- DELETE - Remove an entry.
- PRINT - Display the table.
- IMPORT - Import aliases from a file.
- EXPORT - Export table to a file.
- CLEAR - Clear the table.

[ ]> print
admin: administrator@example.com
[ example.com ]
customercare: bob@example.com, frank@example.com, sally@example.com

There are currently 2 mappings defined.
Choose the operation you want to perform:
- NEW - Create a new entry.
- EDIT - Modify an entry.
- DELETE - Remove an entry.
- PRINT - Display the table.
- IMPORT - Import aliases from a file.
- EXPORT - Export table to a file.
- CLEAR - Clear the table.

[ ]>
```

At this point, our Email Gateway configuration looks like this:

Figure 47: Alias Tables Defined for the Appliance

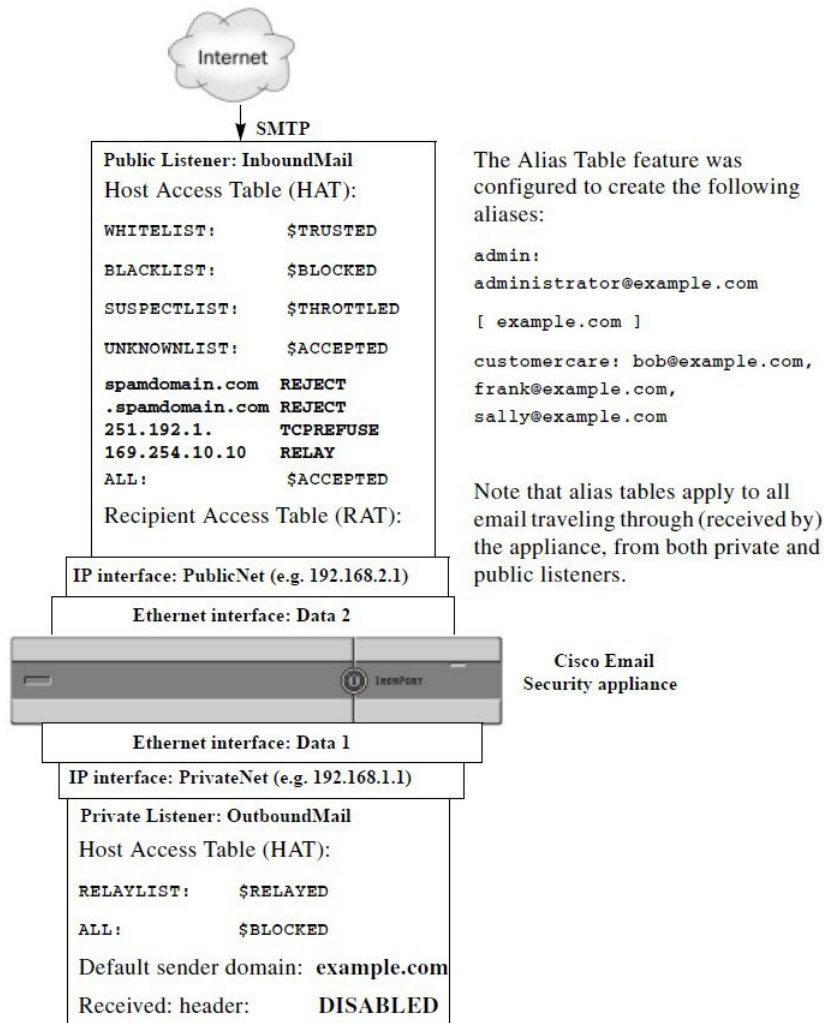

The Alias Table feature was configured to create the following aliases:

```

admin:
administrator@example.com
[ example.com ]
customercare: bob@example.com,
frank@example.com,
sally@example.com
    
```

Note that alias tables apply to all email traveling through (received by) the appliance, from both private and public listeners.

Cisco Email Security appliance

Configuring Masquerading

Masquerading is a feature that rewrites the Envelope Sender (also known as the sender, or MAIL FROM) and the To:, From:, and/or CC: headers on email processed by a listener according to a table that you construct. A typical example implementation of this feature is “Virtual Domains,” which allows you to host multiple domains from a single site. Another typical implementation is “hiding” your network infrastructure by “stripping” the subdomains from strings in email headers. The Masquerading feature is available for both private and public listeners.



Note The Masquerading feature is configured on a per-listener basis, as opposed to the Alias Tables functionality, which is configured for the entire system.

A listener checks the masquerading table for matches and modifies the recipients while the message is in the work queue, immediately after LDAP recipient acceptance queries and before LDAP routing queries. See the “Understanding the Email Pipeline” chapter.

The Masquerading feature actually rewrites addresses for the Envelope Sender and the To:, From:, and CC: fields of the email that has been received. You can specify different masquerading parameters for each listener you create in one of two ways:

- via a static table of mappings you create
- via an LDAP query.

This section discusses the static table method. The table format is forward-compatible with the `/etc/mail/genericstable` feature of a sendmail configuration on some Unix systems. See [LDAP Queries, on page 749](#) for more information on LDAP masquerading queries.

Related Topics

- [Masquerading and altsrghost, on page 685](#)

Masquerading and altsrghost

Generally, the masquerading feature rewrites the Envelope Sender, and any subsequent actions to be performed on the message will be “triggered” from the masqueraded address. However, when you run the `altsrghost` command from the CLI, the `altsrghost` mappings are triggered from the original address (and not the modified, masqueraded address).

For more information, see [Configuring Mail Gateways for all Hosted Domains Using Virtual Gateway™ Technology, on page 723](#) and [Review: Email Pipeline, on page 734](#).

Related Topics

- [Configuring Static Masquerading Tables, on page 685](#)
- [Sample Masquerading Table for a Private Listener, on page 686](#)
- [Importing a Masquerading Table , on page 687](#)
- [Example Masquerading , on page 687](#)

Configuring Static Masquerading Tables

You configure the static masquerading table of mappings by using the `edit -> masquerade` subcommand of the `listenerconfig` command. Alternatively, you can import a file containing the mappings. See [Importing a Masquerading Table , on page 687](#). The subcommand creates and maintains a table that maps input addresses, usernames, and domains to new addresses and domains. See [LDAP Queries, on page 749](#) for more information on LDAP masquerading queries.

When messages are injected into the system, the table is consulted, and the message is rewritten if a match in the header is found.

A domain masquerading table is constructed as follows:

Table 56: Masquerading Table Syntax

Left-hand Side (LHS)	Separator	Right-hand Side (RHS)
a list of one or more usernames and/or domains to match	whitespace (space or tab character)	the rewritten username and/or domain

The following table lists valid entries in the masquerading table:

Left-hand Side (LHS)	Right-hand Side (RHS)
username	username@domain
This entry specifies a username to match. Incoming email messages matching a username on the left-hand side are matched and rewritten with the address on the right-hand side. The right-hand side must be a full address.	
user@domain	username@domain
The entry specifies an exact address to match. Incoming messages matching a full address on the left-hand side are rewritten with the address listed on the right-hand side. The right-hand side must be a full address.	
@domain	@domain
This entry specifies any address with the specified domain. The original domain on the left-hand side is replaced with the domain in the right-hand side, leaving the username intact.	
@.partialdomain	@domain
This entry specifies any address with the specified domain. The original domain on the left-hand side is replaced with the domain in the right-hand side, leaving the username intact.	
ALL	@domain
The ALL entry matches bare addresses and rewrites them with the address on the right-hand side. The right-hand side must be a domain preceded by an “@”. This entry always has the lowest precedence regardless of its location in the table.	
Note	You can use the ALL entry for private listeners only.

- Rules are matched by the order in which they appear in the masquerading table.
- Addresses in the From:, To:, and CC: fields in the headers are matched and rewritten upon receiving by default. You can also configure the option to match and rewrite the Envelope Sender. Enable and disable the Envelope Sender and which headers to rewrite using the config subcommand.
- You can comment out lines in the table using a number symbol (#) at the beginning of each line. Everything following a # to the end of the line will be considered a comment and ignored.
- A masquerading table is limited to 400,000 entries, whether you create them via the new subcommand or import them from a file.

Sample Masquerading Table for a Private Listener

```
# sample Masquerading file

@example.com @example.com # Hides local subdomains in the header
```

```

sales sales_team@success.com

@techsupport tech_support@biggie.com

user@localdomain user@company.com

ALL @bigsender.com

```

Importing a Masquerading Table

A traditional `sendmail /etc/mail/genericstable` file can be imported. To import a `genericstable` file, first see [FTP, SSH, and SCP Access, on page 1261](#) to ensure that you can access the appliance .

Place the `genericstable` file in the configuration directory, and then use the `import` subcommand of the `masquerade` subcommand to upload the file. Use the commands in this order:

```
listenerconfig -> edit -> listener_number -> masquerade -> import
```

Alternatively, you can use the `export` subcommand to download the existing configuration. A file (whose name you specify) will be written to the configuration directory. You can modify this file outside of the CLI and then import it again.

When you use the `import` subcommand, ensure that the file contains only valid entries. If there is an invalid entry (for example, a left-hand side with no right-hand side), the CLI reports syntax errors when you import the file. If there is a syntax error during import, no mappings in the entire file are imported.

Remember to issue the `commit` command after you import a `genericstable` file so that the configuration changes for the listener take effect.

Example Masquerading

In this example, the `masquerade` subcommand of `listenerconfig` is used to construct a domain masquerading table for the private listener named “OutboundMail” on the PrivateNet interface.

First, the option to use LDAP for masquerading is declined. (For information on configuring LDAP masquerading queries, see [LDAP Queries, on page 749](#) for more information on LDAP masquerading queries.)

Then, a partial domain notation of `@.example.com` is mapped to `@example.com` so that any email sent from any machine in the subdomain of `.example.com` will be mapped to `example.com` . Then, the username `joe` is mapped to the domain `joe@example.com`. The domain masquerading table is then printed to confirm both entries, and then exported to a file named `masquerade.txt` . The `config` subcommand is used to disable re-writing addresses in the CC: field, and finally, the changes are committed.

```

mail3.example.com> listenerconfig

Currently configured listeners:

1. InboundMail (on PublicNet, 192.168.2.1) SMTP TCP Port 25 Public
2. OutboundMail (on PrivateNet, 192.168.1.1) SMTP TCP Port 25 Private

Choose the operation you want to perform:

- NEW - Create a new listener.
- EDIT - Modify a listener.
- DELETE - Remove a listener.
- SETUP - Change global settings.

```

```
[ ]> edit

Enter the name or number of the listener you wish to edit.

[ ]> 2

Name: OutboundMail

Type: Private

Interface: PrivateNet (192.168.1.1/24) TCP Port 25

Protocol: SMTP

Default Domain:

Max Concurrency: 600 (TCP Queue: 50)

Domain Map: Disabled

TLS: No

SMTP Authentication: Disabled

Bounce Profile: Default

Footer: None

LDAP: Off

Choose the operation you want to perform:

- NAME - Change the name of the listener.

- INTERFACE - Change the interface.

- LIMITS - Change the injection limits.

- SETUP - Configure general options.

- HOSTACCESS - Modify the Host Access Table.

- BOUNCECONFIG - Choose the bounce profile to use for messages injected on this
listener.

- MASQUERADE - Configure the Domain Masquerading Table.

- DOMAINMAP - Configure domain mappings.

- LDAPACCEPT - Configure an LDAP query to determine whether a recipient address should
be accepted or bounced/dropped.

- LDAPROUTING - Configure an LDAP query to reroute messages.

- LDAPGROUP - Configure an LDAP query to determine whether a sender or
recipient is in a specified group.

- SMTPAUTH - Configure an SMTP authentication.

[ ]> masquerade

Do you want to use LDAP for masquerading? [N]> n
```

```
Domain Masquerading Table
```

```
There are currently 0 entries.
```

```
Masqueraded headers: To, From, Cc
```

```
Choose the operation you want to perform:
```

- NEW - Create a new entry.
- DELETE - Remove an entry.
- PRINT - Display all entries.
- IMPORT - Import all entries from a file.
- EXPORT - Export all entries to a file.
- CONFIG - Configure masqueraded headers.
- CLEAR - Remove all entries.

```
[> new
```

```
Enter the source address or domain to masquerade.
```

```
Usernames like "joe" are allowed.
```

```
Full addresses like "user@example.com" are allowed.
```

```
Full addresses with subdomain wildcards such as "username@.company.com" are allowed.
```

```
Domains like @example.com and @.example.com are allowed.
```

```
Hosts like @training and @.sales are allowed.
```

```
[> @.example.com
```

```
Enter the masqueraded address or domain.
```

```
Domains like @example.com are allowed.
```

```
Full addresses such as user@example.com are allowed.
```

```
[> @example.com
```

```
Entry mapping @.example.com to @example.com created.
```

```
Domain Masquerading Table
```

```
There are currently 1 entries.
```

```
Masqueraded headers: To, From, Cc
```

```
Choose the operation you want to perform:
```

- NEW - Create a new entry.
- DELETE - Remove an entry.
- PRINT - Display all entries.

- IMPORT - Import all entries from a file.
- EXPORT - Export all entries to a file.
- CONFIG - Configure masqueraded headers.
- CLEAR - Remove all entries.

```
[> new
```

Enter the source address or domain to masquerade.

Username like "joe" are allowed.

Full addresses like "user@example.com" are allowed.

Full addresses with subdomain wildcards such as "username@.company.com" are allowed.

Domains like @example.com and @.example.com are allowed.

Hosts like @training and @.sales are allowed.

```
[> joe
```

Enter the masqueraded address.

Only full addresses such as user@example.com are allowed.

```
[> joe@example.com
```

Entry mapping joe to joe@example.com created.

Domain Masquerading Table

There are currently 2 entries.

Masqueraded headers: To, From, Cc

Choose the operation you want to perform:

- NEW - Create a new entry.
- DELETE - Remove an entry.
- PRINT - Display all entries.
- IMPORT - Import all entries from a file.
- EXPORT - Export all entries to a file.
- CONFIG - Configure masqueraded headers.
- CLEAR - Remove all entries.

```
[> print
```

```
@.example.com @example.com
```

```
joe joe@example.com
```

Domain Masquerading Table

```
There are currently 2 entries.
Masqueraded headers: To, From, Cc
Choose the operation you want to perform:
- NEW - Create a new entry.
- DELETE - Remove an entry.
- PRINT - Display all entries.
- IMPORT - Import all entries from a file.
- EXPORT - Export all entries to a file.
- CONFIG - Configure masqueraded headers.
- CLEAR - Remove all entries.

[ ]> export

Enter a name for the exported file:
[ ]> masquerade.txt

Export completed.

Domain Masquerading Table

There are currently 2 entries.
Masqueraded headers: To, From, Cc
Choose the operation you want to perform:
- NEW - Create a new entry.
- DELETE - Remove an entry.
- PRINT - Display all entries.
- IMPORT - Import all entries from a file.
- EXPORT - Export all entries to a file.
- CONFIG - Configure masqueraded headers.
- CLEAR - Remove all entries.

[ ]> config

Do you wish to masquerade Envelope Sender?
[N ]> y

Do you wish to masquerade From headers?
[Y ]> y

Do you wish to masquerade To headers?
[Y ]> y
```

```
Do you wish to masquerade CC headers?
[Y]> n
Do you wish to masquerade Reply-To headers?
[Y]> n
Domain Masquerading Table
There are currently 2 entries.
- NEW - Create a new entry.
- DELETE - Remove an entry.
- PRINT - Display all entries.
- IMPORT - Import all entries from a file.
- EXPORT - Export all entries to a file.
- CONFIG - Configure masqueraded headers.
- CLEAR - Remove all entries.
[]>
Name: OutboundMail
Type: Private
Interface: PrivateNet (192.168.1.1/24) TCP Port 25
Protocol: SMTP
Default Domain:
Max Concurrency: 600 (TCP Queue: 50)
Domain Map: Disabled
TLS: No
SMTP Authentication: Disabled
Bounce Profile: Default
Footer: None
LDAP: Off
Choose the operation you want to perform:
- NAME - Change the name of the listener.
- INTERFACE - Change the interface.
- LIMITS - Change the injection limits.
- SETUP - Configure general options.
- HOSTACCESS - Modify the Host Access Table.
```

- BOUNCECONFIG - Choose the bounce profile to use for messages injected on this listener.
- MASQUERADE - Configure the Domain Masquerading Table.
- DOMAINMAP - Configure domain mappings.
- LDAPACCEPT - Configure an LDAP query to determine whether a recipient address should be accepted or bounced/dropped.
- LDAPROUTING - Configure an LDAP query to reroute messages.
- LDAPGROUP - Configure an LDAP query to determine whether a sender or recipient is in a specified group.
- SMTPAUTH - Configure an SMTP authentication.

[]>

Currently configured listeners:

1. InboundMail (on PublicNet, 192.168.2.1) SMTP TCP Port 25 Public
2. OutboundMail (on PrivateNet, 192.168.1.1) SMTP TCP Port 25 Private

Choose the operation you want to perform:

- NEW - Create a new listener.
- EDIT - Modify a listener.
- DELETE - Remove a listener.
- SETUP - Change global settings.

[]>

Our Enterprise Gateway configuration now looks like this:

Figure 48: Masquerading Defined for a Private Listener

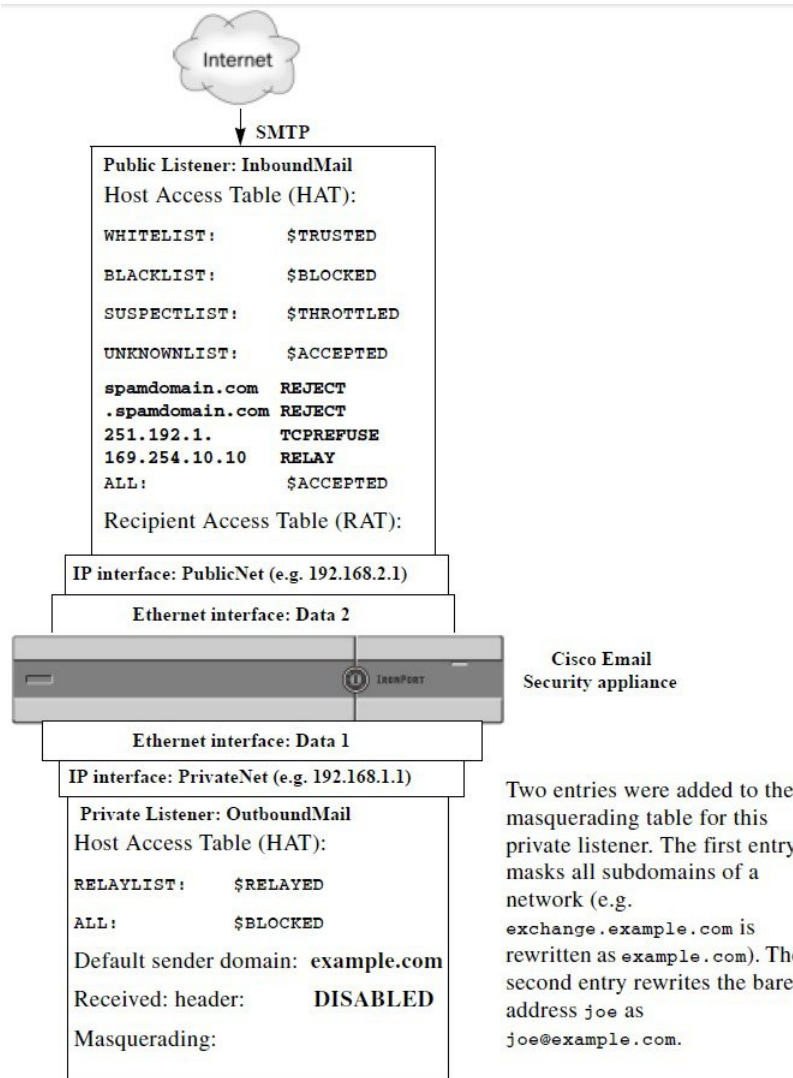

The Domain Map Feature

You can configure a “domain map” for listeners. For each listener you configure, you can construct a domain map table which rewrites the Envelope Recipient for each recipient in a message that matches a domain in the domain map table. This feature is similar to the sendmail “Domain Table” or Postfix “Virtual Table” feature. Only the Envelope Recipient is affected; the “To:” headers are not re-written by this feature.



Note The processing of the domain map feature happens immediately before the RAT and right after Default Domain is evaluated. See the “Understanding the Email Pipeline” chapter.

A common implementation of the domain map feature is to accept incoming mail for more than one legacy domain. For example, if your company has acquired another company, you could construct a domain map on the appliance to accept messages for the acquired domain and rewrite the Envelope Recipients to your company’s current domain.



Note You can configure up to 20,000 separate, unique domain mappings.

Table 57: Domain Map Table Example Syntax

Left Side	Right Side	Comments
username@example.com	username2@example.net	Only complete address for the right side
user@.example.com	user2@example.net	
@example.com	user@example.net <i>or</i> @example.net	Complete address or fully-qualified domain name.
@.example.com	user@example.net <i>or</i> @example.net	

In the following example, the `domainmap` subcommand of the `listenerconfig` command is used to create a domain map for the public listener “InboundMail.” Mail for the domain and any subdomain of `oldcompanyname.com` is mapped to the domain `example.com`. The mapping is then printed for confirmation. Contrast this example with the configuration of placing both domains in the listener’s RAT: the domain map feature will actually rewrite the Envelope Recipient of `joe@oldcomapanynname.com` to `joe@example.com`, whereas placing the domain `oldcompanyname.com` in the listener’s RAT will simply accept the message for `joe@oldcompanyname.com` and route it without rewriting the Envelope Recipient. Also, contrast this example with the alias table feature. Alias tables *must* resolve to an explicit address; they cannot be constructed to map “*any username @domain*” to “*the same username @newdomain.*”

```
mail3.example.com> listenerconfig

Currently configured listeners:

1. Inboundmail (on PublicNet, 192.168.2.1) SMTP TCP Port 25 Public
2. Outboundmail (on PrivateNet, 192.168.1.1) SMTP TCP Port 25 Private

Choose the operation you want to perform:

- NEW - Create a new listener.
- EDIT - Modify a listener.
- DELETE - Remove a listener.
- SETUP - Change global settings.
```

```
[ ]> edit

Enter the name or number of the listener you wish to edit.

[ ]> 1

Name: InboundMail
Type: Public
Interface: PublicNet (192.168.2.1/24) TCP Port 25
Protocol: SMTP
Default Domain:
Max Concurrency: 1000 (TCP Queue: 50)
Domain Map: Disabled
TLS: No
SMTP Authentication: Disabled
Bounce Profile: Default
Use SenderBase For Reputation Filters and IP Profiling: Yes
Footer: None
LDAP: Off

Choose the operation you want to perform:

- NAME - Change the name of the listener.
- INTERFACE - Change the interface.
- LIMITS - Change the injection limits.
- SETUP - Configure general options.
- HOSTACCESS - Modify the Host Access Table.
- RCPTACCESS - Modify the Recipient Access Table.
- BOUNCECONFIG - Choose the bounce profile to use for messages injected on this
listener.
- MASQUERADE - Configure the Domain Masquerading Table.
- DOMAINMAP - Configure domain mappings.

[ ]> domainmap

Domain Map Table

There are currently 0 Domain Mappings.

Domain Mapping is: disabled

Choose the operation you want to perform:

- NEW - Create a new entry.
```

```
- IMPORT - Import domain mappings from a file.

[]> new

Enter the original domain for this entry.
Domains such as "@example.com" are allowed.
Partial hostnames such as "@.example.com" are allowed.
Email addresses such as "test@example.com" and "test@.example.com"
are also allowed.

[]> @.oldcompanyname.com

Enter the new domain for this entry.
The new domain may be a fully qualified
such as "@example.domain.com" or a complete
email address such as "test@example.com"

[]> @example.com

Domain Map Table

There are currently 1 Domain Mappings.

Domain Mapping is: enabled

Choose the operation you want to perform:

- NEW - Create a new entry.
- EDIT - Modify an entry.
- DELETE - Remove an entry.
- PRINT - Display all domain mappings.
- IMPORT - Import domain mappings from a file.
- EXPORT - Export domain mappings to a file.
- CLEAR - Clear all domain mappings.

[]> print

@.oldcompanyname.com --> @example.com

Domain Map Table

There are currently 1 Domain Mappings.

Domain Mapping is: enabled

Choose the operation you want to perform:

- NEW - Create a new entry.
```

```
- EDIT - Modify an entry.
- DELETE - Remove an entry.
- PRINT - Display all domain mappings.
- IMPORT - Import domain mappings from a file.
- EXPORT - Export domain mappings to a file.
- CLEAR - Clear all domain mappings.

[]>

Name: InboundMail

Type: Public

Interface: PublicNet (192.168.2.1/24) TCP Port 25

Protocol: SMTP

Default Domain:

Max Concurrency: 1000 (TCP Queue: 50)

Domain Map: Enabled

TLS: No

SMTP Authentication: Disabled

Bounce Profile: Default

Use SenderBase For Reputation Filters and IP Profiling: Yes

Footer: None

LDAP: Off

Choose the operation you want to perform:

- NAME - Change the name of the listener.
- INTERFACE - Change the interface.
- LIMITS - Change the injection limits.
- SETUP - Configure general options.
- HOSTACCESS - Modify the Host Access Table.
- RCPTACCESS - Modify the Recipient Access Table.
- BOUNCECONFIG - Choose the bounce profile to use for messages injected on this
listener.
- MASQUERADE - Configure the Domain Masquerading Table.
- DOMAINMAP - Configure domain mappings.

[]>
```

Related Topics

- [Importing and Exporting a Domain Map Table](#) , on page 699

Importing and Exporting a Domain Map Table

To import or export a domain map table, first see [FTP, SSH, and SCP Access, on page 1261](#) to ensure that you can access the appliance .

Create a text file of entries of domains to map. Separate the entries with white space (either a tab character or spaces). Comment out lines in the table using a number symbol (#) at the beginning of each line.

Place the file in the configuration directory, and then use the `import` subcommand of the `domain` subcommand to upload the file. Use the commands in this order:

```
listenerconfig -> edit -> injector_number -> domainmap -> import
```

Alternatively, you can use the `export` subcommand to download the existing configuration. A file (whose name you specify) will be written to the configuration directory. You can modify this file outside of the CLI and then import it again.

When you use the `import` subcommand, ensure that the file contains only valid entries. If there is an invalid entry (for example, a left-hand side with no right-hand side), the CLI reports syntax errors when you import the file. If there is a syntax error during import, no mappings in the entire file are imported.

Remember to issue the `commit` command after you import a domain map table file so that the configuration changes for the listener take effect.

Our Enterprise Gateway configuration now looks like this:

Figure 49: Domain Map Defined for a Public Listener

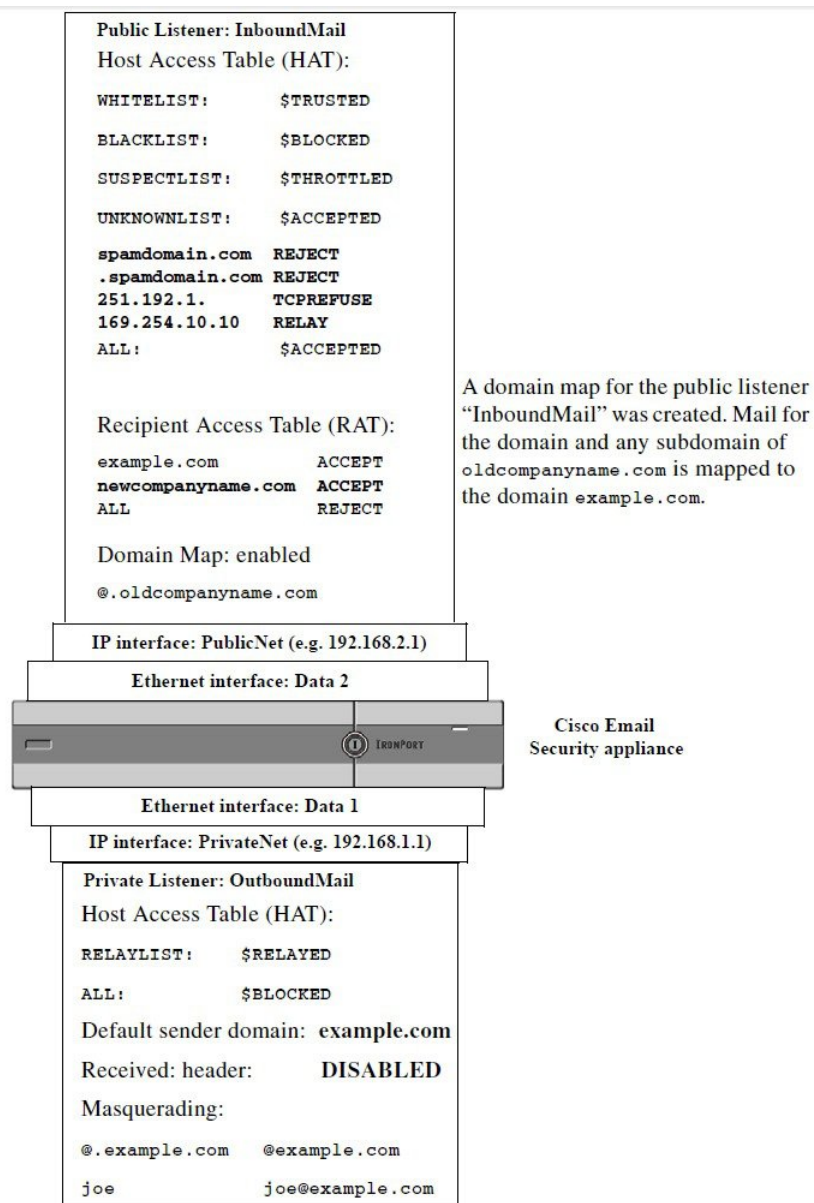

Directing Bounced Email

Bounced email is an inevitable part of any email delivery. Your appliance is able to process bounced email in a number of highly configurable ways.

Please note, this section describes how to control how your appliance generates outgoing bounces (based on incoming mail). To control how your appliance controls incoming bounces (based on outgoing mail) use Bounce Verification (see [Bounce Verification, on page 709](#)).

Related Topics

- [Handling Undeliverable Email, on page 701](#)
- [Creating a New Bounce Profile, on page 707](#)
- [Applying Bounce Profiles to Listeners, on page 707](#)

Handling Undeliverable Email

The AsyncOS operating system classifies undeliverable email, or “bounced messages,” into the following categories:

“Conversational” bounces:	
The remote domain bounces the message during the initial SMTP conversation.	
Soft bounces	A message that is temporarily undeliverable. For example, a user’s mailbox may be full. These messages can be retried at a later time. (e.g. An SMTP 4XX error code.)
Hard bounces	A message that is permanently undeliverable. For example, the user no longer exists for that domain. These messages will not be retried. (e.g. An SMTP 5XX error code.)
“Delayed” (or “Non-conversational”) bounces:	
The remote domain accepts the message for delivery, only to bounce it at a later time.	
Soft bounces	A message that is temporarily undeliverable. For example, a user’s mailbox may be full. These messages can be retried at a later time. (e.g. An SMTP 4XX error code.)
Hard bounces	A message that is permanently undeliverable. For example, the user no longer exists for that domain. These messages will not be retried. (e.g. An SMTP 5XX error code.)

You use the Bounce Profiles page on the Network menu in the GUI (or the `bounceconfig` command) to configure how AsyncOS handles hard and soft conversational bounces for each listener you create. You create bounce profiles and then apply profiles to each listener via the `Network > Listeners` page (or the `listenerconfig` command). You can also assign bounce profiles to specific messages using message filters. (See [Using Message Filters to Enforce Email Policies, on page 131](#) for more information.)

Related Topics

- [Notes on Soft and Hard Bounces, on page 701](#)
- [Bounce Profile Parameters, on page 702](#)
- [Hard Bounces and the status Command, on page 705](#)
- [Conversational Bounces and SMTP Routes Message Filter actions, on page 705](#)
- [Example Bounce Profiles, on page 705](#)
- [Delivery Status Notification Format, on page 706](#)
- [Delay Warning Messages, on page 706](#)
- [Delay Warning Messages and Hard Bounces, on page 706](#)

Notes on Soft and Hard Bounces

- For conversational soft bounces, a soft bounce event is defined as each time a recipient delivery temporarily fails. A single recipient may incur several soft bounce events. You use the Bounce Profiles page or the

bounceconfig command to configure parameters for each soft bounce event. (See [Bounce Profile Parameters, on page 702.](#))

- By default, the system generates a bounce message and sends it to the original sender for each hard bounced recipient. (The message is sent to the address defined in the Envelope Sender address of the message envelope. Envelope From is also commonly referred to as the Envelope Sender.) You can disable this feature and instead rely on log files for information about hard bounces. (See the “Logging” chapter.)
- Soft bounces become hard bounces after the maximum time in queue or the maximum number of retries, whichever comes first.

Bounce Profile Parameters

When configuring a bounce profile, the following parameters control how conversational bounces are handled per message:

Table 58: Bounce Profile Parameters

Maximum number of retries	The number of times the system should try to reconnect to the recipient host to re-deliver the soft bounced message before treating it as a hard bounced message. The default is 100 retries.
Maximum number of seconds in queue	The amount of time the system should spend trying connect to the recipient host to re-deliver the soft bounced message before treating it as a hard bounced message. The default is 259,200 seconds (72 hours).
Initial number of seconds to wait before retrying a message	The amount of time the system should wait before the first attempt to re-deliver the soft bounced message. The default is 60 seconds. Set the initial retry time to a high value to reduce the frequency of soft bounce attempts. Conversely, to increase the frequency, lower the value.
Maximum number of seconds to wait before retrying a message	The maximum amount of time the system should wait before trying to re-deliver the soft bounced message. The default is 3,600 seconds (1 hour). This is not the interval between each subsequent try; rather, it is another parameter that can be used to control the number of retries. The initial retry interval is limited on the high end by the maximum retry interval. If the calculated retry interval period exceeds the maximum retry interval then the maximum retry interval is used instead.

<p>Send Hard Bounce Messages</p>	<p>Specify whether to send bounce message for hard bounce. If this option is enabled, you can choose the format of the bounce message. By default, bounce messages use the DSN format (RFC 1894).</p> <p>You can also send customized bounce messages based on the language of the original message (subject and body). For example, you may want to send bounce messages in Chinese for messages in Chinese and bounce messages in English for all the messages in other languages.</p> <p>Under Notification Template, click Add Row and choose the message language and the template that you want to use.</p> <p>Note Make sure that you do not delete the default entry (Message Language set to Default). You can change the bounce notification template for the default entry.</p> <p>The language of a message is considered Default in the following scenarios:</p> <ul style="list-style-type: none"> • If the language of the message is different from the language selected in the other Notification Template entries. • If the language of the message is not supported by the appliance . • If the appliance is unable to detect the language of the message. • If the content (subject and body) in the message is less than 50 bytes. <p>While configuring the above example (send bounce messages in Chinese for messages in Chinese and bounce messages in English for all the messages in other languages,) the Notification Template table will look like this:</p> <table border="1" data-bbox="894 1037 1240 1115"> <thead> <tr> <th>Message Language</th> <th>Template</th> </tr> </thead> <tbody> <tr> <td>汉语繁体 [zh-cn]</td> <td>bounce_chinese</td> </tr> <tr> <td>Default</td> <td>bounce_english</td> </tr> </tbody> </table> <p>You can also choose whether to parse the DSN status field from the bounce response. If you choose “Yes,” the appliance searches the bounce response for a DSN status code (RFC 3436) and uses the code in the Status field of the delivery status notification.</p>	Message Language	Template	汉语繁体 [zh-cn]	bounce_chinese	Default	bounce_english
Message Language	Template						
汉语繁体 [zh-cn]	bounce_chinese						
Default	bounce_english						

<p>Send Delay Warning Messages</p>	<p>Specify whether to send warning message for delayed delivery. If this option is enabled, you can configure custom delay warning messages based on the language of the original message (subject and body). For example, you may want to send delay warning messages in Chinese for the messages in Chinese and delay warning messages in English for all the messages in other languages.</p> <p>Under Notification Template, click Add Row and choose the message language and the template that you want to use.</p> <p>Note Make sure that you do not delete the default entry (Message Language set to Default). You can change the bounce notification template for the default entry.</p> <p>The language of a message is considered Default in the following scenarios:</p> <ul style="list-style-type: none"> • If the language of the message is different from the language selected in the other Notification Template entries. • If the language of the message is not supported by the appliance . • If the appliance is unable to detect the language of the message. • If the content (subject and body) in the message is less than 50 bytes. <p>While configuring the above example (send delay warning messages in Chinese for the messages in Chinese and delay warning messages in English for all the messages in other languages,) the Notification Template table will look like this:</p> <table border="1" data-bbox="824 961 1235 1052"> <thead> <tr> <th>Message Language</th> <th>Template</th> </tr> </thead> <tbody> <tr> <td>汉语简体 [zh-cn]</td> <td>bounce_chinese</td> </tr> <tr> <td>Default</td> <td>bounce_english</td> </tr> </tbody> </table> <p>You can also specify the minimum interval between messages as well as the maximum number of retries to send.</p>	Message Language	Template	汉语简体 [zh-cn]	bounce_chinese	Default	bounce_english
Message Language	Template						
汉语简体 [zh-cn]	bounce_chinese						
Default	bounce_english						
<p>Specify Recipient for Bounces</p>	<p>You can bounce messages to an alternate address rather than the default of the Envelope Sender address.</p>						
<p>Use DomainKeys signing for bounce and delay messages</p>	<p>You can select a DomainKeys profile to use for signing bounce and delay messages. For information on DomainKeys, see DomainKeys and DKIM Authentication, on page 577.</p>						
<p>Global Settings</p>							
<p>Configure these settings via the Edit Global Settings link on the Bounce Profiles page or by editing the default bounce profile via the <code>bounceconfig</code> command in the CLI.</p>							
<p>Initial number of seconds to wait before retrying an unreachable host</p>	<p>The amount of time the system should wait before retrying a host that is unreachable. The default is 60 seconds.</p>						
<p>Max interval allowed between retries to an unreachable host</p>	<p>The maximum amount of time the system should wait before retrying a host that is unreachable. The default is 3,600 seconds (1 hour). When the delivery initially fails due to the host being down, it will start with the minimum number of seconds retry value, and for each subsequent retry to the downed host, will increase the duration, up to this maximum number of seconds value.</p>						

Hard Bounces and the status Command

When hard bounce message generation is enabled, the following counters in the status and status detail commands increment each time the appliance generates a hard bounce message for delivery:

Counters:	Reset	Uptime	Lifetime
Receiving			
Messages Received	0	0	0
Recipients Received	0	0	0
Gen. Bounce Recipients	0	0	0

For more information, see the “Monitoring and Managing via the CLI” chapter. When hard bounce message generation is disabled, none of these counters increments when a recipient hard bounces.



Note The Envelope Sender address of the message envelope is different than the From: in the message headers. AsyncOS can be configured to send hard bounce messages to an email address different than the Envelope Sender address.

Conversational Bounces and SMTP Routes Message Filter actions

Mappings for SMTP Routes and message filter actions are not applied to the routing of SMTP bounce messages generated by the appliance as a result of a conversational bounce. When an appliance receives a conversational bounce message, it generates an SMTP bounce message back to the Envelope Sender of the original message. In this case, the appliance is actually generating the message, so any SMTP Routes that apply to an injected message for relaying do not apply.

Example Bounce Profiles

Consider these two examples using different bounce profile parameters:

Table 59: Example 1: Bounce Profile Parameters

Parameter	Value
Max number of retries	2
Max number of seconds in queue	259,200 seconds (72 hours)
Initial number of seconds before retrying	60 seconds
Max number of seconds to wait before retrying	60 seconds

In Example 1, the first recipient delivery attempt is made at $t=0$, immediately after the message is injected into the appliance. With the default initial retry time of 60 seconds, the first retry attempt is made approximately

one minute later at $t=60$. The retry interval is calculated and it is determined to use the maximum retry interval of 60 seconds. Thus, the second retry attempt is made at approximately $t=120$. Immediately after this retry attempt, the system generates a hard bounce message for that recipient because the maximum number of retries is two.

Table 60: Example 2: Bounce Profile Parameters

Parameter	Value
Max number of retries	100
Max number of seconds in queue	100 seconds
Initial number of seconds before retrying	60 seconds
Max number of seconds to wait before retrying	120 seconds

In Example 2, the first delivery attempt is made at $t=0$ and the first retry is made at $t=60$. The system hard bounces the message immediately before the next delivery attempt (scheduled to occur at $t=120$) because it has exceeded the maximum time in queue of 100 seconds.

Delivery Status Notification Format

Bounce messages generated by the system, by default, use the Delivery Status Notification (DSN) format for both hard and soft bounces. DSN is a format defined by RFC 1894 (see <http://www.faqs.org/rfcs/rfc1894.html>) that “defines a MIME content-type that may be used by a message transfer agent (MTA) or electronic mail gateway to report the result of an attempt to deliver a message to one or more recipients.” By default, the delivery status notification includes an explanation of the delivery status and the original message if the message size is less than 10k. If the message size is greater than 10k, the delivery status notification includes the message headers only. If the message headers exceed 10k, the delivery status notification truncates the headers. If you want include messages (or message headers) that are greater than 10k in the DSN, you can use the `max_bounce_copy` parameter in the `bounceconfig` command (this parameter is only available from the CLI).

Delay Warning Messages

Time in Queue Messages (delay notification messages) generated by the system also use the DSN format. Change the default parameters by using the Bounce Profiles page on the Network menu (or the `bounceconfig` command) to edit existing or create new bounce profiles and change the default values for:

- The minimum interval between sending delay warning messages.
- The maximum number of delay warning messages to send per recipient.

Delay Warning Messages and Hard Bounces

Note that it is possible to receive both a delay warning and a hard bounce for the same message *simultaneously*, if you have set a very small durations for both the “Maximum Time in Queue” setting and the minimum interval setting for “Send Delay Warning Messages.” Cisco Systems recommends using the default values for these settings as a minimum if you choose to enable sending of delay warning messages.

Further, delay warning messages and bounce messages originated by the appliance may be delayed by as much as 15 minutes during processing.

Creating a New Bounce Profile

In the following example, a bounce profile named `bouncepr1` is created using the Bounce Profiles page. In this profile, all hard bounced messages are sent to the alternate address `bounce-mailbox@example.com`. Delay warnings messages are enabled. One warning message will be sent per recipient, and the default value of 4 hours (14400 seconds) between warning messages is accepted.

Related Topics

- [Editing the Default Bounce Profile, on page 707](#)
- [Example of a Minimalist Bounce Profile, on page 707](#)

Editing the Default Bounce Profile

You can edit any bounce profile by clicking its name in the Bounce Profiles listing. You can also edit the default bounce profile. In this example, the default profile is edited to increase the `maximum number of seconds to wait before retrying unreachable hosts` from 3600 (one hour) to 10800 (three hours):

Example of a Minimalist Bounce Profile

In the following example, a bounce profile named `minimalist` is created. In this profile, messages are not retried when they bounce (zero maximum retries), and the maximum time to wait before retrying is specified. Hard bounce messages are disabled, and soft bounce warnings are not sent.

Applying Bounce Profiles to Listeners

Once you have created a bounce profile, you can apply that profile to a listener using the **Network > Listeners** page or the `listenerconfig` command.

In the following example, the `bouncepr1` profile is applied to the `OutgoingMail` listener.

At this point, our Email Gateway configuration looks like this:

Figure 50: Applying a Bounce Profile to a Private Listener

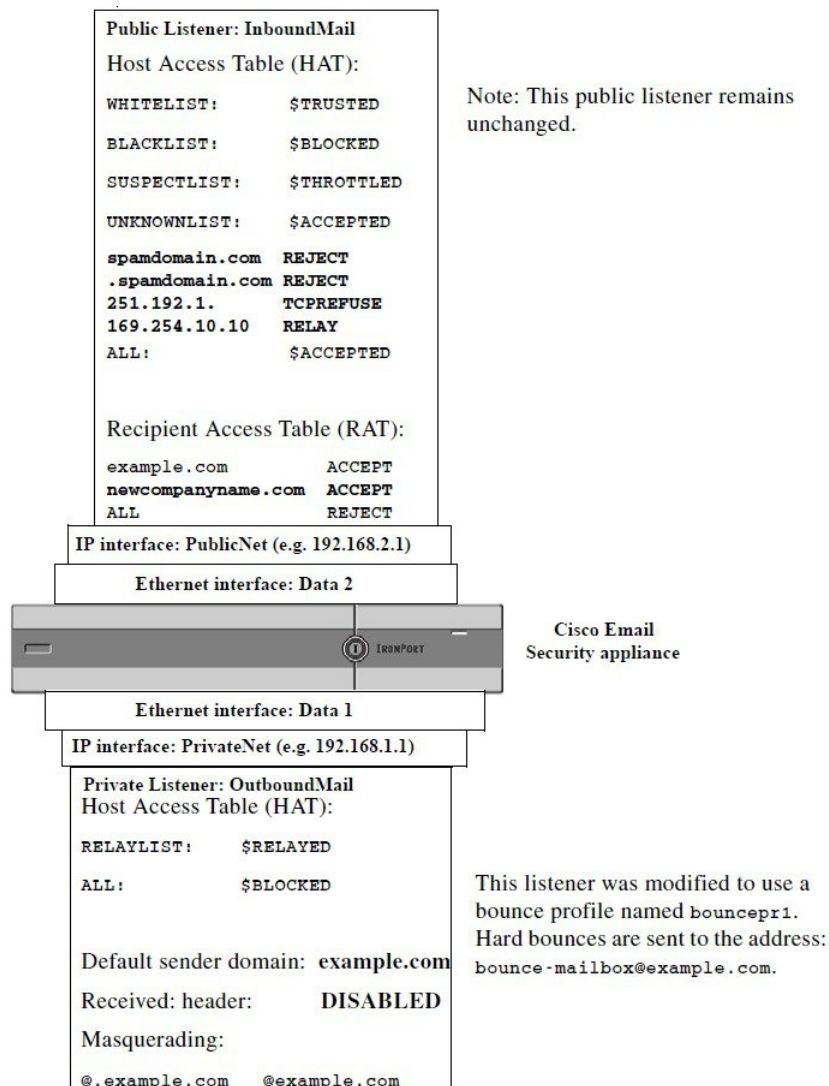

Controlling Email Delivery Using Destination Controls

Uncontrolled high-volume email delivery can overwhelm recipient domains. AsyncOS gives you full control of message delivery by defining the number of connections your appliance will open or the number of messages your appliance will send to each destination domain.

Using the Destination Controls feature (Mail Policies > Destination Controls in the GUI, or the destconfig command in the CLI), you can control:

- [Rate Limiting, on page 709](#)
- [TLS, on page 709](#)
- [Bounce Verification, on page 709](#)
- [Bounce Profile, on page 709](#)

Rate Limiting

- **Concurrent Connections:** number of simultaneous connections to remote hosts the appliance will attempt to open.
- **Maximum Messages Per Connection:** number of messages your appliance will send to a destination domain before the appliance initiates a new connection.
- **Recipients:** number of recipients the appliance will send to a given remote host in a given time period.
- **Limits:** how to apply the limits you have specified on a per-destination and per MGA hostname basis.

TLS

- Whether TLS connections to remote hosts will be accepted, allowed, or required (see [Controlling TLS, on page 712](#)).
- Whether to send an alert when TLS negotiation fails when delivering a message to a remote host that requires a TLS connection. This is a global setting, not a per-domain setting.
- Assign a TLS certificate to use for all outbound TLS connections to remote hosts.

Bounce Verification

- Whether or not to perform address tagging via Bounce Verification (see [Bounce Verification, on page 716](#)).

Bounce Profile

- Which bounce profile should be used by the appliance for a given remote host (the default bounce profile is set via the Network > Bounce Profiles page).

You can also control the default settings for unspecified domains.

Related Topics

- [Determining Which Interface is Used for Mail Delivery, on page 709](#)
- [Default Delivery Limits, on page 710](#)
- [Working with Destination Controls, on page 710](#)

Determining Which Interface is Used for Mail Delivery

Unless you specify the output interface via the `deliveryconfig` command or via a message filter (`alt-src-host`), or through the use of a virtual gateway, the output interface is selected by the AsyncOS routing table. Basically, selecting “auto” means to let AsyncOS decide.

In greater detail: local addresses are identified by applying the interface netmask to the interface IP address. Both of these are set via the Network > Interfaces page or by the `interfaceconfig` command (or during system setup). If the address space overlaps, the most specific netmask is used. If a destination is local, packets are sent via the appropriate local interface.

If the destination is not local, packets are sent to the default router (set via the Network > Routing page or with the `setgateway` command). The IP address of the default router is local. The output interface is determined by the rule for selecting the output interface for local addresses. For example, AsyncOS chooses the most specific IP address and netmask that include the default router's IP address.

The routing table is configured via the Network > Routing page (or via the `routeconfig` command). A matching entry in the routing table takes precedence over the default route. A more specific route takes precedence over a less specific route.

Default Delivery Limits

Each outbound destination domain has its own outbound queue. Therefore, each domain has a separate set of concurrency limits as specified in the Destination Controls table. Further, each unique domain not listed specifically in the Destination Controls table uses another set of the “Default” limits as set in the table.

Working with Destination Controls

Use the Mail Policies > Destination Controls page in the GUI or the `destconfig` command in the CLI to create, edit, and delete Destination Control entries.

Related Topics

- [Controlling the Version of Internet Protocol Addresses, on page 710](#)
- [Controlling the Number of Connections, Messages, and Recipients to a Domain, on page 710](#)
- [Controlling TLS, on page 712](#)
- [Controlling Bounce Verification Tagging, on page 712](#)
- [Controlling Bounces, on page 712](#)
- [Adding a New Destination Control Entry, on page 712](#)
- [Importing and Exporting Destination Control Configurations, on page 713](#)
- [Destination Controls and the CLI, on page 716](#)

Controlling the Version of Internet Protocol Addresses

You can configure which version of Internet Protocol addresses to use for the connection to a domain. The appliance uses both Internet Protocol version 4 (IPv4) and Internet Protocol version (IPv6). You can configure a listener on the appliance to use one version of the protocol or both.

If the “Required” setting for either IPv4 or IPv6 is specified, the appliance will negotiate a connection to the domain using an address of the specified version. If the domain does not use that IP address version, no email will be sent. If the “Preferred” setting for either IPv4 or IPv6 is specified, the appliance will first attempt to negotiate a connection to the domain using an address of the specified version then fall back to the other if the first is not reachable.

Controlling the Number of Connections, Messages, and Recipients to a Domain

You may want to limit how your appliance will deliver email to avoid overwhelming remote hosts or your own internal groupware servers with email from your appliance .

For each domain, you can assign a maximum number of connections, outbound messages, and recipients that will never be exceeded by the system in a given time period. This “good neighbor” table is defined through the Destination Controls feature (**Mail Policies > Destination Controls** or the `destconfig` command — previously the `setgoodtable` command). You can specify the domain name using the following syntax:

```
domain.com
```

```
or
```

.domain.com

This syntax enables AsyncOS to specify destination controls for sub-domains such as sample.server.domain.com without entering each full subdomain address individually.

For connections, messages, and recipients, you set whether the limits you define are enforced for each Virtual Gateway address, or for the entire system. (Virtual Gateway address limits control the number of concurrent connections per IP interface. System-wide limits control the total number of connections the appliance will allow.)

You also set whether the limits you define are enforced for the entire domain.



Note The current system default is 500 connections per domain and 50 messages per connection.

These values are explained in the following table.

Table 61: Values in the Destination Controls Table

Field	Description
Concurrent Connections	The maximum number of outbound connections that will be made by the appliance to a given host. (Note that the domain can include your internal groupware hosts.)
Maximum Messages Per Connection	The maximum number of messages allowed for a single outbound connection from the appliance to a given host before initiating a new connection.
Recipients	<p>The maximum number of recipients allowed within the given period of time. “None” denotes that there is no recipient limit for the given domain.</p> <p>The minimum period of time — between 1 and 60 minutes — that the appliance will count the number of recipients. Specifying a time period of “0” disables the feature.</p> <p>Note If you change the recipient limit, AsyncOS resets the counters for all messages already in the queue. The appliance delivers the messages based on the new recipient limit.</p>
Apply Limits	<p>Specifies whether the limit will be applied (enforces) to the entire domain.</p> <p>This setting applies to connection, message, and recipient limits.</p> <p>Specifies whether the limit will be applied system-wide or for each Virtual Gateway address.</p> <p>Note If you have configured groups of IP addresses, but you have not configured virtual gateways, do not configure apply limits per each virtual gateway. This setting is intended only for systems configured to use virtual gateways. For information on configuring virtual gateways, see Configuring Mail Gateways for all Hosted Domains Using Virtual Gateway™ Technology, on page 723.</p>



Note If limits are applied per each Virtual Gateway address, you can still effectively implement system-wide limits by setting the Virtual Gateway limit to the system-wide limit you want divided by the number of possible virtual gateways. For example, if you have four Virtual Gateway addresses configured, and you do not want to open more than 100 simultaneous connections to the domain `yahoo.com`, set the Virtual Gateway limit to 25 simultaneous connections.

The `delivernow` command, when acting on all domains, resets all counters tracked in the `destconfig` command.

Controlling TLS

You can also configure the TLS (Transport Layer Security) on a per-domain basis. If the “Required” setting is specified, a TLS connection will be negotiated from the appliance listener to MTA(s) for the domain. If the negotiation fails, no email will be sent through the connection. For more information, see [Enabling TLS and Certificate Verification on Delivery, on page 660](#).

You can specify whether the appliance sends an alert if the TLS negotiation fails when delivering messages to a domain that requires a TLS connection. The alert message contains name of the destination domain for the failed TLS negotiation. The appliance sends the alert message to all recipients set to receive Warning severity level alerts for System alert types. You can manage alert recipients via the System Administration > Alerts page in the GUI (or via the `alertconfig` command in the CLI).

To enable TLS connection alerts, click **Edit Global Settings** on the Destination Controls page or `destconfig -> setup` subcommand. This is a global setting, not a per-domain setting. For information on the messages that the appliance attempted to deliver, use the Monitor > Message Tracking page or the mail logs.

You must specify a certificate to use for all outgoing TLS connections. Use the **Edit Global Settings** on the Destination Controls page or `destconfig -> setup` subcommand to specify the certificate. For information on obtaining a certificate, see [Working with Certificates, on page 652](#).

For more information on alerts, see the “System Administration” chapter.

Controlling Bounce Verification Tagging

You can specify whether or not mail sent is tagged for bounce verification. You can specify this for the default, as well as specific destinations. Cisco suggests enabling bounce verification for the default, and then creating new destinations for specific exclusions. See [Bounce Verification, on page 716](#) for more information.

Controlling Bounces

In addition to controlling the number of connections and recipients will deliver to a remote host, you can also specify a bounce profile to be used for that domain. If specified, the bounce profile appears in the fifth column of the `destconfig` command. If you do not specify a bounce profile, the default bounce profile will be used. For more information, see [Creating a New Bounce Profile, on page 707](#).

Adding a New Destination Control Entry

Procedure

-
- Step 1** Click **Add Destination**:
 - Step 2** Configure the entry.

Step 3 Submit and commit your changes.

Importing and Exporting Destination Control Configurations

If you are managing multiple domains, you can create a single configuration file to define Destination Control entries for all of the domains and import it onto the appliance. The format of the configuration file is similar to a Windows INI configuration file. The parameters for a domain are grouped in a section with the domain name as the section name. For example, use the section name [example.com] to group the parameters for the domain example.com. Any parameter that is not defined will be inherited from the default Destination Control entry. You can define the parameters for the default Destination Control entry by including a [DEFAULT] section in the configuration file.

Importing the configuration file overwrites all of appliance's Destination Control entries, except for the default entry unless the configuration file includes the [DEFAULT] section. All other existing Destination Control entries will be deleted.

You can define any of the following parameters for a domain in the configuration file. All parameters are required for the [DEFAULT] section except for the bounce_profile parameter:

Table 62: Destination Control Configuration File Parameters

Parameter Name	Description
ip_sort_pref	Specifies the Internet Protocol version for the domain. Enter one of the following values: <ul style="list-style-type: none"> • PREFER_V6 for “IPv6 Preferred” • REQUIRE_V6 for “IPv6 Required” • PREFER_V4 for “IPv4 Preferred” • REQUIRE_V4 for “IPv4 Required”
max_host_concurrency	The maximum number of outbound connections that will be made by the appliance to a given host. If you define this parameter for a domain, the limit_type and limit_apply parameters must also be defined.
max_messages_per_connection	The maximum number of messages allowed for a single outbound connection from the appliance to a given host before initiating a new connection.
recipient_minutes	The period of time — between 1 and 60 minutes — that the appliance will count the number of recipients. Leave undefined if no recipient limit should be applied.
recipient_limit	The maximum number of recipients allowed within the given period of time. Leave undefined if no recipient limit should be applied. If you define this parameter for a domain, the recipient_minutes, limit_type, and limit_apply parameters must also be defined.

Parameter Name	Description
limit_type	<p>Specifies whether the limit will be applied to the entire domain or to each mail exchange IP address specified for that domain.</p> <p>Enter one of the following values:</p> <ul style="list-style-type: none"> • 0 (or host) for the domain • 1 (or MXIP) for the mail exchange IP address
limit_apply	<p>Specifies whether the limit will be applied system-wide or for each Virtual Gateway address.</p> <p>Enter one of the following values:</p> <ul style="list-style-type: none"> • 0 (or system) for system-wide • 1 (or VG) for Virtual Gateway
bounce_validation	<p>Specifies whether to turn on bounce validation address tagging.</p> <p>Enter one of the following values:</p> <ul style="list-style-type: none"> • 0 (or off) • 1 (or on)
table_tls	<p>Specifies the TLS setting for the domain. See Enabling TLS and Certificate Verification on Delivery, on page 660 for more information.</p> <p>Enter one of the following values:</p> <ul style="list-style-type: none"> • 0 (or off) • 1 (or on) for “Preferred” • 2 (or required) for “Required” • 3 (or on_verify) for “Preferred (Verify)” • 4 (or require_verify) for “Required (Verify)” <p>Strings are not case sensitive.</p>
bounce_profile	Name of the bounce profile to use. This cannot be used in the [DEFAULT] destination control entry.
send_tls_req_alert	<p>Whether to send an alert if the required TLS connection fails.</p> <p>Enter one of the following values:</p> <ul style="list-style-type: none"> • 0 (or off) • 1 (or on) <p>This is a global setting and can only be used in the [DEFAULT] destination control entry.</p>
certificate	<p>Certificate used for outgoing TLS connections. This is a global setting and can only be used in the [DEFAULT] destination control entry.</p> <p>Note If you do not specify a certificate, AsyncOS assigns the demonstration certificate, but using the demonstration certificate is not secure and not recommended for general use.</p>

The following example shows a configuration file for the domains example1.com and example2.com along with the default Destination Control entry:

```
[DEFAULT]
ip_sort_pref = PREFER_V6
max_host_concurrency = 500
max_messages_per_connection = 50
recipient_minutes = 60
recipient_limit = 300
limit_type = host
limit_apply = VG
table_tls = off
bounce_validation = 0
send_tls_req_alert = 0
certificate = example.com

[example1.com]
ip_sort_pref = PREFER_V6
recipient_minutes = 60
recipient_limit = 100
table_tls = require_verify
limit_apply = VG
bounce_profile = tls_failed
limit_type = host

[example2.com]
table_tls = on
bounce_profile = tls_failed
```

The above example results in the following Destination Control entries for example1.com and example2.com:

```
example1.com

IP Address Preference: IPv6 Preferred
Maximum messages per connection: 50
Rate Limiting:
500 concurrent connections
100 recipients per 60 minutes
```

Limits applied to entire domain, across all virtual gateways

TLS: Required (Verify)

Bounce Profile: tls_failed

example2.com

IP Address Preference: IPv6 Preferred

Maximum messages per connection: Default

Rate Limiting: Default

TLS: Preferred

Bounce Profile: tls_failed

Use the **Import Table** button on the Destination Controls page or the `destconfig -> import` command to import a configuration file. You can also export your Destination Control entries to an INI file using the **Export Table** button on the Destination Controls page or the `destconfig -> export` command. AsyncOS includes the `[Default]` domain control entry in the exported INI file.

Destination Controls and the CLI

You can use the `destconfig` command in the CLI to configure Destination Control entries. This command is discussed in the CLI Reference Guide for AsyncOS for Cisco Email Security Appliances .

Bounce Verification

A “bounce” message is a new message that is sent by a receiving MTA, using the Envelope Sender of the original email as the new Envelope Recipient. This bounce is sent back to the Envelope Recipient (usually) with a blank Envelope Sender (MAIL FROM: <>) when the original message is undeliverable (typically due to a non-existent recipient address).

Increasingly, spammers are attacking email infrastructure via misdirected bounce attacks. These attacks consist of a flood of bounce messages, sent by unknowing, legitimate mail servers. Basically, the process spammers use is to send email via open relays and “zombie” networks to multiple, potentially invalid addresses (Envelope Recipients) at various domains. In these messages, the Envelope Sender is forged so that the spam appears to be coming from a legitimate domain (this is known as a “Joe job”).

In turn, for each incoming email with an invalid Envelope Recipient, the receiving mail servers generate a new email — a bounce message — and send it along to the Envelope Sender at the innocent domain (the one whose Envelope Sender address was forged). As a result, this target domain receives a flood of “misdirected” bounces — potentially millions of messages. This type of distributed denial of service attack can bring down email infrastructure and render it impossible for the target to send or receive legitimate email.

To combat these misdirected bounce attacks, AsyncOS includes Bounce Verification. When enabled, Bounce Verification tags the Envelope Sender address for messages sent via your appliance . The Envelope Recipient for any bounce message received by the appliance is then checked for the presence of this tag. Legitimate bounces (which should contain this tag) are untagged and delivered. Bounce messages that do not contain the tag can be handled separately.

Note that you can use Bounce Verification to manage incoming bounce messages based on your outgoing mail. To control how your appliance generates outgoing bounces (based on incoming mail), see [Directing Bounced Email, on page 700](#).

Related Topics

- [Overview: Tagging and Bounce Verification, on page 717](#)
- [Preventing a Bounced Message Storm Using Bounce Verification, on page 718](#)
- [Accepting Legitimate Untagged Bounced Messages, on page 718](#)

Overview: Tagging and Bounce Verification

When sending email with bounce verification enabled, your appliance will rewrite the Envelope Sender address in the message. For example, MAIL FROM: joe@example.com becomes MAIL FROM: prvs=joe=123ABCDEFGH@example.com . The 123... string in the example is the “bounce verification tag” that gets added to the Envelope Sender as it is sent by your appliance . The tag is generated using a key defined in the Bounce Verification settings (see [Bounce Verification Address Tagging Keys, on page 718](#) for more information about specifying a key). If this message bounces, the Envelope Recipient address in the bounce will typically include this bounce verification tag.

You can enable or disable bounce verification tagging system-wide as a default. You can also enable or disable bounce verification tagging for specific domains. In most situations, you would enable it by default, and then list specific domains to exclude in the Destination Controls table (see [Working with Destination Controls, on page 710](#)).

If a message already contains a tagged address, AsyncOS does not add another tag (in the case of an appliance delivering a bounce message to an appliance inside the DMZ).

Related Topics

- [Handling Incoming Bounce Messages, on page 717](#)
- [Bounce Verification Address Tagging Keys, on page 718](#)

Handling Incoming Bounce Messages

Bounces that include a valid tag are delivered. The tag is removed and the Envelope Recipient is restored. This occurs immediately after the Domain Map step in the email pipeline. You can define how your appliances handle untagged or invalidly tagged bounces — reject them or add a custom header. See [Configuring Bounce Verification Settings, on page 719](#) for more information.

If the bounce verification tag is not present, or if the key used to generate the tag has changed, or if the message is more than seven days old, the message is treated as per the settings defined for Bounce Verification.

For example, the following mail log shows a bounced message rejected by the appliance :

```
Fri Jul 21 16:02:19 2006 Info: Start MID 26603 ICID 125192
Fri Jul 21 16:02:19 2006 Info: MID 26603 ICID 125192 From: <>
Fri Jul 21 16:02:40 2006 Info: MID 26603 ICID 125192 invalid bounce, rcpt address
<bob@example.com> rejected by bounce verification.
Fri Jul 21 16:03:51 2006 Info: Message aborted MID 26603 Receiving aborted by sender
Fri Jul 21 16:03:51 2006 Info: Message finished MID 26603 aborted
```



Note When delivering non-bounce mail to your own internal mail server (Exchange, etc.), you should disable Bounce Verification tagging for that internal domain.

AsyncOS considers bounces as mail with a null Mail From address (<>). For non-bounce messages that might contain a tagged Envelope Recipient, AsyncOS applies a more lenient policy. In such cases, AsyncOS ignores the seven-day key expiration and tries to find a match with older keys as well.

Bounce Verification Address Tagging Keys

The tagging key is a text string your appliance uses when generating the bounce verification tag. Ideally, you would use the same key across all of your appliances so that all mail leaving your domain is tagged consistently. That way, if one appliance tags the Envelope Sender on an outgoing message an incoming bounce will be verified and delivered even if the bounce is received by a different appliance .

There is a seven day grace period for tags. For example, you may choose to change your tagging key multiple times within a seven-day period. In such a case, your appliance will try to verify tagged messages using all previous keys that are less than seven days old.

Accepting Legitimate Untagged Bounced Messages

AsyncOS also includes a HAT setting related to Bounce Verification for considering whether untagged bounces are valid. The default setting is “No,” which means that untagged bounces are considered invalid and the appliance either rejects the message or applies a customer header, depending on the action selected on the **Mail Policies > Bounce Verification** page. If you select “Yes,” the appliance considers untagged bounces to be valid and accepts them. This may be used in the following scenario:

Suppose you have a user that wants to send email to a mailing list. However, the mailing list accepts messages only from a fixed set of Envelope Senders. In such a case, tagged messages from your user will not be accepted (as the tag changes regularly).

Procedure

-
- Step 1** Add the domain to which the user is trying to send mail to the Destination Controls table and disable tagging for that domain. At this point, the user can send mail without problems.
 - Step 2** However, to properly support receiving bounces from that domain (since they will not be tagged) you can create a sender group for that domain and enable the Consider Untagged Bounces to be Valid parameter in an “Accept” mail flow policy.
-

Preventing a Bounced Message Storm Using Bounce Verification

Procedure

-
- Step 1** Enter a tagging key. For more information, see [Configuring Bounce Verification Address Tagging Keys](#), on page 719.

- Step 2** Edit the bounce verification settings. For more information, see [Configuring Bounce Verification Settings, on page 719](#).
- Step 3** Enable bounce verification via Destination Controls. For more information, see [Working with Destination Controls, on page 710](#).
-

What to do next

Related Topics

- [Configuring Bounce Verification Address Tagging Keys, on page 719](#)
- [Configuring Bounce Verification Settings, on page 719](#)
- [Configuring Bounce Verification Using the CLI, on page 720](#)
- [Bounce Verification and Cluster Configuration, on page 720](#)

Configuring Bounce Verification Address Tagging Keys

The Bounce Verification Address Tagging Keys listing shows your current key and any unpurged keys you have used in the past. To add a new key:

Procedure

- Step 1** On the **Mail Policies > Bounce Verification** page, click **New Key**.
- Step 2** Enter a text string and click **Submit**.
- Step 3** **Commit** your changes.
-

What to do next

Related Topics

- [Purging Keys, on page 719](#)

Purging Keys

You can purge your old address tagging keys by selecting a rule for purging from the pull-down menu and clicking **Purge**.

Configuring Bounce Verification Settings

The bounce verification settings determine which action to take when an invalid bounce is received.

Procedure

- Step 1** Choose **Mail Policies > Bounce Verification**.
- Step 2** Click **Edit Settings**.
- Step 3** Select whether to reject invalid bounces, or to add a custom header to the message. If you want to add a header, enter the header name and value.

- Step 4** Optionally, enable smart exceptions. This setting allows incoming mail messages, and bounce messages generated by internal mail servers, to be automatically exempted from bounce verification processing (even when a single listener is used for both incoming and outgoing mail).
- Step 5** Submit and commit your changes.

Configuring Bounce Verification Using the CLI

You can use the `bvconfig` and `destconfig` commands in the CLI to configure bounce verification. These commands are discussed in the *CLI Reference Guide for AsyncOS for Cisco Email Security Appliances*.

Bounce Verification and Cluster Configuration

Bounce verification works in a cluster configuration as long as both appliances use the same "bounce key." When you use the same key, either systems should be able to accept a legitimate bounce back. The modified header tag/key is not specific to each appliance.

Set Email Delivery Parameters

The `deliveryconfig` command sets parameters to be used when delivering email from the appliance.

The appliance accepts email using multiple mail protocols: SMTP and QMQP. However, all outgoing email is delivered using SMTP, which is why the `deliveryconfig` command does not require that the protocol be specified.



Note Several of the features or commands described in this section will affect, or be affected by routing precedence. Please see the “Assigning Network and IP Addresses” appendix for more information.

Related Topics

- [Default Delivery IP Interface, on page 720](#)
- [Possible Delivery Feature, on page 721](#)
- [Default Maximum Concurrency, on page 721](#)
- [deliveryconfig Example, on page 721](#)

Default Delivery IP Interface

By default, the system uses an IP interface or IP interface group for email delivery. Any currently configured IP interface or IP interface group can be set. If no specific interface is identified, AsyncOS will use the hostname associated with the default delivery interface in the SMTP HELO command when communicating with recipient hosts. To configure IP interfaces, use the `interfaceconfig` command.

These are the rules for using Auto selection of email delivery interfaces:

- If the remote email server is on the same subnet as one of the configured interfaces, then traffic will go out on the matching interface.
- When set to auto-select, static routes you have configured using `routeconfig` take effect.

- Otherwise, the interface that is on the same subnet as the default gateway will be used. If all of the IP addresses have an equivalent route to the destination, then the system uses the most efficient interface available.

Possible Delivery Feature

**Caution**

If you enable this feature, message delivery will not be reliable and may lead to loss of messages. Also, your appliance will not be RFC 5321-compliant. For more information, see <http://tools.ietf.org/html/rfc5321#section-6.1..>

When the Possible Delivery feature is enabled, AsyncOS treats any message that times-out after the body of the message is delivered, but before recipient host acknowledges receipt of the message, as a “possible delivery.” This functionality prevents recipients from receiving multiple copies of a message if continuous errors at their recipient host prevent acknowledgment of receipt. AsyncOS logs this recipient as a possible delivery in the mail logs and counts the message as completed.

Default Maximum Concurrency

You also specify the default maximum number of concurrent connections the appliance makes for outbound message delivery. (The system-wide default is 10,000 connections to separate domains.) The limit is monitored in conjunction with the per-listener maximum outbound message delivery concurrency (the default per listener is 600 connections for private listeners and 1000 connections for public listeners). Setting the value lower than the default prevents the gateway from dominating weaker networks. For example, certain firewalls do not support large numbers of connections, and this could induce Denial of Service (DoS) warnings in these environments.

deliveryconfig Example

In the following example, the `deliveryconfig` command is used to set the default interface to “Auto” with “Possible Delivery” enabled. The system-wide maximum outbound message delivery is set to 9000 connections.

```
mail3.example.com> deliveryconfig

Choose the operation you want to perform:
- SETUP - Configure mail delivery.

[ ]> setup

Choose the default interface to deliver mail.

1. Auto
2. PublicNet2 (192.168.3.1/24: mail4.example.com)
3. Management (192.168.42.42/24: mail3.example.com)
4. PrivateNet (192.168.1.1/24: mail3.example.com)
5. PublicNet (192.168.2.1/24: mail3.example.com)
```

```
[1]> 1
Enable "Possible Delivery"? [Y]> y
Please enter the default system wide maximum outbound message delivery
concurrency
[10000]> 9000
mail3.example.com>
```

Our Email Gateway configuration now looks like this:

Figure 51: Setting Destination and Delivery Parameters

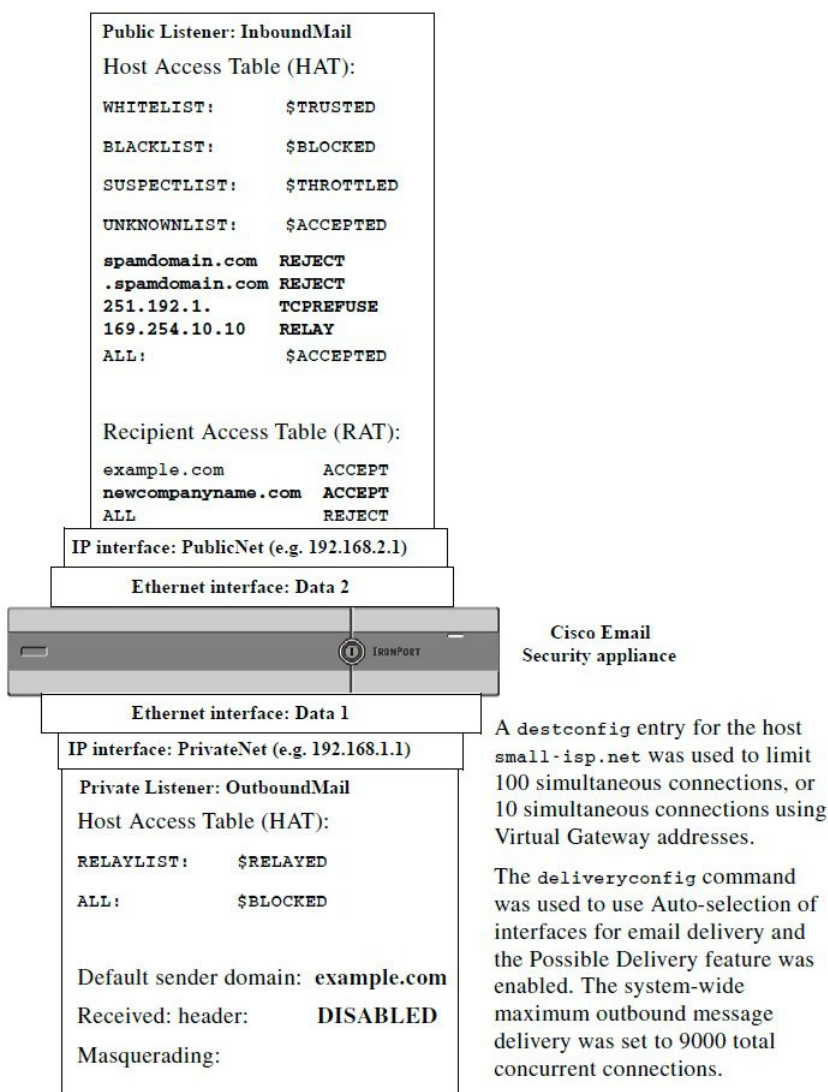

Configuring Mail Gateways for all Hosted Domains Using Virtual Gateway™ Technology

This section describes Cisco Virtual Gateway™ technology and its benefits, how to set up a Virtual Gateway address, and how to monitor and manage Virtual Gateway addresses.

The Cisco Virtual Gateway technology allows you to configure enterprise mail gateways for all domains you host — with distinct IP addresses, hostname and domains — and create separate corporate email policy enforcement and anti-spam strategies for those domains, while hosted within the same physical appliance. The number of Virtual Gateway addresses available on all the appliance models is 255.

Related Topics

- [Overview, on page 723](#)
- [Setting Up Virtual Gateway Addresses, on page 723](#)
- [Monitoring the Virtual Gateway Addresses, on page 730](#)
- [Managing Delivery Connections per Virtual Gateway Address, on page 731](#)

Overview

Cisco has developed a unique Virtual Gateway technology designed to help ensure that corporations can reliably communicate with their customers via email. Virtual Gateway technology enables users to separate the appliance into multiple Virtual Gateway addresses from which to send and receive email. Each Virtual Gateway address is given a distinct IP address, hostname and domain, and email queue.

Assigning a distinct IP address and hostname to each Virtual Gateway address ensures that email delivered through the gateway will be properly identified by the recipient host and prevents critical email from being blocked as spam. The appliance has the intelligence to give the correct hostname in the SMTP HELO command for each of the Virtual Gateway addresses. This ensures that if a receiving Internet Service Provider (ISP) performs a reverse DNS look-up, the appliance will match the IP address of the email sent through that Virtual Gateway address. This feature is extremely valuable, because many ISPs use a reverse DNS lookup to detect unsolicited email. If the IP address in the reverse DNS look-up does not match the IP address of the sending host, the ISP may assume the sender is illegitimate and will frequently discard the email. The Cisco Virtual Gateway technology ensures that reverse DNS look-ups will always match the sending IP address, preventing messages from being blocked accidentally.

Messages in each Virtual Gateway address are also assigned to a separate message queue. If a certain recipient host is blocking email from one Virtual Gateway address, messages intended for that host will remain in the queue and eventually timeout. But messages intended for the same domain in a different Virtual Gateway queue that is not being blocked will be delivered normally. While these queues are treated separately for delivery purposes, the system administration, logging and reporting capability still provide a holistic view into all Virtual Gateway queues as if they were one.

Setting Up Virtual Gateway Addresses

Before setting up the Cisco Virtual Gateway addresses, you must allocate a set of IP addresses that will be used to send email from. (For more information, see the “Assigning Network and IP Addresses” appendix.) You should also ensure proper configuration of your DNS servers so that the IP address resolves to a valid

hostname. Proper configuration of DNS servers ensures that if the recipient host performs a reverse DNS lookup, it will resolve to valid IP/hostname pairs.

Related Topics

- [Creating New IP Interfaces for Use with Virtual Gateways, on page 724](#)
- [Mapping Messages to IP Interfaces for Delivery, on page 726](#)
- [Importing an altsrchoost File, on page 727](#)
- [altsrchoost Limits, on page 728](#)
- [Example Text File with Valid Mappings for the altsrchoost Command, on page 728](#)
- [Adding an altsrchoost Mapping through the CLI, on page 728](#)

Creating New IP Interfaces for Use with Virtual Gateways

After the IP addresses and hostnames have been established, the first step in configuring the Virtual Gateway addresses is to create new IP interfaces with the IP/hostname pairs using the Network > IP Interfaces page in the GUI or the interfaceconfig command in the CLI.

Once the IP interfaces have been configured, you have the option to combine multiple IP interfaces into interface groups; these groups can then be assigned to specific Virtual Gateway addresses which the system cycles through in a “round robin” fashion when delivering email.

After creating the required IP interfaces, you have two options for setting up the Virtual Gateway addresses and defining which email campaign will be sent from each IP interface or interface group:

- You can use the altsrchoost command to map email from specific sender IP addresses or Envelope Sender address information to a host IP interface (Virtual Gateway address) or interface group for delivery.
- Using message filters, you can set up specific filters to deliver flagged messages using a specific host IP interface (Virtual Gateway address) or interface group. See [Alter Source Host \(Virtual Gateway address\) Action, on page 207](#). (This method is more flexible and powerful than the one above.)

For more information about creating IP interfaces, see the “Accessing the Appliance ” appendix.

So far, we have been using an Email Gateway configuration with the following interfaces defined as shown in the following figure.

Figure 52: Example Public and Private interfaces

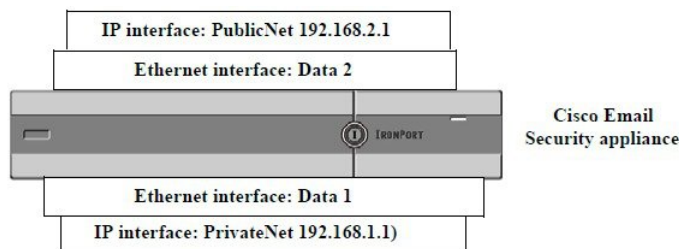

In the following example, the IP Interfaces page confirms that these two interfaces (PrivateNet and PublicNet) have been configured, in addition to the Management interface.

Figure 53: IP Interface Page

IP Interfaces

Network Interfaces and IP Addresses			
Add IP Interface...			
Name	IP Address	Hostname	Delete
Management	192.168.42.42/24	mail3.example.com	
PrivateNet	192.168.1.1/24	mail3.example.com	
PublicNet	192.168.2.1/24	mail3.example.com	

Next, the Add IP Interface page is used to create a new interface named PublicNet2 on the Data2 Ethernet interface. The IP address of 192.168.2.2 is used, and the hostname of mail4.example.com is specified. The services for FTP (port 21) and SSH (port 22) are then enabled.

Figure 54: Add IP Interface Page

Add IP Interface

IP Interface Settings

Name:

Ethernet Port:

IP Address: *

Netmask: *

Hostname:

Services:

Service	Port
<input checked="" type="checkbox"/> FTP	<input type="text" value="21"/>
<input checked="" type="checkbox"/> SSH	<input type="text" value="22"/> *
Appliance Management	
<input type="checkbox"/> HTTP	<input type="text" value="80"/> *
<input type="checkbox"/> HTTPS	<input type="text" value="443"/> *
<input type="checkbox"/> Redirect HTTP requests to HTTPS (HTTP and HTTPS Services will be turned on)	
IronPort Spam Quarantine	
<input type="checkbox"/> IronPort Spam Quarantine HTTP	<input type="text" value="82"/>
<input type="checkbox"/> IronPort Spam Quarantine HTTPS	<input type="text" value="83"/>
<input type="checkbox"/> Redirect HTTP requests to HTTPS (HTTP and HTTPS Services will be turned on)	
<input type="checkbox"/> This is the default interface for IronPort Spam Quarantine Quarantine login and notifications will originate on this interface. URL Displayed in Notifications: <input checked="" type="radio"/> Hostname <input type="radio"/> <input type="text" value=""/> (examples: http://spamQ.url/, http://10.1.1.1:82/)	

Warnings - * Please exercise care when disabling or changing these items, as this could disrupt active connections to this appliance when changes to these items are committed.
 ** Hyperlinks and URLs affected by these changes will not be usable until the changes are committed.

Our Email Gateway configuration now looks like this:

Figure 55: Adding Another Public Interface

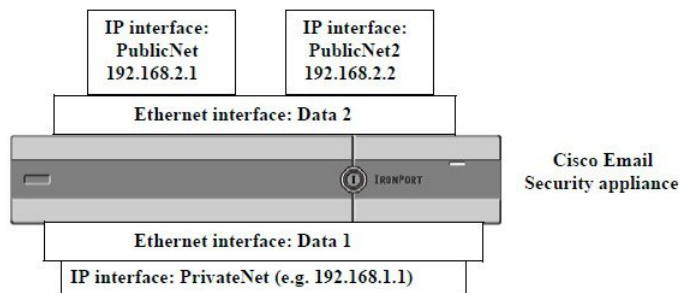

Using Virtual Gateway addresses, a configuration like the one shown in the following figure is also possible.

Figure 56: Four Virtual Gateway Addresses on One Ethernet Interface

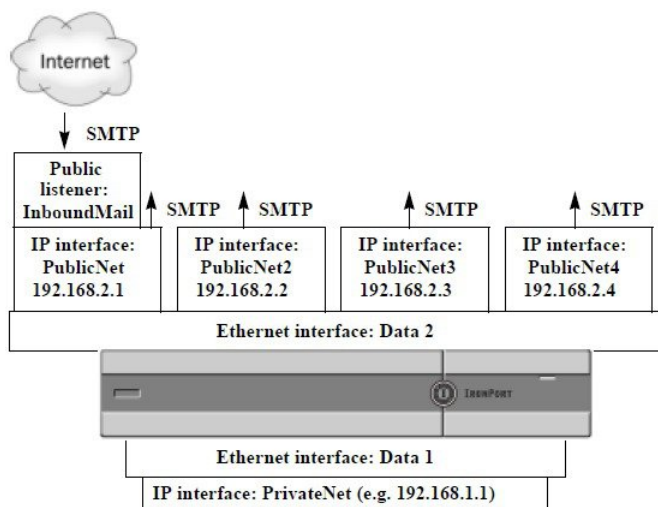

Note that four separate IP interfaces can be used to deliver mail, where only one public listener is configured to accept messages from the Internet.

Mapping Messages to IP Interfaces for Delivery

The `altsrchoost` command provides the simplest and most straightforward method to segment each appliance into multiple IP interfaces (Virtual Gateway addresses) from which to deliver email. However, users requiring more power and flexibility in mapping messages to particular Virtual Gateways should investigate the use of message filters. See [Using Message Filters to Enforce Email Policies, on page 131](#) for more information.

The `altsrchoost` command allows you to control which IP interface or interface group to use during email delivery based on one of the following:

- the sender's IP address
- the Envelope Sender address

To specify which IP interface or interface group the system will deliver email from, you create mapping keys that pair either the sender's IP address or the Envelope Sender address to an IP interface or interface group (specified by interface name or group name).

AsyncOS will compare both the IP address and Envelope Sender address to the mapping keys. If either the IP address or Envelope Sender address matches one of the keys, the corresponding IP interface is used for the outbound delivery. If there is no match, the default outbound interface will be used.

The system can match any of the following keys and take preference in the following order:

Sender's IP address	The IP address of the sender must match exactly. Example: 192.168.1.5
Fully-formed Envelope Sender	The Envelope Sender must match the entire address exactly. Example: username@example.com
Username	The system will match username syntax against the Envelope Sender address up to the @ sign. The @ sign must be included. Example: username@
Domain	The system will match domain name syntax against the Envelope Sender address starting with the @ sign. The @ sign must be included. Example: @example.com



Note A listener checks the information in the `altsrchoost` table and directs the email to a particular interface *after* checking the masquerading information and *before* message filters are checked.

Use these subcommands within the `altsrchoost` command to create mappings in the Virtual Gateways via the CLI:

Syntax	Description
<code>new</code>	Create a new mapping manually.
<code>print</code>	Display the current list of mappings.
<code>delete</code>	Remove one of the mappings from the table.

Importing an altsrchoost File

Like the HAT, the RAT, `smtproutes`, and masquerading and alias tables, you can modify `altsrchoost` entries by exporting and importing a file.

Procedure

- Step 1** Use the `export` subcommand of the `altsrchoost` command to export the existing entries to a file (whose name you specify).
- Step 2** Outside of the CLI, get the file. (See [FTP, SSH, and SCP Access](#), on page 1261 for more information.)
- Step 3** With a text editor, create new entries in the file. The order that rules appear in the `altsrchoost` table is important.
- Step 4** Save the file and place it in the “`altsrchoost`” directory for the interface so that it can be imported. (See [FTP, SSH, and SCP Access](#), on page 1261 for more information.)
- Step 5** Use the `import` subcommand of `altsrchoost` to import the edited file.

altsrchoost Limits

You can define up to 1,000 altsrchoost entries.

Example Text File with Valid Mappings for the altsrchoost Command

```
# Comments to describe the file

@example.com DemoInterface

paul@ PublicInterface

joe@ PublicInterface

192.168.1.5, DemoInterface

steve@example.com PublicNet
```

The `import` and `export` subcommands operate on a line-by-line basis and map either the sender IP address or the Envelope Sender address line to the interface name. The key must be the first block of non-space characters followed by the interface name in the second block of non-space characters, separated by a comma (,) or space (.). Comment lines start with a number sign (#) and will be ignored.

Adding an altsrchoost Mapping through the CLI

In the following example, the `altsrchoost` table is printed to show that there are no existing mappings. Two entries are then created:

- Mail from the groupware server host named `@exchange.example.com` is mapped to the `PublicNet` interface.
- Mail from the sender IP address of `192.168.35.35` (for example, the marketing campaign messaging system) is mapped to the `PublicNet` interface.

Finally, the `altsrchoost` mappings are printed to confirm and the changes are committed.

```
mail3.example.com> altsrchoost
```

```
There are currently no mappings configured.
```

```
Choose the operation you want to perform:
```

- NEW - Create a new mapping.
- IMPORT - Load new mappings from a file.

```
[> new
```

```
Enter the Envelope From address or client IP address for which you want to set up a Virtual Gateway mapping. Partial addresses such as "@example.com" or "user@" are allowed.
```

```
[> @exchange.example.com
```

```
Which interface do you want to send messages for @exchange.example.com from?
```

1. PublicNet2 (192.168.2.2/24: mail4.example.com)
2. Management (192.168.42.42/24: mail3.example.com)
3. PrivateNet (192.168.1.1/24: mail3.example.com)

```
4. PublicNet (192.168.2.1/24: mail4.example.com)
```

```
[1]> 4
```

```
Mapping for @exchange.example.com on interface PublicNet created.
```

```
Choose the operation you want to perform:
```

- NEW - Create a new mapping.
- EDIT - Modify a mapping.
- DELETE - Remove a mapping.
- IMPORT - Load new mappings from a file.
- EXPORT - Export all mappings to a file.
- PRINT - Display all mappings.
- CLEAR - Remove all mappings.

```
[> new
```

```
Enter the Envelope From address or client IP address for which you want to set up a Virtual Gateway mapping. Partial addresses such as "@example.com" or "user@" are allowed.
```

```
[> 192.168.35.35
```

```
Which interface do you want to send messages for 192.168.35.35 from?
```

1. PublicNet2 (192.168.2.2/24: mail4.example.com)
2. Management (192.168.42.42/24: mail3.example.com)
3. PrivateNet (192.168.1.1/24: mail3.example.com)
4. PublicNet (192.168.2.1/24: mail4.example.com)

```
[1]> 1
```

```
Mapping for 192.168.35.35 on interface PublicNet2 created.
```

```
Choose the operation you want to perform:
```

- NEW - Create a new mapping.
- EDIT - Modify a mapping.
- DELETE - Remove a mapping.
- IMPORT - Load new mappings from a file.
- EXPORT - Export all mappings to a file.
- PRINT - Display all mappings.
- CLEAR - Remove all mappings.

```

[ ]> print

1. 192.168.35.35 -> PublicNet2

2. @exchange.example.com -> PublicNet

Choose the operation you want to perform:

- NEW - Create a new mapping.

- EDIT - Modify a mapping.

- DELETE - Remove a mapping.

- IMPORT - Load new mappings from a file.

- EXPORT - Export all mappings to a file.

- PRINT - Display all mappings.

- CLEAR - Remove all mappings.

[ ]>

mail3.example.com> commit

Please enter some comments describing your changes:

[ ]> Added 2 altsrchoost mappings

Do you want to save the current configuration for rollback? [Y]> n

Changes committed: Fri May 23 11:42:12 2014 GMT

```

An illustration of the configuration change in this example is shown in the following figure:

Figure 57: Example: Selecting an IP Interface or Interface Group to Use

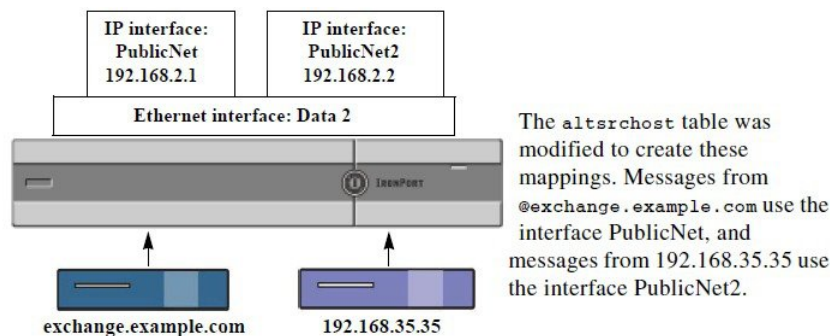

Monitoring the Virtual Gateway Addresses

While each Virtual Gateway address has its own email queue for delivery purposes, the system administration, logging, and reporting capabilities still provide a holistic view into all Virtual Gateway queues as if they were one. To monitor the recipient host status for each Virtual Gateway queue, use the `hoststatus` and `hostrate` command. See the “Reading the Available Components of Monitoring” section in the “Managing and Monitoring Using the CLI” chapter.

The `hoststatus` command returns monitoring information about email operations relating to a specific recipient host.

If you are using Virtual Gateway technology, information about each Virtual Gateway address is also displayed. The command requires you to input the domain of the host information to be returned. DNS information stored in the AsyncOS cache and the last error returned from the recipient host is also given. Data returned is cumulative since the last `resetcounters` command.

The statistics returned are grouped into two categories: counters and gauges. In addition, other data returned include: last activity, MX records, and last 5XX error.

Managing Delivery Connections per Virtual Gateway Address

Certain system parameters require settings at the system and Virtual Gateway address levels.

For example, some recipient ISPs limit the number of connections they allow for each client host. Therefore, it is important to manage relationships with the ISPs, especially when email is being delivered over multiple Virtual Gateway addresses.

See [Controlling Email Delivery Using Destination Controls, on page 708](#) for information about the `destconfig` command and how Virtual Gateway addresses are affected.

When you create a “group,” of Virtual Gateway addresses, the good neighbor table settings for Virtual Gateway are applied to the group, even if the group consists of 254 IP addresses.

For example, suppose you have created group of 254 outbound IP addresses set up as a group to cycle through in a “round-robin” fashion, and suppose the good neighbor table for `small-isp.com` is 100 simultaneous connections for the system and 10 connections for Virtual Gateway addresses. This configuration will *never* open more than 10 connections total for all 254 IP addresses in that group; the group is treated as a single Virtual Gateway address.

Using Global Unsubscribe

To ensure that specific recipients, recipient domains, or IP addresses never receive messages from the appliance, use the AsyncOS Global Unsubscribe feature. The unsubscribe command allows you to add and delete addresses to a global unsubscribe list, as well as enable and disable the feature. AsyncOS checks all recipient addresses against a list of “globally unsubscribed” users, domains, email addresses, and IP addresses. If a recipient matches an address in the list, the recipient is either dropped or hard bounced, and the Global Unsubscribe (GUS) counter is incremented. (Log files will note whether a matching recipient was dropped or hard bounced.) The GUS check occurs immediately before an attempt to send email to a recipient, thus inspecting all messages sent by the system.



Note Global Unsubscribe is not intended to replace the removal of names and general maintenance of mailing lists. The feature is intended to act as a fail-safe mechanism to ensure email does not get delivered to inappropriate entities.

Global Unsubscribe has a maximum limit of 10,000 addresses. Global Unsubscribe addresses can be in one of four forms:

Table 63: Global Unsubscribe Syntax

username@example.com	Fully-formed email address This syntax is used to block a specific recipient at a specific domain.
username@	Username The username syntax will block all recipients with the specified username at all domains. The syntax is the username followed by an at sign (@).
@example.com	Domain The domain syntax is used to block all recipients destined for a particular domain. The syntax is the specific domain, preceded by an at sign (@).
@.example.com	Partial Domain The partial domain syntax is used to block all recipients destined for a particular domain and all its subdomains.
10.1.28.12	IP address The IP address syntax is used to block all recipients destined for a particular IP address. This syntax can be useful if a single IP address is hosting multiple domains. The syntax consists of a common dotted octet IP address.

Related Topics

- [Adding a Global Unsubscribe Address Using The CLI, on page 732](#)
- [Exporting and Importing a Global Unsubscribe File, on page 734](#)

Adding a Global Unsubscribe Address Using The CLI

In this example, the address `user@example.net` is added to the Global Unsubscribe list, and the feature is configured to hard bounce messages. Messages sent to this address will be bounced; the appliance will bounce the message immediately prior to delivery.

```
mail3.example.com> unsubscribe
```

```
Global Unsubscribe is enabled. Action: drop.
```

```
Choose the operation you want to perform:
```

- NEW - Create a new entry.
- IMPORT - Import entries from a file.
- SETUP - Configure general settings.

```
[ ]> new

Enter the unsubscribe key to add. Partial addresses such as
"@example.com" or "user@" are allowed, as are IP addresses. Partial hostnames such as
"@.example.com" are allowed.

[ ]> user@example.net

Email Address 'user@example.net' added.

Global Unsubscribe is enabled.

Choose the operation you want to perform:

- NEW - Create a new entry.
- DELETE - Remove an entry.
- PRINT - Display all entries.
- IMPORT - Import entries from a file.
- EXPORT - Export all entries to a file.
- SETUP - Configure general settings.
- CLEAR - Remove all entries.

[ ]> setup

Do you want to enable the Global Unsubscribe feature? [Y]> y

Would you like matching messages to be dropped or bounced?

1. Drop
2. Bounce

[1]> 2

Global Unsubscribe is enabled. Action: bounce.

Choose the operation you want to perform:

- NEW - Create a new entry.
- DELETE - Remove an entry.
- PRINT - Display all entries.
- IMPORT - Import entries from a file.
- EXPORT - Export all entries to a file.
- SETUP - Configure general settings.
- CLEAR - Remove all entries.

[ ]>

mail3.example.com> commit
```

```

Please enter some comments describing your changes:

[]> Added username "user@example.net" to global unsubscribe

Do you want to save the current configuration for rollback? [Y]> n

Changes committed: Fri May 23 11:42:12 2014 GMT

```

Exporting and Importing a Global Unsubscribe File

Like the HAT, the RAT, smtproutes, static masquerading tables, alias tables, domain map tables, and altsrchoost entries, you can modify global unsubscribe entries by exporting and importing a file.

Procedure

-
- Step 1** Use the export subcommand of the unsubscribe command to export the existing entries to a file (whose name you specify).
 - Step 2** Outside of the CLI, get the file. (See [FTP, SSH, and SCP Access, on page 1261](#) for more information.)
 - Step 3** With a text editor, create new entries in the file.

Separate entries in the file by new lines. Return representations from all standard operating systems are acceptable (<CR>, <LF>, or <CR><LF>). Comment lines start with a number sign (#) and are ignored. For example, the following file excludes a single recipient email address (test@example.com), all recipients at a particular domain (@testdomain.com), all users with the same name at multiple domains (testuser@), and any recipients at a specific IP address (11.12.13.14).

```

# this is an example of the global_unsubscribe.txt file
test@example.com
@testdomain.com
testuser@
11.12.13.14

```

- Step 4** Save the file and place it in the configuration directory for the interface so that it can be imported. (See [FTP, SSH, and SCP Access, on page 1261](#) for more information.)
 - Step 5** Use the import subcommand of unsubscribe to import the edited file.
-

Review: Email Pipeline

The following tables provide an overview of how email is routed through the system, from reception to routing to deliver. Each feature is processed in order (from top to bottom) and is briefly summarized. Shaded areas in *Table - Email Pipeline for the Email Security Appliance: Routing and Delivery Features* represent processing that occurs in the Work Queue.

You can test most of the configurations of features in this pipeline using the trace command. For more information, see “Debugging Mail Flow Using Test Messages: Trace” in the Troubleshooting chapter.



Note For outgoing mail, Data Loss Prevention scanning takes place after the Outbreak Filters stage.

Table 64: Email Pipeline for the Email Security Appliance : Receiving Email Features

Feature	Description
Host Access Table (HAT)	ACCEPT, REJECT, RELAY, or TCPREFUSE connections
Host DNS Sender Verification	Maximum outbound connections Maximum concurrent inbound connections per IP address
Sender Groups	Maximum message size and messages per connection
Envelope Sender Verification	Maximum recipients per message and per hour
Sender Verification Exception Table	TCP listen queue size TLS: no/preferred/required
Mail Flow Policies	SMTP AUTH: no/preferred/required Drop email with malformed FROM headers Always accept or reject mail from entries in the Sender Verification Exception Table. SenderBase on/off (IP profiling/flow control)
Received Header	Adds a received header to accepted email: on/off.
Default Domain	Adds default domain for “bare” user addresses.
Bounce Verification	Used to verify incoming bounce messages as legitimate.
Domain Map	Rewrites the Envelope Recipient for each recipient in a message that matches a domain in the domain map table.
Recipient Access Table (RAT)	(Public listeners only) ACCEPT or REJECT recipients in RCPT TO plus Custom SMTP Response. Allow special recipients to bypass throttling.
Alias tables	Rewrites the Envelope Recipient. (Configured system-wide. aliasconfig is not a subcommand of listenerconfig .)
LDAP Recipient Acceptance	LDAP validation for recipient acceptance occurs within the SMTP conversation. If the recipient is not found in the LDAP directory, the message is dropped or bounced. LDAP validation can be configured to occur within the work queue instead.

Table 65: Email Pipeline for the Email Security Appliance: Routing and Delivery Features

Work Queue	LDAP Recipient Acceptance		LDAP validation for recipient acceptance occurs within the work queue. If the recipient is not found in the LDAP directory, the message is dropped or bounced. LDAP validation can be configured to occur within the SMTP conversation instead.
	Masquerading or LDAP Masquerading		Masquerading occurs in the work queue; it rewrites the Envelope Sender, To:, From:, and/or CC: headers, from a static table or via an LDAP query.
	LDAP Routing		LDAP queries are performed for message routing or address rewriting. Group LDAP queries work in conjunction with message filter rules mail-from-group and rcpt-to-group .
	Message Filters*		Message Filters are applied prior to message “splintering.” * Can send messages to quarantines.
	Anti-Spam**	Per Recipient Scanning	Anti-spam scanning engine examines messages and returns a verdict for further processing.
	Anti-Virus*		Anti-Virus scanning examines messages for viruses. Messages are scanned and optionally repaired, if possible. * Can send messages to quarantines.
	Advanced Malware Protection		Advanced Malware Protection performs file reputation scanning and file analysis, in order to detect malware in attachments.
	Content Filters*		Content Filters are applied. * Can send messages to quarantines.
	Outbreak Filters*		The Outbreak Filters feature helps protect against virus outbreaks. * Can send messages to quarantines.
	Virtual gateways		Sends mail over particular IP interfaces or groups of IP interfaces.
Delivery limits		1. Sets the default delivery interface. 2. Sets the total maximum number of outbound connections.	
Domain-based Limits		Defines, per-domain: maximum outbound connections for each virtual gateway and for the entire system; the bounce profile to use; the TLS preference for delivery: no/preferred/required	
Domain-based routing		Routes mail based on domain without rewriting Envelope Recipient.	
Global unsubscribe		Drops recipients according to specific list (configured system-wide).	
	Bounce profiles		Undeliverable message handling. Configurable per listener, per Destination Controls entry, and via message filters.

* These features can send messages to special queues called Quarantines.



CHAPTER 30

Integrating the Email Gateway with Cisco Advanced Phishing Protection

This chapter contains the following sections:

- [Overview of Cisco Advanced Phishing Protection, on page 739](#)
- [How to Integrate Email Gateway with the Cisco Advanced Phishing Protection Cloud Service, on page 740](#)
- [Advanced Phishing Protection and Clusters, on page 746](#)
- [Advanced Phishing Protection Report Page, on page 746](#)
- [Monitoring Message Metadata on the Cisco Advanced Phishing Protection Cloud Service, on page 747](#)
- [Displaying Messages Submitted to the Cisco Advanced Phishing Protection Cloud Service, on page 747](#)

Overview of Cisco Advanced Phishing Protection

Cisco Advanced Phishing Protection provides Business Email Compromise (BEC) and phishing detection capabilities. It detects identity deception-based threats by performing reputation checks on sender address by using advanced machine learning techniques and added intelligence. This intelligence continuously adapts to drive a real-time understanding of senders and provides enhanced protection.

The Advanced Phishing Protection engine on the email gateway checks the unique behavior of all legitimate senders, based on the historic email traffic to your organization. The cloud service interface of the Cisco Advanced Phishing Protection provides risk analysis to distinguish good messages from potentially malicious messages.

The Cisco Advanced Phishing Protection cloud service relies on the email gateway as a sensor engine to receive a copy of the message metadata sent inbound into your organization. This sensor engine collects metadata such as message headers from the email gateway and relay them to the Cisco Advanced Phishing Protection cloud service for analysis. After the analysis, potentially malicious messages are remediated from the recipient mailbox automatically, based on the pre-configured policies on the Advanced Phishing Protection cloud service.

The ability to use the email gateway as a sensor engine helps an organization to:

- Identify, investigate, and remediate threats observed on the message headers, from the recipient mailbox.
- View the reporting data of the metadata of the message from multiple email gateways in your organization.

Benefits of Cisco Advanced Phishing Protection

The following are the benefits of deploying Cisco Advanced Phishing Protection on the email gateway:

- The Sensor-based solution can be rapidly deployed to ensure that your users are fully protected from damaging breaches.
- Provides another layer of defense to more effectively secure your email environment.
- Gain a real-time understanding of senders, learn, and authenticate email identities and behavioral relationships to protect against BEC attacks.
- Automatically remove malicious emails from the recipient's inbox and calls out identity deception techniques to prevent wire fraud or other advanced attacks.
- Get detailed visibility into email attack activity, including total messages secured and attacks prevented.
- Prevents the following:
 - Attacks that use compromised accounts and social engineering.
 - Phishing, ransomware, zero-day attacks and spoofing.
 - BEC with no malicious payload or URL.

Workflow

1. Activate the license to access the Cisco Advanced Phishing Protection cloud service.
2. Set up the email gateway as a sensor engine on the Cisco Advanced Phishing Protection cloud service. This deploys the email gateway as a lightweight sensor via the cloud or on-premise.
3. Register the sensor engine on the email gateway with the Cisco Advanced Phishing Protection cloud service.
4. The sensor engine on the email gateway forwards the metadata of messages considered clean, to the Cisco Advanced Phishing Protection cloud service.
5. The Cisco Advanced Phishing Protection cloud service determines if the message metadata is malicious.
6. Pre-configured policies on the Cisco Advanced Phishing Protection cloud service, when configured with an 'Enforcement' sensor, blocks or redirects the message for further incident investigation.

How to Integrate Email Gateway with the Cisco Advanced Phishing Protection Cloud Service

Perform these steps in the following order:

Procedure

	Command or Action	Purpose
Step 1	Review the prerequisites.	Prerequisites, on page 741
Step 2	Obtain the provisioning key from Cisco Advanced Phishing Protection cloud service.	Obtaining the Provisioning Key from the Cisco Advanced Phishing Protection Cloud Service, on page 742
Step 3	Register your email gateway as a sensor engine with the Cisco Advanced Phishing Protection cloud service.	Registering the Cisco Advanced Phishing Protection Sensor on the Email Gateway, on page 742
Step 4	Enable Advanced Phishing Protection on the email gateway.	Enabling Advanced Phishing Protection on the Email Gateway, on page 743
Step 5	Obtaining API Access Keys from the Cisco Advanced Phishing Protection cloud service.	Obtaining API Access Keys from Cisco Advanced Phishing Protection Cloud Service, on page 744
Step 6	Configure incoming mail policies to enable forwarding of message metadata.	Configuring Incoming Mail Policies to Enable Forwarding of Message Metadata, on page 745
Step 7	Monitor metadata of message forwarded to the Advanced Phishing Protection Cloud Service.	Monitoring Message Metadata on the Cisco Advanced Phishing Protection Cloud Service, on page 746

Prerequisites

- [Activating the Account for Cisco Advanced Phishing Protection Cloud Service, on page 741](#)
- [Installing Sensors on the Cisco Advanced Phishing Protection Cloud Service, on page 741](#)

Activating the Account for Cisco Advanced Phishing Protection Cloud Service

Make sure that you have:

- Obtained a license to access the Cisco Advanced Phishing Protection cloud service from the following URL - <https://www.cisco.com/c/en/us/buy.html>.
- Activated your account using the activation link that you receive through an email notification to get provisioned with the Cisco Advanced Phishing Protection cloud service.

Installing Sensors on the Cisco Advanced Phishing Protection Cloud Service

Make sure that you have setup your email gateway as sensor engine as per your organizational requirements. For more information, see *User Guide for Cisco Advanced Phishing Protection*.

Obtaining the Provisioning Key from the Cisco Advanced Phishing Protection Cloud Service

Before you begin

Make sure that you have access to Cisco Advanced Phishing Protection cloud service with admin access rights. For more information, see [Prerequisites, on page 741](#). If you are unable to access the Cisco Advanced Phishing Protection cloud service, contact Cisco TAC for assistance.

Procedure

- Step 1** Log in to the Cisco Advanced Phishing Protection cloud service.
- Step 2** Choose **Manage > Sensors**.
- Step 3** Select **Installation > Download Sensor Installer**.
- Step 4** From the drop-down, select the sensor installation script configured as per your organizational requirements. For example: Cisco SEG.
- For more information, see [Installing Sensors on the Cisco Advanced Phishing Protection Cloud Service, on page 741](#).
- Step 5** Copy the 6-word provisioning key.

Use this provisioning key to configure the Cisco Email Security Gateway as a sensor.

Note To register the email gateway as a sensor, you must use the provisioning key within 7 days of generation.

What to do next

Register your email gateway with the Cisco Advanced Phishing Protection cloud service. For more information, see [Registering the Cisco Advanced Phishing Protection Sensor on the Email Gateway, on page 742](#).

Registering the Cisco Advanced Phishing Protection Sensor on the Email Gateway

Before you begin

Make sure that you have:

- A valid provisioning key to register your email gateway with the Advanced Phishing Protection cloud service. For more information, see [Obtaining the Provisioning Key from the Cisco Advanced Phishing Protection Cloud Service, on page 742](#).
- Opened HTTPS (In and Out) 443 port on the firewall for the FQDNs to register your email gateway with the Cisco Advanced Phishing Protection cloud service.

Procedure

- Step 1** Log in to the email gateway.
- Step 2** Go to **Security Services > Advanced Phishing Protection**.
- Step 3** Click **Register**.
- Step 4** From the URL drop-down, select the region of the Cisco Advanced Phishing Protection cloud service.
- Step 5** Enter the 6-word provisioning key obtained from the Advanced Phishing Protection cloud service.
- Step 6** Click **Register** to submit your changes.

The Cisco Advanced Phishing Protection cloud service generates a Universally Unique ID (UUID) after you register your email gateway with the sensor.

Note After successful registration, the Cisco Advanced Phishing Protection cloud service identifies the email gateway's hostname in the cloud service.

What to do next

Enable Cisco Advanced Phishing Protection engine on the email gateway. For more information, see [Enabling Advanced Phishing Protection on the Email Gateway, on page 743](#).

Enabling Advanced Phishing Protection on the Email Gateway

Before you begin

Make sure that you have registered your email gateway as a sensor on the Cisco Advanced Phishing Protection cloud service. For more information, see [Registering the Cisco Advanced Phishing Protection Sensor on the Email Gateway, on page 742](#).

Procedure

- Step 1** Log in to the email gateway.
- Step 2** Go to **Security Services > Advanced Phishing Protection**.
- Step 3** Click **Enable**.
- Step 4** Commit your changes.
-

What to do next

Enable forwarding of message metadata to the Cisco Advanced Phishing Protection cloud service. For more information, see [Configuring Incoming Mail Policies to Enable Forwarding of Message Metadata, on page 745](#).

Obtaining API Access Keys from Cisco Advanced Phishing Protection Cloud Service

You can use the API access keys to perform the following tasks in your email gateway:

- Send email notification alerts about APP license expiry details to users.
- View total number of messages that are sent from all email gateways at the organizational level to the Cisco Advanced Phishing Protection cloud service in a dashboard widget. The dashboard widget is available on the Advanced Phishing Protection report page of the new web interface.

Before you begin

Make sure that you have:

- Registered the email gateway as a sensor on the Cisco Advanced Phishing Protection cloud service. For more information, see [Registering the Cisco Advanced Phishing Protection Sensor on the Email Gateway, on page 742](#).
- Enabled Advanced Phishing Protection on the email gateway. For more information, see [Enabling Advanced Phishing Protection on the Email Gateway, on page 743](#).

Procedure

- Step 1** Log in to the Cisco Advanced Phishing Protection cloud service.
- Step 2** Choose **Manage > Users**.
- Step 3** Click the required username.
- Step 4** Click **Generate API Secret** link to generate the API Access keys.
- Step 5** Copy the **API Access UID** and **API Access Secret** keys locally on your system.

Note In case if you do not copy the API Access keys and close the Cisco Advanced Phishing Protection cloud service, you need to follow steps **1-3** of the procedure and click **Regenerate API Secret** link to obtain new API Access keys.

- Step 6** Log in to the legacy web interface of your email gateway.
- Step 7** Go to **Security Services > Advanced Phishing Protection**.
- Step 8** Click **Edit Settings** under 'Advanced Phishing Protection API Access' section.
- Step 9** Enter the **API Access UID** key in the 'API Access UID' field.
- Step 10** Enter the **API Access Secret** key in the 'API Access key field'.
- Step 11** Click **Submit**.
-

What to do next

Enable forwarding of message metadata to the Cisco Advanced Phishing Protection cloud service. For more information, see [Configuring Incoming Mail Policies to Enable Forwarding of Message Metadata, on page 745](#).

Configuring Incoming Mail Policies to Enable Forwarding of Message Metadata

You can configure mail policies to enable forwarding of message metadata to the Cisco Advanced Phishing Protection cloud service.

When you enable the Cisco Advanced Phishing Protection cloud service on your email gateway, the following message headers are shared with the Cisco Advanced Phishing Protection Cloud service :

- dkim_selector
- last_hop_ip_address
- helo_domain
- dkim_result
- dkim_domain
- dmarc_result
- dkim_signatures
- to_header
- header_subject
- header_from
- message_id
- spf_result
- rcpt_to
- full_header_from
- mail_from
- Received-SPF
- Received-Header
- Authentication-Results
- reply_to
- original_sender
- received-timestamps
- Authentication-Results-original
- X-originating-ip

Before you begin

Make sure that you have:

- Registered the email gateway as a sensor on the Cisco Advanced Phishing Protection cloud service. For more information, see [Registering the Cisco Advanced Phishing Protection Sensor on the Email Gateway, on page 742](#).

- Enabled Advanced Phishing Protection on the email gateway. For more information, see [Enabling Advanced Phishing Protection on the Email Gateway, on page 743](#).

Procedure

- Step 1** Log in to the email security gateway.
 - Step 2** Go to **Mail Policies > Incoming Mail Policies**.
 - Step 3** Click the link below APP Filter.
 - Step 4** Select **Enable Advanced Phishing Protection (Customize Settings)** from the drop-down list.
 - Step 5** Select the check box for **Enable Forwarding**.
 - Step 6** Click **Submit** and commit your changes.
-

Monitoring Message Metadata on the Cisco Advanced Phishing Protection Cloud Service

You can monitor metadata of the message that your email security gateway forwards to the Cisco Advanced Phishing Protection cloud service. The **Analyze > Messages** page of the cloud service provides insights on the source of the message and the risk associated with the message and the senders.

The metadata of the message on the Cisco Advanced Phishing Protection cloud service receives a trust score based on the following:

- Message Authenticity
- Domain Reputation
- Sender Legitimacy

Advanced Phishing Protection and Clusters

If you use centralized management, you can enable the Advanced Phishing Protection at the cluster, group, and machine level. If you have registered your email gateway with the Cisco Advanced Phishing Protection cloud service in standalone mode, you can choose to join a cluster registered with the Cisco Advanced Phishing Protection cloud service.



Note

When you disable the Advanced Phishing Protection at the machine level, the same is disabled on the group and cluster levels.

Advanced Phishing Protection Report Page

The **Monitor > Advanced Phishing Protection** report page displays the following:

- Total number of messages successfully forwarded to the Cisco Advanced Phishing Protection cloud service.
- Total number of messages that are not forwarded to the Cisco Advanced Phishing Protection cloud service.



Note If the forwarding of message metadata has failed, you must validate the configurations of the Advanced Phishing Protection feature. For more information, see [How to Integrate Email Gateway with the Cisco Advanced Phishing Protection Cloud Service, on page 740](#).

You can use the Advanced Phishing Protection report page to view:

- Total number of messages attempted to be forwarded to the Cisco Advanced Phishing Protection cloud service, in a graphical format.
- Summary of messages forwarded to the Cisco Advanced Phishing Protection cloud service in a graphical format.

To view the detailed information on the metadata of the message that is forwarded to the Cisco Advanced Phishing Protection cloud service, click on the link and login to the Cisco Advanced Phishing Protection cloud service. For more information, see [Monitoring Message Metadata on the Cisco Advanced Phishing Protection Cloud Service, on page 746](#).

Monitoring Message Metadata on the Cisco Advanced Phishing Protection Cloud Service

You can monitor metadata of the message that your email security gateway forwards to the Cisco Advanced Phishing Protection cloud service. The Analyze > Messages page of the cloud service provides insights on the source of the message and the risk associated with the message and the senders.

The metadata of the message on the Cisco Advanced Phishing Protection cloud service receives a trust score based on the following:

- Message Authenticity
- Domain Reputation
- Sender Legitimacy

Displaying Messages Submitted to the Cisco Advanced Phishing Protection Cloud Service

You can view the metadata of the message that you forward to the Cisco Advanced Phishing Protection cloud service corresponding to the success and failure.

Before you begin

Make sure that you enable the Message Tracking feature on the email gateway. To enable Message Tracking, go to **Security Services > Centralized Services > Message Tracking** page in the web interface.

Procedure

- Step 1** Log in to the email security gateway.
 - Step 2** Go to **Monitor > Message Tracking**.
 - Step 3** Click **Advanced**.
 - Step 4** Check **Advanced Phishing Protection Forwarding** under Message Event.
 - Step 5** (Optional) Select **Select Successful** to view messages that are forwarded successfully to the Cisco Advanced Phishing Protection cloud service.
 - Step 6** (Optional) Select **Failed** to view messages that are not forwarded to the Cisco Advanced Phishing Protection cloud service.
 - Step 7** Click **Search**.
-



CHAPTER 31

LDAP Queries

This chapter contains the following sections:

- [Overview of LDAP Queries, on page 749](#)
- [Working with LDAP Queries, on page 759](#)
- [Using Acceptance Queries For Recipient Validation, on page 766](#)
- [Using Routing Queries to Send Mail to Multiple Target Addresses, on page 767](#)
- [Using Masquerading Queries to Rewrite the Envelope Sender, on page 768](#)
- [Using Group LDAP Queries to Determine if a Recipient is a Group Member, on page 770](#)
- [Using Domain-based Queries to Route to a Particular Domain, on page 773](#)
- [Using Chain Queries to Perform a Series of LDAP Queries, on page 774](#)
- [Using LDAP For Directory Harvest Attack Prevention, on page 776](#)
- [Configuring AsyncOS for SMTP Authentication, on page 778](#)
- [Configuring External LDAP Authentication for Users, on page 786](#)
- [Authenticating End-Users of the Spam Quarantine, on page 789](#)
- [Spam Quarantine Alias Consolidation Queries, on page 790](#)
- [Sample User Distinguished Name Settings, on page 792](#)
- [Configuring AsyncOS To Work With Multiple LDAP Servers, on page 792](#)
- [Performing Recipient Verification and Resolving Group Queries using Azure AD Domain Services , on page 793](#)
- [Testing Servers and Queries, on page 793](#)

Overview of LDAP Queries

It is recommended that you avoid changing LDAP settings on Cloud Email Security appliances .

If you store user information within LDAP directories in your network infrastructure — for example, in Microsoft Active Directory, SunONE Directory Server, or OpenLDAP directories — you can configure the appliance to query your LDAP servers to accept, route, and authenticate messages. You can configure the appliance to work with one or multiple LDAP servers.

The following section provides an overview on the types of LDAP queries you can perform; how LDAP works with the appliance to authenticate, accept, and route messages; and how to configure your appliance to work with LDAP.

Related Topics

- [Understanding LDAP Queries, on page 750](#)
- [Understanding How LDAP Works with AsyncOS, on page 751](#)
- [Configuring the Cisco IronPort Appliance to Work with an LDAP Server, on page 752](#)
- [Creating LDAP Server Profiles to Store Information About the LDAP Server, on page 753](#)
- [Testing LDAP Servers, on page 754](#)
- [Enabling LDAP Queries to Run on a Particular Listener, on page 754](#)
- [Enhanced Support for Microsoft Exchange 5.5, on page 757](#)

Understanding LDAP Queries

If you store user information within LDAP directories in your network infrastructure, you can configure the appliance to query your LDAP server for the following purposes:

- **Acceptance Queries.** You can use your existing LDAP infrastructure to define how the recipient email address of incoming messages (on a public listener) should be handled. For more information, see [Using Acceptance Queries For Recipient Validation, on page 766](#).
- **Routing (Aliasing).** You can configure the appliance to route messages to the appropriate address and/or mail host based upon the information available in LDAP directories on your network. For more information, see [Using Routing Queries to Send Mail to Multiple Target Addresses, on page 767](#).
- **Certificate Authentication.** You can create a query that checks the validity of a client certificate in order to authenticate an SMTP session between the user's mail client and the appliance. For more information, see [Checking the Validity of a Client Certificate, on page 799](#).
- **Masquerading.** You can masquerade Envelope Senders (for outgoing mail) and message headers (for incoming mail, such as To:, Reply To:, From: or CC:). For more information about masquerading, see [Using Masquerading Queries to Rewrite the Envelope Sender, on page 768](#).
- **Group Queries.** You can configure the appliance to perform actions on messages based on the groups in the LDAP directory. You do this by associating a group query with a message filter. You can perform any message action available for message filters on messages that match the defined LDAP group. For more information, see [Using Group LDAP Queries to Determine if a Recipient is a Group Member, on page 770](#).
- **Domain-based Queries.** You can create domain-based queries to allow the appliance to perform different queries for different domains on a single listener. When the appliance runs the domain-based queries, it determines the query to use based on the domain, and it queries the LDAP server associated with that domain.
- **Chain Queries.** You can create a chain query to enable the appliance to perform a series of queries in sequence. When you configure a chain query, the appliance runs each query in sequence until the LDAP appliance returns a positive result. For chained routing queries, the appliance re-runs the same configured chain query in sequence for each rewritten email address.
- **Directory Harvest Prevention.** You can configure the appliance to combat directory harvest attacks using your LDAP directories. You can configure directory harvest prevention during the SMTP conversation or within the work queue. If the recipient is not found in the LDAP directory, you can configure the system to perform a delayed bounce or drop the message entirely. Consequently, spammers are not able to differentiate between valid and invalid email addresses. See [Using LDAP For Directory Harvest Attack Prevention, on page 776](#).
- **SMTP Authentication.** AsyncOS provides support for SMTP authentication. SMTP Auth is a mechanism for authenticating clients connected to an SMTP server. You can use this functionality to enable users at your organization to send mail using your mail servers even if they are connecting remotely (e.g. from

home or while traveling). For more information, see [Configuring AsyncOS for SMTP Authentication, on page 778](#).

- **External Authentication.** You can configure your appliance to use your LDAP directory to authenticate users logging in to the appliance. For more information, see [Configuring External LDAP Authentication for Users, on page 786](#).
- **Spam Quarantine End-User Authentication.** You can configure your appliance to validate users when they log in to the end-user quarantine. For more information, see [Authenticating End-Users of the Spam Quarantine, on page 789](#).
- **Spam Quarantine Alias Consolidation.** If you use email notifications for spam, this query consolidates the end-user aliases so that end-users do not receive quarantine notices for each aliased email address. For more information, see [Spam Quarantine Alias Consolidation Queries, on page 790](#).

Understanding How LDAP Works with AsyncOS

When you work with LDAP directories, the appliance can be used in conjunction with an LDAP directory server to accept recipients, route messages, and/or masquerade headers. LDAP group queries can also be used in conjunction with message filters to create rules for handling messages as they are received by the appliance.

The following figure demonstrates how the appliance works with LDAP:

Figure 58: LDAP Configuration

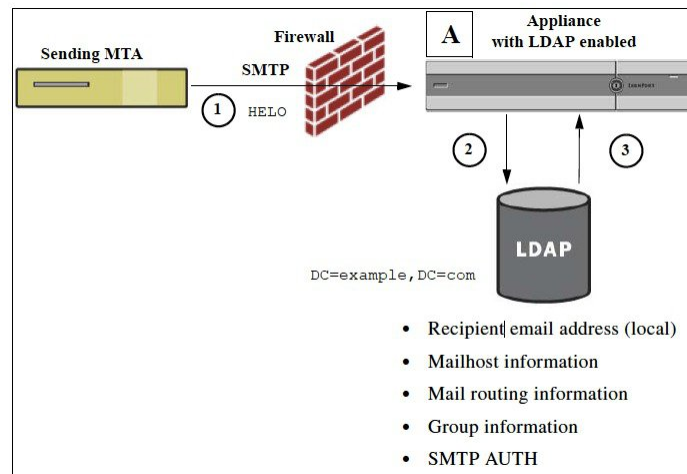

1. The sending MTA sends a message to the public listener “A” via SMTP.
2. The appliance queries the LDAP server defined via the **System Administration > LDAP** page (or by the global `ldapconfig` command).
3. Data is received from the LDAP directory, and, depending on the queries defined on the **System Administration > LDAP** page (or in the `ldapconfig` command) that are used by the listener:
 - the message is routed to the new recipient address, or dropped or bounced
 - the message is routed to the appropriate mailhost for the new recipient
 - From:, To:, and CC: message headers are re-written based upon the query
 - further actions as defined by `rcpt-to-group` or `mail-from-group` message filter rules (used in conjunction with configured group queries).



Note You can configure your appliance to connect to multiple LDAP servers. When you do this, you can configure the LDAP profile settings for load-balancing or failover. For more information about working with multiple LDAP servers, see [Configuring AsyncOS To Work With Multiple LDAP Servers, on page 792](#).

Configuring the Cisco IronPort Appliance to Work with an LDAP Server

When you configure your appliance to work with an LDAP directory, you must complete the following steps to configure your AsyncOS appliance for acceptance, routing, aliasing, and masquerading:

Procedure

Step 1 **Configure LDAP server profiles.** The server profile contains information to enable AsyncOS to connect to the LDAP server (or servers), such as:

- the name of the server (s) and port to send queries,
- the base DN, and
- the authentication requirements for binding to the server

For more information about configuring a server profile, see [Creating LDAP Server Profiles to Store Information About the LDAP Server, on page 753](#).

When you configure the LDAP server profile, you can configure AsyncOS to connect to one or multiple LDAP servers.

For information about configuring AsyncOS to connect to multiple servers, see [Configuring AsyncOS To Work With Multiple LDAP Servers, on page 792](#).

Step 2 **Configure the LDAP query.** You configure the LDAP queries on the LDAP server profile. The query you configure should be tailored to your particular LDAP implementation and schema.

For information on the types of LDAP queries you can create, see [Understanding LDAP Queries, on page 750](#).

For information on writing queries, see [Working with LDAP Queries, on page 759](#).

Step 3 **Enable the LDAP server profile on a public listener or on a private listener.** You must enable the LDAP server profile on a listener to instruct the listener to run the LDAP query when accepting, routing, or sending a message.

For more information, see [Enabling LDAP Queries to Run on a Particular Listener, on page 754](#).

Note When you configure a group query, you need to take additional steps to configure AsyncOS to work with the LDAP server. For information on configuring a group query, see [Using Group LDAP Queries to Determine if a Recipient is a Group Member, on page 770](#). When you configure an end-user authentication or spam notification consolidation query, you must enable LDAP end-user access to the Spam Quarantine. For more information on the Spam Quarantine, see the Spam Quarantine chapter.

Creating LDAP Server Profiles to Store Information About the LDAP Server

When you configure AsyncOS to use LDAP directories, you create an LDAP server profile to store the information about the LDAP server.

Procedure

-
- Step 1** On the **System Administration > LDAP** page, click **Add LDAP Server Profile**.
- Step 2** Enter a name for the server profile.
- Step 3** Enter the host name for the LDAP server.
- You can enter multiple host names to configure the LDAP servers for failover or load-balancing. Separate multiple entries with commas. For more information, see [Configuring AsyncOS To Work With Multiple LDAP Servers, on page 792](#).
- Step 4** Select an authentication method. You can use anonymous authentication or specify a username and passphrase.
- Step 5** Select the LDAP server type: Active Directory, OpenLDAP, or Unknown or Other.
- Step 6** Enter a port number.
- The default port is 3268 without SSL and 3269 with SSL for Active Directory or any Unknown / Other server types.
- The default port is 389 without SSL and 636 with SSL, for Open LDAP server types.
- Step 7** Enter a Base DN (distinguishing name) for the LDAP server.
- If you authenticate with a username and a passphrase, the username must include the full DN to the entry that contains the passphrase. For example, a user is a member of the marketing group with an email address of joe@example.com. The entry for this user would look like the following entry:
- ```
uid=joe, ou=marketing, dc=example dc=com
```
- Step 8** Select whether to use SSL when communicating with the LDAP server.
- Step 9** Under Advanced, enter cache time-to-live. This value represents the amount of time to retain caches.
- Step 10** Enter the maximum number of retained cache entries.
- Note** This cache is maintained per LDAP server. If you are configuring more than one LDAP servers, you must set a smaller LDAP cache value for better performance. Also, if the memory usage of various processes in the appliance is high, increasing this value may reduce the system performance.
- Step 11** Enter the number of simultaneous connections.
- If you configure the LDAP server profile for load balancing, these connections are distributed among the listed LDAP servers. For example, if you configure 10 simultaneous connections and load balance the connections over three servers, AsyncOS creates 10 connections to each server, for a total of 30 connections.
- Note** The maximum number of simultaneous connections includes LDAP connections used for LDAP queries. However, the appliance may open more connections if you use LDAP authentication for the Spam Quarantine.
- You can configure the maximum time (in seconds) for which the connections to the LDAP server must persist before the connections reset. Choose a value between 60 and 86400.

- Step 12** Test the connection to the server by clicking the Test Server(s) button. If you specified multiple LDAP servers, they are all tested. The results of the test appear in the Connection Status field. For more information, see [Testing LDAP Servers, on page 754](#).
- Step 13** Create queries by marking the checkbox and completing the fields. You can select Accept, Routing, Masquerade, Group, SMTP Authentication, External Authentication, Spam Quarantine End-User Authentication, and Spam Quarantine Alias Consolidation.
- Note** To allow the appliance to run LDAP queries when you receive or send messages, you must enable the LDAP query on the appropriate listener. For more information, see [Enabling LDAP Queries to Run on a Particular Listener, on page 754](#).
- Step 14** Test a query by clicking the **Test Query** button.
- Enter the test parameters and click Run Test. The results of the test appear in the Connection Status field. If you make any changes to the query definition or attributes, click **Update**. For more information, see [Testing LDAP Servers, on page 754](#).
- Note** If you have configured the LDAP server to allow binds with empty passphrases, the query can pass the test with an empty passphrase field.
- Step 15** Submit and commit your changes.
- Note** Although the number of server configurations is unlimited, you can configure only one recipient acceptance, one routing, one masquerading, and one group query per server.
- 

## Testing LDAP Servers

Use the Test Server(s) button on the Add/Edit LDAP Server Profile page (or the test subcommand of the ldapconfig command in the CLI) to test the connection to the LDAP server. AsyncOS displays a message stating whether the connection to the server port succeeded or failed. If you configured multiple LDAP servers, AsyncOS tests each server and displays individual results.

## Enabling LDAP Queries to Run on a Particular Listener

To allow the appliance to run LDAP queries when you receive or send messages, you must enable the LDAP query on the appropriate listener.

### Related Topics

- [Configuring Global Settings for LDAP Queries, on page 754](#)
- [Example of Creating an LDAP Server Profile, on page 755](#)
- [Enabling LDAP Queries on a Public Listener, on page 756](#)
- [Enabling LDAP Queries on a Private Listener, on page 756](#)

## Configuring Global Settings for LDAP Queries

The LDAP global settings define how the appliance handles all LDAP traffic.



## Procedure

- Step 1** On the **System Administration > LDAP** page, click **Edit Settings**.
- Step 2** Select the IP interface to use for LDAP traffic. The appliance automatically chooses an interface by default.
- Step 3** Select the TLS certificate to use for the LDAP interface (TLS certificates added via the **Network > Certificates** page or the `certconfig` command in the CLI are available in the list, see [Overview of Encrypting Communication with Other MTAs, on page 651](#)).
- Step 4** Select appropriate option, if you want to validate the LDAP server certificate.
- Step 5** Submit and commit your changes.

## Example of Creating an LDAP Server Profile

In the following example, the System Administration > LDAP page is used to define an LDAP server for the appliance to bind to, and queries for recipient acceptance, routing, and masquerading are configured.



- Note** There is a 60 second connection attempt time-out for LDAP connections (which covers the DNS lookup, the connection itself, and, if applicable, the authentication bind for the appliance itself). After the first failure, AsyncOS immediately starts trying other hosts in the same server (if you specified more than one in the comma separated list). If you only have one host in the server, AsyncOS continues attempting to connect to it.

**Figure 59: Configuring an LDAP Server Profile (1 of 2)**

| LDAP Server Settings      |                                                                                                                                                                                                                                                                                                                                |
|---------------------------|--------------------------------------------------------------------------------------------------------------------------------------------------------------------------------------------------------------------------------------------------------------------------------------------------------------------------------|
| Server Attributes         |                                                                                                                                                                                                                                                                                                                                |
| LDAP Server Profile Name: | PublicLDAP                                                                                                                                                                                                                                                                                                                     |
| Host Name(s):             | myldapserver.example.com<br><small>Fully qualified hostname or IP, separate multiple entries with a comma</small>                                                                                                                                                                                                              |
| Authentication Method:    | <input type="radio"/> Anonymous<br><input checked="" type="radio"/> Use Password<br>Username: cn=anonymous<br>Password: *****                                                                                                                                                                                                  |
| Server Type: ?            | Active Directory                                                                                                                                                                                                                                                                                                               |
| Port: ?                   | 3268                                                                                                                                                                                                                                                                                                                           |
| Base DN: ?                | dc=example, dc=com                                                                                                                                                                                                                                                                                                             |
| Connection Protocol:      | <input type="checkbox"/> Use SSL                                                                                                                                                                                                                                                                                               |
| Advanced:                 | Cache TTL (time-to-live): 900 Seconds<br>Maximum Retained Cache Entries: 10000<br>Maximum number of simultaneous connections for each host: 10<br>Multiple host options:<br><input checked="" type="radio"/> Load-balance connections among all hosts listed<br><input type="radio"/> Failover connections in the order listed |
| Server Attribute Testing: | Test Server(s)                                                                                                                                                                                                                                                                                                                 |

First, the nickname of “PublicLDAP” is given for the myldapserver.example.com LDAP server. The number of connections is set to 10 (the default), and the multiple LDAP server (hosts) load balance option is left as the default. You can specify multiple hosts here by providing a comma separated list of names. Queries are directed to port 3268 (the default). SSL is not enabled as the connection protocol for this host. The base DN of example.com is defined ( dc=example,dc=com ). The cache time-to-live is set to 900 seconds, the maximum number of cache entries is 10000, and the authentication method is set to passphrase.

Queries for recipient acceptance, mail routing, and masquerading are defined. Remember that query names are case-sensitive and must match exactly in order to return the proper results.

Figure 60: Configuring an LDAP Server Profile (2 of 2)

|                                                                                                                     |                                                                                                                            |
|---------------------------------------------------------------------------------------------------------------------|----------------------------------------------------------------------------------------------------------------------------|
| <input checked="" type="checkbox"/> Accept Query                                                                    |                                                                                                                            |
| Name:                                                                                                               | PublicLDAP.accept                                                                                                          |
| Query String:                                                                                                       | {proxyAddresses=smtp:{a}} <a href="#">Test Query</a>                                                                       |
| <input checked="" type="checkbox"/> Routing Query                                                                   |                                                                                                                            |
| Name:                                                                                                               | PublicLDAP.routing                                                                                                         |
| Query String:                                                                                                       | {mailLocalAddress={a}} <a href="#">Test Query</a>                                                                          |
| Recipient Email to Rewrite the Envelope Header:                                                                     | mailRoutingAddress                                                                                                         |
| Alternative Mailhost Attribute:                                                                                     | mailHost                                                                                                                   |
| SMTP Call-Ahead Server Attribute (optional):                                                                        | <small>This attribute is used only if an SMTP Call-Ahead server is configured. Go to Network &gt; SMTP Call-Ahead.</small> |
| <input checked="" type="checkbox"/> Masquerade Query                                                                |                                                                                                                            |
| Name:                                                                                                               | PublicLDAP.masquerade                                                                                                      |
| Query String:                                                                                                       | {mailRoutingAddress={a}} <a href="#">Test Query</a>                                                                        |
| Attribute Containing Externally Visible Full Email Address:                                                         | mailLocalAddress                                                                                                           |
| Do you want the results of the returned attribute to replace the entire friendly portion of the original recipient? | <input checked="" type="radio"/> Yes<br><input type="radio"/> No                                                           |

## Enabling LDAP Queries on a Public Listener

In this example, the public listener “InboundMail” is updated to use LDAP queries for recipient acceptance. Further, recipient acceptance is configured to happen during the SMTP conversation (for more information, see [Using Acceptance Queries For Recipient Validation, on page 766](#) for more information).

Figure 61: Enabling Acceptance and Routing Queries on a Listener

|                                                                                                                                                                                        |                                   |
|----------------------------------------------------------------------------------------------------------------------------------------------------------------------------------------|-----------------------------------|
| LDAP Queries:                                                                                                                                                                          | Accept                            |
| Accept Query:                                                                                                                                                                          | exampleTest.accept                |
| <input type="radio"/> Work Queue                                                                                                                                                       |                                   |
| Non-Matching Recipients:                                                                                                                                                               | Bounce                            |
| <input checked="" type="radio"/> SMTP Conversation                                                                                                                                     |                                   |
| If the LDAP server is unreachable:                                                                                                                                                     |                                   |
| <input type="radio"/> Allow Mail in<br><input checked="" type="radio"/> Drop Connection, return error code:                                                                            |                                   |
| Code:                                                                                                                                                                                  | 451                               |
| Text:                                                                                                                                                                                  | Temporary recipient validation er |
| When the Directory Harvest Attack Prevention threshold (maximum invalid recipients per hour) is reached:                                                                               |                                   |
| Code:                                                                                                                                                                                  | 550                               |
| Text:                                                                                                                                                                                  | Too many invalid recipients       |
| <input checked="" type="checkbox"/> Drop Connection if the Directory Harvest Attack Prevention threshold (maximum invalid recipients per hour) is reached within an SMTP conversation. |                                   |
| <a href="#">Routing</a><br><a href="#">Masquerade</a><br><a href="#">Group</a>                                                                                                         |                                   |

## Enabling LDAP Queries on a Private Listener

In this example, the private listener “OutboundMail” is updated to use LDAP queries for masquerading. The masqueraded fields include: From, To, CC, and Reply-To.

Figure 62: Enabling a Masquerading Query on a Listener

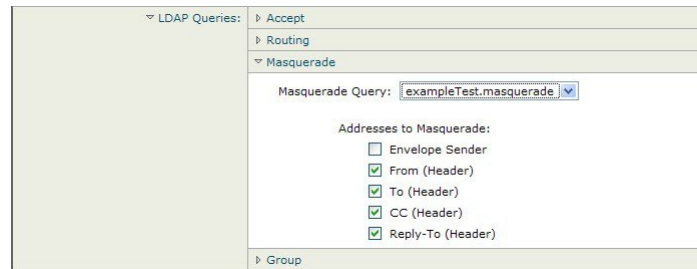

## Enhanced Support for Microsoft Exchange 5.5

AsyncOS includes a configuration option to provide support for Microsoft Exchange 5.5. If you use a later version of Microsoft Exchange, you do not need to enable this option. When configuring an LDAP server, you can elect to enable Microsoft Exchange 5.5 support by answering “y” when prompted in the `ldapconfig` `-> edit -> server -> compatibility` subcommand (this is only available via the CLI):

```
mail3.example.com> ldapconfig
```

```
Current LDAP server configurations:
```

```
1. PublicLDAP: (ldapexample.com:389)
```

```
Choose the operation you want to perform:
```

- NEW - Create a new server configuration.
- EDIT - Modify a server configuration.
- DELETE - Remove a server configuration.

```
[]> edit
```

```
Enter the name or number of the server configuration you wish to edit.
```

```
[]> 1
```

```
Name: PublicLDAP
```

```
Hostname: ldapexample.com Port 389
```

```
Authentication Type: anonymous
```

```
Base: dc=ldapexample,dc=com
```

```
Choose the operation you want to perform:
```

- SERVER - Change the server for the query.
- LDAPACCEPT - Configure whether a recipient address should be accepted or bounced/dropped.
- LDAPROUTING - Configure message routing.
- MASQUERADE - Configure domain masquerading.

- LDAPGROUP - Configure whether a sender or recipient is in a specified group.
- SMTPAUTH - Configure SMTP authentication.

[ ]> server

Name: PublicLDAP

Hostname: ldapexample.com Port 389

Authentication Type: anonymous

Base: dc=ldapexample,dc=com

Microsoft Exchange 5.5 Compatibility Mode: Disabled

Choose the operation you want to perform:

- NAME - Change the name of this configuration.
- HOSTNAME - Change the hostname used for this query.
- PORT - Configure the port.
- AUTHTYPE - Choose the authentication type.
- BASE - Configure the query base.
- COMPATIBILITY - Set LDAP protocol compatibility options.

[ ]> compatibility

Would you like to enable Microsoft Exchange 5.5 LDAP compatibility mode? (This is not recommended for versions of Microsoft Exchange later than 5.5, or other LDAP servers.)

[N]> y

Do you want to configure advanced LDAP compatibility settings? (Typically not required)

[N]>

Name: PublicLDAP

Hostname: ldapexample.com Port 389

Authentication Type: anonymous

Base: dc=ldapexample,dc=com

Microsoft Exchange 5.5 Compatibility Mode: Enabled (attribute "objectClass")

Choose the operation you want to perform:

- NAME - Change the name of this configuration.
- HOSTNAME - Change the hostname used for this query.
- PORT - Configure the port.
- AUTHTYPE - Choose the authentication type.
- BASE - Configure the query base.

```
- COMPATIBILITY - Set LDAP protocol compatibility options.
[]>
```

## Working with LDAP Queries

You create an entry in the LDAP server profile for each type of LDAP query you want to perform. When you create LDAP queries, you must enter the query syntax for your LDAP server. Please note that the queries you construct should be tailored and specific to your particular implementation of LDAP directory services, particularly if you have extended your directory with new object classes and attributes to accommodate the unique needs of your directory.

### Related Topics

- [Types of LDAP Queries, on page 759](#)
- [Base Distinguishing Name \(DN\), on page 760](#)
- [LDAP Query Syntax, on page 760](#)
- [Secure LDAP \(SSL\), on page 761](#)
- [Routing Queries, on page 761](#)
- [Allowing Clients to Bind to the LDAP Server Anonymously , on page 761](#)
- [Testing LDAP Queries, on page 764](#)
- [Troubleshooting Connections to LDAP Servers, on page 765](#)

## Types of LDAP Queries

- **Acceptance queries.** For more information, see [Using Acceptance Queries For Recipient Validation, on page 766](#).
- **Routing queries.** For more information, see [Using Routing Queries to Send Mail to Multiple Target Addresses, on page 767](#).
- **Certificate Authentication queries.** For more information, see [Checking the Validity of a Client Certificate, on page 799](#).
- **Masquerading queries.** For more information, see [Using Masquerading Queries to Rewrite the Envelope Sender, on page 768](#).
- **Group queries.** For more information, see [Using Group LDAP Queries to Determine if a Recipient is a Group Member, on page 770](#).
- **Domain-based queries.** For more information, see [Using Domain-based Queries to Route to a Particular Domain, on page 773](#).
- **Chain queries.** For more information, see [Using Chain Queries to Perform a Series of LDAP Queries, on page 774](#).

You can also configure queries for the following purposes:

- **Directory harvest prevention.** For more information, see [Understanding LDAP Queries, on page 750](#).
- **SMTP authentication.** For more information, see [Configuring AsyncOS for SMTP Authentication, on page 778](#).
- **External authentication.** For more information, see [Configuring External LDAP Authentication for Users, on page 786](#).
- **Spam quarantine end-user authentication query.** For more information, see [Authenticating End-Users of the Spam Quarantine, on page 789](#).

- **Spam quarantine alias consolidation query.** For more information, see [Spam Quarantine Alias Consolidation Queries, on page 790](#).

The search queries you specify are available to all listeners you configure on the system.

## Base Distinguishing Name (DN)

The root level of the directory is called the base. The name of the base is the DN (distinguishing name). The base DN format for Active Directory (and the standard as per RFC 2247) has the DNS domain translated into domain components (dc=). For example, example.com's base DN would be: dc=example, dc=com. Note that each portion of the DNS name is represented in order. This may or may not reflect the LDAP settings for your configuration.

If your directory contains multiple domains you may find it inconvenient to enter a single BASE for your queries. In this case, when configuring the LDAP server settings, set the base to NONE. This will, however, make your searches inefficient.

## LDAP Query Syntax

Spaces are allowed in LDAP paths, and they do not need to be quoted. The CN and DC syntax is not case-sensitive.

Cn=First Last,oU=user,dc=domain,DC=COM

The variable names you enter for queries are *case-sensitive* and must match your LDAP implementation in order to work correctly. For example, entering **mailLocalAddress** at a prompt performs a different query than entering **maillocaladdress**.

### Related Topics

- [Tokens:, on page 760](#)

## Tokens:

You can use the following tokens in your LDAP queries:

- {a} username@domainname
- {d} domainname
- {dn} distinguished name
- {g} groupname
- {u} username
- {f} MAIL FROM: address



---

**Note** The {f} token is valid in acceptance queries only.

---

For example, you might use the following query to accept mail for an Active Directory LDAP server:

```
((mail={a})(proxyAddresses=smtp:{a}))
```



**Note** Cisco Systems strongly recommends using the Test feature of the LDAP page (or the **test** subcommand of the **ldapconfig** command) to test all queries you construct and ensure that expected results are returned *before* you enable LDAP functionality on a listener. See [Testing LDAP Queries, on page 764](#) for more information.

## Secure LDAP (SSL)

You can use instruct AsyncOS to use SSL when communicating with the LDAP server. If you configure your LDAP server profile to use SSL:

- AsyncOS will use the LDAPS certificate configured via certconfig in the CLI (see [Creating a Self-Signed Certificate , on page 654](#)).

You may have to configure your LDAP server to support using the LDAPS certificate.

- If an LDAPS certificate has not been configured, AsyncOS will use the demo certificate.

## Routing Queries

There is no recursion limit for LDAP routing queries; the routing is completely data driven. However, AsyncOS does check for circular reference data to prevent the routing from looping infinitely.

## Allowing Clients to Bind to the LDAP Server Anonymously

You may need to configure your LDAP directory server to allow for anonymous queries. (That is, clients can bind to the server anonymously and perform queries.) For specific instructions on configuring Active Directory to allow anonymous queries, see the “Microsoft Knowledge Base Article - 320528” at the following URL:

<http://support.microsoft.com/default.aspx?scid=kb%3Ben-us%3B320528>

Alternately, you can configure one “user” dedicated solely for the purposes of authenticating and performing queries instead of opening up your LDAP directory server for anonymous queries from any client.

A summary of the steps is included here, specifically:

- How to set up Microsoft Exchange 2000 server to allow “anonymous” authentication.
- How to set up Microsoft Exchange 2000 server to allow “anonymous bind.”
- How to set up AsyncOS to retrieve LDAP data from a Microsoft Exchange 2000 server using both “anonymous bind” and “anonymous” authentication.

Specific permissions must be made to a Microsoft Exchange 2000 server in order to allow “anonymous” or “anonymous bind” authentication for the purpose of querying user email addresses. This can be very useful when an LDAP query is used to determine the validity of an income email message to the SMTP gateway.

### Related Topics

- [Anonymous Authentication Setup, on page 762](#)
- [Anonymous Bind Setup for Active Directory, on page 763](#)
- [Notes for Active Directory Implementations, on page 764](#)

## Anonymous Authentication Setup

The following setup instructions allow you to make specific data available to unauthenticated queries of Active Directory and Exchange 2000 servers in the Microsoft Windows Active Directory. If you wish to allow “anonymous bind” to the Active Directory, see [Anonymous Bind Setup for Active Directory, on page 763](#).

### Procedure

**Step 1** Determine required Active Directory permissions.

Using the ADSI Edit snap-in or the LDP utility, you must modify the permissions to the attributes of the following Active Directory objects:

- The root of the domain naming context for the domain against which you want to make queries.
- All OU and CN objects that contain users against which you wish to query email information.

The following table shows the required permissions to be applied to all of the needed containers.

| User Object | Permissions                 | Inheritance                 | Permission Type |
|-------------|-----------------------------|-----------------------------|-----------------|
| Everyone    | List Contents               | Container Objects           | Object          |
| Everyone    | List Contents               | Organizational Unit Objects | Object          |
| Everyone    | Read Public Information     | User Objects                | Property        |
| Everyone    | Read Phone and Mail Options | User Objects                | Property        |

**Step 2** Set Active Directory Permissions

- Open ADSIEdit from the Windows 2000 Support Tools.
- Locate the **Domain Naming Context** folder. This folder has the LDAP path of your domain.
- Right click the **Domain Naming Context** folder, and then click **Properties**.
- Click **Security**.
- Click **Advanced**.
- Click **Add**.
- Click the **User Object** Everyone, and then click **OK**.
- Click the **Permission Type** tab.
- Click **Inheritance** from the **Apply onto** box.
- Click to select the Allow check box for the **Permission** permission.

**Step 3** Configure the Cisco Messaging Gateway

Use `ldapconfig` on the Command Line Interface (CLI) to create an LDAP server entry with the following information.

- Hostname of an Active Directory or Exchange server
- Port 3268
- Base DN matching the root naming context of the domain
- Authentication type Anonymous



## Anonymous Bind Setup for Active Directory

The following setup instructions allow you to make specific data available to anonymous bind queries of Active Directory and Exchange 2000 servers in the Microsoft Windows Active Directory. Anonymous bind of an Active Directory server will send the username anonymous with a blank passphrase.



**Note** If a passphrase is sent to an Active Directory server while attempting anonymous bind, authentication may fail.

### Procedure

**Step 1** Determine required Active Directory permissions.

Using the ADSI Edit snap-in or the LDP utility, you must modify the permissions to the attributes of the following Active Directory objects.

- The root of the domain naming context for the domain against which you want to make queries.
- All OU and CN objects that contain users against which you wish to query email information.

The following table shows the required permissions to be applied to all of the needed containers.

| User Object     | Permissions                 | Inheritance                 | Permission Type |
|-----------------|-----------------------------|-----------------------------|-----------------|
| ANONYMOUS LOGON | List Contents               | Container Objects           | Object          |
| ANONYMOUS LOGON | List Contents               | Organizational Unit Objects | Object          |
| ANONYMOUS LOGON | Read Public Information     | User Objects                | Property        |
| ANONYMOUS LOGON | Read Phone and Mail Options | User Objects                | Property        |

**Step 2** Set Active Directory Permissions

- Open ADSIEdit from the Windows 2000 Support Tools.
- Locate the **Domain Naming Context** folder. This folder has the LDAP path of your domain.
- Right click the **Domain Naming Context** folder, and then click **Properties**.
- Click **Security**.
- Click **Advanced**.
- Click **Add**.
- Click the **User Object** ANONYMOUS LOGON, and then click **OK**.
- Click the **Permission Type** tab.
- Click **Inheritance** from the **Apply** onto box.
- Click to select the **Allow** check box for the **Permission** permission.

**Step 3** Configure the Cisco Messaging Gateway

Use the **System Administration > LDAP** page (or `ldapconfig` in the CLI) to create an LDAP server entry with the following information.

- Hostname of an Active Directory or Exchange server

- Port 3268
- Base DN matching the root naming context of the domain
- Authentication type passphrase based using `cn=anonymous` as the user with a blank passphrase

## Notes for Active Directory Implementations

- Active Directory servers accept LDAP connections on ports 3268 and 389. The default port for accessing the global catalog is port 3268.
- Active Directory servers accept LDAPS connections on ports 636 and 3269. Microsoft supports LDAPS on Windows Server 2003 and higher.
- The appliance should connect to a domain controller that is also a global catalog so that you can perform queries to different bases using the same server.
- Within Active Directory, you may need to grant read permissions to the group “Everyone” to directory objects to yield successful queries. This includes the root of the domain naming context.
- Generally, the value of the mail attribute entry in many Active Directory implementations has a matching value “ProxyAddresses” attribute entry.
- Microsoft Exchange environments that are aware of each other within the infrastructure can usually route mail between each other without involving a route back to the originating MTA.

## Testing LDAP Queries

Use the Test Query button on the Add/Edit LDAP Server Profile page (or the `test` sub command in the CLI) of each query type to test the query to the LDAP server you configured. In addition to displaying the result, AsyncOS also displays the details on each stage of the query connection test. You can test each of the query types.

The `ldaptest` command is available as a batch command, for example:

```
ldaptest LDAP.ldapaccept foo@ironport.com
```

If you entered multiple hosts in the Host Name field of the LDAP server attributes, the appliance tests the query on each LDAP server.

**Table 66: Testing LDAP Queries**

| Query type                                                 | If a recipient matches (PASS)...                                   | If a recipient does not match (FAIL)...                                                                  |
|------------------------------------------------------------|--------------------------------------------------------------------|----------------------------------------------------------------------------------------------------------|
| Recipient Acceptance<br>(Accept, <code>ldapaccept</code> ) | Accept the message.                                                | Invalid Recipient: Conversation or delayed bounce or drop the message per listener settings. DHAP: Drop. |
| Routing<br>(Routing, <code>ldaprouting</code> )            | Route based on the query settings.                                 | Continue processing the message.                                                                         |
| Masquerade (Masquerade,<br><code>masquerade</code> )       | Alter the headers with the variable mappings defined by the query. | Continue processing the message.                                                                         |
| Group Membership (Group,<br><code>ldapgroup</code> )       | Return “true” for message filter rules.                            | Return “false” for message filter rules.                                                                 |

| Query type                                                       | If a recipient matches (PASS)...                                                                          | If a recipient does not match (FAIL)...                                                                 |
|------------------------------------------------------------------|-----------------------------------------------------------------------------------------------------------|---------------------------------------------------------------------------------------------------------|
| SMTP Auth<br>(SMTP Authentication,<br><code>smtpauth</code> )    | A passphrase is returned from the LDAP server and is used for authentication; SMTP Authentication occurs. | No passphrase match can occur; SMTP Authentication attempts fail.                                       |
| External Authentication (<br><code>externalauth</code> )         | Individually returns a “match positive” for the bind, the user record, and the user’s group membership.   | Individually returns a “match negative” for the bind, the user record, and the user’s group membership. |
| Spam Quarantine End-User Authentication ( <code>isqauth</code> ) | Returns a “match positive” for the end-user account.                                                      | No passphrase match can occur; End-User Authentication attempts fail.                                   |
| Spam Quarantine Alias Consolidation ( <code>isqalias</code> )    | Returns the email address that the consolidated spam notifications will be sent to.                       | No consolidation of spam notifications can occur.                                                       |



**Note** The variable names you enter for queries are *case-sensitive* and must match your LDAP implementation in order to work correctly. For example, entering `mailLocalAddress` at a prompt performs a different query than entering `maillocaladdress`. Cisco Systems strongly recommends using the `test` subcommand of the `ldapconfig` command to test all queries you construct and ensure the proper results are returned.

## Troubleshooting Connections to LDAP Servers

If the LDAP server is unreachable by the appliance, one of the following errors will be shown:

- `Error: LDAP authentication failed: <LDAP Error "invalidCredentials" [0x31]>`
- `Error: Server unreachable: unable to connect`
- `Error: Server unreachable: DNS lookup failure`

Note that a server may be unreachable because the wrong port was entered in the server configuration, or the port is not opened in the firewall. LDAP servers typically communicate over port 3268 or 389. Active Directory uses port 3268 to access the global catalog used in multi-server environments (See the “Firewall Information” appendix for more information.) In AsyncOS 4.0, the ability to communicate to the LDAP server via SSL (usually over port 636) was added. For more information, see [Secure LDAP \(SSL\), on page 761](#).

A server may also be unreachable because the hostname you entered cannot be resolved.

You can use the Test Server(s) on the Add/Edit LDAP Server Profile page (or the `test` subcommand of the `ldapconfig` command in the CLI) to test the connection to the LDAP server. For more information, see [Testing LDAP Servers, on page 754](#).

If the LDAP server is unreachable:

- If LDAP Accept or Masquerading or Routing is enabled on the work queue, mail will remain within the work queue.
- If LDAP Accept is not enabled but other queries (group policy checks, etc.) are used in filters, the filters evaluate to false.

# Using Acceptance Queries For Recipient Validation

You can use your existing LDAP infrastructure to define how the recipient email address of incoming messages (on an public listener) should be handled. Changes to user data in your directories are updated the next time the appliance queries the directory server. You can specify the size of the caches and the amount of time the appliance stores the data it retrieves.



**Note** You may wish to bypass LDAP acceptance queries for special recipients (such as administrator@example.com). You can configure this setting from the Recipient Access Table (RAT). For information about configuring this setting, see the “Configuring the Gateway to Receive Email” chapter.

## Related Topics

- [Sample Acceptance Queries, on page 766](#)
- [Configuring Acceptance Queries for Lotus Notes, on page 767](#)

## Sample Acceptance Queries

The following table shows sample acceptance queries.

**Table 67: Example LDAP Query Strings for Common LDAP Implementations: Acceptance**

| Query for:                                                            | Recipient validation                                                                                                               |
|-----------------------------------------------------------------------|------------------------------------------------------------------------------------------------------------------------------------|
| <b>OpenLDAP</b>                                                       | (mailLocalAddress={a})<br>(mail={a})<br>(mailAlternateAddress={a})                                                                 |
| <b>Microsoft Active Directory Address Book<br/>Microsoft Exchange</b> | ( (mail={a})(proxyAddresses=smtp:{a}))                                                                                             |
| <b>SunONE Directory Server</b>                                        | (mail={a})<br>(mailAlternateAddress={a})<br>(mailEquivalentAddress={a})<br>(mailForwardingAddress={a})<br>(mailRoutingAddress={a}) |
| <b>Lotus Notes/Lotus Domino</b>                                       | ( (  (mail={a})(uid={u})(cn={u}))<br>(  (ShortName={u})(InternetAddress={a})(FullName={u}))                                        |

You can also validate on the username (Left Hand Side). This is useful if your directory does not contain all the domains you accept mail for. Set the Accept query to (uid={u}).

## Configuring Acceptance Queries for Lotus Notes

Note that there is a potential complication with LDAPACCEPT and Lotus Notes. If Notes LDAP contains a person with attributes like these:

```
mail=juser@example.com
```

```
cn=Joe User
```

```
uid=juser
```

```
cn=123456
```

```
location=New Jersey
```

Lotus accepts email for this person for various different forms of email addresses, other than what is specified, such as “Joe\_User@example.com” — which do not exist in the LDAP directory. So AsyncOS may not be able to find all of the valid user email addresses for that user.

One possible solution is to try to publish the other forms of addresses. Please contact your Lotus Notes administrator for more details.

## Using Routing Queries to Send Mail to Multiple Target Addresses

AsyncOS supports alias expansion (LDAP routing with multiple target addresses). AsyncOS replaces the original email message with a new, separate message for each alias target (for example, recipient@yoursite.com might be replaced with new separate messages to newrecipient1@hotmail.com and recipient2@internal.yourcompany.com, etc.). Routing queries are sometimes known as aliasing queries on other mail processing systems.

### Related Topics

- [Sample Routing Queries, on page 767](#)

## Sample Routing Queries

*Table 68: Example LDAP Query Strings for Common LDAP Implementations: Routing*

| Query for:                                                    | Route to another mailhost |
|---------------------------------------------------------------|---------------------------|
| OpenLDAP                                                      | (mailLocalAddress={a})    |
| Microsoft Active Directory Address Book<br>Microsoft Exchange | May not be applicable     |

| Query for:              | Route to another mailhost                                                                                                                     |
|-------------------------|-----------------------------------------------------------------------------------------------------------------------------------------------|
| SunONE Directory Server | <pre>(mail={a}) (mailForwardingAddress={a}) (mailEquivalentAddress={a}) (mailRoutingAddress={a}) (otherMailbox={a}) (rfc822Mailbox={a})</pre> |

a. Active Directory implementations can have multiple entries for the `proxyAddresses` attribute, but because AD formats this attribute value as `smtp:user@domain.com`, that data cannot be used for LDAP routing/alias expansion. Each target address must be in a separate `attribute:value` pair. Microsoft Exchange environments that are aware of each other within the infrastructure can usually route mail between each other without involving a route back to the originating MTA.

#### Related Topics

- [Routing: MAILHOST and MAILROUTINGADDRESS, on page 768](#)

## Routing: MAILHOST and MAILROUTINGADDRESS

For Routing queries, the value of MAILHOST cannot be an IP address; it must be a resolvable hostname. This usually requires the use of an Internal DNSconfig.

MAILHOST is optional for the routing query. MAILROUTINGADDRESS is mandatory if MAILHOST is not set.

## Using Masquerading Queries to Rewrite the Envelope Sender

Masquerading is a feature that rewrites the Envelope Sender (also known as the sender, or MAIL FROM) and the To:, From:, and/or CC: headers on email based on queries you construct. A typical example implementation of this feature is “Virtual Domains,” which allows you to host multiple domains from a single site. Another typical implementation is “hiding” your network infrastructure by “stripping” the subdomains from strings in email headers.

#### Related Topics

- [Sample Masquerading Queries , on page 768](#)
- [Masquerading “Friendly Names”, on page 769](#)

## Sample Masquerading Queries

Table 69: Example LDAP Query Strings for Common LDAP Implementation: Masquerading

| Query for:                              | Masquerade                           |
|-----------------------------------------|--------------------------------------|
| OpenLDAP                                | <pre>(mailRoutingAddress={a})</pre>  |
| Microsoft Active Directory Address Book | <pre>(proxyaddresses=smtp:{a})</pre> |

| Query for:              | Masquerade                                                                                                                        |
|-------------------------|-----------------------------------------------------------------------------------------------------------------------------------|
| SunONE Directory Server | <pre>(mail={a}) (mailAlternateAddress={a}) (mailEquivalentAddress={a}) (mailForwardingAddress={a}) (mailRoutingAddress={a})</pre> |

## Masquerading “Friendly Names”

In some user environments, an LDAP directory server schema may store a “friendly name” in addition to a mail routing address or a local mail address. AsyncOS allows you to masquerade Envelope Senders (for outgoing mail) and message headers (for incoming mail, such as To:, Reply To:, From: or CC:) with this “friendly address” — even if the friendly address contains special characters that are not normally permitted in a valid email address (for example, quotation marks, spaces, and commas).

When using masquerading of headers via an LDAP query, you now have the option to configure whether to replace the entire friendly email string with the results from the LDAP server. Note that even with this behavior enabled, only the user@domain portion will be used for the Envelope Sender (the friendly name is illegal).

As with the normal LDAP masquerading, if empty results (zero length or entire white space) are returned from the LDAP query, no masquerading occurs.

To enable this feature, answer “y” to the following question when configuring an LDAP-based masquerading query for a listener (LDAP page or `ldapconfig` command):

```
Do you want the results of the returned attribute to replace the entire
friendly portion of the original recipient? [N]
```

For example, consider the following example LDAP entry:

| Attribute           | Value                                                     |
|---------------------|-----------------------------------------------------------|
| mailRoutingAddress  | admin\@example.com                                        |
| mailLocalAddress    | joe.smith\@example.com                                    |
| mailFriendlyAddress | “Administrator for example.com,” <joe.smith\@example.com> |

If this feature is enabled, an LDAP query of `(mailRoutingAddress={a})` and a masquerading attribute of `(mailLocalAddress)` would result in the following substitutions:

| Original Address (From, To, CC, Reply-to) | Masqueraded Headers                                               | Masqueraded Envelope Sender           |
|-------------------------------------------|-------------------------------------------------------------------|---------------------------------------|
| admin@example.com                         | From: “Administrator for example.com,”<br><joe.smith@example.com> | MAIL FROM:<br><joe.smith@example.com> |

# Using Group LDAP Queries to Determine if a Recipient is a Group Member

You can define a query to your LDAP servers to determine if a recipient is a member of a group as defined by your LDAP directory.

## Procedure

- 
- Step 1** Create a message filter that uses a rcpt-to-group or mail-from-group rule to act upon the message.
- Step 2** Then, use the **System Administration > LDAP** page (or the `ldapconfig` command) to define the LDAP server for the appliance to bind to and configure a query for a group membership.
- Step 3** Use the **Network > Listeners** page (or the `listenerconfig -> edit -> ldapgroup` subcommand) to enable the group query for the listener.
- 

## What to do next

### Related Topics

- [Sample Group Queries](#), on page 770
- [Configuring a Group Query](#), on page 770

## Sample Group Queries

*Table 70: Example LDAP Query Strings for Common LDAP Implementation: Group*

| Query for:                 | Group                                                                                                                                             |
|----------------------------|---------------------------------------------------------------------------------------------------------------------------------------------------|
| OpenLDAP                   | OpenLDAP does not support the memberOf attribute by default. Your LDAP Administrator may add this attribute or a similar attribute to the schema. |
| Microsoft Active Directory | <code>(&amp; (memberOf={g}) (proxyAddresses=smtp:{a}))</code>                                                                                     |
| SunONE Directory Server    | <code>(&amp; (memberOf={g}) (mailLocalAddress={a}))</code>                                                                                        |

For example, suppose that your LDAP directory classifies members of the “Marketing” group as `ou=Marketing`. You can use this classification to treat messages sent to or from members of this group in a special way. Step 1 creates a message filter to act upon the message, and Steps 2 and 3 enable the LDAP lookup mechanism.

## Configuring a Group Query

In the following example, mail from members of the Marketing group (as defined by the LDAP group “Marketing”) will be delivered to the alternate delivery host `marketingfolks.example.com`.



## Procedure

### Step 1

First, a message filter is created to act upon messages that match positively for group membership. In this example, a filter is created that uses the `mail-from-group` rule. All messages whose Envelope Sender is found to be in the LDAP group “marketing-group1” will be delivered with an alternate delivery host (the filters `alt-mailhost` action).

The group membership field variable (`groupName`) will be defined in step 2. The group attribute “`groupName`” is defined with the value `marketing-group1`.

```
mail3.example.com> filters
```

```
Choose the operation you want to perform:
```

- NEW - Create a new filter.
- IMPORT - Import a filter script from a file.

```
[]> new
```

```
Enter filter script. Enter '.' on its own line to end.
```

```
MarketingGroupfilter:
```

```
if (mail-from-group == "marketing-group1") {
alt-mailhost ('marketingfolks.example.com');
}
```

```
.
```

```
1 filters added.
```

```
Choose the operation you want to perform:
```

- NEW - Create a new filter.
- DELETE - Remove a filter.
- IMPORT - Import a filter script from a file.
- EXPORT - Export filters to a file
- MOVE - Move a filter to a different position.
- SET - Set a filter attribute.
- LIST - List the filters.
- DETAIL - Get detailed information on the filters.
- LOGCONFIG - Configure log subscriptions used by filters.
- ROLLOVERNOW - Roll over a filter log file.

```
[]>
```

For more information on the `mail-from-group` and `rcpt-to-group` message filter rules, see [Message Filter Rules, on page 132](#).

**Step 2** Next, the Add LDAP Server Profile page is used to define an LDAP server for the appliance to bind to, and an initial query for a group membership is configured.

**Step 3** Next, the public listener “InboundMail” is updated to use LDAP queries for group routing. The Edit Listener page is used to enable the LDAP query specified above.

As a result of this query, messages accepted by the listener trigger a query to the LDAP server to determine group membership. The PublicLDAP2.group query was defined previously via the **System Administration > LDAP** page.

**Figure 63: Specifying a Group Query on a Listener**

**Edit Listener**

| Listener Settings               |                                                                                                                                                                                                        |
|---------------------------------|--------------------------------------------------------------------------------------------------------------------------------------------------------------------------------------------------------|
| Name:                           | IncomingMail                                                                                                                                                                                           |
| Type of Listener:               | Public                                                                                                                                                                                                 |
| Interface:                      | Data 1 TCP Port: 25                                                                                                                                                                                    |
| Bounce Profile:                 | Default                                                                                                                                                                                                |
| Disclaimer Above:               | None<br><small>Disclaimer text will be applied above the message body.</small>                                                                                                                         |
| Disclaimer Below:               | None<br><small>Disclaimer text will be applied below the message body.</small>                                                                                                                         |
| SMTP Authentication Profile:    | None                                                                                                                                                                                                   |
| Certificate:                    | test                                                                                                                                                                                                   |
| ▶ SMTP Address Parsing Options: | Optional settings for controlling parsing in SMTP "MAIL FROM" and "RCPT TO"                                                                                                                            |
| ▶ Advanced:                     | Optional settings for customizing the behavior of the Listener                                                                                                                                         |
| ▼ LDAP Queries:                 | <ul style="list-style-type: none"> <li>▶ Accept</li> <li>▶ Routing</li> <li>▶ Masquerade</li> <li>▼ Group <ul style="list-style-type: none"> <li>Group Query: PublicLDAP2.group</li> </ul> </li> </ul> |
| SMTP Call-Ahead Profile:        | SMTP_Call_Ahead                                                                                                                                                                                        |

Cancel
Submit

**Step 4** Submit and commit your changes.

## Example: Using a Group Query to Skip Spam and Virus Checking

Because message filters occurs early in the pipeline, you can use a group query to skip virus and spam checking for specified groups. For example, you want your IT group to receive all messages and to skip spam and virus checking. In your LDAP record, you create a group entry that uses the DN as the group name. The group name consists of the following DN entry:

```
cn=IT, ou=groups, o=sample.com
```

You create an LDAP server profile with the following group query:

```
(&(memberOf={g})(proxyAddresses=smtp:{a}))
```

You then enable this query on a listener so that when a message is received by the listener, the group query is triggered.

To skip virus and spam filtering for members of the IT group, you create the following message filter to check incoming messages against LDAP groups.

```
[]> - NEW - Create a new filter.
- IMPORT - Import a filter script from a file.

[]> new
```

```
Enter filter script. Enter '.' on its own line to end.

IT_Group_Filter:

if (rcpt-to-group == "cn=IT, ou=groups, o=sample.com"){

skip-spamcheck();

skip-viruscheck();

deliver();

}

.

1 filters added.
```



**Note** The rcpt-to-group in this message filter reflects the DN entered as the group name: cn=IT, ou=groups, o=sample.com. Verify that you use the correct group name in the message filter to ensure that your filter matches the name in your LDAP directory.

Messages accepted by the listener trigger a query to the LDAP server to determine group membership. If the message recipient is a member of the IT group, the message filter skips both virus and spam checking and delivers the message to the recipient. To enable the filter to check the results of the LDAP query, you must create the LDAP query on the LDAP server and enable the LDAP query on a listener.

## Using Domain-based Queries to Route to a Particular Domain

Domain-based queries are LDAP queries grouped by type, associated with a domain, and assigned to a particular listener. You might want to use domain-based queries if you have different LDAP servers associated with different domains but you want to run queries for all your LDAP servers on the same listener. For example, the company “MyCompany” purchases company “HisCompany” and company “HerCompany” MyCompany maintains its domain, MyCompany.example.com as well as domains for HisCompany.example.com and HerCompany.example.com, and it maintains a different LDAP server for employees associated with each domain. To accept mail for all three of these domains, MyCompany creates domain-based queries. This allows MyCompany.example.com to accept emails for Mycompany.example.com, HisCompany.example.com, and HerCompany.example.com on the same listener.

### Procedure

- Step 1** Create a server profile for each of the domains you want to use in the domain-based queries. For each of the server profiles, configure the queries you want to use for a domain-based query (acceptance, routing, etc.). For more information, see [Creating LDAP Server Profiles to Store Information About the LDAP Server, on page 753](#).
- Step 2** Create the domain-based query. When you create the domain-based query, you select queries from each server profile, and enable the appliance to determine which query to run based on the domain in the Envelope To field. For more information about creating the query, see [Creating a Domain-Based Query, on page 774](#).

**Step 3** Enable the domain-based query on the public or private listener. For more information about configuring listeners, see the “Configuring the Gateway to Receive Mail” chapter.

**Note** You can also enable domain-based queries for LDAP end-user access or spam notifications for the Spam Quarantine. For more information, see the Spam Quarantine chapter.

---

#### What to do next

#### Related Topics

- [Creating a Domain-Based Query, on page 774](#)

## Creating a Domain-Based Query

You create a domain-based query from the System Administration > LDAP > LDAP Server Profiles page.

#### Procedure

---

**Step 1** From the LDAP Server Profiles page, click **Advanced**.

**Step 2** Click **Add Domain Assignments**.

**Step 3** Enter a name for the domain-based query.

**Step 4** Select the query type.

**Note** When you create domain-based queries, you cannot select different types of queries. Once you select a query type, the appliance populates the query field with queries of that type from the available server profiles.

**Step 5** In the Domain Assignments field, enter a domain.

**Step 6** Select a query to associate with the domain.

**Step 7** Continue to add rows until you have added all the domains to your query.

**Step 8** You can enter a default query to run if all other queries fail. If you do not want to enter a default query, select **None**.

**Step 9** Test the query by clicking the Test Query button and entering a user login and passphrase or an email address to test in the Test Parameters fields. The results appear in the Connection Status field.

**Step 10** Optionally, if you use the {f} token in an acceptance query, you can add an envelope sender address to the test query.

**Note** Once you create the domain-based query, you need to associate it with a public or private listener.

**Step 11** Submit and commit your changes.

---

## Using Chain Queries to Perform a Series of LDAP Queries

A chain query is a series of LDAP queries that the appliance attempts to run in succession. The appliance attempts to run each query in the “chain” until the LDAP server returns a positive response (or the final query in the “chain” returns a negative response or fails). For chained routing queries, the appliance re-runs the same

configured chain query in sequence for each rewritten email address. Chain queries can be useful if entries in your LDAP directory use different attributes to store similar (or the same) values. For example, you might have used the attributes maillocaladdress and mail to store user email addresses. To ensure that your queries run against both these attributes, you can use chain queries.

### Procedure

---

- Step 1** Create server profiles for each of the queries you want to use in the chain queries. For each of the server profiles, configure the queries you want to use for a chain query. For more information, see [Creating LDAP Server Profiles to Store Information About the LDAP Server, on page 753](#).
- Step 2** Create the chain query. For more information, see [Creating a Chain Query, on page 775](#).
- Step 3** Enable the chain query on the public or private listener. For more information about configuring listeners, see the “Configuring the Gateway to Receive Mail” chapter.

**Note** You can also enable domain-based queries for LDAP end-user access or spam notifications for the Spam Quarantine. For more information, see the Spam Quarantine chapter.

---

### What to do next

#### Related Topics

- [Creating a Chain Query, on page 775](#)

## Creating a Chain Query

You create a chain query from the System Administration > LDAP > LDAP Server Profiles page.

### Procedure

---

- Step 1** From the LDAP Server Profiles page, click **Advanced**.
- Step 2** Click **Add Chain Query**.
- Step 3** Add a name for the chain query.
- Step 4** Select the query type.
- When you create chain queries, you cannot select different types of queries. Once you select a query type, the appliance populates the query field with queries of that type from available server profiles.
- Step 5** Select a query to add to the chain query.
- The appliance runs the queries in the order you configure them. Therefore, if you add multiple queries to the chain query, you might want to order the queries so that more specific queries are followed by more general queries.
- Step 6** Test the query by clicking the Test Query button and entering a user login and passphrase or an email address to test in the Test Parameters fields. The results appear in the Connection Status field.
- Step 7** Optionally, if you use the {f} token in an acceptance query, you can add an envelope sender address to the test query.

**Note** Once you create the chain query, you need to associate it with a public or private listener.

**Step 8** Submit and commit your changes.

## Using LDAP For Directory Harvest Attack Prevention

Directory Harvest Attacks occur when a malicious sender attempts to send messages to recipients with common names, and the email gateway responds by verifying that a recipient has a valid mailbox at that location. When performed on a large scale, malicious senders can determine who to send mail to by “harvesting” these valid addresses for spamming.

The appliance can detect and prevent Directory Harvest Attack (DHA) when using LDAP acceptance validation queries. You can configure LDAP acceptance to prevent directory harvest attacks within the SMTP conversation or within the work queue.

### Related Topics

- [Directory Harvest Attack Prevention within the SMTP Conversation, on page 776](#)
- [Directory Harvest Attack Prevention within the Work Queue, on page 777](#)

## Directory Harvest Attack Prevention within the SMTP Conversation

You can prevent DHAs by entering only domains in the Recipient Access Table (RAT), and performing the LDAP acceptance validation in the SMTP conversation.

To drop messages during the SMTP conversation, configure an LDAP server profile for LDAP acceptance. Then, configure the listener to perform an LDAP accept query during the SMTP conversation.

**Figure 64: Configuring the Acceptance Query in the SMTP Conversation**

The screenshot shows the configuration for LDAP Queries under the SMTP Conversation. The 'Accept Query' is set to 'redfish.accept'. Under 'Work Queue', 'Non-Matching Recipients' is set to 'Bounce'. Under 'SMTP Conversation', the 'If the LDAP server is unreachable' section is expanded, showing 'Allow Mail in' as a radio button option and 'Return error code' as a checked option. The 'Return error code' section is further expanded, showing 'Code' set to '451' and 'Text' set to 'Temporary recipient validation er'.

Once you configure LDAP acceptance queries for the listener, you must configure DHAP settings in the mail flow policy associated with the listener.

Figure 65: Configuring the Mail Flow Policy to Drop Connections in the SMTP Conversation

| Mail Flow Limits                            |                                                                                                                                         |
|---------------------------------------------|-----------------------------------------------------------------------------------------------------------------------------------------|
| Rate Limiting:                              | Max. Recipients Per Hour: <input checked="" type="radio"/> Unlimited <input type="radio"/> <input type="text"/>                         |
|                                             | Max. Recipients Per Hour Code: <input type="text" value="452"/>                                                                         |
|                                             | Max. Recipients Per Hour Text: <input type="text" value="Too many recipients received this hour"/>                                      |
| Flow Control:                               | Use SenderBase for Flow Control: <input checked="" type="radio"/> On <input type="radio"/> Off                                          |
|                                             | Group by Similarity of IP Addresses: <i>This Feature can only be used if Senderbase Flow Control is off.</i>                            |
|                                             | <input checked="" type="radio"/> Off <input type="radio"/> <input type="text"/> (significant bits 0-32)                                 |
| Directory Harvest Attack Prevention (DHAP): | Max. Invalid Recipients Per Hour: <input type="radio"/> Unlimited <input checked="" type="radio"/> <input type="text" value="5"/>       |
|                                             | Drop Connection if DHAP threshold is Reached within an SMTP Conversation: <input checked="" type="radio"/> On <input type="radio"/> Off |
|                                             | Max. Invalid Recipients Per Hour Code: <input type="text" value="550"/>                                                                 |
|                                             | Max. Invalid Recipients Per Hour Text: <input type="text" value="Too many invalid recip"/>                                              |

In the mail flow policy associated with the listener, configure the following Directory Harvest Attack Prevention settings:

- **Max. Invalid Recipients Per hour.** The maximum number of invalid recipients per hour this listener will receive from a remote host. This threshold represents the total number of RAT rejections combined with the total number of messages to invalid LDAP recipients dropped in the SMTP conversation or bounced in the work queue. For example, you configure the threshold as five, and the counter detects two RAT rejections and three dropped messages to invalid LDAP recipients. At this point, the appliance determines that the threshold is reached, and the connection is dropped. By default, the maximum number of recipients per hour for a public listener is 25. For a private listener, the maximum number of recipients per hour is unlimited by default. Setting it to “Unlimited” means that DHAP is not enabled for that mail flow policy.
- **Drop Connection if DHAP Threshold is reached within an SMTP conversation.** Configure the appliance to drop the connection if the Directory Harvest Attack Prevention threshold is reached.
- **Max. Recipients Per Hour Code.** Specify the code to use when dropping connections. The default code is 550.
- **Max. Recipients Per Hour Text.** Specify the text to use for dropped connections. The default text is “Too many invalid recipients.”

If the threshold is reached, the Envelope Sender of the message does not receive a bounce message when a recipient is invalid.

## Directory Harvest Attack Prevention within the Work Queue

You can prevent most DHAs by entering only domains in the Recipient Access Table (RAT), and performing the LDAP acceptance validation within the work queue. This technique prevents the malicious senders from knowing if the recipient is valid during the SMTP conversation. (When acceptance queries are configured, the system accepts the message and performs the LDAP acceptance validation within the work queue.) However, the Envelope Sender of the message will still receive a bounce message if a recipient is not valid.

### Related Topics

- [Configuring Directory Harvest Prevention in the Work Queue, on page 778](#)

## Configuring Directory Harvest Prevention in the Work Queue

To prevent Directory Harvest Attacks, you first configure an LDAP server profile, and enable LDAP Accept. Once you have enabled LDAP acceptance queries, configure the listener to use the accept query, and to bounce mail for non-matching recipients:

Next, configure the Mail Flow Policy to define the number of invalid recipient addresses the system will allow per sending IP address for a specific period of time. When this number is exceeded, the system will identify this condition as a DHA and send an alert message. The alert message will contain the following information:

```
LDAP: Potential Directory Harvest Attack from host=('IP-address', 'domain_name'), dhap_limit=n, sender_group=sender_group,
```

```
listener=listener_name, reverse_dns=(reverse_IP_address, 'domain_name', 1), sender=envelope_sender, rcpt=envelope_recipients
```

The system will bounce the messages up to the threshold you specified in the mail flow policy and then it will silently accept and drop the rest, thereby informing legitimate senders that an address is bad, but preventing malicious senders from determining which receipts are accepted.

This invalid recipients counter functions similarly to the way Rate Limiting is currently available in AsyncOS: you enable the feature and define the limit as part of the mail flow policy in a public listener's HAT (including the default mail flow policy for the HAT).

You can also configure this in the command-line interface using the `listenerconfig` command.

This feature is also displayed when editing any mail flow policy in the GUI, providing that LDAP queries have been configured on the corresponding listener:

Entering a number of invalid recipients per hour enables DHAP for that mail flow policy. By default, 25 invalid recipients per hour are allowed for public listeners. For private listeners, the maximum invalid recipients per hour is unlimited by default. Setting it to "Unlimited" means that DHAP is not enabled for that mail flow policy.

## Configuring AsyncOS for SMTP Authentication

AsyncOS provides support for SMTP authentication. SMTP Auth is a mechanism for authenticating clients connected to an SMTP server.

The practical use of this mechanism is that users at a given organization are able to send mail using that entity's mail servers even if they are connecting remotely (e.g. from home or while traveling). Mail User Agents (MUAs) can issue an authentication request (challenge/response) when attempting to send a piece of mail.

Users can also use SMTP authentication for outgoing mail relays. This allows the appliance to make a secure connection to a relay server in configurations where the appliance is not at the edge of the network.

AsyncOS supports two methods to authenticate user credentials:

- You can use an LDAP directory.
- You can use a different SMTP server (SMTP Auth forwarding and SMTP Auth outgoing).



Figure 66: SMTP Auth Support: LDAP Directory Store or SMTP Server

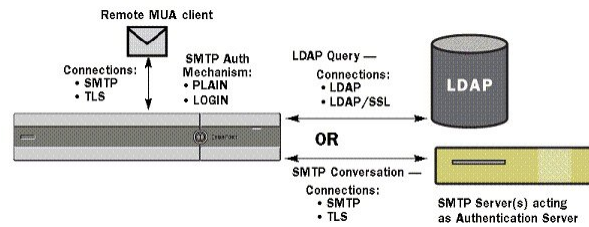

Configured SMTP Authentication methods are then used to create SMTP Auth profiles via the `smtpauthconfig` command for use within HAT mail flow policies (see [Enabling SMTP Authentication on a Listener](#), on page 782).

### Related Topics

- [Configuring SMTP Authentication](#), on page 779
- [Configuring an SMTP Authentication Query](#), on page 780
- [SMTP Authentication via Second SMTP Server \(SMTP Auth with Forwarding\)](#), on page 781
- [SMTP Authentication with LDAP](#), on page 781
- [Authenticating SMTP Sessions Using Client Certificates](#), on page 785
- [Outgoing SMTP Authentication](#), on page 785
- [Logging and SMTP Authentication](#), on page 786

## Configuring SMTP Authentication

If you are going to authenticate with an LDAP server, select the SMTPAUTH query type on the Add or Edit LDAP Server Profile pages (or in the `ldapconfig` command) to create an SMTP Authentication query. For each LDAP server you configure, you can configure a SMTPAUTH query to be used as an SMTP Authentication profile.

There are two kinds of SMTP authentication queries: LDAP bind and passphrase as attribute. When you use passphrase as attribute, the appliance will fetch the passphrase field in the LDAP directory. The passphrase may be stored in plain text, encrypted, or hashed. When you use LDAP bind, the appliance attempts to log into the LDAP server using the credentials supplied by the client.

### Related Topics

- [Specifying a Passphrase as Attribute](#), on page 779

## Specifying a Passphrase as Attribute

The convention in OpenLDAP, based on RFC 2307, is that the type of coding is prefixed in curly braces to the encoded passphrase (for example, “{SHA}5en6G6MezRroT3XKqkdPOmY/BfQ=”). In this example, the passphrase portion is a base64 encoding of a plain text passphrase after application of SHA.

The appliance negotiates the SASL mechanism with the MUA before getting the passphrase, and the appliance and the MUA decide on what method (LOGIN, PLAIN, MD5, SHA, SSHA, and CRYPT SASL mechanisms are supported). Then, the appliance queries the LDAP database to fetch a passphrase. In LDAP, the passphrase can have a prefix in braces.

- If there is no prefix, the appliance assumes that the passphrase was stored in LDAP in plaintext.

- If there is a prefix, the appliance will fetch the hashed passphrase, perform the hash on the username and/or passphrase supplied by the MUA, and compare the hashed versions. The appliance supports SHA1 and MD5 hash types based on the RFC 2307 convention of prepending the hash mechanism type to the hashed passphrase in the passphrase field.
- Some LDAP servers, like the OpenWave LDAP server, do not prefix the encrypted passphrase with the encryption type; instead, they store the encryption type as a separate LDAP attribute. In these cases, you can specify a default SMTP AUTH encryption method the appliance will assume when comparing the passphrase with the passphrase obtained in the SMTP conversation.

The appliance takes an arbitrary username from the SMTP Auth exchange and converts that to an LDAP query that fetches the clear or hashed passphrase field. It will then perform any necessary hashing on the passphrase supplied in the SMTP Auth credentials and compare the results with what it has retrieved from LDAP (with the hash type tag, if any, removed). A match means that the SMTP Auth conversation shall proceed. A failure to match will result in an error code.

## Configuring an SMTP Authentication Query

Table 71: SMTP Auth LDAP Query Fields

| Name                           | A name for the query.                                                                                                                                                                                                                                                                                                                                                                                                                                                                                                                                                                                                                                                                                                                                                                                                                                                                                                                                                                                                                                                                                                           |
|--------------------------------|---------------------------------------------------------------------------------------------------------------------------------------------------------------------------------------------------------------------------------------------------------------------------------------------------------------------------------------------------------------------------------------------------------------------------------------------------------------------------------------------------------------------------------------------------------------------------------------------------------------------------------------------------------------------------------------------------------------------------------------------------------------------------------------------------------------------------------------------------------------------------------------------------------------------------------------------------------------------------------------------------------------------------------------------------------------------------------------------------------------------------------|
| Query String                   | <p>You can select whether to authenticate via LDAP bind or by fetching the passphrase as an attribute.</p> <p><b>Bind:</b> Attempt to log into the LDAP server using the credentials supplied by the client (this is called an LDAP bind).</p> <p>Specify the maximum number of concurrent connections to be used by the SMTP Auth query. This number should not exceed the number specified in the LDAP server attributes above. Note, to avoid large number of session time-outs for bind authentication, increase the maximum number of concurrent connections here (typically nearly all of the connections can be assigned to SMTP Auth). A new connection is used for each bind authentication. The remainder of the connections are shared by the other LDAP query types.</p> <p><b>Passphrase as Attribute:</b> To authenticate by fetching passphrases, specify the passphrase in the SMTP Auth passphrase attribute field below.</p> <p>Specify the LDAP query to use for either kind of authentication. Active Directory example query:<br/>(&amp;(samaccountname={u})(objectCategory=person)(objectClass=user))</p> |
| SMTP Auth Passphrase Attribute | If you have selected “Authenticate by fetching the passphrase as an attribute,” you can specify the passphrase attribute here.                                                                                                                                                                                                                                                                                                                                                                                                                                                                                                                                                                                                                                                                                                                                                                                                                                                                                                                                                                                                  |

In the following example, the System Administration > LDAP page is used to edit the LDAP configuration named “PublicLDAP” to include an SMTPAUTH query. The query string ( uid={u} ) is constructed to match against userPassword attribute.

Figure 67: SMTP Authentication Query

| SMTP Authentication Query |                                                                                                                                 |
|---------------------------|---------------------------------------------------------------------------------------------------------------------------------|
| Name:                     | PublicLDAP.smtpauth                                                                                                             |
| Query String:             | {uid={u}}                                                                                                                       |
|                           | User Identity for Test Queries: <input type="text"/> <input type="button" value="Test Query"/>                                  |
|                           | Test SMTP Authentication Password: <input type="text"/> ?                                                                       |
| Authentication Method:    | <input type="radio"/> Authenticate via LDAP BIND<br><input type="radio"/> Authenticate by fetching the password as an attribute |
|                           | Maximum number of concurrent connections for this query: <input type="text"/>                                                   |
|                           | SMTP Authentication Password Attribute: <input type="text" value="userPassword"/>                                               |

When an SMTPAUTH profile has been configured, you can specify that the listener uses that query for SMTP authentication.

## SMTP Authentication via Second SMTP Server (SMTP Auth with Forwarding)

You can configure the appliance to verify the username and passphrase that have been provided to another SMTP authenticated conversation with a different SMTP server.

The authenticating server is not the server that transfers mail; rather, it only responds to SMTP Authentication requests. When authentication has succeeded, the SMTP transfer of mail with the dedicated mail server can proceed. This feature is sometimes referred to as “SMTP Authentication with forwarding” because only the credentials are forwarded (or “proxied”) to another SMTP server for authentication.

### Procedure

- 
- Step 1** Choose **Network > SMTP Authentication**.
  - Step 2** Click **Add Profile...**
  - Step 3** Enter a unique name for the SMTP authentication profile.
  - Step 4** For the **Profile Type**, select **Forward**.
  - Step 5** Click **Next**.
  - Step 6** Enter the hostname/IP address and port of the forwarding server. Select a forwarding interface to use for forwarding authentication requests. Specify the number of maximum simultaneous connections. Then, you can configure whether TLS is required for connections from the appliance to the forwarding server. You can also select a SASL method to use (PLAIN or LOGIN), if available. This selection is configured for each forwarding server.
  - Step 7** Submit and commit your changes.
  - Step 8** After creating the authentication profile, you can enable the profile on a listener. See [Enabling SMTP Authentication on a Listener, on page 782](#) for more information.
- 

## SMTP Authentication with LDAP

To create an LDAP-based SMTP Authentication profile, you must have previously created an SMTP Authentication query in conjunction with an LDAP server profile using the System Administration > LDAP

page. You can then use this profile to create an SMTP Authentication profile. For more information about creating an LDAP profile, see [Understanding LDAP Queries, on page 750](#).

### Procedure

- 
- Step 1** Choose **Network > SMTP Authentication**.
- Step 2** Click **Add Profile**.
- Step 3** Enter a unique name for the SMTP authentication profile.
- Step 4** For the Profile Type, select **LDAP**.
- Step 5** Click **Next**.
- Step 6** Select the LDAP query you would like to use for this authentication profile.
- Step 7** Select a default encryption method from the drop-down menu. You can select from SHA, Salted SHA, Crypt, Plain, or MD5. If your LDAP servers prefix an encrypted passphrase with the encryption type, leave 'None' selected. If your LDAP server saves the encryption type as a separate entity (OpenWave LDAP servers, for example), then select an encryption method from the menu. The default encryption setting will not be used if the LDAP query is using bind.
- Step 8** Click **Finish**.
- Step 9** Submit and commit your changes.
- Step 10** After creating the authentication profile, you can enable the profile on a listener. See [Enabling SMTP Authentication on a Listener, on page 782](#) for more information.
- 

### What to do next

#### Related Topics

- [Enabling SMTP Authentication on a Listener, on page 782](#)

## Enabling SMTP Authentication on a Listener

After using the **Network > SMTP Authentication** page to create an SMTP authentication “profile” that specifies the type of SMTP authentication you want to perform (LDAP-based or SMTP forwarding-based), you must associate that profile with a listener using the **Network > Listeners** page (or the `listenerconfig` command).



---

**Note** An authenticated user is granted RELAY connection behavior within their current Mail Flow Policy. You may specify more than one forwarding server in a profile. SASL mechanisms CRAM-MD5 and DIGEST-MD5 are not supported between the appliance and a forwarding server.

---

In the following example, the listener “InboundMail” is edited to use the SMTPAUTH profile configured via the Edit Listener page:

Figure 68: Selecting an SMTP Authentication Profile via the Edit Listener page

**Edit Listener**

| Listener Settings               |                                                                              |
|---------------------------------|------------------------------------------------------------------------------|
| Name:                           | IncomingMail                                                                 |
| Type of Listener:               | Public                                                                       |
| Interface:                      | Data 1 TCP Port: 25                                                          |
| Bounce Profile:                 | Default                                                                      |
| Disclaimer Above:               | None<br><i>Disclaimer text will be applied above the message body.</i>       |
| Disclaimer Below:               | None<br><i>Disclaimer text will be applied below the message body.</i>       |
| SMTP Authentication Profile:    | forwarding_based                                                             |
| Certificate:                    | test                                                                         |
| ▶ SMTP Address Parsing Options: | Optional settings for controlling parsing in SMTP "MAIL FROM" and "RCPT TO"  |
| ▶ Advanced:                     | Optional settings for customizing the behavior of the Listener               |
| ▶ LDAP Queries:                 | Optional settings for controlling LDAP queries associated with this Listener |
| SMTP Call-Ahead Profile:        | None                                                                         |

Cancel Submit

Once a listener is configured to use the profile, the Host Access Table default settings can be changed so that the listener allows, disallows, or requires SMTP Authentication:

Figure 69: Enabling SMTP Authentication on a Mail Flow Policy

|                                |                                                  |                                                                                                                                             |
|--------------------------------|--------------------------------------------------|---------------------------------------------------------------------------------------------------------------------------------------------|
| Encryption and Authentication: | TLS:                                             | <input type="radio"/> Use Default (Off) <input checked="" type="radio"/> Off <input type="radio"/> Preferred <input type="radio"/> Required |
|                                | SMTP Authentication:                             | <input checked="" type="radio"/> Use Default (Off) <input type="radio"/> Off <input type="radio"/> Preferred <input type="radio"/> Required |
|                                | If Both TLS and SMTP Authentication are enabled: | <input type="checkbox"/> Require TLS To Offer SMTP Authentication                                                                           |

| Number | Description                                                                                                                                                                                                                        |
|--------|------------------------------------------------------------------------------------------------------------------------------------------------------------------------------------------------------------------------------------|
| 1.     | The SMTP Authentication field provides listener-level control for SMTP authentication. If you select “No,” authentication will not be enabled on the listener, regardless of any other SMTP authentication settings you configure. |
| 2.     | If “Required” is selected in the second prompt (SMTP Authentication:), no AUTH keyword will be issued until TLS is negotiated (after the client issues a second EHLO command).                                                     |

### Related Topics

- [SMTP Authentication and HAT Policy Settings, on page 783](#)
- [HAT Delayed Rejection, on page 784](#)

## SMTP Authentication and HAT Policy Settings

Because senders are grouped into the appropriate sender group before the SMTP Authentication negotiation begins, Host Access Table (HAT) settings, are not affected. When a remote mail host connects, the appliance first determines which sender group applies and imposes the Mail Policy for that sender group. For example, if a remote MTA “suspicious.com” is in your SUSPECTLIST sender group, the THROTTLE policy will be applied, regardless of the results of “suspicious.com’s” SMTPAUTH negotiation.

However, senders that do authenticate using SMTPAUTH are treated differently than “normal” senders. The connection behavior for successful SMTPAUTH sessions changes to “RELAY,” effectively bypassing the Recipient Access Table (RAT) and LDAPACCEPT. This allows the sender to relay messages through the appliance. As stated, any Rate Limiting or throttling that applies will remain in effect.

## HAT Delayed Rejection

When HAT Delayed Rejection is configured, connections that would get dropped based on the HAT Sender Group and Mail Flow Policy configuration can still authenticate successfully and get the RELAY mail flow policy granted.

Configure whether to perform HAT rejection at the message recipient level. By default, HAT rejected connections will be closed with a banner message at the start of the SMTP conversation.

When an email is rejected due to HAT “Reject” settings, AsyncOS can perform the rejection at the message recipient level (RCPT TO), rather than at the start of the SMTP conversation. Rejecting messages in this way delays the message rejection and bounces the message, allowing AsyncOS to retain more detailed information about the rejected messages. For example, you can see the mail from address and each recipient address of the message which is blocked. Delaying HAT rejections also makes it less likely that the sending MTA will perform multiple retries.

When you enable HAT delayed rejection, the following behavior occurs:

- The MAIL FROM command is accepted, but no message object is created.
- All RCPT TO commands are rejected with text explaining that access to send e-mail is refused.
- If the sending MTA authenticates with SMTP AUTH, they are granted a RELAY policy and are allowed to deliver mail as normal.

You can configure delayed rejection using the `listenerconfig --> setup` CLI command. This behavior is disabled by default.

The following table shows how to configure delayed rejection for HAT.

```
example.com> listenerconfig
```

```
Currently configured listeners:
```

1. listener1 (on main, 172.22.138.17) QMQP TCP Port 628 Private
2. listener2 (on main, 172.22.138.17) SMTP TCP Port 25 Private

```
Choose the operation you want to perform:
```

- NEW - Create a new listener.
- EDIT - Modify a listener.
- DELETE - Remove a listener.
- SETUP - Change global settings.

```
[]> setup
```

```
Enter the global limit for concurrent connections to be allowed across all listeners.
```

```
[300]>
```

```
[...]
```

By default HAT rejected connections will be closed with a banner message at the start of the SMTP conversation. Would you like to do the rejection at the

```
message recipient level instead for more detailed logging of rejected mail?
```

```
[N]> y
```

```
Do you want to modify the SMTP RCPT TO reject response in this case?
```

```
[N]> y
```

```
Enter the SMTP code to use in the response. 550 is the standard code.
```

```
[550]> 551
```

```
Enter your custom SMTP response. Press Enter on a blank line to finish.
```

```
Sender rejected due to local mail policy.
```

```
Contact your mail admin for assistance.
```

## Authenticating SMTP Sessions Using Client Certificates

The appliance supports the use of client certificates to authenticate SMTP sessions between the appliance and users' mail clients.

When creating an SMTP authentication profile, you select the Certificate Authentication LDAP query to use for verifying the certificate. You can also specify whether the appliance falls back to the SMTP AUTH command to authenticate the user if a client certificate isn't available.

If your organization uses client certificates to authenticate users, you have the option of using the SMTP Authentication query to check whether a user who doesn't have a client certificate can send mail as long as their record specifies that it's allowed.

## Outgoing SMTP Authentication

SMTP Authentication can also be used to provide validation for an outbound mail relay, using a username and passphrase. Create an 'outgoing' SMTP authentication profile and then attach the profile to an SMTP route for the ALL domain. On each mail delivery attempt, the appliance will log on to the upstream mail relay with the necessary credentials. SMTP authentication supports the following authorization protocols: PLAIN and LOGIN.

### Procedure

---

- Step 1** Create an outgoing SMTP authentication profile.
- Choose **Network > SMTP Authentication**.
  - Click **Add Profile**.
  - Enter a unique name for the SMTP authentication profile.
  - For the Profile Type, select **Outgoing**.
  - Click **Next**.
  - Enter an authentication username and passphrase for the authentication profile.
  - Click **Finish**.
- Step 2** Configure SMTP routes to use the outgoing SMTP authentication profile that you created in Step 1.

- a. Choose **Network > SMTP Routes**.
  - b. Click the **All Other Domains** link in the **Receiving Domain** column of the table.
  - c. Enter the name of the Destination Host for the SMTP route. This is the hostname of your external mail relay used to deliver outgoing mail.
  - d. Select the outgoing SMTP authentication profile from the drop-down menu.
  - e. Submit and commit your changes.
- 

## Logging and SMTP Authentication

The following events will be logged in the mail logs when the SMTP Authentication mechanism (either LDAP-based, SMTP forwarding server based, or SMTP outgoing) is configured on the appliance :

- [Informational] Successful SMTP Authentication attempts — including the user authenticated and the mechanism used. (No plaintext passphrases will be logged.)
- [Informational] Unsuccessful SMTP Authentication attempts — including the user authenticated and the mechanism used.
- [Warning] Inability to connect to the authentication server — including the server name and the mechanism.
- [Warning] A time-out event when the forwarding server (talking to an upstream, injecting appliance ) times out while waiting for an authentication request.

## Configuring External LDAP Authentication for Users

You can configure the appliance to use an LDAP directory on your network to authenticate users by allowing them to log in with their LDAP usernames and passphrases. After you configure the authentication queries for the LDAP server, enable the appliance to use external authentication on the **System Administration > Users** page in the GUI (or use the `userconfig` command in the CLI).

### Procedure

---

- Step 1** **Create a query to find user accounts.** In an LDAP server profile, create a query to search for user accounts in the LDAP directory.
- Step 2** **Create group membership queries.** Create a query to determine if a user is a member of a directory group.
- Step 3** **Set up external authentication to use the LDAP server.** Enable the appliance to use the LDAP server for user authentication and assign user roles to the groups in the LDAP directory. For more information, see “Adding Users” in the “Distributing Administrative Tasks” chapter.

**Note** Use the Test Query button on the LDAP page (or the `ldaptest` command) to verify that your queries return the expected results. For more information, see [Testing LDAP Queries, on page 764](#).

---

### What to do next

#### Related Topics

- [User Accounts Query, on page 787](#)



- [Group Membership Queries, on page 787](#)

## User Accounts Query

To authenticate external users, AsyncOS uses a query to search for the user record in the LDAP directory and the attribute that contains the user's full name. Depending on the server type you select, AsyncOS enters a default query and a default attribute. You can choose to have your appliance deny users with expired accounts if you have attributes defined in RFC 2307 in your LDAP user records ( shadowLastChange , shadowMax , and shadowExpire ). The base DN is required for the domain level where user records reside.

The following table shows the default query string and full username attribute that AsyncOS uses when it searches for a user account on an Active Directory server.

**Table 72: Default User Account Query String and Attribute: Active Directory**

| Server Type                               | Active Directory                                                       |
|-------------------------------------------|------------------------------------------------------------------------|
| Base DN                                   | [blank] (You need to use a specific base DN to find the user records.) |
| Query String                              | (&(objectClass=user)(sAMAccountName={u}))                              |
| Attribute containing the user's full name | displayName                                                            |

The following table shows the default query string and full username attribute that AsyncOS uses when it searches for a user account on an OpenLDAP server.

**Table 73: Default User Account Query String and Attribute: OpenLDAP**

| Server Type                               | OpenLDAP                                                               |
|-------------------------------------------|------------------------------------------------------------------------|
| Base DN                                   | [blank] (You need to use a specific base DN to find the user records.) |
| Query String                              | (&(objectClass=posixAccount)(uid={u}))                                 |
| Attribute containing the user's full name | gecos                                                                  |

## Group Membership Queries

AsyncOS also uses a query to determine if a user is a member of a directory group. Membership in a directory group determines the user's permissions within the system. When you enable external authentication on the System Administration > Users page in the GUI (or userconfig in the CLI), you assign user roles to the groups in your LDAP directory. User roles determine the permissions that users have in the system, and for externally authenticated users, the roles are assigned to directory groups instead of individual users. For example, you can assign users in the IT directory group the Administrator role and users in the Support directory group to the Help Desk User role.

If a user belongs to multiple LDAP groups with different user roles, AsyncOS grants the user the permissions for the most restrictive role. For example, if a user belongs to a group with Operator permissions and a group with Help Desk User permissions, AsyncOS grants the user the permissions for the Help Desk User role.

When you configure the LDAP profile to query for group membership, enter the base DN for the directory level where group records can be found, the attribute that holds the group member's username, and the attribute that contains the group name. Based on the server type that you select for your LDAP server profile, AsyncOS enters default values for the username and group name attributes, as well default query strings.



**Note** For Active Directory servers, the default query string to determine if a user is a member of a group is (&(objectClass=group)(member={u})) . However, if your LDAP schema uses distinguished names in the “memberof” list instead of usernames, you can use {dn} instead of {u} .

The following table shows the default query strings and attributes that AsyncOS uses when it searches for group membership information on an Active Directory server.

**Table 74: Default Group Membership Query Strings and Attribute: Active Directory**

| Server Type                                                                 | Active Directory                                                                                                                                                          |
|-----------------------------------------------------------------------------|---------------------------------------------------------------------------------------------------------------------------------------------------------------------------|
| Base DN                                                                     | [blank] (You need to use a specific base DN to find the group records.)                                                                                                   |
| Query string to determine if a user is a member of a group                  | (&(objectClass=group)(member={u}))<br><b>Note</b> If your LDAP schema uses distinguished names in the memberOf list instead of usernames, you can replace {u} with {dn} . |
| Attribute that holds each member's username (or a DN for the user's record) | member                                                                                                                                                                    |
| Attribute that contains the group name                                      | cn                                                                                                                                                                        |

The following table shows the default query strings and attributes that AsyncOS uses when it searches for group membership information on an OpenLDAP server.

**Table 75: Default Group Membership Query Strings and Attributes: OpenLDAP**

| Server Type                                                                 | OpenLDAP                                                                |
|-----------------------------------------------------------------------------|-------------------------------------------------------------------------|
| Base DN                                                                     | [blank] (You need to use a specific base DN to find the group records.) |
| Query string to determine if a user is a member of a group                  | (&(objectClass=posixGroup)(memberUid={u}))                              |
| Attribute that holds each member's username (or a DN for the user's record) | memberUid                                                               |
| Attribute that contains the group name                                      | cn                                                                      |

# Authenticating End-Users of the Spam Quarantine

Spam quarantine end-user authentication queries validate users when they log in to the Spam Quarantine. The token {u} specifies the user (it represents the user's login name). The token {a} specifies the user's email address. The LDAP query does not strip "SMTP:" from the email address; AsyncOS strips that portion of the address.

If you want the Spam Quarantine to use an LDAP query for end-user access, check the "Designate as the active query" check box. If there is an existing active query, it is disabled. When you open the **System Administration > LDAP** page, an asterisk (\*) is displayed next to the active queries.

Based on the server type, AsyncOS uses one of the following default query strings for the end-user authentication query:

- **Active Directory:** (sAMAccountName={u})
- **OpenLDAP:** (uid={u})
- **Unknown or Other:** [Blank]

By default, the primary email attribute is proxyAddresses for Active Directory servers and mail for OpenLDAP servers. You can enter your own query and email attributes. To create the query from the CLI, use the isqauth subcommand of the ldapconfig command.



**Note** If you want users to log in with their full email address, use (mail=smtp:{a}) for the Query String.

## Related Topics

- [Sample Active Directory End-User Authentication Settings, on page 789](#)
- [Sample OpenLDAP Alias Consolidation Settings, on page 791](#)
- [Configuring End-User Access to the Spam Quarantine, on page 938](#)

## Sample Active Directory End-User Authentication Settings

This section shows sample settings for an Active Directory server and the end-user authentication query. This example uses passphrase authentication for the Active Directory server, the mail and proxyAddresses email attributes, and the default query string for end-user authentication for Active Directory servers.

*Table 76: Example LDAP Server and Spam Quarantine End-User Authentication Settings: Active Directory*

| Authentication Method | Use Passphrase (Need to create a low-privilege user to bind for searching, or configure anonymous searching.) |
|-----------------------|---------------------------------------------------------------------------------------------------------------|
| Server Type           | Active Directory                                                                                              |
| Port                  | 3268                                                                                                          |
| Base DN               | [Blank]                                                                                                       |
| Connection Protocol   | [Blank]                                                                                                       |
| Query String          | (sAMAccountName={u})                                                                                          |

|                              |                                                                                                                      |
|------------------------------|----------------------------------------------------------------------------------------------------------------------|
| <b>Authentication Method</b> | <b>Use Passphrase (Need to create a low-privilege user to bind for searching, or configure anonymous searching.)</b> |
| Email Attribute(s)           | mail,proxyAddresses                                                                                                  |

## Sample OpenLDAP End-User Authentication Settings

This section shows sample settings for an OpenLDAP server and the end-user authentication query. This example uses anonymous authentication for the OpenLDAP server, the mail and mailLocalAddress email attributes, and the default query string for end-user authentication for OpenLDAP servers.

*Table 77: Example LDAP Server and Spam Quarantine End-User Authentication Settings: OpenLDAP*

| <b>Authentication Method</b> | <b>Anonymous</b>                                                  |
|------------------------------|-------------------------------------------------------------------|
| Server Type                  | OpenLDAP                                                          |
| Port                         | 389                                                               |
| Base DN                      | [Blank] (Some older schemas will want to use a specific Base DN.) |
| Connection Protocol          | [Blank]                                                           |
| Query String                 | (uid={u})                                                         |
| Email Attribute(s)           | mail,mailLocalAddress                                             |

## Spam Quarantine Alias Consolidation Queries

If you use spam notifications, the spam quarantine alias consolidation query consolidates the email aliases so that recipients do not receive quarantine notices for each alias. For example, a recipient might receive mail for the following email addresses: john@example.com, jsmith@example.com, and john.smith@example.com. When you use alias consolidation, the recipient receives a single spam notification at a chosen primary email address for messages sent to all of the user's aliases.

To consolidate messages to a primary email address, create a query to search for a recipient's alternate email aliases, and then enter the attribute for the recipient's primary email address in the Email Attribute field.

If you want the Spam Quarantine to use an LDAP query for spam notifications, check the "Designate as the active query" check box. If there is an existing active query, it is disabled. When you open the System Administration > LDAP page, an asterisk (\*) is displayed next to the active queries.

For Active Directory servers, the default query string is `((proxyAddresses={a})(proxyAddresses=smtp:{a}))` and the default email attribute is `mail`. For OpenLDAP servers, the default query string is `(mail={a})` and the default email attribute is `mail`. You can define your own query and email attributes, including multiple attributes separated by commas. If you enter more than one email attribute, Cisco recommends entering a unique attribute that uses a single value, such as `mail`, as the first email attribute instead of an attribute with multiple values that can change, such as `proxyAddresses`.

To create the query in the CLI, use the `isqalias` subcommand of the `ldapconfig` command.

**Related Topics**

- [Sample Active Directory Alias Consolidation Settings, on page 791](#)
- [Sample OpenLDAP Alias Consolidation Settings, on page 791](#)

## Sample Active Directory Alias Consolidation Settings

This section shows sample settings for an Active Directory server and the alias consolidation query. This example uses anonymous authentication for the Active Directory server, a query string for alias consolidation for Active Directory servers, and the mail email attribute.

**Table 78: Example LDAP Server and Spam Quarantine Alias Consolidation Settings: Active Directory**

| Authentication Method | Anonymous                               |
|-----------------------|-----------------------------------------|
| Server Type           | Active Directory                        |
| Port                  | 3268                                    |
| Base DN               | [Blank]                                 |
| Connection Protocol   | Use SSL                                 |
| Query String          | (<br>  (mail={a}) (mail=smtpp:{a})<br>) |
| Email Attribute       | mail                                    |



**Note** This example is for representational purposes only. Queries and OU or tree settings may vary depending on the environment and configuration.

## Sample OpenLDAP Alias Consolidation Settings

This section shows sample settings for an OpenLDAP server and the alias consolidation query. This example uses anonymous authentication for the OpenLDAP server, a query string for alias consolidation for OpenLDAP servers, and the mail email attribute.

**Table 79: Example LDAP Server and Spam Quarantine Alias Consolidation Settings: OpenLDAP**

| Authentication Method | Anonymous                                                         |
|-----------------------|-------------------------------------------------------------------|
| Server Type           | OpenLDAP                                                          |
| Port                  | 389                                                               |
| Base DN               | [Blank] (Some older schemas will want to use a specific Base DN.) |
| Connection Protocol   | Use SSL                                                           |

| Authentication Method | Anonymous  |
|-----------------------|------------|
| Query String          | (mail={a}) |
| Email Attribute       | mail       |



**Note** This example is for representational purposes only. Queries and OU or tree settings may vary depending on the environment and configuration.

## Sample User Distinguished Name Settings

This section shows sample settings for an Active Directory server and the user distinguished name query. This example uses anonymous authentication for the Active Directory server and a query string for user distinguished name retrieval for Active Directory servers.

*Table 80: Example LDAP Server and Spam Quarantine Alias Consolidation Settings: Active Directory*

| Authentication Method | Anonymous                 |
|-----------------------|---------------------------|
| Server Type           | Active Directory          |
| Port                  | 3268                      |
| Base DN               | [Blank]                   |
| Connection Protocol   | Use SSL                   |
| Query String          | (proxyAddresses=smtp:{a}) |



**Note** This example is for representational purposes only. Queries and OU or tree settings may vary depending on the environment and configuration.

## Configuring AsyncOS To Work With Multiple LDAP Servers

When you configure an LDAP profile, you can configure the appliance to connect to a list of multiple LDAP servers. To use multiple LDAP servers, you must configure LDAP servers to contain the same information, use the same structure, and use the same authentication information. (third party products exist that can consolidate the records).

When you configure the appliance to connect to redundant LDAP servers, you can configure the LDAP configuration for failover or load balancing.

You can use multiple LDAP servers to achieve the following results:

- **Failover.** When you configure the LDAP profile for failover, the appliance fails over to the next LDAP server in the list if it cannot connect to the first LDAP server.

- **Load Balancing.** When you configure the LDAP profile for load balancing, the appliance distributes connections across the list of LDAP servers when it performs LDAP queries.

You can configure redundant LDAP servers from the System Administration > LDAP page or from the CLI `ldapconfig` command.

## Performing Recipient Verification and Resolving Group Queries using Azure AD Domain Services

To perform recipient verification and resolve group queries using Azure AD Domain Services, see the Configuring Azure AD DS documentation at <https://docs.ces.cisco.com/docs/using-azure-ad-ds-with-ces#lockdown-secure-ldap-access-over-the-internet>

## Testing Servers and Queries

Use the **Test Server(s)** button on the Add (or Edit) LDAP Server Profile page (or the `test` subcommand in the CLI) to test the connection to an LDAP server. If you use multiple LDAP servers, AsyncOS tests each server and displays individual results for each server. AsyncOS will also test the query on each LDAP server and display the individual results.

### Related Topics

- [Failover, on page 793](#)
- [Load Balancing, on page 794](#)

## Failover

To ensure that LDAP queries are resolved, you can configure your LDAP profile for failover. If the connection to the LDAP server fails, or the query returns certain error codes (for example, Unavailable or Busy), the appliance attempts to query the next LDAP server specified in the list.

The appliance attempts to connect to the first server in the list of LDAP servers for a specified period of time. If the appliance cannot connect to the first LDAP server in the list, or the query returns certain error codes (for example, Unavailable or Busy), the appliance attempts to connect to the next LDAP server in the list. By default, the appliance always attempts to connect to the first server in the list, and it attempts to connect to each subsequent server in the order they are listed. To ensure that the appliance connects to your primary LDAP server by default, ensure that you enter it as the first server in your list of LDAP servers.

If the appliance connects to a second or subsequent LDAP server, it remains connected to that server until it reaches a timeout period. After it reaches the timeout, it attempts to reconnect to the first server in the list.



---

**Note** Only attempts to query a specified LDAP server fail over. Attempts to query referral or continuation servers associated with the specified LDAP server do not fail over.

---

**Related Topics**

- [Configuring the Appliance for LDAP Failover, on page 794](#)

**Configuring the Appliance for LDAP Failover**

To configure the appliance for LDAP failover, complete the following steps in the GUI:

**Procedure**

**Step 1** From System Administration > LDAP, select the LDAP server profile you want to edit.

**Step 2** From the LDAP server profile, configure the following settings:

| Number | Description                    |
|--------|--------------------------------|
| 1      | List LDAP Servers.             |
| 2      | Configure Maximum Connections. |

**Step 3** Configure other LDAP settings and commit the changes.

**Load Balancing**

To distribute LDAP connections among a group of LDAP servers, you can configure your LDAP profile for load balancing.

When you configure your LDAP profile for load balancing, the appliance distributes connections among the LDAP servers listed. If a connection fails or times out, the appliance determines which LDAP servers are available and reconnects to available servers. The appliance determines the number of simultaneous connections to establish based on the maximum number of connections you configure.

If one of the listed LDAP servers does not respond, the appliance distributes the connection load among the remaining LDAP servers.

**Reliance Topics**

- [Configuring the Appliance for Load Balancing, on page 795](#)



## Configuring the Appliance for Load Balancing

### Procedure

**Step 1** From **System Administration > LDAP**, select the LDAP server profile you want to edit.

**Step 2** From the LDAP server profile, configure the following settings:

| Server Attributes               |                                                                                                                                                        |
|---------------------------------|--------------------------------------------------------------------------------------------------------------------------------------------------------|
| LDAP Server Configuration Name: | <input type="text" value="example.com"/>                                                                                                               |
| Host Name(s):                   | <input type="text" value="ldapsrv1.example.com, ldapsrv2.example.com, ldapsrv3.example.com"/><br><small>Separate multiple entries with commas.</small> |
|                                 | Maximum number of simultaneous connections for all hosts: <input type="text" value="10"/>                                                              |
|                                 | Multiple host options:                                                                                                                                 |
|                                 | <input checked="" type="radio"/> Load-balance connections among all hosts listed                                                                       |
|                                 | <input type="radio"/> Failover connections in the order listed                                                                                         |

| Number | Description                   |
|--------|-------------------------------|
| 1      | List LDAP Servers             |
| 2      | Configure Maximum Connections |

**Step 3** Configure other LDAP settings and commit the changes.





## CHAPTER 32

# Authenticating SMTP Sessions Using Client Certificates

---

This chapter contains the following sections:

- [Overview of Certificates and SMTP Authentication](#), on page 797
- [Checking the Validity of a Client Certificate](#), on page 799
- [Authenticating a User Using an LDAP Directory](#), on page 800
- [Authenticating an SMTP Connection Over TLS Using a Client Certificate](#), on page 801
- [Establishing a TLS Connection from the Appliance](#), on page 801
- [Updating a List of Revoked Certificates](#), on page 802

## Overview of Certificates and SMTP Authentication

The appliance supports the use of client certificates to authenticate SMTP sessions between the appliance and users' mail clients. The appliance can request a client certificate from a user's mail client when the application attempts to connect to the appliance to send messages. When the appliance receives the client certificate, it verifies that the certificate is valid, has not expired, and has not been revoked. If the certificate is valid, the appliance allows an SMTP connection from the mail application over TLS.

Organizations that require their users to use a Common Access Card (CAC) for their mail clients can use this feature to configure the appliance to request a certificate that the CAC and ActivClient middleware application will provide to the appliance .

You can configure the appliance to require users to provide a certificate when sending mail, but still allow exceptions for certain users. For these users, you can configure the appliance to use the SMTP authentication LDAP query to authenticate the user.

Users must configure their mail client to send messages through a secure connection (TLS) and accept a server certificate from the appliance .

### Related Topics

- [How to Authenticate a User with a Client Certificate](#), on page 798
- [How to Authenticate a User with an SMTP Authentication LDAP Query](#), on page 798
- [How to Authenticate a User with an LDAP SMTP Authentication Query if the Client Certificate is Invalid](#), on page 799

## How to Authenticate a User with a Client Certificate

**Table 81: How to Authenticate a User with a Client Certificate**

|        | Do This                                                                                            | More Info                                                                                                |
|--------|----------------------------------------------------------------------------------------------------|----------------------------------------------------------------------------------------------------------|
| Step 1 | Define a certificate query for your LDAP server.                                                   | <a href="#">Checking the Validity of a Client Certificate, on page 799</a>                               |
| Step 2 | Create a certificate-based SMTP authentication profile.                                            | <a href="#">Authenticating an SMTP Connection Over TLS Using a Client Certificate, on page 801</a>       |
| Step 3 | Configure a listener to use the certificate SMTP authentication profile.                           | <a href="#">Listening for Connection Requests by Creating a Listener Using Web Interface, on page 75</a> |
| Step 4 | Modify the RELAYED mail flow policy to require TLS, a client certificate, and SMTP authentication. | <a href="#">Establishing a TLS Connection from the Appliance , on page 801</a>                           |

## How to Authenticate a User with an SMTP Authentication LDAP Query

**Table 82: How to Authenticate a User with an SMTP Authenticate LDAP Query**

|        | Do This                                                                                                                         | More Info                                                                                                                                                                                               |
|--------|---------------------------------------------------------------------------------------------------------------------------------|---------------------------------------------------------------------------------------------------------------------------------------------------------------------------------------------------------|
| Step 1 | Define an SMTP authentication query for your server that uses an allowance query string and Bind for the authentication method. | <a href="#">Authenticating a User Using an LDAP Directory, on page 800</a>                                                                                                                              |
| Step 2 | Create an LDAP-based SMTP authentication profile.                                                                               | <a href="#">Configuring AsyncOS for SMTP Authentication, on page 778</a>                                                                                                                                |
| Step 3 | Configure a listener to use the LDAP SMTP authentication profile.                                                               | If the user is not allowed to use LDAP-based SMTP authentication for their connection, you can select whether the appliance rejects the connection or temporarily allows it while logging all activity. |
| Step 4 | Modify the RELAYED mail flow policy to require TLS and SMTP authentication.                                                     | <a href="#">Establishing a TLS Connection from the Appliance , on page 801</a>                                                                                                                          |

## How to Authenticate a User with an LDAP SMTP Authentication Query if the Client Certificate is Invalid

Table 83: How to Authenticate a User with a Client Certificate or an LDAP SMTP Authentication Query

|        | Do This                                                                                                                                                                                                                                    | More Info                                                                                                |
|--------|--------------------------------------------------------------------------------------------------------------------------------------------------------------------------------------------------------------------------------------------|----------------------------------------------------------------------------------------------------------|
| Step 1 | Define an SMTP authentication query for your server that uses an allowance query string and Bind for the authentication method.                                                                                                            | <a href="#">Authenticating a User Using an LDAP Directory, on page 800</a>                               |
| Step 2 | Define a certificate-based query for your LDAP server.                                                                                                                                                                                     | <a href="#">Checking the Validity of a Client Certificate, on page 799</a>                               |
| Step 3 | Create a certificate-based SMTP authentication profile                                                                                                                                                                                     | <a href="#">Authenticating an SMTP Connection Over TLS Using a Client Certificate, on page 801</a>       |
| Step 4 | Create an LDAP SMTP authentication profile.                                                                                                                                                                                                | <a href="#">Configuring AsyncOS for SMTP Authentication, on page 778</a>                                 |
| Step 5 | Configure a listener to use the certificate SMTP authentication profile.                                                                                                                                                                   | <a href="#">Listening for Connection Requests by Creating a Listener Using Web Interface, on page 75</a> |
| Step 6 | <ol style="list-style-type: none"> <li>1. Modify the RELAYED mail flow policy to use the following settings:</li> <li>2. TLS Preferred</li> <li>3. SMTP authentication required</li> <li>4. Require TLS for SMTP authentication</li> </ol> | <a href="#">Establishing a TLS Connection from the Appliance , on page 801</a>                           |

## Checking the Validity of a Client Certificate

The Certificate Authentication LDAP query checks the validity of a client certificate in order to authenticate an SMTP session between the user's mail client and the appliance . When creating this query, you select a list of certificate fields for authentication, specify the User ID attribute (the default is uid ), and enter the query string.

For example, a query string that searches for the certificate's common name and serial number may look like `(&(objectClass=posixAccount)(caccn={cn})(cacserial={sn})` . After you have created the query, you can use it in a Certificate SMTP Authentication Profile. This LDAP query supports OpenLDAP, Active Directory, and Oracle Directory.

See [LDAP Queries, on page 749](#) for more information on configuring LDAP servers.

### Procedure

- 
- Step 1** Select **System Administration > LDAP**.
  - Step 2** Create a new LDAP profile. See [Creating LDAP Server Profiles to Store Information About the LDAP Server, on page 753](#) for more information.
  - Step 3** Check the **Certificate Authentication Query** checkbox.

- Step 4** Enter the query name.
  - Step 5** Enter the query string to authenticate the user's certificate. For example, `(&(objectClass=user)(cn={cn}))`.
  - Step 6** Enter the user ID attribute, such as `sAMAccountName`.
  - Step 7** Submit and commit your changes.
- 

## Authenticating a User Using an LDAP Directory

The SMTP Authentication LDAP query has an Allowance Query String that allows the appliance to check whether the user's mail client is allowed to send mail through the appliance based on the user's record in the LDAP directory. This allows users who don't have a client certificate to send mail as long as their record specifies that it's allowed.

You can also filter out results based on other attributes. For example, the query string `(&(uid={u})(|(! (caccn=*)) (cacexempt=*) (cacemergencymax={t})))` checks to see if any of the following conditions are true for the user:

- CAC is not issued to the user ( `caccn=*` )
- CAC is exempt ( `cacexempt=*` )
- the time period that a user may temporarily send mail without a CAC expires in the future ( `cacemergencymax={t}` )

See [Configuring AsyncOS for SMTP Authentication, on page 778](#) for more information on using the SMTP Authentication query.

### Procedure

---

- Step 1** Select **System Administration > LDAP**.
  - Step 2** Define an LDAP profile. See [Creating LDAP Server Profiles to Store Information About the LDAP Server, on page 753](#) for more information.
  - Step 3** Define an SMTP authentication query for the LDAP profile.
  - Step 4** Check the SMTP Authentication Query checkbox.
  - Step 5** Enter the query name.
  - Step 6** Enter the string to query for the user's ID. For example, `(uid={u})`.
  - Step 7** Select LDAP BIND for the authentication method.
  - Step 8** Enter an allowance query string. For example, `(&(uid={u})(|(! (caccn=*)) (cacexempt=*) (cacemergencymax={t})))`.
  - Step 9** Submit and commit your changes.
-

# Authenticating an SMTP Connection Over TLS Using a Client Certificate

The certificate-based SMTP authentication profile allows the appliance to authenticate an SMTP connection over TLS using a client certificate. When creating the profile, you select the Certificate Authentication LDAP query to use for verifying the certificate. You can also specify whether the appliance falls back to the **SMTP AUTH** command to authenticate the user if a client certificate is not available.

For information on authenticating an SMTP connection by using LDAP, see [Configuring AsyncOS for SMTP Authentication, on page 778](#).

## Procedure

---

- Step 1** Select **Network > SMTP Authentication**.
  - Step 2** Click **Add Profile**.
  - Step 3** Enter the name for the SMTP authentication profile.
  - Step 4** Select **Certificate** for the Profile Type.
  - Step 5** Click **Next**.
  - Step 6** Enter the profile name.
  - Step 7** Select the certificate LDAP query you want to use with this SMTP authentication profile.  
**Note** Do not select the option to allow the SMTP AUTH command if a client certificate is not available.
  - Step 8** Click **Finish**.
  - Step 9** Submit and commit your changes.
- 

## Establishing a TLS Connection from the Appliance

The Verify Client Certificate option in the RELAYED mail flow policy directs the appliance to establish a TLS connection to the user's mail application if the client certificate is valid. If you select this option for the TLS Preferred setting, the appliance still allows a non-TLS connection if the user doesn't have a certificate, but rejects a connection if the user has an invalid certificate. For the TLS Required setting, selecting this option requires the user to have a valid certificate in order for the appliance to allow the connection.

To authenticate a user's SMTP session with a client certificate, select the following settings:

- TLS - Required
- Verify Client Certificate
- Require SMTP Authentication



**Note** Although SMTP authentication is required, the appliance will not use the SMTP authentication LDAP query because it is using certificate authentication.

---

To authenticate a user's SMTP session using the SMTP authentication query instead of a client certificate, select the following settings for the RELAYED mail flow policy:

- TLS - Required
- Require SMTP Authentication

If you require the appliance to ask for a client certificate from certain users while allowing LDAP-based SMTP authentication from others, select the following settings for the RELAYED mail flow policy:

- TLS - Preferred
- Require SMTP Authentication
- Require TLS to Offer SMTP Authentication

## Updating a List of Revoked Certificates

The Email Security appliance checks a list of revoked certificates (called a Certificate Revocation List) as part of its certificate verification to make sure that the user's certificate hasn't been revoked. You keep an up-to-date version of this list on a server and the appliance downloads it on a schedule that you create.

### Procedure

---

- Step 1** Go to **Network > CRL Sources**.
- Step 2** Enable CRL checking for SMTP TLS connections:
- a) Click Edit Settings under Global Settings.
  - b) (Optional) Select the **Global Settings** checkbox if you want to select all options:
    - CRL check for inbound SMTP TLS.
    - CRL check for outbound SMTP TLS
    - CRL Check for Web Interface
  - c) Select the checkbox for either 'CRL check for inbound SMTP TLS', 'CRL check for outbound SMTP TLS' or 'CRL Check for Web Interface' options.
  - d) Submit your change.
- Step 3** Click **Add CRL Source**.
- Step 4** Enter a name for the CRL source.
- Step 5** Select the file type. This can be either ASN.1 or PEM.
- Step 6** Enter the URL for the primary source for the file, including the filename. For example,  
**https://crl.example.com/certs.crl**
- Step 7** Optionally, enter the URL for a secondary source in case the appliance cannot contact the primary source.
- Step 8** Specify a schedule for downloading the CRL source.
- Step 9** Enable the CRL source.
- Step 10** Submit and commit your changes.
-



## Authenticating a User's SMTP Session With a Client Certificate

### Procedure

- 
- Step 1** Go to **System Administration > LDAP** to configure an LDAP server profile.
- Step 2** Define a certificate query for the LDAP profile.
- Enter the query name.
  - Choose the certificate fields to authenticate, such as the serial number and common name.
  - Enter the query string. For example, `(&(caccn={cn})(cacserial={sn}))`.
  - Enter the user ID field, such as uid.
  - Submit your changes.
- Step 3** Go to **Network > SMTP Authentication** to configure a Certificate SMTP authentication profile.
- Enter the profile name.
  - Select the certificate LDAP query you want to use.
  - Do not select the option to allow the **SMTP AUTH** command if a client certificate is not available.
  - Submit your changes.
- Step 4** Go to **Network > Listeners** to configure a listener to use the certificate SMTP authentication profile that you created.
- Step 5** Modify the RELAYED mail flow policy to require TLS and a client certificate, as well as require SMTP authentication.
- Note** Although SMTP authentication is required, the appliance will not use the SMTP AUTH command because it is using certificate authentication. The appliance will require a client certificate from the mail application to authenticate the user.
- Step 6** Submit and commit your changes.
- 

## Authenticating a User's SMTP Session with the SMTP AUTH Command

The appliance can use the SMTP AUTH command to authenticate a user's SMTP session instead of a client certificate. If you user is not allowed to use SMTP AUTH for their connection, you can select whether the appliance rejects the connection or temporarily allows it while logging all activity.

### Procedure

- 
- Step 1** Go to **System Administration > LDAP** to configure an LDAP server profile.
- Step 2** Define an SMTP authentication query for the LDAP profile.
- Enter the query name.
  - Enter the query string. For example, `(uid={u})`.
  - Select LDAP Bind for the authentication method.
  - Enter an allowance query string. For example, `(&(uid={u})(!(caccn=*)(cacexempt=*)(cacemergency>={t})))`.
  - Submit your changes.

- Step 3** Go to **Network > SMTP Authentication** to configure an LDAP SMTP authentication profile.
- Enter the profile name.
  - Select the SMTP authentication LDAP query you want to use.
  - Select the Check with LDAP if user is allowed to use SMTP AUTH Command and choose to monitor and report the user's activity.
  - Submit your changes.
- Step 4** Go to **Network > Listeners** to configure a listener to use the LDAP SMTP authentication profile that you created.
- Step 5** Modify the RELAYED mail flow policy to require TLS and SMTP authentication.
- Step 6** Submit and commit your changes.

## Authenticating a User's SMTP Session with Either a Client Certificate or SMTP AUTH

This configuration requires the appliance to ask for a client certificate from users with a client certificate while allowing SMTP AUTH for users without one, or who cannot use one for sending email.

Any attempt to use the SMTP AUTH command by a user who is not allowed will be prohibited.

### Procedure

- Step 1** Go to **System Administration > LDAP** to configure an LDAP server profile.
- Step 2** Define an SMTP authentication query for the profile.
- Enter the query name.
  - Enter the query string. For example, `(uid={u})`.
  - Select LDAP Bind for the authentication method.
  - Enter an allowance query string. For example, `(&(uid={u})(!(caccn=*)(cacexempt=*)(cacemergency>={t})))`.
- Step 3** Define a certificate query for the LDAP profile.
- Enter the query name.
  - Choose the client certificate fields to authenticate, such as the serial number and common name.
  - Enter the query string. For example, `(&(caccn={cn})(cacserial={sn}))`.
  - Enter the user ID field, such as uid.
  - Submit your changes.
- Step 4** Go to **Network > SMTP Authentication** to configure an LDAP SMTP authentication profile.
- Enter the profile name.
  - Select the SMTP authentication LDAP query you want to use.
  - Select the Check with LDAP if user is allowed to use SMTP AUTH Command and choose to reject the connection.
  - Enter a custom SMTP AUTH response. For example, 525, "Dear user, please use your CAC to send email."
  - Submit your changes.

- Step 5** Configure a Certificate SMTP authentication profile.
- Enter the profile name.
  - Select the certificate LDAP query you want to use.
  - Select the option to allow the SMTP AUTH command if a client certificate is not available.
  - Select your LDAP SMTP authentication profile for the appliance to use if the user does not have a client certificate.
  - Submit your changes.
- Step 6** Go to **Network > Listeners** to configure a listener to use the certificate SMTP authentication profile you created.
- Step 7** Modify the RELAYED mail flow policy to select the following options:
- TLS Preferred
  - SMTP authentication required
  - Require TLS for SMTP Authentication
- Step 8** Submit and commit your changes.
-



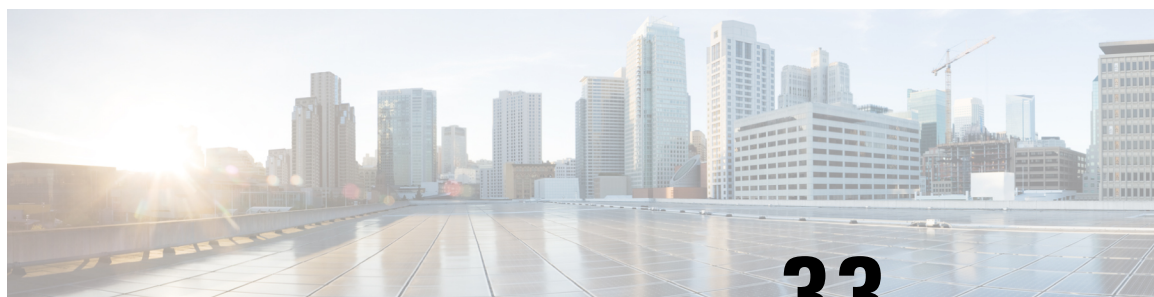

## CHAPTER 33

# Using Email Security Monitor

---

This chapter contains the following sections:

- [Email Security Monitor Overview, on page 807](#)
- [Email Security Monitor Pages, on page 808](#)
- [Email Security Monitor Pages on the New Web Interface, on page 841](#)
- [Reporting Overview, on page 881](#)
- [Managing Reports, on page 883](#)
- [Troubleshooting Email Reports, on page 886](#)

## Email Security Monitor Overview

The Email Security Monitor feature collects data from every step in the email delivery process. The database identifies and records each email sender by IP address, while interfacing with the IP Reputation Service for real-time identity information. You can instantly report on any email sender's local mail flow history and show a profile that includes the sender's global record on the Internet. The Email Security Monitor feature allows your security team to “close the loop” on who is sending mail to your users, the amount of mail sent from and received by your users, and the effectiveness of your security policies.

This chapter explains how to:

- Access the Email Security Monitor feature to monitor inbound and outbound message flow.
- Make mail flow policy decisions (update allowed lists, blocked lists, and greylists) by querying for a sender's IP Reputation Score. You can query on network owners, domains, and even individual IP addresses.
- Report on mail flow, system status, and mail sent to and from your network.

For any given email sender for incoming mail, the Email Security Monitor database captures critical parameters such as:

- Message volume
- Connection history
- Accepted vs. rejected connections
- Acceptance rates and throttle limits
- Sender reputation filter matches
- Number of anti-spam messages for suspected spam and positively identified spam
- Number of virus-positive message detected by anti-virus scanning

See [Managing Spam and Graymail, on page 359](#) for more information on Anti-Spam scanning and [Anti-Virus, on page 341](#) for more information on anti-virus scanning.

The Email Security Monitor feature also captures information on which content filter a particular message triggers, including the internal user (email recipient) to or from which the message was sent.

The Email Security Monitor feature is available in the GUI only, and provides a view into your email traffic and the status of your appliance (including quarantines, work queues, and outbreaks). The appliance identifies when a sender falls outside of the normal traffic profile. Senders that do are highlighted in the interface, allowing you to take corrective action by assigning that sender to a sender group or refining the access profile of the sender; or, you can let AsyncOS's security services continue to react and respond. Outbound mail has a similar monitoring capability, providing you a view into the top domains in the mail queue and the status of receiving hosts (see [Delivery Status Details Page, on page 823](#)).



---

**Note** Information for messages present in the work queue when the appliance is rebooted is not reported by the Email Security Monitor feature.

---

#### Related Topics

- [Email Security Monitor and Centralized Management, on page 808](#)

## Email Security Monitor and Centralized Management

To view aggregated report data, deploy a Cisco Content Security Management appliance .

You cannot aggregate Email Security Monitor reports of clustered appliances. All reports are restricted to machine level. This means they cannot be run at the group or cluster levels — only on individual machines.

The same is true of the Archived Reports page — each machine in effect has its own archive. Thus, the “Generate Report” feature runs on the selected machine.

The Scheduled Reports page is not restricted to machine level; therefore, settings can be shared across multiple machines. Individual scheduled reports run at machine level just like interactive reports, so if you configure your scheduled reports at cluster level, every machine in the cluster will send its own report.

The “Preview This Report” button always runs against the login-host.

## Email Security Monitor Pages

The Email Security Monitor feature is comprised of all the pages available on the Monitor menu except the Quarantines pages.

You use these pages in the GUI to monitor domains that are connecting to the appliance's listeners. You can monitor, sort, analyze, and classify the “mail flow” of your appliance and differentiate between high-volume senders of legitimate mail and potential “spammers” (senders of high-volume, unsolicited commercial email) or virus senders. These pages can also help you troubleshoot inbound connections to the system (including important information such as IP Reputation score and most recent sender group match for domains).

These pages help you classify mail relative to the appliance , and also relative to the services that exist beyond the scope of the gateway, such as the IP Reputation Service, the Anti-Spam scanning service, the Anti-Virus scanning security services, content filters, and Outbreak Filters.

You can generate a printer-friendly formatted .PDF version of any of the Email Security Monitor pages by clicking on the Printable PDF link at the top-right of the page. For information about generating PDFs in languages other than English, see the [Notes on Reports, on page 882](#).

You can export graphs and other data to CSV (comma separated values) format via the **Export** link.

The exported CSV data will display all message tracking and reporting data in GMT regardless of what is set on the appliance . The purpose of the GMT time conversion is to allow data to be used independently from the appliance or when referencing data from appliances in multiple time zones.



**Note** If you export localized CSV data, the headings may not render properly in some browsers. This occurs because some browsers may not use the correct character set for the localized text. To work around this problem, you can save the file to disk, and open the file using File > Open. When you open the file, select the character set to display the localized text.

For more information about automating the export of report data, see [Retrieving CSV Data, on page 839](#)).

#### List of Email Security Monitor Pages

- [My Dashboard Page](#) , on page 811
- [Overview Page](#), on page 812
- [Incoming Mail Page](#), on page 815
- [Outgoing Destinations](#), on page 821
- [Outgoing Senders](#), on page 821
- [Delivery Status Page](#), on page 822
- [Internal Users Page](#), on page 823
- [DLP Incidents Page](#), on page 824
- [Content Filters Page](#), on page 825
- [DMARC Verification Page](#), on page 826
- [Outbreak Filters Page](#), on page 827
- [Virus Types Page](#), on page 829
- [URL Filtering Page](#) , on page 829
- [Web Interaction Tracking Page](#), on page 830
- [File Reputation and File Analysis Reports](#), on page 831
- [TLS Connections Page](#), on page 831
- [Inbound SMTP Authentication Page](#), on page 832
- [Rate Limits Page](#) , on page 833
- [System Capacity Page](#), on page 833
- [System Status Page](#), on page 836

- [High Volume Mail Page](#), on page 838
- [Message Filters Page](#), on page 838
- [Geo Distribution Page](#), on page 822
- [Safe Print Page](#), on page 839

## Searching and Email Security Monitor

Many of the Email Security Monitor pages include a search form. You can search for different types of items:

- IP Address (IPv4 and IPv6)
- domain
- network owner
- internal users
- destination domain
- internal sender domain
- internal sender IP address
- outgoing domain deliver status

For domain, network owner, and internal user searches, choose whether to exactly match the search text or look for items starting with the entered text (for instance, starts with “ex” will match “example.com”).

For IPv4 address searches, the entered text is always interpreted as the beginning of up to four IP octets in dotted decimal format. For instance, “17” will search in the range 17.0.0.0 through 17.255.255.255, so it will match 17.0.0.1 but not 172.0.0.1. For an exact match search, simply enter all four octets. IP address searches also support CIDR format (17.16.0.0/12).

For IPv6 address searches, AsyncOS supports the following formats:

- 2001:db8:2004:4202::0-2001:db8:2004:4202::ff
- 2001:db8:2004:4202::
- 2001:db8:2004:4202::23
- 2001:db8:2004:4202::/64

All searches are bounded by the time range currently selected on the page.

## Viewing Details of Messages Included in Reports

This functionality works only if reporting and tracking are both local (not centralized on a Cisco Content Security Management Appliance .)

### Procedure

- 
- Step 1** Click any blue number in a table on a report page.  
(Not all tables have these links.)  
The messages included in that number are displayed in Message Tracking.



**Step 2** Scroll down to see the list.

### What to do next

#### Related Topics

- [Working with Message Tracking Search Results , on page 893](#)

## My Dashboard Page

You can create a custom email securityreport page by assembling charts (graphs) and tables from existing report pages.

| To                                           | Do This                                                                                                                                                                                                                                                                                                                                                                                                                                                                                                                                                                                                                                                                                                                                                                                                                                                                                                                                                                                                                                                                                                                                                                                                                                                                                                                                                                                                                                                                                                                                                                        |
|----------------------------------------------|--------------------------------------------------------------------------------------------------------------------------------------------------------------------------------------------------------------------------------------------------------------------------------------------------------------------------------------------------------------------------------------------------------------------------------------------------------------------------------------------------------------------------------------------------------------------------------------------------------------------------------------------------------------------------------------------------------------------------------------------------------------------------------------------------------------------------------------------------------------------------------------------------------------------------------------------------------------------------------------------------------------------------------------------------------------------------------------------------------------------------------------------------------------------------------------------------------------------------------------------------------------------------------------------------------------------------------------------------------------------------------------------------------------------------------------------------------------------------------------------------------------------------------------------------------------------------------|
| Add modules to your custom report page       | <ol style="list-style-type: none"> <li>1. Go to <b>Monitor &gt; My Dashboard</b> and delete any sample modules that you do not need by clicking the <b>[X]</b> in the top right corner of the module.</li> <li>2. Do one of the following: <ul style="list-style-type: none"> <li>• Click the <b>[+]</b> button on a module in a report page under the Monitor menu to add it to your custom report.</li> <li>• Go to <b>Monitor &gt; My Dashboard</b>, click the <b>[+]</b> button in one of the sections, then select the report module that you want to add. You may need to check the <b>+ Report Module in</b> each section to find the report that you are looking for.</li> </ul> </li> <li>3. Modules are added with default settings. If you add a module that you have customized (for example, by adding, deleting, or reordering columns ), customize these modules again after adding them. Time range of the original module is not maintained.</li> <li>4. If you add a chart that includes a separate legend (for example, a graph from the Overview page), add the legend separately. If necessary, drag and drop it into position beside the data it describes.</li> </ol> <p>Notes:</p> <ul style="list-style-type: none"> <li>• Some modules on some report pages are available only using one of the above methods. If you cannot add a module using one method, try the other method.</li> <li>• You can add each module only once; if you have already added a particular module to your report, the option to add it will not be available.</li> </ul> |
| View your custom report page                 | <ol style="list-style-type: none"> <li>1. Choose <b>Monitor &gt; My Dashboard</b></li> <li>2. For reports in the Time Range section: The time range selected for all report pages applies to all modules on the My Dashboard page. Select the time range to view.</li> </ol> <p>Newly-added modules appear at the top of the relevant section.</p>                                                                                                                                                                                                                                                                                                                                                                                                                                                                                                                                                                                                                                                                                                                                                                                                                                                                                                                                                                                                                                                                                                                                                                                                                             |
| Rearrange modules on your custom report page | Drag and drop modules into the desired location.                                                                                                                                                                                                                                                                                                                                                                                                                                                                                                                                                                                                                                                                                                                                                                                                                                                                                                                                                                                                                                                                                                                                                                                                                                                                                                                                                                                                                                                                                                                               |

| To                                          | Do This                                              |
|---------------------------------------------|------------------------------------------------------|
| Delete modules from your custom report page | Click the [X] in the top right corner of the module. |

## Overview Page

The Overview page provides a synopsis of the message activity of your appliance, including an overview of your quarantines and Outbreak Filters status (in the System Overview section of the page). The Overview page also includes graphs and detailed message counts for incoming and outgoing messages. You can use this page to monitor the flow of all mail into and out of your gateway.

The Overview page highlights how the appliance is integrated with the IP Reputation Service for incoming mail (messages stopped by reputation filtering, for example). On the **Overview** page, you can:

- View a mail trend graph of all mail “flowing” into or out of your gateway.
- View a graph showing the number of attempted messages, messages stopped by IP reputation filtering, messages with invalid recipients, messages marked as spam, messages marked as virus positive, and clean messages, over time.
- View the summary of the system status and local quarantines.
- See current virus and non-virus outbreak information based on information available at the Threat Operations Center (TOC).

The Overview page is divided into two sections: System Overview and Incoming and Outgoing Mail graphs and summary.

### Related Topics

- [System Overview](#), on page 812
- [Incoming and Outgoing Summary and Graph](#), on page 813
- [Categorizing Email](#), on page 814
- [How Messages are Categorized](#), on page 815

## System Overview

The System Overview section of the Overview page serves as a system dashboard, providing details about the appliance including system and work queue status, quarantine status, and outbreak activity.

### Related Topics

- [Status](#), on page 812
- [System Quarantines](#), on page 813
- [Virus Threat Level](#), on page 813

## Status

This section provides an overview of the current state of the appliance and inbound mail processing.

**System Status:** One of the following states:

- Online
- Resource Conservation
- Delivery Suspended

- Receiving Suspended
- Work Queue Paused
- Offline

See the [Managing and Monitoring Using the CLI, on page 1063](#) for more information.

**Incoming Messages:** The average rate of incoming mail per hour.

**Work Queue:** The number of messages awaiting processing in the work queue.

Click the System Status Details link to navigate to the System Status page.

## System Quarantines

This section displays information about the top three quarantines by disk usage on the appliance, including the name of the quarantine, how full the quarantine is (disk space), and the number of messages currently in the quarantine.

Click the Local Quarantines link to navigate to the Local Quarantines page.

## Virus Threat Level

This section shows the Outbreak status as reported by the Threat Operations Center (TOC). Also shown is the status of the Outbreak quarantine, including how full it is (disk space) and the number of messages in the quarantine. The Outbreak quarantine is only displayed if you have enabled the Outbreak Filters feature on your appliance .



---

**Note** In order for the Threat Level indicator to function, you need to have port 80 open on your firewall to “[downloads.ironport.com](#).” Alternatively, if you have specified a local update server, the Threat Level indicator will attempt to use that address. The Threat Level indicator will also update correctly if you have configured a proxy for downloads via the Service Updates page. For more information, see [Service Updates, on page 1003](#).

---

Click the Outbreak Details link to view the external Threat Operations Center web site. Note that in order for this link to work, your appliance must be able to access the Internet. Note that the Separate Window icon indicates that a link will open in a separate window when clicked. You may need to configure your browser’s pop-up blocker settings to allow these windows.

## Incoming and Outgoing Summary and Graph

The Incoming and Outgoing summary sections provide access to real-time activity of all mail activity on your system and is comprised of the Incoming and Outgoing Mail Graphs and Mail Summaries. You can select the time frame on which to report via the Time Range menu. The time range you select is used throughout all of the Email Security Monitor pages. The explanations of each type or category of message are below (see [Categorizing Email, on page 814](#)).

While the mail trend graph displays a visual representation of the mail flow, the summary table provides a numeric breakdown of the same information. The summary table includes the percentage and actual number of each type of message, including the total number of attempted, threat, and clean messages.

The outgoing graph and summary show similar information for outbound mail.

## Related Topics

- [Notes on Counting Messages in Email Security Monitor, on page 814](#)

## Notes on Counting Messages in Email Security Monitor

The method Email Security Monitor uses to count incoming mail depends on the number of recipients per message. For example, an incoming message from example.com sent to three recipients would count as three messages coming from that sender.

Because messages blocked by sender reputation filtering do not actually enter the work queue, the appliance does not have access to the list of recipients for an incoming message. In this case, a multiplier is used to estimate the number of recipients. This multiplier was determined by Cisco and based upon research of a large sampling of existing customer data.

## Categorizing Email

Messages reported in the Overview and Incoming Mail pages are categorized as follows:

- **Stopped by IP Reputation Filtering:** All connections blocked by HAT policies multiplied by a fixed multiplier (see [Notes on Counting Messages in Email Security Monitor, on page 814](#)) plus all recipients blocked by recipient throttling.
- **Invalid Recipients:** All recipients rejected by conversational LDAP rejection plus all RAT rejections.
- **Spam Messages Detected:** The total count of messages detected by the anti-spam scanning engine as positive or suspect and also those that were both spam and virus positive.
- **Virus Messages Detected:** The total count and percentage of messages detected as virus positive and not also spam.



---

**Note** If you have configured your anti-virus settings to deliver unscannable or encrypted messages, these messages will be counted as clean messages and not virus positive. Otherwise, the messages are counted as virus positive.

---

- **Detected by Advanced Malware Protection:** A message attachment was found to be malicious by file reputation filtering. This value does not include verdict updates or files found to be malicious by file analysis.
- **Messages with Malicious URLs:** One or more URLs in the message were found to be malicious by URL filtering.
- **Stopped by Content Filter:** The total count of messages that were stopped by a content filter.
- **Stopped by DMARC:** The total count of messages that were stopped after DMARC verification.
- **S/MIME Verification/Decryption Failed:** The total count of messages that failed S/MIME verification, decryption, or both.
- **S/MIME Verification/Decryption Successful:** The total count of messages that were successfully verified, decrypted, or decrypted and verified using S/MIME.
- **Clean Messages:** Mail that is accepted and is deemed to be virus and spam free — the most accurate representation of clean messages accepted when taking per-recipient scanning actions (such as splintered messages being processed by separate mail policies) into account. However, because messages that are marked as spam or virus positive and still delivered are not counted, the actual number of messages delivered may differ from the clean message count.
- Graymail Messages

- **Marketing Messages:** The total count of advertising messages sent by professional marketing groups, for example Amazon.com.
- **Social Networking Messages:** The total count of notification messages from social networks, dating websites, forums, and so on. Examples include LinkedIn and CNET forums.
- **Bulk Messages:** The total count of advertising messages sent by unrecognized marketing groups, for example, TechTarget, a technology media company.

Click on the number corresponding to any of the above mentioned graymail categories to view a list of messages belonging to that category using Message Tracking.



---

**Note** Messages that match a *message* filter and are not dropped or bounced by the filter are treated as clean. Messages dropped or bounced by a message filter are not counted in the totals.

---

## How Messages are Categorized

As messages proceed through the email pipeline, they can apply to multiple categories. For example, a message can be marked as spam, virus, or malware positive, and it can also match a content filter. The various verdicts follow these rules of precedence: Outbreak Filters quarantining (in this case the message is not counted until it is released from the quarantine and again processed through the work queue), followed by spam positive, virus positive, malware positive, and matching a content filter.

For example, if a message is marked as spam positive, and the anti-spam settings are set to drop spam positive messages, the message is dropped and the spam counter is incremented. Further, if the anti-spam settings are set to let the spam positive message continue on in the pipeline, and a subsequent content filter drops, bounces, or quarantines the message, the spam count is still incremented. The content filter count is only incremented if the message is not spam, virus, or malware positive.

## Incoming Mail Page

The **Incoming Mail** page provides a mechanism to report on the real-time information being collected by the Email Security Monitor feature for all remote hosts connecting to your appliance. This allows you to gather more information about an IP address, domain, and organization (network owner) sending mail to you. You can perform a Sender Profile search on IP addresses, domains, or organizations that have sent mail to you.

The Incoming Mail page has three views: Domain, IP Address, and Network Owner and provides a snapshot of the remote hosts connecting to the system in the context of the selected view.

It displays a table (Incoming Mail Details) of the top domains (or IP addresses, or network owners, depending on the view) that have sent mail to all public listeners configured on the appliance. You can monitor the flow of all mail into your gateway. You can click on any domain/IP/network owner to drill down to access details about this sender on a Sender Profile page (this is an Incoming Mail page, specific to the domain/IP/network owner you clicked on).

Not all available columns are displayed by default. You can show a different set of information by clicking the Columns link below the table. For example, you can show the "Detected by Advanced Malware Protection" column, which is hidden by default.

The Incoming Mail page extends to include a group of pages (Incoming Mail, Sender Profiles, and the Sender Group Report). From the **Incoming Mail** pages, you can:

- Perform a search on IP addresses, domains, or organizations (network owners) that have sent mail to you.
- View the Sender Groups report to see connections via a specific sender group and mail flow policy actions. See [Sender Groups Report, on page 820](#) for more information.
- See detailed statistics on senders which have sent mail to you, including the number of attempted messages broken down by security service (sender reputation filtering, anti-spam, anti-virus, graymail, and so on).
- Sort by senders who have sent you a high volume of spam or virus email, as determined by anti-spam or anti-virus security services.
- Use the IP Reputation service to drill down on and examine the relationship between specific IP addresses, domains, and organizations to obtain more information about a sender.
- Drill down on specific senders to obtain more information about a sender from the IP Reputation Service, including a sender's IP Reputation Score and which sender group the domain matched most recently. Add senders to sender groups.
- Drill down on a specific sender who sent a high volume of spam or virus email, as determined by the anti-spam or anti-virus security services.
- Once you have gathered information on a domain, you can add the IP address, domain, or organization to an existing sender group (if necessary) by clicking "Add to Sender Group" from a domain, IP address, or network owner profile page. See [Configuring the Gateway to Receive Email, on page 69](#).

#### Related Topics

- [Incoming Mail, on page 816](#)
- [Incoming Mail Details Listing, on page 817](#)
- [Reporting Pages Populated with Data: Sender Profile Pages, on page 818](#)
- [Sender Groups Report, on page 820](#)

## Incoming Mail

The Incoming Mail page provides access to real-time activity of all public listeners configured on your system and is comprised of two main sections: the mail trend graphs summarizing the top sender domains received (by total threat messages, total clean messages, and total graymail messages) and the Incoming Mail Details listing.

See [Incoming Mail Details Listing, on page 817](#) for an explanation of the data included in the Incoming Mail Details listing.

#### Related Topics

[Notes on Time Ranges in the Mail Trend Graph, on page 816](#)

### Notes on Time Ranges in the Mail Trend Graph

The Email Security Monitor feature constantly records data about the mail flowing into your gateway. The data are updated every 60 seconds, but the display shown is delayed by 120 seconds behind the current system time. You can specify the time range to include in the results shown. Because the data is monitored in real time, information is periodically updated and summarized in the database.

Choose from the time range options in the following table.

**Table 84: Time Ranges Available in the Email Security Monitor Feature**

| This time range selected in the GUI | ...is defined as:                                                                        |
|-------------------------------------|------------------------------------------------------------------------------------------|
| Hour                                | the last 60 minutes + up to 5 minutes                                                    |
| Day                                 | the last 24 hours + the last 60 minutes                                                  |
| Week                                | the last 7 days + the elapsed hours of the current day                                   |
| 30 days                             | the last 30 days + the elapsed hours of the current day                                  |
| 90 days                             | the last 90 days + the elapsed hours of the current day                                  |
| Yesterday                           | 00:00 to 23:59 (midnight to 11:59 PM)                                                    |
| Previous Calendar Month             | 00:00 of the first day of the month to 23:59 of the last day of the month                |
| Custom Range                        | the range enclosed by the start date and hour and the end date and hour that you specify |

The time range options that you see will differ if you have enabled Centralized Reporting. For details, see information about Centralized Reporting Mode in [Centralizing Services on a Cisco Content \(M-Series\) Security Management Appliance](#), on page 1249

## Incoming Mail Details Listing

The top senders which have connected to public listeners of the appliance are listed in the External Domains Received listing table at the bottom of the Incoming Mail page, based on the view selected. Click the column headings to sort the data. See [Categorizing Email](#), on page 814 for an explanation of the various categories.

The system acquires and verifies the validity of the remote host's IP address (that is, the domain) by performing a *double DNS lookup*. For more information about double DNS lookups and sender verification, see [Configuring the Gateway to Receive Email](#), on page 69.

The Sender Detail listing has two views, Summary and All.

The default Sender Detail view shows the total number of attempted messages for each sender, and includes a breakdown by category (the same categories as the Incoming Mail Summary graph on the Overview page.

The value for Stopped by IP Reputation Filtering is calculated based on several factors:

- Number of “throttled” messages from this sender.
- Number of rejected or TCP refused connections (may be a partial count).
- A conservative multiplier for the number of messages per connection.

When the appliance is under heavy load, an exact count of rejected connections is not maintained on a per-sender basis. Instead, rejected connections counts are maintained only for the most significant senders in each time interval. In this situation, the value shown can be interpreted as a “floor”; in other words, at least this many messages were stopped.



**Note** The Stopped by IP Reputation Filtering total on the Overview page is always based on a complete count of all rejected connections. Only the per-sender connection counts are ever limited due to load.

Additional columns that you can display are:

**Connections Rejected:** All connections blocked by HAT policies. When the appliance is under heavy load, an exact count of rejected connections is not maintained on a per-sender basis. Instead, rejected connections counts are maintained only for the most significant senders in each time interval.

**Connections Accepted:** All connections accepted

**Stopped by Recipient Throttling:** This is a component of Stopped by Reputation Filtering. It represents the number of recipient messages stopped because any of the following HAT limits have been exceeded: maximum recipients per hour, maximum recipients per message, or maximum messages per connection. This is summed with an estimate of the recipient messages associated with rejected or TCP refused connections to yield Stopped by Reputation Filtering.

**Detected by Advanced Malware Protection:** Messages with attachments that were found to be malicious by file reputation filtering. This value does not include verdict updates or files found to be malicious by file analysis.

**Total Threat:** Total number of threat messages (stopped by sender reputation, stopped as invalid recipient, spam, plus virus).

Show or hide columns by clicking the Column link at the bottom of the table.

Sort the listing by clicking the column header links. A small triangle beside the column header indicates the column by which the data is currently sorted.

### Related Topics

- ["No Domain Information", on page 818](#)
- [Querying for More Information, on page 818](#)

## "No Domain Information"

Domains which have connected to the appliance and could not be verified with a double-DNS lookup are automatically grouped into the special domain "No Domain Information." You can control how these types of unverified hosts are managed via Sender Verification. See [Configuring the Gateway to Receive Email, on page 69](#).

You can select the number of senders to show in the listing via the Items Displayed menu.

## Querying for More Information

For senders listed in the Email Security Monitor table, click the sender (or "No Domain Information" link) to drill down for more information on the particular sender. The results are displayed on a Sender Profile page which includes real-time information from the IP Reputation Service. From the Sender Profile page, you can drill down for more information on specific IP addresses or network owners (see [Reporting Pages Populated with Data: Sender Profile Pages, on page 818](#)).

You can also view another report, the Sender Groups report, by clicking the Sender Groups report link at the bottom of the Incoming Mail page. For more information about Sender Groups reports, see [Sender Groups Report, on page 820](#).

## Reporting Pages Populated with Data: Sender Profile Pages

If you clicked a sender in the Incoming Mail Details table on an Incoming Mail page, the resulting *Sender Profile page* is listed with data for the particular IP address, domain, or organization (network owner). Sender Profile pages show detailed information for the sender. You can access a Sender Profile page for any network



owner, domain, or IP address by clicking on the specified item in the Incoming Mail or other Sender Profile pages. Network owners are entities that contain domains; domains are entities that contain IP addresses. For more information on this relationship and how it relates to the IP Reputation Service, see [Configuring the Gateway to Receive Email, on page 69](#).

The Sender Profile pages displayed for IP addresses, network owners, and domains vary slightly. For each, the page contains a graph and summary table for incoming mail from this sender. Below the graph is a table listing domains or IP addresses associated with the sender (the Sender Profile page for individual IP addresses does not contain the detailed listing) and an information section with the current SenderBase, sender group, and network information for the sender.

- Network Owner profile pages contain information for the network owner, as well as the domains and IP addresses associated with that network owner.
- Domain profile pages contain information for the domains and IP addresses associated with that domain.
- IP address profile pages contain information about the IP address only.

Each sender profile page contains the following data in the Current Information table at the bottom of the page:

- The **Global** information from the IP Reputation Service, including:
  - IP Address, Domain Name, and/or Network Owner
  - Network Owner Category (Network Owner Only)
  - CIDR Range (IP addresses only)
  - Daily Magnitude and Monthly Magnitude for the IP address, Domain, and/or Network Owner
  - Days since the first message was received from this sender
  - Last sender group and whether DNS verified (IP Address sender profile page only)

Daily magnitude is a measure of how many messages a domain has sent over the last 24 hours. Similar to the Richter scale used to measure earthquakes, SenderBase magnitude is a measure of message volume calculated using a log scale with a base of 10. The maximum theoretical value of the scale is set to 10, which equates to 100% of the world's email message volume (approximately 10 billion messages/day). Using the log scale, a one-point increase in magnitude equates to a 10x increase in actual volume.

Monthly magnitude is calculated using the same approach as daily magnitude, except the percentages are calculated based on the volume of email sent over the last 30 days.

- Average Magnitude (IP addresses only)
- Lifetime Volume / 30 Day Volume (IP address profile pages only)
- Bonded Sender Status (IP address profile pages only)
- IP Reputation Score (IP address profile pages only)
- Days Since First Message (network owner and domain profile pages only)
- Number of Domains Associated with this Network Owner (network owner and domain profile pages only)
- Number of IP Addresses in this Network Owner (network owner and domain profile pages only)
- Number of IP Addresses used to Send Email (network owner pages only)

Click the “More from SenderBase” link to see a page with all information supplied by the IP Reputation Service.

- The **Mail Flow Statistics** information, with Email Security Monitor information collected about the sender over the time range that you specify.
- **Details** about the domains and IP addresses controlled by this network owner are displayed on network owner profile pages. Details about the IP addresses in the domain are displayed on domain pages.

From a domain profile page, you can drill down to a specific IP address, or drill up to view an organization profile page. You can also display the DNS Verified status, IP Reputation Score, and Last Sender Group for each sender address in the IP Addresses table by clicking the Columns link at the bottom of that table. You can also hide any columns in that table.

From a network owner profile page, you can display information such as Connections Rejected, Connections Accepted, Stopped by Recipient Throttling, and Detected by Advanced Malware Protection for each domain in the Domains table by clicking the Columns link at the bottom of that table. You can also hide any columns in that table.

If you are an administrator of the system, on each of these pages, you can choose to add the network owner, domain, or IP address to a sender group by clicking the check box for the entity (if necessary) and then clicking Add to Sender Group.

You can also add a sender to a sender group by clicking the **Add to Sender Group** link below the Sender Group Information in the Current Information table for the sender and clicking Add to Sender Group. For more information about adding senders to sender groups, see [Configuring the Gateway to Receive Email, on page 69](#). Of course, you do not have to make any changes — you can let the security services handle incoming mail.

### Related Topics

- [Sender Profile Search, on page 820](#)

## Sender Profile Search

Type an IP address, a domain, or an organization name in the Quick Search box to search for a specific sender.

A Sender Profile page is displayed with the information for sender. See [Reporting Pages Populated with Data: Sender Profile Pages, on page 818](#).

## Sender Groups Report

The Sender Groups report provides a summary of connections by sender group and mail flow policy action, allowing you to review SMTP connection and mail flow policy trends. The Mail Flow by Sender Group listing shows the percentage and number of connections for each sender group. The Connections by Mail Flow Policy Action chart shows the percentage of connections for each mail flow policy action. This page provides an overview of the effectiveness of your Host Access Table (HAT) policies. For more information about the HAT, see [Configuring the Gateway to Receive Email, on page 69](#).

## Sender Domain Reputation Page

You can use the Sender Domain Reputation report page to view:

- Incoming messages based on the verdict received from the SDR service in graphical format.
- Summary of incoming messages based on the threat category and verdict received from the SDR service in tabular format.
- Incoming messages based on the threat category received from the SDR service in graphical format.



---

**Note** Only the messages whose SDR verdict is 'awful' or 'poor' are classified under the SDR threat category, such as, 'spam,' 'malicious,' etc.

---

- Summary of incoming messages based on the threat category received from the SDR service in tabular format.

In the Summary of Incoming Messages handled by SDR section, you can click on the number of messages corresponding to a particular verdict to view the related messages in Message Tracking.

## Outgoing Destinations

The Outgoing Destinations page provides information about the domains your company sends mail to. The page consists of two sections. The top half of the page consists of graphs depicting the top destinations by outgoing threat messages and top destinations by outgoing clean messages on the top half of the page. The bottom half of the page displays a chart showing all the columns sorted by total recipients (default setting).

You can select a time range on which to report, such as an hour, a week, or a custom range. As with all reports, you can export the data for the graphs or the details listing to CSV format via the **Export** link.

The Outgoing Destinations page can be used to answer the following types of questions:

- What domains is the appliance sending mail to?
- How much mail is sent to each domain?
- How much of that mail is clean, spam-positive, virus-positive, malware or stopped by a content filter?
- How many messages are delivered and how many messages are hard-bounced by the destination server?

## Outgoing Senders

The Outgoing Senders page provides information about the quantity and type of mail being sent from IP addresses and domains in your network. You can view the results by domain or IP address when you view this page. You might want to view the results by domain if you want to see what volume of mail is being sent by each domain, or you might want to view the results by IP address if you want to see which IP addresses are sending the most virus messages or triggering content filters.

The page consists of two sections. On the left side of the page is a graph depicting the top senders by total threat messages. Total threat messages include messages that are spam-positive, virus-positive, malware or triggered a content filter. On the right side of the page is a graph displaying top senders by clean messages on the top half of the page. The bottom half of the page displays a chart showing all the columns sorted by total messages (default setting).



---

**Note** This page does not display information about message delivery. Delivery information, such as how many messages from a particular domain were bounced can be tracked using the Delivery Status page.

---

You can select a time range on which to report, such as an hour, a week, or a custom range. As with all reports, you can export the data for the graphs or the details listing to CSV format via the **Export** link.

The Outgoing Senders page can be used to answer the following types of questions:

- Which IP addresses are sending the most virus-positive, spam-positive or malware email?
- Which IP addresses trigger content filters the most frequently?
- Which domains are sending the most mail?

## Geo Distribution Page

You can use the Geo Distribution report page to view:

- Top incoming mail connections based on country of origin in graphical format.
- Total incoming mail connections based on country of origin in tabular format.

You can click on the number of incoming mail connections of a specific geolocation to view the related messages in Message Tracking.

The "Total Messages" column only displays those messages that are accepted at the SMTP connection level.



---

**Note** During report generation:

- If one or more incoming mail connections are detected as private IP address, the incoming mail connections are categorized as “Private IP Addresses” in the report.
  - If one or more incoming mail connections are detected as not a valid IP Reputation score, the incoming mail connections are categorized as ‘No Country Info’ in the report.
- 

## Delivery Status Page

If you suspect delivery problems to a specific recipient domain or if you want to gather information on a Virtual Gateway address, the Monitor > Delivery Status Page provides monitoring information about email operations relating to a specific recipient domain.

The **Delivery Status Page** displays the same information as the `tophosts` command within the CLI. (For more information, see “Determining the Make-up of the Email Queue” in [Managing and Monitoring Using the CLI, on page 1063](#))

This page displays a list of the top 20, 50, or 100 recipient domains for messages delivered by the system within the last three hours. You can sort by latest host status, active recipients (the default), connections out, delivered recipients, soft bounced events, and hard bounced recipients by clicking the links in the column heading for each statistic.

- To search for a specific domain, type the name of the domain in the Domain Name: field and click **Search**.
- To drill down on a domain shown, click the domain name link.

The results are shown in an Delivery Status Details Page.



---

**Note** Any activity for a recipient domain results in that domain being “active” and thus present in the overview page. For example, if mail remains in the outbound queue due to delivery problems, that recipient domain continues to be listed in the outgoing mail overview.

---

### Related Topics

- [Retrying Delivery, on page 823](#)
- [Delivery Status Details Page, on page 823](#)

## Retrying Delivery

Messages that are scheduled for later delivery can be immediately retried by clicking **Retry All Delivery**. Retry All Delivery allows you to reschedule messages in the queue for immediate delivery. All domains that are marked as “down” and any scheduled or soft bounced messages are queued for immediate delivery.

To retry delivery to a specific destination domain, click the domain name link. On the Delivery Status Details page, click **Retry Delivery**.

You can also use the `delivernow` command in the CLI to reschedule messages for immediate delivery. For more information, see [Scheduling Email for Immediate Delivery, on page 1085](#).

## Delivery Status Details Page

Use the **Delivery Status Details Page** to look up statistics on a specific recipient domain. This page displays the same information as the `hoststatus` command within the CLI: Mail Status, Counters and Gauges. (For more information, see [Managing and Monitoring Using the CLI, on page 1063](#)) To search for a specific domain, type the name of the domain in the Domain Name: field and click **Search**. Virtual Gateway address information appears if you are using the `altsrchost` feature.

## Internal Users Page

The Internal Users page provides information about the mail sent and received by your internal users, *per email address* (a single user may have multiple email addresses listed — the email addresses are not combined in the report).

The page consists of two sections:

- Graphs depicting the top users by clean incoming and outgoing messages and top users receiving graymail.
- User mail flow details

You can select a time range on which to report (hour, day, week, or month). As with all reports, you can export the data for the graphs or the details listing to CSV format via the **Export** link. You can also display hidden table columns or hide default columns by clicking the Columns link below the table.

The User Mail Flow Details listing breaks down the mail received and sent by each email address into clean, spam (incoming only), virus, malware, content filter matches, and graymail (incoming only). You can sort the listing by clicking on the column headers.

Using the Internal Users report, you can answer these kinds of questions:

- Who is sending the most external email?
- Who receives the most clean email?
- Who receives the most number of graymail messages?
- Who receives the most spam?
- Who is triggering which content filters?
- Whose email is getting caught by content filters?

Inbound Internal Users are the users for which you received email, based on the Rcpt To: address. Outbound Internal Users are based on the Mail From: address and are useful when tracking the types of email that senders on your internal network are sending.

Note that some outbound mail (like bounces) have a null sender. They are counted under outbound and “unknown.”

Click on an internal user to view the Internal User detail page for that user.

Click the Columns link below the table to show columns that are hidden by default, such as the Incoming Detected by Advanced Malware Protection column or Outgoing Detected by Advanced Malware Protection column.

### Related Topics

- [Internal User Details, on page 824](#)
- [Searching for a Specific Internal User, on page 824](#)

## Internal User Details

The Internal User detail page shows detailed information about the specified user, including a breakdown of incoming and outgoing messages showing the number of messages in each category (spam detected, virus detected, detected by Advanced Malware Protection, stopped by content filter, graymail detected, and clean). Optionally, for incoming messages, you can click the Columns link below the table to show the Incoming Detected by Advanced Malware Protection column. This value reflects the number messages that contained attachments that were determined by file reputation filtering to be malicious. It does not include verdict updates or files found to be malicious by file analysis. Incoming and outgoing content filter and DLP policy matches are also shown.

Click on a content filter name to view detailed information for that filter in the corresponding content filter information page (see [Content Filters Page, on page 825](#)). You can use this method to get a list of users who also sent or received mail that matched that particular content filter.

## Searching for a Specific Internal User

You can search for a specific internal user (email address) via the search form at the bottom of the Internal Users page and the Internal User detail page. Choose whether to exactly match the search text or look for items starting with the entered text (for instance, starts with “ex” will match “example.com”).

## DLP Incidents Page

The DLP Incidents page shows information on the incidents of data loss prevention (DLP) policy violations occurring in outgoing mail. The appliance uses the DLP email policies enabled in the Outgoing Mail Policies table to detect sensitive data sent by your users. Every occurrence of an outgoing message violating a DLP policy is reported as an incident.

Using the DLP Incidents report, you can answer these kinds of questions:

- What type of sensitive data is being sent by your users?
- How severe are these DLP incidents?
- How many of these messages are being delivered?
- How many of these messages are being dropped?
- Who is sending these messages?

The DLP Incidents page is comprised of two main sections:

- the DLP incident trend graphs summarizing the top DLP incidents by severity (Low, Medium, High, Critical) and policy matches, and
- the DLP Incidents Details listing.

You can select a time range on which to report, such as an hour, a week, or a custom range. As with all reports, you can export the data for the graphs or the details listing to CSV format via the **Export** link or PDF format by clicking the **Printable (PDF)** link. For information about generating PDFs in languages other than English, see the [Notes on Reports, on page 882](#).

Click on the name of a DLP policy to view detailed information on the DLP incidents detected by the policy. You can use this method to get a list of users who sent mail that contained sensitive data detected by the policy.

### Related Topics

- [DLP Incidents Details, on page 825](#)
- [DLP Policy Detail Page, on page 825](#)

## DLP Incidents Details

The DLP policies currently enabled in the appliance's outgoing mail policies are listed in the DLP Incidents Details table at the bottom of the DLP Incidents page. Click on the name of a DLP policy to view more detailed information.

The DLP Incidents Details table shows the total number of DLP incidents per policy, with a breakdown by severity level. The severity level also includes the number of bounced messages and the number of messages delivered in the clear, delivered encrypted, or dropped. Click on the column headings to sort the data.

## DLP Policy Detail Page

If you clicked the name of a DLP policy in the DLP Incidents Details table, the resulting DLP Policy Detail page displays the DLP incidents data for the policy. The page displays graphs on the DLP incidents based on severity.

The page also includes an Incidents by Sender listing at the bottom of the page that lists each internal user who has sent a message that violated the DLP policy. The listing also shows the total number of DLP incidents for this policy per user, with a breakdown by severity level, and whether any of the messages were delivered in the clear, delivered encrypted, or dropped. You can use the Incidents by Sender listing to find out which users may be sending your organization's sensitive data to people outside your network.

Clicking on the sender name opens up the Internal Users page. See [Internal Users Page, on page 823](#) for more information.

## Content Filters Page

The Content Filters page shows information about the top incoming and outgoing content filter matches (which content filter had the most matching messages) in two forms: a bar chart and a listing. Using the Content Filters page, you can review your corporate policies on a per-content filter or per-user basis and answer questions like:

- Which content filter is being triggered the most by incoming or outgoing mail?
- Who are the top users sending or receiving mail that is triggering a particular content filter?

You can click the name of the content filter in the listing to view more information about that filter on the Content Filter detail page.

### Related Topics

- [Content Filter Details, on page 826](#)

## Content Filter Details

The Content Filter detail page displays matches for that filter over time, as well as matches by internal user.

In the Matches by Internal User section, you can click the name of a user to view that internal user's (email address) Internal User details page (see [Internal User Details, on page 824](#)).

## DMARC Verification Page

The DMARC Verification page shows the top domains that failed DMARC verification and the details of actions AsyncOS performed on the messages that failed DMARC verification. You can use this report to fine-tune your DMARC settings and answer these kinds of questions:

- Which are the domains that sent maximum number of messages that are not DMARC compliant?
- For each domain, what are the actions AsyncOS performed on the messages that failed DMARC verification?

The DMARC Verification page contains:

- A bar chart showing top domains by DMARC verification failures.
- Tabular representation of the following, for each domain:
  - Number of messages that were rejected, quarantined, or accepted without taking any action. Click on the number to view a list of messages under the selected category.
  - Number messages that passed DMARC verification.
  - Total number of DMARC verification attempts.

You can select a time range on which to report, such as an hour, a week, or a custom range. As with all reports, you can export the data for the graphs or the details listing to CSV format via the **Export** link or PDF format by clicking the **Printable (PDF)** link.

## Macro Detection Page

You can use the Macro Detection report page to view:

- Top Incoming Macro-Enabled Attachments by File Type in graphical and tabular format.
- Top Outgoing Macro-Enabled Attachments by File Type in graphical and tabular format.

You can click on the number of macro-enabled attachments to view the related messages in Message Tracking.





- Note** During report generation:
- If one or more macros are detected within an archive file, the Archive Files file type is incremented by one. The number of macro-enabled attachments within an archive file are not counted.
  - If one or more macros are detected within an embedded file, the parent file type is incremented by one. The number of macro-enabled attachments within an embedded file are not counted.

## External Threat Feeds Page

You can use the External Threat Feeds report page to view:

- Top ETF sources used to detect threats in messages in graphical format
- Summary of ETF sources used to detect threats in messages in tabular format.
- Top IOCs that matched threats detected in messages in graphical format.
- Top ETF sources used to filter malicious incoming mail connections in graphical format.
- Summary of ETF sources used to filter malicious incoming mail connections in tabular format.

In the ‘Summary of External Threat Feed Sources’ section:

- You can click on the number of messages for a particular ETF source to view the related messages in Message Tracking.
- You can click on a particular threat feed source to view the distribution of the ETF source based on the IOCs.

In the ‘Summary of Indicator of Compromise (IOC) Matches’ section:

- You can click on the number of IOCs for a particular ETF source to view the related messages in Message Tracking.
- You can click on a particular IOC to view the distribution of the IOC based on the ETF sources.

## Outbreak Filters Page

The Outbreak Filters page shows the current status and configuration of Outbreak Filters on your appliance as well as information about recent outbreaks and messages quarantined due to Outbreak Filters. You can use this page to monitor your defense against targeted virus, scam, and phishing attacks.

The Threats By Type section shows the different types of threat messages received by the appliance .

The Threat Summary section shows a breakdown of the threat messages by Malware, Phish, Scam, and Virus. Click on the number to view a list of all the messages that are included in that number using Message Tracking.

The Past Year Outbreak Summary lists global as well as local outbreaks over the past year, allowing you to compare local network trends to global trends. The listing of global outbreaks is a superset of all outbreaks, both viral and non-viral, whereas local outbreaks are limited to virus outbreaks that have affected your appliance . Local outbreak data does not include non-viral threats. Global outbreak data represents all outbreaks detected

by the Threat Operations Center which exceeded the currently configured threshold for the outbreak quarantine. Local outbreak data represents all virus outbreaks detected on this appliance which exceeded the currently configured threshold for the outbreak quarantine. The Total Local Protection Time is always based on the difference between when each virus outbreak was detected by the Threat Operations Center and the release of an anti-virus signature by a major vendor. Note that not every global outbreak affects your appliance. A value of "--" indicates either a protection time does not exist, or the signature times were not available from the anti-virus vendors (some vendors may not report signature times). This does not indicate a protection time of zero, rather it means that the information required to calculate the protection time is not available.

The Quarantined Messages section summarizes Outbreak Filters quarantining, and is a useful gauge of how many potential threat messages Outbreak Filters are catching. Quarantined messages are counted at time of release. Typically, messages will be quarantined before anti-virus and anti-spam rules are available. When released, they will be scanned by the anti-virus and anti-spam software and determined to be positive or clean. Because of the dynamic nature of Outbreak tracking, the rule under which a message is quarantined (and even the associated outbreak) may change while the message is in the quarantine. Counting the messages at the time of release (rather than the time of entry into the quarantine) avoids the confusion of having counts that increase and decrease.

The Threat Details listing displays information about specific outbreaks, including the threat category (virus, scam, or phishing), threat name, a description of the threat, and the number of messages identified. For virus outbreaks, the Past Year Virus Outbreaks include the Outbreak name and ID, time and date a virus outbreak was first seen globally, the protection time provided by Outbreak filters, and the number of quarantined messages. You can select either global or local outbreaks as well as the number of messages to display via the menu on the left. You can sort the listing by clicking on the column headers. Click on the number to view a list of all the messages that are included in that number using Message Tracking.

The First Seen Globally time is determined by the Threat Operations Center, based on data from SenderBase, the world's largest email and web traffic monitoring network. The Protection Time is based on the difference between when each threat was detected by the Threat Operations Center and the release of an anti-virus signature by a major vendor.

A value of "--" indicates either a protection time does not exist, or the signature times were not available from the anti-virus vendors (some vendors may not report signature times). This does not indicate a protection time of zero. Rather, it means that the information required to calculate the protection time is not available.

Hit Messages from Incoming Messages section shows the percentage and number of viral attachment, other threats (non-viral), and clean incoming messages.

Hit Messages by Threat Level section shows the percentage and number of incoming threat messages (viral and non-viral) based on threat levels (Level 1 through 5).

Messages resided in Outbreak Quarantine section shows the number of threat messages resided in the Outbreak Quarantine based on the duration.

Top URL's Rewritten section shows the list of top 10 URLs that were rewritten based on the number of occurrences. Use the Items Displayed drop-down to view more rewritten URLs. Click on the number to view a list of all the messages that contain the selected rewritten URL on the Message Tracking page.

Using the Outbreak Filters page, you can answer questions like:

- How many messages are being quarantined and what type of threats were they?
- How much lead time has the Outbreak Filter feature been providing for virus outbreaks?
- How do my local virus outbreaks compare to the global outbreaks?

## Virus Types Page

The Virus Types page provides an overview of the viruses entering and being sent from your network. The Virus Types page displays the viruses that have been detected by the virus scanning engines running on your appliance. You might want to use this report to take a specific action against a particular virus. For example, if you see that you are receiving a high volume of a viruses known to be embedded in PDF files, you might want to create a filter action to quarantine messages with PDF attachments.

If you run multiple virus scanning engines, the Virus Types page includes results from all enabled virus scanning engines. The name of the virus displayed on the page is a name determined by the virus scanning engines. If more than one scanning engine detects a virus, it is possible to have more than one entry for the same virus.

The Virus Types page gives you an overview of the viruses entering or being sent from or to your network. The Top Incoming Virus Detected section shows a chart view of the viruses that have been sent to your network in descending order. The Top Outgoing Virus Detected section shows a chart view of the viruses that have been sent from your network in descending order.



---

**Note** To see which hosts sent virus-infected messages to your network, you can go to the Incoming Mail page, specify the same reporting period and sort by virus-positive. Similarly, to see which IP addresses have sent virus-positive email within your network, you can view the Outgoing Senders page and sort by virus-positive messages.

---

The VirusTypes Details listing displays information about specific viruses, including the infected incoming and outgoing messages, and the total infected messages. The details listing for infected incoming messages displays the name of the virus and the number of incoming messages infected with this virus. Similarly, the outgoing messages displays the name of the virus and the number of outgoing messages infected with the virus. You can sort the Virus Type details by Incoming Messages, Outgoing Messages, or Total Infected Messages.

## URL Filtering Page

- URL Filtering report modules are populated only if URL filtering is enabled.
- URL Filtering reports are available for incoming and outgoing messages.
- Only messages that are scanned by the URL filtering engine (either as part of anti-spam/outbreak filter scanning or through message/content filters) are included in these modules. However, not all of the results are necessarily specifically attributable to the URL Filtering feature.
- The Top URL Categories module includes all categories found in messages that have been scanned, whether or not they match a content or message filter.
- Each message can be associated with only one URL reputation level. For messages with multiple URLs, the statistics reflect the lowest reputation of any URL in the message.
- URLs in the global allowed list configured at Security Services > URL Filtering are not included in reports.

URLs in allowed lists used in individual filters are included in reports.

- Malicious URLs are URLs that Outbreak Filters have determined to have poor reputation. Neutral URLs are those that Outbreak Filters have determined to require click-time protection. Neutral URLs have therefore been rewritten to redirect them to the Cisco Web Security proxy.
- Results of URL category-based filters are reflected in content and message filter reports.

- Results of click-time URL evaluations by the Cisco Web Security proxy are not reflected in reports.

## Web Interaction Tracking Page

- Web Interaction Tracking report modules are populated only if the web interaction tracking feature is enabled.
- Web Interaction Tracking report modules are not updated in real-time and are refreshed every 30 minutes. Also, after clicking a rewritten URL, it may take up to two hours for the Web Interaction Tracking report to report this event.
- Web Interaction Tracking report is not updated in real-time. After clicking a cloud re-directed rewritten URL, it may take up to two hours for the Web Interaction Tracking report to report this event.
- Web Interaction Tracking reports are available for incoming and outgoing messages.
- Only cloud re-directed rewritten URLs (either by policy or Outbreak Filter) clicked by the end users are included in these modules.
- Web Interaction Tracking page includes the following reports:

**Top Rewritten Malicious URLs clicked by End Users.** Click on a URL to view a detailed report that contains the following information:

- A list of end users who clicked on the rewritten malicious URL.
- Date and time at which the URL was clicked.
- Whether the URL was rewritten by a policy or an outbreak filter.
- Action taken (allow, block, or unknown) when the rewritten URL was clicked. Note that, if a URL was rewritten by outbreak filter and the final verdict is unavailable, the status is shown as unknown.

### **Top End Users who clicked on Rewritten Malicious URLs**

**Web Interaction Tracking Details.** Includes the following information:

- A list of all the cloud re-directed rewritten URLs (malicious and unmalicious). Click on a URL to view a detailed report.
- Action taken (allow, block, or unknown) when a cloud re-directed rewritten URL was clicked.

For the data to show up, perform the following:

- Choose **Incoming Mail Policies > Outbreak Filters** to configure an outbreak filter and enable message modification and URL rewriting.
- Configure a content filter with the "**Redirect to Cisco Security Proxy**" action.

Note that, if the verdict of a URL (clean or malicious) was unknown at the time when the end user clicked it, the status is shown as unknown. This could be because the URL was under further scrutiny or the web server was down or not reachable at the time of the user click.

- The number of times end users clicked on a rewritten URL. Click on a number to view a list of all the messages that contain the clicked URL.
- While using Web Interaction Tracking reports, keep in mind the following limitations:
  - If you have configured a content or message filter to deliver messages after rewriting malicious URLs and notify another user (for example, an administrator), the web interaction tracking data of the original recipient is incremented even if the notified user clicks on the rewritten URLs.
  - If you are sending a copy of quarantined messages containing rewritten URLs to a user (for example, an administrator) using web interface, the web interaction tracking data of the original recipient is

incremented even if the user (to whom the copy of the messages were sent) clicks on the rewritten URLs.

- At any point, if you plan to modify the time of your appliance, make sure that the system time is synchronized with Coordinated Universal Time (UTC).

## Forged Email Matches Report

See [Monitoring Forged Email Detection Results](#), on page 617.

## File Reputation and File Analysis Reports

For the following reports, see [File Reputation and File Analysis Reporting and Tracking](#), on page 478:

- Advanced Malware Protection
- File Analysis
- AMP Verdict Updates

## Mailbox Auto Remediation Report

You can view the details of the mailbox remediation results using the Mailbox Auto Remediation report page (**Monitor > Mailbox Auto Remediation**). Use this report to view details such as:

- Remedial actions taken on messages
- The filenames associated with a SHA-256 hash
- A list of profile names defined for the recipients for whom the mailbox remediation was successful or unsuccessful
- Reason for the remediation failure
- No profile mapped to the domain

Click on a SHA-256 hash to view the related messages in Message Tracking.

For more information, see [Remediating Messages in Mailboxes](#), on page 553

## TLS Connections Page

The TLS Connections page shows the overall usage of TLS connections for sent and received mail. The report also shows details for each domain sending mail using TLS connections.

The TLS Connections page can be used to determine the following information:

- Overall, what portion of incoming and outgoing connections use TLS?
- What partners do I have successful TLS connections with?
- What partners do I have unsuccessful TLS connections with?
- What partners do I have successful TLS connections with DANE support?
- What partners do I have unsuccessful TLS connections with DANE support?
- What partners have issue with their TLS certificates?
- What percent of overall mail with a partner uses TLS?

- What percent of outgoing TLS connections with DANE support are successful?
- What percent of outgoing connections with DANE support are unsuccessful?

The TLS Connections page is divided into a section for incoming connections and a section for outgoing connections. Each section includes a graph, summaries, and a table with details.

The graph displays a view of incoming or outgoing TLS-encrypted and non-encrypted connections over the time range you specify. The graph displays the total volume of messages, the volume of encrypted and unencrypted messages, the volume of successful and failed TLS encrypted messages and the volume of successful and failed DANE connections. The graphs distinguish between connections in which TLS was required and connections in which TLS was merely preferred.

The table displays details for domains sending or receiving encrypted messages. For each domain, you can view the number of required and preferred TLS connections that were successful and that failed, the total number of TLS connections attempted (whether successful or failed), the total number of unencrypted connections, and the total number of unencrypted connections, and the total number of DANE connections (depending on whether successful or failed). You can also view the percentage of all connections in which TLS was attempted, and the total number of encrypted messages sent successfully, regardless of whether TLS was preferred or required. You can show or hide columns by clicking the Columns link at the bottom of this table.

## Inbound SMTP Authentication Page

The Inbound SMTP Authentication page shows the use of client certificates and the SMTP AUTH command to authenticate SMTP sessions between the appliance and users' mail clients. If the appliance accepts the certificate or SMTP AUTH command, it will establish a TLS connection to the mail client, which the client will use to send a message. Since it is not possible for the appliance to track these attempts on a per-user basis, the report shows details on SMTP authentication based on the domain name and domain IP address.

Use this report to determine the following information:

- Overall, how many incoming connection use SMTP authentication?
- How many connections use a client certificated?
- How many connections use SMTP AUTH?
- What domains are failing to connect when attempting to use SMTP authentication?
- How many connections are successfully using the fall-back when SMTP authentication fails?

The Inbound SMTP Authentication page includes a graph for received connections, a graph for mail recipients who attempted an SMTP authentication connection, and a table with details on the attempts to authenticate connections.

The Received Connections graph shows the incoming connections from mail clients that attempt to authentication their connections using SMTP authentication over the time range you specify. The graph displays the total number of connections the appliance received, the number that did not attempt to authenticate using SMTP authentication, the number that failed and succeeded to authenticate the connection using a client certificate, and the number that failed and succeeded to authenticate using the SMTP AUTH command.

The Received Recipients graph displays the number of recipients whose mail clients attempted to authenticate their connections to the appliances to send messages using SMTP authentication. The graph also show the number of recipients whose connections were authenticated and the number of recipients whose connections were not authenticated.

The SMTP Authentication details table displays details for the domains whose users attempt to authenticate their connections to the appliance to send messages. For each domain, you can view the number of connection

attempts using a client certificate that were successful or failed, the number of connection attempts using the SMTP AUTH command that were successful or failed, and the number that fell back to the SMTP AUTH after their client certificate connection attempt failed. You can use the links at the top of the page to display this information by domain name or domain IP address.

## Rate Limits Page

Rate Limiting by envelope sender allows you to limit the number of email message recipients per time interval from an individual sender, based on the mail-from address. The Rate Limits report shows you the senders who most egregiously exceed this limit.

Use this report to help you identify the following:

- Compromised user accounts that might be used to send spam in bulk.
- Out-of-control applications in your organization that use email for notifications, alerts, automated statements, etc.
- Sources of heavy email activity in your organization, for internal billing or resource-management purposes.
- Sources of large-volume inbound email traffic that might not otherwise be considered spam.

Note that other reports that include statistics for internal senders (such as Internal Users or Outgoing Senders) measure only the number of messages sent; they do not identify senders of a few messages to a large number of recipients.

The Top Offenders by Incident chart shows the envelope senders who most frequently attempted to send messages to more recipients than the configured limit. Each attempt is one incident. This chart aggregates incident counts from all listeners.

The Top Offenders by Rejected Recipients chart shows the envelope senders who sent messages to the largest number of recipients above the configured limit. This chart aggregates recipient counts from all listeners.

To configure rate limiting by envelope sender or modify the existing rate limit, see [Defining Rules for Incoming Messages Using a Mail Flow Policy, on page 107](#).

## System Capacity Page

The System Capacity page provides a detailed representation of the system load, including messages in the work queue, average time spent in the work queue, incoming and outgoing messages (volume, size, and number), overall CPU usage, CPU usage by function, and memory page swapping information.

The system capacity page can be used to determine the following information:

- Identify when an appliance is exceeding recommended capacity and configuration optimization or additional appliances are needed.
- Identify historical trends in system behavior which point to upcoming capacity issues.
- Identify which part of the system is using the most resources to assist with troubleshooting.

It is important to monitor your appliance to ensure that your capacity is appropriate to your message volumes. Over time, volume will inevitably rise and appropriate monitoring will ensure that additional capacity or configuration changes can be applied proactively. The most effective way to monitor system capacity is to track overall volume, messages in the work queue and incidents of Resource Conservation Mode.

- **Volume:** It is important to have an understanding of the “normal” message volume and the “usual” spikes in your environment. Track this data over time to measure volume growth. You can use the Incoming

Mail and Outgoing Mail pages to track volume over time. For more information, see [System Capacity-Incoming Mail, on page 835](#) and [System Capacity-Outgoing Mail, on page 835](#).

- **Work Queue:** The work queue is designed to work as a “shock absorber”-- absorbing and filtering spam attacks and processing unusual increases in ham messages. However, the work queue is also the best indicator of a system under stress, prolonged and frequent work queue backups may indicate a capacity problem. You can use the WorkQueue page to track the average time messages spend in the work queue and the activity in your work queue. For more information, see [System Capacity- Workqueue, on page 834](#).
- **Resource Conservation Mode:** When an appliance becomes overloaded, it will enter “Resource Conservation Mode” (RCM) and send a CRITICAL system alert. This is designed to protect the device and allow it to process any backlog of messages. Your appliance should enter RCM infrequently and only during a very large or unusual increase in mail volume. Frequent RCM alerts may be an indication that the system is becoming overloaded. See [System Capacity-System Load, on page 835](#).

### Related Topics

- [System Capacity- Workqueue, on page 834](#)
- [System Capacity- Incoming Mail, on page 835](#)
- [System Capacity-Outgoing Mail, on page 835](#)
- [System Capacity-System Load, on page 835](#)
- [Note about Memory Page Swapping, on page 836](#)
- [System Capacity- All, on page 836](#)

## System Capacity- Workqueue

The Workqueue page shows the average time a message spends in the work queue, excluding any time spent in the Spam quarantine or in a policy, virus, or outbreak quarantine. You can view time periods from an hour up to one month. This average can help in identifying both short term events delaying mail delivery and identify long term trends in the workload on the system.



---

**Note** If a message is released from the quarantine into the work queue, the “average time in work queue” metric ignores this time. This prevents double-counting and distorted statistics due to extended time spent in a quarantine.

---

The report also shows the volume of messages in the work queue over a specified time period, and it shows the maximum messages in the work queue over the same time period. The graphical representation of the maximum messages in the work queue also shows the work queue threshold level.

Occasional spikes in the Workqueue graphs are normal and expected. If the messages in the work queue remain higher than the configured threshold for a long duration, this may indicate a capacity issue. In this scenario, consider tuning the threshold level or review the system configuration.

For instructions to change the work queue threshold level, see [Setting Thresholds for System Health Parameters, on page 1019](#).



---

**Tip** When reviewing the work queue page, you may want to measure the frequency of work queue backups, and take note of work queue backups that exceed 10,000 messages.

---



## System Capacity- Incoming Mail

The incoming mail page shows incoming connections, the total number of incoming messages, the average message size, and the total incoming message size. You can limit the results to the time range that you specify. It is important to have an understanding of the trends of normal message volume and spikes in your environment. You can use the incoming mail page to help track volume growth over time and plan for system capacity. You might also want to compare the Incoming Mail data with the Sender Profile data to view the trends in volumes of emails that are being sent from specific domains to your network.



---

**Note** An increased number of incoming connections may not necessarily affect system load.

---

## System Capacity-Outgoing Mail

The outgoing mail page shows outgoing connections, the total number of outgoing messages, the average message size, and the total outgoing message size. You can limit the results to the time range that you specify. It is important to have an understanding of the trends of normal message volume and spikes in your environment. You can use the outgoing mail page to help track volume growth over time and plan for system capacity. You might also want to compare the Outgoing Mail data with the Outgoing Destinations data to view the trends in volumes of emails that are being sent from specific domains or IP addresses.

## System Capacity-System Load

The system load report shows the following:

- Overall CPU Usage
- Memory Page Swapping
- Resource Conservation Activity

### Overall CPU Usage

The appliance is optimized to use idle CPU resources to improve message throughput. High CPU usage may not indicate a system capacity problem. If the high CPU usage is coupled with consistent, high-volume memory page swapping, you may have a capacity problem.



---

**Note** This graph also shows the threshold level for CPU usage. If you want to change the threshold level, use the **System Administration > System Health** page in web interface or **healthconfig** command in CLI. See [Setting Thresholds for System Health Parameters, on page 1019](#).

---

This page also shows a graph that displays the amount of CPU used by different functions, including mail processing, spam and virus engines, reporting, and quarantines. The CPU-by-function graph is a good indicator of which areas of the product use the most resources on your system. If you need to optimize your appliance, this graph can help you determine which functions may need to be tuned or disabled.

### Memory Page Swapping

The memory page swapping graph shows how frequently the system must page to disk. This graph also shows the threshold level for memory page swapping. If you want to change the threshold level, use the **System**

**Administration** > **System Health** page in web interface or **healthconfig** command in CLI. See [Setting Thresholds for System Health Parameters, on page 1019](#).

### Resource Conservation Activity

The resource conservation activity graph shows the number of times the appliance entered Resource Conservation Mode (RCM). For example, if the graph shows *n* times, it means that the appliance has entered RCM *n* times and exited at least *n-1* times.

Your appliance should enter RCM infrequently and only during a very large or unusual increase in mail volume. If the Resource Conservation Activity graph shows that your appliance is entering RCS frequently, it may be an indication that the system is becoming overloaded.

## Note about Memory Page Swapping

The system is designed to swap memory regularly, so some memory swapping is expected and is not an indication of problems with your appliance. Unless the system *consistently* swaps memory in high volumes, memory swapping is normal and expected behavior, especially on C170 and C190 appliances. To improve performance, you may need to add appliances to your network or tune your configuration to ensure maximum throughput.

## System Capacity- All

The All page consolidates all the previous system capacity reports onto a single page so you can view the relationship between the different reports. For example, you might view the message queue is high at the same time that excessive memory swapping takes place. This might be an indication that you have a capacity problem. You may want to save this page as PDF to preserve a snapshot of system performance for later reference (or to share with support staff). For information about generating PDFs in languages other than English, see the [Notes on Reports, on page 882](#).

## System Status Page

The **System Status** page provides a detailed representation of all real-time mail and DNS activity for the system. The information displayed is the same information that is available by using the status detail and **dnsstatus** commands in the CLI. For more information, see “Monitoring Detailed Email Status” for the status detail command and “Checking the DNS Status” for the **dnsstatus** command in [Managing and Monitoring Using the CLI, on page 1063](#)

The System Status page is comprised of four sections: System Status, Gauges, Rates, and Counters.

### Related Topics

- [System Status, on page 836](#)
- [Gauges, on page 837](#)
- [Rates, on page 837](#)
- [Counters, on page 837](#)

## System Status

The system status section shows Mail System Status and Version Information.

## Related Topics

- [Mail System Status, on page 837](#)
- [Version Information, on page 837](#)

## Mail System Status

The Mail System Status section includes:

- System Status (for more information about system status, see [Status, on page 812](#))
- The last time the status was reported.
- The uptime for the appliance .
- The oldest message in the system, including messages that have not yet been queued for delivery.

## Version Information

The Version Information section includes:

- The appliance model name.
- The version and build date of the AsyncOS operating system installed.
- The installation date of the AsyncOS operating system.
- The serial number of the system to which you are connected.

This information is useful if you are contacting Cisco Customer Support. (See [Working with Technical Support, on page 1233](#).)

## Gauges

The Gauges section shows queue and resource utilization.

- Mail Processing Queue
- Active Recipients in Queue
- Queue Space
- CPU Utilization

Mail Gateway Appliance refers to the percentage of the CPU that AsyncOS processes are consuming. CASE refers to several items, including the Anti-Spam scanning engine and Outbreak Filters processes.

- General Resource Utilization
- Logging Disk Utilization

## Rates

The Rates section shows rate handling for recipients.

- Mail Handling Rates
- Completion Rates

## Counters

It is recommended that you avoid resetting counters on Cloud Email Security appliance.

You can reset the cumulative email monitoring counters for system statistics and view the last time the counters were reset. The reset affects system counters as well as per-domain counters. The reset does not affect the counters on messages in the delivery queue related to retry schedules.



**Note** Only user accounts that are in the administrator or operator group have access to reset the counters. User accounts you create in the guest group will not be able to reset the counters. For more information, see [Working with User Accounts, on page 949](#).

Click Reset Counters to reset the counters. This button offers the same functionality as the `resetcounters` command in the CLI. For more information, see [Resetting Email Monitoring Counters, on page 1078](#).

- Mail Handling Events
- Completion Events
- Domain Key Events
- DNS Status

## High Volume Mail Page



**Note** The High Volume Mail page shows data only from message filters that use Header Repeats rule.

The High Volume Mail page contains the following reports in the form of bar charts:

- **Top Subjects.** You can use this chart to understand the top subjects of messages that AsyncOS received.
- **Top Envelope Senders.** You can use this chart to understand the top envelope senders of messages that AsyncOS received.
- **Top Message Filters by Number of Matches.** You can use this chart to understand the top message filter (that uses Header Repeats rule) matches.

The High Volume Mail page also provides a tabular representation of the top message filters and the number of matches for the respective message filters. Click on the number to view a list of all the messages that are included in that number using Message Tracking.

You can select a time range on which to report, such as an hour, a week, or a custom range. As with all reports, you can export the data for the graphs or the details listing to CSV format via the **Export** link or PDF format by clicking the **Printable (PDF)** link.

## Message Filters Page

The Message Filters page shows information about the top message filter matches (which message filter had the most matching messages) in two forms: a bar chart and a tabular representation.

Using the bar chart, you can find the message filters that are being triggered the most by incoming and outgoing messages. The tabular representation shows the top message filters and the number of matches for the respective message filters. Click on the number to view a list of all the messages that are included in that number using Message Tracking.

You can select a time range on which to report, such as an hour, a week, or a custom range. As with all reports, you can export the data for the graphs or the details listing to CSV format via the **Export** link or PDF format by clicking the **Printable (PDF)** link.

## Safe Print Page

You can use the Safe Print report page to view:

- Number of safe-printed attachments based on the file type in graphical format.
- Summary of safe-printed attachments based on the file type in tabular format.

In the ‘Summary of Safe Print File Types’ section, click the total number of safe-printed attachments to view the message details in Message Tracking.

## Retrieving CSV Data

You can retrieve the data used to build the charts and graphs in the Email Security Monitor in CSV format. The CSV data can be accessed in two ways:

- **CSV reports delivered via email.** You can generate a CSV report that is delivered via email or archived. This delivery method is useful when you want separate reports for each table represented on an Reports page, or when you want to send CSV data to users who do not have access to internal networks.

The comma-separated values (CSV) Report Type is an ASCII text file which contains the tabular data of the scheduled report. Each CSV file may contain up to 100 rows. If a report contains more than one type of table, a separate CSV file will be created for each table. Multiple CSV files for a single report will be compressed into a single .zip file for the archived file storage option or will all be attached to separate e-mail messages for e-mail delivery.

- **CSV files retrieved via HTTP.** You can retrieve the data used to build the charts and graphs in the Email Security Monitor feature via HTTP. This delivery method is useful if you plan to perform further analysis on the data via other tools. You can automate the retrieval of this data, for example, by an automatic script that will download raw data, process, and then display the results in some other system.

### Related Topics

- [Retrieving CSV Data Via Automated Processes, on page 839](#)

## Retrieving CSV Data Via Automated Processes

The easiest way to get the HTTP query you will need is to configure one of the Email Security Monitor pages to display the type of data you want. You can then copy the **Export** link. This is the download URL. When automating data retrieval like this it is important to note which parameters in the download URL should be fixed and which should change (see below).

The download URL is encoded in such a way that it can be copied to an external script that can execute the same query (using proper HTTP authentication) and get a similar data set. The script can use Basic HTTP Authentication or cookie authentication. Keep the following in mind when retrieving CSV data via automated processes:

- Time range selection (past hour, day, week, etc) in relation to when the URL is used again. If you copy the URL to retrieve a CSV data set for “Past Day,” the next time you use that URL you will get a new data set that covers the “Past Day” from the time you send the URL again. The date range selection is retained, and appears in the CSV query string (e.g. `date_range=current_day`).

- Filtering and grouping preferences for the data set. Filters are retained and appear in the query string. Note that filters in reports are rare — one example is the “Global / Local” outbreaks selector in the Outbreaks report.
- The CSV download returns all rows of data in the table for the selected time range.
- The CSV download returns the rows of data in the table ordered by timestamp and key. You can perform further sorting in a separate step such as via a spreadsheet application.
- The first row contains column headers that match the display names shown in the report. Note that timestamps (see [Timestamps, on page 840](#)) and keys (see [Keys, on page 840](#)) also appear.

### Related Topics

- [Sample URL, on page 840](#)
- [Adding Basic HTTP Authentication credentials, on page 840](#)
- [File Format, on page 840](#)
- [Timestamps, on page 840](#)
- [Keys, on page 840](#)
- [Streaming, on page 841](#)

### Sample URL

```
http://example.com/monitor/content_filters?format=csv&sort_col_ss_0_0_0=
MAIL_CONTENT_FILTER_INCOMING.RECIPIENTS_MATCHED§ion=ss_0_0_0
&date_range=current_day&sort_order_ss_0_0_0=desc&report_def_id=mga_content_filters
```

### Adding Basic HTTP Authentication credentials

To specify basic HTTP Authentication credentials to the URL:

```
http://example.com/monitor/
```

becomes:

```
http://username:password@example.com/monitor/
```

### File Format

The downloaded file is in CSV format and has a .csv file extension. The file header has a default filename, which starts with the name of the report, then the section of the report.

### Timestamps

Exports that stream data show begin and end timestamps for each raw “interval” of time. Two begin and two end timestamps are provided — one in numeric format and the other in human-readable string format. The timestamps are in GMT time, which should make log aggregation easier if you have appliances in multiple time zones.

Note that in some rare cases where the data has been merged with data from other sources, the export file does not include timestamps. For example, the Outbreak Details export merges report data with Threat Operations Center (TOC) data, making timestamps irrelevant because there are no intervals.

### Keys

Exports also include the report table key(s), even in cases where the keys are not visible in the report. In cases where a key is shown, the display name shown in the report is used as the column header. Otherwise, a column header such as “key0,” “key1,” etc. is shown.

## Streaming

Most exports stream their data back to the client because the amount of data is potentially very large. However, some exports return the entire result set rather than streaming data. This is typically the case when report data is aggregated with non-report data (e.g. Outbreaks Detail.)

# Email Security Monitor Pages on the New Web Interface

To access the new web interface, click the **Email Security Appliance is getting a new look. Try it!!** link on the legacy web interface. For more information, see [Accessing the Web-Based Graphical User Interface \(GUI\), on page 30](#).

You can view the reports for the appliance using the **Reports** drop-down as shown in the following figure:



**Note** The Mail Flow Summary report page is the landing page (the page displayed after login).

**Figure 70: Reports Drop-down**

| Reports / Mail Flow Summary: Incoming |                          | Data in time range: 100% COMPLETE 22 Jul 2019 14:00 to 23 Jul 2019 14:53 (GMT +05:30) |                   |
|---------------------------------------|--------------------------|---------------------------------------------------------------------------------------|-------------------|
| Mail Flow Summary                     |                          | Time Range                                                                            | Day               |
| My Reports                            | Email Threat Reports     | Connection and Flow Reports                                                           | User Reports      |
| Mail Flow Summary                     | DMARC Verification       | Mail Flow Details                                                                     | User Mail Summary |
| System Capacity                       | Outbreak Filtering       | Sender Groups                                                                         | DLP Incidents     |
|                                       | URL Filtering            | Outgoing Destinations                                                                 | Web Interaction   |
| File and Malware Reports              | Forged Email Detection   | TLS Encryption                                                                        | Filter Reports    |
| Advanced Malware Protection           | Sender Domain Reputation | Inbound SMTP Authentication                                                           | Message Filters   |
| Virus Filtering                       | External Threat Feeds    | Rate Limits                                                                           | High Volume Mail  |
| Macro Detection                       |                          | Connections by Country                                                                | Content Filters   |

You use these pages in the GUI to monitor domains that are connecting to the appliance listeners. You can monitor, sort, analyze, and classify the “mail flow” of your appliance and differentiate between high-volume senders of legitimate mail and potential “spammers” (senders of high-volume, unsolicited commercial email) or virus senders. These pages can also help you troubleshoot inbound connections to the system (including important information such as IP Reputation score and most recent sender group match for domains).

These pages help you classify mail relative to the appliance, and also relative to the services that exist beyond the scope of the gateway, such as the IP Reputation Service, the Anti-Spam scanning service, the Anti-Virus scanning security services, content filters, and Outbreak Filters.

You can export graphs and other data to CSV (comma separated values) format via the **Export** link.

The exported CSV data will display all message tracking and reporting data in GMT regardless of what is set on the appliance. The purpose of the GMT time conversion is to allow data to be used independently from the appliance or when referencing data from appliances in multiple time zones.



**Note** If you export localized CSV data, the headings may not render properly in some browsers. This occurs because some browsers may not use the correct character set for the localized text. To work around this problem, you can save the file to disk, and open the file using File > Open. When you open the file, select the character set to display the localized text.

For more information about automating the export of report data, see [Retrieving CSV Data, on page 839](#)).

### List of Email Security Monitor Pages

- [My Favorite Reports Page](#), on page 844
- [Mail Flow Summary Page](#), on page 846
- [System Capacity Page](#), on page 833
- [Advanced Malware Protection Page](#), on page 855
- [Virus Filtering Page](#), on page 859
- [Macro Detection Page](#), on page 859
- [DMARC Verification Page](#), on page 860
- [Outbreak Filtering Page](#), on page 861
- [URL Filtering Page](#), on page 860
- [Forged Email Detection Page](#), on page 862
- [Sender Domain Reputation Page](#), on page 863
- [External Threat Feeds Page](#), on page 863
- [Mail Flow Details Page](#), on page 864
- [Sender Groups Report](#), on page 871
- [Outgoing Destinations](#), on page 871
- [TLS Encryption Page](#), on page 871
- [Inbound SMTP Authentication Page](#), on page 872
- [Rate Limits Page](#), on page 873
- [Connections by Country Page](#), on page 873
- [User Mail Summary Page](#), on page 874
- [DLP Incident Summary Page](#), on page 875
- [Web Interaction Page](#), on page 876
- [Message Filters Page](#), on page 879
- [High Volume Mail Page](#), on page 879
- [Content Filters Page](#), on page 880
- [Advanced Phishing Protection Report Page](#), on page 880

## Searching and the Interactive Email Report Pages

Many of the interactive email reporting pages include a ‘**Search For:**’ drop-down menu at the bottom of the page.

From the drop-down menu, you can search for several types of criteria, including the following:



- IP address
- Domain
- Network owner
- Internal user
- Destination domain
- Internal sender domain
- Internal sender IP address
- Incoming TLS domain
- Outgoing TLS domain
- SHA-256

For most searches, choose whether to exactly match the search text or look for items starting with the entered text (for example, starts with “ex” will match “example.com”).

For IPv4 searches, the entered text is always interpreted as the beginning of up to four IP octets in dotted decimal format. For example, ‘17.\*’ will search in the range 17.0.0.0 through 17.255.255.255, so it will match 17.0.0.1 but not 172.0.0.1. For an exact match search, enter all four octets. IP address searches also support Classless Inter-Domain Routing (CIDR) format (17.16.0.0/12).

For IPv6 searches, you can enter addresses using the formats in the following examples:

- 2001:db8:2004:4202::0-2001:db8:2004:4202::ff
- 2001:db8:2004:4202::
- 2001:db8:2004:4202::23
- 2001:db8:2004:4202::/64

## Viewing Details of Messages Included in Reports

This functionality works only if reporting and tracking are both local (not centralized on a Cisco Content Security Management Appliance .)

### Procedure

---

- Step 1** Click any blue number in a table on a report page.  
(Not all tables have these links.)  
The messages included in that number are displayed in Message Tracking.
- Step 2** Scroll down to see the list.
- 

### What to do next

#### Related Topics

- [Working with Message Tracking Search Results](#) , on page 893

## Time Range for Reports

The Email Security Monitor feature constantly records data about the mail flowing into your gateway. The data are updated every 60 seconds, but the display shown is delayed by 120 seconds behind the current system time. You can specify the time range to include in the results shown. Because the data is monitored in real time, information is periodically updated and summarized in the database.

Choose from the time range options in the following table.

**Table 85: Time Ranges Available in the Email Security Monitor Feature**

| This time range selected in the GUI | ...is defined as:                                                                        |
|-------------------------------------|------------------------------------------------------------------------------------------|
| Hour                                | the last 60 minutes + up to 5 minutes                                                    |
| Day                                 | the last 24 hours + the last 60 minutes                                                  |
| Week                                | the last 7 days + the elapsed hours of the current day                                   |
| 30 days                             | the last 30 days + the elapsed hours of the current day                                  |
| 90 days                             | the last 90 days + the elapsed hours of the current day                                  |
| Yesterday                           | 00:00 to 23:59 (midnight to 11:59 PM)                                                    |
| Previous Calendar Month             | 00:00 of the first day of the month to 23:59 of the last day of the month                |
| Custom Range                        | the range enclosed by the start date and hour and the end date and hour that you specify |

## My Favorite Reports Page

You can create a custom report page by assembling charts (graphs) and tables from all your existing email security reports, on the My Reports page.

| To                                      | Do This                                                                                                                                                                                                                          |
|-----------------------------------------|----------------------------------------------------------------------------------------------------------------------------------------------------------------------------------------------------------------------------------|
| Add modules to My Favorite Reports page | See: <ul style="list-style-type: none"> <li>• <a href="#">Modules That Cannot Be Added to the My Reports Page, on page 845</a></li> <li>• <a href="#">Adding Reports on the My Favorite Reports Page, on page 845</a></li> </ul> |

| To                                                | Do This                                                                                                                                                                                                                                                                                                                                                                                                                                                                                                                                                                            |
|---------------------------------------------------|------------------------------------------------------------------------------------------------------------------------------------------------------------------------------------------------------------------------------------------------------------------------------------------------------------------------------------------------------------------------------------------------------------------------------------------------------------------------------------------------------------------------------------------------------------------------------------|
| View My Favorite Reports page                     | <ol style="list-style-type: none"> <li>1. Select <b>My Favorite Reports</b> from the Reports drop-down.</li> <li>2. Select the time range to view. The time range selected applies to all reports, including all modules on the My Favorite Reports page.</li> </ol> <p>Newly-added modules appear at the top of the custom report.</p> <p><b>Note</b> The report modules that you add on the My Favorite Reports page of the new web interface differs from the report modules added on the legacy web interface. It can also differ based on the User roles that you assign.</p> |
| Rearrange modules on the My Favorite Reports page | On the My Favorite Reports page, drag and drop the modules into the desired location.                                                                                                                                                                                                                                                                                                                                                                                                                                                                                              |
| Delete modules from the My Favorite Reports page  | <p>You can delete the report modules from the My Favorite Reports page in any one of the following ways:</p> <ul style="list-style-type: none"> <li>• Click the  in the top right corner of the required report module.</li> <li>• Go to the <b>My Favorite Reports</b> page and select <b>Manage Favorites</b> to remove the required report module.</li> </ul>                                                                                                                                |

## Modules That Cannot Be Added to the My Reports Page

- All modules on the System Status page.
- All modules on the Reporting Data Availability page.
- All modules on the Message Tracking Data Availability page.
- The following per-domain modules from the Sender Profile detail report page: Current Information from SenderBase, Sender Group Information, and Network Information.
- The Past Year Virus Outbreak Summary chart and Past Year Virus Outbreaks table on the Outbreak Filters report page.

## Adding Reports on the My Favorite Reports Page

### Before you begin

- Ensure that the modules that you want to add can be added. See [Modules That Cannot Be Added to the My Reports Page, on page 845](#).
- Click  on the top right corner of a module to delete any default modules that you do not need.

## Procedure

---

**Step 1** You can add a report module on the My Favorite Reports page in any one of the following ways:

**Note** Some modules are available only using one of these methods. If you cannot add a module using one method, try another method.

- Go to the report page under the Reports drop-down and click  on the top of the report module.
- From the Reports drop-down, select **My Reports** and click **Manage Favorites**.

The report modules are listed as per the tables and charts on email report pages. Select the required report modules and click **Add** to add to the My Favorite Reports page. If you do not want any reports to be displayed on the My Favorite Report page, select the report module and click **Remove**.

You can add each module only once; if you have already added a particular module to your report, the option to add it will not be available.

**Note** You can add a maximum of 10 report modules on the My Favorite Reports page.

**Step 2** If you add a report module that you have customized (for example, by adding, deleting, or reordering columns, or by displaying non-default data in the chart), customize the modules on the My Favorite Reports page.

Modules are added with default settings. Time range of the original module is not maintained.

**Step 3** If you add a chart that includes a separate legend (for example, a graph from the Mail Flow Summary page), add the legend separately. If necessary, drag and drop it into position beside the data it describes.

---

## Mail Flow Summary Page

The Mail Flow Summary report page provides a synopsis of the email message activity from your appliance . The Mail Flow Summary report page includes graphs and summary tables for the incoming and outgoing messages.

The Mail Flow Summary: Incoming report page shows the incoming mail graphs for the total number of messages that are processed and blocked by the appliance , as well as the summary of the incoming mails.

You can use the mail trend graphs on this page to monitor the flow of all the incoming mails that are processed and blocked by your appliances , based on the selected time range. For more information, see [Time Range for Reports, on page 844](#).

To search for specific information within your data, see [Searching and the Interactive Email Report Pages , on page 842](#)

The following mail trend graphs provide a visual representation of the incoming mail flow:

- Threat Detection Summary
- Content Summary

You can view the mail trend of the incoming messages based on the required counters for the respective categories. For more information, see [Using Counters to Filter Data on the Trend Graphs, on page 851](#).

The Mail Flow Summary: Outgoing report page shows the outgoing mail graphs for the total number of messages that are processed and delivered by the appliance, as well as the summary of the outgoing mail.

You can use the mail trend graphs on this page to monitor the flow of all the outgoing mails that are processed and delivered by your appliances, based on the selected time range. For more information, see [Time Range for Reports, on page 844](#).

The following mail trend graphs provide a visual representation of the mail flow of the Outgoing Mails.

You can view the mail trend of the outgoing messages based on the required counters of the processed messages. For more information, see [Using Counters to Filter Data on the Trend Graphs, on page 851](#).

The following list explains the various sections on the Mail Flow Summary report page:

**Table 86: Details on the Mail Flow Summary Page**

| Section                            | Description                                                                                                                                                                                                                                                                                                                                                                                                                                                                                                                                                                                                                                                                                                                                                                                                                                                                                                          |
|------------------------------------|----------------------------------------------------------------------------------------------------------------------------------------------------------------------------------------------------------------------------------------------------------------------------------------------------------------------------------------------------------------------------------------------------------------------------------------------------------------------------------------------------------------------------------------------------------------------------------------------------------------------------------------------------------------------------------------------------------------------------------------------------------------------------------------------------------------------------------------------------------------------------------------------------------------------|
| <b>Mail Flow Summary: Incoming</b> |                                                                                                                                                                                                                                                                                                                                                                                                                                                                                                                                                                                                                                                                                                                                                                                                                                                                                                                      |
| Number of Messages                 | The Number of Messages graph provides a visual representation of the total number of messages processed, including the messages that are processed as threat messages.                                                                                                                                                                                                                                                                                                                                                                                                                                                                                                                                                                                                                                                                                                                                               |
| Threat Messages                    | The Threat Messages graph provides a visual representation of the total number of messages that are blocked by the appliance.                                                                                                                                                                                                                                                                                                                                                                                                                                                                                                                                                                                                                                                                                                                                                                                        |
| Threat Detection Summary           | <p>The Threat Detection Summary mail trend graph provides a visual representation based on the following categories:</p> <ul style="list-style-type: none"> <li>• <b>Connection and IP Reputation Filtering:</b> Messages that are categorized as threat by the Reputation Filtering and Invalid Recipients.</li> <li>• <b>Spam Detection:</b> Messages that are categorized as threat by the Anti-spam scanning engine.</li> <li>• <b>Email Spoofing:</b> Messages which are categorized as threat due to DMARC Verification failure.</li> <li>• <b>Outbreak Threat Summary:</b> Messages which are categorized as phishing, scam, virus or malware, by the Outbreak Filtering engine.</li> <li>• <b>Attachment and Malware Detection:</b> Messages that are categorized as threat by the Anti-virus and AMP engines.</li> <li>• <b>All Categories:</b> All the messages that are categorized as threat.</li> </ul> |

| Section                            | Description                                                                                                                                                                                                                                                                                                                                                                                                                                                           |
|------------------------------------|-----------------------------------------------------------------------------------------------------------------------------------------------------------------------------------------------------------------------------------------------------------------------------------------------------------------------------------------------------------------------------------------------------------------------------------------------------------------------|
| Content Summary                    | <p>The Content Summary mail trend graph provides a visual representation based on the following categories:</p> <ul style="list-style-type: none"> <li>• <b>Graymail:</b> Messages that are categorized as marketing, bulk or social networking.</li> <li>• <b>Content Filters:</b> Messages that are categorized by the content filters.</li> <li>• <b>All Categories:</b> All the messages that are categorized by graymail engines and content filters.</li> </ul> |
| <b>Mail Flow Summary: Outgoing</b> |                                                                                                                                                                                                                                                                                                                                                                                                                                                                       |
| Number of Messages                 | The Number of Messages graph provides a visual representation of the total number of messages processed, including the messages that are processed as clean.                                                                                                                                                                                                                                                                                                          |
| Message Delivery                   | The Message Delivery graph provides a visual representation of the total number of messages that are delivered, including hard bounces.                                                                                                                                                                                                                                                                                                                               |
| Outgoing Mails                     | <p>The Outgoing Mails trend graph provides a visual representation based on the following categories:</p> <ul style="list-style-type: none"> <li>• Spam Detected</li> <li>• Virus Detected</li> <li>• Detected by AMP</li> <li>• Stopped by Content Filters</li> <li>• Stopped by DLP</li> </ul>                                                                                                                                                                      |

### Related Topics

- [How Email Messages Are Categorized by the Appliances](#) , on page 848
- [Incoming and Outgoing Summary and Graph](#), on page 813
- [Categorizing Email Messages on the Mail Flow Summary Page](#), on page 849
- [Using Counters to Filter Data on the Trend Graphs](#), on page 851

## How Email Messages Are Categorized by the Appliances

As messages proceed through the email pipeline, they can apply to multiple categories. For example, a message can be marked as spam or virus positive; it can also match a content filter. The precedence of the various filters and scanning activities greatly impacts the results of message processing.

In the example above, the various verdicts follow these rules of precedence:

- Spam positive
- Virus positive

- Matching a content filter

Following these rules, if a message is marked as spam positive, and your anti-spam settings are set to drop spam positive messages, the message is dropped and the spam counter is incremented.

Further, if your anti-spam settings are set to let the spam positive message continue on in the email pipeline, and a subsequent content filter drops, bounces, or quarantines the message, the spam count is still incremented. The content filter count is only incremented if the message is not spam or virus positive.

Alternately, if the message were quarantined by Outbreak Filters, it would not be counted until it was released from the quarantine and again processed through the work queue.

For complete information about message processing precedence, see the chapter about the email pipeline in the online help or user guide for your appliance .

## Incoming and Outgoing Summary and Graph

The Incoming and Outgoing summary sections provide access to real-time activity of all mail activity on your system and is comprised of the Incoming and Outgoing Mail Graphs and Mail Summaries. You can select the time frame on which to report via the Time Range menu. The time range you select is used throughout all of the Email Security Monitor pages. The explanations of each type or category of message are below (see [Categorizing Email](#), on page 814).

While the mail trend graph displays a visual representation of the mail flow, the summary table provides a numeric breakdown of the same information. The summary table includes the percentage and actual number of each type of message, including the total number of attempted, threat, and clean messages.

The outgoing graph and summary show similar information for outbound mail.

### Related Topics

- [Notes on Counting Messages in Email Security Monitor](#), on page 814

### Notes on Counting Messages in Email Security Monitor

The method Email Security Monitor uses to count incoming mail depends on the number of recipients per message. For example, an incoming message from example.com sent to three recipients would count as three messages coming from that sender.

Because messages blocked by sender reputation filtering do not actually enter the work queue, the appliance does not have access to the list of recipients for an incoming message. In this case, a multiplier is used to estimate the number of recipients. This multiplier was determined by Cisco and based upon research of a large sampling of existing customer data.

## Categorizing Email Messages on the Mail Flow Summary Page

Incoming messages that are considered as threat, and outgoing messages that are delivered in the Mail Flow Summary report page are categorized as follows:

*Table 87: Email Categories on Mail Flow Summary Page*

| Category                           | Description |
|------------------------------------|-------------|
| <b>Mail Flow Summary: Incoming</b> |             |

| Category                           | Description                                                                                                                                                                                                                                                                                                                                                                                                                                                                                                                                                                                                                                                                                                                                                                                                                                                                                                                                                                                                                                                                                                                           |
|------------------------------------|---------------------------------------------------------------------------------------------------------------------------------------------------------------------------------------------------------------------------------------------------------------------------------------------------------------------------------------------------------------------------------------------------------------------------------------------------------------------------------------------------------------------------------------------------------------------------------------------------------------------------------------------------------------------------------------------------------------------------------------------------------------------------------------------------------------------------------------------------------------------------------------------------------------------------------------------------------------------------------------------------------------------------------------------------------------------------------------------------------------------------------------|
| Reputation Filtering               | <p>All connections blocked by HAT policies, multiplied by a fixed multiplier, and added with all recipients blocked by recipient throttling.</p> <p>The value for Stopped by Reputation Filtering is calculated based on the following factors:</p> <ul style="list-style-type: none"> <li>• Number of “throttled” messages from this sender.</li> <li>• Number of rejected or TCP refused connections (may be a partial count).</li> <li>• A conservative multiplier for the number of messages per connection.</li> </ul> <p>When the appliance is under heavy load, an exact count of rejected connections is not maintained on a per-sender basis. Instead, rejected connections counts are maintained only for the most significant senders in each time interval. In this situation, the value shown can be interpreted as an indicative value of the least number of messages are stopped.</p> <p>The Reputation Filtering total count and percentage on the Mail Flow Summary report page is always based on a complete count of all rejected connections. Only the per-sender connection counts are limited due to load.</p> |
| Sender Domain Reputation Filtering | The total count of messages blocked based on the reputation verdict of the sender domain.                                                                                                                                                                                                                                                                                                                                                                                                                                                                                                                                                                                                                                                                                                                                                                                                                                                                                                                                                                                                                                             |
| Invalid Recipients                 | The total count and percentage of all mail recipients rejected by conversational LDAP rejection in addition to all RAT rejections.                                                                                                                                                                                                                                                                                                                                                                                                                                                                                                                                                                                                                                                                                                                                                                                                                                                                                                                                                                                                    |
| Anti-Spam                          | The total count and percentage of incoming messages detected by the anti-spam scanning engine as positive or suspect. Additionally, messages that are both spam and virus positive.                                                                                                                                                                                                                                                                                                                                                                                                                                                                                                                                                                                                                                                                                                                                                                                                                                                                                                                                                   |
| Anti-Virus                         | <p>The total count and percentage of incoming messages detected as virus positive and not also spam.</p> <p>The following messages are counted in the “Virus Detected” category:</p> <ul style="list-style-type: none"> <li>• Messages with a virus scan result of “Repaired” or “Infectious”</li> <li>• Messages with a virus scan result of “Encrypted” when the option to count encrypted messages as containing viruses is selected</li> <li>• Messages with a virus scan result of “Unscannable” when the action for unscannable messages is NOT “Deliver”</li> <li>• Messages with a virus scan result of “Unscannable” or “Encrypted” when the option to deliver to an alternate mail host or an alternate recipient is selected</li> <li>• Messages that are deleted from the Outbreak quarantine, either manually or by timing out.</li> </ul>                                                                                                                                                                                                                                                                               |



| Category                              | Description                                                                                                                                                                                                                                                                |
|---------------------------------------|----------------------------------------------------------------------------------------------------------------------------------------------------------------------------------------------------------------------------------------------------------------------------|
| Advanced Malware Protection           | The total count and percentage of incoming messages blocked by the file analysis service.<br><br>A message attachment was found to be malicious by file reputation filtering. This value does not include verdict updates or files found to be malicious by file analysis. |
| Content Filter                        | The total count and percentage of incoming messages that are stopped by message and content filters.                                                                                                                                                                       |
| DMARC Policy                          | The total count and percentage of incoming messages that failed DMARC verification policy.                                                                                                                                                                                 |
| S/MIME Verification/Decryption Failed | The total count and percentage of incoming messages that failed S/MIME verification, decryption, or both.                                                                                                                                                                  |
| <b>Mail Flow Summary: Outgoing</b>    |                                                                                                                                                                                                                                                                            |
| Hard Bounces                          | The total count and percentage of outgoing messages that are permanently undeliverable.                                                                                                                                                                                    |
| Delivered                             | The total count and percentage of outgoing messages that are delivered.                                                                                                                                                                                                    |



**Note** If you have configured your anti-virus settings to deliver unscannable or encrypted messages, these messages will be counted as clean messages and not virus positive. Otherwise, the messages are counted as virus positive. Additionally, if messages match a message filter and are not dropped or bounced by the filter, they are treated as clean. Messages dropped or bounced by a message filter are not counted in the totals.

#### Related Topics

[Mail Flow Details Page, on page 864](#)

## Using Counters to Filter Data on the Trend Graphs

You can filter data based on the required time range and available counters on a trend graph.

The time range that you select in the Time Range drop-down, is used for a trend graph until you select a different value.

A counters on a trend graph of the Mail Flow Summary report page is used to view data specific to different filters. Click on an available counter to filter the data.

## System Capacity Page

The System Capacity page provides a detailed representation of the system load, including messages in the work queue, average time spent in the work queue, incoming and outgoing messages (volume, size, and number), overall CPU usage, CPU usage by function, and memory page swapping information.

The system capacity page can be used to determine the following information:

- Identify when an appliance is exceeding recommended capacity and configuration optimization or additional appliances are needed.
- Identify historical trends in system behavior which point to upcoming capacity issues.
- Identify which part of the system is using the most resources to assist with troubleshooting.

It is important to monitor your appliance to ensure that your capacity is appropriate to your message volumes. Over time, volume will inevitably rise and appropriate monitoring will ensure that additional capacity or configuration changes can be applied proactively. The most effective way to monitor system capacity is to track overall volume, messages in the work queue and incidents of Resource Conservation Mode.

- **Volume:** It is important to have an understanding of the “normal” message volume and the “usual” spikes in your environment. Track this data over time to measure volume growth. You can use the Incoming Mail and Outgoing Mail pages to track volume over time. For more information, see [System Capacity-Incoming Mail, on page 835](#) and [System Capacity-Outgoing Mail, on page 835](#).
- **Work Queue:** The work queue is designed to work as a “shock absorber”-- absorbing and filtering spam attacks and processing unusual increases in ham messages. However, the work queue is also the best indicator of a system under stress, prolonged and frequent work queue backups may indicate a capacity problem. You can use the WorkQueue page to track the average time messages spend in the work queue and the activity in your work queue. For more information, see [System Capacity- Workqueue, on page 834](#).
- **Resource Conservation Mode:** When an appliance becomes overloaded, it will enter “Resource Conservation Mode” (RCM) and send a CRITICAL system alert. This is designed to protect the device and allow it to process any backlog of messages. Your appliance should enter RCM infrequently and only during a very large or unusual increase in mail volume. Frequent RCM alerts may be an indication that the system is becoming overloaded. See [System Capacity-System Load, on page 835](#).

### Related Topics

- [System Capacity- Workqueue, on page 834](#)
- [System Capacity- Incoming Mail, on page 835](#)
- [System Capacity-Outgoing Mail, on page 835](#)
- [System Capacity-System Load, on page 835](#)
- [Note about Memory Page Swapping, on page 836](#)
- [System Capacity- All, on page 836](#)

## System Capacity- Workqueue

The Workqueue page shows the average time a message spends in the work queue, excluding any time spent in the Spam quarantine or in a policy, virus, or outbreak quarantine. You can view time periods from an hour up to one month. This average can help in identifying both short term events delaying mail delivery and identify long term trends in the workload on the system.



### Note

If a message is released from the quarantine into the work queue, the “average time in work queue” metric ignores this time. This prevents double-counting and distorted statistics due to extended time spent in a quarantine.

The report also shows the volume of messages in the work queue over a specified time period, and it shows the maximum messages in the work queue over the same time period. The graphical representation of the maximum messages in the work queue also shows the work queue threshold level.

Occasional spikes in the Workqueue graphs are normal and expected. If the messages in the work queue remain higher than the configured threshold for a long duration, this may indicate a capacity issue. In this scenario, consider tuning the threshold level or review the system configuration.

For instructions to change the work queue threshold level, see [Setting Thresholds for System Health Parameters, on page 1019](#).



---

**Tip** When reviewing the work queue page, you may want to measure the frequency of work queue backups, and take note of work queue backups that exceed 10,000 messages.

---

## System Capacity- Incoming Mail

The incoming mail page shows incoming connections, the total number of incoming messages, the average message size, and the total incoming message size. You can limit the results to the time range that you specify. It is important to have an understanding of the trends of normal message volume and spikes in your environment. You can use the incoming mail page to help track volume growth over time and plan for system capacity. You might also want to compare the Incoming Mail data with the Sender Profile data to view the trends in volumes of emails that are being sent from specific domains to your network.



---

**Note** An increased number of incoming connections may not necessarily affect system load.

---

## System Capacity-Outgoing Mail

The outgoing mail page shows outgoing connections, the total number of outgoing messages, the average message size, and the total outgoing message size. You can limit the results to the time range that you specify. It is important to have an understanding of the trends of normal message volume and spikes in your environment. You can use the outgoing mail page to help track volume growth over time and plan for system capacity. You might also want to compare the Outgoing Mail data with the Outgoing Destinations data to view the trends in volumes of emails that are being sent from specific domains or IP addresses.

## System Capacity-System Load

The system load report shows the following:

- Overall CPU Usage
- Memory Page Swapping
- Resource Conservation Activity

### Overall CPU Usage

The appliance is optimized to use idle CPU resources to improve message throughput. High CPU usage may not indicate a system capacity problem. If the high CPU usage is coupled with consistent, high-volume memory page swapping, you may have a capacity problem.



**Note** This graph also shows the threshold level for CPU usage. If you want to change the threshold level, use the **System Administration > System Health** page in web interface or **healthconfig** command in CLI. See [Setting Thresholds for System Health Parameters, on page 1019](#).

This page also shows a graph that displays the amount of CPU used by different functions, including mail processing, spam and virus engines, reporting, and quarantines. The CPU-by-function graph is a good indicator of which areas of the product use the most resources on your system. If you need to optimize your appliance, this graph can help you determine which functions may need to be tuned or disabled.

### Memory Page Swapping

The memory page swapping graph shows how frequently the system must page to disk. This graph also shows the threshold level for memory page swapping. If you want to change the threshold level, use the **System Administration > System Health** page in web interface or **healthconfig** command in CLI. See [Setting Thresholds for System Health Parameters, on page 1019](#).

### Resource Conservation Activity

The resource conservation activity graph shows the number of times the appliance entered Resource Conservation Mode (RCM). For example, if the graph shows *n* times, it means that the appliance has entered RCM *n* times and exited at least *n*-1 times.

Your appliance should enter RCM infrequently and only during a very large or unusual increase in mail volume. If the Resource Conservation Activity graph shows that your appliance is entering RCS frequently, it may be an indication that the system is becoming overloaded.

## Note about Memory Page Swapping

The system is designed to swap memory regularly, so some memory swapping is expected and is not an indication of problems with your appliance. Unless the system *consistently* swaps memory in high volumes, memory swapping is normal and expected behavior, especially on C170 and C190 appliances. To improve performance, you may need to add appliances to your network or tune your configuration to ensure maximum throughput.

## System Capacity- All

The All page consolidates all the previous system capacity reports onto a single page so you can view the relationship between the different reports. For example, you might view the message queue is high at the same time that excessive memory swapping takes place. This might be an indication that you have a capacity problem. You may want to save this page as PDF to preserve a snapshot of system performance for later reference (or to share with support staff). For information about generating PDFs in languages other than English, see the [Notes on Reports, on page 882](#).

## Reporting Data Availability

The **Reporting Data Availability** page allows you to view data to provide real-time visibility into resource utilization and email traffic trouble spots.

All data resource utilization and email traffic trouble spots are shown from this page, including the data availability for the overall appliances that are managed by the Security Management appliance.

From this report page you can also view the data availability for a specific appliance and time range.

## Advanced Malware Protection Page

Advanced Malware Protection protects against zero-day and targeted file-based threats in email attachments by:

- Obtaining the reputation of known files.
- Analyzing behavior of certain files that are not yet known to the reputation service.
- Evaluating emerging threats as new information becomes available, and notifying you about files that are determined to be threats after they have entered your network.

This feature is available for incoming and outgoing messages.

For more information on the file reputation filtering and file analysis, see the *User Guide or Online Help for AsyncOS for Email Security Appliances*.

To view the report page, select **Advanced Malware Protection** from the File and Malware Reports section of the Reports drop-down.

The Advanced Malware Protection report page shows the following reporting views:

- [Advanced Malware Protection – Summary, on page 855](#)
- [Advanced Malware Protection – AMP Reputation, on page 856](#)
- [Advanced Malware Protection – File Analysis, on page 857](#)
- [Advanced Malware Protection – File Retrospection, on page 857](#)
- [Advanced Malware Protection – Mailbox Auto Remediation, on page 858](#)

The Advanced Malware Protection report page displays a metrics bar that provides real time data of the appliance connected to the Cisco Threat Grid appliance.



### Note

- You must use the `trailblazerconfig > enable` command on the CLI to populate data on the metrics bar. For more information, see the *Cisco Email Security Command Reference Guide*.
- You can only view the data from the Cisco Threat Grid appliance for the day, week and month.

### Related Topics

- [Identifying Files by SHA-256 Hash , on page 859](#)
- [Viewing File Reputation Filtering Data in Other Reports , on page 859](#)

## Advanced Malware Protection – Summary

The Advanced Malware Protection - Summary page shows the complete summary of the incoming and outgoing file-based threats that are identified by the file reputation and file analysis service.

For more information, see [Advanced Malware Protection – AMP Reputation, on page 856](#) and [Advanced Malware Protection – File Analysis, on page 857](#).

## Advanced Malware Protection – AMP Reputation

The Advanced Malware Protection - AMP Reputation page shows incoming and outgoing file-based threats that were identified by the file reputation service.

For files with changed verdicts, see the AMP Verdict updates report. Those verdicts are not reflected in the Advanced Malware Protection report.

If a file extracted from a compressed or archived file is malicious, only the SHA value of the compressed or archived file is included in the Advanced Malware Protection report.

The **Incoming files handled by AMP** section shows the incoming malware files by different categories such as malicious, clean, unknown, unscannable, and low risk.

Incoming malicious files are categorized as the following:

- The percentage of block listed file SHAs received from the AMP reputation server that are categorized as **Malware**.
- The percentage of block listed file SHAs received from the AMP for Endpoints console that are categorised as **Custom Detection**. The threat name of a block listed file SHA obtained from AMP for Endpoints console is displayed as **Simple Custom Detection** in the Incoming Malware Threat Files section of the report.
- The percentage of block listed file SHAs based on the threshold settings that are categorised as **Custom Threshold**.

You can click on the link in the More Details section of the report to view the file trajectory details of a block listed file SHA in the AMP for Endpoints console.

You can view the **Low Risk** verdict details in the Incoming Files Handed by AMP section of the report.

You can use the AMP Reputation view of the Advanced Malware Protection: Incoming report page to view:

- The summary of incoming files that are identified by file reputation service of the Advanced Malware Protection engine, in a graphical format.
- A trend graph for all the incoming malware threat files based on the selected time range.
- The top incoming malware threat files.
- The top incoming threat files based on the file types.
- The Incoming Malware Threat Files interactive table that lists the top incoming malware threat files.

Drill down to view detailed analysis results, including the threat characteristics for each file.

If your access privileges allow you to view Message Tracking data for the messages that populate this report, click a blue number link in the table.

You can use the AMP Reputation view of the Advanced Malware Protection: Outgoing report page to view:

- The summary of outgoing files that are identified by file reputation service of the Advanced Malware Protection engine, in a graphical format.
- A trend graph for all the outgoing malware threat files based on the selected time range.

- The top outgoing malware threat files.
- The top outgoing threat files based on the file types.
- The Outgoing Malware Threat Files interactive table that lists the top outgoing malware threat files that are identified by the file reputation service.

Drill down to view detailed analysis results, including the threat characteristics for each file.

If your access privileges allow you to view Message Tracking data for the messages that populate this report, click a blue number link in the table.

## Advanced Malware Protection – File Analysis

The Advanced Malware Protection - File Analysis page shows the time and verdict (or interim verdict) for each file sent for analysis. The appliance checks for analysis results every 30 minutes.

To view more than 1000 File Analysis results, export the data as a .csv file.

For deployments with an on-premises Cisco AMP Threat Grid Appliance: Files that are allow listed on the AMP Threat Grid appliance show as "clean". For information about allow listing, see the AMP Threat Grid documentation or online help.

Drill down to view detailed analysis results, including the threat characteristics for each file.

You can also search for additional information about an SHA, or click the link at the bottom of the file analysis details page to view additional details on the server that analyzed the file. For more information, see [Identifying Files by SHA-256 Hash](#), on page 859.

If your access privileges allow you to view Message Tracking data for the messages that populate this report, click the **Details** link in the table.

If a file extracted from a compressed or archived file is sent for analysis, only the SHA value of the extracted file is included in the File Analysis report.

You can use the File Analysis view of the Advanced Malware Protection report page to view:

- The number of incoming and outgoing files that are uploaded for file analysis by file analysis service of the Advanced Malware Protection engine.
- A list of incoming and outgoing files that have completed file analysis requests.
- A list of incoming and outgoing files that have pending file analysis requests.

## Advanced Malware Protection – File Retrospection

The Advanced Malware Protection - File Retrospection page lists the files processed by this appliance for which the verdict has changed since the message was received. For more information about on this scenario, see the documentation for your appliance.

As Advanced Malware Protection is focused on targeted and zero-day threats, threat verdicts can change as aggregated data might unviel more information.

To view more than 1000 verdict updates, export the data as a .csv file.

In the case of multiple verdict changes for a single SHA-256, this report shows only the latest verdict, not the verdict history.

To view all affected messages for a particular SHA-256 within the maximum available time range (regardless of the time range selected for the report) click a SHA-256 link.

You can use the File Retrospection view of the Advanced Malware Protection report page to view:

- A list of incoming and outgoing files with retrospective verdict changes.

## Advanced Malware Protection – Mailbox Auto Remediation

The Advanced Malware Protection - Mailbox Auto Remediation report page shows the details of the mailbox remediation results for the incoming files.

You can use the Advanced Malware Protection - Mailbox Auto Remediation page to view retrospective security details such as:

- A list of recipients for whom the mailbox remediation was successful or unsuccessful
- Remedial actions taken on messages
- The filenames associated with a SHA-256 hash
- A list of profile names defined for the recipients for whom the mailbox remediation was successful or unsuccessful
- Reason for the remediation failure
- No profile mapped to the domain

The Recipients for whom remediation was unsuccessful field is updated in the following scenario:

- *Invalid Mailbox*: The recipient is not a valid Microsoft Exchange online or Microsoft Exchange on-premise user, or the recipient does not belong to the Microsoft Exchange online or an Microsoft Exchange on-premise domain account configured on your appliance .
- The message containing the attachment is no longer available in the mailbox, for example, the end user deleted the message.
- *Authentication Error*: The user account provided on your appliance to connect to the Microsoft Exchange on-premise mailbox is incorrect.
- *Connection Error*: There is a connectivity issue between your appliance and Microsoft Exchange online or Microsoft Exchange on-premise services when the appliance attempts to perform the remedial action.
- *Permission Error*:
  - In case of a Microsoft Exchange on-premise account, the user account provided on your appliance to connect to the Microsoft Exchange on-premise mailbox is not assigned the impersonator role.
  - In case of a Microsoft Exchange online account, the Office 365 application does not have the required permission to access the recipient mailbox.
- *No Profile Mapped for domain*: There is no profile mapped to the recipient domain.
- *Mailbox is Inaccessible or Invalid*:
  - The profile type of the account profile that is used to access the mailbox is incorrect.
  - The recipient is not a valid Microsoft Exchange online or Microsoft Exchange on-premise user.
  - The recipient does not belong to the Microsoft Exchange online or an Microsoft Exchange on-premise domain account configured on your appliance.

Click on a SHA-256 hash to view the related messages in Message Tracking.



## Identifying Files by SHA-256 Hash

Because filenames can easily be changed, the appliance generates an identifier for each file using a Secure Hash Algorithm (SHA-256). If an appliance processes the same file with different names, all instances are recognized as the same SHA-256. If multiple appliances process the same file, all instances of the file have the same SHA-256 identifier.

In most reports, files are listed by their SHA-256 value (in an abbreviated format).

## Viewing File Reputation Filtering Data in Other Reports

Data for file reputation and analysis is available in other reports where relevant. A Detected by Advanced Malware Protection column may be hidden by default in applicable reports. To display additional columns, click the Customize Columns icon at the top right side of the table.

## Virus Filtering Page

The Virus Filtering page provides an overview of the viruses entering and being sent from your network. The Virus Filtering page displays the viruses that have been detected by the virus scanning engines running on your appliance. You might want to use this report to take a specific action against a particular virus. For example, if you see that you are receiving a high volume of a viruses known to be embedded in PDF files, you might want to create a filter action to quarantine messages with PDF attachments.

If you run multiple virus scanning engines, the Virus Filtering page includes results from all enabled virus scanning engines. The name of the virus displayed on the page is a name determined by the virus scanning engines. If more than one scanning engine detects a virus, it is possible to have more than one entry for the same virus.

The Virus Filtering page gives you an overview of the viruses entering or being sent from or to your network. The Top Incoming Virus Detected section shows a chart view of the viruses that have been sent to your network in descending order. The Top Outgoing Virus Detected section shows a chart view of the viruses that have been sent from your network in descending order.

**Note**

To see which hosts sent virus-infected messages to your network, you can go to the Incoming Mail page, specify the same reporting period and sort by virus-positive. Similarly, to see which IP addresses have sent virus-positive email within your network, you can view the Outgoing Senders page and sort by virus-positive messages.

The VirusTypes Details listing displays information about specific viruses, including the infected incoming and outgoing messages, and the total infected messages. The details listing for infected incoming messages displays the name of the virus and the number of incoming messages infected with this virus. Similarly, the outgoing messages displays the name of the virus and the number of outgoing messages infected with the virus. You can sort the Virus Type details by Incoming Messages, Outgoing Messages, or Total Infected Messages.

## Macro Detection Page

You can use the Macro Detection report page to view:

- Top and summary of Incoming Macro-Enabled Attachments by File Type in graphical and tabular format.

- Top and summary Outgoing Macro-Enabled Attachments by File Type in graphical and tabular format.

You can click on the number of macro-enabled attachments to view the related messages in Message Tracking.

To view the Macro Detection report page on the appliance, select **Macro Detection** from the Reports drop-down.



**Note** During report generation:

- If one or more macros are detected within an archive file, the Archive Files file type is incremented by one. The number of macro-enabled attachments within an archive file are not counted.
- If one or more macros are detected within an embedded file, the parent file type is incremented by one. The number of macro-enabled attachments within an embedded file are not counted.

## DMARC Verification Page

The DMARC Verification page shows the top domains that failed DMARC verification and the details of actions AsyncOS performed on the messages that failed DMARC verification. You can use this report to fine-tune your DMARC settings and answer these kinds of questions:

- Which are the domains that sent maximum number of messages that are not DMARC compliant?
- For each domain, what are the actions AsyncOS performed on the messages that failed DMARC verification?

The DMARC Verification page contains:

- A graphical representation showing top domains by DMARC verification failures.
- Tabular representation of the following, for each domain:
  - Number of messages that were rejected, quarantined, or accepted without taking any action. Click the number to view a list of messages under the selected category.
  - Number messages that passed DMARC verification.
  - Total number of DMARC verification attempts.

You can select a time range on which to report, such as an hour, a week, or a custom range. As with all reports, you can export the data for the graphs or the details listing to CSV format via the **Export** link.

## URL Filtering Page

- URL Filtering report modules are populated only if URL filtering is enabled.
- URL Filtering reports are available for incoming and outgoing messages.
- Only messages that are scanned by the URL filtering engine (either as part of anti-spam/outbreak filter scanning or through message/content filters) are included in these modules. However, not all of the results are necessarily specifically attributable to the URL Filtering feature.
- The Top URL Categories module includes all categories found in messages that have been scanned, whether or not they match a content or message filter.

- Each message can be associated with only one URL reputation level. For messages with multiple URLs, the statistics reflect the lowest reputation of any URL in the message.
- URLs in the global allowed list configured at Security Services > URL Filtering are not included in reports.  
URLs in allowed lists used in individual filters are included in reports.
- Malicious URLs are URLs that Outbreak Filters have determined to have poor reputation. Neutral URLs are those that Outbreak Filters have determined to require click-time protection. Neutral URLs have therefore been rewritten to redirect them to the Cisco Web Security proxy.
- Results of URL category-based filters are reflected in content and message filter reports.
- Results of click-time URL evaluations by the Cisco Web Security proxy are not reflected in reports.

## Outbreak Filtering Page

The Outbreak Filtering report page shows information about recent outbreaks and messages quarantined due to Outbreak Filters. You can use this page to monitor your defense against targeted virus, scam, and phishing attacks.

Use the Outbreak Filtering report page to answer the following types of questions:

- How many messages are quarantined and by which Outbreak Filters rule?
- How long do messages stay in the Outbreak Quarantine?
- Which potentially malicious URLs are most frequently seen?

To view the Outbreak Filtering report page, select **Outbreak Filtering** from the Reports drop-down.

The following table explains the various sections on the Outbreak Filtering report page:

**Table 88: Details on the Outbreak Filtering Page**

| Section                     | Description                                                                                                                                                                                                                                                                                                                                        |
|-----------------------------|----------------------------------------------------------------------------------------------------------------------------------------------------------------------------------------------------------------------------------------------------------------------------------------------------------------------------------------------------|
| Time Range (drop-down list) | A drop-down list with options for choosing a time range to view.                                                                                                                                                                                                                                                                                   |
| Threats By Type             | The Threats by Type section shows the different types of threat messages received by the appliance .                                                                                                                                                                                                                                               |
| Threat Summary              | The Threat Summary section shows a breakdown of the messages by Malware, Phish, Scam and Virus.<br><br>To view Message Tracking details for the messages that populate this report, click a blue number link in the table.                                                                                                                         |
| Threat Details              | The Threat Details interactive table shows details about specific outbreaks, including the threat category (virus, scam, or phishing), threat name, a description of the threat, and the number of messages identified.<br><br>To view Message Tracking details for the messages that populate this report, click a blue number link in the table. |

| Section                                 | Description                                                                                                                                                                                                                                                                                                                                                                                                                                                                                                                                                     |
|-----------------------------------------|-----------------------------------------------------------------------------------------------------------------------------------------------------------------------------------------------------------------------------------------------------------------------------------------------------------------------------------------------------------------------------------------------------------------------------------------------------------------------------------------------------------------------------------------------------------------|
| Hit Messages from Incoming Messages     | <p>The Hit Messages from Incoming Messages section shows the chart and summary of the number of incoming messages processed by Outbreak Filters in the selected time period.</p> <p>Non-viral threats include phishing emails, scams, and malware distribution using links to an external website.</p>                                                                                                                                                                                                                                                          |
| Hit Messages by Threat Level            | <p>The Hit Messages by Threat Level section shows the chart and summary of the severity of threats caught by Outbreak Filters.</p> <p>Level 5 threats are severe in scope or impact, while Level 1 represents low threat risk. For descriptions of threat levels, see the online help or user guide for your appliance .</p>                                                                                                                                                                                                                                    |
| Messages resided in Outbreak Quarantine | <p>The Messages resided in Outbreak Quarantine shows the length of time messages spent in the Outbreak Quarantine.</p> <p>This duration is determined by the time it takes the system to compile enough data about the potential threat to make a verdict on its safety. Messages with viral threats typically spend more time in the quarantine than those with non-viral threats, because they must wait for anti-virus program updates. The maximum retention time that you specify for each mail policy is also reflected.</p>                              |
| Top URL's Rewritten                     | <p>The Top URL's Rewritten section shows the URLs that are most frequently rewritten to redirect message recipients to the Cisco Web Security Proxy for click-time evaluation of the site if and when the recipient clicks a potentially malicious link in a message.</p> <p>This list may include URLs that are not malicious, because if any URL in a message is deemed malicious, then all URLs in the message are rewritten.</p> <p>To view Message Tracking details for the messages that populate this report, click a blue number link in the table.</p> |



**Note** In order to correctly populate the tables on the Outbreak Filtering report page, the appliance must be able to communicate with the Cisco update servers.

## Forged Email Detection Page

The Forged Email Detection page includes the following reports:

- **Top Forged Email Detection.** Displays the top ten users in the content dictionary that matched the forged From: header in the incoming messages.
- **Forged Email Detection: Details.** Displays a list of all the users in the content dictionary that matched the forged From: header in the incoming messages and for a given user, the number of messages matched.

To view the Forged Email Detection report page on the Security Management appliance, select **Forged Email Detection** from the Reports drop-down.

The Forged Email Detection reports are populated only if you are using the Forged Email Detection content filter or the `forged-email-detection` message filter.

From the Forged Email Detection report page you can export raw data to a CSV file. Click **Export** link on the top of a report page. Select the required report module that you want to export and click **Download**.

## Sender Domain Reputation Page

You can use the Sender Domain Reputation report page to view:

- Incoming messages based on the verdict received from the SDR service in graphical format.
- Incoming messages based on the threat category received from the SDR service in graphical format.



---

**Note** Only the messages whose SDR verdict is 'awful' or 'poor' are classified under the SDR threat category, such as, 'spam,' 'malicious,' etc.

---

- Summary of incoming messages based on the threat category received from the SDR service in tabular format.

To view the Sender Domain Reputation report page on the Security Management appliance, select **Sender Domain Reputation** from the Reports drop-down.

## External Threat Feeds Page

You can use the External Threat Feeds report page to view:

- Top ETF sources used to detect threats in messages in graphical format
- Summary of ETF sources used to detect threats in messages in tabular format.
- Top IOCs that matched threats detected in messages in graphical format.
- Top ETF sources used to filter malicious incoming mail connections in graphical format.
- Summary of ETF sources used to filter malicious incoming mail connections in tabular format.

In the 'Summary of External Threat Feed Sources' section:

- You can click on the number of messages for a particular ETF source to view the related messages in Message Tracking.
- You can click on a particular threat feed source to view the distribution of the ETF source based on the IOCs.

In the 'Summary of Indicator of Compromise (IOC) Matches' section:

- You can click on the number of IOCs for a particular ETF source to view the related messages in Message Tracking.
- You can click on a particular IOC to view the distribution of the IOC based on the ETF sources.

To view the External Threat Feeds report page, select **External Threat Feeds** from the Reports drop-down.

## Mail Flow Details Page

The Mail Flow Details report page provides interactive reporting on the real-time information for all remote hosts connecting to your managed Security Management appliances . You can gather information about the IP addresses, domains, and network owners (organizations) sending mail to your system. You can also gather information about the IP addresses and domains of the outgoing senders.

To view the Mail Flow Details report page, select **Mail Flow Details** from the Reports drop-down.

The Mail Flow Details report page has the following tabs:

- Incoming Mails
- Outgoing Senders

To search for specific information within your data, see [Searching and the Interactive Email Report Pages](#) , on page 842.

From the Incoming Mails tab, you can:

- View the top senders by total threat messages in graphical format.
- View the top senders by clean messages in graphical format.
- View the top senders by graymail messages in graphical format.
- See the IP addresses, domains, or network owners (organizations) that have sent mail to your Security Management appliances .
- See detailed statistics on senders that have sent mail to your appliances . The statistics include the number of connections (accepted or rejected), attempted messages broken down by security service (sender reputation filtering, anti-spam, anti-virus, and so forth), total threat messages, total graymails and clean messages.
- See the Incoming Mails interactive table for the detailed information about the particular IP address, domain, or network owner (organization). For more information, see [Incoming Mails Table](#), on page 867.

If your access privileges allow you to view Message Tracking data for the messages that populate this report, click a number hyperlink in the table.

From the Outgoing Senders tab, you can:

- View the top senders by total threat messages in graphical format.
- View the top senders by clean messages in graphical format.
- View the top senders (by IP address or domain) of outgoing threat messages (spam, antivirus, etc.) in your organization.
- See detailed statistics on senders that have sent mail from your appliances . The statistics include the total threat messages broken down by security service (sender reputation filtering, anti-spam, anti-virus, and so forth) and clean messages.
- See the Sender Details interactive table for detailed information about the particular IP address or domain. For more information, see [Sender Details Table](#), on page 870.

If your access privileges allow you to view Message Tracking data for the messages that populate this report, click a number hyperlink in the table.

### Related Topics

- [Incoming Mails Table, on page 867](#)
- [“No Domain Information”, on page 866](#)
- [Time Range for Reports, on page 844](#)
- [Views Within the Mail Flow Details Page, on page 865](#)

## Views Within the Mail Flow Details Page

The Mail Flow Details: Incoming report page has three different views:

- IP Addresses
- Domains
- Network Owners

These views provide a snapshot of the remote hosts connecting to the system in the context of the selected view.

Additionally, in the Incoming Mail table of the Mail Flow Details page, you can click on a Sender’s IP Address, Domain name, or Network Owner Information to retrieve specific Sender Profile Information. For more information on Sender Profile information, see the [Sender Profile Pages, on page 869](#).



---

**Note** Network owners are entities that contain domains. Domains are entities that contain IP addresses.

---

Depending on the view you select, the Incoming Mail Details interactive table displays the top IP addresses, domains, or network owners that have sent mail to all public listeners configured on the appliances . You can monitor the flow of all mail into your appliances.

Click an IP address, domain, or network owner to access details about the sender on the Sender Profile page. The Sender Profile page is an Mail Flow Details page that is specific to a particular IP address, domain, or network owner.

See the [Incoming Mails Table, on page 867](#) for an explanation of the data included in the Incoming Mails interactive table.

From the Mail Flow Details page you can export raw data to a CSV file.



---

**Note** You can generate a scheduled report for the Mail Flow Details report page. See the [Scheduled Reports, on page 883](#).

---

The Mail Flow Details: Outgoing report page has two different views:

- IP Addresses

- Domains

These views provide a snapshot of the remote hosts connecting to the system in the context of the selected view.

Depending on the view you select, the Sender Details interactive table displays the top IP addresses or domains of the senders that have sent mail from the public listeners configured from the Email Security appliances. You can monitor the flow of all mail from your appliances .

See the [Sender Details Table, on page 870](#) for an explanation of the data included in the Sender Details interactive table.

### "No Domain Information"

Domains which have connected to the appliance and could not be verified with a double-DNS lookup are automatically grouped into the special domain "No Domain Information." You can control how these types of unverified hosts are managed via Sender Verification. See [Configuring the Gateway to Receive Email, on page 69](#).

You can select the number of senders to show in the listing via the Items Displayed menu.

### Time Range for Reports

The Email Security Monitor feature constantly records data about the mail flowing into your gateway. The data are updated every 60 seconds, but the display shown is delayed by 120 seconds behind the current system time. You can specify the time range to include in the results shown. Because the data is monitored in real time, information is periodically updated and summarized in the database.

Choose from the time range options in the following table.

**Table 89: Time Ranges Available in the Email Security Monitor Feature**

| This time range selected in the GUI | ...is defined as:                                                                        |
|-------------------------------------|------------------------------------------------------------------------------------------|
| Hour                                | the last 60 minutes + up to 5 minutes                                                    |
| Day                                 | the last 24 hours + the last 60 minutes                                                  |
| Week                                | the last 7 days + the elapsed hours of the current day                                   |
| 30 days                             | the last 30 days + the elapsed hours of the current day                                  |
| 90 days                             | the last 90 days + the elapsed hours of the current day                                  |
| Yesterday                           | 00:00 to 23:59 (midnight to 11:59 PM)                                                    |
| Previous Calendar Month             | 00:00 of the first day of the month to 23:59 of the last day of the month                |
| Custom Range                        | the range enclosed by the start date and hour and the end date and hour that you specify |



## Incoming Mails Table

The interactive Incoming Mails table at the bottom of the Mail Flow Details: Incoming Mails page lists the top senders that have connected to public listeners on the appliances. The table shows domains, IP addresses, or network owners, based on the view selected.

The system acquires and verifies the validity of the remote host's IP address by performing a double DNS lookup. For more information about *double DNS lookups* and sender verification, see the user guide or online help for the appliance.

For senders, that is Network Owner, IP Address or Domain, listed in the first column of the Incoming Mails table, or on the Top Senders by Total Threat Messages, click the Sender or No Domain Information link to view more information about the sender. The results appear on a Sender Profile page, which includes real-time information from the IP Reputation Service. From the Sender Profile page, you can view for more information about specific IP addresses or network owners. For more information, see the [Sender Profile Pages, on page 869](#).

You can also view the Sender Groups report, by clicking Sender Groups report at the bottom of the Mail Flow Details page. For more information about the Sender Groups report page, see the [Sender Groups Report, on page 871](#).

To view Message Tracking details for the messages that populate this report, click a number hyperlink in the table.

The following table shows the table column descriptions for the Incoming Mails table:

**Table 90: Table Column Descriptions for Incoming Mail Table**

| Column Name                                       | Description                                                                                                                                                                                                                                                                       |
|---------------------------------------------------|-----------------------------------------------------------------------------------------------------------------------------------------------------------------------------------------------------------------------------------------------------------------------------------|
| Sender Domain (Domains)                           | The domain name of the sender.                                                                                                                                                                                                                                                    |
| Sender IP Address (IP Addresses)                  | The IP address of the sender.                                                                                                                                                                                                                                                     |
| Hostname (IP Addresses)                           | The hostname of the sender.                                                                                                                                                                                                                                                       |
| DNS Verified (IP Addresses)                       | The IP addresses that are verified by the DNS.                                                                                                                                                                                                                                    |
| IP Reputation Score (IP Addresses)                | The IP Reputation Score of the sender.                                                                                                                                                                                                                                            |
| Last Sender Group (IP Addresses)                  | The details of the last sender group.                                                                                                                                                                                                                                             |
| Last Sender Group (IP Addresses)                  | The details of the last sender group.                                                                                                                                                                                                                                             |
| Network Owner (Network Owners)                    | The network owner of the sender.                                                                                                                                                                                                                                                  |
| Connections Rejected (Domains and Network Owners) | All connections blocked by HAT policies. When the appliance is under heavy load, an exact count of rejected connections is not maintained on a per-sender basis. Instead, rejected connections counts are maintained only for the most significant senders in each time interval. |

| Column Name                                                  | Description                                                                                                                                                                                                                                                                                                                                                                                                                                                                                                                                                                                                                                                                                                                                                                                                                                                                                                                                              |
|--------------------------------------------------------------|----------------------------------------------------------------------------------------------------------------------------------------------------------------------------------------------------------------------------------------------------------------------------------------------------------------------------------------------------------------------------------------------------------------------------------------------------------------------------------------------------------------------------------------------------------------------------------------------------------------------------------------------------------------------------------------------------------------------------------------------------------------------------------------------------------------------------------------------------------------------------------------------------------------------------------------------------------|
| Connections Accepted (Domains and Network Owners)            | All connections accepted,                                                                                                                                                                                                                                                                                                                                                                                                                                                                                                                                                                                                                                                                                                                                                                                                                                                                                                                                |
| Total Attempted                                              | All accepted and blocked connections attempted.                                                                                                                                                                                                                                                                                                                                                                                                                                                                                                                                                                                                                                                                                                                                                                                                                                                                                                          |
| Stopped by Recipient Throttling (Domains and Network Owners) | This is a component of Stopped by Reputation Filtering. It represents the number of recipient messages stopped because any of the following HAT limits have been exceeded: maximum recipients per hour, maximum recipients per message, or maximum messages per connection. This is summed with an estimate of the recipient messages associated with rejected or TCP refused connections to yield Stopped by Reputation Filtering.                                                                                                                                                                                                                                                                                                                                                                                                                                                                                                                      |
| Stopped by Reputation Filtering                              | <p>The value for Stopped by Reputation Filtering is calculated based on several factors:</p> <ul style="list-style-type: none"> <li>• Number of “throttled” messages from this sender</li> <li>• Number of rejected or TCP refused connections (may be a partial count)</li> <li>• A conservative multiplier for the number of messages per connection.</li> </ul> <p>When the appliance is under heavy load, an exact count of rejected connections is not maintained on a per-sender basis. Instead, rejected connections counts are maintained only for the most significant senders in each time interval. In this situation, the value shown can be interpreted as a “floor”; that is, at least this many messages are stopped.</p> <p><b>Note</b> The Reputation Filtering total on the Mail Flow Summary page is always based on a complete count of all rejected connections. Only the per-sender connection counts are limited due to load.</p> |
| Stopped as Invalid Recipients                                | All mail recipients rejected by conversational LDAP rejection plus all RAT rejections.                                                                                                                                                                                                                                                                                                                                                                                                                                                                                                                                                                                                                                                                                                                                                                                                                                                                   |
| Spam Detected                                                | Any spam that has been detected.                                                                                                                                                                                                                                                                                                                                                                                                                                                                                                                                                                                                                                                                                                                                                                                                                                                                                                                         |
| Virus Detected                                               | Any viruses that have been detected                                                                                                                                                                                                                                                                                                                                                                                                                                                                                                                                                                                                                                                                                                                                                                                                                                                                                                                      |
| Detected by Advanced Malware Protection                      | The total count of messages detected by Advanced Malware Protection engines.                                                                                                                                                                                                                                                                                                                                                                                                                                                                                                                                                                                                                                                                                                                                                                                                                                                                             |
| Stopped by Content Filter                                    | The total count of messages that are stopped by a content filter.                                                                                                                                                                                                                                                                                                                                                                                                                                                                                                                                                                                                                                                                                                                                                                                                                                                                                        |
| Stopped by DMARC                                             | The total count of messages that failed Domain-based Message Authentication, Reporting and Conformance (DMARC) verification.                                                                                                                                                                                                                                                                                                                                                                                                                                                                                                                                                                                                                                                                                                                                                                                                                             |
| Total Threat                                                 | Total number of threat messages (stopped by reputation, stopped as invalid recipient, spam, plus virus)                                                                                                                                                                                                                                                                                                                                                                                                                                                                                                                                                                                                                                                                                                                                                                                                                                                  |
| Marketing                                                    | Number of messages detected as unwanted marketing messages.                                                                                                                                                                                                                                                                                                                                                                                                                                                                                                                                                                                                                                                                                                                                                                                                                                                                                              |
| Social                                                       | Number of messages detected as social messages.                                                                                                                                                                                                                                                                                                                                                                                                                                                                                                                                                                                                                                                                                                                                                                                                                                                                                                          |

| Column Name     | Description                                                                                                                |
|-----------------|----------------------------------------------------------------------------------------------------------------------------|
| Bulk            | Number of messages detected as bulk.                                                                                       |
| Total Graymails | Number of messages detected as graymails.                                                                                  |
| Clean           | All clean messages.<br>Messages processed on appliances on which the graymail feature is not enabled are counted as clean. |

## Sender Profile Pages

When you click a sender in the Incoming Mail Details interactive table, on the **Mail Flow Details** [New Web Interface] or **Incoming Mail** page, the Sender Profile page appears. It shows detailed information about the particular IP address, domain, or network owner (organization). You can access a Sender Profile page for any IP address, domain, or network owner by clicking the corresponding link on the Incoming Mail page or on other Sender Profile pages.

*Network owners* are entities that contain domains. *Domains* are entities that contain IP addresses.

The Sender Profile pages displayed for IP addresses, domains, and network owners vary slightly. For each, the page contains a graph and summary table for incoming mail from the particular sender. Below the graph, a table lists the domains or IP addresses associated with the sender. (The Sender Profile page for an individual IP address does not contain a more granular listing.) The Sender Profile page also includes an information section with the current SenderBase, sender group, and network information for the sender.

- Network Owner profile pages contain information for the network owner, as well as the domains and IP addresses associated with that network owner.
- Domain profile pages contain information for the domains and IP addresses associated with that domain.
- IP address profile pages contain information about the IP address only.

Each Sender Profile page contains the following data in the Current Information table at the bottom of the page:

- The global information from the IP Reputation Service, including:
  - IP address, domain name, and/or network owner
  - Network owner category (network owner only)
  - CIDR range (IP addresses only)
  - Daily magnitude and monthly magnitude for the IP address, domain, and/or network owner
  - Days since the first message was received from this sender
  - Last sender group and whether DNS verified (IP address sender profile page only)

Daily magnitude is a measure of how many messages a domain has sent over the last 24 hours. Similar to the Richter scale used to measure earthquakes, SenderBase magnitude is a measure of message volume calculated using a log scale with a base of 10. The maximum theoretical value of the scale is set to 10, which equates to 100% of the world's email message volume. Using the log scale, a one-point increase in magnitude equates to a 10x increase in actual volume.

Monthly magnitude is calculated using the same approach as daily magnitude, except the percentages are calculated based on the volume of email sent over the last 30 days.

- Average magnitude (IP addresses only)
- Lifetime volume / 30 day volume (IP address profile pages only)
- Bonded sender status (IP address profile pages only)
- IP Reputation Score (IP address profile pages only)
- Days since first message (network owner and domain profile pages only)
- Number of domains associated with this network owner (network owner and domain profile pages only)
- Number of IP addresses in this network owner (network owner and domain profile pages only)
- Number of IP addresses used to send email (network owner pages only)

Click **More from SenderBase** to see a page with all information supplied by the IP Reputation Service.

- Details about the domains and IP addresses controlled by this network owner appear on network owner profile pages. Details about the IP addresses in the domain appear on domain pages.

From a domain profile page, you can click on a specific IP address to view specific information, or view an organization profile page.

## Sender Details Table

The interactive Sender Details table at the bottom of the Mail Flow Details: Outgoing page lists the top senders that have connected to public listeners on the appliances. The table shows domains or IP addresses, based on the view selected.

To view Message Tracking details for the messages that populate this report, click a number hyperlink in the table.

The following table shows the table column descriptions for the Sender Details table:

**Table 91: Table Column Descriptions for Sender Details Table**

| Column Name                             | Description                                                                  |
|-----------------------------------------|------------------------------------------------------------------------------|
| Sender Domain (Domains)                 | The domain name of the sender.                                               |
| Sender IP Address (IP Addresses)        | The IP address of the sender.                                                |
| Hostname (IP Addresses)                 | The hostname of the sender.                                                  |
| Spam Detected                           | Any spam that has been detected.                                             |
| Virus Detected                          | Any viruses that have been detected.                                         |
| Detected by Advanced Malware Protection | The total count of messages detected by Advanced Malware Protection engines. |
| Stopped by Content Filter               | The total count of messages that are stopped by a content filter.            |

| Column Name    | Description                                                                                                                |
|----------------|----------------------------------------------------------------------------------------------------------------------------|
| Stopped by DLP | The total count of messages that are stopped by DLP engine.                                                                |
| Total Threat   | Total number of threat messages (spam, virus)                                                                              |
| Clean          | All clean messages.<br>Messages processed on appliances on which the graymail feature is not enabled are counted as clean. |
| Total Messages | The total count of all the messages.                                                                                       |

## Sender Groups Report

The Sender Groups report provides a summary of connections by sender group and mail flow policy action, allowing you to review SMTP connection and mail flow policy trends. The Mail Flow by Sender Group listing shows the percentage and number of connections for each sender group. The Connections by Mail Flow Policy Action chart shows the percentage of connections for each mail flow policy action. This page provides an overview of the effectiveness of your Host Access Table (HAT) policies. For more information about the HAT, see [Configuring the Gateway to Receive Email, on page 69](#).

## Outgoing Destinations

The Outgoing Destinations page provides information about the domains your company sends mail to. The page consists of two sections. The top half of the page consists of graphs depicting the top destinations by outgoing threat messages and top destinations by outgoing clean messages on the top half of the page. The bottom half of the page displays a chart showing all the columns sorted by total recipients (default setting).

You can select a time range on which to report, such as a day, a week, or a custom range. As with all reports, you can export the data for the graphs or the details listing to CSV format via the **Export** link.

The Outgoing Destinations page can be used to answer the following types of questions:

- What domains is the appliance sending mail to?
- How much mail is sent to each domain?
- How much of that mail is clean, spam-positive, virus-positive, malware or stopped by a content filter?
- How many messages are delivered and how many messages are hard-bounced by the destination server?

## TLS Encryption Page

The TLS Encryption pages shows the overall usage of TLS Encryption for sent and received mail. The report also shows details for each domain sending mail using TLS connections.

The TLS Encryption page can be used to determine the following information:

- Overall, what portion of incoming and outgoing connections use TLS?
- What partners do I have successful TLS connections with?
- What partners do I have unsuccessful TLS connections with?
- What partners do I have successful TLS connections with DANE support?

- What partners do I have unsuccessful TLS connections with DANE support?
- What partners have issue with their TLS certificates?
- What percent of overall mail with a partner uses TLS?
- What percent of outgoing TLS connections with DANE support are successful?
- What percent of outgoing connections with DANE support are unsuccessful?

The TLS Encryption page is divided into a section for incoming connections and a section for outgoing connections. Each section includes a graph, summaries, and a table with details.

The graph displays a view of incoming or outgoing TLS-encrypted and non-encrypted connections over the time range you specify. The graph displays the total volume of messages, the volume of encrypted and unencrypted messages, the volume of successful and failed TLS encrypted messages and the volume of successful and failed DANE connections. The graphs distinguish between connections in which TLS was required and connections in which TLS was merely preferred.

The table displays details for domains sending or receiving encrypted messages. For each domain, you can view the number of required and preferred TLS connections that were successful and that failed, the total number of TLS connections attempted (whether successful or failed), the total number of unencrypted connections, and the total number of unencrypted connections, and the total number of DANE connections (depending on whether successful or failed). You can also view the percentage of all connections in which TLS was attempted, and the total number of encrypted messages sent successfully, regardless of whether TLS was preferred or required. You can show or hide columns by Customize Columns icon at the top right side of the table.

## Inbound SMTP Authentication Page

The Inbound SMTP Authentication page shows the use of client certificates and the SMTP AUTH command to authenticate SMTP sessions between the appliance and users' mail clients. If the appliance accepts the certificate or SMTP AUTH command, it will establish a TLS connection to the mail client, which the client will use to send a message. Since it is not possible for the appliance to track these attempts on a per-user basis, the report shows details on SMTP authentication based on the domain name and domain IP address.

Use this report to determine the following information:

- Overall, how many incoming connection use SMTP authentication?
- How many connections use a client certificated?
- How many connections use SMTP AUTH?
- What domains are failing to connect when attempting to use SMTP authentication?
- How many connections are successfully using the fall-back when SMTP authentication fails?

The Inbound SMTP Authentication page includes a graph for received connections, a graph for mail recipients who attempted an SMTP authentication connection, and a table with details on the attempts to authenticate connections.

The Received Connections graph shows the incoming connections from mail clients that attempt to authentication their connections using SMTP authentication over the time range you specify. The graph displays the total number of connections the appliance received, the number that did not attempt to authenticate using SMTP authentication, the number that failed and succeeded to authenticate the connection using a client certificate, and the number that failed and succeeded to authenticate using the SMTP AUTH command.

The Received Recipients graph displays the number of recipients whose mail clients attempted to authenticate their connections to the appliances to send messages using SMTP authentication. The graph also shows the number of recipients whose connections were authenticated and the number of recipients whose connections were not authenticated.

The SMTP Authentication details table displays details for the domains whose users attempt to authenticate their connections to the appliance to send messages. For each domain, you can view the number of connection attempts using a client certificate that were successful or failed, the number of connection attempts using the SMTP AUTH command that were successful or failed, and the number that fell back to the SMTP AUTH after their client certificate connection attempt failed. You can use the tabs at the top of the page to display this information by domain name or domain IP address.

## Rate Limits Page

Rate Limiting by envelope sender allows you to limit the number of email message recipients per time interval from an individual sender, based on the mail-from address. The Rate Limits report shows you the senders who most egregiously exceed this limit.

Use this report to help you identify the following:

- Compromised user accounts that might be used to send spam in bulk.
- Out-of-control applications in your organization that use email for notifications, alerts, automated statements, etc.
- Sources of heavy email activity in your organization, for internal billing or resource-management purposes.
- Sources of large-volume inbound email traffic that might not otherwise be considered spam.

Note that other reports that include statistics for internal senders (such as Internal Users or Outgoing Senders) measure only the number of messages sent; they do not identify senders of a few messages to a large number of recipients.

The Top Offenders by Incident chart shows the envelope senders who most frequently attempted to send messages to more recipients than the configured limit. Each attempt is one incident. This chart aggregates incident counts from all listeners.

The Top Offenders by Rejected Recipients chart shows the envelope senders who sent messages to the largest number of recipients above the configured limit. This chart aggregates recipient counts from all listeners.

To configure rate limiting by envelope sender or modify the existing rate limit, see [Defining Rules for Incoming Messages Using a Mail Flow Policy, on page 107](#).

## Connections by Country Page

You can use the Connections by Country report page to view:

- Top incoming mail connections based on country of origin in graphical format.
- Total incoming mail connections based on country of origin in tabular format.

You can click on the number of incoming mail connections of a specific geolocation to view the related messages in Message Tracking.

The "Total Messages" column only displays those messages that are accepted at the SMTP connection level.



---

**Note** During report generation:

- If one or more incoming mail connections are detected as private IP address, the incoming mail connections are categorized as “Private IP Addresses” in the report.
  - If one or more incoming mail connections are detected as not a valid IP Reputation score, the incoming mail connections are categorized as ‘No Country Info’ in the report.
- 

## User Mail Summary Page

The User Mail Summary page provides information about the mail sent and received by your internal users, *per email address* (a single user may have multiple email addresses listed — the email addresses are not combined in the report).

The page consists of two sections:

- Graphs depicting the top users by clean incoming and outgoing messages and top users receiving graymail.
- User mail flow details

You can select a time range on which to report (hour, day, week, or month). As with all reports, you can export the data for the graphs or the details listing to CSV format via the **Export** link. You can also display hidden table columns or hide default columns by clicking the Customize Column icon on the top right side of the table.

The User Mail Flow Details listing breaks down the mail received and sent by each email address into clean, spam (incoming only), virus, malware, content filter matches, and graymail (incoming only). You can sort the listing by clicking on the column headers.

Using the Internal Users report, you can answer these kinds of questions:

- Who is sending the most external email?
- Who receives the most clean email?
- Who receives the most number of graymail messages?
- Who receives the most spam?
- Who is triggering which content filters?
- Whose email is getting caught by content filters?

Inbound Internal Users are the users for which you received email, based on the Rcpt To: address. Outbound Internal Users are based on the Mail From: address and are useful when tracking the types of email that senders on your internal network are sending.

Note that some outbound mail (like bounces) have a null sender. They are counted under outbound and “unknown.”

Click on an internal user to view the Internal User detail page for that user.



Click the Customize Columns icon on the top right side of the table to show columns that are hidden by default, such as the Incoming Spam Detected by Intelligent Multi-Scan column or Outgoing Spam Detected by Intelligent Multi-Scan column.

### Related Topics

- [User Mail Flow Details, on page 875](#)
- [Searching for a Specific Internal User, on page 824](#)

## User Mail Flow Details

The User Mail Flow details section shows detailed information about the specified user, including a breakdown of incoming and outgoing messages showing the number of messages in each category (spam detected, virus detected, detected by Advanced Malware Protection, stopped by content filter, graymail detected, and clean). Optionally, for incoming messages, you can click the Customize Columns icon on the top right side of the table to show the Incoming Spam Detected by Intelligent Multi-Scan column. This value reflects the number messages that contained attachments that were determined by file reputation filtering to be malicious. It does not include verdict updates or files found to be malicious by file analysis. Incoming and outgoing content filter and DLP policy matches are also shown.

Click a content filter name to view detailed information for that filter in the corresponding content filter information page (see [Content Filters Page, on page 825](#)). You can use this method to get a list of users who also sent or received mail that matched that particular content filter.

## Searching for a Specific Internal User

You can search for a specific internal user (email address) via the search form at the bottom User Mail Summary page. Choose whether to exactly match the search text or look for items starting with the entered text (for instance, starts with “ex” will match “example.com”).

## DLP Incident Summary Page

The DLP Incident Summary page shows information on the incidents of data loss prevention (DLP) policy violations occurring in outgoing mail. The appliance uses the DLP email policies enabled in the Outgoing Mail Policies table to detect sensitive data sent by your users. Every occurrence of an outgoing message violating a DLP policy is reported as an incident.

Using the DLP Incidents report, you can answer these kinds of questions:

- What type of sensitive data is being sent by your users?
- How severe are these DLP incidents?
- How many of these messages are being delivered?
- How many of these messages are being dropped?
- Who is sending these messages?

The DLP Incident Summary page is comprised of two main sections:

- the DLP incident trend graphs summarizing the top DLP incidents by severity (Low, Medium, High, Critical) and policy matches, and

- the DLP Incidents Details listing.

You can select a time range on which to report, such as an hour, a week, or a custom range. As with all reports, you can export the data for the graphs or the details listing to CSV format via the **Export** link. For information about generating PDFs in languages other than English, see the [Notes on Reports, on page 882](#).

Click the name of a DLP policy to view detailed information on the DLP incidents detected by the policy. You can use this method to get a list of users who sent mail that contained sensitive data detected by the policy.

### Related Topics

- [DLP Incident Details, on page 876](#)
- [DLP Policy Detail Page, on page 876](#)

## DLP Incident Details

The DLP policies currently enabled in the appliance's outgoing mail policies are listed in the DLP Incident Details table. Click the name of a DLP policy to view more detailed information.

The DLP Incident Details table shows the total number of DLP incidents per policy, with a breakdown by severity level. The severity level also includes the number of bounced messages and the number of messages delivered in the clear, delivered encrypted, or dropped. Click the column headings to sort the data.

## DLP Policy Detail Page

If you clicked the name of a DLP policy in the DLP Incident Details table, the resulting DLP Policy Detail page displays the DLP incidents data for the policy. The page displays graphs on the DLP incidents based on severity.

The page also includes an Incidents by Sender listing at the bottom of the page that lists each internal user who has sent a message that violated the DLP policy. The listing also shows the total number of DLP incidents for this policy per user, with a breakdown by severity level, and whether any of the messages were delivered in the clear, delivered encrypted, or dropped. You can use the Incidents by Sender listing to find out which users may be sending your organization's sensitive data to people outside your network.

Clicking on the sender name opens up the Internal Users page. See [#unique\\_1487](#) for more information.

## Web Interaction Page

- Web Interaction Tracking report modules are populated only if the web interaction tracking feature is enabled.
- Web Interaction Tracking report modules are not updated in real-time and are refreshed every 30 minutes. Also, after clicking a rewritten URL, it may take up to two hours for the Web Interaction Tracking report to report this event.
- Web Interaction Tracking report is not updated in real-time. After clicking a cloud re-directed rewritten URL, it may take up to two hours for the Web Interaction Tracking report to report this event.
- Web Interaction Tracking reports are available for incoming and outgoing messages.
- Only cloud re-directed rewritten URLs (either by policy or Outbreak Filter) clicked by the end users are included in these modules.

- Web Interaction Tracking page includes the following reports:

**Top Malicious URLs clicked by End Users.** Click on a URL to view a detailed report that contains the following information:

- A list of end users who clicked on the rewritten malicious URL.
- Date and time at which the URL was clicked.
- Whether the URL was rewritten by a policy or an outbreak filter.
- Action taken (allow, block, or unknown) when the rewritten URL was clicked. Note that, if a URL was rewritten by outbreak filter and the final verdict is unavailable, the status is shown as unknown.

#### **Top End Users who clicked on Malicious URLs**

This section displays the summary of the top end users who clicked on the Rewritten Malicious URLs, for incoming and outgoing messages.

**Web Interaction Tracking Details.** Includes the following information:

- A list of all the cloud re-directed rewritten URLs (malicious and unmalicious). Click on a URL to view a detailed report.
- Action taken (allow, block, or unknown) when a cloud re-directed rewritten URL was clicked.

For the data to show up, perform the following:

- Choose **Incoming Mail Policies > Outbreak Filters** to configure an outbreak filter and enable message modification and URL rewriting.
- Configure a content filter with the "**Redirect to Cisco Security Proxy**" action.

Note that, if the verdict of a URL (clean or malicious) was unknown at the time when the end user clicked it, the status is shown as unknown. This could be because the URL was under further scrutiny or the web server was down or not reachable at the time of the user click.

- The number of times end users clicked on a rewritten URL. Click on a number to view a list of all the messages that contain the clicked URL.
- While using Web Interaction Tracking reports, keep in mind the following limitations:
  - If you have configured a content or message filter to deliver messages after rewriting malicious URLs and notify another user (for example, an administrator), the web interaction tracking data of the original recipient is incremented even if the notified user clicks on the rewritten URLs.
  - If you are sending a copy of quarantined messages containing rewritten URLs to a user (for example, an administrator) using web interface, the web interaction tracking data of the original recipient is incremented even if the user (to whom the copy of the messages were sent) clicks on the rewritten URLs.
  - At any point, if you plan to modify the time of your appliance, make sure that the system time is synchronized with Coordinated Universal Time (UTC).

## Remediation Report Page

You can use the Remediation report to monitor the remediation results for Mailbox Auto Remediation and Mailbox Search and Remediate.

Use this report:

- To view the list of messages that are attempted for Mailbox Auto Remediation and Mailbox Search and Remediate.
- To know the reason for remediation failure. For example, connections errors, authentication errors, and so on.

The following list explains the various sections on the Rate Limit report:

| Section                  | Description                                                                                                                                                                                                                                                                                                                                                                                                                                                                                                                                                                                                      |
|--------------------------|------------------------------------------------------------------------------------------------------------------------------------------------------------------------------------------------------------------------------------------------------------------------------------------------------------------------------------------------------------------------------------------------------------------------------------------------------------------------------------------------------------------------------------------------------------------------------------------------------------------|
| Summary                  | <p>The Summary section displays the following:</p> <ul style="list-style-type: none"> <li>• Total number of messages attempted for remediation using Mailbox Auto Remediation and Mailbox Search and Remediate.</li> <li>• Number of messages successfully remediated for a configured remedial action.</li> <li>• Number of messages for which the remediation failed.</li> </ul>                                                                                                                                                                                                                               |
| Mailbox Auto Remediation | <p>The Mailbox Auto Remediation report section displays the following:</p> <ul style="list-style-type: none"> <li>• A list of recipients for whom the mailbox auto remediation was successful or unsuccessful.</li> <li>• Auto Remedial actions taken on messages.</li> <li>• The filenames associated with a SHA-256 hash. Click the SHA-256 hash to view the related messages in the Message Tracking page.</li> <li>• A list of profile names defined for the recipients for whom the mailbox auto remediation was successful or unsuccessful.</li> <li>• Reason for the auto remediation failure.</li> </ul> |

| Section                      | Description                                                                                                                                                                                                                                                                                                                                                                                                                                                                                                                                                                                                                                                                                                                                                                                                                                                                                                                                                                                                                                                                                                                                                                                                                                                                          |
|------------------------------|--------------------------------------------------------------------------------------------------------------------------------------------------------------------------------------------------------------------------------------------------------------------------------------------------------------------------------------------------------------------------------------------------------------------------------------------------------------------------------------------------------------------------------------------------------------------------------------------------------------------------------------------------------------------------------------------------------------------------------------------------------------------------------------------------------------------------------------------------------------------------------------------------------------------------------------------------------------------------------------------------------------------------------------------------------------------------------------------------------------------------------------------------------------------------------------------------------------------------------------------------------------------------------------|
| Mailbox Search and Remediate | <p>The Mailbox Search and Remediate section displays the following details:</p> <ul style="list-style-type: none"> <li>• The list of remediation batches that are in progress or completed.</li> <li>• The remediation status of the messages in the batches.</li> <li>• The batch name and the batch ID. Click the batch name to view the batch details: <ul style="list-style-type: none"> <li>• The date and time when the Mailbox Search and Remediate was initiated.</li> <li>• The source from which the Mailbox Search and Remediate was initiated.</li> <li>• The host who initiated the Mailbox Search and Remediate.</li> <li>• The remedial action taken on the messages.</li> <li>• The Cisco Ironport Message ID of the message.</li> <li>• A read receipt icon to show if the message was read by the recipient before the message was remediated successfully.</li> <li>• The remediation status of the message in the particular batch as Success, Failed, or In Progress.</li> <li>• The email address of the sender who sent the message.</li> <li>• The email addresses of the recipients for whom the message was delivered and later attempted for remediation.</li> <li>• The date and time when the message was sent to the recipient.</li> </ul> </li> </ul> |

## Message Filters Page

The Message Filters page shows information about the top message filter matches (which message filter had the most matching messages) in two forms: a bar chart and a tabular representation.

Using the bar chart, you can find the message filters that are being triggered the most by incoming and outgoing messages. The tabular representation shows the top message filters and the number of matches for the respective message filters. Click on the number to view a list of all the messages that are included in that number using Message Tracking.

You can select a time range on which to report, such as an hour, a week, or a custom range. As with all reports, you can export the data for the graphs or the details listing to CSV format via the **Export** link.

## High Volume Mail Page



**Note** The High Volume Mail page shows data only from message filters that use Header Repeats rule.

The High Volume Mail page contains the following reports in the form of bar charts:

- **Top Subjects.** You can use this chart to understand the top subjects of messages that AsyncOS received.
- **Top Envelope Senders.** You can use this chart to understand the top envelope senders of messages that AsyncOS received.

- **Top Message Filters by Number of Matches.** You can use this chart to understand the top message filter (that uses Header Repeats rule) matches.

The High Volume Mail page also provides a tabular representation of the top message filters and the number of matches for the respective message filters. Click the number to view a list of all the messages that are included in that number using Message Tracking.

You can select a time range on which to report, such as an hour, a week, or a custom range. As with all reports, you can export the data for the graphs or the details listing to CSV format via the **Export** link.

## Content Filters Page

The Content Filters page shows information about the top incoming and outgoing content filter matches (which content filter had the most matching messages) in two forms: a bar chart and a listing. Using the Content Filters page, you can review your corporate policies on a per-content filter or per-user basis and answer questions like:

- Which content filter is being triggered the most by incoming or outgoing mail?
- Who are the top users sending or receiving mail that is triggering a particular content filter?

You can click the name of the content filter in the listing to view more information about that filter on the Content Filter detail page.

### Related Topics

- [Content Filter Details, on page 880](#)

## Content Filter Details

Click the content filter name link to view the content filter details. The Content Filter detail page displays matches for that filter over time, as well as matches by internal user.

In the Matches by Internal Users section, you can click the name of a user to view that internal user's (email address) Internal User details page (see [#unique\\_1487](#)).

## Safe Print Page

You can use the Safe Print report page to view:

- Number of safe-printed attachments based on the file type in graphical format.
- Summary of safe-printed attachments based on the file type in tabular format.

In the 'Summary of Safe Print File Types' section, click the total number of safe-printed attachments to view the message details in Message Tracking.

## Advanced Phishing Protection Report Page

The **Reports > Mail Flow Summary > Advanced Phishing Protection** report page displays the following:

- Total number of messages successfully forwarded to the Cisco Advanced Phishing Protection cloud service.

- Total number of messages that are not forwarded to the Cisco Advanced Phishing Protection cloud service.



---

**Note** If the forwarding of message metadata has failed, you must validate the configurations of the Advanced Phishing Protection feature. For more information, see [How to Integrate Email Gateway with the Cisco Advanced Phishing Protection Cloud Service, on page 740](#)

---

You can use the Advanced Phishing Protection report page to view:

- Total number of messages that are sent from all appliances at the organizational level to the Cisco Advanced Phishing Protection cloud service in a dashboard.
- Total number of messages attempted to be forwarded to the Cisco Advanced Phishing Protection cloud service, in a graphical format.

To view the detailed information on the metadata of the message that is forwarded to the Cisco Advanced Phishing Protection cloud service, click on the link and login to the Cisco Advanced Phishing Protection cloud service. For more information, see [Monitoring Message Metadata on the Cisco Advanced Phishing Protection Cloud Service, on page 746](#).

## Reporting Overview

Reporting in AsyncOS involves three basic actions:

- You can create Scheduled Reports to be run on a daily, weekly, or monthly basis.
- You can generate a report immediately (“on-demand” report).
- You can view archived versions of previously run reports (both scheduled and on-demand).

Configure scheduled and on-demand reports via the Monitor > Scheduled Reports page. View archived reports via the Monitor > Archived Reports page.

Your appliance will retain the most recent reports it generates, up to 1000 total versions for all reports. You can define as many recipients for reports as you want, including zero recipients. If you do not specify an email recipient, the system will still archive the reports. If you need to send the reports to a large number of addresses, however, it may be easier to create a mailing list rather than listing the recipients individually.

By default, the appliance archives the twelve most recent reports of each scheduled report. Reports are stored in the /saved\_reports directory of the appliance. (See [FTP, SSH, and SCP Access, on page 1261](#) for more information.)

### Related Topics

- [Scheduled or Archived Report Types, on page 881](#)
- [Setting the Return Address for Reports, on page 883](#)

## Scheduled or Archived Report Types

You can choose from the following report types:

- AMP Reputation
- Advanced Malware Protection File Analysis
- Advanced Malware Protection File Retrospection
- Connections by Country
- Content Filters
- DLP Incident Summary
- DMARC Verification Report
- Delivery Status
- Executive Summary
- External Threat Feeds
- Forged Email Detection
- High Volume Mail
- Inbound SMTP Authentication
- Marco Detection
- Mail Flow Summary: Incoming
- Mailbox Auto Remediation
- Mail Flow Details (Outgoing senders: domain)
- Mail Flow Summary: Outgoing
- Message Filters
- My Email Reports
- Outgoing Destinations
- Rate Limits
- Sender Domain Reputation
- Sender Groups
- System Capacity
- TLS Encryption
- User Mail Summary
- URL Filtering
- Outbreak Filters
- Virus Filtering
- Web Interaction

Each of the reports consists of a summary of the corresponding Email Security Monitor page.

### Related Topics

- [Notes on Reports, on page 882](#)

## Notes on Reports

Content Filter reports in a PDF format are limited to a maximum of 40 content filters. You can obtain the full listing via reports in a CSV format.



---

**Note** To generate PDFs in Chinese, Japanese, or Korean on Windows computers, you must also download the applicable Font Pack from Adobe.com and install it on your local computer.

---



## Setting the Return Address for Reports

To set the return address for reports, see [Configuring the Return Address for Appliance Generated Messages](#), on page 1019. From the CLI, use the `addressconfig` command.

## Managing Reports

You can create, edit, delete, and view archived scheduled reports. You can also run a report immediately (on-demand report). Managing and viewing these reports is discussed below.



---

**Note** When in Cluster Mode, you are unable to view reports. You may view reports when in machine mode.

---

The Monitor > Scheduled Reports page shows a listing of the scheduled reports already created on the appliance.

### Related Topics

- [Scheduled Reports, on page 883](#)
- [Archived Reports, on page 885](#)

## Scheduled Reports

Scheduled reports can be scheduled to run on a daily, weekly, or monthly basis. You can select a time at which to run the report. Regardless of when you run a report, it will only include data for the time period that you specify, for example the past 3 days or the previous calendar month. Note that a daily report scheduled to run at 1AM will contain data for the previous day, midnight to midnight.

Your appliance ships with a default set of scheduled reports—you can use, modify, or delete any of them.

### Related Topics

- [Scheduling a Report to be Generated Automatically , on page 883](#)
- [Editing Scheduled Reports , on page 884](#)
- [Deleting Scheduled Reports, on page 884](#)

## Scheduling a Report to be Generated Automatically

### Procedure

---

- Step 1** On the Monitor > Scheduled Reports page, click **Add Scheduled Report**.
- Step 2** Select a report type. Depending on the report type you select, different options may be available. For more information about the available types of scheduled reports, see [Scheduled or Archived Report Types, on page 881](#).
- Step 3** Enter a descriptive title for the report. AsyncOS does not verify the uniqueness of report names. To avoid confusion, do not create multiple reports with the same name.
- Step 4** Select a time range for the report data. (This option is not available for Outbreak Filters reports.)

- Step 5** Select a format for the report:
- PDF. Create a formatted PDF document for delivery, archival, or both. You can view the report as a PDF file immediately by clicking Preview PDF Report.
- For information about generating PDFs in languages other than English, see the [Notes on Reports, on page 882](#).
- CSV. Create an ASCII text file that contains the tabular data as comma-separated values. Each CSV file may contain up to 100 rows. If a report contains more than one type of table, a separate CSV file is created for each table.
- Step 6** Specify the report options, if available. Some reports do not have report options.
- Step 7** Specify scheduling and delivery options. If you do not specify an email address, the report is archived but is not sent to any recipients.
- Note** If you are sending reports to an external account (such as Yahoo or Gmail, etc.), you may need to add the reporting return address to the external account's allowed list to prevent report emails from being incorrectly classified as spam.
- Step 8** Click **Submit**. Commit your changes.
- 

## Editing Scheduled Reports

### Procedure

---

- Step 1** Click the report title in the listing on the Services > Centralized Reporting page.
- Step 2** Make your changes.
- Step 3** Submit and commit your changes.
- 

## Deleting Scheduled Reports

### Procedure

---

- Step 1** On the Services > Centralized Reporting page, select the check boxes corresponding to the reports that you want to delete.
- Note** Select the All check box to remove all scheduled reports.
- Step 2** Click **Delete**.
- Step 3** Confirm the deletion and then commit your changes.
- Any archived versions of deleted reports are *not* automatically deleted.
-

## Archived Reports

The **Monitor > Archived Reports** page lists the available archived reports. You can view a report by clicking its name in the Report Title column. You can generate a report immediately by clicking **Generate Report Now**.

Use the Show menu to filter which type of reports is listed. Click the column headings to sort the listing.

Archived reports are deleted automatically — up to 30 instances of each scheduled report (up to 1000 reports) are kept and as new reports are added, older ones are deleted to keep the number at 1000. The 30 instances limit is applied to each individual scheduled report, not report type.

### Related Topics

- [Generating On-Demand Reports, on page 885](#)

## Generating On-Demand Reports

You can generate a report without scheduling it. These on-demand reports are still based on a specified time frame, but they are generated immediately.

### Procedure

---

- Step 1** Click **Generate Report Now** on the Archived Reports page.
- Step 2** Select a report type and edit the title if desired. AsyncOS does not verify the uniqueness of report names. To avoid confusion, do not create multiple reports with the same name.
- For more information about the available types of scheduled reports, see [Scheduled or Archived Report Types, on page 881](#).
- Step 3** Select a time range for the report data. (This option is not available for Virus Outbreak reports.)
- If you create a custom range, the range will appear as a link. To modify the range, click the link.
- Step 4** Select a format for the report.
- PDF. Create a formatted PDF document for delivery, archival, or both. You can view the report as a PDF file immediately by clicking Preview PDF Report.
- For information about generating PDFs in languages other than English, see the [Notes on Reports, on page 882](#).
- CSV. Create an ASCII text file that contains the tabular data as comma-separated values. Each CSV file may contain up to 100 rows. If a report contains more than one type of table, a separate CSV file is created for each table. Specify any report options.
- Step 5** Select whether to archive the report (if so, the report will shown on the Archived Reports page).
- Step 6** Specify whether to email the report and to which email addresses to send the report.
- Step 7** Click **Deliver this Report** to generate the report and deliver it to recipients or archive it.
- Step 8** Commit your changes.
-

# Troubleshooting Email Reports

- [Link to Message Tracking Gives Unexpected Results](#) , on page 886
- [File Analysis Details in the Cloud Are Incomplete](#), on page 886

## Link to Message Tracking Gives Unexpected Results

### Problem

Drilling down from a report to view details in message tracking yields unexpected results.

### Solution

This can occur if reporting and message tracking were not simultaneously enabled, functioning properly, and storing data locally (as opposed to being stored centrally on a Security Management appliance ). Data for each feature (reporting and message tracking) is stored only while that feature is enabled and functioning on that appliance , independently of whether the other feature (reporting or message tracking) is enabled and functioning. Therefore, reports may include data that is not available in Message Tracking and vice-versa.

## File Analysis Details in the Cloud Are Incomplete

### Problem

Complete file analysis results in the public cloud are not available for files uploaded from other appliances in my organization.

### Solution

Be sure to group all appliances that will share file analysis result data. See [\(Public Cloud File Analysis Services Only\) Configuring Appliance Groups](#) , on page 469. This configuration must be done on each appliance in the group.



# CHAPTER 34

## Tracking Messages

---

This chapter contains the following sections:

- [Message Tracking Overview](#) , on page 887
- [Enabling Message Tracking](#), on page 887
- [Searching for Messages on the Legacy Interface](#) , on page 888
- [Searching for Email Messages on the New Web Interface](#), on page 891
- [Working with Message Tracking Search Results](#) , on page 893
- [Checking Message Tracking Data Availability](#) , on page 896
- [Troubleshooting Message Tracking](#), on page 897

## Message Tracking Overview

Message tracking helps resolve help desk calls by giving a detailed view of message flow. For example, if a message was not delivered as expected, you can determine if it was found to contain a virus or placed in a spam quarantine — or if it is located somewhere else in the mail stream.

You can search for a particular email message or a group of messages that match criteria that you specify.



---

**Note** You cannot use message tracking to read the content of messages.

---

## Enabling Message Tracking



---

**Note** Message tracking data is preserved only for messages that are processed after you enable this feature.

---

### Before you Begin

- In order to search for and display attachment names in Message Tracking and view attachment names in log files, you must configure and enable at least one body scanning process, such as a message filter or content filter.

- To support searching by subject, log files must be configured to record subject headers. For more information, see [Logging, on page 1113](#).
- If you are setting up Centralized Tracking: Set up your Security Management appliance to support centralized message tracking for this appliance. See the Cisco Content Security Management appliance User Guide.

### Procedure

---

**Step 1** Click **Security Services > Message Tracking**.

Use this path even if you do not plan to centralize this service.

**Step 2** Select **Enable Message Tracking Service**.

**Step 3** If you are enabling message tracking for the first time after running the System Setup Wizard, review the end-user license agreement, and click **Accept**.

**Step 4** Choose a Message Tracking Service:

| Option               | Description                                                                                     |
|----------------------|-------------------------------------------------------------------------------------------------|
| Local Tracking       | Use message tracking on this appliance.                                                         |
| Centralized Tracking | Use Security Management appliance to track messages for multiple appliances including this one. |

**Step 5** (Optional) Select the check box to save information for rejected connections.

For best performance, leave this setting disabled.

**Step 6** Submit and commit your changes.

---

### What to do next

If you selected Local Tracking:

- Choose who can access content related to DLP violations. See [Controlling Access to Sensitive Information in Message Tracking, on page 953](#).
- (Optional) Adjust the disk space allocation for storing messages. See [Managing Disk Space, on page 1000](#).

## Searching for Messages on the Legacy Interface

### Procedure

---

**Step 1** Choose **Monitor > Message Tracking**

**Step 2** Enter search criteria.

- To view all options, click the **Advanced** link.
- Tracking does not support wildcard characters or regular expressions.
- Tracking searches are not case sensitive.
- Unless otherwise specified, the query is an “AND” search: The query returns messages that match *all* conditions specified in the search fields. For example, if you specify text strings for the envelope recipient and the subject line parameters, the query returns only messages that match *both* the specified envelope recipient *and* the subject line.
- Search criteria include:

| Option                                           | Description                                                                                                                                                                                                                                                                                            |
|--------------------------------------------------|--------------------------------------------------------------------------------------------------------------------------------------------------------------------------------------------------------------------------------------------------------------------------------------------------------|
| <b>Envelope Sender</b>                           | Select <b>Begins With</b> , <b>Is</b> , or <b>Contains</b> , then enter an email address, username, or domain of a message sender to find.<br><br>You can enter any character(s). No validation of your entry is performed.                                                                            |
| <b>Envelope Recipient</b>                        | Select <b>Begins With</b> , <b>Is</b> , or <b>Contains</b> , and enter an email address, username, or domain of a message recipient to find.<br><br>You can enter any character(s). No validation of your entry is performed.                                                                          |
| <b>Subject</b>                                   | Select <b>Begins With</b> , <b>Is</b> , or <b>Contains</b> , and enter a text string to search for in the message subject line.<br><br><b>Warning:</b> Do not use this type of search in environments where regulations prohibit such tracking.                                                        |
| <b>Message Received</b>                          | Specify a date and time range.<br><br>If you do not specify a date, the query returns data for all dates. If you specify a time range only, the query returns data for that time range across all available dates.<br><br>Use the local date and time that the message was received by the appliance . |
| <b>Advanced options:</b>                         |                                                                                                                                                                                                                                                                                                        |
| <b>Sender IP Address/ Domain / Network Owner</b> | Specify the IP address, domain, or network owner of a remote host.<br><br>You can search within rejected connections only or search all messages.                                                                                                                                                      |

| Option                    | Description                                                                                                                                                                                                                                                                                                                                                                                                                                                                                                                                                                                                                                                                                                                                                                                                                                                                                                                                                                                                                                                                                                                                                 |
|---------------------------|-------------------------------------------------------------------------------------------------------------------------------------------------------------------------------------------------------------------------------------------------------------------------------------------------------------------------------------------------------------------------------------------------------------------------------------------------------------------------------------------------------------------------------------------------------------------------------------------------------------------------------------------------------------------------------------------------------------------------------------------------------------------------------------------------------------------------------------------------------------------------------------------------------------------------------------------------------------------------------------------------------------------------------------------------------------------------------------------------------------------------------------------------------------|
| <b>Attachment</b>         | <p>Select <b>Begins With</b>, <b>Is</b>, or <b>Contains</b>, and enter an ASCII or Unicode text string for one attachment to find. Leading and trailing spaces are <i>not</i> stripped from the text you enter.</p> <p>You can search for messages by attachment filenames only if you have performed:</p> <ul style="list-style-type: none"> <li>• Body scan using a message filter</li> <li>• Body scan using a content filter</li> <li>• Advanced Malware Protection (AMP) scan.</li> </ul> <p>For more information about identifying files based on SHA-256 hash, see <a href="#">Identifying Files by SHA-256 Hash</a> , on page 478.</p> <p>You can search for messages that are detected as malicious by the Advanced Malware Protection engine based on the threat name. In the <b>Threat Name</b> field, enter <i>Simple_Custom_Detection</i> or <i>Custom_Threshold</i> to search for messages that are detected as malicious based on the Custom Detection and Custom Threshold categories. You can also search for messages by the virus name if a particular file is detected as virus positive by the Advanced Malware Protection engine.</p> |
| <b>Message Event</b>      | <p>Select one or more message processing events. For example, you can search for messages that have been delivered, quarantined, or hard bounced.</p> <p>Message events are added with an “OR” operator: Selecting multiple events finds messages that match <i>any</i> of the conditions you specify.</p>                                                                                                                                                                                                                                                                                                                                                                                                                                                                                                                                                                                                                                                                                                                                                                                                                                                  |
| <b>Message ID Header</b>  | <p>Enter a text string for the SMTP Message-ID header.</p> <p>This RFC 822 message header uniquely identifies each email message. It is inserted in the message when the message is first created.</p>                                                                                                                                                                                                                                                                                                                                                                                                                                                                                                                                                                                                                                                                                                                                                                                                                                                                                                                                                      |
| <b>Cisco IronPort MID</b> | <p>Enter a message number to search for. An IronPort MID uniquely identifies each email message on the appliance .</p>                                                                                                                                                                                                                                                                                                                                                                                                                                                                                                                                                                                                                                                                                                                                                                                                                                                                                                                                                                                                                                      |
| Cisco IronPort Host       | <p>Select an Email Security appliance to restrict the search to messages processed by that appliance , or select all appliances.</p>                                                                                                                                                                                                                                                                                                                                                                                                                                                                                                                                                                                                                                                                                                                                                                                                                                                                                                                                                                                                                        |

**Step 3** Click **Search** to submit the query.

The query results are displayed at the bottom of the page.

### What to do next

#### Related Topics

- [Working with Message Tracking Search Results](#) , on page 893



# Searching for Email Messages on the New Web Interface

The tracking service of the appliance lets you search for a particular email message or group of messages that match specified criteria, such as the message subject line, date and time range, envelope sender or recipient, or processing event (for example, whether the message was virus positive, spam positive, hard bounced, delivered, and so forth). Message tracking gives you a detailed view of message flow. You can also drill down on particular email messages to see message details, such as the processing events, attachment names, or the envelope and header information.



**Note** Although the tracking component provides detailed information about individual email messages, you cannot use it to read the content of messages.

## Procedure

**Step 1** Click **Tracking** tab.

**Step 2** Select **Messages** tab or **Rejected Connections** tab to narrow your search results.

**Note** You can search for rejected connections based on the sender IP address, domain or network owner.

**Step 3** (Optional) Click the **Advanced Search** to display additional search options.

**Step 4** Enter the following search criteria:

**Note** Tracking searches do not support wildcard characters or regular expressions. Tracking searches are not case sensitive.

- [For Messages and Rejected Connections] **Message Received:** Specify a date and time range for the query using “Last Day,” “Last 7 Days,” or “Custom Range.” Use the “Last Day” option to search for messages within the past 24 hours, and use the “Last 7 Days” option to search for messages within the past full seven days, plus the time that has passed on the current day.

If you do not specify a date, the query returns data for all dates. If you specify a time range only, the query returns data for that time range across all available dates. If you specify the current date and 23:59 as the end date and time, the query returns all data for the current date.

Dates and times are converted to GMT format when they are stored in the database. When you view dates and times on an appliance, they are displayed in the local time of the appliance.

Messages appear in the results only after they have been logged on the appliance and retrieved by the Security Management appliance. Depending on the size of logs and the frequency of polling, there could be a small gap between the time when an email message was sent and when it actually appears in tracking and reporting results.

- **Envelope Sender:** Select Begins With, Is, or Contains, and enter a text string to search for in the envelope sender. You can enter email addresses, user names, or domains. Use the following formats:
  - For email domains: *example.com*, *[203.0.113.15]*, *[ipv6:2001:db8:80:1::5]*
  - For full email addresses: *user@example.com*, *user@[203.0.113.15]* or *user@[ipv6:2001:db8:80:1::5]*.

- You can enter any character(s). No validation of your entry is performed.
- **Subject:** Select Begins With, Is, Contains, or Is Empty, and enter a text string to search for in the message subject line.
- **Envelope Recipient:** Select Begins With, Is, or Contains, and enter text to search for in the envelope recipient. You can enter email addresses, user names, or domains.

If you use the alias table for alias expansion on your appliances, the search finds the expanded recipient addresses rather than the original envelope addresses. In all other cases, message tracking queries find the original envelope recipient addresses.

Otherwise, valid search criteria for Envelope Recipient are the same as those for Envelope Sender.

You can enter any character(s). No validation of your entry is performed.

- **Attachment Name:** Select Begins With, Is, or Contains, and enter an ASCII or Unicode text string for one Attachment Name to find. Leading and trailing spaces are not stripped from the text you enter.
- **Reply-To:** Select Begins With, Is, or Contains, and enter a text string to search for messages based on the `Reply-To` header of the message.
- **File SHA256:** Enter a File SHA-256 value of the message.

For more information about identifying files based on SHA-256 hash, see [Identifying Files by SHA-256 Hash](#), on page 859.

- **Cisco Host:** Select All Host to search across all appliances or select the required appliance from the drop-down menu.
- **Message ID Header and Cisco MID:** Enter a text string for the message ID header, the Cisco IronPort message ID (MID), or both.
- [For Messages and Rejected Connections] **Sender IP Address/ Domain/ Network Owner:** Enter a sender IP address, domain or network owner details.
  - An IPv4 address must be 4 numbers separated by a period. Each number must be a value from 0 to 255. (Example: 203.0.113.15).
  - An IPv6 address consists of 8 sets of 16-bit hexadecimal values separated by colons.
 

You can use zero compression in one location, such as 2001:db8:80:1::5.
  - **Message Event:** Select the events to track. For example, you can search for messages that have been delivered, quarantined, or hard bounced. Message events are added with an “OR” operator: Selecting multiple events finds messages that match any of the conditions you specify.

You do not need to complete every field. Except for the Message Event options, the query is an “AND” search. The query returns messages that match the “AND” conditions specified in the search fields. For example, if you specify text strings for the envelope recipient and the subject line parameters, the query returns only messages that match both the specified envelope recipient and the subject line.

#### Step 5 Click **Search**.

Each row corresponds to an email message. Scroll down to load more messages in the view.

If necessary, you can refine your search by entering new search criteria, and run the query again. Alternatively, you can refine the search by narrowing the result set, as described in the following section.

---

### What to do next

- [Working with Message Tracking Search Results](#) , on page 893

## Working with Message Tracking Search Results

Keep the following points in mind:

- Messages appear in the results only after they have been logged on the appliance and retrieved by the Security Management appliance . Depending on the size of logs and the frequency of polling, there could be a small gap between the time when an email message was sent and when it actually appears in tracking and reporting results.
- For information about searches involving Advanced Malware Protection (file reputation scanning and file analysis), see [About Message Tracking and Advanced Malware Protection Features](#) , on page 479.

Actions you can take when working with search results:

- Show more than 250 search results by returning to the search criteria, clicking Advanced, scrolling to the Query Settings, and setting the maximum number of results to 1000.
- Show more results per page by choosing an option from the top right side of the search results section.
- Navigate through multiple pages of search results from the top right side of the search results section.
- Narrow your search results by floating the cursor over a value in the search results that you want to add as a condition. If an orange highlight appears, you can click that value to narrow the search by that criterion. This adds the additional criterion to the search criteria. For example, if you search for messages sent to a particular recipient, you can then click on a sender name in the search results to find all messages to that recipient from that sender within the time range (and meeting any other criteria) that you originally specified.
- If more than 1000 messages match your search criteria, you can click Export All (a link at the top right of the search results section) and export up to 50,000 search results as a comma-separated values file and work with the data in another application.
- View more details for a message by clicking Show Details in the row for that message. A new browser window opens with the message details.
- For quarantined messages, you can click a link in the message tracking search results to view details such as the reason the message was quarantined.
- Remediate the malicious messages from the user mailbox using the Mailbox Search and Remediate action. For more information, see [Search and Remediate Messages in the Mailboxes](#), on page 570



---

### Note

If you clicked a link in a report page to view message details in Message Tracking, and the set of results is not what you expected, this can occur if reporting and tracking were not both simultaneously and continuously enabled during the time period you are reviewing.

---

**Related Topics**

- [Message Tracking Details](#) , on page 894

## Message Tracking Details

| Item                                 | Description                                                                                                                                                                                                                                                                                                                                                                                       |
|--------------------------------------|---------------------------------------------------------------------------------------------------------------------------------------------------------------------------------------------------------------------------------------------------------------------------------------------------------------------------------------------------------------------------------------------------|
| Envelope and Header Summary section: |                                                                                                                                                                                                                                                                                                                                                                                                   |
| <b>Received Time</b>                 | Time that the appliance received the message.<br>Dates and times are displayed using the local time configured on the appliance .                                                                                                                                                                                                                                                                 |
| <b>MID</b>                           | Unique IronPort message ID.                                                                                                                                                                                                                                                                                                                                                                       |
| <b>Message Size</b>                  | Message size.                                                                                                                                                                                                                                                                                                                                                                                     |
| <b>Subject</b>                       | Subject line of the message.<br>The subject line in the tracking results may have the value “(No Subject)” if the message does not have a subject, or if log files are not configured to record subject headers. For more information, see <a href="#">Logging, on page 1113</a>                                                                                                                  |
| <b>Envelope Sender</b>               | Address of the sender in the SMTP envelope.                                                                                                                                                                                                                                                                                                                                                       |
| <b>Envelope Recipients</b>           | If your deployment uses the alias table for alias expansion, the search finds the expanded recipient addresses rather than the original envelope addresses. For more information about Alias Tables, see “Creating Alias Tables” in the “Configuring Routing and Delivery Features” chapter .<br><br>In all other cases, message tracking queries find the original envelope recipient addresses. |
| <b>Message ID Header</b>             | The RFC 822 message header.                                                                                                                                                                                                                                                                                                                                                                       |
| <b>SMTP Auth User ID</b>             | SMTP authenticated username of the sender, if the sender used SMTP authentication to send the message. Otherwise, the value is “N/A.”                                                                                                                                                                                                                                                             |

| Item                                                                                                                                                           | Description                                                                                                                                                                                                                                                                                                                                                                                                                                                                                                                                                                                                                                                                                                                                                                                                                                                                                                                                                                                                                                                                         |
|----------------------------------------------------------------------------------------------------------------------------------------------------------------|-------------------------------------------------------------------------------------------------------------------------------------------------------------------------------------------------------------------------------------------------------------------------------------------------------------------------------------------------------------------------------------------------------------------------------------------------------------------------------------------------------------------------------------------------------------------------------------------------------------------------------------------------------------------------------------------------------------------------------------------------------------------------------------------------------------------------------------------------------------------------------------------------------------------------------------------------------------------------------------------------------------------------------------------------------------------------------------|
| <b>Attachments</b>                                                                                                                                             | <p>The names of files attached to the message.</p> <p>Messages that contain at least one attachment with the queried name will appear in the search results.</p> <p>Some attachments may not be tracked. For performance reasons, scanning of attachment names occurs only as part of other scanning operations, for example message or content filtering, DLP, or disclaimer stamping. Attachment names are available only for messages that pass through body scanning while the attachment is still attached. Situations in which an attachment name will not appear in search results include (but are not limited to):</p> <ul style="list-style-type: none"> <li>• If the system only uses content filters, and a message is dropped or its attachment is stripped by anti-spam or anti-virus filters</li> <li>• If message splintering policies strip the attachment from some messages before body scanning occurs.</li> </ul> <p>For performance reasons, the names of files within attachments, such as OLE objects or archives such as .ZIP files, are not searched.</p> |
| [New Web Interface Only] <b>Message Event</b>                                                                                                                  | Select multiple events to include messages that match each event type.                                                                                                                                                                                                                                                                                                                                                                                                                                                                                                                                                                                                                                                                                                                                                                                                                                                                                                                                                                                                              |
| Sending Host Summary section                                                                                                                                   |                                                                                                                                                                                                                                                                                                                                                                                                                                                                                                                                                                                                                                                                                                                                                                                                                                                                                                                                                                                                                                                                                     |
| <b>Reverse DNS Hostname</b>                                                                                                                                    | Name of the sending host, as verified by reverse DNS (PTR) lookup.                                                                                                                                                                                                                                                                                                                                                                                                                                                                                                                                                                                                                                                                                                                                                                                                                                                                                                                                                                                                                  |
| <b>IP Address</b>                                                                                                                                              | IP address of the sending host.                                                                                                                                                                                                                                                                                                                                                                                                                                                                                                                                                                                                                                                                                                                                                                                                                                                                                                                                                                                                                                                     |
| <b>IP Reputation Score</b>                                                                                                                                     | <p>IP reputation score. The range is from 10 (likely a trustworthy sender) to -10 (apparent spammer). A score of “None” indicates that there was no information about this host at the time the message was processed.</p> <p>For more information about IP Reputation Service, see <a href="#">IP Reputation Filtering</a> , on page 85</p>                                                                                                                                                                                                                                                                                                                                                                                                                                                                                                                                                                                                                                                                                                                                        |
| Processing Details section                                                                                                                                     |                                                                                                                                                                                                                                                                                                                                                                                                                                                                                                                                                                                                                                                                                                                                                                                                                                                                                                                                                                                                                                                                                     |
| <p><b>Summary information</b></p> <p>(If one of the tabs below is displayed, this information is displayed in a tab. Summary information always displays.)</p> | <p>The Summary tab displays status events logged during the processing of the message.</p> <p>Entries include information about Mail Policy processing, such as Anti-Spam and Anti-Virus scanning, and other events such as message splitting and custom log entries added by a content or message filter.</p> <p>If the message was delivered, the details of the delivery are displayed here.</p> <p>The last recorded event is highlighted in the processing details.</p>                                                                                                                                                                                                                                                                                                                                                                                                                                                                                                                                                                                                        |

| Item                           | Description                                                                                                                                                                                                                                                                                                                                                                                                                                                                                                                                                                                                                                                                                                                                                    |
|--------------------------------|----------------------------------------------------------------------------------------------------------------------------------------------------------------------------------------------------------------------------------------------------------------------------------------------------------------------------------------------------------------------------------------------------------------------------------------------------------------------------------------------------------------------------------------------------------------------------------------------------------------------------------------------------------------------------------------------------------------------------------------------------------------|
| <b>DLP Matched Content tab</b> | <p>This tab displays only for messages that were caught by DLP policies.</p> <p>This tab includes information about the match, as well as the sensitive content that triggered the DLP policy match.</p> <p>You must configure the appliance to display this information. See <a href="#">Displaying Sensitive DLP Data in Message Tracking</a> , on page 511.</p> <p>To control access to this tab, see <a href="#">Controlling Access to Sensitive Information in Message Tracking</a>, on page 953.</p>                                                                                                                                                                                                                                                     |
| <b>URL Details tab</b>         | <p>This tab displays only for messages caught by URL Reputation and URL Category content filters and by outbreak filters.</p> <p>This tab displays the following information:</p> <ul style="list-style-type: none"> <li>• The reputation score or category associated with the URL</li> <li>• The action performed on the URL (rewrite, defang, or redirect)</li> <li>• If a message contains multiple URLs, which URL has triggered the filter action.</li> </ul> <p>You must configure the appliance to display this information. See <a href="#">Displaying URL Details in Message Tracking</a> , on page 439.</p> <p>To control access to this tab, see <a href="#">Controlling Access to Sensitive Information in Message Tracking</a>, on page 953.</p> |

#### Related Topics

- [Searching for Messages on the Legacy Interface](#) , on page 888

## Checking Message Tracking Data Availability

You can determine the date range that your message tracking data includes, as well as identify any missing intervals in that data.

#### Procedure

- 
- Step 1** [New Web Interface Only] Click the gear icon on the upper right corner of the page to load the legacy web interface.
- Step 2** Select **Monitor > Message Tracking**.
- Step 3** Look for **Data in time range:** in the upper right corner of the Search box.
- Step 4** Click the value shown for **Data in time range:**.
- 

#### What to do next

#### Related Topics

- [About Message Tracking and Upgrades](#) , on page 897

## About Message Tracking and Upgrades

New message tracking features may not apply to messages that were processed before upgrade, because the required data may not have been retained for those messages. For possible limitations related to message tracking data and upgrades, see the Release Notes for your release.

## Troubleshooting Message Tracking

### Related Topics

- [Attachments Do Not Appear in Search Results](#) , on page 897
- [Expected Messages Are Missing from Search Results](#) , on page 897

## Attachments Do Not Appear in Search Results

### Problem

Attachment names are not found and displayed in search results.

### Solution

See configuration requirements at [Enabling Message Tracking, on page 887](#) . Also see limitations for attachment name searches in [Message Tracking Details](#) , on page 894.

## Expected Messages Are Missing from Search Results

### Problem

Search results did not include messages that should have met the criteria.

### Solution

- Results for many searches, and especially searches that involve Message Events, depend on your appliance configuration. For example, if you search for a URL Category for which you have not filtered, no results will be found, even if a message contains a URL in that category. Verify that you have configured the appliance properly to achieve the behavior that you expected. For example, check your mail policies, content and message filters, and quarantine settings.
- If expected information is missing after you clicked a link in a report, see [Troubleshooting Email Reports, on page 886](#).







## CHAPTER 35

# Policy, Virus, and Outbreak Quarantines

---

This chapter contains the following sections:

- [Overview of Policy, Virus, and Outbreak Quarantines, on page 899](#)
- [Managing Policy, Virus, and Outbreak Quarantines, on page 901](#)
- [Working with Messages in Policy, Virus, or Outbreak Quarantines, on page 909](#)

## Overview of Policy, Virus, and Outbreak Quarantines

“Policy, virus and outbreak quarantines” includes all non-spam quarantines, including the File Analysis quarantine.

When an appliance detects possible malware or content that is not allowed by your organization in incoming or outgoing messages, it can send those messages to a quarantine instead of deleting them immediately. A quarantine holds these messages safely on the appliance or on a Cisco Content Security Management appliance for a period of time, to allow a human being to review them, or to await an update that will better evaluate the safety of the message.

Examples of how non-spam quarantines can be used in your organization:

- **Policy enforcement.** Let Human Resources personnel or the Legal department review messages that may contain offensive, confidential, or otherwise disallowed information.
- **Virus quarantine.** Store messages that are marked as infected, encrypted, or not scannable by the anti-virus scanning engine to prevent the spread of viruses to your users.
- **Outbreak prevention.** Hold messages that are flagged by the Outbreak Filters as possibly being part of a viral outbreak or small-scale malware attack until an anti-virus or anti-spam update is released.
- **File Analysis quarantine.** Store messages that have attachments that may contain malware, and that have been sent for analysis, until a verdict is reached.

### Related Topic

- [Spam Quarantine, on page 919](#)

## Quarantine Types

| Quarantine Type             | Quarantine Name                      | Created by the System by Default? | Description                                                                                                                                                                                                  | More Information                                                                                                                                                                                                |
|-----------------------------|--------------------------------------|-----------------------------------|--------------------------------------------------------------------------------------------------------------------------------------------------------------------------------------------------------------|-----------------------------------------------------------------------------------------------------------------------------------------------------------------------------------------------------------------|
| Advanced Malware Protection | File Analysis                        | Yes                               | Holds messages that are sent for file analysis, until a verdict is returned.                                                                                                                                 | <ul style="list-style-type: none"> <li>• <a href="#">Managing Policy, Virus, and Outbreak Quarantines</a></li> <li>• <a href="#">Working with Messages in Policy, Virus, or Outbreak Quarantines</a></li> </ul> |
| Virus                       | Virus                                | Yes                               | Holds messages that may be transmitting malware, as determined by the anti-virus engine.                                                                                                                     |                                                                                                                                                                                                                 |
| Outbreak                    | Outbreak                             | Yes                               | Holds messages caught by Outbreak Filters as potentially being spam or malware.                                                                                                                              |                                                                                                                                                                                                                 |
| Policy                      | Policy                               | Yes                               | Holds messages caught by message filters, content filters, and DLP message actions.<br><br>A default Policy quarantine has been created for you.                                                             |                                                                                                                                                                                                                 |
|                             | Unclassified                         | Yes                               | Holds messages only if a quarantine that is specified in a message filter, content filter, or DLP message action has been deleted.<br><br>You cannot assign this quarantine to any filter or message action. |                                                                                                                                                                                                                 |
|                             | (Policy quarantines that you create) | No                                | Policy quarantines that you create for use in message filters, content filters, and DLP message actions.                                                                                                     |                                                                                                                                                                                                                 |

| Quarantine Type | Quarantine Name | Created by the System by Default? | Description                                                                                                                                                                                                                                                      | More Information                             |
|-----------------|-----------------|-----------------------------------|------------------------------------------------------------------------------------------------------------------------------------------------------------------------------------------------------------------------------------------------------------------|----------------------------------------------|
| Spam            | Spam            | Yes                               | <p>Holds spam or suspected spam messages for the message's recipient or an administrator to review.</p> <p>The spam quarantine is not included in the group of policy, virus, and outbreak quarantines and is managed separately from all other quarantines.</p> | <a href="#">Spam Quarantine, on page 919</a> |

## Managing Policy, Virus, and Outbreak Quarantines

- [Disk Space Allocation for Policy, Virus, and Outbreak Quarantines , on page 901](#)
- [Retention Time for Messages in Quarantines , on page 902](#)
- [Default Actions for Automatically Processed Quarantined Messages , on page 903](#)
- [Checking the Settings of System-Created Quarantines , on page 903](#)
- [Configuring Policy, Virus, and Outbreak Quarantines , on page 903](#)
- [About Editing Policy, Virus, and Outbreak Quarantine Settings , on page 905](#)
- [Determining the Filters and Message Actions to Which a Policy Quarantine Is Assigned , on page 905](#)
- [About Deleting Policy Quarantines , on page 906](#)
- [Monitoring Quarantine Status, Capacity, and Activity , on page 906](#)
- [Policy Quarantine Performance , on page 907](#)
- [Alerts About Quarantine Disk-Space Usage , on page 908](#)
- [Policy Quarantines and Logging, on page 908](#)
- [About Distributing Message Processing Tasks to Other Users , on page 908](#)
- [About Policy, Virus, and Outbreak Quarantines in Cluster Configurations , on page 909](#)
- [About Centralized Policy, Virus, and Outbreak Quarantines , on page 909](#)

## Disk Space Allocation for Policy, Virus, and Outbreak Quarantines

For disk space information for policy, virus, and outbreak quarantines, see [Managing Disk Space , on page 1000](#).

Policy, virus, and outbreak quarantines consume some disk space on the appliance even if the quarantines are centralized.

Messages in multiple quarantines consume the same amount of disk space as a message in a single quarantine.

If Outbreak Filters and Centralized Quarantines are both enabled:

- All disk space on the appliance that would have been allocated to local policy, virus, and outbreak quarantines is used instead to hold copies of messages in the Outbreak quarantine, in order to scan those messages each time outbreak rules are updated.
- The disk space on the Security Management appliance for messages in the Outbreak quarantine from a particular managed

### Related Topics

- [Monitoring Quarantine Status, Capacity, and Activity](#) , on page 906
- [Alerts About Quarantine Disk-Space Usage](#) , on page 908
- [Retention Time for Messages in Quarantines](#) , on page 902

## Retention Time for Messages in Quarantines

Messages are automatically removed from the quarantine under the following circumstances:

- Normal Expiration—the configured retention time is met for a message in the quarantine. You specify a retention time for messages in each quarantine. Each message has its own specific expiration time, displayed in the quarantine listing. Messages are stored for the amount of time specified unless another circumstance described in this topic occurs.



---

**Note** The normal retention time for messages in the Outbreak Filters quarantine is configured in the Outbreak Filters section of each mail policy, not in the outbreak quarantine.

---

- Early Expiration—messages are forced from quarantines before the configured retention time is reached. This can happen when:

- The size limit for all quarantines, as defined in [Disk Space Allocation for Policy, Virus, and Outbreak Quarantines](#) , on page 901, is reached.

If the size limit is reached, the oldest messages, regardless of quarantine, are processed and the default action is performed for each message, until the size of all quarantines is again less than the size limit. The policy is First In First Out (FIFO). Messages in multiple quarantines will be expired based on their latest expiration time.

(Optional) You can configure individual quarantines to be exempt from release or deletion because of insufficient disk space. If you configure all quarantines to be exempt and the disk space reaches capacity, messages in the quarantine will be delivered to make room for new messages.

You will receive alerts at disk-space milestones. See [Alerts About Quarantine Disk-Space Usage](#) , on page 908.

- You delete a quarantine that still holds messages.

When a message is automatically removed from a quarantine, the default action is performed on that message. See [Default Actions for Automatically Processed Quarantined Messages](#) , on page 903.



**Note** In addition to the above scenarios, messages can be automatically removed from quarantine based on the result of scanning operations (outbreak filters or file analysis.)

#### Effects of Time Adjustments on Retention Time

- Daylight savings time and appliance time zone changes do not affect the retention period.
- If you change the retention time of a quarantine, only new messages will have the new expiration time.
- If the system clock is changed, messages that should have expired in the past will expire at the next most appropriate time.
- System clock changes do not apply to messages that are in the process of being expired.

## Default Actions for Automatically Processed Quarantined Messages

The default action is performed on messages in a policy, virus, or outbreak quarantine when any situation described in [Retention Time for Messages in Quarantines](#) , on page 902, occurs.

There are two primary default actions:

- Delete—The message is deleted.
- Release—The message is released for delivery.

Upon release, messages may be rescanned for threats. For more information, see [About Rescanning of Quarantined Messages](#) , on page 915.

In addition, messages released before their expected retention time has passed can have additional operations performed on them, such as adding an X-Header. For more information, see [Configuring Policy, Virus, and Outbreak Quarantines](#) , on page 903.

## Checking the Settings of System-Created Quarantines

Before you use quarantines, customize the settings of the default quarantines, including the Unclassified quarantine.

#### Related Topics

- [Configuring Policy, Virus, and Outbreak Quarantines](#) , on page 903

## Configuring Policy, Virus, and Outbreak Quarantines

#### Before you begin

- If you are editing an existing quarantine, see [About Editing Policy, Virus, and Outbreak Quarantine Settings](#) , on page 905.
- Understand how messages in quarantines are automatically managed, including retention times and default actions. See [Retention Time for Messages in Quarantines](#) , on page 902, and [Default Actions for Automatically Processed Quarantined Messages](#) , on page 903.

- Determine which users you want to have access to each quarantine, and create users and custom user roles accordingly. For details, see [Which User Groups Can Access Policy, Virus, and Outbreak Quarantines](#), on page 908.

## Procedure

**Step 1** You can configure Policy, Virus, and Outbreak Quarantines in any one of the following ways:

- [ New Web Interface Only] Choose **Quarantine > Other Quarantine > View > +**.
- Choose **Monitor > Policy, Virus, and Outbreak Quarantines** and do one of the following.
  - Click **Add Policy Quarantine**.
  - Click a quarantine to edit.

**Step 2** Enter the following information:

Keep the following in mind:

- Changing the retention time of the File Analysis quarantine from the default of one hour is not recommended.
- If you do *not* want messages in this quarantine to be processed before the end of the Retention Period you specify, even when quarantine disk space is full, deselect **Free up space by applying default action on messages upon space overflow**.

Do not select this option for all quarantines. The system must be able to make space by deleting messages from at least one quarantine.

- If you select **Release** as the default action, you can specify additional actions to apply to messages that are released before their retention period has passed:

| Option            | Information                                                                                                                                                                                                                                                                                                                                                         |
|-------------------|---------------------------------------------------------------------------------------------------------------------------------------------------------------------------------------------------------------------------------------------------------------------------------------------------------------------------------------------------------------------|
| Modify Subject    | Type the text to add and specify whether to add it to the beginning or the end of the original message subject.<br><br>For example, you might want to warn the recipient that the message may contain inappropriate content.<br><br><b>Note</b> In order for a subject with non-ASCII characters to display correctly it must be represented according to RFC 2047. |
| Add X-Header      | An X-Header can provide a record of actions taken on a message. This can be helpful for example when handling inquiries about why a particular message was delivered.<br><br>Enter a name and value.<br><br>Example:<br>Name = Inappropriate-release-early<br>Value = True                                                                                          |
| Strip Attachments | Stripping attachments protects against viruses that may be in such files.                                                                                                                                                                                                                                                                                           |

**Step 3** Specify the users who can access this quarantine:

| User                           | Information                                                                                                                                                                                            |
|--------------------------------|--------------------------------------------------------------------------------------------------------------------------------------------------------------------------------------------------------|
| Local Users                    | The list of local users includes only users with roles that can access quarantines. The list excludes users with Administrator privileges, because all Administrators have full access to quarantines. |
| Externally Authenticated Users | You must have configured external authentication.                                                                                                                                                      |
| Custom User Roles              | You see this option only if you have created at least one custom user role with quarantine access.                                                                                                     |

**Step 4** Submit and commit your changes.

#### What to do next

Create message and content filters and DLP message actions that will move messages to the quarantine.

## About Editing Policy, Virus, and Outbreak Quarantine Settings



#### Note

- You cannot rename a quarantine.
- See also [Retention Time for Messages in Quarantines](#) , on page 902.

To change quarantine settings, choose **Monitor > Policy, Virus, and Outbreak Quarantines** , and then click the name of a quarantine.

To change quarantine settings on the new web interface, navigate to **Quarantine > Other Quarantine > View** and click  on the required quarantine or

## Determining the Filters and Message Actions to Which a Policy Quarantine Is Assigned

You can view the message filters, content filters, Data Loss Prevention (DLP) message actions, and DMARC verification profiles that are associated with a policy quarantine.

#### Procedure



- Step 1** [New Web Interface Only] On the appliance , click **Quarantine > Other Quarantine > View**.
- Step 2** [New Web Interface Only] Select the required quarantine and click on the  button.
- Step 3** Choose **Monitor > Policy, Virus, and Outbreak Quarantines**.

- Step 4** Click the name of the policy quarantine to check.
- Step 5** Scroll to the bottom of the page and view the **Associated Message Filters/Content Filters/DLP Message Actions**.



## About Deleting Policy Quarantines

- Before you delete a policy quarantine, see if it is associated with any active filters or message actions. See [Determining the Filters and Message Actions to Which a Policy Quarantine Is Assigned](#), on page 905.
- You can delete a policy quarantine even if it is assigned to a filter or message action.
- If you delete a quarantine that is not empty, the default action defined in the quarantine will be applied to all messages, even if you have selected the option not to delete messages if the disk is full. See [Default Actions for Automatically Processed Quarantined Messages](#), on page 903.
- After you delete the quarantine associated with a filter or message action, any messages subsequently quarantined by that filter or message action will be sent to the Unclassified quarantine. You should customize the default settings of the Unclassified quarantine before you delete quarantines.
- You cannot delete the Unclassified quarantine.

## Monitoring Quarantine Status, Capacity, and Activity

| To View                                                 | Do This                                                                                                                                                                                                                                                                                                                                                                     |
|---------------------------------------------------------|-----------------------------------------------------------------------------------------------------------------------------------------------------------------------------------------------------------------------------------------------------------------------------------------------------------------------------------------------------------------------------|
| Total space allocated for all non-spam quarantines      | [New Web Interface Only] On the appliance, click  to load the legacy web interface.<br>Choose <b>Monitor &gt; Policy, Virus, and Outbreak Quarantines</b> and look in the first section on the page.<br>To change allocations, see <a href="#">Managing Disk Space</a> , on page 1000. |
| Currently available space for all non-spam quarantines  | [New Web Interface Only] Choose <b>Quarantine &gt; Other Quarantine</b> .<br>Choose <b>Monitor &gt; Policy, Virus, and Outbreak Quarantines</b> and look just below the table.                                                                                                                                                                                              |
| Total amount of space currently used by all quarantines | [New Web Interface Only] On the appliance, click  to load the legacy web interface.<br>Choose <b>Monitor &gt; System Status</b> and look for <b>Queue Space Used by Quarantine</b> .                                                                                                   |
| Amount of space currently used by each quarantine       | [New Web Interface Only] Choose <b>Quarantines Quarantine &gt; Other Quarantine &gt; View</b> .<br>Choose <b>Monitor &gt; Policy, Virus, and Outbreak Quarantines</b> , click the quarantine name, and look for this information in the table row directly below the quarantine name.                                                                                       |



| To View                                                                                                  | Do This                                                                                                                                                                                                                                                                                                                                                                                                                                                    |
|----------------------------------------------------------------------------------------------------------|------------------------------------------------------------------------------------------------------------------------------------------------------------------------------------------------------------------------------------------------------------------------------------------------------------------------------------------------------------------------------------------------------------------------------------------------------------|
| Total number of messages currently in all quarantines                                                    | [New Web Interface Only] On the appliance , click  to load the legacy web interface.<br><br>Choose <b>Monitor &gt; System Status</b> and look for <b>Active Messages in Quarantine</b> .                                                                                                                                                                                |
| Number of messages currently in each quarantine                                                          | [New Web Interface Only] Choose <b>Quarantines Quarantine &gt; Other Quarantine &gt; View</b> .<br><br>Choose <b>Monitor &gt; Policy, Virus, and Outbreak Quarantines</b> and look at the table row for the quarantine.                                                                                                                                                                                                                                    |
| Total CPU usage by all quarantines                                                                       | [New Web Interface Only] On the appliance , click  to load the legacy web interface.<br><br>Choose <b>Monitor &gt; System Status</b> and look in the <b>CPU Utilization</b> section.                                                                                                                                                                                    |
| Date and time when the last message entered each quarantine (excluding moves between policy quarantines) | [New Web Interface Only] Choose <b>Quarantines &gt; Other Quarantine &gt; View</b> .<br><br>Choose <b>Monitor &gt; Policy, Virus, and Outbreak Quarantines</b> and look at the table row for the quarantine.                                                                                                                                                                                                                                               |
| Date a policy quarantine was created                                                                     | [New Web Interface Only] On the appliance , click  to load the legacy web interface.<br><br>Choose <b>Monitor &gt; Policy, Virus, and Outbreak Quarantines</b> , click the quarantine name, and look for this information in the table row directly below the quarantine name.<br><br>Creation date and creator name are not available for system-created quarantines. |
| Name of policy quarantine creator                                                                        |                                                                                                                                                                                                                                                                                                                                                                                                                                                            |
| Filters and message actions associated with a policy quarantine                                          | See <a href="#">Determining the Filters and Message Actions to Which a Policy Quarantine Is Assigned</a> , on page 905.                                                                                                                                                                                                                                                                                                                                    |

## Policy Quarantine Performance

Messages stored in policy quarantines use system memory in addition to hard-drive space. Storing hundreds of thousands of messages in policy quarantines on a single appliance may cause a decrease in the appliance's performance due to excessive memory usage. The appliance takes more time to quarantine, delete, and release messages, which causes message processing to slow down and the email pipeline to back up.

Cisco recommends storing an average of less than 20,000 messages in your policy quarantines to ensure that the appliance processes email at a normal rate.

To check the number of messages in quarantines, see [Monitoring Quarantine Status, Capacity, and Activity](#) , on page 906.

## Alerts About Quarantine Disk-Space Usage

An alert is sent whenever the total size of the policy, virus, and outbreak quarantine reaches or passes 75 percent, 85 percent, and 95 percent of its capacity. The check is performed when a message is placed in the quarantine. For example, if adding a message to a quarantine increases the size to or past 75 percent of the total capacity, an alert is sent.

## Policy Quarantines and Logging

AsyncOS individually logs all messages that are quarantined:

Info: MID 482 quarantined to "Policy" (message filter:policy\_violation)

The message filter or Outbreak Filters feature rule that caused the message to be quarantined is placed in parentheses. A separate log entry is generated for each quarantine in which the message is placed.

AsyncOS also individually logs messages that are removed from quarantine:

Info: MID 483 released from quarantine "Policy" (queue full)

Info: MID 484 deleted from quarantine "Anti-Virus" (expired)

The system individually logs messages after they are removed from all quarantines and either permanently deleted or scheduled for delivery, for example

Info: MID 483 released from all quarantines

Info: MID 484 deleted from all quarantines

When a message is re-injected, the system creates a new Message object with a new Message ID (MID). This is logged using an existing log message with a new MID “byline”, for example:

Info: MID 483 rewritten to 513 by Policy Quarantine

## About Distributing Message Processing Tasks to Other Users

You can distribute message review and processing tasks to other administrative users. For example:

- The Human Resources team can review and manage the Policy Quarantine.
- The Legal team can manage the Confidential Material Quarantine.

You assign access privileges to these users when you specify settings for a quarantine. In order to add users to quarantines, the users must already exist.

Each user may have access to all, some, or none of the quarantines. A user who is not authorized to view a quarantine will not see any indication of its existence anywhere in the GUI or CLI listings of quarantines.

### Related Topics

- [Which User Groups Can Access Policy, Virus, and Outbreak Quarantines](#), on page 908
- [Distributing Administrative Tasks](#), on page 949

## Which User Groups Can Access Policy, Virus, and Outbreak Quarantines

When you allow administrative users to access a quarantine, the actions that they can perform depend on their user group:

- Users in the Administrators groups can create, configure, delete, and centralize quarantines and can manage quarantined messages.
- Users in the Operators, Guests, Read-Only Operators, and Help Desk Users groups, as well as custom user roles with quarantine management privileges, can search for, view, and process messages in a quarantine, but cannot change the quarantine's settings, create, delete, or centralize quarantines. You specify in each quarantine which of these users have access to that quarantine.
- Users in the Technicians group cannot access quarantines.

Access privileges for related features, such as Message Tracking and Data Loss Prevention, also affect the options and information that an administrative user sees on Quarantine pages. For example, if a user does not have access to Message Tracking, that user will not see message tracking links and information for quarantined messages.

End users do not have see or have access to policy, virus, and outbreak quarantines.

## About Policy, Virus, and Outbreak Quarantines in Cluster Configurations

Policy, virus, and outbreak quarantines are configurable only at machine level in deployments with centralized management.

## About Centralized Policy, Virus, and Outbreak Quarantines

You can centralize policy, virus, and outbreak quarantines on a Cisco Content Security Management appliance . For more information, see [Centralized Policy, Virus, and Outbreak Quarantines](#) , on page 1253.

# Working with Messages in Policy, Virus, or Outbreak Quarantines

### Related Topics

- [Viewing Messages in Quarantines](#) , on page 910
- [Finding Messages in Policy, Virus, and Outbreak Quarantines](#) , on page 910
- [Manually Processing Messages in a Quarantine](#), on page 911
- [Messages in Multiple Quarantines](#) , on page 913
- [Message Details and Viewing Message Content](#), on page 913
- [About Rescanning of Quarantined Messages](#) , on page 915
- [The Outbreak Quarantine](#), on page 916

## Viewing Messages in Quarantines

| To                                                         | Do This                                                                                                                                                                                                                                                                                                                               |
|------------------------------------------------------------|---------------------------------------------------------------------------------------------------------------------------------------------------------------------------------------------------------------------------------------------------------------------------------------------------------------------------------------|
| View all messages in a quarantine                          | [New Web Interface Only] Choose <b>Quarantine &gt; Other Quarantine &gt; View</b> .<br>Choose <b>Monitor &gt; Policy, Virus, and Outbreak Quarantines</b> .<br>In the row for the relevant quarantine, click the blue number in the <b>Messages</b> column of the table.                                                              |
| View messages in the Outbreak quarantine                   | [New Web Interface] Choose <b>Quarantine &gt; Other Quarantine &gt; View</b> .<br>Choose <b>Monitor &gt; Policy, Virus, and Outbreak Quarantines</b> .<br>In the row for the relevant quarantine, click the blue number in the <b>Messages</b> column of the table.<br>See <a href="#">Manage by Rule Summary Link, on page 917</a> . |
| Navigate through the list of messages in a quarantine      | Click Previous, Next, a page number, or double-arrow link. The double arrows take you to the first (<<) or last (>>) page in the listing.                                                                                                                                                                                             |
| Sort the list of messages in a quarantine                  | Click a column heading (except columns that could include multiple items or the “In other quarantines” column).                                                                                                                                                                                                                       |
| Resize table columns                                       | Drag the divider between column headings.                                                                                                                                                                                                                                                                                             |
| View the content that caused the message to be quarantined | See <a href="#">Viewing Matched Content</a> , on page 914.                                                                                                                                                                                                                                                                            |

### Related Topics

- [Quarantined Messages and International Character Sets, on page 910](#)

## Quarantined Messages and International Character Sets

For messages with subjects that contain characters from international character sets (double-byte, variable length, and non-ASCII encoded), the Policy Quarantine pages display subject lines in non-ASCII characters in their decoded form.

## Finding Messages in Policy, Virus, and Outbreak Quarantines



### Note

- Users can find and see only the messages in quarantines to which they have access.
- Searches in Policy, Virus, and Outbreak quarantines do not find messages in the spam quarantine.

## Procedure

---

- Step 1** [New Web Interface Only] Click the blue number link of the corresponding quarantine.
- Tip** [New Web Interface Only] For the Outbreak Quarantine, you can also find all messages quarantined by each outbreak rule: Click the **Rule Summary** tab in the Outbreak quarantine, and then click the relevant rule.
- Step 2** [New Web Interface Only] Choose **Quarantine > Other Quarantine > Search**.
- Step 3** [New Web Interface Only] Click the blue number link of the corresponding quarantine.
- Tip** [New Web Interface Only] For the Outbreak Quarantine, you can also find all messages quarantined by each outbreak rule: Click the **Rule Summary** tab in the Outbreak quarantine, and then click the relevant rule.
- Step 4** Choose **Monitor > Policy, Virus, and Outbreak Quarantines**.
- Step 5** Click the **Search Across Quarantines** button.
- Tip** For the Outbreak Quarantine, you can also find all messages quarantined by each outbreak rule: Click the **Manage by Rule Summary** link in the Outbreak table row, and then click the relevant rule.
- Step 6** (Optional) Enter other search criteria.
- For Envelope Sender and Envelope Recipient: You can enter any character(s). No validation of your entry is performed.
  - Search results include only messages that match *all* of the criteria you specify. For example, if you specify an Envelope Recipient and a Subject, only messages that match the terms specified in both the Envelope Recipient *and* the Subject are returned.
- 

## What to do next

You can use the search results in the same way that you use the quarantine listings. For more information, see [Manually Processing Messages in a Quarantine, on page 911](#).

# Manually Processing Messages in a Quarantine

Manually processing messages means to manually select a Message Action for the message from the Message Actions page.

You can perform the following actions on messages:

- Delete
- Release
- Delay Scheduled Exit from quarantine
- Send a Copy of messages to email addresses that you specify

- Move a message from one quarantine to another

Generally, you can perform actions on messages in the lists that are displayed when you do the following. However, not all actions are available in all situations.

- From the list of quarantines on the **Monitor > Policy, Virus, and Outbreak Quarantines** or [New Web Interface Only] **Quarantine > Other Quarantine > View** page, click the number of messages in a quarantine.
- Click **Search Across Quarantines**.
- Click a quarantine name and search within a quarantine.

You can perform these actions on multiple messages at one time by:

- Choosing an option from the pick list at the top of the list of messages.
- Selecting the check box beside each message listed on a page.
- Selecting the check box in the table heading at the top of a list of messages. This applies the action to all messages visible on the screen. Messages on other pages are not affected.

Additional options are available for messages in the outbreak quarantine. See

#### Related Topics

- [Sending a Copy of the Message, on page 912](#)
- [About Moving Messages Between Policy Quarantines , on page 912](#)
- [Messages in Multiple Quarantines , on page 913](#)
- [Default Actions for Automatically Processed Quarantined Messages , on page 903](#)

## Sending a Copy of the Message

Only users who belong to the Administrators group may send copies of a message.

To send a copy of the message, enter an email address in the Send Copy To: field and click **Submit**. Sending a copy of a message does not cause any other action to be performed on the message.

## About Moving Messages Between Policy Quarantines

You can manually move messages from one policy quarantine to another on a single appliance .

When you move a message to a different quarantine:

- The expiration time is unchanged. The message keeps the retention time of the original quarantine.
- The reason the message was quarantined, including the matched content and other relevant details, does not change.
- If a message is in multiple quarantines and you move the message to a destination that already holds a copy of that message, the expiration time and reason for quarantine of the moved copy of the message overwrite those of the copy of the message that was originally in the destination quarantine.

## Messages in Multiple Quarantines

If a message is present in one or more other quarantines, the “In other quarantines” column in the quarantine message list will show “Yes,” regardless of whether you have permissions to access those other quarantines.

A message in multiple quarantines:

- Is not delivered unless it has been released from all of the quarantines in which it resides. If it is deleted from any quarantine, it will never be delivered.
- Is not deleted from any quarantine until it has been deleted or released from all quarantines in which it resides.

Because a user wanting to release a message may not have access to all of the quarantines in which it resides, the following rules apply:

- A message is not released from any quarantine until it has been released from all of the quarantines in which it resides.
- If a message is marked as Deleted in any quarantine, it cannot be delivered from any other quarantine in which it resides. (It can still be released.)

If a message is queued in multiple quarantines and a user does not have access to one or more of the other quarantines:

- The user will be informed whether the message is present in each of the quarantines to which the user has access.
- The GUI shows only the scheduled exit time from the quarantines to which the user has access. (For a given message, there is a separate exit time for each quarantine.)
- The user will not be told the names of the other quarantine(s) holding the message.
- The user will not see matched content that caused the message to be placed into quarantines that the user does not have access to.
- Releasing a message affects only the queues to which the user has access.
- If the message is also queued in other quarantines not accessible to the user, the message will remain in quarantine, unchanged, until acted upon by users who have the required access to the remaining quarantines (or until the message is released “normally” via early or normal expiration).

## Message Details and Viewing Message Content

Click on the subject line of a message to view that message’s content and to access the Quarantined Message page.

The Quarantined Message page has two sections: Quarantine Details and Message Details.

From the Quarantined Message page, you can read the message, select a Message Action, send a copy of the message, or test for viruses. You can also see if a message will be encrypted upon release from the quarantine due to the Encrypt on Delivery filter action.

The Message Details section displays the message body, message headers, and attachments. Only the first 100 K of the message body is displayed. If the message is longer, the first 100 K is shown, followed by an ellipsis (...). The actual message is not truncated. This is for display purposes only. You can download the message body by clicking [message body] in the Message Parts section at the bottom of Message Details. You can also download any of the message’s attachments by clicking the attachment’s filename.

If you view a message that contains a virus and you have desktop anti-virus software installed on your computer, your anti-virus software may complain that it has found a virus. This is not a threat to your computer and can be safely ignored.

To view additional details about the message, click the **Message Tracking** link.



---

**Note** For the special Outbreak quarantine, additional functionality is available. See [The Outbreak Quarantine, on page 916](#).

---

#### Related Topics

- [Viewing Matched Content , on page 914](#)
- [Downloading Attachments , on page 915](#)
- [Testing for Viruses, on page 915](#)

## Viewing Matched Content

When you configure a quarantine action for messages that match Attachment Content conditions, Message Body or Attachment conditions, Message body conditions, or the Attachment content conditions, you can view the matched content in the quarantined message. When you display the message body, the matched content is highlighted in yellow, except for DLP policy violation matches. You can also use the \$MatchedContent action variable to include the matched content from message or content filter matches in the message subject.

If the attachment contains the matched content, the attachment's contents are displayed, as well as the reason it was quarantined, whether it was due to a DLP policy violation, content filter condition, message filter condition, or Image Analysis verdict.

When you view messages in the local quarantine that have triggered message or content filter rules, the GUI may display content that did not actually trigger the filter action (along with content that triggered the filter action). The GUI display should be used as a guideline for locating content matches, but does not necessarily reflect an exact list of content matches. This occurs because the GUI uses less strict content matching logic than is used in the filters. This issue applies only to the highlighting in the message body. The table that lists the matched strings in each part of the message, along with the associated filter rule, is correct.



Figure 71: Matched Content Viewed in the Policy Quarantine

The screenshot displays the 'Matched Content' interface. At the top, a table lists attachments. The selected attachment is 'FP1.1.txt', which is linked to a list of email addresses and dates. Below this, the 'Headers' section shows the raw email header information, including sender and recipient details, date, and subject. The 'Message' section shows the body text 'Test'. At the bottom, the 'Message Parts' table provides a summary of the message components.

| Attachment Name | Matched Content                                                                                                                                                                                                                                                                                                                                                                                                                                                                                      | Condition                           |
|-----------------|------------------------------------------------------------------------------------------------------------------------------------------------------------------------------------------------------------------------------------------------------------------------------------------------------------------------------------------------------------------------------------------------------------------------------------------------------------------------------------------------------|-------------------------------------|
| FP1.1.txt       | <ul style="list-style-type: none"> <li>MS 38930 USA Facilities 662-646-0523 jsamuelson@acmecorp.com 7/17/06 4929132070312710 Acme Corp Irene Gibbs 808 Sumner Street Greenwood MS 38930 USA Publishing 662-646-0522 igibbs@acmecorp.com 2/1/07 4485231592071860 Acme Corp Kathy Lopez 808 Sumner Street Greenwood MS 38930 USA Marketing 662-646-0541 klopez@acmecorp.com 2/1/07 4716298862510192 Acme Corp Marty Smith 808 Sumner Street Greenwood MS 38930 USA Engineerinn 662-646-0542</li> </ul> | DLP Classifier: Contact Information |

```

X-IronPort-AV: E=Sophos;i="4.43,282,1246818600";
d="txt?scan?208";a="178202"
Received: from d2.vmw023-bsd04.ibqa (HELO vmw023-bsd04.ibqa) ([172.22.107.1])
by c360002.ibqa with ESMTP; 28 Jul 2009 16:25:03 +0530
Message-ID: <792087.518002035-sendEmail@vmw023-bsd04>
From: "user@test.com" <user@test.com>
To: "user1@test.com" <user1@test.com>
Subject: DLPTEST
Date: Tue, 28 Jul 2009 08:42:11 +0000
X-Mailer: sendEmail-1.55
MIME-Version: 1.0
Content-Type: multipart/mixed; boundary="----MIME delimiter for sendEmail-538525.714612664"

```

| Name           | Size | Details                                |
|----------------|------|----------------------------------------|
| [message body] | 6    | ASCII text, with CRLF line terminators |
| FP1.1.txt      | 1K   | ASCII text                             |

## Downloading Attachments

You can download a message attachment by clicking the attachment's file name in the Message Parts or Matched Content section. AsyncOS displays a warning that attachments from unknown sources may contain viruses and asks you if you want to continue. Download attachments that may contain viruses at your own risk. You can also download the message body by clicking [message body] in the Message Parts section.

## Testing for Viruses

To test the message for viruses, click **Start Test**. Use a quarantine to hold messages until you are sure that your anti-virus signatures have been updated.

Testing for viruses sends a copy of the message to the anti-virus engine, not the message itself. The verdict from the anti-virus engine is returned and displayed above the Quarantines area.

## About Rescanning of Quarantined Messages

When a message is released from all queues in which it has been quarantined, the following rescanning occurs, depending on the features enabled for the appliance and for the mail policy that originally quarantined the message:

- Messages released from Policy and Virus quarantines are rescanned by the anti-virus, advanced malware protection, and graymail engines.

- Messages released from the Outbreak quarantine are rescanned by the anti-spam, AMP, and anti-virus engines. (For information about rescanning of messages while in the Outbreak quarantine, see )
- Messages released from the File Analysis quarantine are rescanned for threats.
- Messages with attachments are rescanned by the file reputation service upon release from Policy, Virus, and Outbreak quarantines.

Upon rescanning, if the verdict produced matches the verdict produced the previous time the message was processed, the message is not re-quarantined. Conversely, if the verdict is different, the message could be sent to another quarantine.

The rationale is to prevent messages from looping back to the quarantine indefinitely. For example, suppose a message is encrypted and therefore sent to the Virus quarantine. If an administrator releases the message, the anti-virus engine will still not be able to decrypt it; however, the message should not be re-quarantined or a loop will be created and the message will never be released from the quarantine. Since the two verdicts are the same, the system bypasses the Virus quarantine the second time.

## The Outbreak Quarantine

The Outbreak quarantine is present when a valid Outbreak Filters feature license key has been entered. The Outbreak Filters feature sends messages to the Outbreak quarantine, depending on the threshold set. For more information, see

The Outbreak quarantine functions just like other quarantines—you can search for messages, release or delete messages, and so on.

- Standard
- Rule Summary

The Outbreak quarantine has some additional features not available in other quarantines: the Manage by Rule Summary link, the Send to Cisco feature when viewing message details, and the option to sort messages in search results by the Scheduled Exit time.

If the license for the Outbreak Filters feature expires, you will be unable to add more messages to the Outbreak quarantine. Once the messages currently in the quarantine have expired and the Outbreak quarantine becomes empty, it is no longer shown in the Quarantines listing in the GUI.

### Related Topics

- [Rescanning Messages in an Outbreak Quarantine](#) , on page 916
- [Manage by Rule Summary Link](#), on page 917
- [Reporting False Positives or Suspicious Messages to Cisco Systems](#), on page 917

## Rescanning Messages in an Outbreak Quarantine

Messages placed in the Outbreak quarantine are automatically released if newly published rules deem the quarantined message no longer a threat.

If anti-spam and anti-virus are enabled on the appliance , the scanning engines scan every message released from the Outbreak quarantine based on the mail flow policy that applies to the message.

## Manage by Rule Summary Link

Click the Manage by Rule Summary link next to the Outbreak quarantine in the quarantine listing to view the Manage by Rule Summary page. You can perform message actions (Release, Delete, Delay Exit) on all of the messages in the quarantine based on which outbreak rule caused the message to be quarantined. This is ideal for clearing out large numbers of messages from the Outbreak quarantine. For more information, see the topics under Outbreak Quarantine and the Manage by Rule Summary View

## Reporting False Positives or Suspicious Messages to Cisco Systems

When viewing message details for a message in the Outbreak quarantine, you can send the message to Cisco to report false positives or suspicious messages.

### Procedure

---

- Step 1** Navigate to a message in the Outbreak quarantine.
  - Step 2** In the Message Details section, select the **Send a Copy to Cisco Systems** check box.
  - Step 3** In the new web interface, click the blue number in the Message column of the outbreak filters entry in the table and select the check box of the message(s) and select Send a Copy .
  - Step 4** Enter the recipient address and click **Send**.
-





## CHAPTER 36

# Spam Quarantine

This chapter contains the following sections:

- [Overview of the Spam Quarantine](#) , on page 919
- [Local Versus External Spam Quarantine](#) , on page 919
- [Setting Up the Local Spam Quarantine](#), on page 920
- [Using Safelists and Blocklists to Control Email Delivery Based on Sender](#) , on page 925
- [Configuring Spam Management Features for End Users](#) , on page 936
- [Managing Messages in the Spam Quarantine](#) , on page 944
- [Disk Space for the Spam Quarantine](#) , on page 946
- [About Disabling the External Spam Quarantine](#) , on page 947
- [Troubleshooting Spam Quarantine Features](#) , on page 947

## Overview of the Spam Quarantine

The Spam Quarantine (also known as ISQ) and End-User Quarantine (also known as EUQ) provides a safeguard mechanism for organizations that are concerned about “false positives” — that is, legitimate email messages that the appliance has deemed to be spam. When the appliance determines that a message is spam or suspected spam, you may want to let the recipient or an administrator review the message before delivering or deleting it. The spam quarantine stores messages for this purpose.

Administrative users of the appliance can view all messages in a spam quarantine. End users, usually the message recipients, can view their own quarantined messages in a slightly different web interface.

The spam quarantine is separate from policy, virus, and outbreak quarantines.

### Related Topics

- [Managing Spam and Graymail](#), on page 359
- [Policy, Virus, and Outbreak Quarantines](#), on page 899

## Local Versus External Spam Quarantine

A local spam quarantine stores spam and suspect spam on the appliance . An external spam quarantine can store these messages on a separate Cisco Content Security Management appliance .

Consider using an external spam quarantine if:

- You want a centralized location to store and manage spam from multiple appliances .
- You want to store more spam than the appliance can hold.
- You want to regularly back up the spam quarantine and its messages.

#### Related Topics

- [Disk Space for the Spam Quarantine](#) , on page 946
- [Working with an External Spam Quarantine](#) , on page 1250

## Setting Up the Local Spam Quarantine

The following table shows how to send messages to a Spam Quarantine

#### Procedure

|               | Command or Action                                                                                   | Purpose                                                                                                                                                                                                                                           |
|---------------|-----------------------------------------------------------------------------------------------------|---------------------------------------------------------------------------------------------------------------------------------------------------------------------------------------------------------------------------------------------------|
| <b>Step 1</b> | Enable the Anti-Spam feature if you have not yet done so.                                           | For more information, see <a href="#">Managing Spam and Graymail</a> , on page 359.                                                                                                                                                               |
| <b>Step 2</b> | Enable and configure quarantine settings.                                                           | For more information, see <a href="#">Enabling and Configuring the Spam Quarantine on the Legacy Web Interface</a> , on page 921.                                                                                                                 |
| <b>Step 3</b> | Adjust the disk space allocated to the spam quarantine                                              | For more information, see <a href="#">Managing Disk Space</a> , on page 1000                                                                                                                                                                      |
| <b>Step 4</b> | Enable browser access to the quarantine.                                                            | For more information, see <a href="#">Configuring the IP Interface for Browser Access to the Spam Quarantine</a> , on page 922                                                                                                                    |
| <b>Step 5</b> | Configure the appliance to send spam to the quarantine.                                             | For more information, see <ul style="list-style-type: none"> <li>• <a href="#">Configuring a Mail Policy to Quarantine Spam</a> , on page 924</li> <li>• <a href="#">Limiting Which Recipients Have Mail Quarantined</a> , on page 924</li> </ul> |
| <b>Step 6</b> | Specify a default character encoding for messages that do not have this information in the heading. | For more information, see <a href="#">Ensuring That Message Text Displays Correctly</a> , on page 924                                                                                                                                             |

#### What to do next

#### Related Topics

- [Configuring the IP Interface for Browser Access to the Spam Quarantine](#) , on page 922
- [Configuring Administrative User Access to the Spam Quarantine](#) , on page 923
- [Configuring a Mail Policy to Quarantine Spam](#) , on page 924
- [Limiting Which Recipients Have Mail Quarantined](#) , on page 924

- [Ensuring That Message Text Displays Correctly](#) , on page 924
- [Spam Quarantine Language](#), on page 925

## Enabling and Configuring the Spam Quarantine on the Legacy Web Interface

### Procedure

- Step 1** [New Web Interface Only] On the appliance , click  to load the legacy web interface.
- Step 2** Select **Spam Quarantine**.
- Step 3** If you have not previously enabled the spam quarantine, select **Enable Spam Quarantine**.  
If you are editing spam quarantine settings, click the **Spam Quarantine** link in the Quarantine Name column of the Spam Quarantine section.
- Step 4** Specify options:

| Option                            | Description                                                                                                                                                                                                                                                                                                                                                                                                                                                                                                                                                                                                                                                                                                                                                                                           |
|-----------------------------------|-------------------------------------------------------------------------------------------------------------------------------------------------------------------------------------------------------------------------------------------------------------------------------------------------------------------------------------------------------------------------------------------------------------------------------------------------------------------------------------------------------------------------------------------------------------------------------------------------------------------------------------------------------------------------------------------------------------------------------------------------------------------------------------------------------|
| Deliver Messages Via              | <p>All outgoing quarantine-related email (such as spam notifications and messages released from the spam quarantine) must be delivered via another appliance or server that is configured to send messages.</p> <p>You can route these messages through an SMTP or groupware server, or you can specify the outbound listener interface of an appliance (typically the Data 2 interface).</p> <p>The alternate address is used for load balancing and failover.</p> <p>If you have multiple appliances , you can use the outbound listener interface of any managed appliances for the primary and alternate addresses. Both must use the same interface (either Data 1 or Data 2) as the outbound listener.</p> <p>Read instructions on the screen for additional caveats about these addresses.</p> |
| Schedule Delete After             | <p>Specify the number of days to hold messages before deleting them.</p> <p>Cisco recommends that you configure the quarantine to delete older messages to prevent the quarantine from filling to capacity, but you can elect not to schedule automatic deletion.</p>                                                                                                                                                                                                                                                                                                                                                                                                                                                                                                                                 |
| Notify Cisco Upon Message Release | <p>Check the <b>Send a copy of released messages to Cisco for analysis(recommended)</b> checkbox if you wish to notify Cisco upon message release.</p>                                                                                                                                                                                                                                                                                                                                                                                                                                                                                                                                                                                                                                                |

| Option                     | Description                                                                                                                                                                                                                                                                                                                                                                                                                                                                                                                                                                                                                                                                               |
|----------------------------|-------------------------------------------------------------------------------------------------------------------------------------------------------------------------------------------------------------------------------------------------------------------------------------------------------------------------------------------------------------------------------------------------------------------------------------------------------------------------------------------------------------------------------------------------------------------------------------------------------------------------------------------------------------------------------------------|
| Spam Quarantine Appearance | <p><b>Logo</b></p> <p>By default, the Cisco logo is displayed at the top of the spam quarantine page when the user logs in to view quarantined messages.</p> <p>To use a custom logo instead, upload the logo. The logo should be a .jpg, .gif, or .png file that is at most 50 pixels high by 500 pixels wide.</p> <p><b>Login page message</b></p> <p>(Optional) Specify a login page message. This message is shown to end users and administrators when they log in to view the quarantine.</p> <p>If you do not specify a message, the following message appears:</p> <p>Enter your login information below. If you are unsure what to enter, please contact your administrator.</p> |
| Administrative Users       | See <a href="#">Configuring Administrative User Access to the Spam Quarantine</a> , on page 923.                                                                                                                                                                                                                                                                                                                                                                                                                                                                                                                                                                                          |

**Step 5** Submit and commit your changes.

---

#### What to do next

- Return to [Setting Up the Local Spam Quarantine, on page 920](#)

## Configuring the IP Interface for Browser Access to the Spam Quarantine

When administrators and end users access the spam quarantine, a separate browser window opens.

#### Procedure

---

**Step 1** [New Web Interface Only] On the appliance , click  to load the legacy web interface.

**Step 2** Choose **Network > IP Interfaces**.

**Step 3** Click the interface name (for this example, we will use the Management interface).

**Step 4** In the Spam Quarantine section, configure settings for access to the spam quarantine:

- By default, HTTP uses port 82 and HTTPS uses port 83.
- Specify the URL that appears in notifications and in the spam quarantine browser window.

If you do not want to expose the hostname of your Security Management appliance to end users, you can specify an alternate hostname.



**Step 5** Submit and commit your changes.

---

#### What to do next

Ensure that your DNS server can resolve the hostname that you specified for spam quarantine access.

## Configuring Administrative User Access to the Spam Quarantine

All users with administrator privileges can change spam quarantine settings and view and manage messages in the spam quarantine. You do not need to configure spam quarantine access for administrator users.

If you configure access to the spam quarantine for users with the following roles, they can view, release, and delete messages in the spam quarantine:

- Operator
- Read-only operator
- Help desk user
- Guest
- Custom user roles that have spam quarantine privileges

These users cannot access spam quarantine settings.

#### Before you begin

Create users or custom user roles that have access to the spam quarantine. For more information, see [Distributing Administrative Tasks, on page 949](#)

#### Procedure

---

**Step 1** On the Security Management appliance, click **Service Status** and hover over the  corresponding to **Spam Quarantine** and click **Edit Spam Quarantine Settings**.

**Step 2** Click the toggle switch to enable Spam Quarantine.

**Step 3** Click the link for the type of user to add: local, externally authenticated, or custom role.

If you have already added users or roles, click a username or role to view all eligible users or roles.

**Step 4** Select the users or roles that you want to add.

Users with Administrator privileges are not listed because they automatically have full access to the spam quarantine.

**Step 5** Click **OK**.

**Step 6** Click **Submit**.

---

#### What to do next

#### Related Topics

[Configuring End-User Access to the Spam Quarantine](#), on page 938

## Configuring a Mail Policy to Quarantine Spam

Once you have enabled the spam quarantine, you can configure a mail policy to send spam or suspected spam to that quarantine. Anti-spam scanning must be enabled on the mail policy in order to send mail to the spam quarantine.

### Procedure

---

- Step 1** On the **Mail Policies > Incoming Mail Policies** page, click the link in the Anti-Spam column for the corresponding mail policy.
  - Step 2** In the Anti-Spam Settings section, select **Use IronPort Anti-Spam service**.
  - Step 3** In the Positively-Identified Spam Settings section, select **Spam Quarantine** for the **Apply This Action to Message** option.
  - Step 4** Configure settings for suspected spam and marketing email.
  - Step 5** Submit and commit your changes.
- 

## Limiting Which Recipients Have Mail Quarantined

You can use multiple mail policies on the appliance (Mail Policies > Incoming Mail Policy) to specify a list of recipient addresses for which mail will not be quarantined. Select 'Deliver' or 'Drop' instead of quarantine when configuring the anti-spam settings for the mail policy.

## Ensuring That Message Text Displays Correctly

AsyncOS attempts to determine the character set of a message based on the encoding that is specified in the message headers. However, if the encoding specified in the headers does not match that of the actual text, the message will not be displayed properly when viewed in the spam quarantine. This situation is more likely to occur with spam messages.

To ensure that message text displays correctly for these messages, see .

### Related Topic

- [Specifying a Default Encoding](#) , on page 924

## Specifying a Default Encoding

If an incoming message does not have a character set encoding specified in the headers, you can configure your appliance to specify a default encoding.

Doing so will help ensure that these types of messages display properly in the spam quarantine. However, specifying a default encoding can cause messages in other character sets to display incorrectly. This setting applies only to messages that do not specify the encoding in the message headers. Generally, you would only set a default encoding if you expect the majority of your mail that falls into this category to be of one specific encoding.

For example, if most quarantined messages that do not specify the character set encoding in the message headers are in Japanese (ISO-2022-JP), you can set the encoding on the Scan Behavior page as **Japanese (ISO-2022-JP)**.

## Procedure

---

- Step 1** Click **Security Services > Scan Behavior**.
  - Step 2** Under Global Settings, click **Edit Global Settings**.
  - Step 3** From the **Encoding to use when none is specified** drop-down list, select the desired encoding type.
  - Step 4** Click **Submit**.
  - Step 5** Click **Commit Changes**.
- 

## Spam Quarantine Language

Each user selects a language in the spam quarantine from the Options menu at the top right of the window.

## Using Safelists and Blocklists to Control Email Delivery Based on Sender

Administrators and end users can use safelists and blocklists to help determine which messages are spam. Safelists specify senders and domains that are never treated as spam. Blocklists specify senders and domains that are always treated as spam.

You can allow end users (email users) to manage the safelist and blocklist for their own email accounts. For example, an end user may receive email from a mailing list that no longer interests him. He may decide to add this sender to his blocklist to prevent emails from the mailing list from being sent to his inbox. On the other hand, end users may find that emails from specific senders are sent to their spam quarantine when they do not want them to be treated as spam. To ensure that messages from these senders are not quarantined, they may want to add the senders to their safelists.

Changes that end users and administrators make are visible to and can be changed by either.

### Related Topics

- [Message Processing of Safelists and Blocklists](#) , on page 925
- [Enabling Safelists and Blocklists on the Legacy Web Interface](#), on page 926
- [External Spam Quarantine and Safelist/Blocklists](#) , on page 927
- [Adding Senders and Domains to Safelists and Blocklists \(Administrators\)](#) , on page 927
- [About End-User Access to Safelists and Blocklists](#) , on page 932
- [Synchronizing Safelists or Blocklists on Multiple Email Security Appliances \(Deployments Without a Security Management Appliance\)](#) , on page 934
- [Backing Up and Restoring the Safelist/Blocklist](#) , on page 934
- [Troubleshooting Safelists and Blocklists](#), on page 935

## Message Processing of Safelists and Blocklists

A sender's being on a safelist or blocklist does not prevent the appliance from scanning a message for viruses or determining if the message meets the criteria for a content-related mail policy. Even if the sender of a

message is on the recipient's safelist, the message may not be delivered to the end user depending on other scanning settings and results.

When you enable safelists and blocklists, the appliance scans the messages against the safelist/blocklist database immediately before anti-spam scanning. If the appliance detects a sender or domain that matches a safelist or blocklist entry, the message will be splintered if there are multiple recipients (and the recipients have different safelist/blocklist settings). For example, a message is sent to both recipient A and recipient B. Recipient A has safelisted the sender, whereas recipient B does not have an entry for the sender in the safelist or the blocklist. In this case, the message may be split into two messages with two message IDs. The message sent to recipient A is marked as safelisted with an *X-SLBL-Result-Safelist* header and skips anti-spam scanning, whereas the message bound for recipient B is scanned by the anti-spam scanning engine. Both messages then continue along the pipeline (through anti-virus scanning, content policies, and so on) and are subject to any configured settings.

If a message sender or domain is blocklisted, the delivery behavior depends on the blocklist action that you specify when you enable the safelist/blocklist feature. Similar to safelist delivery, the message is splintered if there are different recipients with different safelist/blocklist settings. The blocklisted message splinter is then quarantined or dropped, depending on the blocklist action settings. If the blocklist action is configured to quarantine, the message is scanned and eventually quarantined. If the blocklist action is configured to delete, the message is dropped immediately after safelist/blocklist scanning.

Because safelists and blocklists are maintained in the spam quarantine, delivery behavior is also contingent on other anti-spam settings. For example, if you configure the "Accept" mail flow policy in the Host Access Table (HAT) to skip anti-spam scanning, then users who receive mail on that listener will not have their safelist and blocklist settings applied to mail received on that listener. Similarly, if you create a mail flow policy that skips anti-spam scanning for certain message recipients, these recipients will not have their safelist and blocklist settings applied.

### Related Topics

- [Enabling Safelists and Blocklists on the Legacy Web Interface, on page 926](#)
- [External Spam Quarantine and Safelist/Blocklists , on page 927](#)

## Enabling Safelists and Blocklists on the Legacy Web Interface

### Before you begin

- The spam quarantine must be enabled. See [Setting Up the Local Spam Quarantine, on page 920](#).
- Configure the appliance to use an external safelist/blocklist. See instructions for setting up an external spam quarantine in the documentation for your appliance .

### Procedure

- 
- Step 1** [New Web Interface Only] On the appliance , click  to load the legacy web interface.
  - Step 2** Navigate to **Spam Quarantine**.
  - Step 3** Under **End-User Safelist/Blocklist**, click **Edit Settings**.
  - Step 4** Select **Enable End User Safelist/Blocklist Feature**.
  - Step 5** Select **Quarantine** or **Delete** for the Blocklist Action.

**Step 6** Specify **Maximum List Items Per User**.

This is the maximum number of addresses or domains for each list, for each recipient. If you allow a large number of list entries per user, system performance might be adversely affected.

**Step 7** Select **Update Frequency**.

This value determines how often AsyncOS updates the safelists/blocklists on the appliances that use the external spam quarantine. The significance of this setting is described in [External Spam Quarantine and Safelist/Blocklists](#) , on page 927.

**Step 8** Select the update frequency. This value determines how often AsyncOS updates the safelists/blocklists on the appliances that use the external spam quarantine. The significance of this setting is described in [External Spam Quarantine and Safelist/Blocklists](#) , on page 927.**Step 9** Submit and commit your changes.

## External Spam Quarantine and Safelist/Blocklists

If you use an external spam quarantine on a Security Management appliance , the safelist/blocklist is saved on the management appliance. This gives you a single location to manage safe and blocked senders for all appliances.

Because the appliance evaluates senders in safelists and blocklists when processing incoming mail, safelists and blocklists that are stored on a Security Management appliance must be sent to the appliance in order to be applied to incoming mail. When you configure the safelist/blocklist feature on a Security Management appliance , you configure the frequency of these updates.

For more information about working with external safelists and blocklists on a Security Management appliance , see the topics under the *Cisco Content Security Management Appliance User Guide*

## Adding Senders and Domains to Safelists and Blocklists (Administrators)

Manage safelists and blocklists via the spam quarantine interface.

You can also see whether many recipients (end users in your organization) have included a particular sender or domain in allowed list or blocked list.

Administrators see and work with the superset of the same entries that each end user sees and works with.

**Before you begin**

- Ensure that you can access the spam quarantine. See [Accessing the Spam Quarantine \(Administrative Users\)](#), on page 944.
- Enable access to the safelist/blocklist. See [Enabling Safelists and Blocklists on the Legacy Web Interface](#), on page 926.
- (Optional) To import safelist/blocklists instead of building these lists using the procedure in this section, use the process described in [Backing Up and Restoring the Safelist/Blocklist](#) , on page 934.
- Understand the required format of safelist and blocklist entries. See [Syntax for Safelists and Blocklist Entries](#) , on page 931.

## Procedure

**Step 1** [New Web Interface Only] On the appliance , click **Quarantine > Spam Quarantine > Search**.

Or

Choose **Monitor > Spam Quarantine** and select the **Options** drop-down menu in the upper right corner of the page.

**Step 2** Choose **Safelist** or **Blocklist**.

**Step 3** (Optional) Search for a sender or recipient.

**Step 4** Do one or more of the following:

| To                                   | Do This                                                                                                                                                                                                                                                                                                                                                                                                                                                                                                                                                                                                                                                                                                                                                                                                                                                                                                                                                                                                                                                                                                                                                         |
|--------------------------------------|-----------------------------------------------------------------------------------------------------------------------------------------------------------------------------------------------------------------------------------------------------------------------------------------------------------------------------------------------------------------------------------------------------------------------------------------------------------------------------------------------------------------------------------------------------------------------------------------------------------------------------------------------------------------------------------------------------------------------------------------------------------------------------------------------------------------------------------------------------------------------------------------------------------------------------------------------------------------------------------------------------------------------------------------------------------------------------------------------------------------------------------------------------------------|
| Add multiple senders for a recipient | <p>To add multiple senders for a recipient on the new web interface:</p> <ol style="list-style-type: none"> <li>Select <b>Recipient</b> tab.</li> <li>Click on the + icon to add a recipient address and sender list.</li> <li>Enter the recipient email address.</li> <li>Enter the sender email addresses and domains.<br/>Put each entry on a separate line, or separate each entry with a comma.</li> <li>Click <input checked="" type="checkbox"/> to save the entry.</li> </ol> <p>To modify an existing sender address, select the checkbox next to the required recipient address, click the edit icon, modify the sender address and click <input checked="" type="checkbox"/> to save the entry.</p> <p>To add multiple senders for a recipient on the legacy web interface:</p> <ol style="list-style-type: none"> <li>Select <b>View by: Recipient</b></li> <li>Click <b>Add</b>, or click <b>Edit</b> for a recipient.</li> <li>Enter or edit the recipient email address.</li> <li>Enter sender email addresses and domains.<br/>Put each entry on a separate line, or separate each entry with a comma.</li> <li>Click <b>Submit</b>.</li> </ol> |

| To                                             | Do This                                                                                                                                                                                                                                                                                                                                                                                                                                                                                                                                                                                                                                                                                                                                                                                                                                                                                                                                                                                                                                                                                                                  |
|------------------------------------------------|--------------------------------------------------------------------------------------------------------------------------------------------------------------------------------------------------------------------------------------------------------------------------------------------------------------------------------------------------------------------------------------------------------------------------------------------------------------------------------------------------------------------------------------------------------------------------------------------------------------------------------------------------------------------------------------------------------------------------------------------------------------------------------------------------------------------------------------------------------------------------------------------------------------------------------------------------------------------------------------------------------------------------------------------------------------------------------------------------------------------------|
| Add multiple recipients for a sender           | <p>To add multiple recipient for a sender on the new web interface:</p> <ol style="list-style-type: none"> <li>Select <b>Sender</b> tab.</li> <li>Click + to add a sender address and recipient list.</li> <li>Enter the sender address or domain.</li> <li>Enter the recipient email addresses.<br/>Put each entry on a separate line, or separate each entry with a comma.</li> <li>Click <input checked="" type="checkbox"/> to save the entry.</li> </ol> <p>To modify an existing recipient address, select the checkbox next to the required sender address, click the edit icon, modify the sender address and click <input checked="" type="checkbox"/> to save the entry.</p> <p>To add multiple recipient for a sender on the legacy web interface:</p> <ol style="list-style-type: none"> <li>Select <b>View by: Sender</b></li> <li>Click <b>Add</b>, or click <b>Edit</b> for a sender.</li> <li>Enter or edit the sender address or domain.</li> <li>Enter recipient email addresses.<br/>Put each entry on a separate line, or separate each entry with a comma.</li> <li>Click <b>Submit</b>.</li> </ol> |
| Delete all senders associated with a recipient | <p>To delete all senders associated with a recipient on the new web interface:</p> <ol style="list-style-type: none"> <li>Select the checkbox next to the recipient or sender address to select the entry.<br/>You can select and delete all entries.</li> <li>Click on the trash can icon to delete an entire table row.</li> </ol> <p>To delete all senders associated with a recipient on the legacy web interface:</p> <ol style="list-style-type: none"> <li>Select a <b>View by</b> option.</li> <li>Click a trash can icon to delete an entire table row.</li> </ol>                                                                                                                                                                                                                                                                                                                                                                                                                                                                                                                                              |

| To                                             | Do This                                                                                                                                                                                                                                                                                                                                                                                                                                                                                                                                                                                                                                                                                                                                                                                                                                                                                  |
|------------------------------------------------|------------------------------------------------------------------------------------------------------------------------------------------------------------------------------------------------------------------------------------------------------------------------------------------------------------------------------------------------------------------------------------------------------------------------------------------------------------------------------------------------------------------------------------------------------------------------------------------------------------------------------------------------------------------------------------------------------------------------------------------------------------------------------------------------------------------------------------------------------------------------------------------|
| Delete all recipients associated with a sender | <p>To delete all recipients associated with a sender on the new web interface:</p> <ol style="list-style-type: none"> <li>a. Select the checkbox next to the recipient or sender address to select the entry.<br/>You can select and delete all entries.</li> <li>b. Click on the trash can icon to delete an entire table row.</li> </ol> <p>To delete all recipients associated with a sender on the legacy web interface:</p> <ol style="list-style-type: none"> <li>a. Select a <b>View by</b> option.</li> <li>b. Click a trash can icon to delete an entire table row.</li> </ol>                                                                                                                                                                                                                                                                                                  |
| Delete individual senders for a recipient      | <p>To delete individual senders for a recipient on the new web interface:</p> <ol style="list-style-type: none"> <li>a. Select the checkbox next to the recipient or sender address to select the entry.<br/>You can select and delete multiple entries.</li> <li>b. Click on the edit icon to modify an individual recipient or sender.</li> <li>c. Add or remove entries from the text box. You must leave at least one entry.</li> <li>d. Click <input checked="" type="checkbox"/> to save the entry.</li> </ol> <p>To delete individual senders for a recipient on the legacy web interface:</p> <ol style="list-style-type: none"> <li>a. Select a <b>View by</b> option.</li> <li>b. Click <b>Edit</b> for an individual recipient or sender.</li> <li>c. Add or remove entries from the text box. You must leave at least one entry.</li> <li>d. Click <b>Submit</b>.</li> </ol> |



| To                                        | Do This                                                                                                                                                                                                                                                                                                                                                                                                                                                                                                                                                                                                                                                                                                                                                                                                                                                         |
|-------------------------------------------|-----------------------------------------------------------------------------------------------------------------------------------------------------------------------------------------------------------------------------------------------------------------------------------------------------------------------------------------------------------------------------------------------------------------------------------------------------------------------------------------------------------------------------------------------------------------------------------------------------------------------------------------------------------------------------------------------------------------------------------------------------------------------------------------------------------------------------------------------------------------|
| Delete individual recipients for a sender | <p>To delete individual recipient for a sender on the new web interface:</p> <ol style="list-style-type: none"> <li>Select the checkbox next to the recipient or sender address to select the entry.<br/>You can select and delete multiple entries.</li> <li>Click on the edit icon to modify an individual recipient or sender.</li> <li>Add or remove entries from the text box. You must leave at least one entry.</li> <li>Click <input checked="" type="checkbox"/> to save the entry.</li> </ol> <p>To delete individual senders for a recipient on the legacy web interface:</p> <ol style="list-style-type: none"> <li>Select a <b>View by</b> option.</li> <li>Click <b>Edit</b> for an individual recipient or sender.</li> <li>Add or remove entries from the text box. You must leave at least one entry.</li> <li>Click <b>Submit</b>.</li> </ol> |

### What to do next

#### Related Topics

- [Syntax for Safelists and Blocklist Entries](#) , on page 931
- [Clearing All Safelists and Blocklists](#) , on page 932

## Syntax for Safelists and Blocklist Entries

Senders can be added to safelists and blocklists using the following formats:

- user@domain.com
- server.domain.com
- domain.com
- [10.1.1.0]
- [ipv6:2001:DB8:1::1]
- user@[1.2.3.4]
- user@[ipv6:2001:db8::1]

An identical entry, such as a sender address or a domain, cannot be included on both the safelist and the blocklist at the same time. However, a domain can be on a safelist while an email address for a sender belonging to that domain is on the blocklist (or vice versa), and both rules apply. For example, if *example.com* is on the

safelist, *george@example.com* can be on the blocklist. In this case, the appliance delivers all mail from *example.com* without scanning for spam, except mail from *george@example.com*, which is treated as spam.

It is not possible allow or block a range of subdomains using the following syntax: *.domain.com* . However, it is possible to block a specific domain using the following syntax: *server.domain.com* .

## Clearing All Safelists and Blocklists

If you need to delete all safelist and blocklist entries, including all senders and all recipients, import a file with no entries using the procedure in [Backing Up and Restoring the Safelist/Blocklist](#) , on page 934.

## About End-User Access to Safelists and Blocklists

End users access their safelist and blocklist via the spam quarantine. To configure end-user access to the spam quarantine, see [Setting Up End-User Access to the Spam Quarantine via Web Browser](#) .

You may want to give your end users the URL of the spam quarantine and the instructions below, as applicable.

### Related Topics

- [Adding Entries to Safelists \(End Users\)](#)
- [Adding Senders to Blocklists \(End Users\)](#)

## Adding Entries to Safelists (End Users)



---

**Note** Delivery of messages from safelisted senders depends on other settings that are configured in the system. See [Message Processing of Safelists and Blocklists](#) , on page 925.

---

End users can add senders to safelists in two ways:

- [Adding the Sender of a Quarantined Message to the Safelist](#) , on page 932
- [Adding Senders to the Safelist Without a Quarantined Message](#) , on page 933

### Adding the Sender of a Quarantined Message to the Safelist

End users can add senders to the safelist if the message has been sent to the spam quarantine.

#### Procedure

---

- Step 1** [New Web Interface Only] Choose **Quarantine > Spam Quarantine > Safelist**.
- Or
- Choose **Monitor > Spam Quarantine > Safelist**.
- Step 2** [New Web Interface Only] Click **Release and Add to Safelist** icon to release the message and add it to the safelist.
- Or

Select **Release and Add to Safelist** from the drop-down menu.

The envelope sender and the from header for the specified mail are both added to the safelist, and the released messages proceed directly to the destination queue, skipping any further work queue processing in the email pipeline.

---

## Adding Senders to the Safelist Without a Quarantined Message

### Procedure

---

- Step 1** [New Web Interface Only] Choose **Quarantine > Spam Quarantine > Safelist** and click the plus icon on the top right side page.
- Step 2** [New Web Interface Only] Enter the email address or domain. You can enter multiple domains and email addresses, separated by commas.
- Step 3** [New Web Interface Only] Click  to save the entry.
- Step 4** Optionally you can perform this task from the legacy interface:
- Choose **Monitor > Spam Quarantine**.
  - Select the **Options** drop-down menu in the upper right corner of the page
  - Choose **Safelist**.
  - From the Safelist dialog box, enter the email address or domain. You can enter multiple domains and email addresses, separated by commas.
  - Click **Add to List**.
- 

## Adding Senders to Blocklists (End Users)

Messages from blocklisted senders may be rejected or quarantined, depending on the safelist/blocklist action settings defined by your administrator.



---

**Note** You can add blocklist entries only using this procedure.

---

### Procedure

---

- Step 1** [New Web Interface Only] Choose **Quarantine > Spam Quarantine** .
- Step 2** [New Web Interface Only] Choose **Blocklist**, click the + icon and enter the domain or email address that you want to blocklist. You can enter multiple domains and email addresses, separated by commas.
- Step 3** [New Web Interface Only] Click  to save the entry.
- Step 4** Optionally you can perform this task from the legacy interface:
- Choose **Monitor > Spam Quarantine**.
  - Choose **Blocklist** from the **Options** drop-down menu in the upper right corner of the page.

- c) Enter the domain or email address that you want to blocklist. You can enter multiple domains and email addresses, separated by commas.
- d) Click **Add to List**.

## Synchronizing Safelists or Blocklists on Multiple Email Security Appliances (Deployments Without a Security Management Appliance)

If you use multiple appliances without a Security Management appliance, you may need to manually synchronize the safelist/blocklist and its configuration settings across the different appliances.

You can export and import a .csv file using the procedure described in [Backing Up and Restoring the Safelist/Blocklist](#), on page 934, then use FTP to upload and download the file.

### Backing Up and Restoring the Safelist/Blocklist

Before you upgrade your appliance or run the installation wizard, you should back up the safelist/blocklist database. Safelist/blocklist information is not included in the main XML configuration file that contains your appliance configuration settings.

You can also use this procedure to save a copy of the safelist/blocklist to synchronize multiple appliances.

#### Procedure

- Step 1** [New Web Interface Only] On the appliance, click  to load the legacy web interface.
- Step 2** Select **System Administration > Configuration File**.
- Step 3** Scroll to the **End-User Safelist/Blocklist Database (Spam Quarantine)** section.

| To                            | Do This                                                                                                                                                                                                                                                                                               |
|-------------------------------|-------------------------------------------------------------------------------------------------------------------------------------------------------------------------------------------------------------------------------------------------------------------------------------------------------|
| Export the safelist/blocklist | <p>Note the path and filename of the .csv file, and modify as needed.</p> <p>Click <b>Backup Now</b>.</p> <p>The appliance saves a .csv file to the /configuration directory of the appliance using the following naming convention:</p> <p><i>slbl&lt;serial number&gt;&lt;timestamp&gt;.csv</i></p> |

| To                            | Do This                                                                                                                                                                                                                                                                                                                                                      |
|-------------------------------|--------------------------------------------------------------------------------------------------------------------------------------------------------------------------------------------------------------------------------------------------------------------------------------------------------------------------------------------------------------|
| Import the safelist/blocklist | <p><b>Caution</b> This process will overwrite all existing entries in safelists and blocklists for all users.</p> <p>Click <b>Select File to Restore</b>.</p> <p>Select the desired file from the list of files in your configuration directory.</p> <p>Select the safelist/blocklist backup file that you want to restore.</p> <p>Click <b>Restore</b>.</p> |

## Troubleshooting Safelists and Blocklists

To troubleshoot issues with safelists and blocklists, you can view the log files or system alerts.

When an email is blocked due to safelist/blocklist settings, the action is logged in the ISQ\_log files or the antispam log files. Emails that are safelisted are marked as safelisted with an *X-SLBL-Result-Safelist* header. Emails that are blocklisted are marked as blocklisted with an *X-SLBL-Result-Blocklist* header.

Alerts are sent out when the database is created or updated, or if there are errors in modifying the database or running the safelist/blocklist processes.

For more information about alerts, see [Alerts, on page 1021](#).

For more information about log files, see [Logging, on page 1113](#).

### Related Topics

- [Message from Safelisted Sender Was Not Delivered , on page 935](#)

## Message from Safelisted Sender Was Not Delivered

### Problem

Message from a safelisted sender was not delivered.

### Solution

Possible causes:

- The message was dropped for malware or content violations. See [Message Processing of Safelists and Blocklists , on page 925](#).
- If you have multiple appliances and the sender was recently added to the safelist, then safelist/blocklists might not have been synchronized at the time the message was processed. See [External Spam Quarantine and Safelist/Blocklists , on page 927](#) and [Synchronizing Safelists or Blocklists on Multiple Email Security Appliances \(Deployments Without a Security Management Appliance \) , on page 934](#).

## Configuring Spam Management Features for End Users

| To                                                                                                                                                                     | See                                                                                                    |
|------------------------------------------------------------------------------------------------------------------------------------------------------------------------|--------------------------------------------------------------------------------------------------------|
| Understand the benefits and limitations of the different authentication methods for end-user access to spam management features.                                       | <a href="#">Configuring End-User Access to the Spam Quarantine</a> , on page 938 and subsections       |
| Allow end users to access the spam quarantine directly via browser.                                                                                                    | <a href="#">Authentication Options for End Users Accessing Spam Management Features</a> , on page 936  |
| Send users a notification when messages addressed to them are routed to the spam quarantine.<br><br>Notifications can include links for access to the spam quarantine. | <a href="#">Notifying End Users About Quarantined Messages</a> , on page 940                           |
| Allow users to specify email addresses and domains of senders whom they know to be safe, and of senders whom they know to be sending spam or other unwanted mail.      | <a href="#">Using Safelists and Blocklists to Control Email Delivery Based on Sender</a> , on page 925 |

### Related Topics

- [Authentication Options for End Users Accessing Spam Management Features](#) , on page 936
- [Setting Up End-User Access to the Spam Quarantine via Web Browser](#) , on page 938
- [Notifying End Users About Quarantined Messages](#) , on page 940

## Authentication Options for End Users Accessing Spam Management Features



**Note** Mailbox authentication does not allow users to view messages addressed to an email alias.

| For End-User Spam Quarantine Access                                                                                   | Do This                                                                                                                                                                                                                                                                    |
|-----------------------------------------------------------------------------------------------------------------------|----------------------------------------------------------------------------------------------------------------------------------------------------------------------------------------------------------------------------------------------------------------------------|
| Directly via web browser, authentication required<br>and<br>Via a link in a notification, authentication required     | <ol style="list-style-type: none"> <li>1. In the End User Quarantine Access settings, choose <b>LDAP</b>, or <b>Mailbox (IMAP/POP)</b>.</li> <li>2. In the Spam Notifications settings, deselect <b>Enable login without credentials for quarantine access</b>.</li> </ol> |
| Directly via web browser, authentication required<br>and<br>Via a link in a notification, authentication not required | <ol style="list-style-type: none"> <li>1. In the End User Quarantine Access settings, choose <b>LDAP</b>, or <b>Mailbox (IMAP/POP)</b>.</li> <li>2. In the Spam Notifications settings, select <b>Enable login without credentials for quarantine access</b>.</li> </ol>   |

| For End-User Spam Quarantine Access                            | Do This                                                                                         |
|----------------------------------------------------------------|-------------------------------------------------------------------------------------------------|
| Only via a link in a notification, authentication not required | In the End User Quarantine Access settings, choose <b>None</b> as the authentication method.    |
| No access                                                      | In the End User Quarantine Access settings, deselect <b>Enable End-User Quarantine Access</b> . |

### Related Topics

- [LDAP Authentication Process](#) , on page 937
- [Configuring End-User Access to the Spam Quarantine](#) , on page 938
- [Notifying End Users About Quarantined Messages](#) , on page 940
- [Authentication Options for End Users Accessing Spam Management Features](#) , on page 936
- [About End-User Access to Safelists and Blocklists](#) , on page 932

## LDAP Authentication Process

1. A user enters his or her username and passphrase into the web UI login page.
2. The spam quarantine connects to the specified LDAP server either to perform an anonymous search or as an authenticated user with the specified “Server Login” DN and passphrase. For Active Directory, you will usually need to have the server connect on the “Global Catalog port” (it is in the 6000s) and you need to create a low privilege LDAP user that the spam quarantine can bind as in order to execute the search.
3. The spam quarantine then searches for the user using the specified BaseDN and Query String. When a user’s LDAP record is found, the spam quarantine then extracts the DN for that record and attempts bind to the directory using the user records’ DN and the passphrase they entered originally. If this passphrase check succeeds then the user is properly authenticated, but the spam quarantine still needs to determine which mailboxes’ contents to show for that user.
4. Messages are stored in the spam quarantine using the recipient's envelope address. After a user's passphrase is validated against LDAP, the spam quarantine then retrieves the “Primary Email Attribute” from the LDAP record to determine which envelope address they should show quarantined messages for. The “Primary Email Attribute” can contain multiple email addresses which are then used to determine what envelope addresses should be displayed from the quarantine for the authenticated user.

### Related Topics

- [Authentication Options for End Users Accessing Spam Management Features](#) , on page 936

## IMAP/POP Authentication Process

1. Depending on your mail server configuration, a user enters their username ( joe ) or email address ( joe@example.com ) and passphrase into the web UI login page. You can modify the Login Page Message to tell your users whether they should enter a full email address or just their username (see [Configuring End-User Access to the Spam Quarantine](#) , on page 938).
2. The spam quarantine connects to the IMAP or POP server and uses the entered login (either username or email address) and passphrase to try to log into the IMAP/POP server. If the passphrase is accepted then the user is considered authenticated and the spam quarantine immediately logs out of the IMAP/POP server.
3. Once the user is authenticated, the spam quarantine lists email for the user, based on the email address:

- If you have configured the spam quarantine to specify a domain to append to bare usernames (like joe ), then this domain is appended and that fully qualified email address is used to search for matching envelopes in the quarantine.
- Otherwise, the spam quarantine uses the entered email address to search for matching envelopes.

For more information about IMAP, see the University of Washington web site:

<http://www.washington.edu/imap/>

## Setting Up End-User Access to the Spam Quarantine via Web Browser

### Procedure

---

- Step 1** Understand the benefits and limitations of the different authentication methods for end-user access to spam management features.
- Step 2** If you will authenticate end users using LDAP, configure an LDAP server profile, including the **Spam Quarantine End-User Authentication Query** settings on the **System Administration > LDAP > LDAP Server Profile** page.
- Example:**  
If you will authenticate end users using SAML 2.0 (SSO), configure the settings on the **System Administration > SAML** page.
- Step 3** Configure end-user access to the spam quarantine.  
[Configuring End-User Access to the Spam Quarantine](#) , on page 938
- Step 4** Determine the URL for end-user access to the spam quarantine.  
[Determining the URL for End-User Access to the Spam Quarantine](#), on page 939
- 

### What to do next

#### Related Topics

- [Configuring End-User Access to the Spam Quarantine](#) , on page 938
- [Determining the URL for End-User Access to the Spam Quarantine](#), on page 939
- [Which Messages an End User Sees](#) , on page 940

## Configuring End-User Access to the Spam Quarantine

Administrative users can access the spam quarantine whether or not end-user access is enabled.

### Before you begin

See requirements in [Authentication Options for End Users Accessing Spam Management Features](#) , on page 936.



## Procedure

- Step 1** If you are on the legacy interface, navigate to **Management Appliance > Centralized Services > Monitor > Spam Quarantine > Edit Settings**, and then scroll down to **End-User Quarantine Access**. If you are on the new web interface, then navigate to Security Management appliance, click **Service Status** and hover on  icon and click **Edit End-User Quarantine Settings**. You will be redirected to the legacy interface.
- Step 2** Select **Enable End-User Quarantine Access**.
- Step 3** Specify the method to use to authenticate end users when they attempt to view their quarantined messages.

| Select This Option | More Information                                                                                                                                                                                                                                                                                                                                                                                                                                                                                                                                                                                                                                                                                                                                                                                                                                                                                                    |
|--------------------|---------------------------------------------------------------------------------------------------------------------------------------------------------------------------------------------------------------------------------------------------------------------------------------------------------------------------------------------------------------------------------------------------------------------------------------------------------------------------------------------------------------------------------------------------------------------------------------------------------------------------------------------------------------------------------------------------------------------------------------------------------------------------------------------------------------------------------------------------------------------------------------------------------------------|
| None               | Choose this option to make the quarantined messages accessible to the end-users via links in the spam notification without additional authentication.                                                                                                                                                                                                                                                                                                                                                                                                                                                                                                                                                                                                                                                                                                                                                               |
| Mailbox (IMAP/POP) | <p>For sites without an LDAP directory to use for authentication, the quarantine can validate user email addresses and passphrases against a standards-based IMAP or POP server that holds their mailbox.</p> <p>When logging in to the spam quarantine, end users enter their full email address and mailbox passphrase.</p> <p>If the POP server advertises APOP support in the banner, then for security reasons (i.e., to avoid sending the passphrase in the clear) the Cisco appliance will only use APOP. If APOP is not supported for some or all users then the POP server should be reconfigured to not advertise APOP.</p> <p>Select SSL if you have configured your server to use it. If users enter username only, you can specify a domain to add to automatically complete the email address. Enter the domain of the envelope for users logging in to “Append Domain to Unqualified Usernames.”</p> |
| LDAP               | Configure LDAP settings as described in the sections referenced in the Before You Begin section of this topic.                                                                                                                                                                                                                                                                                                                                                                                                                                                                                                                                                                                                                                                                                                                                                                                                      |

- Step 4** Specify whether or not to display message bodies before messages are released.
- If this box is selected, users may not view the message body via the spam quarantine page. Instead, to view the body of a quarantined message, users must release the message and view it in their mail application (such as Microsoft Outlook). You can use this feature for policy and regulation compliance — for example, if a regulation requires that all viewed email be archived.
- Step 5** Submit and commit your changes.

## Determining the URL for End-User Access to the Spam Quarantine

The URL that end users can use to directly access the spam quarantine is formed from the hostname of the machine and the settings (HTTP/S and port numbers) configured on the IP interface on which the quarantine has been enabled. For example, `HTTP://mail3.example.com:82`.

The end-users can now access the Spam Quarantine on the new web interface in any one of the following ways:

- When `trailblazerconfig` CLI command is enabled, use the following URL -  
`https://example.com:<trailblazer-https-port>/euq-login.`  
 where `example.com` is the appliance host name and `<trailblazer-https-port>` is the trailblazer HTTPS port configured on the appliance.
- When `trailblazerconfig` CLI command is disabled, use the following URL -  
`https://example.com:<https-port>/euq-login.`  
 where `example.com` is the appliance host name and `<https-port>` is the HTTPS port configured on the appliance.



---

**Note** Local and externally-authenticated users cannot log into the end-user Spam Quarantine portal.

---

## Which Messages an End User Sees

Generally, end users see only their own messages in the spam quarantine.

Depending on the method of access (via notification or directly via web browser) and authentication method (LDAP or IMAP/POP), users may see mail for multiple email addresses in the spam quarantine.

When LDAP authentication is used, if the Primary Email attribute has multiple values in the LDAP directory, all of those values (addresses) will be associated with the user. Therefore, quarantined messages addressed to all email addresses associated with the end user in the LDAP directory are present in the quarantine.

If the authentication method is IMAP/POP, or the user accesses the quarantine directly via a notification, then the quarantine will display only messages for that user's email address (or the address to which the notification was sent).

For information about messages that are sent to aliases of which the user is a member, see [Recipient Email Mailing List Aliases and Spam Notifications](#), on page 943.

### Related Topics

- [Configuring End-User Access to the Spam Quarantine](#), on page 938
- [Recipient Email Mailing List Aliases and Spam Notifications](#), on page 943

## Notifying End Users About Quarantined Messages

You can configure the system to send a notification email to some or all users when they have spam and suspected spam messages in the spam quarantine.

By default, spam notifications lists the end user's quarantined messages. Notifications include a link that you can use to view the quarantined messages in the spam quarantine. You can then decide whether to have the quarantined messages delivered to the inbox or to delete them.



---



**Note** In cluster configurations, you can choose which users receive notifications only at the machine level.

---

### Before you begin

- For end users to manage messages listed in notifications, they must be able to access the spam quarantine. See [Configuring End-User Access to the Spam Quarantine](#) , on page 938.
- Understand and implement the authentication options for managing spam using notifications. See [Authentication Options for End Users Accessing Spam Management Features](#) , on page 936.
- If end users receive email at multiple aliases, see [Recipient Email Mailing List Aliases and Spam Notifications](#) , on page 943.

### Procedure

- 
- Step 1** [New Web Interface Only] On the appliance , click  to load the legacy web interface.
- Step 2** If you are on the legacy interface, navigate to **Management Appliance > Centralized Services > Spam Quarantine > Edit Settings**, and then scroll down to **Spam Notifications**. However if you are on the new web interface, navigate to Security Management appliance , click **Service Status**, hover over the  icon, and click **Edit Spam Notification Settings**. You will be redirected to the legacy interface.
- Step 3** Select **Enable Spam Notification**.
- Step 4** Enter a From: address for the notifications.
- Step 5** Specify the end-users whom you want to notify.
- Step 6** (Optional) Customize the subject for the notification.
- Step 7** (Optional) Customize the title for the notification.
- Step 8** Select the default language for notifications.
- Step 9** Configure the quarantine access for the end-users.
- a) Check the **Login without credentials** check box to automatically log users into the spam quarantine when they access it by clicking a link in a notification. The end-users can release messages by clicking the **Release** links in the notification. If you uncheck this option, the end-users cannot release messages by clicking the **Release** links in the notification.
- This option is visible only if you choose one of the following end-user authentication methods: Mailbox (IMAP/POP), LDAP, or SAML 2.0. If you have chosen None as the authentication method, when the end-users click on the links in the spam notification, they are automatically logged into the spam quarantine.
- b) Set an expiration period (in days) for the links in the notification. Enter a number between 0 and 365. These links will expire automatically after the specified period. Enter 0 if you do not want the links to expire.
- (For Mailbox (IMAP/POP), LDAP, and SAML 2.0) This option is configurable only if you check the **Login without credentials** check box.
- You can also set the expiration period using the **spamdigestconfig** command in the CLI.
- Step 10** Customize the message body:
- a) (Optional) Customize the default text and variables.
- To insert a variable, place the cursor where you would like the variable inserted and then click the name of the variable in the Message Variables listing on the right. Or type in the variable.
- The following message variables are expanded to the actual value for the specific end user:

- **New Message Count** ( %new\_message\_count% )— The number of new messages since the user last logged in.
- **Total Message Count** ( %total\_message\_count% )— The number of messages for the user in the spam quarantine.
- **Days Until Message Expires** ( %days\_until\_expire% )
- **Quarantine URL** ( %quarantine\_url% )— URL to log in to the quarantine and view messages.
- **Username** ( %username% )
- **New Message Table** ( %new\_quarantine\_messages% )— A list of the user’s new quarantined messages, showing sender, message subject, date, and a link to release the message. The user clicks a message subject to view the message in the spam quarantine.
- **New Message Table without Subject** ( %new\_quarantine\_messages\_no\_subject% ) — Similar to New Message Table, but only a “View Message” link is shown in place of the subject for each message.

- b) Choose whether to show or hide the links to view all the quarantined messages in a spam notification. Under **Show link to see all quarantined messages in Notification Mails**, choose **Yes** or **No** depending on your requirement.

(For Mailbox (IMAP/POP), LDAP, and SAML 2.0). This option is visible only if you check the **Login without credentials** check box (under Quarantine Access).

If you choose **Yes**, you can force the end-user to authenticate before accessing the spam quarantine. Check **Challenge Access**. This option is not available if you have chosen None as the end-user authentication method.

You can also show or hide the links using the **spamdigestconfig** command in the CLI.

- c) Click **Preview Message** to verify that the message is as you want it to be.

- Step 11** Select a message format (HTML, Text, or HTML/Text).
- Step 12** Specify the address to which bounced notifications will be sent.
- Step 13** (Optional) Select **Consolidate messages sent to the same LDAP user at different addresses**.
- Step 14** Set the notification schedule.
- Step 15** Submit and commit your changes.

---

### What to do next

To ensure that end users receive these notifications, consider recommending that they add the From: address for the spam quarantine notification emails to the “allowed list” in the junk mail settings of their mail application (such as Microsoft Outlook or Mozilla Thunderbird.)

### Related Topics

- [Recipient Email Mailing List Aliases and Spam Notifications](#) , on page 943
- [Testing Notifications](#), on page 943
- [Troubleshooting Spam Notifications](#) , on page 943

## Recipient Email Mailing List Aliases and Spam Notifications

Notifications can be sent to each Envelope Recipient that has quarantined email, including mailing lists and other aliases. Each mailing list receives a single digest. If you send notifications to a mailing list, all subscribers to the list will receive the notification. Users who belong to multiple email aliases, or who belong to LDAP groups that receive notifications, or who use several email addresses, may receive multiple spam notifications. The following table shows example situations in which users may receive multiple notifications.

**Table 92: Notifications per Address/Alias**

| User | Email Addresses                    | Aliases                                             | Notifications |
|------|------------------------------------|-----------------------------------------------------|---------------|
| Sam  | sam@example.com                    | —                                                   | 1             |
| Mary | mary@example.com                   | dev@example.com<br>qa@example.com<br>pm@example.com | 4             |
| Joe  | joe@example.com, admin@example.com | hr@example.com                                      | 3             |

If you use LDAP authentication, you can choose not to send notifications to mailing list aliases. Or, if you choose to send spam notifications to mailing list aliases, you can prevent some occurrences of multiple notifications. See [Spam Quarantine Alias Consolidation Queries](#), on page 790.

Users who access the spam quarantine by clicking a link in a notification will not see quarantined messages for any other aliases that the end-user may have, unless the appliance is using a spam quarantine alias consolidation query for email notifications. If the notification was sent to a distribution list that is expanded after processing by the appliance, then multiple recipients may have access to the same quarantine for that list.

This means that all subscribers to a mailing list will receive the notification and can log in to the quarantine to release or delete messages. In this case, end users visiting the quarantine to view messages mentioned in a notification may find that those messages have already been deleted by other users.



**Note** If you do not use LDAP and you do not want your end users to receive multiple email notifications, consider disabling notifications and instead allow end users to access the quarantine directly and authenticate via LDAP or POP/IMAP.

## Testing Notifications

You can test notifications by configuring a testing mail policy, and having spam quarantined for just a single user. Then, configure the spam quarantine notification settings: Select the **Enable Spam Notification** checkbox and do not select **Enable End-User Quarantine Access**. Then only the administrator configured in the **Deliver Bounced Messages To** field is notified of new spam in the quarantine.

## Troubleshooting Spam Notifications

### Related Topics

- [User Receives Multiple Notifications](#) , on page 944

- [Recipient Does Not Receive Notifications](#) , on page 944
- [User Receives Multiple Notifications](#) , on page 944
- [Recipient Does Not Receive Notifications](#) , on page 944

### User Receives Multiple Notifications

#### Problem

A user receives multiple spam notifications for a single message.

#### Solution

Possible causes:

- The user has multiple email addresses and the spam message was sent to more than one of those addresses.
- The user is a member of one or more email aliases that received the spam message. To minimize duplications, and for more information, see [Recipient Email Mailing List Aliases and Spam Notifications](#) , on page 943.

### Recipient Does Not Receive Notifications

#### Problem

Recipient is not receiving spam notifications.

#### Solution

- If notifications are being sent to the “Deliver Bounce Messages To:” address instead of to spam recipients, this means that spam notifications are enabled, but spam quarantine access is not enabled. See [Authentication Options for End Users Accessing Spam Management Features](#) , on page 936.
- Have the user check the junk mail settings of their email client.

## Managing Messages in the Spam Quarantine

This section explains how to work with messages in local or external spam quarantines.

Administrative users can see and manage all messages in the spam quarantine.

#### Related Topics

- [Accessing the Spam Quarantine \(Administrative Users\)](#), on page 944
- [Searching for Messages in the Spam Quarantine](#), on page 945
- [Viewing Messages in the Spam Quarantine](#), on page 945
- [Delivering Messages in the Spam Quarantine](#), on page 946
- [Deleting Messages from the Spam Quarantine](#), on page 946

## Accessing the Spam Quarantine (Administrative Users)

Administrative users can see and manage all messages in the spam quarantine.

### Procedure

---

- Step 1** [New Web Interface Only] Choose **Quarantine > Spam Quarantine > Search**.
- Step 2** Select **Monitor > Spam Quarantine**, then click the number in the Messages column.
- 

## Searching for Messages in the Spam Quarantine

### Procedure

---

- Step 1** Specify an envelope recipient.
- Note** You can enter a partial address.
- Step 2** Select whether the search results should match the exact recipient you entered, or whether the results should contain, start with, or end with your entry.
- Step 3** Enter a date range to search through. Click the calendar icons to select a date.
- Step 4** Specify a From: address, and select whether the search results should contain, match exactly, start with, or end with the value you entered.
- Step 5** Click **Search**. Messages matching your search criteria are displayed below the Search section of the page.
- 

### What to do next

#### Related Topics

[Searching Very Large Message Collections, on page 945](#)

## Searching Very Large Message Collections

If you have a very large collection of messages in the spam quarantine, and if your search terms are not narrowly defined, your query may take a very long time to return information, or it may time out.

You will be prompted to confirm whether you want to resubmit your search. Please note that having multiple large searches running simultaneously can impact performance.

## Viewing Messages in the Spam Quarantine

The message listing shows messages in the spam quarantine. You can select how many messages are shown at one time. You can sort the display by clicking on the column headings. Click the same column again to reverse the sorting.

Click the subject of a message to view the message, including the body and headers. The message is displayed in the Message Details page. The first 20K of the message is displayed. If the message is longer, it is truncated at 20K and you can download the message via the link at the bottom of the message.

From the Message Details page you can delete a message (select **Delete**) or select **Release** to release the message. Releasing a message causes it to be delivered.

To view additional details about the message, click the **Message Tracking** link.

Note the following:

- **Viewing Messages with Attachments**

When viewing a message that includes an attachment, the body of the message is displayed, followed by a list of attachments.

- **Viewing HTML Messages**

The spam quarantine attempts to render an approximation of HTML-based messages. Images are not displayed.

- **Viewing Encoded Messages**

Base64-encoded messages are decoded and then displayed.

## Delivering Messages in the Spam Quarantine

To release a message for delivery, click the checkbox next to the message or messages that you want to release and select **Release** from the drop-down menu. Then click **Submit**.

Click the checkbox in the heading row to automatically select all messages currently displayed on the page.

Released messages proceed directly to the destination queue, skipping any further work queue processing in the email pipeline.

## Deleting Messages from the Spam Quarantine

The spam quarantine can be configured to automatically delete messages after a certain amount of time. Also, the spam quarantine can be configured to automatically delete the oldest messages once the quarantine has reached its maximum size. You may also delete messages from the spam quarantine manually.

To delete specific messages, click the checkbox next to the messages that you want to delete and then select **Delete** from the drop-down menu. Then click **Submit**. Click the checkbox in the heading row to automatically select all of the messages currently displayed on the page.

To delete all messages in the spam quarantine, disable the quarantine (see [About Disabling the External Spam Quarantine](#), on page 947) and then click the **Delete All Messages** link. The number in parenthesis at the end of the link is the number of messages in the spam quarantine.

## Disk Space for the Spam Quarantine

By default, messages in the spam quarantine are automatically deleted after a set amount of time. If the quarantine gets full, older spam is deleted.

### Related Topics

- [Managing Disk Space](#), on page 1000



## About Disabling the External Spam Quarantine

If you disable the spam quarantine:

- If messages are present in the spam quarantine when it is disabled, you can opt to delete all of the messages.
- Any mail policies set to quarantine spam or suspected spam will instead be set to deliver the message. You may need to adjust mail policies .
- To completely disable an external spam quarantine, disable it on both the appliance and the Security Management appliance .

Disabling an external spam quarantine on the appliance only does not delete the external quarantine or its messages and data.

## Troubleshooting Spam Quarantine Features

- [Troubleshooting Safelists and Blocklists, on page 935](#)
- [Troubleshooting Spam Notifications , on page 943](#)
- [Ensuring That Message Text Displays Correctly , on page 924](#)





## CHAPTER 37

# Distributing Administrative Tasks

---

This chapter contains the following sections:

- [Working with User Accounts](#), on page 949
- [Managing Cisco Cloud Email Security](#), on page 954
- [Managing Custom User Roles for Delegated Administration](#), on page 957
- [Passphrases](#), on page 965
- [Configuring Access to the Email Security Appliance](#), on page 974
- [Displaying Messages to Administrative Users](#), on page 978
- [Managing Secure Shell \(SSH\) Keys](#), on page 979
- [Monitoring Administrative User Access](#), on page 981

## Working with User Accounts

The Cisco appliance provides two methods for adding user accounts: creating user accounts on the Cisco appliances itself, and enabling user authentication using your own centralized authentication system, which can be either an LDAP or RADIUS directory. You can manage users and connections to external authentication sources on the **System Administration > Users** page in the GUI (or by using the `userconfig` command in the CLI). For information about using an external directory to authenticate users, see [External Authentication](#), on page 970.

The default user account for the system, admin, has all administrative privileges. The admin user account cannot be deleted, but you can change the passphrase and lock the account.

When you create a new user account, you assign the user to a predefined or a custom user role. Each role contains differing levels of permissions within the system.

Although there is no limit to the number of user accounts that you can create on the appliance, you cannot create user accounts with names that are reserved by the system. For example, you cannot create the user accounts named “operator” or “root.”

# User Roles

Table 93: User Roles Listing

| User Role     | Description                                                                                                                                                                                                                                                                                                                                                                                                                                                                                                                                                                                                                                                                                                                           |
|---------------|---------------------------------------------------------------------------------------------------------------------------------------------------------------------------------------------------------------------------------------------------------------------------------------------------------------------------------------------------------------------------------------------------------------------------------------------------------------------------------------------------------------------------------------------------------------------------------------------------------------------------------------------------------------------------------------------------------------------------------------|
| admin         | <p>The admin user is the default user account for the system and has all administrative privileges. The admin user account is listed here for convenience, but it cannot be assigned via a user role, and it cannot be edited or deleted, aside from changing the passphrase.</p> <p>Only the admin user can issue the <b>resetconfig</b> and revert commands.</p>                                                                                                                                                                                                                                                                                                                                                                    |
| Administrator | <p>User accounts with the Administrator role have full access to all configuration settings of the system. However, only the admin user has access to the <b>resetconfig</b> and <b>revert</b> commands.</p> <p><b>Note</b> AsyncOS does not support multiple administrators configuring the appliance from the GUI simultaneously.</p>                                                                                                                                                                                                                                                                                                                                                                                               |
| Technician    | <p>User accounts with the Technician role can perform system upgrades, reboot the appliance, and manage feature keys. Technicians can also perform the following actions in order to upgrade the appliance:</p> <ul style="list-style-type: none"> <li>• Suspend email delivery and receiving.</li> <li>• View status of workqueue and listeners.</li> <li>• Save and email configuration files.</li> <li>• Back up safelists and blocklists. Technicians cannot restore these lists.</li> <li>• Disconnect the appliance from a cluster.</li> <li>• Enable or disable remote service access for Cisco technical support.</li> <li>• Raise a support request.</li> </ul>                                                              |
| Operator      | <p>User accounts with the Operator role are restricted from:</p> <ul style="list-style-type: none"> <li>• Creating or editing user accounts.</li> <li>• Issuing the <b>resetconfig</b> command.</li> <li>• Upgrading the appliance.</li> <li>• Issuing the <b>systemsetup</b> command or running the System Setup Wizard.</li> <li>• Issuing the <b>adminaccessconfig</b> command.</li> <li>• Performing some quarantine functions (including creating, editing, deleting, and centralizing quarantines).</li> <li>• Modifying LDAP server profile settings other than username and passphrase, if LDAP is enabled for external authentication.</li> </ul> <p>Otherwise, they have the same privileges as the Administrator role.</p> |
| Guest         | <p>Users accounts with the Guest role can only view status information and reports. Users with the Guest role can also manage messages in quarantines, if access is enabled in a quarantine. Users with the Guest role cannot access Message Tracking.</p>                                                                                                                                                                                                                                                                                                                                                                                                                                                                            |

| User Role          | Description                                                                                                                                                                                                                                                                                                                                                                                                                                                                                                                                                                                                                                      |
|--------------------|--------------------------------------------------------------------------------------------------------------------------------------------------------------------------------------------------------------------------------------------------------------------------------------------------------------------------------------------------------------------------------------------------------------------------------------------------------------------------------------------------------------------------------------------------------------------------------------------------------------------------------------------------|
| Read-Only Operator | <p>User accounts with the Read-Only Operator role have access to view configuration information. Users with the Read-Only Operator role can make and submit changes to see how to configure a feature, but they cannot commit them. Users with this role can manage messages in quarantines, if access is enabled in a quarantine.</p> <p>Users with this role cannot access the following:</p> <ul style="list-style-type: none"> <li>• File system, FTP, or SCP.</li> <li>• Settings for creating, editing, deleting, or centralizing quarantines.</li> </ul>                                                                                  |
| Help Desk User     | <p>User accounts with the Help Desk User role are restricted to:</p> <ul style="list-style-type: none"> <li>• Message tracking.</li> <li>• Managing messages in quarantines.</li> </ul> <p>Users with this role cannot access to the rest of the system, including the CLI. You need to enable access in each quarantine before a user with this role can manage them.</p>                                                                                                                                                                                                                                                                       |
| Custom user role   | <p>User accounts with a custom user role can only access email security features assigned to the role. These features can be any combination of DLP policies, email policies, reports, quarantines, local message tracking, encryption profiles, and the Trace debugging tool Trace debugging tool, . The users cannot access system configuration features, including enabling features globally. Only administrators can define custom user roles. See <a href="#">Managing Custom User Roles for Delegated Administration, on page 957</a> for more information.</p> <p><b>Note</b> Users assigned to custom roles cannot access the CLI.</p> |
| Cloud Roles        | <p>The Cloud Email Security appliance uses a set of user roles designed specifically for the Cloud environment. For information about the roles defined for Cloud users, see <a href="#">Managing Cisco Cloud Email Security , on page 954</a>.</p>                                                                                                                                                                                                                                                                                                                                                                                              |

All roles defined in the above table can access both the GUI and the CLI, except the Help Desk User role and custom user roles, which can only access the GUI.

If you use an LDAP directory to authenticate users, you assign directory groups to user roles instead of individual users. When you assign a directory group to a user role, each user in that group receives the permissions defined for the user role. For more information, see [External Authentication, on page 970](#).

### Related Topics

- [Managing Users, on page 951](#)

## Managing Users

The Users page lists the existing users for the system, including the username, full name, and user type or group.

From the Users page, you can:

- Add new users. For more information, see [Adding Users , on page 952](#).

- Delete users. For more information, see [Deleting Users, on page 953](#).
- Edit users, such as changing a user's passphrase and locking and unlocking a user's account. For more information, see [Editing Users, on page 952](#).
- Force users to change their passphrases. See [Force Users To Change Their Passphrases, on page 953](#).
- Configure user account and passphrase settings for local accounts. For more information, see [Configuring Restrictive User Account and Passphrase Settings, on page 966](#).
- Enable the appliance to use an LDAP or RADIUS directory to authenticate users. For more information, see [External Authentication, on page 970](#).
- Enable access for non-administrators to DLP Matched Content in Message Tracking. See [Controlling Access to Sensitive Information in Message Tracking, on page 953](#) for more information.

### Related Topics

[Managing Cisco Cloud Email Security , on page 954](#)

## Adding Users

### Before You Begin

- Determine the user roles you will use.
  - For descriptions of predefined user roles, see [User Roles , on page 950](#).
  - To create custom roles, see [Managing Custom User Roles for Delegated Administration, on page 957](#).
- Specify your passphrase requirements. See [Configuring Restrictive User Account and Passphrase Settings, on page 966](#).

### Procedure

---

- Step 1** Choose **System Administration > Users**.
  - Step 2** Click **Add User**.
  - Step 3** Enter a login name for the user. Some words are reserved (such as “operator” or “root”).
  - Step 4** Enter the user's full name.
  - Step 5** Select a predefined or custom user role.
  - Step 6** Enter a passphrase.
  - Step 7** Submit and commit your changes.
- 

## Editing Users

Use this procedure to change a passphrase, etc.

### Procedure

---

- Step 1** Choose **System Administration > Users**.
  - Step 2** Click the user's name in the Users listing.
  - Step 3** Make changes to the user.
  - Step 4** Submit and commit your changes.
- 

## Force Users To Change Their Passphrases

### Procedure

---

- Step 1** Choose **System Administration > Users**.
  - Step 2** Select the users from the Users listing.
  - Step 3** Click **Enforce Passphrase Change**.
  - Step 4** Choose whether the users must change the passphrase during the next login or after a specified duration (in days).
  - Step 5** (Optional) If you are enforcing a passphrase change after a specified duration, set the grace period (in days) to reset the passphrase after the passphrase expires.
  - Step 6** Click **OK**.
  - Step 7** Submit and commit your changes.
- 

## Deleting Users

### Procedure

---

- Step 1** Click the trash can icon corresponding to the user's name in the Users listing.
  - Step 2** Confirm the deletion by clicking **Delete** in the warning dialog that appears.
  - Step 3** Commit your changes.
- 

## Controlling Access to Sensitive Information in Message Tracking

You may want to restrict administrative access to message details that are likely to include sensitive information:

- Messages that violate Data Loss Prevention (DLP) policies may include information such as corporate confidential information or personal information including credit card numbers and health records. By default, this content is visible to all users who have access to the appliance .
- URLs that are caught by outbreak filters or by content filters that are based on URL reputation or category may also be considered sensitive. By default, only users with Administrator privileges can view this content.

This sensitive content appears in dedicated tabs on the Message Details page for messages listed in Message Tracking results.

You can hide these tabs and their content from administrative users based on their user role. However, although there is an option to hide this sensitive content from users who have the Administrator role, any user with the Administrator role (including cloud administrator users) can change these permissions and thus view sensitive information at any time.

### Before You Begin

Ensure that you have met the prerequisites for these features. See [Displaying URL Details in Message Tracking](#), on page 439.

### Procedure

---

- Step 1** Go to the **System Administration > Users** page.
  - Step 2** Under **Access to Sensitive Information in Message Tracking**, click **Edit Settings**.
  - Step 3** Select the roles for which you want to grant access to each type of sensitive information.  
Custom roles without access to Message Tracking can never view this information and thus are not listed.
  - Step 4** Submit and commit your changes.
- 

### What to do next

#### Related Topics

- [Message Tracking Details](#), on page 894
- [Displaying Sensitive DLP Data in Message Tracking](#), on page 511
- [Displaying URL Details in Message Tracking](#), on page 439

## Managing Cisco Cloud Email Security

When managing your Cisco IronPort Cloud Email Security service, there are certain administrative tasks performed by a Cisco security expert, and there are administrative tasks that can be performed by members of your organization. To meet the needs of the Cloud Email Security users at your organization, the Cloud Email Security service includes the following cloud-based roles:



Table 94: Cloud User Roles Listing

| Cloud User Role     | Description                                                                                                                                                                                                                                                                                                                                                                                                                                                                                                                                                                                                                                                                                                                                                                                                                                                                      |
|---------------------|----------------------------------------------------------------------------------------------------------------------------------------------------------------------------------------------------------------------------------------------------------------------------------------------------------------------------------------------------------------------------------------------------------------------------------------------------------------------------------------------------------------------------------------------------------------------------------------------------------------------------------------------------------------------------------------------------------------------------------------------------------------------------------------------------------------------------------------------------------------------------------|
| Cloud Administrator | <p>The Cloud Administrator role is a special administrator role created for Cloud Email Security, designed to allow access to specific administrative tasks specific to the role of a Cloud administrator. The role has many of the same privileges as an on-premises Administrator, but is restricted from activities that may interfere with the proper running of the Cloud Email Security service, such as shutting down the device, running installations, or updating the device.</p> <p>More than one user can be assigned the Cloud Administrator role. By default, at least one user is assigned this role upon provisioning.</p> <p><b>Note</b> The Cloud Administrator is the only Cloud user role that can access the CLI. Other Cloud users have access to the GUI only.</p> <p>For more information, see <a href="#">The Cloud Administrator, on page 956</a>.</p> |
| Cloud Operator      | <p>User account for a Cloud Operator with limited administrative rights. This user has full access to Mail Policy, DLP Policy, reports, message tracking, the debug trace feature, and the spam and system quarantines.</p> <p>Access to the IronPort Spam Quarantine and system quarantines must be enabled before a user with this role can manage them.</p> <p>For more information, see <a href="#">The Cloud Operator, on page 957</a>.</p>                                                                                                                                                                                                                                                                                                                                                                                                                                 |
| Cloud DLP Admin     | <p>User account for a Cloud user whose function is to administer DLP policies. This user has full access to DLP Policy administration.</p> <p>For more information, see <a href="#">Cloud DLP Admin, on page 957</a>.</p>                                                                                                                                                                                                                                                                                                                                                                                                                                                                                                                                                                                                                                                        |
| Cloud Help Desk     | <p>User account for a Cloud Help Desk User. This user has full access to message tracking, and the spam and system quarantines.</p> <p>Access to the IronPort Spam Quarantine and system quarantines must be enabled before a user with this role can manage them.</p> <p>For more information, see <a href="#">Cloud Help Desk, on page 957</a>.</p>                                                                                                                                                                                                                                                                                                                                                                                                                                                                                                                            |
| Cloud Guest         | <p>User account for a Cloud guest who may want to run reports or access the IronPort spam quarantine and system quarantine. This user has full access to reporting and the quarantines.</p> <p>Access to the IronPort Spam Quarantine and system quarantines must be enabled before a user with this role can manage them.</p> <p>For more information, see <a href="#">Cloud Guest, on page 957</a>.</p>                                                                                                                                                                                                                                                                                                                                                                                                                                                                        |
| Custom user role    | <p>User accounts with a custom user role can only access email security features assigned to the role. These features can be any combination of DLP policies, email policies, reports, quarantines, local message tracking, encryption profiles, and the Trace debugging tool. The users cannot access system configuration features. Only Cloud administrators can define custom user roles. See <a href="#">Managing Custom User Roles for Delegated Administration, on page 957</a> for more information.</p>                                                                                                                                                                                                                                                                                                                                                                 |

## The Cloud Administrator

The Cloud Administrator role is designed to allow members of your organization to perform some administrative functions for the Cloud Email Security service, but it has restricted administrative rights to prevent interference with the tasks handled by Cisco email security experts.

A Cisco email security expert is responsible for making network interface changes, changing security service update settings, starting and shutting down the device, managing clusters, and maintaining and updating configurations.

User accounts with the Cloud Administrator role can perform the following administrative tasks:

- Creating or modifying users belonging to the Cloud Administrator role
- Creating and modifying custom user roles (with limited privileges)
- Creating and resetting passwords (but not modify password policy)
- User management, such as creating new users and locking and unlocking accounts
- Accessing and running reports and tracking messages
- Creating mail policies and content filters
- Creating and modifying DLP policies
- Running the trace debugging tool
- Configuring and modifying encryption profiles
- Accessing the system quarantine and the IronPort Spam quarantine
- Saving, modifying and loading the Safelist/Blocklist file

The Cloud Administrator role is restricted from performing a select group of administrative tasks:

- Modifying Network interface settings (including routes and certificates)
- Shutting down and rebooting the device
- Applying software upgrades to the device
- Disabling clustering and adding or deleting devices to a cluster
- Creating or deleting an Administrator
- Changing security service update settings
- Loading configuration files or resetting the configurations
- Modifying External Authentication settings
- Modifying scheduled reports settings
- Modifying alert settings
- Modifying password account policy, such as password strength settings
- Running System Setup wizards

When using external authentication, if a user's group is mapped to the Cloud Administrator role, the user is assigned the privileges of a Cloud Administrator.

## The Cloud Operator

The Cloud Operator role has full access to Mail Policy, DLP Policy, reports, message tracking, the debug trace feature, and the spam and system quarantines.

The Operator role is designed to have many of same privileges as the Cloud Administrator role, but is restricted from the following activities:

- Creating or editing user accounts.
- Performing some quarantine functions (including creating and deleting quarantines).

## Cloud DLP Admin

The Cloud DLP Admin role is designed to allow a user full access to the DLP Policies. This user has full access to all DLP policies on the appliance, including the ability to create new policies. The DLP manager can also reorder the DLP policies in the DLP Policy manager.

For more details about data loss prevention, see [Data Loss Prevention, on page 485](#).

## Cloud Help Desk

The Cloud Help Desk role is designed to allow a user full access to message tracking, and the spam and system quarantines in order to support end-users. The Cloud Help Desk user can view and take actions on assigned quarantines, such as releasing or deleting messages, but cannot change the quarantine's configuration, such as the size of the quarantine, retention period, and they cannot create or delete quarantines.

## Cloud Guest

This account is designed for a user who wants to track information, but does not necessarily need to modify the infrastructure configuration. The Cloud guest account has full access to reporting and to system and spam quarantines. The Cloud Guest user can view and take actions in assigned quarantines, such as releasing or deleting messages, but cannot change the quarantine's configuration, such as the size of the quarantine, retention period, and they cannot create or delete quarantines.

Access to the IronPort Spam Quarantine and system quarantines must be enabled before a user with this role can manage them.

## Managing Custom User Roles for Delegated Administration

You can design custom user roles and delegate specific responsibilities to users that align with their roles within your organization, allowing these *delegated administrators* access only to the email security features they are responsible for and not the system configuration features that are not related to their roles. Delegated administration provides more flexible control over your users' access to the email security features on the appliance than the predefined administrator, operator, and help desk user roles.

For example, you may have users who are responsible for managing mail policies for specific domains on the appliance, but you do not want these users to access the system administration and security services configuration features, which the predefined administrator and operator roles grant. You can create a custom user role for mail policy administrators who can grant these users access to the mail policies they manage, along with other email security features that they can use to manage messages processed by these policies, such as Message Tracking and policy quarantines.

Use the **System Administration > User Roles** page in the GUI (or the `userconfig -> role` command in the CLI) to define custom user roles and manage the email security features for which they are responsible, such as mail policies, DLP policies, email reports, and quarantines. For a full list of email security features that delegated administrators can manage, see [Assigning Access Privileges, on page 959](#). Custom roles can also be created when adding or editing a local user account using the **System Administration > Users** page. See [Defining a Custom User Role When Adding a User Account, on page 963](#) for more information.

You should make sure when creating a custom user role so that its responsibilities don't overlap too much with the responsibilities of other delegated administrators. If multiple delegated administrators are responsible for the same content filter, for example, and use the content filter in different mail policies, the changes made to the filter by one delegated administrator may cause unintended side effects for the mail policies managed by other delegated administrators.

When you have created the custom user roles, you can assign local users and external authentication groups to them like any other user role. See [Working with User Accounts, on page 949](#) for more information. Please note that users assigned to custom roles cannot access the CLI.

### Related Topics

- [Account Privileges Page, on page 958](#)
- [Assigning Access Privileges, on page 959](#)
- [Defining a Custom User Role, on page 963](#)
- [Defining a Custom User Role When Adding a User Account, on page 963](#)
- [Updating Responsibilities for a Custom User Role, on page 964](#)
- [Editing a Custom User Role, on page 964](#)
- [Duplicating a Custom User Role, on page 964](#)
- [Deleting a Custom User Role, on page 965](#)

## Account Privileges Page

When a delegated administrator logs into the appliance, the Account Privileges page displays links to the security features for which the delegated administrator is responsible and brief descriptions of their access privileges. A delegated administrator can return to this page by selecting Account Privileges in the Options menu. Delegated administrators can also access the features that they manage using the menu at the top of the web page.

The following figure shows an Account Privileges page for a delegated administrator with access to mail policies, email reporting, message tracking, and quarantines.

Figure 72: Account Privileges Page for a Delegated Administrator

| Account Privileges (bob1) |                                                                                                                                                                                              |
|---------------------------|----------------------------------------------------------------------------------------------------------------------------------------------------------------------------------------------|
| <b>Mail Policies</b>      | Incoming Mail Policies (1)<br>Incoming Content Filters (1)<br>Outgoing Mail Policies (1)<br>Outgoing Content Filters (None Assigned)<br><i>Configure Email Policies and Content Filters.</i> |
| <b>Email Reporting</b>    | Policy Reporting and DLP Reporting<br><br><i>View and analyze email traffic.</i>                                                                                                             |
| <b>Message Tracking</b>   | Message Tracking<br><br><i>Track messages.</i>                                                                                                                                               |
| <b>Quarantine</b>         | Manage Message Quarantines (1)<br><br><i>Manage messages in assigned Quarantines.</i>                                                                                                        |

## Assigning Access Privileges

When creating a custom user role, you define the levels of access to the security features for which delegated administrators are responsible.

The security features available for delegated administrators to manage are:

- Incoming and outgoing mail policies and content filters.
- Data Loss Prevention (DLP) policies.
- Email reporting.
- Message Tracking.
- The Trace debugging tool.
- Spam, policy, virus, and outbreak quarantines.
- Cisco Email Encryption profiles.

After defining the access levels for a custom user role, you need to assign the specific mail policies, content filters, DLP policies, quarantines, or encryption profiles for which the delegated administrators will be responsible.

For example, you can create two different DLP policy administrator roles that are responsible for different DLP policies. One role is only responsible for DLP violations related to company confidentiality and acceptable use, while the other is responsible for DLP violations related to privacy protection. In addition to DLP policies access, these custom user roles can also be assigned privileges for tracking message data and viewing quarantines and reports. They can search for DLP violations related to the policies that they are responsible for in using Message Tracking.

You can view which responsibilities are available to assign to a custom user role by clicking on the links for the assigned privileges in the Custom User Roles for Delegated Administration table on the User Roles page. See [Updating Responsibilities for a Custom User Role](#), on page 964.

### Related Topics

- [Mail Policies and Content Filters](#), on page 960
- [DLP Policies](#), on page 961
- [Email Reporting](#), on page 961

- [Message Tracking, on page 962](#)
- [Trace, on page 962](#)
- [Quarantines, on page 962](#)
- [Encryption Profiles, on page 963](#)

## Mail Policies and Content Filters

The Mail Policies and Content Filters access privileges define a delegated administrator's level of access to the incoming and outgoing mail policies and content filters on the appliance. You can assign specific mail policies and content filters to a custom user role, allowing only the delegated administrators belonging to this role, along with operators and administrators, to manage the mail policies and content filters.

All delegated administrators with this access privilege can view the default incoming and outgoing mail policies but they can only edit these policies if they have full access.

All delegated administrators with access privileges can create new content filters to use with their mail policies. A content filter created by a delegated administrator is available to the other delegated administrators assigned to the custom user role. Content filters that are not assigned to any custom user role are public and can be viewed by all delegated administrators with the mail policy access privilege. Content filters created by operators and administrators are *public* by default. Delegated administrators can enable or disable any existing content filters on mail policies assigned to their custom user role, but they cannot modify or delete public content filters.

If a delegated administrator deletes a content filter used by mail policies other than their own, or if the content filter is assigned to other custom user roles, AsyncOS does not delete the content filter from the system. AsyncOS instead unlinks the content filter from the custom user role and removes it from the delegated administrator's mail policies. The content filter remains available to other custom user roles and mail policies.

Delegated administrators can use any text resource or dictionary in their content filters, but they cannot access the Text Resources or Dictionaries pages in the GUI to view or modify them. Delegated administrators also cannot create new text resources or dictionaries.

For outgoing mail policies, delegated administrators can enable or disable DLP policies but they cannot customize the DLP settings unless they also have DLP policy privileges.

You can assign one of the following access levels for mail policies and content filters to a custom user role:

- **No access:** Delegated administrators cannot view or edit mail policies and content filters on the appliance.
- **View assigned, edit assigned:** Delegated administrators can view and edit the mail policies and content filters assigned to the custom user role and create new content filters. Delegated administrators can edit a policy's Anti-Spam, Anti-Virus, and Outbreak Filters settings. They can enable their content filters for the policy, as well as disable any existing content filter assigned to the policy, regardless of whether they are responsible for it. Delegated administrators cannot modify a mail policy's name or its senders, recipients, or groups. Delegated administrators can modify the order of the content filters for mail policies assigned to their custom user role.
- **View all, edit assigned:** Delegated administrators can view all mail policies and content filters on the appliance, but they can only edit the ones assigned to the custom user role.

**View all, edit all (full access):** Delegated administrators have full access to all of the mail policies and content filters on the appliance, including the default mail policies, and have the ability to create new mail policies. Delegated administrators can modify the senders, recipients, and groups of all mail policies. They can also reorder mail policies.

You can assign individual mail policies and content filters to the custom user role using either the Email Security Manager or the Custom User Roles for Delegated Administration table on the User Roles page.

See [Updating Responsibilities for a Custom User Role](#) , on page 964 for information on using the Custom User Roles for Delegated Administration table to assign mail policies and content filters.

## DLP Policies

The DLP Policies access privileges define a delegated administrator's level of access to the DLP policies via the DLP Policy Manager on the appliance . You can assign DLP policies to specific custom user roles, allowing delegated administrators, in addition to operators and administrators, to manage these policies. Delegated administrators with DLP access can also export DLP configuration files from the Data Loss Prevention Global Settings page.

If a delegated administrator also has mail policy privileges, they can customize the DLP policies. Delegated administrators can use any custom DLP dictionary for their DLP policies, but they cannot view or modify the custom DLP dictionaries.

You can assign one of the following access levels for DLP policies to a custom user role:

- **No access:** Delegated administrators cannot view or edit DLP policies on the appliance .
- **View assigned, edit assigned:** Delegated administrators can use the DLP Policy Manager to view and edit the DLP policies assigned to the custom user role. Delegated administrators cannot rename or reorder DLP policies in the DLP Policy Manager. Delegated administrators can export DLP configurations.
- **View all, edit assigned:** Delegated administrators can view and edit the DLP policies assigned to the custom user role. They can export DLP configurations. They can also view all DLP policies that are not assigned to the custom user role but they cannot edit them. Delegated administrators cannot reorder DLP policies in the DLP Policy Manager or rename the policy.
- **View all, edit all (full access):** Delegated administrators have full access to all of the DLP policies on the appliance , including the ability to create new ones. Delegated administrators can reorder DLP policies in the DLP Policy Manager. They cannot change the DLP mode that the appliance uses.

You can assign individual DLP policies to the custom user role using either the DLP Policy Manager or the Custom User Roles for Delegated Administration table on the User Roles page.

See [Data Loss Prevention](#), on page 485 for more information on DLP policies and the DLP Policy Manager.

See [Updating Responsibilities for a Custom User Role](#) , on page 964 for information on using the Custom User Roles for Delegated Administration list to assign DLP policies.

## Email Reporting

The Email Reporting access privileges define which reports and Email Security Monitor pages a delegated administrator can view, depending on the custom user role's access to mail policies, content filters, and DLP policies. These reports are not filtered for assigned policies; delegated administrators can view reports for mail and DLP policies that for which they are not responsible.

You can assign one of the following access levels for email reporting to a custom user role:

- **No access:** Delegated administrators cannot view reports on the appliance .
- **View relevant reports:** Delegated administrators can view reports on the Email Security Monitor pages related to their Mail Policies and Content Filters and DLP Policies access privileges. Delegated administrators with Mail Policies and Content Filters access privileges can view the following Email Security Monitor pages:
  - Overview

- Incoming Mail
- Outgoing Destinations
- Outgoing Senders
- Internal Users
- Content Filters
- Virus Outbreaks
- Virus Types
- Archived Reports

Delegated administrators with DLP Policies access privileges can view the following Email Security Monitor pages:

- Overview
  - DLP Incidents
  - Archived Reports
- **View all reports:** Delegated administrators can view all reports and Email Security Monitor pages on the appliance .

See the [Using Email Security Monitor, on page 807](#) chapter for more information on email reporting and the Email Security Monitor.

## Message Tracking

The Message Tracking access privileges define whether delegated administrators assigned to the custom user role have access to Message Tracking, including message content that may violate your organization's DLP policies if the DLP Tracking Policies option has been enabled on the **System Administration > Users** page and the custom user role also has DLP policies access privileges.

Delegated administrators can only search for the DLP violations for the DLP policies assigned to them.

See [Tracking Messages, on page 887](#) for more information on Message Tracking.

See [Controlling Access to Sensitive Information in Message Tracking, on page 953](#) for information for allowing delegated administrators access to viewing matched DLP content in Message Tracking.

## Trace

The Trace access privileges define whether delegated administrators assigned to the custom user role can use Trace to debug the flow of messages through the system. Delegated administrators with access can run Trace and view all of the generated output. Trace results are not filtered based on the delegated administrator's mail or DLP policy privileges.

See [Debugging Mail Flow Using Test Messages: Trace, on page 1213](#) for more information on using Trace.

## Quarantines

The Quarantines access privileges define whether delegated administrators can manage assigned quarantines. Delegated administrators can view and take actions on any message in an assigned quarantine, such as releasing or deleting messages, but cannot change the quarantine's configuration (e.g. the size, retention period, etc.), or create or delete quarantines.

You can assign any of the quarantines to the custom user role using either the Monitor > Quarantines page or the Custom User Roles for Delegated Administration table on the User Roles page.



See [About Distributing Message Processing Tasks to Other Users](#) , on page 908 and [Configuring Administrative User Access to the Spam Quarantine](#) , on page 923 for more information on assigning Quarantine management tasks to administrative users.

See [Updating Responsibilities for a Custom User Role](#) , on page 964 for information on using the Custom User Roles for Delegated Administration list to assign quarantines.

## Encryption Profiles

The Encryption Profiles access privileges define whether delegated administrators can use encryption profiles assigned to their custom user role when editing content filters or DLP policies. Encryption profiles can only be assigned to custom user roles with mail or DLP policy access privileges. Encryption profiles that are not assigned to a custom role are available for use by all delegated administrators with mail or DLP policy privileges. Delegated administrators cannot view or modify any encryption profiles.

You can assign encryption profiles when creating or editing an encryption profile using the Security Services > IronPort Email Encryption page.

## Defining a Custom User Role

User the User Roles page in the GUI (or the `userconfig -> role` command in the CLI) to define a new user role and assign its access privileges. The User Roles page displays all existing custom user roles on the appliance and the access privileges for each role.

### Procedure

---

- Step 1** Choose **System Administration > User Roles**.
  - Step 2** Click **Add User Role**.
  - Step 3** Enter a name for the user role.
  - Step 4** Enter a description of the user role and its privileges.
  - Step 5** Select the user role's access privileges. (See [Assigning Access Privileges](#), on page 959 for more information on each type of access privilege.)
  - Step 6** Submit and commit your changes.
- 

## Defining a Custom User Role When Adding a User Account

You can create a new custom user role when adding or editing a local user account on the appliance .

See [Managing Users](#), on page 951 for more information on adding a user account.

### Procedure

---

- Step 1** Go to the **System Administration > Users** page.
- Step 2** Click **Add User**.
- Step 3** When creating the user account, select Custom Roles.
- Step 4** Select **Add Role**.

- Step 5** Enter the name for the new role.
- Step 6** Submit the new user account.
- AsyncOS displays a notification that the new user account and custom user role have been added.
- Step 7** Go to the **System Administration > User Roles** page.
- Step 8** Click on the name of the custom user role in the Custom User Roles for Delegated Administration table.
- Step 9** Enter a description of the user role and its privileges.
- Step 10** Select the user role's access privileges. (See [Assigning Access Privileges, on page 959](#) for more information on each type of access privilege.)
- Step 11** Submit and commit your changes.
- 

## Updating Responsibilities for a Custom User Role

### Procedure

---

- Step 1** Go to the **System Administration > User Roles** page.
- Step 2** Click the name of the access privilege for the custom user role you want to update.
- AsyncOS displays a list of all the mail policies, content filters, DLP policies, or quarantines available on the appliance, along with the names of any other assigned custom user roles.
- Step 3** Select the mail policies, content filters, DLP policies, or quarantines for which you want the delegated administrators assigned to be responsible.
- Step 4** Submit and commit your changes.
- 

## Editing a Custom User Role

### Procedure

---

- Step 1** Go to the **System Administration > User Roles** page.
- Step 2** Click the user role's name in the Custom User Roles for Delegated Administration listing.
- Step 3** Make changes to the user role.
- Step 4** Submit and commit your changes.
- 

## Duplicating a Custom User Role

You may want to create multiple custom user roles with similar access privileges but assign different responsibilities to different sets of users. For example, if the appliance handles messages for multiple domains, you may want to create custom user roles with similar access rights but for different mail policies based on

the domain. This allows delegated administrators to manage mail policies for their domains without interfering with the responsibilities of other delegated administrators.

### Procedure

---

- Step 1** Go to the **System Administration > User Roles** page.
  - Step 2** Click the duplicate icon corresponding to the user role you want to duplicate in the Custom User Roles for Delegated Administration listing.
  - Step 3** Change the name of the custom user role.
  - Step 4** Make any access privilege changes required for the new custom user role.
  - Step 5** Submit and commit your changes.
- 

## Deleting a Custom User Role

When a custom role is deleted, users become unassigned and do not have access to the appliance . If you delete a custom user role that is assigned to one or more users, you do not receive a warning message. You should reassign any users that were assigned to the custom user role that you deleted.

### Procedure

---

- Step 1** Go to the **System Administration > User Roles** page.
  - Step 2** Click the trash can icon corresponding to the user role you want to delete in the Custom User Roles for Delegated Administration list.
  - Step 3** Confirm the deletion by clicking **Delete** in the warning dialog that appears.
  - Step 4** Commit your changes.
- 

## Passphrases

- [Changing Your Passphrase, on page 965](#)
- [Locking and Unlocking a User Account, on page 966](#)
- [Configuring Restrictive User Account and Passphrase Settings, on page 966](#)
- [External Authentication, on page 970](#)

## Changing Your Passphrase

Administrative users can change their own passphrases via the Options > Change Passphrase link at the top of the GUI.

As soon as you submit a new passphrase, you are logged out and taken to the log in screen.

In the CLI, use the `passwd` or `passwd` command to change your passphrase. If you forget the passphrase for the admin user account, contact your customer support provider to reset the passphrase.

The `passwd` command requires you to enter the old passphrase for security.



---

**Note** Changes to the passphrase take effect immediately and do not require you commit the change.

---

## Locking and Unlocking a User Account

Locking a user account prevents a local user from logging into the appliance. A user account can be locked in one of the following ways:

- AsyncOS locks a user account if the user exceeded the maximum number of failed login attempts defined in the Local User Account & Passphrase Settings section.
- Administrators can manually lock user accounts for security purposes using the System Administration > Users page.

AsyncOS displays the reason why the user account was locked when you view the user account on the Edit User page.

To unlock a user account, open the user account by clicking on the user name in the Users listing and click **Unlock Account**.

To manually lock a local user account, open the user account by clicking on the user name in the Users listing and click **Lock Account**. AsyncOS displays a message saying that the user will be unable to log into the appliance and asks if you want to continue.

You can also configure all local user accounts to lock after users fail to login successfully after a configured number of attempts. For more information, see [Configuring Restrictive User Account and Passphrase Settings, on page 966](#).



---

**Note** If you lock the admin account, you can only unlock it by logging in as the admin through a serial communications connection to the serial console port. The admin user can always access the appliance using the serial console port, even when the admin account is locked. See [Connecting to the Appliance, on page 25](#) for more information on accessing the appliance using the serial console port.

---

## Configuring Restrictive User Account and Passphrase Settings

You can define user account and passphrase restrictions to enforce organizational passphrase policies. The user account and passphrase restrictions apply to local users defined on the appliance. You can configure the following settings:

- **User account locking.** You can define how many failed login attempts cause the user to be locked out of the account.
- **Passphrase lifetime rules.** You can define how long a passphrase can exist before the user is required to change the passphrase after logging in.
- **Passphrase rules.** You can define what kinds of passphrases users can choose, such as which characters are optional or mandatory.

You define user account and passphrase restrictions on the System Administration > Users page in the Local User Account & Passphrase Settings section.

## Cloud User Accounts

Cloud user accounts have pre-configured password settings that cannot be changed by a Cloud Administrator. The following password settings are configured for cloud users:

- Users must change their passwords on the first login.
- Users must change their passwords every 6 months.
- The password must contain a minimum of eight characters; and the password must include one uppercase character (A-Z), one lowercase character (a-z), one numeric character (1-9) and one special character (such as @\$%).

### Procedure

- Step 1** Choose **System Administration > Users**.
- Step 2** Scroll to the **Local User Account & Passphrase Settings** section.
- Step 3** Click **Edit Settings**.
- Step 4** Configure the settings as described below.

| Setting           | Description                                                                                                                                                                                                                                                                                                                                                                                                                                                                                                                                                                                                                                                                                                                                                                                                                                                                                                                                                                                                                                                                                                                                                                                                                                                                                                                                                       |
|-------------------|-------------------------------------------------------------------------------------------------------------------------------------------------------------------------------------------------------------------------------------------------------------------------------------------------------------------------------------------------------------------------------------------------------------------------------------------------------------------------------------------------------------------------------------------------------------------------------------------------------------------------------------------------------------------------------------------------------------------------------------------------------------------------------------------------------------------------------------------------------------------------------------------------------------------------------------------------------------------------------------------------------------------------------------------------------------------------------------------------------------------------------------------------------------------------------------------------------------------------------------------------------------------------------------------------------------------------------------------------------------------|
| User Account Lock | <p>Choose whether or not to lock the user account after the user fails to login successfully. Specify the number of failed login attempts that cause the account locking. You can enter any number from one (1) to 60. Default is five (5).</p> <p>When you configure account locking, enter the message to be displayed to the user attempting to login. Enter text using 7-bit ASCII characters. This message is only displayed when users enter the correct passphrase to an account locked by an administrator. This message is not shown for accounts locked due to failed login attempts.</p> <p>When a user account gets locked, an administrator can unlock it on the Edit User page in the GUI or using the userconfig CLI command.</p> <p>Failed login attempts are tracked by user, regardless of the machine the user connects from or the type of connection, such as SSH or HTTP. Once the user successfully logs in, the number of failed login attempts is reset to zero (0).</p> <p>When a user account is locked out due to reaching the maximum number of failed login attempts, an alert is sent to the administrator. The alert is set at the “Info” severity level.</p> <p><b>Note</b> You can also manually lock individual user accounts. For more information see <a href="#">Locking and Unlocking a User Account, on page 966</a>.</p> |

| Setting                                                      | Description                                                                                                                                                                                                                                                                                                                                                                                                                                                                                                                                                                                                                                                                                                                                                                                                                                                                                                                                                                                                                                                                                                                                                                                                                                                                                                                                                                                                                                                                    |
|--------------------------------------------------------------|--------------------------------------------------------------------------------------------------------------------------------------------------------------------------------------------------------------------------------------------------------------------------------------------------------------------------------------------------------------------------------------------------------------------------------------------------------------------------------------------------------------------------------------------------------------------------------------------------------------------------------------------------------------------------------------------------------------------------------------------------------------------------------------------------------------------------------------------------------------------------------------------------------------------------------------------------------------------------------------------------------------------------------------------------------------------------------------------------------------------------------------------------------------------------------------------------------------------------------------------------------------------------------------------------------------------------------------------------------------------------------------------------------------------------------------------------------------------------------|
| Passphrase Reset                                             | <p>You can choose whether:</p> <ul style="list-style-type: none"> <li>• Users should be forced to change their passphrases after an administrator changes their passphrases.</li> <li>• Users should be forced to change their passphrases after a specified duration. Enter the number of days a passphrase can last before users must change it. You can enter any number from one (1) to 366. Default is 90. In this case, you can optionally choose: <ul style="list-style-type: none"> <li>• To display a notification about the upcoming passphrase expiration. Enter the number of days before expiration to notify users.</li> <li>• To allow a grace period (of specified days) to reset the passphrase after the passphrase expiry. Enter the number of days.</li> </ul> </li> </ul> <p>If you are setting a grace period, user accounts will be locked if the passphrases are not changed within the specified duration. If you are not setting a grace period, users can change their passphrases any time after the passphrase expiry.</p> <p><b>Note</b> When a user account uses SSH keys instead of a passphrase challenge, the Passphrase Reset rules still apply. When a user account with SSH keys expires, the user must enter their old passphrase or ask an administrator to manually change the passphrase to change the keys associated with the account. For more information, see <a href="#">Managing Secure Shell (SSH) Keys, on page 979</a>.</p> |
| Passphrase Rules:<br>Require at least <number> characters.   | <p>Enter the minimum number of characters that a passphrase may contain.</p> <p>Enter any number between 0 and 128.</p> <p>Default is 8 characters.</p> <p>Passphrases can have more characters than the number you specify here.</p>                                                                                                                                                                                                                                                                                                                                                                                                                                                                                                                                                                                                                                                                                                                                                                                                                                                                                                                                                                                                                                                                                                                                                                                                                                          |
| Passphrase Rules:<br>Require at least one number (0-9).      | <p>Choose whether or not the passphrases must contain at least one number.</p>                                                                                                                                                                                                                                                                                                                                                                                                                                                                                                                                                                                                                                                                                                                                                                                                                                                                                                                                                                                                                                                                                                                                                                                                                                                                                                                                                                                                 |
| Passphrase Rules:<br>Require at least one special character. | <p>Choose whether or not the passphrases must contain at least one special character. Passphrases may contain the following special characters:</p> <p>~?!@#%&amp;*-_+=</p> <p>\/[[]()&lt;&gt;{}`'"';:,. .</p>                                                                                                                                                                                                                                                                                                                                                                                                                                                                                                                                                                                                                                                                                                                                                                                                                                                                                                                                                                                                                                                                                                                                                                                                                                                                 |

| Setting                                                                 | Description                                                                                                                                                                                                                                                                                                                                                                                                                                                                                                                                                                                                                                                                                                                                                                                            |
|-------------------------------------------------------------------------|--------------------------------------------------------------------------------------------------------------------------------------------------------------------------------------------------------------------------------------------------------------------------------------------------------------------------------------------------------------------------------------------------------------------------------------------------------------------------------------------------------------------------------------------------------------------------------------------------------------------------------------------------------------------------------------------------------------------------------------------------------------------------------------------------------|
| Passphrase Rules:<br>Ban usernames and their variations as passphrases. | Choose whether or not the passphrase are allowed to be the same as the associated username or variations on the username. When username variations are banned, the following rules apply to passphrases: <ul style="list-style-type: none"> <li>• The passphrase may not be the same as the username, regardless of case.</li> <li>• The passphrase may not be the same as the username in reverse, regardless of case.</li> <li>• The passphrase may not be the same as the username or reversed username with the following character substitutions:               <ul style="list-style-type: none"> <li>• "@" or "4" for "a"</li> <li>• "3" for "e"</li> <li>• " ", "!", or "1" for "i"</li> <li>• "0" for "o"</li> <li>• "\$" or "5" for "s"</li> <li>• "+" or "7" for "t"</li> </ul> </li> </ul> |
| Passphrase Rules:<br>Ban reuse of the last <number> passphrases.        | Choose whether or not users are allowed to choose a recently used passphrase when they are forced to change the passphrase. If they are not allowed to reuse recent passphrases, enter the number of recent passphrases that are banned from reuse.<br><br>You can enter any number from one (1) to 15. Default is three (3).                                                                                                                                                                                                                                                                                                                                                                                                                                                                          |
| Passphrase Rules:<br>List of words to disallow in passphrases           | You can create a list of words to disallow in passphrases.<br><br>Make this file a text file with each forbidden word on a separate line. Save the file with the name forbidden_password_words.txt and use SCP or FTP to upload the file to the appliance.<br><br>If this restriction is selected but no word list is uploaded, this restriction is ignored.                                                                                                                                                                                                                                                                                                                                                                                                                                           |

| Setting             | Description                                                                                                                                                                                                                                                                                                                                                                                                                                                                                                                                                                                                                                                                                                                                                                                                                                                                                                                                                                                                                                                                                                                                                                                                                                                                                                                                                                                                                                                                    |
|---------------------|--------------------------------------------------------------------------------------------------------------------------------------------------------------------------------------------------------------------------------------------------------------------------------------------------------------------------------------------------------------------------------------------------------------------------------------------------------------------------------------------------------------------------------------------------------------------------------------------------------------------------------------------------------------------------------------------------------------------------------------------------------------------------------------------------------------------------------------------------------------------------------------------------------------------------------------------------------------------------------------------------------------------------------------------------------------------------------------------------------------------------------------------------------------------------------------------------------------------------------------------------------------------------------------------------------------------------------------------------------------------------------------------------------------------------------------------------------------------------------|
| Passphrase Strength | <p>You can display a passphrase-strength indicator when an admin or user enters a new passphrase.</p> <p>This setting does not enforce creation of strong passphrases, it merely shows how easy it is to guess the entered passphrase.</p> <p>Select the roles for which you wish to display the indicator. Then, for each selected role, enter a number greater than zero. A larger number means that a passphrase that registers as strong is more difficult to achieve. This setting has no maximum value.</p> <p>Examples:</p> <ul style="list-style-type: none"> <li>• If you enter 30 , then an 8 character passphrase with at least one upper- and lower-case letter, number, and special character will register as a strong passphrase.</li> <li>• If you enter 18 , then an 8 character passphrase with all lower case letters and no numbers or special characters will register as strong.</li> </ul> <p>Passphrase strength is measured on a logarithmic scale. Evaluation is based on the U.S. National Institute of Standards and Technology rules of entropy as defined in NIST SP 800-63, Appendix A.</p> <p>Generally, stronger passphrases:</p> <ul style="list-style-type: none"> <li>• Are longer</li> <li>• Include upper case, lower case, numeric, and special characters</li> <li>• Do not include words in any dictionary in any language.</li> </ul> <p>To enforce passphrases with these characteristics, use the other settings on this page.</p> |

**Step 5** Submit and commit your changes.

### What to do next

If you selected **List of words to disallow in passphrases**, create and upload the described text file.

## External Authentication

If you store user information in an LDAP or RADIUS directory on your network, you can configure your appliance to use the external directory to authenticate users who log in to the appliance . To set up the appliance to use an external directory for authentication, use the System Administration > Users page in the GUI or the userconfig command and the external subcommand in the CLI.

When external authentication is enabled and a user logs into the appliance , the appliance first determines if the user is the system defined “admin” account. If not, then the appliance checks the first configured external server to determine if the user is defined there. If the appliance cannot connect to the first external server, the appliance checks the next external server in the list.



For LDAP servers, if the user fails authentication on any external server, the appliance tries to authenticate the user as a local user defined on the appliance. If the user does not exist on any external server or on the appliance, or if the user enters the wrong passphrase, access to the appliance is denied.

If an external RADIUS server cannot be contacted, the next server in the list is tried. If all servers cannot be contacted, the appliance tries to authenticate the user as a local user defined on the appliance. However, if an external RADIUS server rejects a user for any reason, such as an incorrect passphrase or the user being absent, access to the appliance is denied.

### Related Topics

- [Enabling LDAP Authentication, on page 971](#)
- [Enabling RADIUS Authentication, on page 972](#)
- [Enable SAML Authentication, on page 973](#)

## Enabling LDAP Authentication

In addition to using an LDAP directory to authenticate users, you can assign LDAP groups to Cisco user roles. For example, you can assign users in the IT group to the Administrator user role, and you can assign users in the Support group to the Help Desk User role. If a user belongs to multiple LDAP groups with different user roles, AsyncOS grants the user the permissions for the most restrictive role. For example, if a user belongs to a group with Operator permissions and a group with Help Desk User permissions, AsyncOS grants the user the permissions for the Help Desk User role.



**Note** If an external user changes the user role for their LDAP group, the user should log out of the appliance and then log back in. The user will have the permissions of their new role.

### Before You Begin

Define an LDAP server profile and an external authentication query for the LDAP server. For more information, see [LDAP Queries, on page 749](#)

### Procedure

- Step 1** Choose **System Administration > Users**.
- Step 2** Scroll down to the **External Authentication** section.
- Step 3** Click **Enable**.
- Step 4** Select the **Enable External Authentication** check box.
- Step 5** Select **LDAP** for the authentication type.
- Step 6** Enter the amount of time to store external authentication credentials in the web user interface.
- Step 7** Select the LDAP external authentication query that authenticates users.
- Step 8** Enter the number of seconds that the appliance waits for a response from the server before timing out.
- Step 9** Enter the name of a group from the LDAP directory that you want the appliance to authenticate, and select the role for the users in the group.
- Step 10** Optionally, click **Add Row** to add another directory group. Repeat steps 9 and 10 for each directory group that the appliance authenticates.

**Step 11** Submit and commit your changes.

---

## Enabling RADIUS Authentication

You can also use a RADIUS directory to authenticate users and assign groups of users to Cisco roles. The RADIUS server should support the CLASS attribute, which AsyncOS uses to assign users in the RADIUS directory to Cisco user roles. AsyncOS supports two authentication protocols for communicating with the RADIUS server: Password Authentication Protocol (PAP) and Challenge Handshake Authentication Protocol (CHAP).

To assign RADIUS users to Cisco user roles, first set the CLASS attribute on the RADIUS server with a string value of <radius-group> , which will be mapped to Cisco user roles. The CLASS attribute may contain letters, numbers, and a dash, but cannot start with a dash. AsyncOS does not support multiple values in the CLASS attribute. RADIUS users belonging to a group without a CLASS attribute or an unmapped CLASS attribute cannot log into the appliance .

If the appliance cannot communicate with the RADIUS server, the user can log in with a local user account on the appliance .



---

**Note** If an external user changes the user role for their RADIUS group, the user should log out of the appliance and then log back in. The user will have the permissions of their new role.

---

### Procedure

---

**Step 1** On the **System Administration > Users** page, click **Enable**.

**Step 2** Check the Enable External Authentication option if it is not enabled already.

**Step 3** Enter the hostname for the RADIUS server.

**Step 4** Enter the port number for the RADIUS server. The default port number is 1812.

**Step 5** Enter the Shared Secret password for the RADIUS server.

**Step 6** Enter the number of seconds for the appliance to wait for a response from the server before timing out.

**Step 7** (Optional) Click **Add Row** to add another RADIUS server. Repeat steps 3 – 6 for each RADIUS server.

**Note** You can add up to ten RADIUS servers.

**Step 8** Enter the number of seconds AsyncOS stores the external authentication credentials before contacting the RADIUS server again to re-authenticate in the “External Authentication Cache Timeout” field. Default is zero (0).

**Note** If the RADIUS server uses one-time passwords, for example passwords created from a token, enter zero (0). When the value is set to zero, AsyncOS does not contact the RADIUS server again to authenticate during the current session.

**Step 9** Configure Group Mapping:

| Setting                                                           | Description                                                                                                                                                                                                                                                                                                                                                                                                                                                                                                                                                                                                                                                                                                                                                                                                                                                                                                                                                                                                                                                                                                   |
|-------------------------------------------------------------------|---------------------------------------------------------------------------------------------------------------------------------------------------------------------------------------------------------------------------------------------------------------------------------------------------------------------------------------------------------------------------------------------------------------------------------------------------------------------------------------------------------------------------------------------------------------------------------------------------------------------------------------------------------------------------------------------------------------------------------------------------------------------------------------------------------------------------------------------------------------------------------------------------------------------------------------------------------------------------------------------------------------------------------------------------------------------------------------------------------------|
| Map externally authenticated users to multiple local roles.       | <p>AsyncOS assigns RADIUS users to appliance roles based on the RADIUS CLASS attribute. CLASS attribute requirements:</p> <ul style="list-style-type: none"> <li>• 3 character minimum</li> <li>• 253 character maximum</li> <li>• no colons, commas, or newline characters</li> <li>• one or more mapped CLASS attributes for each RADIUS user (With this setting, AsyncOS denies access to RADIUS users without a mapped CLASS attribute.)</li> </ul> <p>For RADIUS users with multiple CLASS attributes, AsyncOS assigns the most restrictive role. For example, if a RADIUS user has two CLASS attributes, which are mapped to the Operator and Read-Only Operator roles, AsyncOS assigns the RADIUS user to the Read-Only Operator role, which is more restrictive than the Operator role.</p> <p>These are the appliance roles ordered from least restrictive to most restrictive:</p> <ul style="list-style-type: none"> <li>• admin</li> <li>• Administrator</li> <li>• Technician</li> <li>• Operator cloudadmin</li> <li>• Read-only Operator</li> <li>• Help Desk User</li> <li>• Guest</li> </ul> |
| Map all externally authenticated users to the Administrator role. | AsyncOS assigns RADIUS users to the Administrator role.                                                                                                                                                                                                                                                                                                                                                                                                                                                                                                                                                                                                                                                                                                                                                                                                                                                                                                                                                                                                                                                       |

- Step 10** Choose whether to map all externally authenticated users to the Administrator role or to different appliance user role types.
- Step 11** If you map users to different role types, enter the group name as defined in the RADIUS CLASS attribute in the Group Name or Directory field, and choose an appliance role type from the Role field. You can add more role mappings by clicking **Add Row**.
- For more information on user role types, see [Working with User Accounts, on page 949](#).
- Step 12** Submit and commit your changes.

## Enable SAML Authentication

You can enable Single Sign On using SAML to authenticate users and assign groups of users to Cisco rules.

### Before you begin

Make sure that you have configured the SAML profiles with Service Provider and Identity Provider settings. See [How to Configure SSO on your Appliance , on page 1051](#).

## Procedure

---

- Step 1** Navigate to **System Administration > Users**.
- Step 2** Scroll down to the **External Authentication** section.
- Step 3** Click **Enable**.
- Step 4** Select the **Enable External Authentication** check box.
- Step 5** Select **SAML** as the authentication type from the drop-down list.
- Step 6** **(Optional)** In the **External Authentication Attribute Name Map** field, enter the attribute name to search from the Group Mapping.

The Attribute Name depends on the attributes that you configure for the Identity Provider to relay the SAML response. The appliance will search for matching entries of the Attribute Name from SAML response against the attributes that you configure in the **Group Mapping** field. This is optional and if you do not configure, the appliance will search for matching entries of all attributes present in SAML response against configured Group Mapping field.

- Step 7** In the **Group Mapping** field, enter the group name attribute as defined in the SAML directory based on the predefined or custom user role. You can click **Add Row** to add multiple role mappings.

The Group Mapping must contain a group attribute. You can add 'Unspecified Groups' attribute to authenticate SAML assertions or response.

For more information on types of user roles, see [Working with User Accounts, on page 949](#).

**Note** The Group Mapping attributes are case-sensitive and must match exactly in order to return the proper results.

- Step 8** Submit and commit your changes.
- 

## What to do next

After you enable SAML external authentication, you can use the **Use Single Sign On** link on the login page of the appliance and enter the username to log in to the appliance .

# Configuring Access to the Email Security Appliance

AsyncOS provides administrators controls to manage users' access to the appliance , including a timeout for Web UI session and an access list that specifies the IP addresses from which users and your organization's proxy servers can access the appliance .

## Related Topics

- [Configuring IP-Based Network Access, on page 975](#)
- [Configuring Session Timeouts, on page 977](#)

## Configuring IP-Based Network Access

You can control from which IP addresses users access the appliance by creating access lists for users who connect directly to the appliance and users who connect through a reverse proxy, if your organization uses reverse proxies for remote users.

### Related Topics

- [Direct Connections, on page 975](#)
- [Connecting Through a Proxy, on page 975](#)
- [Important Precautions When Restricting Network Access , on page 975](#)
- [Creating the Access List , on page 976](#)

### Direct Connections

You can specify the IP addresses, subnets, or CIDR addresses for machines that can connect to the appliance . Users can access the appliance from any machine with IP address from the access list. Users attempting to connect to the appliance from an address not included in the list are denied access.

### Connecting Through a Proxy

If your organization's network uses reverse proxy servers between remote users' machines and the appliance , AsyncOS allows you create an access list with the IP addresses of the proxies that can connect to the appliance .

Even when using a reverse proxy, AsyncOS still validates the IP address of the remote user's machine against a list of IP addresses allowed for user connections. To send the remote user's IP address to the appliance , the proxy needs to include the x-forwarded-for HTTP header in its connection request to the appliance .

The x-forwarded-for header is a non-RFC standard HTTP header with the following format:

```
x-forwarded-for: client-ip, proxy1, proxy2,... CRLF .
```

The value for this header is a comma-separated list of IP addresses with the left-most address being the address of the remote user's machine, followed by the addresses of each successive proxy that forwarded the connection request. (The header name is configurable.) The appliance matches the remote user's IP address from the header and the connecting proxy's IP address against the allowed user and proxy IP addresses in the access list.



---

**Note** AsyncOS supports only IPv4 addresses in the x-forwarded-for header.

---

### Important Precautions When Restricting Network Access

**Caution!** You may lose access to the appliance after submitting and committing network access changes if one of the following conditions is true:

- If you select **Only Allow Specific Connections** and do not include the IP address of your current machine (PC, appliance in a clustered environment, or Security Management appliance , etc.) in the list.
- If you select **Only Allow Specific Connections Through Proxy** and the IP address of the proxy currently connected to the appliance is not in the proxy list and the value of the Origin IP header is not in the list of allowed IP addresses.

- If you select **Only Allow Specific Connections Directly or Through Proxy** and
  - the value of the Origin IP header is not in the list of allowed IP addresses
  - OR
  - the value of the Origin IP header is not in the list of allowed IP Addresses and the IP address of the proxy connected to the appliance is not in the list of allowed proxies.

## Creating the Access List

You can create the network access list either via the GUI or the `adminaccessconfig > ipaccess` CLI command.

### Before You Begin

Ensure that you will not lock yourself out of the appliance after changing network access settings. See [Important Precautions When Restricting Network Access](#), on page 975.

### Procedure

- Step 1** Select **System Administration > Network Access**.
- Step 2** Click **Edit Settings**.
- Step 3** Select the mode of control for the access list:

| Option                                                           | Description                                                                                                                                                                                                                                                                                                                                                                                                                                                                                                                                                                                                             |
|------------------------------------------------------------------|-------------------------------------------------------------------------------------------------------------------------------------------------------------------------------------------------------------------------------------------------------------------------------------------------------------------------------------------------------------------------------------------------------------------------------------------------------------------------------------------------------------------------------------------------------------------------------------------------------------------------|
| <b>Allow All</b>                                                 | This mode allows all connections to the appliance .<br>This is the default mode of operation.                                                                                                                                                                                                                                                                                                                                                                                                                                                                                                                           |
| <b>Only Allow Specific Connections</b>                           | This mode allows a user to connection to the appliance if the user's IP address matches the IP addresses, IP ranges, or CIDR ranges included in the access list.                                                                                                                                                                                                                                                                                                                                                                                                                                                        |
| <b>Only Allow Specific Connections Through Proxy</b>             | This mode allows a user to connect to the appliance through a reverse proxy if the following conditions are met: <ul style="list-style-type: none"> <li>• The connecting proxy's IP address is included in the access list's IP Address of Proxy Server field.</li> <li>• The proxy includes the <b>x-forwarded-header</b> HTTP header in its connection request.</li> <li>• The value of <b>x-forwarded-header</b> is not empty.</li> <li>• The remote user's IP address is included in x-forwarded-header and it matches the IP addresses, IP ranges, or CIDR ranges defined for users in the access list.</li> </ul> |
| <b>Only Allow Specific Connections Directly or Through Proxy</b> | This mode allows users to connect through a reverse proxy or directly to the appliance if their IP address matches the IP addresses, IP ranges, or CIDR ranges included in the access list. The conditions for connecting through a proxy are the same as in the Only Allow Specific Connections Through Proxy mode.                                                                                                                                                                                                                                                                                                    |

- Step 4** Enter the IP addresses from which users will be allowed to connect to the appliance .  
You can enter an IP address, IP address range or CIDR range. Use commas to separate multiple entries.
- Step 5** If connecting through a proxy is allowed, enter the following information:
- The IP addresses of the proxies allowed to connect to the appliance . Use commas to separate multiple entries.
  - The name of the origin IP header that the proxy sends to the appliance , which contains the IP addresses of the remote user's machine and the proxy servers that forwarded the request. By default, the name of the header is x-forwarded-for .
- Step 6** Ensure that you have not configured a change that will lock you out of the appliance after you submit and commit your changes.
- Step 7** Submit and commit your changes.
- 

## Configuring Session Timeouts

- [Configuring the Web UI Session Timeout, on page 977](#)
- [Configuring the CLI Session Timeout, on page 978](#)

### Configuring the Web UI Session Timeout

You can specify how long a user can be logged into the appliance's Web UI before AsyncOS logs the user out due to inactivity. This Web UI session timeout applies to:

- All users, including administrator
- HTTP and HTTPS sessions
- Cisco Spam Quarantine

Once AsyncOS logs a user out, the appliance redirects the user's web browser to login page.

#### Procedure

---

- Step 1** Select **System Administration > Network Access**.
- Step 2** Click **Edit Settings**.
- Step 3** In the **Web UI Inactivity Timeout** field, enter the number of minutes users can be inactive before being logged out. You can define a timeout period between 5 and 1440 minutes.
- Step 4** Submit and commit your changes.
- 

#### What to do next

You can also use the `adminaccessconfig` command in CLI to configure Web UI session timeout. See *CLI Reference Guide for AsyncOS for Cisco Email Security Appliances* .

## Configuring the CLI Session Timeout

You can specify how long a user can be logged into the appliance's CLI before AsyncOS logs the user out due to inactivity. The CLI session timeout applies:

- To all users, including administrator
- Only to the connections using Secure Shell (SSH), SCP, and direct serial connection



---

**Note** Any uncommitted configuration changes at the time of CLI session timeout will be lost. Make sure that you commit the configuration changes as soon as they are made.

---

### Procedure

---

- Step 1** Select **System Administration > Network Access**.
  - Step 2** Click **Edit Settings**.
  - Step 3** In the **CLI Inactivity Timeout** field, enter the number of minutes users can be inactive before being logged out. You can define a timeout period between 5 and 1440 minutes.
  - Step 4** Submit and commit your changes.
- 

### What to do next

You can also use the `adminaccessconfig` command in CLI to configure CLI session timeout. See *CLI Reference Guide for AsyncOS for Cisco Email Security Appliances* .

## Displaying Messages to Administrative Users

- [Displaying a Message Before Login](#) , on page 978
- [Displaying a Message After Login](#) , on page 979

### Displaying a Message Before Login

You can configure the appliance to display a message before a user attempts to log into the appliance through SSH, FTP, or Web UI. The login banner is customizable text that appears above the login prompt. You can use the login banner to display internal security information or best practice instructions for the appliance . For example, you can create a simple note that saying that unauthorized use of the appliance is prohibited or a detailed warning concerning the organization's right to review changes made by the user to the appliance .

Use the `adminaccessconfig > banner` command in the CLI to create the login banner. The maximum length of the login banner is 2000 characters to fit 80x25 consoles. A login banner can be imported from a file in the `/data/pub/configuration` directory on the appliance . After creating the banner, commit your changes.



## Displaying a Message After Login

You can configure AsyncOS to display a welcome banner after a user successfully logs into the appliance through SSH, FTP, or Web UI. You can use the welcome banner to display internal security information or best practice instructions for the appliance .

Use the `adminaccessconfig > welcome` command in CLI to create the welcome banner. The maximum length of the welcome banner is 1600 characters.

You can import a welcome banner from a file in the `/data/pub/configuration` directory on your appliance . After creating the banner, commit your changes.

For more information, see *CLI Reference Guide for AsyncOS for Cisco Email Security Appliances* .

## Managing Secure Shell (SSH) Keys

Use the `sshconfig` command to:

- Add or delete secure shell (SSH) public User keys to the `authorized_keys` file of user accounts that have been configured on the system, including the admin account. This allows authentication to user accounts using SSH keys rather than passphrase challenge.
- Edit the following SSH server configuration settings:
  - Public Key Authentication Algorithms
  - Cipher Algorithms
  - KEX Algorithms
  - MAC Methods
  - Minimum Server Key Size.



**Note** To configure Host keys, which are used when performing SCP pushes of log files from the appliance to other host machines, use `logconfig -> hostkeyconfig` . For more information, see [Logging, on page 1113](#).

Using `hostkeyconfig` , you can scan for keys of remote hosts and add them to the appliance .

### Related Topics

- [Example: Install a New Public Key, on page 979](#)
- [Example: Edit SSH Server Configuration, on page 980](#)

## Example: Install a New Public Key

In the following example, a new public key is installed for the administrator account:

```
mail.example.com> sshconfig
Choose the operation you want to perform:
- SSHD - Edit SSH server settings.
- USERKEY - Edit SSH User Key settings
[]> userkey
Currently installed keys for admin:
Choose the operation you want to perform:
```

```

- NEW - Add a new key.
- USER - Switch to a different user to edit.
[]> new
Please enter the public SSH key for authorization.
Press enter on a blank line to finish.
[-paste public key for user authentication here-]
Choose the operation you want to perform:
- SSHD - Edit SSH server settings.
- USERKEY - Edit SSH User Key settings
[]>

```

## Example: Edit SSH Server Configuration

The following example shows how to edit the SSH server configuration.

```

mail.example.com> sshconfig
Choose the operation you want to perform:
- SSHD - Edit SSH server settings.
- USERKEY - Edit SSH User Key settings
[]> sshd
ssh server config settings:
Public Key Authentication Algorithms:
 rsal
 ssh-dss
 ssh-rsa
Cipher Algorithms:
 aes128-ctr
 aes192-ctr
 aes256-ctr
 arcfour256
 arcfour128
 aes128-cbc
 3des-cbc
 blowfish-cbc
 cast128-cbc
 aes192-cbc
 aes256-cbc
 arcfour
 rijndael-cbc@lysator.liu.se
MAC Methods:
 hmac-md5
 hmac-sha1
 umac-64@openssh.com
 hmac-ripemd160
 hmac-ripemd160@openssh.com
 hmac-sha1-96
 hmac-md5-96
Minimum Server Key Size:
 1024
KEX Algorithms:
 diffie-hellman-group-exchange-sha256
 diffie-hellman-group-exchange-sha1
 diffie-hellman-group14-sha1
 diffie-hellman-group1-sha1
Choose the operation you want to perform:
- SETUP - Setup SSH server configuration settings
[]> setup
Enter the Public Key Authentication Algorithms do you want to use
[rsal,ssh-dss,ssh-rsa]> rsal
Enter the Cipher Algorithms do you want to use
[aes128-ctr,aes192-ctr,aes256-ctr,arcfour256,arcfour128,aes128-cbc,3des-cbc,blowfish-cbc,
cast128-cbc,aes192-cbc,aes256-cbc,arcfour,rijndael-cbc@lysator.liu.se]> aes192-ctr

```

```

Enter the MAC Methods do you want to use
[hmac-md5,hmac-shal,umac-64@openssh.com,hmac-ripemd160,hmac-ripemd160@openssh.com,hmac-shal-96,
hmac-md5-96]> hmac-shal
Enter the Minimum Server Key Size do you want to use
[1024]> 2048
Enter the KEX Algorithms do you want to use
[diffie-hellman-group-exchange-sha256,diffie-hellman-group-exchange-shal,diffie-hellman-group14-shal,
diffie-hellman-group1-shal]> diffie-hellman-group-exchange-shal
ssh server config settings:
Public Key Authentication Algorithms:
 rsal
Cipher Algorithms:
 aes192-ctr
MAC Methods:
 hmac-shal
Minimum Server Key Size:
 2048
KEX Algorithms:
 diffie-hellman-group-exchange-shal
Choose the operation you want to perform:
- SETUP - Setup SSH server configuration settings
[]>

```

## Remote SSH Command Execution

The CLI allows commands to be run via remote SSH command execution. For example, the following command can be run from a remote host unchallenged if an SSH public key has been configured for the admin account on the appliance :

```

ssh admin@mail3.example.com status

Enter "status detail" for more information.

Status as of: Mon Jan 20 17:24:15 2003

Last counter reset: Mon Jan 20 17:08:21 2003

System status: online

[rest of command deleted]

```

## Monitoring Administrative User Access

| To                                                                                                                                                           | Do This                                                                                                                                                                                  |
|--------------------------------------------------------------------------------------------------------------------------------------------------------------|------------------------------------------------------------------------------------------------------------------------------------------------------------------------------------------|
| View session details of all active users of the appliance                                                                                                    | Click <b>Options &gt; Active Sessions</b> at the top right of the page<br><br>In the command-line interface, use the <code>w</code> , <code>whoami</code> and <code>who</code> commands. |
| View users who have recently logged into the appliance .<br><br>The IP address of the remote host, and the login, logout, and total time are also displayed. | In the command-line interface, use the <code>l</code> ast command.                                                                                                                       |





## CHAPTER 38

# System Administration

This chapter contains the following sections:



### Note

Several of the features or commands described in this section will affect, or be affected by routing precedence. Please see *Appendix B "IP Addresses Interfaces and Routing"* for more information.

- [Management of the Appliance](#) , on page 983
- [Email Security Appliance Licensing](#), on page 986
- [Cisco Email Security Virtual Appliance Virtual Email Gateway License](#), on page 994
- [Managing the Configuration File](#), on page 995
- [Configuration File Page](#), on page 1000
- [Managing Disk Space](#) , on page 1000
- [Managing Security Services](#), on page 1002
- [Service Updates](#) , on page 1003
- [Setting Up to Obtain Upgrades and Updates](#) , on page 1004
- [Upgrading AsyncOS](#), on page 1012
- [Enabling Remote Power Cycling](#) , on page 1016
- [Reverting to a Previous Version of AsyncOS](#), on page 1017
- [Configuring the Return Address for Appliance Generated Messages](#), on page 1019
- [Setting Thresholds for System Health Parameters](#), on page 1019
- [Checking the Health of Appliance](#) , on page 1020
- [Alerts](#), on page 1021
- [Changing Network Settings](#), on page 1043
- [Single Sign-On \(SSO\) Using SAML 2.0](#), on page 1048
- [System Time](#), on page 1058
- [Customizing Your View](#) , on page 1060
- [General Settings](#), on page 1061
- [Configuring Maximum HTTP Header Size](#), on page 1062
- [Restarting and Viewing Status of Service Engines](#), on page 1062

## Management of the Appliance

The following tasks allow you to easily manage the common functions within the appliance .

- [Shutting Down or Rebooting the Appliance](#) , on page 984
- [Suspending Email Receiving and Delivery](#) , on page 984
- [Resuming Suspended Email Receiving and Delivery](#) , on page 985

## Shutting Down or Rebooting the Appliance

After you shut down or reboot, you may restart the appliance later without losing any messages in the delivery queue.

You can use the `s hutdown` or `s reboot` command in the CLI, or use the web interface:

### Procedure

- 
- Step 1** Select **System Administration** > **Shutdown/Suspend**.
  - Step 2** In the **System Operations** section, choose **Shutdown** or **Reboot** from the **Operation** drop-down list.
  - Step 3** Enter a number of seconds to wait to allow open connections to complete before forcing them to close. The default delay is thirty (30) seconds.
  - Step 4** Click **Commit**.
- 

## Suspending Email Receiving and Delivery

AsyncOS allows you to suspend receiving and delivering of emails. You can suspend:

- Receiving of emails on a particular listener or multiple listeners.
- Delivery of all emails or emails to a particular domain or multiple domains.

Use the `suspend` command in the CLI, or use the web interface:

### Procedure

- 
- Step 1** Select **System Administration** > **Shutdown/Suspend**.
  - Step 2** Suspend receiving of emails on a particular listener or multiple listeners. In the **Mail Operations** section, select the functions and/or listeners to suspend. If the appliance has multiple listeners, you can suspend email receiving on individual listeners.
  - Step 3** Suspend the delivery of all emails or emails to a particular domain or multiple domains. Depending on your requirements, do one of the following:
    - a. To suspend the delivery of all emails, in **Specify Domain(s)/Subdomain(s)** field, enter **ALL**, and press **Enter**.
    - b. To suspend the delivery of emails to a specific domain or subdomain, in **Specify Domain(s)/Subdomain(s)** field, enter the domain or subdomain name or IP address, and press **Enter**. Use comma-separated text to add multiple entries.
  - Step 4** Enter number of seconds to wait to allow open connections to complete before forcing them to close.

If there are no open connections, the system goes offline immediately.

The default delay is 30 seconds.

**Step 5** Click **Commit**.

---

#### What to do next

When you are ready to resume suspended services, see [Resuming Suspended Email Receiving and Delivery](#), on page 985.

## Resuming Suspended Email Receiving and Delivery

Use the Shutdown/Suspend page or the `resume` command to resume the suspended receiving and delivery of emails.

#### Procedure

---

- Step 1** Select **System Administration > Shutdown/Suspend**.
- Step 2** In the **Mail Operations** section, select the functions and/or listeners to resume.  
If the appliance has multiple listeners, you can resume email receiving on individual listeners.
- Step 3** Resume the delivery of all emails or emails to a particular domain or multiple domains.  
In **Specify Domain(s)/Subdomain(s)** field, click the close icon on the intended entry.
- Step 4** Click **Commit**.
- 

## Resetting to Factory Defaults



**Caution** Do not reset to factory defaults if you are not able to reconnect to the web interface or CLI using the Serial interface or the default settings on the Management port through the default Admin user account.

---

When physically transferring the appliance, you may want to start with factory defaults. Resetting to factory settings is extremely destructive, and it should only be used when you are transferring the unit or as a last resort to solving configuration issues. Resetting to factory defaults disconnects you from the web interface or CLI, disabling services that you used to connect to the appliance (FTP, SSH, HTTP, HTTPS), and even removing additional user accounts you had created. You can reset to factory default:

- On web interface, click the Reset button in the **System Administration > Configuration File** page, or click the Reset Configuration button in the **System Administration > System Setup Wizard**.
- On CLI, use the `resetconfig` command.



**Note** The `resetconfig` command only works when the appliance is in the offline state. The appliance returns to the online state after resetting to factory settings.

## Next Steps

- Run the System Setup wizard. For more information, refer to [Using the System Setup Wizard](#) , on page 30
- Turn on mail delivery to resume mail delivery.

## Displaying the Version Information for AsyncOS

To determine which version of AsyncOS is currently installed on your appliance , use the System Overview page from the Monitor menu in the web interface (see [System Status, on page 836](#)), or use the version command in the CLI.

## Email Security Appliance Licensing

- [Feature Keys, on page 986](#)

## Feature Keys

- [Adding and Managing Feature Keys](#) , on page 986
- [Automating Feature Key Download and Activation](#) , on page 987
- [Expired Feature Keys, on page 988](#)

On Cloud Email Security appliances , avoid changing feature key settings.

## Adding and Managing Feature Keys

For physical appliances , feature keys are specific to the serial number of the appliance and specific to the feature being enabled (you cannot re-use a key from one system on another system).

To work with feature keys in the CLI, use the `featurekey` command.

### Procedure

**Step 1** Select **System Administration > Feature Keys**.

**Step 2** Perform actions:

| To                                     | Do This                                                            |
|----------------------------------------|--------------------------------------------------------------------|
| View the status of active feature keys | Look at the <b>Feature Keys for &lt;serial number&gt;</b> section. |



| To                                                                                   | Do This                                                                                                                                                                                                                                                 |
|--------------------------------------------------------------------------------------|---------------------------------------------------------------------------------------------------------------------------------------------------------------------------------------------------------------------------------------------------------|
| View feature keys that have been issued for your appliance but are not yet activated | Look at the <b>Pending Activation</b> section.<br>If you have enabled automatic download and activation, feature keys will never appear in this list.                                                                                                   |
| Check for recently-issued feature keys                                               | Click the <b>Check for New Keys</b> button in the Pending Activation section.<br><br>This is useful if you have not enabled automatic download and activation of feature keys, or if you need to download feature keys before the next automatic check. |
| Activate an issued feature key                                                       | Select the key in the <b>Pending Activation</b> list and click <b>Activate Selected Keys</b> .                                                                                                                                                          |
| Add a new feature key                                                                | Use the <b>Feature Activation</b> section.                                                                                                                                                                                                              |

---

### What to do next

#### Related Topics

- [Automating Feature Key Download and Activation](#) , on page 987
- [Configuration File Page](#), on page 1000

## Automating Feature Key Download and Activation

You can set the appliance to automatically check for, download, and activate feature keys that are issued for this appliance .

### Procedure

- 
- Step 1** Select **System Administration > Feature Key Settings**.
  - Step 2** Click **Edit Feature Key Settings**.
  - Step 3** To see frequency of checks for new feature keys, click the (?) help button.
  - Step 4** Specify settings.
  - Step 5** Submit and commit your changes.
- 

### What to do next

#### Related Topics

- [Adding and Managing Feature Keys](#) , on page 986

## Expired Feature Keys

If a feature key is expiring, the appliance sends out alerts 90 days, 60 days, 30 days, 15 days, 5 days, one day prior to the key expiration, and at the time of key expiration. To receive these alerts, make sure that you have subscribed to the System Alerts. For more information, see [Alerts, on page 1021](#).

If the feature key for the feature you are trying to access (using the web interface) has expired, please contact your Cisco representative or support organization.

## Smart Software Licensing

- [Overview, on page 988](#)
- [Enabling Smart Software Licensing, on page 990](#)
- [Registering the Appliance with Cisco Smart Software Manager, on page 990](#)
- [Requesting for Licenses, on page 991](#)
- [Deregistering the Appliance from Smart Cisco Software Manager , on page 992](#)
- [Reregistering the Appliance with Smart Cisco Software Manager , on page 992](#)
- [Changing Transport Settings, on page 992](#)
- [Renewing Authorization and Certificate, on page 993](#)
- [Updating Smart Agent, on page 994](#)
- [Alerts, on page 993](#)
- [Smart Licensing in Cluster Mode, on page 994](#)

## Overview

Smart Software Licensing enables you to manage and monitor appliance licenses seamlessly. To activate Smart Software licensing, you must register your appliance with Cisco Smart Software Manager (CSSM) which is the centralized database that maintains the licensing details about all the Cisco products that you purchase and use. With Smart Licensing, you can register with a single token rather than registering them individually on the website using Product Authorization Keys (PAKs).

Once you register the appliance , you can track your appliance licenses and monitor license usage through the CSSM portal. The Smart Agent installed on the appliance connects the appliance with CSSM and passes the license usage information to the CSSM to track the consumption.

See [https://www.cisco.com/c/en/us/td/docs/wireless/technology/mesh/8-2/b\\_Smart\\_Licensing\\_Deployment\\_Guide.html](https://www.cisco.com/c/en/us/td/docs/wireless/technology/mesh/8-2/b_Smart_Licensing_Deployment_Guide.html) to know about Cisco Smart Software Manager.

### Before you begin

- Make sure that your appliance has internet connectivity.
- Contact Cisco sales team to create a smart account in Cisco Smart Software Manager portal (<https://software.cisco.com/#module/SmartLicensing>) or install a Cisco Smart Software Manager Satellite on your network.

See [https://www.cisco.com/c/en/us/td/docs/wireless/technology/mesh/8-2/b\\_Smart\\_Licensing\\_Deployment\\_Guide.html](https://www.cisco.com/c/en/us/td/docs/wireless/technology/mesh/8-2/b_Smart_Licensing_Deployment_Guide.html) to know more about Cisco Smart Software Manager user account creation or installing a Cisco Smart Software Manager Satellite.

For users who do not want to directly send the license usage information to the internet, the Smart Software Manager Satellite can be installed on the premises, and it provides a subset of CSSM functionality. Once you download and deploy the satellite application, you can manage licenses locally and securely without sending data to CSSM using the internet. The CSSM Satellite periodically transmits the information to the cloud.



---

**Note** If you want to use Smart Software Manager Satellite, use Smart Software Manager Satellite Enhanced Edition 6.1.0.

---

- The existing users of classical licenses (traditional) should migrate their classical licenses to smart licenses. See <https://video.cisco.com/detail/video/5841741892001/convert-classic-licenses-to-smart-licenses?autoStart=true&q=classic>.
- The system clock of the appliance must be in sync with that of the CSSM. Any deviation in the system clock of the appliance with that of the CSSM, will result in failure of smart licensing operations.



---

**Note** If you have internet connectivity and want to connect to the CSSM through a proxy, you must use the same proxy that is configured for the appliance using **Security Services -> Service updates**

---



---

**Note** For virtual users, every time you receive a new PAK file (new or renewal), generate the license file and load the file on the appliance . After loading the file, you must convert the PAK to Smart Licensing. In Smart Licensing mode, the feature keys section in the license file will be ignored while loading the file and only the certificate information will be used.

---

You must perform the following procedures to activate Smart Software Licensing for your appliance :

|        | Do This                                                  | More Informaton                                                                          |
|--------|----------------------------------------------------------|------------------------------------------------------------------------------------------|
| Step 1 | Enable Smart Software Licensing                          | <a href="#">Enabling Smart Software Licensing, on page 990</a>                           |
| Step 2 | Register the appliance with Cisco Smart Software Manager | <a href="#">Registering the Appliance with Cisco Smart Software Manager, on page 990</a> |
| Step 3 | Request for licenses (feature keys)                      | <a href="#">Requesting for Licenses, on page 991</a>                                     |

## Enabling Smart Software Licensing

### Procedure

---

**Step 1** Choose **System Administration > Smart Software Licensing**.

**Step 2** Click **Enable Smart Software Licensing**.

To know about Smart Software Licensing, click on the Learn More about Smart Software Licensing link.

**Step 3** Click **OK** after reading the information about Smart Software Licensing.

**Step 4** Commit your changes.

---

### What to do next

After you enable Smart Software Licensing, all the features in the Classic Licensing mode will be automatically available in the Smart Licensing mode. If you are an existing user in Classic Licensing mode, you have 90-days evaluation period to use the Smart Software Licensing feature without registering your appliance with the CSSM.

You will get notifications on regular intervals (90th, 60th, 30th, 15th, 5th, and last day) prior to the expiry and also upon expiry of the evaluation period. You can register your appliance with the CSSM during or after the evaluation period.



**Note** New virtual appliance users with no active licenses in Classic Licensing mode will not have the evaluation period even if they enable the Smart Software Licensing feature. Only the existing virtual appliance users with active licenses in Classic Licensing mode will have evaluation period. If new virtual appliance users want to evaluate the smart licensing feature, contact Cisco Sales team to add the evaluation license to the smart account. The evaluation licenses are used for evaluation purpose after registration.

---



**Note** After you enable the Smart Licensing feature on your appliance, you will not be able to roll back from Smart Licensing to Classic Licensing mode.

---

## Registering the Appliance with Cisco Smart Software Manager

You must enable the Smart Software Licensing feature under System Administration menu in order to register your appliance with the Cisco Smart Software Manager.

### Procedure

---

**Step 1** Choose **System Administration > Smart Software Licensing**.

**Step 2** Click **Edit**, if you want to change the **Transport Settings**. The available options are:

- **Direct**: Connects the appliance directly to the Cisco Smart Software Manager through HTTPs. This option is selected by default.

- Transport Gateway: Connects the appliance to the Cisco Smart Software Manager through a Transport Gateway or Smart Software Manager Satellite. When you choose this option, you must enter the URL of the Transport Gateway or the Smart Software Manager Satellite and click OK. This option supports HTTP and HTTPS. In FIPS mode, Transport Gateway supports only HTTPS. See [https://www.cisco.com/c/en/us/td/docs/wireless/technology/mesh/8-2/b\\_Smart\\_Licensing\\_Deployment\\_Guide.html](https://www.cisco.com/c/en/us/td/docs/wireless/technology/mesh/8-2/b_Smart_Licensing_Deployment_Guide.html) to know about Transport Gateway.

Access the Cisco Smart Software Manager portal

(<https://software.cisco.com/#module/SmartLicensing> using your login credentials. Navigate to the Virtual Account page of the portal and access the General tab to generate a new token. Copy the Product Instance Registration Token for your appliance .

See [https://www.cisco.com/c/en/us/td/docs/wireless/technology/mesh/8-2/b\\_Smart\\_Licensing\\_Deployment\\_Guide.html](https://www.cisco.com/c/en/us/td/docs/wireless/technology/mesh/8-2/b_Smart_Licensing_Deployment_Guide.html) to know about Product Instance Registration Token creation.

- Step 3** Switch back to your appliance and paste the Product Instance Registration Token.
- Step 4** Click **Register**.
- Step 5** On the Smart Software Licensing page, you can check the Reregister this product instance if it is already registered check box to reregister your appliance . See [Reregistering the Appliance with Smart Cisco Software Manager , on page 992](#).

---

### What to do next

The product registration process takes a few minutes and you can view the registration status on the Smart Software Licensing page.

## Requesting for Licenses

Once you complete the registration process successfully, you must request for licenses for the appliance's features as required.

### Procedure

---

- Step 1** Choose **System Administration > Licenses**.
- Step 2** Click **Edit Settings**.
- Step 3** Check the checkboxes under the License Request/Release column corresponding to the licenses you want to request for.
- Step 4** Click **Submit**.

**Note** By default the licenses for Mail Handling and Email Security Appliance Bounce Verification are available. You cannot activate, deactivate, or release these licenses.

There is no evaluation period or out of compliance for Mail Handling and Email Security Appliance Bounce Verification licenses. This is not applicable for virtual appliances .

---

**What to do next**

When the licenses are overused or expired, they will go into out of compliance (OOC) mode and 30-days grace period is provided to each license. You will get notifications on regular intervals (30th, 15th, 5th, and last day) prior to the expiry and also upon the expiry of the OOC grace period.

After the expiry of the OOC grace period, you cannot use the licenses and the features will be unavailable. To access the features again, you must update the licenses on the CSSM portal and renew the authorization.

**Deregistering the Appliance from Smart Cisco Software Manager****Procedure**

- 
- Step 1** Choose **System Administration > Smart Software Licensing**.
  - Step 2** From the **Action** drop-down list, choose **Deregister** and click **Go**.
  - Step 3** Click **Submit**.
- 

**Reregistering the Appliance with Smart Cisco Software Manager****Procedure**

- 
- Step 1** Choose **System Administration > Smart Software Licensing**.
  - Step 2** From the **Action** drop-down list, choose **Reregister** and click **Go**.
- 

**What to do next**

See [Registering the Appliance with Cisco Smart Software Manager, on page 990](#) to know about registration process.

You can reregister the appliance after you reset the appliance configurations during unavoidable scenarios.

**Changing Transport Settings**

You can change the transport settings only before registering the appliance with CSSM.

**Note**

You can change the transport settings only when the smart licensing feature is enabled. If you have already registered your appliance, you must deregister the appliance to change the transport settings. After changing the transport settings, you must register the appliance again.

See [Registering the Appliance with Cisco Smart Software Manager](#) to know how to change the transport settings.

## Renewing Authorization and Certificate

After you register your appliance with the Smart Cisco Software Manager, you can renew the certificate.



---

**Note** You can renew authorization only after the successful registration of the appliance .

---

### Procedure

---

**Step 1** Choose **System Administration > Smart Software Licensing**.

**Step 2** From the **Action** drop-down list, choose the appropriate option:

- Renew Authorization Now
- Renew Certificates Now

**Step 3** Click **Go**.

---

## Alerts

You will receive notifications on the following scenarios:

- Smart Software Licensing successfully enabled
- Smart Software Licensing enabling failed
- Beginning of the evaluation period
- Expiry of evaluation period (on regular intervals during evaluation period and upon expiry)
- Successfully registered
- Registration failed
- Successfully authorized
- Authorization failed
- Successfully deregistered
- Deregistration failed
- Successfully renewed Id certificate
- Renewal of Id certificate failed
- Expiry of authorization
- Expiry of Id certificate
- Expiry of out of compliance grace period (on regular intervals during out of compliance grace period and upon expiry)
- First instance of the expiry of a feature

## Updating Smart Agent

To update the Smart Agent version installed on your appliance , perform the following steps:

### Procedure

---

**Step 1** Choose **System Administration > Smart Software Licensing**.

**Step 2** In the **Smart Agent Update Status** section, click **Update Now** and follow the process.

**Note** If you try to save any configuration changes using the CLI command `saveconfig` or through the web interface using **System Administration > Configuration Summary**, then Smart Licensing related configuration will not be saved.

---

## Smart Licensing in Cluster Mode



**Note** The cluster management of smart licensing feature happens only in the machine mode. In smart licensing cluster mode, you can log into any of the appliances and configure smart licensing feature. You can log into an appliance and access other appliances one by one in the cluster and configure the smart licensing feature without logging off from the first appliance.

---

For more information, see [Centralized Management Using Clusters, on page 1183](#).

## Cisco Email Security Virtual Appliance Virtual Email Gateway License

To set up and license a virtual appliance, see the *Cisco Content Security Virtual Appliance Installation Guide* . This document is available from the location specified in [Documentation](#) .



**Note** You cannot open a Technical Support tunnel or run the System Setup Wizard before installing the virtual appliance license.

---

## Virtual Appliance License Expiration

After the virtual appliance license expires, the appliance will continue to deliver mail without security services for 180 days. Security service updates do not occur during this period.

Alerts will be sent 180 days, 150 days, 120 days, 90 days, 60 days, 30 days, 15 days, 5 days, 1 day and 0 seconds before the license expires, and at the same intervals before the grace period ends. These alerts will be of type “System” at severity level “Critical.” To ensure that you receive these alerts, see [Adding Alert Recipients, on page 1022](#).

These alerts are also logged in the system log.



Individual feature keys may expire earlier than the virtual appliance license. You will also receive alerts when these approach their expiration dates.

#### Related Topics

- [Reverting AsyncOS on Virtual Appliances May Impact the License](#) , on page 1018

## Managing the Configuration File

All configuration settings within the appliance can be managed via a single configuration file. The file is maintained in XML (Extensible Markup Language) format.

You can use this file in several ways:

- You can save the configuration file to a different system to back up and preserve crucial configuration data. If you make a mistake while configuring your appliance , you can “roll back” to the most recently saved configuration file.
- You can download the existing configuration file to view the entire configuration for an appliance quickly. (Many newer browsers include the ability to render XML files directly.) This may help you troubleshoot minor errors (like typographic errors) that may exist in the current configuration.
- You can download an existing configuration file, make changes to it, and upload it to the same appliance . This, in effect, “bypasses” both the CLI and the web interface for making configuration changes.
- You can upload entire configuration file via FTP access, or you can paste portions of or an entire configuration file directly into the CLI.
- Because the file is in XML format, an associated DTD (document type definition) that describes all of the XML entities in the configuration file is also provided. You can download the DTD to validate an XML configuration file before uploading it. (XML Validation tools are readily available on the Internet.)

## Managing Multiple Appliances with XML Configuration Files

- You can download an existing configuration file from one appliance , make changes to it, and upload it to a different appliance . This lets you manage an installation of multiple appliances more easily. Currently you may not load configuration files from C/X-Series appliances onto an M-Series appliance.
- You can divide an existing configuration file downloaded from one appliance into multiple subsections. You can modify those sections that are common among all applianceS (in a multiple appliance environment) and load them onto other appliances as the subsections are updated.

For example, you could use an appliance in a test environment for testing the Global Unsubscribe command. When you feel that you have configured the Global Unsubscribe list appropriately, you could then load the Global Unsubscribe configuration section from the test appliance to all of your production appliances .

## Managing Configuration Files

To manage configuration files on your appliance , click the System Administration> Configuration File.

The Configuration File page contains the following sections:

- **Current Configuration** - used to save and export the current configuration file.
- **Load Configuration** - used to load a complete or partial configuration file.

- **End-User Safelist/Blocklist Database (Spam Quarantine)** - For information, see [Using Safelists and Blocklists to Control Email Delivery Based on Sender](#), on page 925 and [Backing Up and Restoring the Safelist/Blocklist](#), on page 934.
- **Reset Configuration** - used to reset the current configuration back to the factory defaults (you should save your configuration prior to resetting it).



**Note** The private keys and certificates are included in unencrypted PEM format along with the configuration file with encrypted passphrase.

### Related Topics

- [Saving and Exporting the Current Configuration File, on page 996](#)
- [Loading a Configuration File, on page 997](#)
- [Mailing the Configuration File, on page 997](#)
- [Resetting the Current Configuration, on page 999](#)

## Saving and Exporting the Current Configuration File

Using the **Current Configuration** section of the **System Administration > Configuration File** page, you can save the current configuration file to your local machine, save it on the appliance (placed in the configuration directory in the FTP/SCP root), or email it to the address specified.

The following information is not saved with the configuration file:

- Certificates used for secure communications with services used by the URL filtering feature.
- CCO User IDs and Contract ID saved on the Contact Technical Support page.

You can mask the user's passphrases by clicking the **Mask passphrases in the Configuration Files** checkbox. Masking a passphrase causes the original, encrypted passphrase to be replaced with "\*\*\*\*\*" in the exported or saved file. Please note, however, that configuration files with masked passphrases cannot be loaded back into AsyncOS.

You can encrypt the user's passphrases by clicking the **Encrypt passphrases in the Configuration Files** checkbox. The following are the critical security parameters in the configuration file that will be encrypted.

- Certificate private keys
- RADIUS passwords
- LDAP bind passwords
- Local users' password hashes
- SNMP password
- DK/DKIM signing keys
- Outgoing SMTP authentication passwords
- PostX encryption keys
- PostX encryption proxy password
- FTP Push log subscriptions' passwords
- IPMI LAN password
- Updater server URLs

You can also configure this in the command-line interface using the `saveconfig` command.

## Mailing the Configuration File

Use the Email file to field in the System Administration > Configuration File or use the `mailconfig` command to email the current configuration to a user as an attachment.

## Loading a Configuration File

Use the Load Configuration section of the **System Administration > Configuration File** page to load new configuration information into the appliance . You can also configure this in the command-line interface using the `loadconfig` command.

You can load information in one of three methods:

- Placing information in the `configuration` directory and uploading it.
- Uploading the configuration file directly from your local machine.
- Pasting configuration information directly.



---

**Note** Configuration files with masked passphrases cannot be loaded.

In cluster mode, you can either choose to load the configuration for a cluster or an appliance . For instructions to load cluster configuration, see [Loading a Configuration in Clustered Appliances , on page 1204](#).

---

Regardless of the method, you must include the following tags at the top of your configuration:

```
<?xml version="1.0" encoding="ISO-8859-1"?>

<!DOCTYPE config SYSTEM "config.dtd">

<config>

... your configuration information in valid XML

</config>
```

The closing `</config>` tag should follow your configuration information. The values in XML syntax are parsed and validated against the DTD (document type definition) located in the `configuration` directory on your appliance . The DTD file is named `config.dtd` . If validation errors are reported at the command line when you use the `loadconfig` command, the changes are not loaded. You can download the DTD to validate configuration files outside of the appliance before uploading them.

In either method, you can import an entire configuration file (the information defined between the highest level tags: `<config></config>` ), or a *complete* and *unique* sub-section of the configuration file, as long as it contains the declaration tags (above) and is contained within the `<config></config>` tags.

“Complete” means that the entire start and end tags for a given subsection as defined by the DTD are included. For example, uploading or pasting this:

```
<?xml version="1.0" encoding="ISO-8859-1"?>

<!DOCTYPE config SYSTEM "config.dtd">

<config>
```

```
<autosupport_enabled>0</autosu
</config>
```

will cause validation errors, while uploading. This, however:

```
<?xml version="1.0" encoding="ISO-8859-1"?>
<!DOCTYPE config SYSTEM "config.dtd">
<config>
<autosupport_enabled>0</autosupport_enabled>
</config>
```

will not.

“Unique” means that the subsection of the configuration file being uploaded or pasted is not ambiguous for the configuration. For example, a system can have only one hostname, so uploading this (including the declarations and `<config></config>` tags):

```
<hostname>mail4.example.com</hostname>
```

is allowed. However, a system can have multiple listeners defined, each with different Recipient Access Tables defined, so uploading only this:

```
<rat>
 <rat_entry>
 <rat_address>ALL</rat_address>
 <access>RELAY</access>
 </rat_entry>
</rat>
```

is considered ambiguous and is not allowed, even though it is “complete” syntax.



### Caution

When uploading or pasting a configuration file or subsections of a configuration file, you have the potential to erase uncommitted changes that may be pending.

If disk space allocations in the configuration file are smaller than the amount of data currently stored on the appliance, the oldest data will be deleted to meet the quota specified in the configuration file.

## Empty vs. Omitted Tags

Use caution when uploading or pasting sections of configuration files. If you do not include a tag, then its value in the configuration is not modified when you load a configuration file. However, if you include an empty tag, then its configuration setting is cleared.

For example, uploading this:

```
<listeners></listeners>
```

will remove all listeners from the system!

**Caution**

When uploading or pasting subsections of a configuration file, you have the potential to disconnect yourself from the web interface or CLI and to destroy large amounts of configuration data. Do not disable services with this command if you are not able to reconnect to the appliance using another protocol, the Serial interface, or the default settings on the Management port. Also, do not use this command if you are unsure of the exact configuration syntax as defined by the DTD. Always back up your configuration data prior to loading a new configuration file.

**Note About Loading Passphrases for Log Subscriptions**

If you attempt to load a configuration file that contains a log subscription that requires a passphrase (for example, one that will use FTP push), the `loadconfig` command does not warn you about the missing passphrase. The FTP push will fail and alerts will be generated until you configure the correct passphrase using the `logconfig` command.

**Note About Character Set Encoding**

The “encoding” attribute of the XML configuration file must be “ ISO-8859-1 ” regardless of the character set you may be using to manipulate the file offline. Note that the encoding attribute is specified in the file whenever you issue the `showconfig`, `saveconfig`, or `mailconfig` commands:

```
<?xml version="1.0" encoding="ISO-8859-1"?>
```

Currently, only configuration files with this encoding can be loaded.

**Related Topics**

- [Loading a Configuration in Clustered Appliances , on page 1204](#)

## Resetting the Current Configuration

Resetting the current configuration causes your appliance to revert back to the original factory defaults. You should save your configuration prior to resetting it. Resetting the configuration via this button in the GUI is not supported in a clustering environment.

See [Resetting to Factory Defaults, on page 985](#).

## Viewing the Configuration File

You can view the configuration file details using the `showconfig` command only. The `showconfig` command prints the current configuration to the screen.

```
mail3.example.com> showconfig
```

```
Do you want to include passphrases? Please be aware that a configuration without
passphrases will fail when reloaded with loadconfig.
```

```
<?xml version="1.0" encoding="ISO-8859-1"?>
<!DOCTYPE config SYSTEM "config.dtd">
<!--
```

```
Product: IronPort model number Messaging Gateway Appliance(tm)
Model Number: model number
Version: version of AsyncOS installed
Serial Number: serial number
```

```
Current Time: current time and date
```

```
[The remainder of the configuration file is printed to the screen.]
```

## Configuration File Page

- [Managing the Configuration File, on page 995](#)
- [Resetting to Factory Defaults, on page 985](#)
- [Backing Up and Restoring the Safelist/Blocklist , on page 934](#)

## Managing Disk Space

- [\(Virtual Appliances Only\) Increasing Available Disk Space , on page 1000](#)
- [Viewing and Allocating Disk Space Usage , on page 1001](#)
- [Managing Disk Space for the Miscellaneous Quota , on page 1001](#)
- [Ensuring That You Receive Alerts About Disk Space , on page 1002](#)

### (Virtual Appliances Only) Increasing Available Disk Space

For virtual appliances running ESXi 5.5 and VMFS 5, you can allocate more than 2TB of disk space. For appliances running ESXi 5.1, the limit is 2 TB.

To add disk space to the virtual appliance instance:



---

**Note** Disk space reduction is not supported. See the VMWare documentation for information.

---

#### Before You Begin

Carefully determine the disk space increase needed.

#### Procedure

---

**Step 1** Bring down the appliance instance.

**Step 2** Increase disk space using utilities or administrative tools provided by VMWare.

See information about changing the virtual disk configuration in the VMWare documentation. At time of release, this information for ESXi 5.5 was available here: <http://pubs.vmware.com/vsphere-55/index.jsp?topic=%2Fcom.vmware.vsphere.hostclient.doc%2FGUID-81629CAB-72FA-42F0-9F86-F8FD0DE39E57.html>.

**Step 3** Go to **System Administration > Disk Management** and verify that your change has taken effect.

## Viewing and Allocating Disk Space Usage

You can optimize disk usage by allocating disk space on the appliance among the features that your deployment uses.

To	Do This
<ul style="list-style-type: none"> <li>View disk space quotas and current usage for each service</li> <li>Reallocate disk space on your appliance at any time</li> </ul>	Go to <b>System Administration &gt; Disk Management</b> .
Manage data volume	<ul style="list-style-type: none"> <li>For reporting and tracking services and the spam quarantine, the oldest data will be deleted automatically.</li> <li>For Policy, Virus and Outbreak quarantines, the default action configured in the quarantine will be taken. See <a href="#">Default Actions for Automatically Processed Quarantined Messages</a>, on page 903.</li> <li>For the Miscellaneous quota, you must first manually delete data to reduce usage below the new quota you will set. See <a href="#">Managing Disk Space for the Miscellaneous Quota</a>, on page 1001.</li> </ul>

## Managing Disk Space for the Miscellaneous Quota

The Miscellaneous quota includes System data and User data. You cannot delete System data. User data that you can manage includes the following types of files:

To Manage	Do this
Log files	Go to <b>System Administration &gt; Log Subscriptions</b> and: <ul style="list-style-type: none"> <li>Look to see which log directories consume the most disk space.</li> <li>Verify that you need all of the log subscriptions that are being generated.</li> <li>Verify that the log level is no more verbose than necessary.</li> <li>If feasible, reduce the rollover file size.</li> </ul>
Packet captures	Go to <b>Help and Support</b> (near the upper right side of your screen) > <b>Packet Capture</b> .
Configuration files (These files are unlikely to consume much disk space.)	FTP to the /data/pub directory on the appliance . To configure FTP access to the appliance, see <a href="#">FTP, SSH, and SCP Access</a> , on page 1261
Quota size	Go to <b>System Administration &gt; Disk Management</b> .

## Ensuring That You Receive Alerts About Disk Space

You will begin to receive system alerts at warning level when Miscellaneous disk usage reaches 75% of the quota. You should take action when you receive these alerts.

To ensure that you receive these alerts, see [Alerts, on page 1021](#).

## Disk Space and Centralized Management

Disk space management is available only in machine mode, not in group or cluster mode.

## Managing Security Services

The Services Overview page lists the current service and rule versions of the following engines:

- Graymail
- McAfee
- Sophos

You can perform the following tasks in the Services Overview page:

- Manually update the engines. For more information, see [Manually Updating the Engines, on page 1003](#)
- Rollback to previous version of the engine. For more information, see [Rollback to Previous Version of Engine, on page 1003](#)

The **Auto Update** column shows the status of the automatic updates of a particular engine. If you want to enable or disable Automatic Updates, go to the **Global Settings** page of particular engine.

When automatic updates are disabled for a specific service engine, you will receive alerts periodically. If you want to change the alert interval, use the **Alert Interval for Disabled Automatic Engine Updates** option in the Security Services > Service Updates page.



---

**Note** Auto Updates are disabled automatically for the engine on which the rollback is applied.

---

### Related Topics

- [Manually Updating the Engines, on page 1003](#)
- [Rollback to Previous Version of Engine, on page 1003](#)
- [Viewing Logs, on page 1003](#)
- [System Alerts, on page 1029](#)



## Manually Updating the Engines

### Procedure

---

- Step 1** Go to **Security Services > Services Overview** page.
- Step 2** Click **Update** in the **Available Updates** column for the latest service or rule version of the service engine.
- Note** The **Update** option is available only if new updates are available for the particular engine.
- 

## Rollback to Previous Version of Engine

### Procedure

---

- Step 1** Go to **Security Services > Services Overview** page.
- Step 2** Click **Change** in the **Modify Versions** column.
- Step 3** Select the required rule and service version of the update and click **Apply**.

The appliance rolls back the engine to the previous version.

**Note** A Service Updates includes the service version and the rule version together as a package.

Once you click **Apply**, the automatic updates for the particular engine is automatically disabled. To enable the automatic updates, go to the Global Settings page of the particular engine.

---

## Viewing Logs

The information about engine rollback and disabling automatic updates is posted to the following logs:

- **Updater Logs:** Contains information about the engine rollback and automatic updating of the engine. Most information is at Info or Debug level.

For more information, see [Updater Log Example, on page 1161](#).

## Service Updates

The following services require updates for maximum effectiveness:

- Feature Keys
- McAfee Anti-Virus definitions
- PXE Engine
- Sophos Anti-Virus definitions
- IronPort Anti-Spam rules
- Outbreak Filters rules

- Time zone rules
- URL categories (Used for URL filtering features. For details, see [Future URL Category Set Changes](#) , on page 456)
- Enrollment client (Used for updating certificates needed for communication with cloud-based services used for URL filtering features. For information, see [About the Connection to Talos Intelligence Services](#) , on page 428.)
- Graymail rules



**Note** Settings for the DLP engine and content matching classifiers are handled on the **Security Services > Data Loss Prevention** page. See [About Updating the DLP Engine and Content Matching Classifiers](#), on page 512 for more information.

Service update settings are used for all services that receive updates except DLP updates. You cannot specify unique settings for any individual service except DLP updates.

To set up the network and the appliance to obtain these critical updates, see [Setting Up to Obtain Upgrades and Updates](#) , on page 1004.

## Setting Up to Obtain Upgrades and Updates

- [Options for Distributing Upgrades and Updates](#) , on page 1004
- [Configuring Your Network to Download Upgrades and Updates from the Cisco Servers](#) , on page 1004
- [Configuring the Appliance for Upgrades and Updates in Strict Firewall Environments](#), on page 1005
- [Upgrading and Updating from a Local Server](#), on page 1005
- [Hardware and Software Requirements for Upgrading and Updating from a Local Server](#), on page 1006
- [Hosting an Upgrade Image on a Local Server](#), on page 1007
- [Configuring Server Settings for Downloading Upgrades and Updates](#) , on page 1008
- [Configuring Automatic Updates](#) , on page 1010
- [Configuring the Appliance to Verify the Validity of Updater Server Certificate](#), on page 1010
- [Configuring the Email Gateway to Trust Proxy Server Communication](#), on page 1011

## Options for Distributing Upgrades and Updates

There are several ways to distribute AsyncOS upgrade and update files to your appliances:

- Each appliance can download the files directly from the Cisco update servers. This is the default method.
- You can download the files from Cisco once, and then distribute them to your appliances from a server within your network. See [Upgrading and Updating from a Local Server](#), on page 1005.

To choose and configure a method, see [Configuring Server Settings for Downloading Upgrades and Updates](#) , on page 1008.

## Configuring Your Network to Download Upgrades and Updates from the Cisco Servers

The appliance connect directly to the Cisco update servers to find and download upgrades and updates:

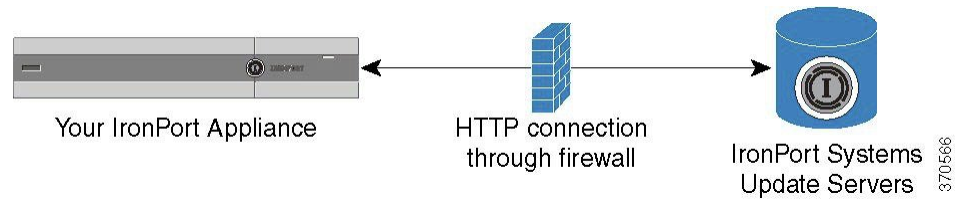
**Figure 73: Streaming Update Method**

Cisco update servers use dynamic IP addresses. If you have strict firewall policies, you may need to configure a static location instead. For more information, see [Configuring the Appliance for Upgrades and Updates in Strict Firewall Environments, on page 1005](#).

Create a firewall rule to allow downloading of upgrades from Cisco update servers on ports 80 and 443.

## Configuring the Appliance for Upgrades and Updates in Strict Firewall Environments

The Cisco IronPort upgrade and update servers use dynamic IP addresses. If you have strict firewall policies, you may need to configure a static location for updates and AsyncOS upgrades.

### Procedure

- 
- Step 1** Contact Cisco Customer support to obtain the static URL address.
  - Step 2** Create a firewall rule to allow downloading of upgrades and updates from the static IP address on port 80.
  - Step 3** Choose **Security Services > Service Updates**.
  - Step 4** Click **Edit** Update Settings.
  - Step 5** On the Edit Update Settings page, in the “Update Servers (images)” section, choose Local Update Servers and enter the static URL received in step 1 in the Base URL field for AsyncOS upgrades and McAfee Anti-Virus definitions.
  - Step 6** Verify that IronPort Update Servers is selected for the “Update Servers (list)” section.
  - Step 7** Submit and commit your changes.
- 

## Upgrading and Updating from a Local Server

You can download AsyncOS upgrade images to a local server and host upgrades from within your own network rather than obtaining upgrades directly from Cisco’s update servers. Using this feature, an upgrade image is downloaded via HTTP to any server in your network that has access to the Internet. If you choose to download the upgrade image, you can then configure an internal HTTP server (an “update manager”) to host the AsyncOS images to your appliances.

Use a local server if your appliance does not have access to the internet, or if your organization restricts access to mirror sites used for downloads. Downloading AsyncOS upgrades to each appliance from a local server is generally faster than downloading from the Cisco IronPort servers.



**Note** Cisco recommends using a local server only for AsyncOS upgrades. If you use a local update server for security update images, the local server does not automatically receive security updates from Cisco IronPort, so the appliances in your network may not always have the most current security services.

**Figure 74: Remote Update Method**

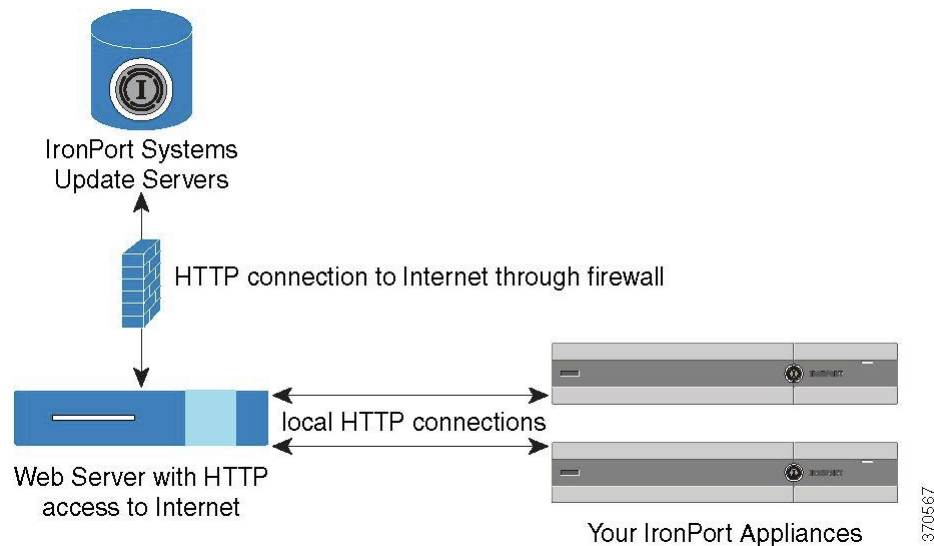

### Procedure

- Step 1** Configure a local server to retrieve and serve the upgrade files.
- Step 2** Download the upgrade files.
- Step 3** Configure the appliance to use the local server using either the **Security Services > Service Updates** page in the GUI or the `updateconfig` command in the CLI.
- Step 4** Upgrade the appliance using either the **System Administration > System Upgrade** page or the upgrade command in the CLI.

## Hardware and Software Requirements for Upgrading and Updating from a Local Server

For *downloading* AsyncOS upgrade and update files, you must have a system in your internal network that has:

- Internet access to the Cisco Systems update servers.
- A web browser (see [Browser Requirements](#), on page 11).



---

**Note** For this release, if you need to configure a firewall setting to allow HTTP access to this address, you must configure it using the DNS name and not a specific IP address.

---

For *hosting* AsyncOS update files, you must have a server in your internal network that has:

- A web server — for example, Microsoft IIS (Internet Information Services) or the Apache open source server — which:
  - supports the display of directory or filenames in excess of 24 characters
  - has directory browsing enabled
  - is configured for anonymous (no authentication) or basic (“simple”) authentication
  - contains at least 350MB of free disk space for each AsyncOS update image

## Hosting an Upgrade Image on a Local Server

After setting up a local server, go to [http://updates.ironport.com/fetch\\_manifest.html](http://updates.ironport.com/fetch_manifest.html) to download a ZIP file of an upgrade image. To download the image, enter your serial number (for a physical appliance ) or a VLN (for a virtual appliance ) and the version number of the appliance . You will then be presented with a list of available upgrades. Click on the upgrade version that you want to download, and unzip the ZIP file in the root directory on the local server while keeping the directory structure intact. To use the upgrade image, configure the appliance to use the local server on the Edit Update Settings page (or use `updateconfig` in the CLI).

The local server also hosts an XML file that limits the available AsyncOS upgrades for the appliances on your network to the downloaded upgrade image. This file is called the “manifest.” The manifest is located in the `asynco`s directory of the upgrade image ZIP file. After unzipping the ZIP file in the root directory of the local server, enter the full URL for the XML file, including the filename, on the Edit Update Settings page (or use `updateconfig` in the CLI).

For more information about remote upgrades, please see the Knowledge Base or contact your Cisco Support provider.

## UpdatesThrough a Proxy Server

The appliance is configured (by default) to connect directly to Cisco’s update servers to receive updates. This connection is made by HTTP on port 80 and the content is encrypted. If you do not want to open this port in your firewall, you can define a proxy server and specific port from which the appliance can receive updated rules.

If you choose to use a proxy server, you can specify an optional authentication and port.



---

**Note** If you define a proxy server, it will *automatically* be used for all service updates that are configured to use a proxy server. There is no way to turn off the proxy server for updates to any individual service.

---

## Configuring Server Settings for Downloading Upgrades and Updates

Specify the server and connection information required to download upgrades and updates to your appliance .

You can use the same or different settings for AsyncOS upgrades and for service updates.

### Before You Begin

Determine whether the appliance will download upgrades and updates directly from Cisco, or whether you will host these images from a local server on your network instead. Then set up your network to support the method you choose. See all topics under [Setting Up to Obtain Upgrades and Updates](#) , on page 1004.

### Procedure

**Step 1** Choose **Security Services > Service Updates**.

**Step 2** Click **Edit Update Settings**.

**Step 3** Enter options:

Setting	Description
<b>Update Servers (images)</b>	<p>Choose whether to download Cisco IronPort AsyncOS upgrade images and service updates from the Cisco IronPort update servers or a from a local server on your network. The default is the Cisco IronPort update servers for both upgrades and updates.</p> <p>To use the same settings for upgrades and updates, enter information in the visible fields.</p> <p>If you choose a local update server, enter the base URL and port number for the servers used to download the upgrades and updates. If the server requires authentication, you can also enter a valid username and passphrase.</p> <p>To enter separate settings solely for AsyncOS upgrades and McAfee Anti-Virus definitions, click the <b>Click to use different settings for AsyncOS</b> link.</p> <p><b>Note</b> Cisco Intelligent Multi-Scan requires a second local server to download updates for third-party anti-spam rules.</p>

Setting	Description
Update Servers (lists)	<p>To ensure that only upgrades and updates that are appropriate to your deployment are available to each appliance, Cisco IronPort generates a manifest list of the relevant files.</p> <p>Choose whether to download the lists of available upgrades and service updates (the manifest XML files) from the Cisco IronPort update servers or from a local server on your network.</p> <p>There are separate sections for specifying servers for updates and for AsyncOS upgrades. The default for upgrades and updates is the Cisco IronPort update servers.</p> <p>If you choose local update servers, enter the full path to the manifest XML file for each list, including the file name and HTTP port number for the server. If you leave the port field blank, AsyncOS uses port 80. If the server requires authentication, enter a valid user name and passphrase.</p>
<b>Automatic Updates</b>	<p>Enable automatic updates and the update interval (how often the appliance checks for updates) for Sophos and McAfee Anti-Virus definitions, Cisco Anti-Spam rules, Cisco Intelligent Multi-Scan rules, PXE Engine updates, Outbreak Filter rules, and time zone rules.</p> <p>Include a trailing s, m, or h to indicate seconds, minutes, or hours. Enter 0 (zero) to disable automatic updates.</p> <p><b>Note</b> You can only turn on automatic updates for DLP using the <b>Security Services &gt; Data Loss Prevention</b> page. However, you must enable automatic updates for all services first. See <a href="#">About Updating the DLP Engine and Content Matching Classifiers</a>, on page 512 for more information.</p>
<b>Alert Interval for Disabled Automatic Engine Updates</b>	<p>Enter specific frequency of alerts to be sent when the 'Automatic Updates' feature is disabled for a specific engine.</p> <p>Include a trailing m, h, or d to indicate months, hours, or days. The default value is 30 days.</p>
<b>Interface</b>	<p>Choose which network interface to use when contacting the update servers for the listed security component updates. The available proxy data interfaces are shown. By default, the appliance selects an interface to use.</p>
<b>HTTP Proxy Server</b>	<p>An optional proxy server used for the services listed in the GUI.</p> <p>If you specify a proxy server, it will be used to update ALL services.</p>
<b>HTTPS Proxy Server</b>	<p>An optional proxy server using HTTPS. If you define the HTTPS proxy server, it will be used to update the services listed in the GUI.</p>

**Step 4** Submit and commit your changes.

## Configuring Automatic Updates

### Procedure

- 
- Step 1** Navigate to the **Security Services > Service Updates** page, and click **Edit Update Settings**.
  - Step 2** Select the check box to enable automatic updates.
  - Step 3** Enter an update interval (time to wait between checks for updates). Add a trailing **m** for minutes and **h** for hours. The maximum update interval is 1 hour.
- 

## Configuring the Appliance to Verify the Validity of Updater Server Certificate

The appliance can check the validity of Cisco updater server certificate every time the appliance communicates the updater server. If you configure this option and the verification fails, updates are not downloaded and the details are logged in Updater Logs.

Use the `updateconfig` command to configure this option. The following example shows how to configure this option.

```
mail.example.com> updateconfig
Service (images): Update URL:

Feature Key updates http://downloads.ironport.com/asyncos
Timezone rules Cisco IronPort Servers
Enrollment Client Updates Cisco IronPort Servers
Support Request updates Cisco IronPort Servers
Cisco IronPort AsyncOS upgrades Cisco IronPort Servers
Service (list): Update URL:

Timezone rules Cisco IronPort Servers
Enrollment Client Updates Cisco IronPort Servers
Support Request updates Cisco IronPort Servers
Service (list): Update URL:

Cisco IronPort AsyncOS upgrades Cisco IronPort Servers
Update interval: 5m
Proxy server: not enabled
HTTPS Proxy server: not enabled
Choose the operation you want to perform:
- SETUP - Edit update configuration.
- VALIDATE_CERTIFICATES - Validate update server certificates
- TRUSTED_CERTIFICATES - Manage trusted certificates for updates
[> validate_certificates
Should server certificates from Cisco update servers be validated?
[Yes]>
Service (images): Update URL:

Feature Key updates http://downloads.ironport.com/asyncos
Timezone rules Cisco IronPort Servers
Enrollment Client Updates Cisco IronPort Servers
Support Request updates Cisco IronPort Servers
Cisco IronPort AsyncOS upgrades Cisco IronPort Servers
Service (list): Update URL:

Timezone rules Cisco IronPort Servers
```



```

Enrollment Client Updates Cisco IronPort Servers
Support Request updates Cisco IronPort Servers
Service (list): Update URL:

Cisco IronPort AsyncOS upgrades Cisco IronPort Servers
Update interval: 5m
Proxy server: not enabled
HTTPS Proxy server: not enabled
Choose the operation you want to perform:
- SETUP - Edit update configuration.
- VALIDATE_CERTIFICATES - Validate update server certificates
- TRUSTED_CERTIFICATES - Manage trusted certificates for updates
[]>

```

## Configuring the Email Gateway to Trust Proxy Server Communication

If you are using a non-transparent proxy server, you can add the CA certificate used to sign the proxy certificate to the appliance. By doing so, the appliance trusts the proxy server communication.

Use the `updateconfig` command to configure this option. The following example shows how to configure this option.

```

mail.example.com> updateconfig
...
...
...
Choose the operation you want to perform:
- SETUP - Edit update configuration.
- VALIDATE_CERTIFICATES - Validate update server certificates
- TRUSTED_CERTIFICATES - Manage trusted certificates for updates
[]> trusted_certificates
Choose the operation you want to perform:
- ADD - Upload a new trusted certificate for updates.
[]> add
Paste certificates to be trusted for secure updater connections, blank to quit
Trusted Certificate for Updater:
Paste cert in PEM format (end with '.'):
-----BEGIN CERTIFICATE-----
MMIICiDCCAfGgAwIBAgIBATANBgkqhkiG9w0BAQUFADCBgDELMAkGA1UEBhMCSU4x
DDAKBgNVBAGTA0tBUjENM.....
-----END CERTIFICATE-----
.
Choose the operation you want to perform:
- ADD - Upload a new trusted certificate for updates.
- LIST - List trusted certificates for updates.
- DELETE - Delete a trusted certificate for updates.
[]>

```

# Upgrading AsyncOS

## Procedure

	Command or Action	Purpose
<b>Step 1</b>	If you have not yet done so, configure settings that apply to all update and upgrade downloads, and set up your network to support and optionally distribute these downloads.	<a href="#">Setting Up to Obtain Upgrades and Updates</a> , on page 1004
<b>Step 2</b>	Understand when an upgrade is available and determine whether to install it.	<a href="#">Notifications of Available Upgrades</a> , on page 1012
<b>Step 3</b>	Perform required and recommended tasks before each upgrade.	<a href="#">Preparing to Upgrade AsyncOS</a> , on page 1013 <a href="#">Upgrading Machines in a Cluster</a> , on page 1194
<b>Step 4</b>	Perform the upgrade.	<a href="#">Downloading and Installing the Upgrade</a> , on page 1013

## About Upgrading Clustered Systems

If you are upgrading clustered machines, please see [Upgrading Machines in a Cluster](#), on page 1194.

## About Batch Commands for Upgrade Procedures

Batch commands for upgrade procedures are documented in the *CLI Reference Guide for AsyncOS for Cisco Email Security Appliances* at [http://www.cisco.com/en/US/products/ps10154/prod\\_command\\_reference\\_list.html](http://www.cisco.com/en/US/products/ps10154/prod_command_reference_list.html).

## Notifications of Available Upgrades

By default, users with administrator and technician privileges will see a notification at the top of the web interface when an AsyncOS upgrade is available for the appliance .

On clustered machines, actions apply only to the machine to which you are logged in.

To	Do This
View more information about the latest upgrade	Hover over the upgrade notification.
View a list of all available upgrades	Click the down arrow in the notification.
Dismiss a current notification. The appliance will not display another notification until a new upgrade becomes available.	Click the down arrow, then select <b>Clear the notification</b> , then click <b>Close</b> .
Prevent future notifications (Users with Administrator privileges only.)	Go to <b>Management Appliance &gt; System Administration &gt; System Upgrade</b> .

## Notifications of Available Upgrades

By default, users with administrator and technician privileges will see a notification at the top of the web interface when an AsyncOS upgrade is available for the appliance .

On clustered machines, actions apply only to the machine to which you are logged in.

To	Do This
View more information about the latest upgrade	Hover over the upgrade notification.
View a list of all available upgrades	Click the down arrow in the notification.
Dismiss a current notification. The appliance will not display another notification until a new upgrade becomes available.	Click the down arrow, then select <b>Clear the notification</b> , then click <b>Close</b> .
Prevent future notifications (Users with Administrator privileges only.)	Go to <b>Management Appliance &gt; System Administration &gt; System Upgrade</b> .

## Preparing to Upgrade AsyncOS

As a best practice, Cisco recommends preparing for an upgrade by taking the following steps.

### Before you begin

Clear all the messages in your work queue. You cannot perform the upgrade without clearing your work queue.

### Procedure

- 
- Step 1** Save the XML configuration file off-box. If you need to revert to the pre-upgrade release for any reason, you will need this file.
  - Step 2** If you are using the Safelist/Blocklist feature, export the list off-box.
  - Step 3** Suspend all listeners. If you perform the upgrade from the CLI, use the suspendlistener command. If you perform the upgrade from the GUI, listener suspension occurs automatically.
  - Step 4** Wait for the queue to empty. You can use the workqueue command to view the number of messages in the work queue or the rate command in the CLI to monitor the message throughput on your appliance .

**Note** Re-enable the listeners post-upgrade.

---

## Downloading and Installing the Upgrade

You can download and install in a single operation, or download in the background and install later.



---

**Note** When downloading and upgrading AsyncOS in a single operation from a local server instead of from a Cisco IronPort server, the upgrade installs immediately *while downloading*. A banner displays for 10 seconds at the beginning of the upgrade process. While this banner is displayed, you have the option to type Control-C to exit the upgrade process before downloading starts.

---

### Before You Begin

- Choose whether you will download upgrades directly from Cisco or will host upgrade images from a server on your network. Then set up your network to support the method you choose. Then configure the appliance to obtain upgrades from your chosen source. See [Setting Up to Obtain Upgrades and Updates](#), on page 1004 and [Configuring Server Settings for Downloading Upgrades and Updates](#), on page 1008.
- If you will install the upgrade now, follow the instructions in [Preparing to Upgrade AsyncOS](#), on page 1013.
- If you are installing the upgrade in a clustered system, see [Upgrading Machines in a Cluster](#), on page 1194.
- If you will only download the upgrade, there are no prerequisites until you are ready to install it.
- After you upgrade, you cannot use TLS v1.0 in FIPS mode. However, you can re-enable TLS v1.0 on the appliance, if necessary.

### Procedure

---

**Step 1** Choose **System Administration > System Upgrade**.

**Step 2** Click **Upgrade Options**.

The system analyzes historical data (up to three months) in the Status Logs to determine the health of the appliance and provides recommendation on whether the appliance can be upgraded.

**Note** For the system to perform this analysis, the Status Logs must contain a minimum of one month of logging data.

**Step 3** Depending on the result of the analysis, do one of the following:

- If the analysis detected that the system has experienced one of the following problems in the last few months, follow the displayed recommendation.
  - Resource conservation mode
  - Delay in mail processing
  - High CPU usage
  - High memory usage
  - High memory page swapping
- If the system is unable to perform the analysis (due to insufficient data in the Status Logs), no recommendations are provided. In this scenario, consider upgrading the appliance only if the appliance has not experienced any problems recently.
- If the analysis did not detect any problems, go to Step 4.

**Step 4** Choose an option:

To	Do This
Download and install the upgrade in a single operation	Click <b>Download and Install</b> . If you have already downloaded an installer, you will be prompted to overwrite the existing download.
Download an upgrade installer	Click <b>Download only</b> . If you have already downloaded an installer, you will be prompted to overwrite the existing download. The installer downloads in the background without interrupting service.
Install a downloaded upgrade installer	Click <b>Install</b> . This option appears only if an installer has been downloaded. The AsyncOS version to be installed is noted below the Install option.

**Step 5** Unless you are installing a previously-downloaded installer, select an AsyncOS version from the list of available upgrades.

**Step 6** If you are installing:

- a) Choose whether or not to save the current configuration to the configuration directory on the appliance .
- b) Choose whether or not to mask the passphrases in the configuration file.

**Note** You cannot load a configuration file with masked passphrases using the Configuration File page in the GUI or the loadconfig command in the CLI.

- c) If you want to email copies of the configuration file, enter the email addresses to which you want to email the file. Use commas to separate multiple email addresses.

**Step 7** Click **Proceed**.

**Step 8** If you are installing:

- a) Be prepared to respond to prompts during the process.  
The process pauses until you respond.  
A progress bar appears near the top of the page.
- b) At the prompt, click **Reboot Now**.
- c) After about 10 minutes, access the appliance again and log in.

If you feel you need to power-cycle the appliance to troubleshoot an upgrade issue, do not do so until at least 20 minutes have passed since you rebooted.

### What to do next

- If the process was interrupted, you must start the process again.
- If you downloaded but did not install the upgrade:

When you are ready to install the upgrade, follow these instructions from the beginning, including the prerequisites in the Before You Begin section, but choose the Install option.

- If you installed the upgrade:

- Re-enable (resume) the listeners.
- Save a configuration file for the new system. For information, see [Managing the Configuration File, on page 995](#).
- After upgrade is complete, re-enable listeners.

## Viewing Status of, Canceling, or Deleting a Background Download

### Procedure

**Step 1** Choose **System Administration > System Upgrade**.

**Step 2** Click **Upgrade Options**.

**Step 3** Choose an option:

To	Do This
View download status	Look in the middle of the page. If there is no download in progress and no completed download waiting to be installed, you will not see download status information.
Cancel a download	Click the <b>Cancel Download</b> button in the middle of the page. This option appears only while a download is in progress.
Delete a downloaded installer	Click the <b>Delete File</b> button in the middle of the page. This option appears only if an installer has been downloaded.

**Step 4** (Optional) View the Upgrade Logs.

## Enabling Remote Power Cycling

The ability to remotely reset the power for the appliance chassis is available only on 80 - and 90- series hardware.

If you want to be able to remotely reset appliance power, you must enable and configure this functionality in advance, using the procedure described in this section.

### Before You Begin

- Cable the dedicated Remote Power Cycle (RPC) port directly to a secure network. For information, see the Hardware Installation Guide.
- Ensure that the appliance is accessible remotely; for example, open any necessary ports through the firewall.
- This feature requires a unique IPv4 address for the dedicated Remote Power Cycle interface. This interface is configurable only via the procedure described in this section; it cannot be configured using the `ipconfig` command.

- In order to cycle appliance power, you will need a third-party tool that can manage devices that support the Intelligent Platform Management Interface (IPMI) version 2.0. Ensure that you are prepared to use such a tool.
- For more information about accessing the command-line interface, see the CLI reference guide.

### Procedure

---

- Step 1** Use SSH or the serial console port to access the command-line interface.
- Step 2** Sign in using an account with Administrator access.
- Step 3** Enter the following commands:
- ```
remotepower
setup
```
- Step 4** Follow the prompts to specify the following:
- a. The dedicated IP address for this feature, plus netmask and gateway.
 - b. The username and passphrase required to execute the power-cycle command.
- These credentials are independent of other credentials used to access your appliance .
- Step 5** Enter commit to save your changes.
- Step 6** Test your configuration to be sure that you can remotely manage appliance power.
- Step 7** Ensure that the credentials that you entered will be available to you in the indefinite future. For example, store this information in a safe place and ensure that administrators who may need to perform this task have access to the required credentials.
-

What to do next

Related Topics

- [Remotely Resetting Appliance Power](#) , on page 1232

Reverting to a Previous Version of AsyncOS

AsyncOS includes the ability to revert the AsyncOS operating system to a previous qualified build for emergency uses.

Reversion Impact

Using the revert command on an appliance is a very destructive action. This command destroys all configuration logs and databases. Only the network information for the management interface is preserved--all other network configuration is deleted. In addition, reversion disrupts mail handling until the appliance is reconfigured. Because this command destroys network configuration, you may need physical local access to the appliance when you want to issue the revert command.



Caution You must have a configuration file for the version you want to revert to. Configuration files are *not* backwards-compatible.

Reverting AsyncOS on Virtual Appliances May Impact the License

If you revert from AsyncOS 9.0 for Email to AsyncOS 8.5 for Email, the license does not change.

If you revert from AsyncOS 9.0 for Email to AsyncOS 8.0 for Email, there is no longer a 180-day grace period during which the appliance delivers mail without security features.

Feature key expiration dates do not change in either case.

Related Topics

- [Virtual Appliance License Expiration](#) , on page 994

Reverting AsyncOS

Procedure

-
- Step 1** Ensure that you have the configuration file for the version you wish to revert to. Configuration files are not backwards-compatible. To do this, you can email the file to yourself or FTP the file. For information, see [Mailing the Configuration File](#), on page 997.
- Step 2** Save a backup copy of the current configuration of your appliance (with passphrases unmasked) on another machine.
- Note** This is not the configuration file you will load after reverting.
- Step 3** If you use the Safelist/Blocklist feature, export the Safelist/Blocklist database to another machine.
- Step 4** Wait for the mail queue to empty.
- Step 5** Log into the CLI of the appliance you want to revert.
- When you run the revert command, several warning prompts are issued. After these warning prompts are accepted, the revert action takes place immediately. Therefore, do not begin the reversion process until after you have completed the pre-reversion steps.
- Step 6** From the CLI, Issue the **revert** command.
- Note** The reversion process is time-consuming. It may take fifteen to twenty minutes before reversion is complete and console access to the appliance is available again.
- Step 7** Wait for the appliance to reboot twice.
- Step 8** After the machine reboots twice, use the serial console to configure an interface with an accessible IP address using the **interfaceconfig** command.
- Step 9** Enable FTP or HTTP on one of the configured interfaces.
- Step 10** Either FTP the XML configuration file you created, or paste it into the GUI interface.
- Step 11** Load the XML configuration file of the version you are reverting to.
- Step 12** If you use the Safelist/Blocklist feature, import and restore the Safelist/Blocklist database.

Step 13 Commit your changes.

The reverted appliance should now run using the selected AsyncOS version.

Configuring the Return Address for Appliance Generated Messages

It is recommended that you avoid changing return addresses on Cloud appliances .

You can configure the envelope sender for mail generated by AsyncOS for the following circumstances:

- Anti-Virus notifications
- Bounces
- DMARC feedback
- Notifications (notify() and notify-copy() filter actions)
- Quarantine notifications (and “Send Copy” in quarantine management)
- Reports
- All other messages

You can specify the display, user, and domain names of the return address. You can also choose to use the Virtual Gateway domain for the domain name.

You can modify the return address for system-generated email messages in the GUI or in the CLI using the `addressconfig` command.

Procedure

- Step 1** Navigate to the System Administration > Return Addresses page.
- Step 2** Click **Edit Settings**.
- Step 3** Make changes to the address or addresses you want to modify
- Step 4** Submit and commit your changes.
-

Setting Thresholds for System Health Parameters

Depending on your organization's requirements, you can configure the threshold for various health parameters of your appliance such as CPU usage, maximum messages in the workqueue, and so on. You can also configure the appliance to send alerts when the specified threshold values are crossed.



Note To configure the threshold for system health parameters using CLI, use the `healthconfig` command. For more information, see the CLI inline help or *CLI Reference Guide for AsyncOS for Cisco Email Security Appliances*.

Before You Begin

Carefully determine the threshold values.

Procedure

Step 1 Click **System Administration** > **System Health**.

Step 2 Click **Edit Settings**.

Step 3 Configure the following options:

- Specify the threshold level for CPU usage (in percent).

Also, specify if you want to receive an alert if the current CPU usage has crossed the configured threshold value. After the first alert is sent, if the CPU usage crosses the running average from the time the first alert was triggered by five percent in 15 minutes, an additional alert is sent.

Note These alerts are triggered based only on the CPU usage of the mail handling process.

- Specify the threshold level for memory page swapping (in percent).

Also, specify if you want to receive an alert if the overall memory swap usage crosses the configured threshold value. After the first alert is sent, if the memory page swapping crosses the value that triggered the first alert by 150 percent or after a 15 minutes alert interval, an additional alert is sent. For example, if the threshold is set to 10,

- When the memory swap usage reaches 10.1%, the first alert is sent.
- When the memory swap usage reaches 15.1% in 15 minutes, one more alert is sent.

- Specify the threshold level for maximum messages in workqueue (in number of messages).

Also, specify if you want to receive an alert if the number of messages in work queue has crossed the configured threshold value. After the first alert is sent, if the maximum messages in work queue crosses the value that triggered the first alert by 150 percent within 15 minutes, an additional alert is sent. For example, if the threshold is set to 1000,

- When the maximum messages in work queue reached 1002, the first alert was sent.
- When the maximum messages in work queue reached 1510 with 15 minutes, one more alert is sent.

Note All the alerts for this feature belong to the System Alert category.

Step 4 Submit and commit your changes.

What to do next

If you have configured alerts for this feature, make sure that you subscribe to the System Alerts. For instructions, see [Adding Alert Recipients, on page 1022](#).

Checking the Health of Appliance

You can use the health check functionality to check the health of your appliance . When you run the health check, the system analyzes historical data (up to three months) in the current Status Logs to determine the health of the appliance .



Note For the system to perform this analysis, the Status Logs must contain a minimum of one month of logging data.

To run the health check,

- On web interface, go to **System Administration > System Health** page and click **Run Health Check**.
- On CLI, run the command: `healthconfig`.

The analysis results will indicate whether system has experienced one or more of the following problems in the last few months:

- Resource conservation mode
- Delay in mail processing
- High CPU usage
- High memory usage
- High memory page swapping

If the health check is indicating that your appliance has experienced one or more of the above problems, consider reviewing and fine-tuning your system configuration. For more information, see: <http://www.cisco.com/c/en/us/support/docs/security/email-security-appliance/118881-technote-esa-00.html>

Alerts

Alert messages are automatically-generated standard email messages that contain information about events occurring on the appliances. These events can be of varying levels of importance (or severity) from minor to major and pertain generally to a specific component or feature on your appliance. Alerts are generated by the appliance. You can specify, at a much more granular level, which alert messages are sent to which users and for which severity of event they are sent. Manage alerts via the System Administration > Alerts page in the GUI (or via the `alertconfig` command in the CLI).

Alert Severities

Alerts can be sent for the following severities:

- Critical: Requires immediate attention.
- Warning: Problem or error requiring further monitoring and potentially immediate attention.
- Information: Information generated in the routine functioning of this device.

AutoSupport

To allow Cisco to better support and design future system changes, the appliance can be configured to send Cisco Systems a copy of all alert messages generated by the system. This feature, called AutoSupport, is a useful way to allow our team to be proactive in supporting your needs. AutoSupport also sends weekly reports noting the uptime of the system, the output of the `status` command, and the AsyncOS version used.

By default, alert recipients set to receive Information severity level alerts for System alert types will receive a copy of every message sent to Cisco. This can be disabled if you do not want to send the weekly alert messages internally. To enable or disable this feature, see [Configuring Alert Settings, on page 1023](#).

Alert Delivery

Alerts sent from the appliance to addresses specified in the Alert Recipient follow SMTP routes defined for those destinations

Since alert messages can be used to inform you of problems within your appliance, they are not sent using AsyncOS's normal mail delivery system. Instead, alert messages pass through a separate and parallel email system designed to operate even in the face of significant system failure in AsyncOS.

The alert mail system does not share the same configuration as AsyncOS, which means that alert messages may behave slightly differently from other mail delivery:

- Alert messages are delivered using standard DNS MX and A record lookups.
 - They do cache the DNS entries for 30 minutes and the cache is refreshed every 30 minutes, so in case of DNS failure the alerts still go out.
- Alert messages do not pass through the work queue, so they are not scanned for viruses or spam. They are also not subjected to message filters or content filters.
- Alert messages do not pass through the delivery queue, so they are not affected by bounce profiles or destination control limits.

Example Alert Message

```
Date: 23 Mar 2005 21:10:19 +0000

To: joe@example.com

From: IronPort C60 Alert [alert@example.com]

Subject: Critical-example.com: (Anti-Virus) update via http://newproxy.example.com
failed

The Critical message is:

update via http://newproxy.example.com failed

Version: 4.5.0-419

Serial Number: XXXXXXXXXXXX-XXXXXXX

Timestamp: Tue May 10 09:39:24 2005

For more information about this error, please see
http://support.ironport.com

If you desire further information, please contact your support provider.
```

Adding Alert Recipients

The alerting engine allows for granular control over which alerts are sent to which alert recipients. For example, you can configure the system to send only specific alerts to an alert recipient, configuring an alert recipient to receive notifications only when Critical (severity) information about the System (alert type) is sent.



Note If you enabled AutoSupport during System Setup, the email address specified will receive alerts for all severities and classes by default. You can change this configuration at any time.

Procedure

- Step 1** Select **System Administration > Alerts**.
 - Step 2** Click **Add Recipient**.
 - Step 3** Enter the recipient's email address. You can enter multiple addresses, separated by commas.
 - Step 4** (Optional) If you want to receive software release and critical support notification alerts from Cisco Support, check the **Release and Support Notifications** checkbox.
 - Step 5** Select the alert types and severities that this recipient will receive.
 - Step 6** Submit and commit your changes.
-

Configuring Alert Settings

The following settings apply to all alerts.



Note Use the alertconfig CLI command to define the number of alerts to save on the appliance to view later.

Procedure

- Step 1** Click **Edit Settings** on the Alerts page.
 - Step 2** Enter a Header From: address to use when sending alerts, or select Automatically Generated (“alert@<hostname>”).
 - Step 3** Mark the checkbox if you want to specify the number of seconds to wait between sending duplicate alerts. For more information, see [Sending Duplicate Alerts, on page 1024](#).
 - Specify the initial number of seconds to wait before sending a duplicate alert.
 - Specify the maximum number of seconds to wait before sending a duplicate alert.
 - Step 4** You can enable AutoSupport by checking the IronPort AutoSupport option. For more information about AutoSupport, see [AutoSupport, on page 1021](#).
 - If AutoSupport is enabled, the weekly AutoSupport report is sent to alert recipients set to receive System alerts at the Information level. You can disable this via the checkbox.
 - Step 5** Submit and commit your changes.
-

Alert Settings

Alert settings control the general behavior and configuration of alerts, including:

- The RFC 2822 Header From: when sending alerts (enter an address or use the default “alert@<hostname>”). You can also set this via the CLI, using the `alertconfig -> from` command.
- The initial number of seconds to wait before sending a duplicate alert.
- The maximum number of seconds to wait before sending a duplicate alert.
- The status of AutoSupport (enabled or disabled).
- The sending of AutoSupport’s weekly status reports to alert recipients set to receive System alerts at the Information level.

Sending Duplicate Alerts

You can specify the initial number of seconds to wait before AsyncOS will send a duplicate alert. If you set this value to 0, duplicate alert summaries are not sent and instead, all duplicate alerts are sent without any delay (this can lead to a large amount of email over a short amount of time). The number of seconds to wait between sending duplicate alerts (alert interval) is increased after each alert is sent. The increase is the number of seconds to wait plus twice the last interval. So a 5 second wait would have alerts sent at 5 seconds, 15 seconds, 35 seconds, 75 seconds, 155 seconds, 315 seconds, etc.

Eventually, the interval could become quite large. You can set a cap on the number of seconds to wait between intervals via the maximum number of seconds to wait before sending a duplicate alert field. For example, if you set the initial value to 5 seconds, and the maximum value to 60 seconds, alerts would be sent at 5 seconds, 15 seconds, 35 seconds, 60 seconds, 120 seconds, etc.

Viewing Recent Alerts

The appliances saves the latest alerts so you can view them in both the GUI and the CLI in case you lose or delete the alert messages. These alerts cannot be downloaded from the appliance .

To view a list of the latest alerts, click the **View Top Alerts** button on the Alerts page or use the `displayalerts` command in the CLI. You can arrange the alerts in the GUI by date, level, class, text, and recipient.

By default, the appliance saves a maximum of 50 alerts to displays in the **Top Alerts** window. Use the `alertconfig -> setup` command in the CLI to edit the number of alerts that the appliance saves. If you want to disable this feature, change the number of alerts to 0.

Alert Descriptions

The following tables list alerts by classification, including the alert name (internal descriptor used by Cisco), actual text of the alert, description, severity (critical, information, or warning) and the parameters (if any) included in the text of the message. The value of the parameter is replaced in the actual text of the alert. For example, an alert message below may mention “\$ip” in the message text. “\$ip” is replaced by the actual IP address when the alert is generated.

- [Anti-Spam Alerts, on page 1025](#)
- [Anti-Virus Alerts, on page 1025](#)
- [Directory Harvest Attack Prevention \(DHAP\) Alerts, on page 1026](#)
- [Hardware Alerts, on page 1026](#)

- [Spam Quarantine Alerts, on page 1027](#)
- [Safelist/Blocklist Alerts, on page 1028](#)
- [System Alerts, on page 1029](#)
- [Updater Alerts, on page 1040](#)
- [Outbreak Filter Alerts, on page 1040](#)
- [Clustering Alerts, on page 1041](#)

Anti-Spam Alerts

The following table contains a list of the various anti-spam alerts that can be generated by AsyncOS, including a description of the alert and the alert severity.

Table 95: Listing of Possible Anti-Spam Alerts

| Alert Name | Message and Description | Parameters |
|--------------------|--|--|
| AS.SERVER.ALERT | \$engine anti-spam - \$message \$tb | 'engine' - The type of anti-spam engine. |
| | Critical. Sent when the anti-spam engine fails. | 'message' - The log message.
'tb' - Traceback of the event. |
| AS.TOOL.INFO_ALERT | Update - \$engine - \$message | 'engine' - The anti-spam engine name |
| | Information. Sent when there is a problem with the anti-spam engine. | 'message' - The message |
| AS.TOOL.ALERT | Update - \$engine - \$message | 'engine' - The anti-spam engine name |
| | Critical. Sent when an update is aborted due to a problem with one of the tools used to manage the anti-spam engine. | 'message' - The message |

Anti-Virus Alerts

The following table contains a list of the various Anti-Virus alerts that can be generated by AsyncOS, including a description of the alert and the alert severity.

Table 96: Listing of Possible Anti-Virus Alerts

| Alert Name | Message and Description | Parameters |
|--|--|--|
| AV.SERVER.ALERT
/AV.SERVER.CRITICAL | \$engine antivirus - \$message \$tb | 'engine' - The type of anti-virus engine. |
| | Critical. Sent when there is a critical problem with the anti-virus scanning engine. | 'message' - The log message.
'tb' - Traceback of the event. |

| Alert Name | Message and Description | Parameters |
|---------------------------------|---|---|
| AV.SERVER.ALERT.INFO | \$engine antivirus - \$message \$tb | 'engine' - The type of anti-virus engine.
'message' - The log message.
'tb' - Traceback of the event. |
| | Information. Sent when an informational event occurs with the anti-virus scanning engine. | |
| AV.SERVER.ALERT.WARN | \$engine antivirus - \$message \$tb | 'engine' - The type of anti-virus engine.
'message' - The log message.
'tb' - Traceback of the event. |
| | Warning. Sent when there is a problem with the anti-virus scanning engine. | |
| MAIL.ANTIVIRUS.ERROR_MESSAGE | MID \$mid antivirus \$what error \$tag | 'mid' - MID
'what' - The error that happened.
'tag' - Virus outbreak name if set. |
| | Critical. Sent when anti-virus scanning produces an error while scanning a message. | |
| MAIL.SCANNER.PROTOCOL_MAX_RETRY | MID \$mid is malformed and cannot be scanned by \$engine. | 'mid' - MID
'engine' - The engine being used |
| | Critical. The scanning engine attempted to scan the message unsuccessfully because the message is malformed. The maximum number of retries has been exceeded, and the message will be processed without being scanned by this engine. | |

Directory Harvest Attack Prevention (DHAP) Alerts

The following table contains a list of the various DHAP alerts that can be generated by AsyncOS, including a description of the alert and the alert severity.

Table 97: Listing of Possible Directory Harvest Attack Prevention Alerts

| Alert Name | Message and Description | Parameters |
|-----------------|---|------------|
| LDAP.DHAP_ALERT | LDAP: Potential Directory Harvest Attack detected. See the system mail logs for more information about this attack. | |
| | Warning. Sent when a possible directory harvest attack is detected. | |

Hardware Alerts

The following table contains a list of the various Hardware alerts that can be generated by AsyncOS, including a description of the alert and the alert severity.

Table 98: Listing of Possible Hardware Alerts

| Alert Name | Message and Description | Parameters |
|---------------------------------------|--|--|
| INTERFACE.ERRORS | Port \$port: has detected \$in_err input errors, \$out_err output errors, \$col collisions please check your media settings. | 'port' - Interface name.
'in_err' - The number of input errors since the last message. |
| | Warning. Sent when interface errors are detected. | 'out_err' - The number of output errors since the last message.
'col' - The number of packet collisions since the last message. |
| MAIL.MEASUREMENTS_FILESYSTEM | The \$file_system partition is at \$capacity% capacity | 'file_system' - The name of the filesystem |
| | Warning. Sent when a disk partition is nearing capacity (75%). | 'capacity' - How full the filesystem is in percent. |
| MAIL.MEASUREMENTS_FILESYSTEM.CRITICAL | The \$file_system partition is at \$capacity% capacity | 'file_system' - The name of the filesystem |
| | Critical. Sent when a disk partition reaches 90% capacity (and at 95%, 96%, 97%, etc.). | 'capacity' - How full the filesystem is in percent. |
| SYSTEM.RAID_EVENT_ALERT | A RAID-event has occurred: \$error | 'error' - The text of the RAID error. |
| | Warning. Sent when a critical RAID-event occurs. | |
| SYSTEM.RAID_EVENT_ALERT_INFO | A RAID-event has occurred: \$error | 'error' - The text of the RAID error. |
| | Information. Sent when a RAID-event occurs. | |

Spam Quarantine Alerts

The following table contains a list of the various spam quarantine alerts that can be generated by AsyncOS, including a description of the alert and the alert severity.

Table 99: Listing of Possible Spam Quarantine Alerts

| Alert Name | Message and Description | Parameters |
|----------------------------|---|---|
| ISQ.CANNOT_CONNECT_OFF_BOX | ISQ: Could not connect to off-box quarantine at \$host:\$port | 'host' - address of off-box quarantine |
| | Information. Sent when AsyncOS was unable to connect to the (off-box) IP address. | 'port' - port to connect to on off-box quarantine |
| ISQ.CRITICAL | ISQ: \$msg | 'msg' - message to be displayed |
| | Critical. Sent when a critical spam quarantine error is encountered. | |

| Alert Name | Message and Description | Parameters |
|------------------------------|---|--|
| ISQ.DB_APPROACHING_FULL | ISQ: Database over \$threshold% full | 'threshold' - the percent full threshold at which alerting begins |
| | Warning. Sent when the spam quarantine database is nearly full. | |
| ISQ.DB_FULL | ISQ: database is full | |
| | Critical. Sent when the spam quarantine database is full. | |
| ISQ.MSG_DEL_FAILED | ISQ: Failed to delete MID \$mid for \$rcpt: \$reason | 'mid' - MID |
| | Warning. Sent when an email is not successfully deleted from the spam quarantine. | 'rcpt' - Recipient or "all"
'reason' - Why the message was not deleted |
| ISQ.MSG_NOTIFICATION_FAILED | ISQ: Failed to send notification message: \$reason | 'reason' - Why the notification was not sent |
| | Warning. Sent when a notification message is not successfully sent. | |
| ISQ.MSG_QUAR_FAILED | Warning. Sent when a message is not successfully quarantined. | |
| ISQ.MSG_RLS_FAILED | ISQ: Failed to release MID \$mid to \$rcpt: \$reason | 'mid' - MID |
| | Warning. Sent when a message is not successfully released. | 'rcpt' - Recipient or "all"
'reason' - Why the message was not released |
| ISQ.MSG_RLS_FAILED_UNK_RCPTS | ISQ: Failed to release MID \$mid: \$reason | 'mid' - MID |
| | Warning. Sent when a message is not successfully released because the recipient is unknown. | 'reason' - Why the message was not released |
| ISQ.NO_EU_PROPS | ISQ: Could not retrieve \$user's properties. Setting defaults | 'user' - end user name |
| | Information. Sent when AsyncOS is unable to retrieve information about a user. | |
| ISQ.NO_OFF_BOX_HOST_SET | ISQ: Setting up off-box ISQ without setting host | |
| | Information. Sent when AsyncOS is configured to reference an external quarantine, but the external quarantine is not defined. | |

Safelist/Blocklist Alerts

The following table contains a list of the various Safelist/Blocklist alerts that can be generated by AsyncOS, including a description of the alert and the alert severity

Table 100: Listing of Possible Safelist/Blocklist Alerts

| Alert Name | Message and Description | Parameters |
|-------------------------|---|---|
| SLBL.DB.RECOVERY_FAILED | SLBL: Failed to recover End-User Safelist/Blocklist database: '\$error'. | 'error' - error reason |
| | Critical. Failed to recover the Safelist/Blocklist database. | |
| SLBL.DB.SPACE_LIMIT | SLBL: End-User Safelist/Blocklist database exceeded allowed disk space: \$current of \$limit. | 'current' - how much it has used, in MB |
| | Critical. The safelist/blocklist database exceeded the allowed disk space. | 'limit' - the configured limit, in MB |

System Alerts

The following table contains a list of the various System alerts that can be generated by AsyncOS, including a description of the alert and the alert severity.

Table 101: Listing of Possible System Alerts

| Component/Alert Name | Message and Description | Parameters |
|-----------------------------------|---|--|
| AMP.ENGINE.ALERT | See Ensuring That You Receive Alerts About Advanced Malware Protection Issues, on page 477 | - |
| AsyncOS API Alerts | See “Alerts” section in the <i>AsyncOS API for Cisco Email Security Appliances - Getting Started Guide</i> . | - |
| Mailbox Auto Remediation Alerts | See “Alerts” section in Remediating Messages in Mailboxes, on page 553 | - |
| COMMON.APP_FAILURE | An application fault occurred: \$error | 'error' - The text of the error, typically a traceback. |
| | Warning. Sent when there is an unknown application failure. | |
| COMMON.ENGINE_AUTO_UPDATE_ENABLED | <\$level>: <\$class> | 'engine' - The name of the Service Engine. The values can be: <ul style="list-style-type: none"> • Sophos • McAfee • Graymail |
| | Information: Automatic updates have been enabled for the particular engine <\$engine>. You will now receive automatic engine updates for this engine. | |

| Component/Alert Name | Message and Description | Parameters |
|------------------------------------|--|--|
| COMMON.ENGINE_AUTO_UPDATE_DISABLED | <\$level>: <\$class> | ' engine ' - The name of the Service Engine.
The values can be: <ul style="list-style-type: none"> • Sophos • McAfee • Graymail |
| | Information: Automatic updates have been disabled for the particular engine <\$engine>. You will not receive any automatic updates for this engine, unless you enable automatic updates in the global setting page of the particular engine. | |
| COMMON.KEY_EXPIRED_ALERT | Your "\$feature" key has expired. Please contact your authorized Cisco sales representative. | ' feature ' - The name of the feature that is about to expire. |
| | Warning. Sent when a feature key has expired. | |
| COMMON.KEY_EXPIRING_ALERT | Your "\$feature" key will expire in under \$days day(s). Please contact your authorized Cisco sales representative. | ' feature ' - The name of the feature that is about to expire.
' days ' - The number of days it will expire. |
| | Warning. Sent when a feature key is about to expire. | |
| COMMON.KEY_FINAL_EXPIRING_ALERT | This is a final notice. Your "\$feature" key will expire in under \$days day(s). Please contact your authorized Cisco sales representative. | ' feature ' - The name of the feature that is about to expire.
' days ' - The number of days it will expire. |
| | Warning. Sent as a final notice that a feature key is about to expire. | |
| KEYS.GRACE_EXPIRING_ALERT | All security services licenses for this appliance have expired. The appliance will continue to deliver mail without security services for \$days days. | ' days ' - The number of days remaining in the grace period at the time the alert was sent.

For more information about the grace period, see Virtual Appliance License Expiration , on page 994. |
| | To renew security services licenses, Please contact your authorized Cisco sales representative.

Critical. Sent periodically from the start of the grace period for virtual appliance license expiration. | |
| KEYS.GRACE_FINAL_EXPIRING_ALERT | This is the final notice. All security services licenses for this appliance have expired. The appliance will continue to deliver mail without security services for 1 day. | For more information about the grace period, see Virtual Appliance License Expiration , on page 994. |
| | To renew security services licenses, Please contact your authorized Cisco sales representative.

Critical. Sent one day before the virtual appliance license expires. | |

| Component/Alert Name | Message and Description | Parameters |
|---|---|--|
| KEYS.GRACE_EXPIRED_ALERT | Your grace period has expired. All security service have expired, and your appliance is non-functional. The appliance will no longer deliver mail until a new license is applied.

To renew security services licenses, Please contact your authorized Cisco sales representative. | For more information about the grace period, see Virtual Appliance License Expiration , on page 994. |
| | Critical. Sent when the grace period for virtual appliance has expired. | |
| DNS.BOOTSTRAP_FAILED | Failed to bootstrap the DNS resolver. Unable to contact root servers. | |
| | Warning. Sent when the appliance is unable to contact the root DNS servers. | |
| COMMON.INVALID_FILTER | Invalid \$class: \$error | ' class ' - Either "Filter", "SimpleFilter", etc. |
| | Warning. Sent when an invalid filter is encountered. | ' error ' - Additional why-filter-is-invalid info. |
| IPBLOCKD.HOST_ADDED_TO_ALLOWED_LIST
IPBLOCKD.HOST_ADDED_TO_BLOCKED_LIST
IPBLOCKD.HOST_REMOVED_FROM_BLOCKED_LIST | The host at \$ip has been added to the blocked list because of an SSH DOS attack. | ' ip ' - IP address from which a login attempt occurred. |
| | The host at \$ip has been permanently added to the ssh allowed list. | |
| | The host at \$ip has been removed from the blocked list. | |
| | Warning.

IP addresses that try to connect to the appliance over SSH but do not provide valid credentials are added to the SSH blocked list if more than 10 failed attempts occur within two minutes.

When a user logs in successfully from the same IP address, that IP address is added to the allowed list.

Addresses on the allowed list. are allowed access even if they are also on the blocked list.

Entries are automatically removed from the blocked list after about a day. | |
| LDAP.GROUP_QUERY_FAILED_ALERT | LDAP: Failed group query \$name, comparison in filter will evaluate as false | ' name ' - The name of the query. |
| | Critical. Sent when an LDAP group query fails. | |

| Component/Alert Name | Message and Description | Parameters |
|--------------------------------------|---|--|
| LDAP.HARD_ERROR | LDAP: work queue processing error in \$name reason \$why | 'name' - The name of the query.
'why' - Why the error happened. |
| | Critical. Sent when an LDAP query fails completely (after trying all servers). | |
| LOG.ERROR.* | Critical. Various logging errors. | |
| MAIL.FILTER.RULE_MATCH_ALERT | MID \$mid matched the \$rule_name rule. \n Details: \$details | 'mid' - Unique identification number of the message.
'rule_name' - The name of the rule that matched.
'details' - More information about the message or the rule. |
| | Information. Sent every time when a Header Repeats rule evaluates to true . | |
| MAIL.PERRCPT.LDAP_GROUP_QUERY_FAILED | LDAP group query failure during per-recipient scanning, possible LDAP misconfiguration or unreachable server. | |
| | Critical. Sent when an LDAP group query fails during per-recipient scanning. | |
| MAIL.QUEUE.ERROR.* | Critical. Various mail queue hard errors. | |
| MAIL.OMH.DELIVERY_RETRY | Subject - 'Alert: Message Delivery failed for \$hostname. DANE verification failed for one or more Domain(s).'

Message - The message delivery failed due to DANE verification failure for all mail exchange (MX) hosts in \$hostname. The appliance will attempt message delivery again or bounce the message. | 'host' - The host for which the DANE verification has failed. |
| MAIL.RES_CON_START_ALERT.MEMORY | This system (hostname: \$hostname) has entered a 'resource conservation' mode in order to prevent the rapid depletion of critical system resources. RAM utilization for this system has exceeded the resource conservation threshold of \$memory_threshold_start%. The allowed receiving rate for this system will be gradually decreased as RAM utilization approaches \$memory_threshold_halt%. | 'hostname' - The name of the host.
'memory_threshold_start' - The percent threshold where memory tarpitting starts.
'memory_threshold_halt' - The percent threshold where the system will halt due to memory being too full. |
| | Critical. Sent when RAM utilization has exceeded the system resource conservation threshold. | |

| Component/Alert Name | Message and Description | Parameters |
|-------------------------------------|---|--|
| MAIL.RES_CON_START_ALERT.QUEUE_SLOW | This system (hostname: \$hostname) has entered a 'resource conservation' mode in order to prevent the rapid depletion of critical system resources. The queue is overloaded and is unable to maintain the current throughput. | 'hostname' - The name of the host. |
| | Critical. Sent when the mail queue is overloaded and system resource conservation is enabled. | |
| MAIL.RES_CON_START_ALERT.QUEUE | This system (hostname: \$hostname) has entered a 'resource conservation' mode in order to prevent the rapid depletion of critical system resources. Queue utilization for this system has exceeded the resource conservation threshold of \$queue_threshold_start%. The allowed receiving rate for this system will be gradually decreased as queue utilization approaches \$queue_threshold_halt%. | 'hostname' - The name of the host.
'queue_threshold_start' - The percent threshold where queue tarpitting starts.
'queue_threshold_halt' - The percent threshold where the system will halt due to the queue being too full. |
| | Critical. Sent when queue utilization has exceeded the system resource conservation threshold. | |
| MAIL.RES_CON_START_ALERT.WORKQ | This system (hostname: \$hostname) has entered a 'resource conservation' mode in order to prevent the rapid depletion of critical system resources. Listeners have been suspended because the current work queue size has exceeded the threshold of \$suspend_threshold. Listeners will be resumed once the work queue size has dropped to \$resume_threshold. These thresholds may be altered via use of the 'tarpit' command on the system CLI. | 'hostname' - The name of the host.
'suspend_threshold' - Work queue size above which listeners are suspended.
'resume_threshold' - Work queue size below which listeners are resumed. |
| | Information. Sent when listeners are suspended because the work queue size is too big. | |
| MAIL.RES_CON_START_ALERT | This system (hostname: \$hostname) has entered a 'resource conservation' mode in order to prevent the rapid depletion of critical system resources. | 'hostname' - The name of the host. |
| | Critical. Sent when the appliance enters "resource conservation" mode. | |
| MAIL.RES_CON_STOP_ALERT | This system (hostname: \$hostname) has exited 'resource conservation' mode as resource utilization has dropped below the conservation threshold. | 'hostname' - The name of the host. |
| | Information. Sent when the appliance leaves 'resource conservation' mode. | |

| Component/Alert Name | Message and Description | Parameters |
|--|--|--|
| MAIL.URL_REP_CLIENT.CATEGORY_CHANGE | See Future URL Category Set Changes , on page 456. | — |
| MAIL.BEAKER_CONNECTOR.CERTIFICATE_INVALID | See Troubleshooting URL Filtering , on page 439. | |
| MAIL.BEAKER_CONNECTOR.ERROR_FETCHING_CERTIFICATE | | |
| MAIL.WORK_QUEUE_PAUSED_NATURAL | work queue paused, \$num msgs, \$reason
Critical. Sent when the work queue is paused. | 'num' - The number of messages in the work queue.
'reason' - The reason the work queue is paused. |
| MAIL.WORK_QUEUE_UNPAUSED_NATURAL | work queue resumed, \$num msgs
Critical. Sent when the work queue is resumed. | 'num' - The number of messages in the work queue. |
| NTP.NOT_ROOT | Not running as root, unable to adjust system time
Warning. Sent when the appliance is unable to adjust time because NTP is not running as root. | |
| QUARANTINE.ADD_DB_ERROR | Unable to quarantine MID \$mid - quarantine system unavailable
Critical. Sent when a message cannot be sent to a quarantine. | 'mid' - MID |
| QUARANTINE.DB_UPDATE_FAILED | Unable to update quarantine database (current version: \$version; target \$target_version)
Critical. Sent when a quarantine database cannot be updated. | 'version' - The schema version detected.
'target_version' - The target schema version. |
| QUARANTINE.DISK_SPACE_LOW | The quarantine system is unavailable due to a lack of space on the \$file_system partition.
Critical. Sent when the disk space for quarantines is full. | 'file_system' - The name of the filesystem. |
| QUARANTINE.THRESHOLD_ALERT | Quarantine "\$quarantine" is \$full% full
Warning. Sent when a quarantine reaches 5%, 50%, or 75% of capacity. | 'quarantine' - The name of the quarantine.
'full' - The percentage of how full the quarantine is. |
| QUARANTINE.THRESHOLD_ALERT.SERIOUS | Quarantine "\$quarantine" is \$full% full
Critical. Sent when a quarantine reaches 95% of capacity. | 'quarantine' - The name of the quarantine.
'full' - The percentage of how full the quarantine is. |

| Component/Alert Name | Message and Description | Parameters |
|--|--|--|
| REPORTD.DATABASE_OPEN_FAILED_ALERT | The reporting system has encountered a critical error while opening the database. In order to prevent disruption of other services, reporting has been disabled on this machine. Please contact customer support to have reporting enabled. The error message is: \$err_msg | 'err_msg' - The error message raised |
| | Critical. Sent if the reporting engine is unable to open the database. | |
| REPORTD.AGGREGATION_DISABLED_ALERT | Processing of collected reporting data has been disabled due to lack of logging disk space. Disk usage is above \$threshold percent. Recording of reporting events will soon become limited and reporting data may be lost if disk space is not freed up (by removing old logs, etc.). Once disk usage drops below \$threshold percent, full processing of reporting data will be restarted automatically. | 'threshold' - The threshold value |
| | Warning. Sent if the system runs out of disk space. When the disk usage for a log entry exceeds the log usage threshold, reportd disables aggregation and sends the alert. | |
| REPORTING.CLIENT.UPDATE_FAILED_ALERT | Reporting Client: The reporting system has not responded for an extended period of time (\$duration). | 'duration' - Length of time the client has been trying to contact the reporting daemon. This is a string in a human readable format ('1h 3m 27s'). |
| | Warning. Sent if the reporting engine was unable to save reporting data. | |
| REPORTING.CLIENT.JOURNAL_FULL | Reporting Client: The reporting system is unable to maintain the rate of data being generated. Any new data generated will be lost. | |
| | Critical. Sent if the reporting engine is unable to store new data. | |
| REPORTING.CLIENT.JOURNAL_FREE | Reporting Client: The reporting system is now able to handle new data. | |
| | Information. Sent when the reporting engine is again able to store new data. | |
| PERIODIC_REPORTS.REPORT_TASK.BUILD_FAILURE | A failure occurred while building periodic report '\$report_title'. This subscription has been removed from the scheduler. | 'report_title' - the report title |
| | Critical. Sent when the reporting engine is unable to build a report. | |

| Component/Alert Name | Message and Description | Parameters |
|--|---|---|
| PERIODIC_REPORTS.REPORT_TASK.EMAIL_FAILURE | A failure occurred while emailing periodic report '\$report_title'. This subscription has been removed from the scheduler. | 'report_title' - the report title |
| | Critical. Sent when a report could not be emailed. | |
| PERIODIC_REPORTS.REPORT_TASK.ARCHIVE_FAILURE | A failure occurred while archiving periodic report '\$report_title'. This subscription has been removed from the scheduler. | 'report_title' - the report title |
| | Critical. Sent when a report could not be archived. | |
| SENDERBASE.ERROR | Error processing response to query \$query: response was \$response | 'query' - The query address.
'response' - Raw data of response received. |
| | Information. Sent when an error occurred while processing a response from SenderBase. | |
| SMTPAUTH.FWD_SERVER_FAILED_ALERT | SMTP Auth: could not reach forwarding server \$ip with reason: \$why | 'ip' - The IP of the remote server.
'why' - Why the error happened. |
| | Warning. Sent when the SMTP Authentication forwarding server is unreachable. | |
| SMTPAUTH.LDAP_QUERY_FAILED | SMTP Auth: LDAP query failed, see LDAP debug logs for details. | |
| | Warning. Sent when an LDAP query fails. | |
| SYSTEM.HERMES_SHUTDOWN_FAILURE.
REBOOT | While preparing to \${what}, failed to stop mail server gracefully: \${error}\${what}:=reboot | 'error' - The error that happened. |
| | Warning. Sent when there was a problem shutting down the system on reboot. | |
| SYSTEM.HERMES_SHUTDOWN_FAILURE.
SHUTDOWN | While preparing to \${what}, failed to stop mail server gracefully: \${error}\${what}:=shut down | 'error' - The error that happened. |
| | Warning. Sent when there was a problem shutting down the system. | |
| SYSTEMLOGIN_FAILURES_LOCK_ALERT | User "\$user" is locked after \$numlogins consecutive login failures. Last login attempt was from \$rhost

Information: Sent when the user account is locked because of maximum number of failed login attempts | 'user' - The name of the user
'numlogins' - The configured alert threshold
'rhost' - The address of the remote host |
| SYSTEMRCPTVALIDATION.UPDATE_FAILED | Error updating recipient validation data: \$why | 'why' - The error message. |
| | Critical. Sent when a recipient validation update failed. | |

| Component/Alert Name | Message and Description | Parameters |
|---|--|--|
| SYSTEM.SERVICE_TUNNEL.DISABLED | Tech support: Service tunnel has been disabled | |
| | Information. Sent when a tunnel created for Cisco Support Services is disabled. | |
| SYSTEM.SERVICE_TUNNEL.ENABLED | Tech support: Service tunnel has been enabled, port \$port | 'port' - The port used for the service tunnel. |
| | Information. Sent when a tunnel created for Cisco Support Services is enabled. | |
| IPBLOCKD.HOST_ADDED_TO_ALLOWED_LIST | The host at \$ip has been added to the blocked list because of an SSH DOS attack. | 'ip' - IP address from which a login attempt occurred. |
| IPBLOCKD.HOST_ADDED_TO_BLOCKED_LIST | The host at \$ip has been permanently added to the ssh allowed list. | |
| IPBLOCKD.HOST_REMOVED_FROM_BLOCKED_LIST | The host at \$ip has been removed from the blocked list. | |
| | <p>Warning.</p> <p>IP addresses that try to connect to the appliance over SSH but do not provide valid credentials are added to the SSH blocked list if more than 10 failed attempts occur within two minutes.</p> <p>When a user logs in successfully from the same IP address, that IP address is added to the allowed list.</p> <p>Addresses on the allowed list are allowed access even if they are also on the blocked list .</p> <p>Entries are automatically removed from the blocked list after about a day.</p> | |

| Component/Alert Name | Message and Description | Parameters |
|-----------------------------------|--|---|
| WATCHDOG_RESTART_ALERT_MSG | <p><\$level>: <\$class>, <\$hostname>: \$subject \$text</p> <p>Warning.</p> <p>The appliance uses the watchdog service to monitor the health condition of the following engines:</p> <ul style="list-style-type: none"> • Anti-Spam • Anti-Virus • Anti Malware Protection • Graymail <p>If any of the above engines does not respond to the watchdog service for a certain duration, the watchdog service restarts the engine(s) and sends an alert to the administrator.</p> | <p>'subject' - Watchdog alert subject specific to the engine</p> <p>'text' - Watchdog alert text specific to the engine</p> |
| MAIL.IMH.GEODB_UPDATE_COUNTRIES' | <p>Warning. Geolocation Update - the list of supported countries has changed.</p> <p>Added Countries - <\$added></p> <p>Deleted Countries - <\$deleted></p> <p>Review your HAT sender groups, Message Filters, and Content Filters settings accordingly.</p> | <p>'added' - The following countries are added: <iso_code1>:<country_name1>,<iso_code2>:<country_name2>,</p> <p>'deleted' - The following countries are deleted: <iso_code1>:<country_name1>:<iso_code2>:<country_name2>,</p> |
| MAILUPDAIED_SHORT_URL_DOMAIN_LIST | <p>Info. The list of shortened URL domains has been updated..</p> <p>Added Domains: <\$added_domains></p> <p>Deleted Domains - <\$deleted_domains></p> | <p>'added_domains': The following domains are added: <domains_1>, <domain_2></p> <p>'deleted_domains': The following domains are deleted: <domain_3>, <domain_4></p> |
| MAIL.DOMAINS_NOT_REACHABLE | <p>Warning. The following domains are not reachable by the appliance for shortened URL support: <\$domains></p> <p>Check your firewall rules to allow your appliance to connect to these domains.</p> | <p><\$domains>: comma separated list of domains</p> |
| MAILUPGRADE_CONFIG_CHANGEALERT | <p>Info. Sent when the user configured value is changed by the system during the upgrade.</p> | <p>'text' - The Intelligent Multi-Scan and the Graymail global configuration settings have been modified during the upgrade. Please review the global settings for the Intelligent Multi-Scan and the Graymail configurations.</p> |
| CERTIFICATE.CERT_EXPIRING_ALERT | <p>Your certificate "\$certificate" will expire in \$days day(s).</p> <p>Alert level : WARNING</p> | <p>'certificate', 'The name of the certificate that is about to expire.</p> <p>'days', 'The number of days it will expire.'</p> |

| Component/Alert Name | Message and Description | Parameters |
|--|---|---|
| CERTIFICATE.CERT_CRITICAL_EXPIRING_ALERT | Your certificate "\$certificate" will expire in \$days hour(s).

Alert level : CRITICAL A 'CRITICAL' certificate validity period is less than 5 days. | 'certificate', 'The name of the certificate that is about to expire.'

'days', 'The number of days with remaining time (HH:MM:SS), for example, 4 days 10:12:20 hour(s).' |
| CERTIFICATE.CERT_EXPIRED_ALERT | Your certificate "\$certificate" has expired.

Alert level : CRITICAL | 'certificate', 'The name of the certificate that has expired.' |
| MAIL.APP.NO_ACCESS_KEY | Alert text: 'Failed to poll for the Cisco Advanced Phishing Protection Cloud Service expiry date, add API AccessUID and API Access secret key.'

Description: Alert is sent when a query for the APP expiry date failed because the API Access key and the secret key was not entered. | N/A |
| MAIL.APP.INVALID_KEY | Alert text: Failed to poll for the Cisco Advanced Phishing Protection Cloud Service expiry date because the API Access Key is invalid. You need to re-configure the API Access UID and secret key.

Description: Alert is sent when a query for the APP expiry date failed because the API Access key and the secret key was not entered. | N/A |
| MAIL.APP.EXPIRED | Alert text: The Cisco Advanced Phishing Protection Cloud Service has expired and is disabled. Contact your Cisco Account Manager to renew the service and enable it.

Description: The Cisco Advanced Phishing Protection Cloud Service has expired and is disabled. You need to renew the APP license and enable the APP service. | N/A |
| MAIL.APP.EXPIRY_REMINDER | Alert text: Cisco Advanced Phishing Protection Cloud Service expires on \$eas_expiry_date. You need to contact your Cisco Account Manager to renew the service.

Description: Alert is sent each day, starting from three days before the expiry period. | Parameters: eas_expiry_date
eas_expiry_date - date on which Cisco Advanced Phishing Protection Cloud Service will expire |
| MAIL.APP.SERVICE_UNAVAILABLE | Alert text: Cisco Advanced Phishing Protection Cloud Service update. Unable to establish communication with the cloud service.

Description: 'APP cloud service is unavailable because ten consecutive mails failed to forward to APP. | N/A |

| Component/Alert Name | Message and Description | Parameters |
|----------------------------|---|------------|
| MAIL.APP.SERVICE_AVAILABLE | Alert text: Cisco Advanced Phishing Protection Cloud Service update. Communication with the cloud service has been established.

Description: APP cloud service is available. | N/A |

Updater Alerts

The following table contains a list of the various Updater alerts that can be generated by AsyncOS.

Table 102: Listing of Possible Updater Alerts

| Alert Name | Message and Description | Parameters |
|---------------------------------------|---|---|
| UPDATER.APP.UPDATE_ABANDONED | \$app abandoning updates until a new version is published. The \$app application tried and failed \$attempts times to successfully complete an update. This may be due to a network configuration issue or temporary outage | 'app' - The application name.
'attempts' - The number of attempts tried. |
| | Warning. The application is abandoning the update. | |
| UPDATER.UPDATERD.ANIFEST_FAILED_ALERT | The updater has been unable to communicate with the update server for at least \$threshold. | 'threshold' - Human readable threshold string. |
| | Warning. Failed to acquire a server manifest. | |
| UPDATER.UPDATERD.RELEASE_NOTIFICATION | \$mail_text | 'mail_text' - The notification text. |
| | Warning. Release notification. | 'notification_subject' - The notification text. |
| UPDATER.UPDATERD.UPDATE_FAILED | Unknown error occurred: \$traceback | 'traceback' - The traceback. |
| | Critical. Failed to run an update. | |

Outbreak Filter Alerts

The following table contains a list of the various Outbreak Filter alerts that can be generated by AsyncOS, including a description of the alert and the alert severity. Please note that Outbreak Filters can also be referenced in system alerts for quarantines (the Outbreak quarantine, specifically).

Table 103: Listing of Possible Outbreak Filter Alerts

| Alert Name | Message and Description | Parameters |
|-------------------------|--|--|
| VOF.GTL_THRESHOLD_ALERT | Outbreak Filters Rule Update Alert:\$text All rules last updated at: \$time on \$date. | 'text' - Update alert text.
'time' - Time of last update. |
| | Information. Sent when the Outbreak Filters threshold has changed. | 'date' - Date of last update. |

| Alert Name | Message and Description | Parameters |
|-------------------|---|--|
| AS.UPDATE_FAILURE | Engine update unsuccessful. This may be due to transient network or DNS issues, HTTP proxy configuration causing update transmission errors or unavailability of downloads.ironport.com. The specific error on the appliance for this failure is: \$error | 'engine' - The engine that failed to update.

'error' - The error that happened. |
| | Warning. Sent when the anti-spam engine or CASE rules fail to update. | |

Clustering Alerts

The following table contains a list of the various clustering alerts that can be generated by AsyncOS, including a description of the alert and the alert severity.

Table 104: Listing of Possible Clustering Alerts

| Alert Name | Message and Description | Parameters |
|---------------------------------|--|---|
| CLUSTER.CC_ERROR.AUTH_ERROR | Error connecting to cluster machine \$name at IP \$ip - \$error - \$why\$error:=Machine does not appear to be in the cluster | 'name' - The hostname and/or serial number of the machine.

'ip' - The IP of the remote host. |
| | Critical. Sent when there was an authentication error. This can occur if a machine is not a member of the cluster. | 'why' - Detailed text about the error. |
| CLUSTER.CC_ERROR.DROPPED | Error connecting to cluster machine \$name at IP \$ip - \$error - \$why\$error:=Existing connection dropped | 'name' - The hostname and/or serial number of the machine.

'ip' - The IP of the remote host. |
| | Warning. Sent when the connection to the cluster was dropped. | 'why' - Detailed text about the error. |
| CLUSTER.CC_ERROR.FAILED | Error connecting to cluster machine \$name at IP \$ip - \$error - \$why\$error:=Connection failure | 'name' - The hostname and/or serial number of the machine.

'ip' - The IP of the remote host. |
| | Warning. Sent when the connection to the cluster failed. | 'why' - Detailed text about the error. |
| CLUSTER.CC_ERROR.FORWARD_FAILED | Error connecting to cluster machine \$name at IP \$ip - \$error - \$why\$error:=Message forward failed, no upstream connection | 'name' - The hostname and/or serial number of the machine.

'ip' - The IP of the remote host. |
| | Critical. Sent when the appliance was unable to forward data to a machine in the cluster. | 'why' - Detailed text about the error. |
| CLUSTER.CC_ERROR.NOROUTE | Error connecting to cluster machine \$name at IP \$ip - \$error - \$why\$error:=No route found | 'name' - The hostname and/or serial number of the machine.

'ip' - The IP of the remote host. |
| | Critical. Sent when the machine was unable to obtain a route to another machine in the cluster. | 'why' - Detailed text about the error. |

| Alert Name | Message and Description | Parameters |
|----------------------------------|--|---|
| CLUSTER.CC_ERROR.SSH_KEY | Error connecting to cluster machine \$name at IP \$ip - \$error - \$why\$error:=Invalid host key | 'name' - The hostname and/or serial number of the machine. |
| | Critical. Sent when there was an invalid SSH host key. | 'ip' - The IP of the remote host.
'why' - Detailed text about the error. |
| CLUSTER.CC_ERROR.TIMEOUT | Error connecting to cluster machine \$name at IP \$ip - \$error - \$why\$error:=Operation timed out | 'name' - The hostname and/or serial number of the machine. |
| | Warning. Sent when the specified operation timed out. | 'ip' - The IP of the remote host.
'why' - Detailed text about the error. |
| CLUSTER.CC_ERROR_NOIP | Error connecting to cluster machine \$name - \$error - \$why | 'name' - The hostname and/or serial number of the machine. |
| | Critical. Sent when the appliance could not obtain a valid IP address for another machine in the cluster. | 'why' - Detailed text about the error. |
| CLUSTER.CC_ERROR_NOIP.AUTH_ERROR | Error connecting to cluster machine \$name - \$error - \$why\$error:=Machine does not appear to be in the cluster | 'name' - The hostname and/or serial number of the machine. |
| | Critical. Sent when there was an authentication error connecting to a machine in a cluster. This can occur if a machine is not a member of the cluster. | 'why' - Detailed text about the error. |
| CLUSTER.CC_ERROR_NOIP.DROPPED | Error connecting to cluster machine \$name - \$error - \$why\$error:=Existing connection dropped | 'name' - The hostname and/or serial number of the machine. |
| | Warning. Sent when the machine was unable to obtain a valid IP address for another machine in the cluster and the connection to the cluster was dropped. | 'why' - Detailed text about the error. |
| CLUSTER.CC_ERROR_NOIP.FAILED | Error connecting to cluster machine \$name - \$error - \$why\$error:=Connection failure | 'name' - The hostname and/or serial number of the machine. |
| | Warning. Sent when there was an unknown connection failure and the machine was unable to obtain a valid IP address for another machine in the cluster. | 'why' - Detailed text about the error. |

| Alert Name | Message and Description | Parameters |
|--------------------------------------|---|--|
| CLUSTER.CC_ERROR_NOIP.FORWARD_FAILED | Error connecting to cluster machine \$name - \$error - \$why\$error:=Message forward failed, no upstream connection | 'name' - The hostname and/or serial number of the machine.

'why' - Detailed text about the error. |
| | Critical. Sent when the machine was unable to obtain a valid IP address for another machine in the cluster and the appliance was unable to forward data to the machine. | |
| CLUSTER.CC_ERROR_NOIP.NOROUTE | Error connecting to cluster machine \$name - \$error - \$why\$error:=No route found | 'name' - The hostname and/or serial number of the machine.

'why' - Detailed text about the error. |
| | Critical. Sent when the machine was unable to obtain a valid IP address for another machine in the cluster and it was unable to obtain a route to the machine. | |
| CLUSTER.CC_ERROR_NOIP.SSH_KEY | Error connecting to cluster machine \$name - \$error - \$why\$error:=Invalid host key | 'name' - The hostname and/or serial number of the machine.

'why' - Detailed text about the error. |
| | Critical. Sent when the machine was unable to obtain a valid IP address for another machine in the cluster and was unable to obtain a valid SSH host key. | |
| CLUSTER.CC_ERROR_NOIP.TIMEOUT | Error connecting to cluster machine \$name - \$error - \$why\$error:=Operation timed out | 'name' - The hostname and/or serial number of the machine.

'why' - Detailed text about the error. |
| | Warning. Sent when the machine was unable to obtain a valid IP address for another machine in the cluster and the specified operation timed out. | |
| CLUSTER.SYNC.PUSH_ALERT | Overwriting \$sections on machine \$name | 'name' - The hostname and/or serial number of the machine. |
| | Critical. Sent when configuration data has gotten out of sync and has been sent to a remote host. | 'sections' - List of cluster sections being sent. |

Changing Network Settings

This section describes the features used to configure the network operation of the appliance. These features give you direct access to the hostname, DNS, and routing settings that you configured via the System Setup Wizard (or the **systemsetup** command) in [Using the System Setup Wizard](#), on page 30.

The following features are described:

- **sethostname**
- DNS Configuration (GUI and via the **dnsconfig** command)
- Routing Configuration (GUI and via the **routeconfig** and **setgateway** commands)
- **dnsflush**

- Passphrase
- Network Access
- Login Banner

Changing the System Hostname

The hostname is used to identify the system. You must enter a fully-qualified hostname. To change the hostname:

- On the web interface, click Network > IP Interfaces, click the Management and in the Hostname, change the hostname.
- On the CLI, use the `s ethostname` command.



Note The new hostname does not take effect until you commit changes.

Configuring Domain Name System (DNS) Settings

You can configure the DNS settings for your appliance through the DNS page on the Network menu of the GUI, or via the `dnsconfig` command.

You can configure the following settings:

- whether to use the Internet's DNS servers or your own, and which specific server(s) to use
- which interface to use for DNS traffic
- the number of seconds to wait before timing out a reverse DNS lookup
- clear DNS cache

Specifying DNS Servers

AsyncOS can use the Internet root DNS servers, your own DNS servers, or the Internet root DNS servers and authoritative DNS servers you specify. When using the Internet root servers, you may specify alternate servers to use for specific domains. Since an alternate DNS server applies to a single domain, it must be authoritative (provide definitive DNS records) for that domain.

AsyncOS supports “splitting” DNS servers when not using the Internet's DNS servers. If you are using your own internal server, you can also specify exception domains and associated DNS servers.

When setting up “split DNS,” you should set up the `in-addr.arpa` (PTR) entries as well. So, for example, if you want to redirect “.eng” queries to the nameserver 1.2.3.4 and all the .eng entries are in the 172.16 network, then you should specify “eng,16.172.in-addr.arpa” as the domains in the split DNS configuration.

Multiple Entries and Priority

For each DNS server you enter, you can specify a numeric priority. AsyncOS will attempt to use the DNS server with the priority closest to 0. If that DNS server is not responding AsyncOS will attempt to use the server at the next priority. If you specify multiple entries for DNS servers with the same priority, the system randomizes the list of DNS servers at that priority every time it performs a query. The system then waits a short amount of time for the first query to expire or “time out” and then a slightly longer amount of time for the second, etc. The amount of time depends on the exact total number of DNS servers and priorities that have been configured. The timeout length is the same for all IP addresses at any particular priority. The first priority

gets the shortest timeout, each subsequent priority gets a longer timeout. Further, the timeout period is roughly 60 seconds. If you have one priority, the timeout for each server at that priority will be 60 seconds. If you have two priorities, the timeout for each server at the first priority will be 15 seconds, and each server at the second priority will be 45 seconds. For three priorities, the timeouts are 5, 10, 45.

For example, suppose you configure four DNS servers, with two of them at priority 0, one at priority 1, and one at priority 2:

Table 105: Example of DNS Servers, Priorities, and Timeout Intervals

| Priority | Server(s) | Timeout (seconds) |
|----------|---------------------|-------------------|
| 0 | 1.2.3.4,
1.2.3.5 | 5, 5 |
| 1 | 1.2.3.6 | 10 |
| 2 | 1.2.3.7 | 45 |

AsyncOS will randomly choose between the two servers at priority 0. If one of the priority 0 servers is down, the other will be used. If both of the priority 0 servers are down, the priority 1 server (1.2.3.6) is used, and then, finally, the priority 2 (1.2.3.7) server.

The timeout period is the same for both priority 0 servers, longer for the priority 1 server, and longer still for the priority 2 server.

Using the Internet Root Servers

The AsyncOS DNS resolver is designed to accommodate the large number of simultaneous DNS connections required for high-performance email delivery.



Note If you choose to set the default DNS server to something other than the Internet root servers, that server must be able to recursively resolve queries for domains for which it is not an authoritative server.

Reverse DNS Lookup Timeout

The appliance attempts to perform a “double DNS lookup” on all remote hosts connecting to a listener for the purposes of sending or receiving email. [That is: the system acquires and verifies the validity of the remote host’s IP address by performing a double DNS lookup. This consists of a reverse DNS (PTR) lookup on the IP address of the connecting host, followed by a forward DNS (A) lookup on the results of the PTR lookup. The system then checks that the results of the A lookup match the results of the PTR lookup. If the results do not match, or if an A record does not exist, the system only uses the IP address to match entries in the Host Access Table (HAT).] This particular timeout period applies only to this lookup and is not related to the general DNS timeout discussed in [Multiple Entries and Priority, on page 1044](#).

The default value is 20 seconds for each DNS server. When there are multiple entries for DNS servers, the total timeout value is (number of DNS servers multiplied by the Reverse DNS Lookup Timeout value) seconds. For example, if there are 8 DNS servers and the Reverse DNS Lookup Timeout value is 20 seconds, the total timeout value is $(8 * 20) = 160$ seconds.

You can disable the reverse DNS lookup timeout globally across all listeners by entering '0' as the number of seconds. If the value is set to 0 seconds, the reverse DNS lookup is not attempted, and instead the standard timeout response is returned immediately. This also prevents the appliance from delivering mail to domains that require TLS-verified connections if the receiving host's certificate has a common name (CN) that maps to the host's IP lookup.

DNS Alert

Occasionally, an alert may be generated with the message "Failed to bootstrap the DNS cache" when an appliance is rebooted. The message means that the system was unable to contact its primary DNS servers, which can happen at boot time if the DNS subsystem comes online before network connectivity is established. If this message appears at other times, it could indicate network issues or that the DNS configuration is not pointing to a valid server.

Clearing the DNS Cache

The Clear Cache button from the GUI, or the `dnsflush` command (for more information about the `dnsflush` command, see the CLI Reference Guide for AsyncOS for Cisco Email Security Appliances), clears all information in the DNS cache. You may choose to use this feature when changes have been made to your local DNS system. The command takes place immediately and may cause a temporary performance degradation while the cache is repopulated.

Configuring DNS Settings via the Graphical User Interface

Procedure

- Step 1** Select **Network > DNS**.
 - Step 2** Click **Edit Settings**.
 - Step 3** Select whether to use the Internet's root DNS servers or your own internal DNS server or the Internet's root DNS servers and specify alternate DNS servers.
 - Step 4** If you want to use your own DNS server(s) enter the server ID and click **Add Row**. Repeat this for each server. When entering your own DNS servers, specify a priority as well. For more information, see [Specifying DNS Servers, on page 1044](#).
 - Step 5** If you want to specify alternate DNS servers for certain domains, enter the domain and the alternate DNS server IP address. Click **Add Row** to add additional domains.
 - Note** You can enter multiple domains for a single DNS server by using commas to separate domain names. You can also enter multiple DNS servers by using commas to separate IP addresses.
 - Step 6** Choose an interface for DNS traffic.
 - Step 7** Enter the number of seconds to wait before cancelling a reverse DNS lookup.
 - Step 8** You can also clear the DNS cache by clicking **Clear Cache**.
 - Step 9** Submit and commit your changes.
-

Configuring TCP/IP Traffic Routes

Some network environments require the use of traffic routes other than the standard default gateway.

The appliance can use both Internet Protocol version 4 (IPv4) and Internet Protocol version 6 (IPv6) static routes.

You can manage static routes via the CLI, using the `routeconfig` command, or use the following procedure.

Procedure

- Step 1** Select **Network > Routing**.
 - Step 2** Click **Add Route** for the type of static route you want to create (IPv4 or IPv6).
 - Step 3** Enter a name for the route.
 - Step 4** Enter the destination IP address.
 - Step 5** Enter the Gateway IP address.
 - Step 6** Submit and commit your changes.
-

Configuring the Default Gateway

You can configure the default gateway using the `setgateway` command in the CLI or use the following procedure.

Procedure

- Step 1** Select **Network > Routing**.
 - Step 2** Click **Default Route** in the route listing for the Internet Protocol version you want to modify.
 - Step 3** Change the Gateway IP address.
 - Step 4** Submit and commit your changes.
-

Configuring SSL Settings

You can configure the SSL settings for the appliance using SSL Configuration Settings page or `sslconfig` command.

Procedure

- Step 1** Click **System Administration > SSL Configuration Settings**.
- Step 2** Click **Edit Settings**.

Important If you have upgraded from a lower AsyncOS version (for example, 12.0 or 12.1), the default SSL ciphers are changed in AsyncOS 13.x and later as follows:

- **For GUI HTTPS-**

```
AES128:AES256:!SRP:!AESGCM+DH+aRSA:!AESGCM+RSA:
!aNULL:!kRSA:@STRENGTH:-aNULL:-EXPORT:-IDEA
```

- **For Inbound SMTP -**

```
AES128:AES256:!SRP:!AESGCM+DH+aRSA:!AESGCM+RSA:
!aNULL:!kRSA:@STRENGTH:-aNULL:-EXPORT:-IDEA
```

- **For Outbound SMTP -**

```
ECDH+aRSA:ECDH+ECDSA:DHE+DSS+AES:AES128:AES256:
!SRP:!AESGCM+DH+aRSA:!AESGCM+RSA:!aNULL:!eNULL:!kRSA:@STRENGTH:
-aNULL:-EXPORT:-IDEA
```

Step 3 Depending on your requirements, do the following:

- Set GUI HTTPS SSL settings. Under GUI HTTPS, specify the SSL methods and ciphers that you want to use.
- Set Inbound SMTP SSL settings. Under Inbound SMTP, specify the SSL methods and ciphers that you want to use.
- Set Outbound SMTP SSL settings. Under Outbound SMTP, specify the SSL methods and ciphers that you want to use.
- Set other TLS Client Services. Under 'Other TLS Client Services,' the TLS v1.0 method is disabled by default if your appliance is in the non-FIPS mode. You can enable the TLS v1.0 method on your appliance for the following TLS client services - 'LDAP' and 'Updater.'

Keep in mind that,

- [In non-FIPS mode] You cannot enable TLS v1.0 and v1.1 methods simultaneously. However, you can enable these methods in conjunction with TLS v1.2 method.
- If you plan to upgrade from a lower AsyncOS version (for example, 12.x or 13.0) in non-FIPS mode with TLS v1.0 enabled, to AsyncOS 13.5.1 and later, then TLS v1.0 is disabled by default. You need to enable TLS v1.0 method on your appliance after upgrade.
- From AsyncOS 13.5.1 and later, there is no support for SSLv2 and SSL v3 methods.
- There is no support for the TLS v1.0 method if your appliance is in the FIPS mode.
- The TLS v1.0 method is disabled by default if your appliance is in the non-FIPS mode.

Step 4 Click **Submit**.

Step 5 Click **Commit Changes**.

Single Sign-On (SSO) Using SAML 2.0

- [About Single Sign-On \(SSO\) and SAML 2.0, on page 1049](#)

- [SAML 2.0 SSO Workflow, on page 1049](#)
- [Guidelines and Limitations for SAML 2.0, on page 1050](#)
- [How to Configure SSO on your Appliance , on page 1051](#)

About Single Sign-On (SSO) and SAML 2.0

The appliance now supports SAML 2.0 SSO so that the administrative users can log in to the web interface of the appliance using the same credentials that are used to access other SAML 2.0 SSO enabled services within their organization. For instance, if you enable Duo, Microsoft AD FS or Azure as your SAML Identity Provider (IdP), then you can configure your appliance as a Service Provider (SP) to support SAML 2.0 SSO. Users can sign in once and have access to all SAML 2.0 SSO enabled services.

SAML 2.0 SSO Workflow

The SAML 2.0 SSO workflow is displayed in the following figure:

Figure 75: SAML Workflow

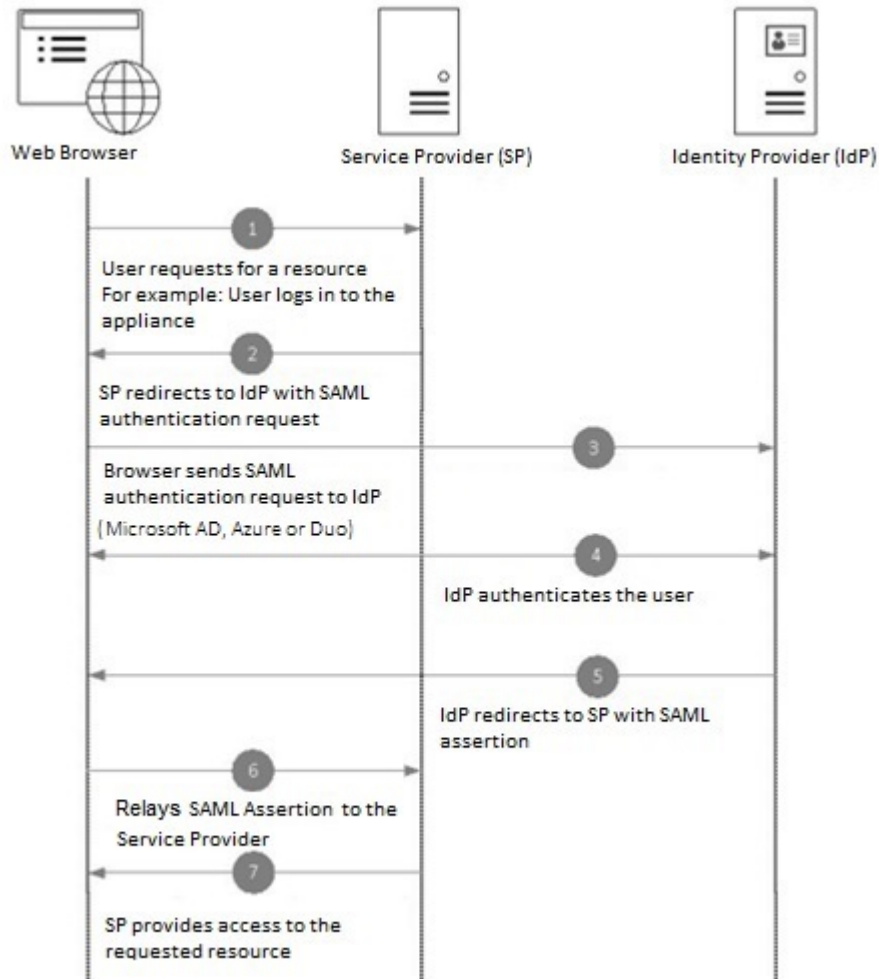

Guidelines and Limitations for SAML 2.0

- [General](#), on page 1050
- [Logout](#), on page 1051
- [Limitations](#), on page 1051

General

You can use Single Sign-On using SAML only on the graphical user interface (GUI). You can use the GUI and the command line interface (CLI) to configure SAML profiles.

You can configure only one instance of service provider and identity provider on the appliance .

Logout

When a user logs out of the appliance , they are not logged out of other SAML 2.0 SSO enabled applications.

Limitations

You cannot configure SAML profiles at cluster level. All SAML configurations are restricted to machine level.

How to Configure SSO on your Appliance

Procedure

| | Command or Action | Purpose |
|---------------|--|--|
| Step 1 | Review the prerequisites. | Prerequisites, on page 1051 |
| Step 2 | Configure your appliance as a service provider. | Configuring Appliance as a Service Provider, on page 1052 |
| Step 3 | [On IDP] Configure the identity provider to work with your appliance . | Configuring the Identity Provider to Communicate with Appliance , on page 1055 |
| Step 4 | Configure identity provider settings on your appliance . | Configure Identity Provider Settings on Appliance , on page 1057 |
| Step 5 | Enable External Authentication using SAML on your appliance . | Enable SAML Authentication, on page 973 |

Prerequisites

- [Supported Identity Providers, on page 1051](#)
- [Certificates for Secure Communication, on page 1052](#)

Supported Identity Providers

Verify whether the identity provider used by your organization is supported by the appliance . The following are the pre-qualified identity providers:

- Microsoft Active Directory Federation Services (AD FS) 2.0 and later
- Duo Access Gateway
- Azure AD



Note

You can use any standard SAML 2.0 identity provider to configure SSO using SAML on your email gateway.

Certificates for Secure Communication

Obtain the following certificates that are required to secure the communication between your appliance and the identity provider:

- If you want your appliance to sign SAML authentication requests or if you want your identity provider to encrypt SAML assertions, obtain a self-signed certificate or a certificate from a trusted CA and the associated private key.
- If you want the identity provider to sign SAML assertions, obtain the identity provider's certificate and import the same to your appliance. Your appliance will use this certificate to verify the signed SAML assertions.

Converting Certificates

To create and export certificates from your appliance, see [Working with Certificates, on page 652](#). Normally, the certificates obtained from the appliance are in .pfx format and must be converted to .pem format when you configure your appliance as a service provider.

To convert the certificates from .pfx format to .pem format, do the following:

- Download and install OpenSSL tool and import the certificate file (.pfx) obtained from your appliance.
- Run the following command to export the certificate in .pem format: `openssl pkcs12 -in <certname>.pfx -nokeys -out cert.pem`
- Run the following command to export the private key in .pem format: `openssl pkcs12 -in certname.pfx -nocerts -out key.pem -nodes`
- Run the following command to remove the passphrase from the private key: `openssl rsa -in key.pem -out server.key`

Configuring Appliance as a Service Provider



Note The service provider settings on the identity provider is configured based on the service provider configurations on the appliance.

Before you begin

Make sure that you review the [Prerequisites, on page 1051](#).

Procedure

- Step 1** Log in to your appliance using the web interface.
- Step 2** Navigate to **System Administration > SAML**.
- Step 3** Click **Add Service Provider**.
- Step 4** Enter the following details:

| Field | Description |
|-------------------------------|---|
| Profile Name | Enter a name for the service provider profile. |
| Configuration Settings | |
| Entity ID | Enter a globally unique name for the service provider (in this case, your appliance). The format of the service provider Entity ID is typically a URI. |
| Name ID Format | <p>The format that the identity provider should use to specify the user in the SAML assertion.</p> <p>This field is not configurable. You will need this value while configuring the service provider settings on the identity provider.</p> |
| Assertion Consumer URL | <p>Enter the URL to which the identity provider should send the SAML assertion after authentication has successfully completed.</p> <p>The Assertion Consumer URL is the URL that is used to access your appliance . You will need this value while configuring the service provider settings on the identity provider.</p> |

| Field | Description |
|----------------------|--|
| SP Certificate | <p>You can choose to import service provider certificates in any one of the following ways:</p> <ul style="list-style-type: none"> • Select a signed certificate available on your appliance , from the drop-down list. • Import a certificate and the associated private key. The certificate must be in (.cert) format and the private key in (.key) format. • Import a certificate in PKCS #12 file format. Password is mandatory for PKCS #12 format certificates. <p>(Optional) Signing Authentication Requests</p> <p>If you want the appliance to sign the SAML authentication requests:</p> <ol style="list-style-type: none"> Upload the certificate obtained from the appliance and the associated private key.
You must upload the certificate in (.cert) format. For more information, see Certificates for Secure Communication, on page 1052. Enter the passphrase for the private key. Select Sign Requests. <p>(Optional) Decrypt Encrypted Assertions</p> <p>If you plan to configure your identity provider to encrypt SAML assertions:</p> <ol style="list-style-type: none"> Upload the certificate obtained from the appliance and the associated private key. Enter the passphrase for the private key. <p>Note The private key must be in .key format. For information on the usage of certificates, see Certificates for Secure Communication, on page 1052.</p> |
| Sign Assertions | <p>If you want the identity provider to sign the SAML assertions, select Sign Assertions.</p> <p>If you select this option, you must add the identity provider's certificate to the appliance . See Configure Identity Provider Settings on Appliance , on page 1057.</p> |
| Organization Details | Enter the details of your organization. Identity provider uses this information in the error logs. |
| Technical Contact | Enter the email address of the technical contact. Identity provider uses this information in the error logs. |

Step 5 Click **Submit** and commit your changes.

Step 6 Note down the service provider metadata (Entity ID and Assertion Customer URL) displayed on the SSO Settings page and the Name ID Format displayed on the Service Provider Settings page. You will need these details while configuring the service provider settings on the identity provider.

Optionally, you can export the metadata as a file. After you configure the settings, click **Export Metadata** and save the metadata file. Some identity providers allow you to load service provider details from a metadata file.

What to do next

Configure the identity provider to communicate with your appliance. See [Configuring the Identity Provider to Communicate with Appliance](#), on page 1055.

Configuring the Identity Provider to Communicate with Appliance

Before you begin

Make sure that you have:

- Configured your appliance as a service provider. See [Configuring Appliance as a Service Provider](#), on page 1052.
- Copied the service provider metadata details or exported the metadata file. See [Configuring Appliance as a Service Provider](#), on page 1052.

Procedure

Step 1 On the identity provider, do one of the following:

- Manually configure the details of the service provider (your appliance).
- If your identity provider allows you to load the service provider details from a metadata file, import the metadata file.

If you have configured your appliance to sign the SAML authentication requests or you plan to encrypt SAML assertions, make sure that you add the relevant certificate to the identity provider.

For identity provider-specific instructions, see:

- [Configure AD FS to Communicate with Appliance](#), on page 1056.
- [Configure Duo Access Gateway to Communicate with Appliance](#), on page 1056.
- [Configure Azure AD to Communicate with Appliance](#), on page 1057.

Step 2 Note down the identity provider metadata or export the metadata as a file.

What to do next

Configure the identity provider settings on your appliance . See [Configure Identity Provider Settings on Appliance](#) , on page 1057.

Configure AD FS to Communicate with Appliance

The following are the high level tasks you need to perform to configure AD FS (2.0 and later) to communicate with your appliance . For complete and detailed instructions, see *Microsoft documentation*.

- Add the service provider's (appliance's) Assertion Consumer URL as a relaying party.
- Enter the service provider's (appliance's) Entity ID under Relaying Party Trusts > Properties > Identifiers > Relaying Party Identifier. Make sure that this value is same as the Entity ID value in the Service Provider settings on your appliance .
- If you have configured your service provider (appliance) to send signed SAML authentication requests, upload the service provider's certificate (used to sign authentication requests) in .cer format under Relaying Party Trusts > Properties > Signature.
- If you plan to configure AD FS to send encrypted SAML assertions, upload the service provider's (appliance's) certificate in .cer format under Relaying Party Trusts > Properties > Encryption.
- Set the Secure-hash Algorithm to SHA-1 under Relaying Party Trusts > Properties > Advanced.
- Add a custom rule to include SPNameQualifier in the response. The following is a sample custom rule:

```
c:[Type == "http://schemas.xmlsoap.org/ws/2005/05/identity/claims/emailaddress"] =>
issue(Type = "http://schemas.xmlsoap.org/ws/2005/05/identity/claims/nameidentifier",
Issuer=
c.Issuer, OriginalIssuer = c.OriginalIssuer, Value = c.Value, ValueType = c.ValueType,
Properties["http://schemas.xmlsoap.org/ws/2005/05/identity/claimproperties/format"] =
"urn:oasis:names:tc:SAML:1.1:nameid-format:emailAddress",
Properties ["http://schemas.xmlsoap.org/ws/2005/05/identity/claimproperties/format"] =
"urn:oasis:names:tc:SAML:1.1:nameid-format:unspecified");
```
- Edit the Claim Rule and add an Issuance Transform Rule to send the LDAP attribute for email address as an outgoing claim type (email address). Also ensure that you add an Issuance Transform Rule to send the LDAP attribute for group attribute as an outgoing claim type (unspecified groups).

Configure Duo Access Gateway to Communicate with Appliance

The following are the high level tasks you need to perform to Duo Access Gateway to communicate with your appliance . For complete and detailed instructions, see *Duo Security Documentation*.

- Add the service provider's (appliance's) Assertion Consumer URL as the service provider endpoint that receives and processes SAML assertions.
- Enter the service provider's (appliance's) Entity ID under Duo Admin Panel > Applications > Protect an Application > SAML Service Provider. Make sure that this value is same as the Entity ID value in the Service Provider settings on your appliance .
- If you have configured your service provider (appliance) to send signed SAML authentication requests, upload the service provider's certificate (used to sign authentication requests) in .cer format when you configure the authentication source on the Duo Access Gateway.

- If you plan to configure Duo to send encrypted SAML assertions, upload the service provider's (appliance's) certificate in .cer format when you configure the authentication source on the Duo Access Gateway.
- Select the NameID format as "unspecified" under Duo Admin Panel > Applications > Protect an Application > SAML Service Provider > SAML Response.
- Set the Secure-hash Algorithm to SHA-256 under Duo Admin Panel > Applications > Protect an Application > SAML Service Provider > SAML Response.
- Save the SAML - Service Provider Setting as a configuration file on the Duo Admin Panel and import the configuration file as a SAML application on the Duo Access Gateway.

Configure Azure AD to Communicate with Appliance

The following are the high level tasks you need to perform to Azure AD to communicate with your appliance . For complete and detailed instructions, see *Microsoft Azure AD Documentation*.

- Add the service provider's (appliance's) Assertion Consumer URL as the service provider identifier that receives and processes SAML assertions.
- Enter the service provider's (appliance's) Entity ID in the Azure Portal under Enterprise Application > New Application > Non-gallery application > Single Sign-On > Basic SAML Configuration. Make sure that this value is same as the Entity ID value in the Service Provider settings on your appliance .
- If you have configured your service provider (appliance) to send signed SAML authentication requests, upload the service provider's certificate (used to sign authentication requests) under SAML Signing Certificate section (Enterprise Application > New Application > Non-gallery application > Single Sign-On > SAML Signing Certificate).
- Configure a Group Claim under User Attributes and Claims section (Enterprise Application > New Application > Non-gallery application > Single Sign-On > User Attributes and Claims) and add the group attribute.
- Add users and/or groups under Azure Application created for SAML > Users & Groups to control users who can login to this Azure SAML application..

Configure Identity Provider Settings on Appliance

Before you begin

Make sure that you have:

- Configured the identity provider to communicate with your appliance . See [Configuring the Identity Provider to Communicate with Appliance](#) , on page 1055.
- Copied the identity provider metadata details or exported the identity provider metadata as file.

Procedure

-
- | | |
|---------------|--|
| Step 1 | Log in to your appliance on the web interface. |
| Step 2 | Navigate to System Administration > SAML . |
| Step 3 | Click Add Identity Provider . |

Step 4 Enter the following details:

| Field | Description |
|--|---|
| Profile Name | Enter a name for the identity provider profile. |
| Configuration Settings (Manually Configure Identity Provider Settings) | |
| Entity ID | Enter a globally unique name for the identity provider. The format of the identity provider Entity ID is typically a URI. |
| SSO URL | Specify the URL to which the service provider must send the SAML authentication requests. |
| Certificate | If the identity provider signs the SAML assertion, you must upload the identity provider's signing certificate. |
| Configuration Settings (Importing Identity Provider Metadata) | |
| Import IDP Metadata | Click Import Metadata and select the metadata file. |

Step 5 Submit and commit your changes.

What to do next

[Enable SAML Authentication, on page 973.](#)

System Time

It is recommended that you avoid changing the time settings on the appliance .

To set the System Time on your appliance , set the Time Zone used, or select an NTP server and query interface, use the Time Zone or Time Settings page from the System Administration menu in the GUI or use the following commands in the CLI: `ntpconfig` , `settime` , and `settz` .

You can also verify the time zone files used by AsyncOS on the **System Administration > Time Settings** page or using the `tzupdate` CLI command.

Selecting a Time Zone

The Time Zone page (available via the System Administration menu in the GUI) displays the time zone for your appliance . You can select a specific time zone or GMT offset.

Procedure

Step 1 Click **Edit Settings** on the **System Administration > Time Zone** page.

Step 2 Select a Region, country, and time zone from the pull-down menus.

Step 3 Submit and commit your changes.

Selecting a GMT Offset

Procedure

- Step 1** Click **Edit Settings** on the **System Administration > Time Zone** page.
- Step 2** Select GMT Offset from the list of regions.
- Step 3** Select an offset in the Time Zone list. The offset refers to the amount of hours that must be added/subtracted in order to reach GMT (the Prime Meridian). Hours preceded by a minus sign (“-”) are east of the Prime Meridian. A plus sign (“+”) indicates west of the Prime Meridian.
- Step 4** Submit and commit your changes.
-

Editing Time Settings

You can edit the time settings for the appliance using one of the following methods:

- [\(Recommended\) Setting Appliance System Time Using the Network Time Protocol \(NTP\), on page 1059](#)
- [Setting Appliance System Time Manually , on page 1059](#)

(Recommended) Setting Appliance System Time Using the Network Time Protocol (NTP)

This is the recommended time keeping method, especially if your appliance is integrated with other devices. All integrated devices should use the same NTP server.

Procedure

- Step 1** Navigate to the System Administration > Time Settings page.
- Step 2** Click **Edit Settings**.
- Step 3** In the Time Keeping Method section, select Use Network Time Protocol.
- Step 4** Enter an NTP server address and click **Add Row**. You can add multiple NTP servers.
- Step 5** To delete an NTP server from the list, click the trash can icon for that server.
- Step 6** Select an interface for NTP queries. This is the IP address from which NTP queries should originate.
- Step 7** Submit and commit your changes.
-

Setting Appliance System Time Manually

This time keeping method is generally not recommended. Use a Network Time Protocol server instead.

Procedure

-
- Step 1** Navigate to the System Administration > Time Settings page.
 - Step 2** Click **Edit Settings**.
 - Step 3** In the Time Keeping Method section, select Set Time Manually.
 - Step 4** Enter the month, day, year, hour, minutes, and seconds.
 - Step 5** Select A.M or P.M.
 - Step 6** Submit and commit your changes.
-

Customizing Your View

- [Using Favorite Pages](#) , on page 1060
- [Setting User Preferences](#), on page 1060

Using Favorite Pages

(Locally-authenticated administrative users only.) You can create a quick-access list of the pages you use most.

| To | Do This |
|---------------------------------------|--|
| Add pages to your favorites list | Navigate to the page to add, then choose Add This Page To My Favorites from the My Favorites menu near the top right corner of the window.

No commit is necessary for changes to My Favorites. |
| Reorder favorites | Choose My Favorites > View All My Favorites and drag favorites into the desired order. |
| Delete favorites | Choose My Favorites > View All My Favorites and delete favorites. |
| Go to a favorite page | Choose a page from the My Favorites menu near the top right corner of the window. |
| View or build a custom reporting page | See My Dashboard Page , on page 811. |

Setting User Preferences

Local users can define preference settings, such as language, specific to each account. These settings apply by default when the user first logs into the appliance . The preference settings are stored for each user and are the same regardless from which client machine the user logs into the appliance .

When users change these settings but do not commit the changes, the settings revert to the default values when they log in again.



Note This feature is not available to externally-authenticated users. These users can choose a language directly from the Options menu.

Procedure

- Step 1** Log into the appliance with the user account for which you want to define preference settings.
- Step 2** Choose **Options > Preferences**. The options menu is at the top right side of the window.
- Step 3** Click **Edit Preferences**.
- Step 4** Configure settings:

| Preference Setting | Description |
|--|--|
| Language Display | The language AsyncOS for Web uses in the web interface and CLI. |
| Landing Page | The page that displays when the user logs into the appliance |
| Reporting Time Range Displayed (default) | The default time range that displays for reports on the Reporting tab. |
| Number of Reporting Rows Displayed | The number of rows of data shown for each report by default. |

- Step 5** Submit and commit your changes.
- Step 6** Click the **Return to previous page** link at the bottom of the page.

General Settings

You can edit the following general settings for the appliance :

- [Overriding Internet Explorer Compatibility Mode, on page 1061](#)
- [Collecting Usage Statistics of the Appliance on the New Web Interface , on page 1062](#)

Overriding Internet Explorer Compatibility Mode

For better web interface rendering, Cisco recommends that you enable Internet Explorer Compatibility Mode Override.



Note If enabling this feature is against your organizational policy, you may disable this feature.

Procedure

- Step 1** Click **System Administration > General Settings**.
 - Step 2** Select **Override IE Compatibility Mode** check box.
 - Step 3** Submit and commit your changes.
-

Collecting Usage Statistics of the Appliance on the New Web Interface

Usage Analytics is used to provide insight into your site activity data for analytical statistics. If Usage Analytics is enabled, the appliance collects the feature usage data of the appliance on the new web interface. The usage statistics are used to analyze and provide insight to improve the user experience of the appliance .

Usage Analytics is enabled on the appliance by default. If you want to disable Usage Analytics, do the following:

Procedure

- Step 1** Click **System Administration > General Settings**.
 - Step 2** Clear the **Usage Analytics** check box.
 - Step 3** Submit and commit your changes.
-

Configuring Maximum HTTP Header Size

You can now use the `adminaccessconfig > maxhttpheaderfieldsize` command in the CLI to configure the maximum HTTP header size of an HTTP request sent to the appliance .

The default value for the HTTP header field size is 4096 (4 KB) and the maximum value is 33554432 (32 MB).

Restarting and Viewing Status of Service Engines

You can use the `diagnostic > servicessub` command in the CLI to:

- Restart the service engines enabled on your appliance without having to reboot your appliance .
- View the status of service engines enabled on your appliance .

For more information, refer to the CLI Reference Guide for Email Security Appliance .



CHAPTER 39

Managing and Monitoring Using the CLI

This chapter contains the following sections:

- [Overview of Managing and Monitoring Using the CLI, on page 1063](#)
- [Reading the Available Components of Monitoring, on page 1064](#)
- [Monitoring Using the CLI, on page 1069](#)
- [Managing the Email Queue, on page 1079](#)
- [Monitoring System Health and Status Using SNMP, on page 1088](#)

Overview of Managing and Monitoring Using the CLI

Managing and monitoring the appliance using the CLI includes these types of tasks:

- Monitoring message activity.
 - The raw number of messages, recipients, and bounce recipients that the appliance is processing in the email pipeline
 - The hourly rate of message delivery or message bounces based on the last one-minute, five-minute, or fifteen-minute period
- Monitoring system resources. Examples:
 - Memory usage
 - Disk space
 - Number of connections
- Monitoring possible system disfunction using the Simple Network Management Protocol (SNMP). Examples:
 - Fan failure
 - Update failure
 - Abnormally high appliance temperature
- Managing email within the pipeline. Examples:
 - Deleting recipients in the queue
 - Redirecting messages to another host
 - Clear the queue by deleting recipients or redirecting the messages
 - Suspend or resume email receiving, delivery, or work queue processing
 - Locate specific messages

Reading the Available Components of Monitoring

- [Reading the Event Counters, on page 1064](#)
- [Reading the System Gauges, on page 1066](#)
- [Reading the Rates of Delivered and Bounced Messages, on page 1068](#)

Reading the Event Counters

Counters provide a running total of various events in the system. For each counter, you can view the total number of events that have occurred since the counter was reset, since the last system reboot, and over the system's lifetime.

Counters increment each time an event occurs and are displayed in three versions:

| Reset | Since the last counter reset with the <code>resetcounters</code> command |
|----------|--|
| Uptime | Since the last system reboot |
| Lifetime | Total through the lifetime of the appliance |

The following table lists the available counters and their description when monitoring the appliance .



Note This is the entire list. The displayed counters vary depending on which display option or command you choose. Use this list as a reference.

Table 106: Counters

| Statistic | Description |
|-----------------------------|--|
| Receiving | |
| Messages Received | Messages received into the delivery queue. |
| Recipients Received | Recipients on all received messages. |
| Generated Bounce Recipients | Recipients for which bounces have been generated by the system and inserted into the delivery queue. |
| Rejection | |
| Rejected Recipients | Recipients that have been denied receiving into the delivery queue due to the Recipient Access Table (RAT), or unexpected protocol negotiation including premature connection termination. |

| Statistic | Description |
|-------------------------|--|
| Dropped Messages | Messages that have been denied receiving into the delivery queue due to a filter drop action match or have been received by a Sinkhole queuing listener. Messages directed to /dev/null entries in the alias table also are considered dropped messages. Messages dropped by anti-spam filtering (if it has been enabled on the system) also increment this counter. |
| Queue | |
| Soft Bounced Events | Number of soft bounce events — a message that soft bounces multiple times has multiple soft bounce events. |
| Completion | |
| Completed Recipients | Total of all hard bounced recipients, delivered recipients, and deleted recipients. Any recipient that is removed from the delivery queue. |
| Hard Bounced Recipients | Total of all DNS hard bounces, 5XX hard bounces, filter hard bounces, expired hard bounces and other hard bounces. A failed attempt to deliver message to a recipient that results in immediate termination of that delivery. |
| DNS Hard Bounces | DNS error encountered while trying to deliver a message to a recipient. |
| 5XX Hard Bounces | The destination mail server returned a “5XX” response code while trying to deliver a message to a recipient. |
| Expired Hard Bounces | Message recipients that have exceeded the maximum time allowed in the delivery queue or the maximum number of connection attempts. |
| Filter Hard Bounces | Recipient delivery has been preempted by a matching filter bounce action. Messages dropped by anti-spam filtering (if it has been enabled on the system) also increment this counter. |
| Other Hard Bounces | An unexpected error during message delivery or a message recipient was explicitly bounced via the bouncerecipients command. |
| Delivered Recipients | Message successfully delivered to a recipient. |
| Deleted Recipients | Total of message recipients explicitly deleted via the deleterecipients command or was a Global Unsubscribe Hit. |
| Global Unsubscribe Hits | Message recipient was deleted due to a matching global unsubscribe setting. |
| Current IDs | |

| Statistic | Description |
|--------------------------------|---|
| Message ID (MID) | The last Message ID to have been assigned to a message inserted into the delivery queue. A MID is associated with every message received by the appliance and can be tracked in mail logs. The MID resets to zero at 231. |
| Injection Connection ID (ICID) | The last Injection Connection ID to have been assigned to a connection to a listener interface. The ICID rolls over (resets to zero) at 231. |
| Delivery Connection ID (DCID) | The last Delivery Connection ID to have been assigned to a connection to a destination mail server. The DCID rolls over (resets to zero) at 231. |

Reading the System Gauges

Gauges show the current utilization of a system resource such as memory, disk space, or active connections. The following table lists the available gauges and their description when monitoring the appliance .



Note This is the entire list. The displayed gauges will vary depending upon which display option or command you choose. Use this list as a reference.

Table 107: Gauges

| Statistic | Description |
|----------------------|--|
| System Gauges | |
| RAM Utilization | Percentage of physical RAM (Random Access Memory) being used by the system. |
| CPU Utilization | Percentage of CPU usage. |
| Disk I/O Utilization | Percentage of Disk I/O being used.

Note The Disk I/O Utilization gauge does not display a reading against a scale of a known value. Rather, it displays the I/O utilization the system has seen thus far and scales against the maximum value since the last reboot. So, if the gauge displays 100%, the system is experiencing the highest level of I/O utilization seen since boot (which may not necessarily represent 100% of the physical Disk I/O of the entire system). |

| Statistic | Description |
|------------------------------|---|
| Resource Conservation | A value between 0 and 60 or 999 . Numbers from 0 to 60 represent the degree to which the system is decreasing its acceptance of messages in order to prevent the rapid depletion of critical system resources. Higher numbers represent a higher degree of decreased acceptance. Zero represents no decrease in acceptance. If this gauge displays 999 , the system has entered “Resource Conservation mode,” and it will accept no messages. Alert messages are sent whenever the system enters or exits Resource Conservation mode. |
| Disk Utilization: Logs | Percentage of disk being used for logs, displayed as LogUsd in the status logs and log_used in the XML status. |
| Connections Gauges | |
| Current Inbound Connections | Current inbound connections to the listener interfaces. |
| Current Outbound Connections | Current outbound connections to destination mail servers. |
| Queue Gauges | |
| Active Recipients | Message recipients in the delivery queue. Total of Unattempted Recipients and Attempted Recipients. |
| Unattempted Recipients | A subcategory of Active Recipients. Message recipients in queue for which delivery has not yet been attempted. |
| Attempted Recipients | A subcategory of Active Recipients. Message recipients in queue for which delivery has been attempted but failed due to a Soft Bounces Event. |
| Messages in Work Queue | The number of messages waiting to be processed by alias table expansion, masquerading, anti-spam, anti-virus scanning, message filters, and LDAP queries prior to being enqueued. |
| Messages in Quarantine | The unique number of messages in any quarantine, plus messages that have been released or deleted but not yet acted upon. For example, if you release all quarantined messages from Outbreak, the total messages for Outbreak would become zero immediately, but this field still reflects the quarantined messages until they were all delivered. |

| Statistic | Description |
|-------------------------|--|
| Destinations in Memory | The number of destinations domains in memory. For each domain with a message destined to be delivered, a destination object is created in memory. After all the mail for that domain has been delivered, the destination object is retained for another 3 hours. After 3 hours, if no new messages are bound for that domain, the object is expired so that the destination is no longer reported (for example, in the <code>tophosts</code> command). If you are delivering mail only to one domain, this counter will be “1.” If you have never received or sent any messages (or no messages have been processed by the appliance in many hours), the counter will be “0.”

If you are using Virtual Gateways, destination domains for each Virtual Gateway will have a separate destination object. (For example, <code>yahoo.com</code> will count as 3 destination objects if you are delivering to <code>yahoo.com</code> from 3 different Virtual Gateways). |
| Kilobytes Used | Queue storage used in kilobytes. |
| Kilobytes in Quarantine | Queue storage used for quarantined messages. The value is calculated as the message size plus 30 bytes for each recipient, totaled for the “Messages in Quarantine” as counted above. Note that this calculation will usually <i>overestimate</i> the space used. |
| Kilobytes Free | Queue storage remaining in kilobytes. |

Reading the Rates of Delivered and Bounced Messages

All rates are shown as the average rate an event occurs per hour at the specific point in time the query is made. Rates are calculated for three intervals, the average rate per hour over the past one (1) minute, the past five (5) minutes, and the past fifteen (15) minutes.

For example, if the appliance receives 100 recipients in a single minute, then the rate for the 1 minute interval will be 6,000 per hour. The rate for the 5-minute interval will be 1,200 per hour, and the 15-minute rate will be 400 per hour. The rates are calculated to indicate what the average rate for the hour would be if the rate for the one minute period continued. Therefore, 100 messages each minute would yield a higher rate than 100 messages over 15 minutes.

The following table lists the available rates and their description when monitoring the appliance .



Note This is the entire list. The displayed rates will vary depending upon which display option or command you choose. Use this list as a reference.

Table 108: Rates

| Statistic | Description |
|-------------------|---|
| Messages Received | Rate of messages inserted into the delivery queue per hour. |

| Statistic | Description |
|-------------------------|---|
| Recipients Received | Rate of the number of recipients on all messages inserted into the delivery queue per hour. |
| Soft Bounced Events | Rate of the number of soft bounce events per hour. (A message that soft bounces multiple times has multiple soft bounce events.) |
| Completed Recipients | Rate of the total of all hard bounced recipients, delivered recipients and deleted recipients. Any recipient that is removed from the delivery queue is considered completed. |
| Hard Bounced Recipients | Rate of the total of all DNS hard bounces, 5XX hard bounces, filter hard bounces, expired hard bounces and other hard bounces per hour. A failed attempt to deliver a message to a recipient that results in immediate termination of that delivery is a hard bounce. |
| Delivered Recipients | Rate of messages successfully delivered to a recipient per hour. |

Monitoring Using the CLI

- [Monitoring the Email Status, on page 1069](#)
- [Monitoring Detailed Email Status, on page 1070](#)
- [Monitoring the Status of a Mail Host, on page 1072](#)
- [Determining the Make-up of the Email Queue, on page 1074](#)
- [Displaying Real-time Activity, on page 1075](#)
- [Monitoring Inbound Email Connections, on page 1076](#)
- [Checking the DNS Status, on page 1077](#)
- [Resetting Email Monitoring Counters, on page 1078](#)
- [Identifying Active TCP/IP Services, on page 1079](#)

Monitoring the Email Status

You may want to monitor the status of email operations on the appliance. The `status` command returns a subset of the monitored information about email operations. The statistics returned displayed in one of two fashions: counters and gauges. Counters provide a running total of various events in the system. For each counter, you can view the total number of events that have occurred since the counter was reset, since the last system reboot, and over the system's lifetime. Gauges show the current utilization of a system resource such as memory, disk space, or active connections.

For a description of each item, see [Overview of Managing and Monitoring Using the CLI, on page 1063](#).

Table 109: Mail Status

| Statistic | Description |
|--------------------|---|
| Status as of | Displays the current system time and date. |
| Last counter reset | Displays the last time the counters were reset. |

Example

| Statistic | Description |
|----------------|--|
| System status | Online, offline, receiving suspended, or delivery suspended. Note that the status will be “receiving suspended” only when <i>all</i> listeners are suspended. The status will be “offline” when receiving and delivery are suspended for <i>all</i> listeners. |
| Oldest Message | Displays the oldest message waiting to be delivered by the system. |
| Features | Displays any special features installed on the system by the featurekey command. |

Example

```
mail3.example.com> status

Status as of:          Thu Oct 21 14:33:27 2004 PDT
Up since:              Wed Oct 20 15:47:58 2004 PDT (22h 45m 29s)
Last counter reset:   Never
System status:        Online
Oldest Message:       4 weeks 46 mins 53 secs
Counters:              Reset      Uptime      Lifetime
  Receiving
    Messages Received  62,049,822      290,920      62,049,822
    Recipients Received 62,049,823      290,920      62,049,823
  Rejection
    Rejected Recipients 3,949,663        11,921        3,949,663
    Dropped Messages    11,606,037         219          11,606,037
  Queue
    Soft Bounced Events 2,334,552        13,598        2,334,552
  Completion
    Completed Recipients 50,441,741       332,625       50,441,741
  Current IDs
    Message ID (MID)                99524480
    Injection Conn. ID (ICID)        51180368
    Delivery Conn. ID (DCID)         17550674
Gauges:                  Current
  Connections
    Current Inbound Conn.            0
    Current Outbound Conn.           14
  Queue
    Active Recipients                 7,166
    Messages In Work Queue            0
    Messages In Quarantine            16,248
    Kilobytes Used                     387,143
    Kilobytes In Quarantine            338,206
    Kilobytes Free                     39,458,745
mail3.example.com>
```

Monitoring Detailed Email Status

The status detail command returns complete monitored information about email operations. The statistics returned are displayed in one of three categories: counters, rates, and gauges. Counters provide a running total of various events in the system. For each counter, you can view the total number of events that have occurred since the counter was reset, since the last system reboot, and over the system’s lifetime. Gauges show the current utilization of a system resource such as memory, disk space, or active connections. All rates are shown as the average rate an event occurs per hour at the specific point in time the query is made. Rates are calculated for three intervals, the average rate per hour over the past one (1) minute, the past five (5) minutes, and the

past fifteen (15) minutes. For a description of each item, see [Overview of Managing and Monitoring Using the CLI, on page 1063](#).

Example

```
mail3.example.com> status detail
Status as of:          Thu Jun 30 13:09:18 2005 PDT
Up since:              Thu Jun 23 22:21:14 2005 PDT (6d 14h 48m 4s)
Last counter reset:   Tue Jun 29 19:30:42 2004 PDT
System status:        Online
Oldest Message:       No Messages
Feature - IronPort Anti-Spam: 17 days
Feature - Sophos:     Dormant/Perpetual
Feature - Outbreak Filters: Dormant/Perpetual
Feature - Central Mgmt: Dormant/Perpetual
Counters:
  Reset              Uptime              Lifetime
Receiving
  Messages Received  2,571,967          24,760             3,113,176
  Recipients Received 2,914,875          25,450             3,468,024
  Gen. Bounce Recipients 2,165              0                  7,451
Rejection
  Rejected Recipients 1,019,453          792                1,740,603
  Dropped Messages    1,209,001          66                 1,209,028
Queue
  Soft Bounced Events 11,236             0                  11,405
Completion
  Completed Recipients 2,591,740          49,095             3,145,002
  Hard Bounced Recipients 2,469              0                  7,875
    DNS Hard Bounces    199                0                  3,235
    5XX Hard Bounces    2,151              0                  4,520
    Expired Hard Bounces 119                0                  120
    Filter Hard Bounces 0                   0                  0
    Other Hard Bounces 0                   0                  0
  Delivered Recipients 2,589,270          49,095             3,137,126
  Deleted Recipients 1                   0                  1
    Global Unsub. Hits 0                   0                  0
  DomainKeys Signed Msgs 10                  9                  10
Current IDs
  Message ID (MID)                                7615199
  Injection Conn. ID (ICID)                       3263654
  Delivery Conn. ID (DCID)                       1988479
Rates (Events Per Hour):
  1-Minute      5-Minutes      15-Minutes
Receiving
  Messages Received    180            300            188
  Recipients Received 180            300            188
Queue
  Soft Bounced Events 0              0              0
Completion
  Completed Recipients 360            600            368
  Hard Bounced Recipients 0              0              0
  Delivered Recipients 360            600            368
Gauges:
  Current
System
  RAM Utilization      1%
  CPU Utilization
    MGA                0%
    AntiSpam           0%
    AntiVirus          0%
  Disk I/O Utilization 0%
  Resource Conservation 0
Connections
  Current Inbound Conn. 0
```

```

Current Outbound Conn.          0
Queue
  Active Recipients              0
    Unattempted Recipients      0
    Attempted Recipients        0
  Messages In Work Queue        0
  Messages In Quarantine        19
  Destinations In Memory        3
  Kilobytes Used                 473
    Kilobytes In Quarantine     473
  Kilobytes Free                 39,845,415

```



Note A case could exist in a newly installed appliance where the oldest message counter shows a message but, in fact, there are no recipients shown in counters. If the remote host is connecting and in the process of receiving a message very slowly (that is, it takes minutes to receive a message), you might see that the recipients received counter displays “0” but the oldest message counter displays “1.” This is because the oldest message counter displays messages in progress. The counter will be reset if the connection is eventually dropped.

Monitoring the Status of a Mail Host

If you suspect delivery problems to a specific recipient host or you want to gather information on a Virtual Gateway address, the `hoststatus` command displays this information. The `hoststatus` command returns monitoring information about email operations relating to a specific recipient host. The command requires that you enter the domain of the host information to be returned. DNS information stored in the AsyncOS cache and the last error returned from the recipient host is also given. Data returned is cumulative since the last `resetcounters` command. The statistics returned are displayed in two categories: counters and gauges. For a description of each item, see [Overview of Managing and Monitoring Using the CLI, on page 1063](#).

In addition, these other data are returned specific to the `hoststatus` command.

Table 110: Additional Data in the `hoststatus` Command

| Statistic | Description |
|------------------------------|--|
| Pending Outbound Connections | Pending, or “embryonic” connections to the destination mail host, as opposed to open and working connections. Pending Outbound Connections are connections which have not yet gotten to the protocol greeting stage. |
| Oldest Message | The age of the oldest active recipient in the delivery queue for this domains. This counter is useful for determining the age of a message in the queue that cannot be delivered because of soft bounce events and/or a downed host. |
| Last Activity | This field is updated each time a message delivery is attempted to that host. |
| Ordered IP Addresses | This field contains the TTL (time to live) for IP addresses, their preference according to MX records, and the actual addresses. An MX record designates the mail server IP address for a domain. A domain may have multiple MX records. Each MX record mail server is assigned a priority. The MX record with the lowest priority number is given preference. |
| Last 5XX error | This field contains the most recent “5XX” status code and description returned by the host. This is only displayed if there is an 5XX error. |

| Statistic | Description |
|---------------------------|---|
| MX Records | An MX record designates the mail server IP address for a domain. A domain may have multiple MX records. Each MX record mail server is assigned a priority. The MX record with the lowest priority number is given preference. |
| SMTP Routes for this host | If SMTP routes are defined for this domain, they are listed here. |
| Last TLS Error | This field contains a description of the the most recent outgoing TLS connection error and the type of TLS connection that the appliance tried to establish. This is only displayed if there is a TLS error. |

Virtual Gateway

The following Virtual Gateway information is only displayed if you have set up Virtual Gateway addresses (see [Configuring the Gateway to Receive Email, on page 69](#).)

Table 111: Additional Virtual Gateway Data in the hoststatus Command

| Statistic | Description |
|----------------|---|
| Host up/down | Same definition as global hoststatus field of the same name — tracked per Virtual Gateway address. |
| Last Activity | Same definition as global hoststatus field of the same name — tracked per Virtual Gateway address. |
| Recipients | This field also corresponds to the same definition as the global hoststatus command. Active Recipients field — tracked per Virtual Gateway address. |
| Last 5XX error | This field contains the most recent 5XX status code and description returned by the host. This is only displayed if there is a 5XX error. |

Example

```
mail3.example.com> hoststatus

Recipient host:
[]> aol.com
Host mail status for: 'aol.com'
Status as of:      Tue Mar 02 15:17:32 2010
Host up/down:     up
Counters:
  Queue
    Soft Bounced Events          0
  Completion
    Completed Recipients          1
    Hard Bounced Recipients      1
      DNS Hard Bounces            0
      5XX Hard Bounces            1
      Filter Hard Bounces         0
      Expired Hard Bounces        0
      Other Hard Bounces          0
    Delivered Recipients          0
    Deleted Recipients            0
```

```

Gauges:
Queue
  Active Recipients                0
  Unattempted Recipients           0
  Attempted Recipients             0
Connections
  Current Outbound Connections     0
  Pending Outbound Connections    0
Oldest Message                    No Messages
Last Activity                      Tue Mar 02 15:17:32 2010
Ordered IP addresses: (expiring at Tue Mar 02 16:17:32 2010)
Preference  IPs
15          64.12.137.121    64.12.138.89    64.12.138.120
15          64.12.137.89    64.12.138.152   152.163.224.122
15          64.12.137.184   64.12.137.89    64.12.136.57
15          64.12.138.57    64.12.136.153   205.188.156.122
15          64.12.138.57    64.12.137.152   64.12.136.89
15          64.12.138.89    205.188.156.154 64.12.138.152
15          64.12.136.121   152.163.224.26  64.12.137.184
15          64.12.138.120   64.12.137.152   64.12.137.121
MX Records:
Preference  TTL      Hostname
15          52m24s  mailin-01.mx.aol.com
15          52m24s  mailin-02.mx.aol.com
15          52m24s  mailin-03.mx.aol.com
15          52m24s  mailin-04.mx.aol.com
Last 5XX Error:
-----
550 REQUESTED ACTION NOT TAKEN: DNS FAILURE
(at Tue Mar 02 15:17:32 2010 GMT) IP: 10.10.10.10
-----
Last TLS Error:                Required - Verify
-----
TLS required, STARTTLS unavailable
(at Tue Mar 02 15:17:32 2010 GMT) IP: 10.10.10.10
Virtual gateway information:
=====
example.com (PublicNet_017):
Host up/down:                  up
Last Activity                   Wed June 22 13:47:02 2005
Recipients                       0

```



Note The Virtual Gateway address information only appears if you are using the altsrhost feature.

Determining the Make-up of the Email Queue

To get immediate information about the email queue and determine if a particular recipient host has delivery problems — such as a queue buildup — use the `tophosts` command. The `tophosts` command returns a list of the top 20 recipient hosts in the queue. The list can be sorted by a number of different statistics, including active recipients, connections out, delivered recipients, soft bounced events, and hard bounced recipients. For a description of each item, see [Overview of Managing and Monitoring Using the CLI, on page 1063](#).

Example

```
mail3.example.com> tophosts
```



```

Sort results by:
1. Active Recipients
2. Connections Out
3. Delivered Recipients
4. Soft Bounced Events
5. Hard Bounced Recipients
[1]> 1
Status as of:      Mon Nov 18 22:22:23 2003
# Recipient Host  Active  Conn.  Deliv.  Soft  Hard
                  Recip   Out   Recip.  Bounced  Bounced
1 aol.com          365    10    255    21    8
2 hotmail.com     290    7     198    28    13
3 yahoo.com       134    6     123    11    19
4 excite.com      98     3     84     9     4
5 msn.com         84     2     76     33    29
mail3.example.com>
    
```

Displaying Real-time Activity

The appliance offers real-time monitoring, which allows you to view the progress of email activity on the system. The `rate` command returns real-time monitoring information about email operations. The information is updated on a periodic interval as specified by you. Use Control-C to stop the `rate` command.

The data shown are listed in the following table:

Table 112: Data in the rate Command

| Statistic | Description |
|----------------------|--|
| Connections In | Number of inbound connections. |
| Connections Out | Number of outbound connections. |
| Recipients Received | Total number of recipients received into the system. |
| Recipients Completed | Total number of recipients completed. |
| Delta | The difference change in Received and Completed recipients since the last data update. |
| Queue Used | Size of the message queue in kilobytes. |

Example

```

mail3.example.com> rate

Enter the number of seconds between displays.
[10]> 1
Hit Ctrl-C to return to the main prompt.
Time      Connections Recipients      Recipients      Queue
          In      Out   Received   Delta  Completed   Delta   K-Used
23:37:13  10    2    41708833   0     40842686   0      64
23:37:14   8    2    41708841   8     40842692   6     105
23:37:15   9    2    41708848   7     40842700   8      76
23:37:16   7    3    41708852   4     40842705   5      64
23:37:17   5    3    41708858   6     40842711   6      64
23:37:18   9    3    41708871  13     40842722  11      67
    
```

Example

```

23:37:19      7      3  41708881      10  40842734      12      64
23:37:21     11      3  41708893      12  40842744      10      79
^C

```

The `hostrate` command returns real-time monitoring information about a specific mail host. This information is a subset of the status detail command. (See [Monitoring Detailed Email Status](#), on page 1070.)

Table 113: Data in the `hostrate` Command

| Statistic | Description |
|----------------------------------|---|
| Host Status | Current status of the specific host: up, down, or unknown. |
| Current Connections Out | Current number of outbound connections to the host. |
| Active Recipients in Queue | Total number of active recipients to the specific host in queue. |
| Active Recipients in Queue Delta | Difference in the total number of active recipients to the specific host in queue since the last known host status. |
| Delivered Recipients Delta | Difference in the total number of delivered recipients to the specific host in queue since the last known host status. |
| Hard Bounced Recipients Delta | Difference in the total number of hard bounced recipients to the specific host in queue since the last known host status. |
| Soft Bounce Events Delta | Difference in the total number of soft bounced recipients to the specific host in queue since the last known host status. |

Use Control-C to stop the `hostrate` command.

Example

```

mail3.example.com> hostrate
Recipient host:
[]> aol.com
Enter the number of seconds between displays.
[10]> 1
   Time      Host  CrtCncOut  ActvRcp  ActvRcp  DlvRcp  HrdBncRcp  SftBncEvt
   Status                                     Delta    Delta      Delta    Delta
23:38:23      up      1          0          0          4          0          0
23:38:24      up      1          0          0          4          0          0
23:38:25      up      1          0          0         12          0          0
^C

```

Monitoring Inbound Email Connections

You may want to monitor hosts that are connecting to the appliance to identify the large volume senders or to troubleshoot inbound connections to the system. The `topin` command provides a snapshot of the remote hosts connecting to the system. It displays a table with one row for each remote IP address connecting to a specific listener. Two connections from the same IP address to different listeners results in 2 rows in the following table describes the fields displayed when using the `topin` command.

Table 114: Data in the `topin` Command

| Statistic | Description |
|-------------------|---|
| Remote Hostname | Hostname of the remote host, derived from Reverse DNS lookup. |
| Remote IP Address | IP address of the remote host. |
| listener | Nickname of the listener on the appliance that is receiving the connection. |
| Connections In | The number of concurrent connections from the remote host with the specified IP address open at the time when the command is run. |

The system does a reverse DNS lookup to find the remote hostname, and then a forward DNS lookup to validate the name. If the forward lookup does not result in the original IP address, or if the reverse DNS lookup fails, the table displays the IP address in the hostname column. For more information about the process of sender verification, see [Verifying Senders, on page 116](#).

Example

```
mail3.example.com> topin
```

```
Status as of:                               Sat Aug 23 21:50:54 2003
# Remote hostname      Remote IP addr.  listener        Conn. In
1 mail.remotedomain01.com 172.16.0.2      Incoming01      10
2 mail.remotedomain01.com 172.16.0.2      Incoming02      10
3 mail.remotedomain03.com 172.16.0.4      Incoming01      5
4 mail.remotedomain04.com 172.16.0.5      Incoming02      4
5 mail.remotedomain05.com 172.16.0.6      Incoming01      3
6 mail.remotedomain06.com 172.16.0.7      Incoming02      3
7 mail.remotedomain07.com 172.16.0.8      Incoming01      3
8 mail.remotedomain08.com 172.16.0.9      Incoming01      3
9 mail.remotedomain09.com 172.16.0.10     Incoming01      3
10 mail.remotedomain10.com 172.16.0.11     Incoming01      2
11 mail.remotedomain11.com 172.16.0.12     Incoming01      2
12 mail.remotedomain12.com 172.16.0.13     Incoming02      2
13 mail.remotedomain13.com 172.16.0.14     Incoming01      2
14 mail.remotedomain14.com 172.16.0.15     Incoming01      2
15 mail.remotedomain15.com 172.16.0.16     Incoming01      2
16 mail.remotedomain16.com 172.16.0.17     Incoming01      2
17 mail.remotedomain17.com 172.16.0.18     Incoming01      1
18 mail.remotedomain18.com 172.16.0.19     Incoming02      1
19 mail.remotedomain19.com 172.16.0.20     Incoming01      1
20 mail.remotedomain20.com 172.16.0.21     Incoming01      1
```

Checking the DNS Status

The `dnsstatus` command returns a counter displaying statistics of DNS lookup and cache information. For each counter, you can view the total number of events since the counter was last reset, since the last system reboot, and over the lifetime of the system.

The following table lists the available counters.

Table 115: Data in the `dnsstatus` Command

| Statistic | Description |
|------------------|---|
| DNS Requests | A top-level, non-recursive request to the system DNS cache to resolve a domain name. |
| Network Requests | A request to the network (non-local) to retrieve DNS information. |
| Cache Hits | A request to the DNS cache where the record was found and returned. |
| Cache Misses | A request to the DNS cache where the record was not found. |
| Cache Exceptions | A request to the DNS cache where the record was found but the domain was unknown. |
| Cache Expired | A request to the DNS cache where the record was found in the cache, considered for use, and discarded because it was too old.

Many entries can exist in the cache even though their time to live (TTL) has been exceeded. As long as these entries are not used, they will not be included in the expires counter. When the cache is flushed, both valid and invalid (too old) entries are deleted. A flush operation does not change the expires counter. |

Example

```
mail3.example.com> dnsstatus
Status as of: Sat Aug 23 21:57:28 2003
Counters:           Reset           Uptime           Lifetime
DNS Requests       211,735,710       8,269,306        252,177,342
Network Requests   182,026,818       6,858,332        206,963,542
Cache Hits         474,675,247       17,934,227       541,605,545
Cache Misses       624,023,089       24,072,819       704,767,877
Cache Exceptions   35,246,211        1,568,005        51,445,744
Cache Expired      418,369           7,800            429,015
mail3.example.com>
```

Resetting Email Monitoring Counters



Caution

It is recommended that you avoid resetting email monitoring counters on Cloud Email Security appliances.

The `resetcounters` command resets cumulative email monitoring counters. The reset affects global counters as well as per host counters. The reset does not affect the counters on messages in the delivery queue related to retry schedules.



Note

You can also reset the counters in the GUI. See [System Status Page, on page 836](#).

Example

```
mail3.example.com> resetcounters
Counters reset: Mon Jan 01 12:00:01 2003
```

Identifying Active TCP/IP Services

To identify active TCP/IP services used by your appliance, use the `tcp services` command in the command line interface.

Managing the Email Queue

Cisco AsyncOS allows you to perform operations on messages in the email queue. You can delete, bounce, suspend, or redirect messages in the email queue. You can also locate, remove, and archive older messages in your queue.

Deleting Recipients in Queue

If particular recipients are not being delivered or to clear the email queue, use the `deleterecipients` command. The `deleterecipients` command allows you to manage the email delivery queue by deleting specific recipients waiting for delivery. Recipients to be deleted are identified by either the recipient host that the recipient is destined for, or the message sender identified by the specific address given in the Envelope From line of the message envelope. Alternately, you can delete all messages in the delivery queue (all active recipients) at once.



Note To perform the `deleterecipients` function, it is recommended that you place the appliance in an offline state or suspended delivery (see [Suspending Email Receiving and Delivery](#), on page 984).



Note Although the function is supported in all states, certain messages may be delivered while the function is taking place.

Matches to recipient hosts and senders must be identical string matches. Wild cards are not accepted. The `deleterecipients` command returns the total number of messages deleted. In addition, if a mail log subscription (IronPort text format only) is configured, the message deletion is logged as a separate line.

Example

```
mail3.example.com> deleterecipients
Please select how you would like to delete messages:
1. By recipient host.
2. By Envelope From address.
3. All.
[1]>
```

The appliance gives you various options to delete recipients depending upon the need. The following example show deleting recipients by recipient host, deleting by Envelope From Address, and deleting all recipients in the queue.

Delete by Recipient Domain

```
Please enter the hostname for the messages you wish to delete.
[ ]> example.com
Are you sure you want to delete all messages being delivered to "example.com"? [N]> Y
Deleting messages, please wait.
100 messages deleted.
```

Delete by Envelope From Address

```
Please enter the Envelope From address for the messages you wish to delete.
[ ]> mailadmin@example.com
Are you sure you want to delete all messages with the Envelope From address of
"mailadmin@example.com"? [N]> Y
Deleting messages, please wait.
100 messages deleted.
```

Delete All

```
Are you sure you want to delete all messages in the delivery queue (all active recipients)?
[N]> Y
Deleting messages, please wait.
1000 messages deleted.
```

Bouncing Recipients in Queue

Similar to the `deleterecipients` command, the `bouncerecipients` command allows you to manage the email delivery queue by hard bouncing specific recipients waiting for delivery. Message bouncing follows regular bounce message configuration as specified in the `bounceconfig` command.



Note To perform the `bouncerecipients` function, it is recommended that you place the appliance in an offline state or suspended delivery (see [Suspending Email Receiving and Delivery](#), on page 984).



Note Although the function is supported in all states, certain messages may be delivered while the function is taking place.

Matches to recipient hosts and senders must be identical string matches. Wild cards are not accepted. The `bouncerecipients` command returns the total number of messages bounced.



Note The `bouncerecipients` function is resource-intensive and may take several minutes to complete. If in offline or suspended delivery state, the actual sending of bounce messages (if hard bounce generation is on) will begin only after Cisco AsyncOS is placed back into the online state by using the `resume` command.

Example

```
mail3.example.com> bouncerecipients
Please select how you would like to bounce messages:
1. By recipient host.
2. By Envelope From address.
3. All.
[1]>
```

Recipients to be bounced are identified by either the destination recipient host or the message sender identified by the specific address given in the Envelope From line of the message envelope. Alternately, all messages in the delivery queue can be bounced at once.

Bounce by Recipient Host

```
Please enter the hostname for the messages you wish to bounce.
[]> example.com
Are you sure you want to bounce all messages being delivered to "example.com"? [N]> Y
Bouncing messages, please wait.
100 messages bounced.
```

Bounce by Envelope From Address

```
Please enter the Envelope From address for the messages you wish to bounce.
[]> mailadmin@example.com
Are you sure you want to bounce all messages with the Envelope From address of
"mailadmin@example.com"? [N]> Y
Bouncing messages, please wait.
100 messages bounced.
```

Bounce All

```
Are you sure you want to bounce all messages in the queue? [N]> Y
Bouncing messages, please wait.
1000 messages bounced.
```

Redirecting Messages in Queue

The `redirectrecipients` commands allow you to redirect all messages in the email delivery queue to another relay host. Please note that redirecting recipients to a host or IP address that is not prepared to accept large volumes of SMTP mail from this host will cause messages to bounce and possibly result in the loss of mail.



Caution

Redirecting messages to a receiving domain that has `/dev/null` as its destination results in the loss of messages. The CLI does not display a warning if you redirect mail to such a domain. Check the SMTP route for the receiving domain before redirecting messages.

Example

The following example redirects all mail to the `example2.com` host.

```
mail3.example.com> redirectrecipients
Please enter the hostname or IP address of the machine you want to send all mail to.
```

```
[ ]> example2.com
WARNING: redirecting recipients to a host or IP address that is not prepared to accept large
volumes of SMTP mail from this host will cause messages to bounce and possibly result in
the loss of mail.
Are you sure you want to redirect all mail in the queue to "example2.com"? [N]> y
Redirecting messages, please wait.
246 recipients redirected.
```

Showing Messages Based on Recipient in Queue

Use the `showrecipients` command to show messages from the email delivery queue by recipient host or Envelope From address. You can also show all messages in the queue.

Example

```
mail3.example.com> showrecipients
Please select how you would like to show messages:
1. By recipient host.
2. By Envelope From address.
3. All.
[1]> 3
Showing messages, please wait.
MID/      Bytes/      Sender/      Subject
[RID]     [Atmps]    Recipient
1527      1230       user123456@ironport.com Testing
[0]       [0]        9554@example.com
1522      1230       user123456@ironport.com Testing
[0]       [0]        3059@example.com
1529      1230       user123456@ironport.com Testing
[0]       [0]        7284@example.com
1530      1230       user123456@ironport.com Testing
[0]       [0]        8243@example.com
1532      1230       user123456@ironport.com Testing
[0]       [0]        1820@example.com
1531      1230       user123456@ironport.com Testing
[0]       [0]        9595@example.com
1518      1230       user123456@ironport.com Testing
[0]       [0]        8778@example.com
1535      1230       user123456@ironport.com Testing
[0]       [0]        1703@example.com
1533      1230       user123456@ironport.com Testing
[0]       [0]        3052@example.com
1536      1230       user123456@ironport.com Testing
[0]       [0]        511@example.com
```

The following example shows messages in the queue for all recipient hosts.

Suspending Email Delivery



Caution

It is recommended that you avoid suspending and resuming email delivery on us appliances.

To temporarily suspend email delivery for maintenance or troubleshooting, use the `suspenddel` command. The `suspenddel` command puts Cisco AsyncOS into suspended delivery state. This state is characterized by the following:

- Outbound email delivery is halted.
- Inbound email connections are accepted.
- Log transfers continue.
- The CLI remains accessible.

The `suspenddel` command lets open outbound connections close, and it stops any new connections from opening. The `suspenddel` command commences immediately, and allows any established connections to successfully close. Use the `resumedel` command to return to regular operations from the suspended delivery state.



Note The “delivery suspend” state is preserved across system reboots. If you use the `suspenddel` command and then reboot the appliance, you must resume delivery after the reboot using the `resumedel` command.

Example

```
mail3.example.com> suspenddel
Enter the number of seconds to wait before abruptly closing connections.
[30]>
Waiting for outgoing deliveries to finish...
Mail delivery suspended.
```

Resuming Email Delivery



Caution It is recommended that you avoid suspending and resuming email delivery on Cloud Email Security appliances.

The `resumedel` command returns Cisco AsyncOS to normal operating state after using the `suspenddel` command.

Syntax

```
resumedel
```

```
mail3.example.com> resumedel
Mail delivery resumed.
```

Suspending Receiving Email



Caution It is recommended that you avoid suspending and resuming listeners on Cloud Email Security appliances.

To temporarily suspend all listeners from receiving email, use the `suspendlistener` command. While receiving is suspended, the system does not accept connections to the specific port of the listener.

This behavior has changed in this release of AsyncOS. In previous releases, the system would accept connections, respond with the following responses and disconnect:

- SMTP: 421 *hostname* Service not available, closing transaction channel

- QMQP: ZService not available



Note The “receiving suspend” state is preserved across system reboots. If you use the `suspendlistener` command and then reboot the appliance, you must use the `resumelister` command before the listener will resume receiving messages.

Syntax

```
suspendlistener mail3.example.com> suspendlistener
Choose the listener(s) you wish to suspend.
Separate multiple entries with commas.
1. All
2. InboundMail
3. OutboundMail
[1]> 1
Enter the number of seconds to wait before abruptly closing connections.
[30]>
Waiting for listeners to exit...
Receiving suspended.
mail3.example.com>
```

Resuming Receiving Email



Caution It is recommended that you avoid suspending and resuming listeners on Cloud Email Security appliances.

The `resumelister` command returns Cisco AsyncOS to normal operating state after using the `suspendlistener` command.

Syntax

```
resumelister

mail3.example.com> resumelister
Choose the listener(s) you wish to resume.
Separate multiple entries with commas.
1. All
2. InboundMail
3. OutboundMail
[1]> 1
Receiving resumed.
mail3.example.com>
```

Resuming Delivery and Receiving of Email

The `resume` command resumes both delivery and receiving.

Syntax

```
resume

mail3.example.com> resume
Receiving resumed.
Mail delivery resumed.
mail3.example.com>
```

Scheduling Email for Immediate Delivery

Recipients and hosts that are scheduled for later delivery can be immediately retried by using the `delivernow` command. The `delivernow` command allows you to reschedule email in the queue for immediate delivery. All domains that are marked down and any scheduled or soft bounced messages are queued for immediate delivery.

The `delivernow` command can be invoked for all recipients or specific recipients in the queue (scheduled and active). When selecting specific recipients, you must enter the domain name of the recipients to schedule for immediate delivery. The system matches the entire string for character and length.

Syntax

```
delivernow

mail3.example.com> delivernow
Please choose an option for scheduling immediate delivery.
1. By recipient host
2. All messages
[1]> 1
Please enter the domain to schedule for immediate delivery.
[]> recipient.example.com
Rescheduling all messages to recipient.example.com for immediate delivery.
mail3.example.com>
```

Pausing the Work Queue

**Caution**

It is recommended that you avoid pausing the work queue on Cloud Email Security appliances.

Processing for LDAP recipient access, masquerading, LDAP re-routing, Message Filters, anti-spam, and the anti-virus scanning engine are all performed in the “work queue.” Refer to [Configuring Routing and Delivery Features, on page 671](#) for the processing flow and [Reading the System Gauges, on page 1066](#) for a description of the “Messages in Work Queue” gauge. You can manually pause the work queue portion of message processing using the `workqueue` command.

For example, assume that you wanted to change the configuration of an LDAP server configuration while many messages are in the work queue. Perhaps you want to switch from bouncing to dropping messages based on an LDAP recipient access query. Or perhaps you want to pause the queue while you manually check for the latest anti-virus scanning engine definition files (via the `antivirusupdate` command). The `workqueue` command allows you to pause and resume the work queue to stop processing while you perform other configuration changes.

When you pause and resume the work queue, the event is logged. For example

```
Sun Aug 17 20:01:36 2003 Info: work queue paused, 1900 msgs S
Sun Aug 17 20:01:39 2003 Info: work queue resumed, 1900 msgs
```

In the following example, the work queue is paused:

```
mail3.example.com> workqueue
Status as of: Sun Aug 17 20:02:30 2003 GMT
Status: Operational
Messages: 1243
Choose the operation you want to perform:
- STATUS - Display work queue status
- PAUSE - Pause the work queue
- RATE - Display work queue statistics over time
[]> pause
Manually pause work queue? This will only affect unprocessed messages. [N]> y
Reason for pausing work queue:
[]> checking LDAP server
Status as of: Sun Aug 17 20:04:21 2003 GMT
Status: Paused by admin: checking LDAP server
Messages: 1243
```



Note

Entering a reason is optional. If you do not enter a reason, the system logs the reason as “Manually paused by user .”

In this example, the work queue is resumed:

```
mail3.example.com> workqueue
Status as of: Sun Aug 17 20:42:10 2003 GMT
Status: Paused by admin: checking LDAP server
Messages: 1243
Choose the operation you want to perform:
- STATUS - Display work queue status
- RESUME - Resume the work queue
- RATE - Display work queue statistics over time
[]> resume
Status: Operational
Messages: 1243
```

Locating and Archiving Older Messages

Sometimes older messages remain in the queue because they could not be delivered. You may want to remove and archive these messages. To do this, use the `showmessage` CLI command to display the message for the given message ID. Use the `oldmessage` CLI command to display the oldest non-quarantine message on the system. You can then optionally use the `removemessage` to safely remove the message for the given message ID. This command can only remove messages that are in the work queue, retry queue, or a destination queue. If the message is in none of these queues, it cannot be removed.

You can also use the `archivemessage[mid]` CLI command to archive the message for a given message ID into an mbox file in the configuration directory.

You cannot use the `oldmessage` command to get the message ID for a message in a quarantine. However, if you know the message ID, you can show or archive the specified message. Since the message is not in the

work queue, retry queue, or a destination queue, you cannot remove the message with the `removemessage` command.



Note You cannot perform any of these queue management commands on a message in the Cisco Spam Quarantine.

Syntax

```
archivemessage
```

```
example.com> archivemessage
Enter the MID to archive and remove.
[0]> 47
MID 47 has been saved in file oldmessage_47.mbox in the configuration directory
example.com>
```

Syntax

```
oldmessage
```

```
example.com> oldmessage
MID 9: 1 hour 5 mins 35 secs old
Received: from example.com ([172.16.0.102])
    by example.com with SMTP; 14 Feb 2007 22:11:37 -0800
From: user123@example.com
To: 4031@test.example2.com
Subject: Testing
Message-Id: <20070215061136.68297.16346@example.com>
```

Tracking Messages Within the System

The `findevent` CLI command simplifies the process of tracking messages within the system using the onbox mail log files. The `findevent` CLI command allows you to search through the mail logs for a particular message by searching for a message ID or a regular expression match against the subject header, envelope sender or envelope recipient. You can display results for the current log file, all the log files, or display log files by date. When you view log files by date, you can specify a date or a range of dates.

After you identify the message you want to view logs for, the `findevent` command displays the log information for that message ID including splintering information (split log messages, bounces and system generated messages). The following example shows the `findevent` CLI command tracking the receiving and delivery a message with “confidential” in the subject header:

```
example.com>
findevent
Please choose which type of search you want to perform:
1. Search by envelope FROM
2. Search by Message ID
3. Search by Subject
4. Search by envelope TO
[1]> 3
Enter the regular expression to search for.
[]> confidential
Currently configured logs:
```

```

1. "mail_logs" Type: "IronPort Text Mail Logs" Retrieval: FTP Poll
Enter the number of the log you wish to use for message tracking.
[]> 1
Please choose which set of logs to search:
1. All available log files
2. Select log files by date list
3. Current log file
[3]> 3
The following matching message IDs were found. Please choose one to
show additional log information:
1. MID 4 (Tue Jul 31 17:37:35 2007) sales: confidential
[1]> 1
Tue Jul 31 17:37:32 2007 Info: New SMTP ICID 2 interface Data 1 (172.19.1.86) address
10.251.20.180 reverse dns host unknown verified no
Tue Jul 31 17:37:32 2007 Info: ICID 2 ACCEPT SG None match ALL SBRS None
Tue Jul 31 17:37:35 2007 Info: Start MID 4 ICID 2
Tue Jul 31 17:37:35 2007 Info: MID 4 ICID 2 From: <user@example.com>
Tue Jul 31 17:37:35 2007 Info: MID 4 ICID 2 RID 0 To: <ljohnson@example02.com>
Tue Jul 31 17:37:35 2007 Info: MID 4 Subject 'sales: confidential'
Tue Jul 31 17:37:35 2007 Info: MID 4 ready 4086 bytes from <user@example.com>
Tue Jul 31 17:37:35 2007 Info: MID 4 matched all recipients for per-recipient policy DEFAULT
in the inbound table
Tue Jul 31 17:37:35 2007 Info: ICID 2 close
Tue Jul 31 17:37:37 2007 Info: MID 4 interim verdict using engine: CASE spam negative
Tue Jul 31 17:37:37 2007 Info: MID 4 using engine: CASE spam negative
Tue Jul 31 17:37:37 2007 Info: MID 4 interim AV verdict using Sophos CLEAN
Tue Jul 31 17:37:37 2007 Info: MID 4 antivirus negative
Tue Jul 31 17:37:37 2007 Info: MID 4 queued for delivery
Tue Jul 31 17:37:37 2007 Info: Delivery start DCID 0 MID 4 to RID [0]
Tue Jul 31 17:37:37 2007 Info: Message done DCID 0 MID 4 to RID [0]
Tue Jul 31 17:37:37 2007 Info: MID 4 RID [0] Response '/null'
Tue Jul 31 17:37:37 2007 Info: Message finished MID 4 done

```

Monitoring System Health and Status Using SNMP



Caution

It is recommended that you avoid configuring SNMP on Cloud Email Security appliances

The AsyncOS operating system supports system status monitoring via SNMP (Simple Network Management Protocol). This release implements a read-only subset of MIB-II as defined in RFCs 1213 and 1907. (For more information on SNMP, see RFCs 1065, 1066, and 1067.) Please note:

- SNMP is **off** by default.
- SNMP SET operations (configuration) are not implemented.
- AsyncOS supports SNMPv1, v2, and v3.
- Message authentication and encryption are mandatory when enabling SNMPv3. The encryption algorithm can be AES (recommended) or DES. The authentication algorithm can be SHA-1 (recommended) or MD5. The `snmpconfig` command “remembers” your passphrases the next time you run the command.
- The SNMPv3 username is: `v3get`

```
> snmpwalk -v 3 -l AuthNoPriv -u v3get -a SHA -A ironport mail.example.com
```

- If you use only SNMPv1 or SNMPv2, you must set a community string. The community string does not default to public .
- For SNMPv1 and SNMPv2, you must specify a network from which SNMP GET requests are accepted.

- To use traps, an SNMP manager (not included in AsyncOS) must be running and its IP address entered as the trap target. (You can use a hostname, but if you do, traps will only work if DNS is working.)

Use the `snmpconfig` command to enable and configure SNMP monitoring for the appliance. After you choose and configure values for an interface, the appliance responds to SNMPv3 GET requests. These version 3 requests must include a matching passphrase. By default, version 1 and 2 requests are rejected. If enabled, version 1 and 2 requests must have a matching community string.

MIB Files

The following MIB files for appliances are available from <http://www.cisco.com/c/en/us/support/security/email-security-appliance/tsd-products-support-series-home.html>. Use the latest available MIB files.

- ASYNCOS-MAIL-MIB.txt — an SNMPv2 compatible description of the Enterprise MIB for appliances.
- AsyncOS-SMI.txt (IRONPORT-SMI.txt) — a “Structure of Management Information” (SMI) file that defines the role of the ASYNCOS-MAIL-MIB in Cisco content security products.

Hardware Objects

Hardware sensors conforming to the Intelligent Platform Management Interface Specification (IPMI) report information such as temperature, fan speed, and power supply status.

It is a good idea to poll for the hardware status and identify possible hardware failures before they become critical. Temperatures within 10 per cent of the critical value may be a cause for concern.

For information such as the number of power supplies and the range of operating temperatures for your appliance, see the hardware guide for your model. For the location of hardware guides, see [Documentation](#), on page 6.

Hardware Traps

Status change traps are sent when the status changes. Fan Failure and high temperature traps are sent every 5 seconds. The other traps are failure condition alarm traps — they are sent once when the state changes (healthy to failure).

For example, on C170 appliances, traps are sent if the following thresholds are reached:

Table 116: Hardware Traps on C170 Appliances : Temperature and Hardware Conditions

| Model | High Temp (CPU) | High Temp (Ambient) | High Temp (Backplane) | High Temp (Riser) | Fan Failure | Power Supply | RAID | Link |
|-------|-----------------|---------------------|-----------------------|-------------------|-------------|---------------|---------------|---------------|
| C170 | 90C | 47C | NA | NA | 0 RPMs | Status Change | Status Change | Status Change |

To see the available traps and threshold values on your appliance, run the `snmpconfig` command from the command-line interface.

Note that failure condition alarm traps represent a critical failure of the individual component, but may not cause a total system failure. For example, a single fan or power supply can fail on an appliance with multiple fans or power supplies and the appliance will continue to operate.

Related Topics

- [Example: snmpconfig Command](#) , on page 1090

SNMP Traps

SNMP provides the ability to send traps, or notifications, to advise an administration application (an SNMP management console, typically) when one or more conditions have been met. Traps are network packets that contain data relating to a component of the system sending the trap. Traps are generated when a condition has been met on the SNMP agent (in this case, the appliance). After the condition has been met, the SNMP agent then forms an SNMP packet and sends it to the host running the SNMP management console software.

To enable and configure SNMP traps, use the `snmpconfig` command.

To specify multiple trap targets: when prompted for the trap target, you may enter up to 10 comma separated IP addresses.

Example: snmpconfig Command

In the following example, the `snmpconfig` command is used on a C690 hardware appliance to enable SNMP on the “PublicNet” interface on port 161. The community string `public` is entered for GET requests from versions 1 and 2.

```
mail.example.com> snmpconfig

Current SNMP settings:
SNMP Disabled.

Choose the operation you want to perform:
- SETUP - Configure SNMP.
[1]> SETUP

Do you want to enable SNMP?
[Y]>

Please choose an IP interface for SNMP requests.
1. Management (198.51.100.1: esa.example.com)
[1]>

Which port shall the SNMP daemon listen on interface "Management"?
[161]>

Please select SNMPv3 authentication type:
1. MD5
2. SHA
[1]> 2

Please select SNMPv3 privacy protocol:
1. DES
2. AES
[1]> 2

Enter the SNMPv3 authentication passphrase.
[]>

Please enter the SNMPv3 authentication passphrase again to confirm.
[]>

Enter the SNMPv3 privacy passphrase.
```



```
[ ]>
```

```
Please enter the SNMPv3 privacy passphrase again to confirm.
```

```
[ ]>
```

```
Service SNMP V1/V2c requests?
```

```
[N]> y
```

```
Enter the SNMP V1/V2c community string.
```

```
[ironport]> public
```

```
Shall SNMP V2c requests be serviced from IPv4 addresses?
```

```
[Y]>
```

```
From which IPv4 networks shall SNMP V1/V2c requests be allowed? Separate multiple networks with commas.
```

```
[127.0.0.1/32]>
```

```
Enter the Trap target as a host name, IP address or list of IP addresses separated by commas (IP address preferred). Enter "None" to disable traps.
```

```
[127.0.0.1]> 203.0.113.1
```

```
Enter the Trap Community string.
```

```
[ironport]> tcomm
```

```
Enterprise Trap Status
```

| | |
|-------------------------------|----------|
| 1. CPUUtilizationExceeded | Disabled |
| 2. FIPSMODEDisableFailure | Enabled |
| 3. FIPSMODEEnableFailure | Enabled |
| 4. FailoverHealthy | Enabled |
| 5. FailoverUnhealthy | Enabled |
| 6. RAIDStatusChange | Enabled |
| 7. connectivityFailure | Disabled |
| 8. fanFailure | Enabled |
| 9. highTemperature | Enabled |
| 10. keyExpiration | Enabled |
| 11. linkUpDown | Enabled |
| 12. memoryUtilizationExceeded | Disabled |
| 13. powerSupplyStatusChange | Enabled |
| 14. resourceConservationMode | Enabled |
| 15. updateFailure | Enabled |

```
Do you want to change any of these settings?
```

```
[N]> y
```

```
Do you want to disable any of these traps?
```

```
[Y]> n
```

```
Do you want to enable any of these traps?
```

```
[Y]> y
```

```
Enter number or numbers of traps to enable. Separate multiple numbers with commas.
```

```
[ ]> 1,7,12
```

```
What threshold would you like to set for CPU utilization?
```

```
[95]>
```

```
What URL would you like to check for connectivity failure?
```

```
[http://downloads.ironport.com]>
```

```
What threshold would you like to set for memory utilization?
```

```
[95]>
```

Example: snmpconfig Command

```
Enter the System Location string.
[Unknown: Not Yet Configured]> Network Operations Center - west; rack #30, position 3

Enter the System Contact string.
[snmp@localhost]> mail-admin@example.com

Current SNMP settings:
Listening on interface "Management" 198.51.100.1 port 161.
SNMP v3: Enabled.
SNMP v1/v2: Enabled, accepting requests from subnet 127.0.0.1/32 .
SNMP v1/v2 Community String: public
Trap target: 203.0.113.1
Location: Network Operations Center - west; rack #30, position 3
System Contact: esa-admin@example.com

Choose the operation you want to perform:
- SETUP - Configure SNMP.
[ ]>

mail.example.com> commit

Please enter some comments describing your changes:
[ ]> Enable and configure SNMP

Changes committed: Fri Nov 06 18:13:16 2015 GMT
esa.example.com>
```



CHAPTER 40

Improving Phishing Detection Efficacy using Service Logs

This chapter contains the following sections:

- [Overview, on page 1093](#)
- [Enabling Service Logs on Appliance , on page 1093](#)
- [Disabling Service Logs on Appliance , on page 1094](#)
- [Frequently Asked Questions, on page 1094](#)

Overview

The Service Logs are used to collect personal data based on the [Cisco Email Security Appliance Data Sheet](#) guidelines.

The Service Logs are sent to the Cisco Talos Cloud service to improve Phishing detection.



Note From AsyncOS 13.5 onwards, Service Logs replaces senderbase as the telemetry data that is sent to Cisco Talos Cloud service.

The email gateway collects limited personal data from customer emails and offers extensive useful threat detection capabilities that can be coupled with dedicated analysis systems to collect, trend, and correlate observed threat activity. Cisco uses the personal data to improve your email gateway capabilities to analyze the threat landscape, provide threat classification solutions on malicious emails, and to protect your email gateway from new threats such as spam, virus, and directory harvest attacks.

Enabling Service Logs on Appliance

Procedure

- Step 1** Go to **Security Services > Service Logs**.
- Step 2** Click **Edit Global Settings**.

Step 3 Check the **Enable sharing limited data with the Service Logs Information Service (Recommended)** check box.

Checking this box enables the feature globally for the appliance . When enabled, the Context Adaptive Scanning Engine (CASE) is used to collect and report the data (regardless of whether or not Cisco anti-spam scanning is enabled). You can configure the same settings using the `servicelogsconfig` command in the CLI

Step 4 Click **Submit** and commit your changes.

Disabling Service Logs on Appliance

Procedure

Step 1 Go to **Security Services > Service Logs**.

Step 2 Click **Disable** and commit your changes.

Frequently Asked Questions

Cisco recognizes that privacy is important to you, so we design and operate our services with the protection of your privacy in mind. If you enroll to Cisco Talos Cloud service, Cisco will collect aggregated statistics about your organization’s email traffic; however, we do not collect or use any personally identifiable information. Any information Cisco collects that would identify your users or your organization will be treated as confidential.

What data do I share?

The data is summarized information on message attributes and information on how different types of messages were handled by appliances . We do not collect the full body of the message. Again, information provided to Cisco that would identify your users or your organization will be treated as confidential. (See [What does Cisco do to make sure that the data I share is secure?](#), on page 1095 below).

The following tables explain a sample log entry in a “human-friendly” format.

Table 117: Statistics Shared per Email Message Information

| Item | Sample Data |
|---|------------------------------|
| GUID for the inbound SMTP connection | 0FyIkNX8ThST1
/IdfyNshg== |
| GUID for the email message | 1Hss77LIS6u7y5
GDn0QFEQ== |
| Email Security Appliance message ID | 5191655 |
| Number of recipients and their validity | 1 |

| Item | Sample Data |
|--|--|
| Scanner verdicts from non-Cisco Talos engines (for example, Anti-Virus or Advanced Malware Protection) | 4 |
| Message disposition | MSG_DISP_DROPPED |
| Message disposition reason | MSG_DISP_FILTER |
| Is the message for outbound delivery? | true |
| Message size | 35100 |
| Incoming mail relay | true |
| Mail flow direction | IP_DIR_OUT |
| AMP verdict information | file_sha2_256:
"\217\263\037\004\374`N
\3264\265\016\314\227\005E\337\373q
\177A\245 \017\004\204\340\231\260!^ |
| Sampling of dropped messages | true |

Table 118: Statistics Shared per Periodic Configuration Information

| Item | Sample Data |
|---|----------------|
| Outbreak Filters feature enabled | true |
| Sender Domain Reputation (SDR) disabled flag | true |
| Context Adaptive Scanning Engine (CASE) version | 3.8.5-036 |
| Talos engine | 1.95.0.220 |
| Generic list of enabled features | Sophos_enabled |

What does Cisco do to make sure that the data I share is secure?

If you agree to enroll to Cisco Talos Cloud service:

- Data sent from your appliances will be sent to the Cisco Talos Cloud service using the secure gRPC/HTTP2 protocol.
- All customer data will be handled with care at Cisco. This data will be stored in a secure location and access to the data will be limited to employees and contractors at Cisco who require access in order to improve the company's email security products and services or provide customer support.
- No information identifying email recipients or the customer's company will be shared outside of Cisco Systems when reports or statistics are generated based on the data.

Will sharing data impact the performance of my Cisco appliances ?

Cisco believes that there will be a minimal performance impact for most customers. We record data that already exists as part of the mail delivery process. Customer data is then aggregated on the appliance and sent to Cisco Talos Cloud service. We anticipate that the total size of data transferred via HTTPS will be less than 1% of the bandwidth of a typical company's email traffic.

When enabled, the Context Adaptive Scanning Engine (CASE) is used to collect and report the data (regardless of whether or not Cisco anti-spam scanning is enabled).

If you have additional questions, please contact Cisco Customer Support. See [Cisco Support Community](#), on page 8.

Are there other ways I can share data?

For customers wanting to do even more to help Cisco provide top quality security services, there is a command that allows you to share additional data. This higher level of data sharing will also provide attachment filenames in clear, unhashed text, as well as hostnames of URLs in messages. If you are interested in learning more about this feature, please talk to your Systems Engineer or contact Cisco Customer Support.



CHAPTER 41

Other Tasks in the GUI

This chapter contains the following sections:

- [The Graphical User Interface \(GUI\), on page 1097](#)
- [System Information in the GUI , on page 1098](#)
- [Gathering XML status from the GUI, on page 1098](#)

The Graphical User Interface (GUI)

The graphical user interface (GUI) is the web-based alternative to some command line interface (CLI) commands for system monitoring and configuration. The GUI enables you to monitor the system using a simple Web-based interface without having to learn the AsyncOS command syntax. After HTTP and/or HTTPS services have been enabled for an interface, you can access the GUI and log in. See the “Accessing the Appliance ” chapter for more information.

Enabling the GUI on an Interface

By default, the system ships with HTTP enabled on the Management interface.

To enable the GUI, execute the `interfaceconfig` command at the command-line interface, edit the interface that you want to connect to, and then enable the HTTP services or secure HTTP services, or both.



Note You can also use the Network > IP Interfaces page to enable or disable the GUI on an interface, once you have the GUI enabled on any other interface. See [IP Interfaces, on page 1261](#) for more information.



Note Enabling secure HTTP on an interface requires you to install a certificate. For more information, see “Enabling a Certificate for HTTPS.”

For either service, you specify the port on which you want the service to be enabled. By default, HTTP is enabled on port 80 and HTTPS on port 443. If you enable both services for an interface, you can automatically redirect HTTP requests to the secure service.

In addition, all users (see [Working with User Accounts, on page 949](#)) who attempt to access the GUI on this interface (either via HTTP or HTTPS) must authenticate themselves via a standard username and passphrase login page.



Note You must save the changes by using the commit command before you are able to access the GUI.

In the following example, the GUI is enabled for the Data 1 interface. The interfaceconfig command is used to enable HTTP on port 80 and HTTPS on port 443. (The demonstration certificate is temporarily used for HTTP until the certconfig command can be run. For more information, see “Installing Certificates on the Appliance.”) HTTP requests to port 80 are configured to be automatically redirected to port 443 for the Data1 interface.

System Information in the GUI

- On the **System Overview** page, you can:
 - View historical graphs and tables showing some of the key system status and performance information.
 - View the version of the AsyncOS operating system installed on the appliance .
 - View a subset of key statistics.
- The **System Status** page provides a detailed representation of all real-time mail and DNS activity for the system. You can also reset the counters for system statistics and view the last time the counters were reset.

Gathering XML status from the GUI

View status through XML pages, or access XML status information programmatically.

The XML Status feature provides a programmatic method to access email monitoring statistics. Note that some newer browsers can also render XML data directly.

Information from the pages in the GUI in this table is also available as dynamic XML output by accessing the corresponding URL:

| GUI Page Name | Corresponding XML status URL |
|---------------------------------------|---|
| Mail Status | http:// <i>hostname</i> /xml/status |
| Host Mail Status for a Specified Host | http:// <i>hostname</i> /xml/hoststatus?hostname= <i>host</i> |
| DNS Status | http:// <i>hostname</i> /xml/dnsstatus |
| Top Incoming Domains | http:// <i>hostname</i> /xml/topin |
| Top Outgoing Domains ¹ | http:// <i>hostname</i> /xml/tophosts |

¹ The default sort order for this page is by number of active recipients. You can change the order by appending “?sort= order ” to the URL, where order is conn_out , deliv_recip , soft_bounced , or hard_bounced .



CHAPTER 42

Advanced Network Configuration

This chapter contains the following sections:

- [Media Settings on Ethernet Interfaces, on page 1099](#)
- [Network Interface Card Pairing/Teaming, on page 1100](#)
- [Virtual Local Area Networks \(VLANs\), on page 1103](#)
- [Direct Server Return, on page 1107](#)
- [Ethernet Interface's Maximum Transmission Unit, on page 1111](#)
- [Accept or Reject ARP Replies with a Multicast Address, on page 1112](#)

Media Settings on Ethernet Interfaces

Media settings for the ethernet interfaces can be accessed via the use of the etherconfig command. Each ethernet interface is listed with its current setting. By selecting the interface, the possible media settings are displayed. See [Example of Editing Media Settings, on page 1099](#) for an example.

Using etherconfig to Edit Media Settings on Ethernet Interfaces

The etherconfig command can be used to set the duplex settings (full/half) as well as the speed (10/100/1000 Mbps) of ethernet interfaces. By default, interfaces automatically select the media settings; however, in some cases you may wish to override this setting.



Note If you have completed the GUI's System Setup Wizard (or the Command Line Interface systemsetup command) as described in the "Setup and Installation" chapter and committed the changes, the default ethernet interface settings should already be configured on your appliance .

Some appliances contain a fiber optic network interface option. If available, you will see two additional ethernet interfaces (Data 3 and Data 4) in the list of available interfaces on these appliances . These gigabit fiber optic interfaces can be paired with the copper (Data 1, Data 2, and Management) interfaces in a heterogeneous configuration. See [Network Interface Card Pairing/Teaming, on page 1100](#).

Example of Editing Media Settings

```
mail3.example.com> etherconfig
```

```

Choose the operation you want to perform:
- MEDIA - View and edit ethernet media settings.
- PAIRING - View and configure NIC Pairing.
- VLAN - View and configure VLANs.
- LOOPBACK - View and configure Loopback.
- MTU - View and configure MTU.
- MULTICAST - Accept or reject ARP replies with a multicast address.

[ ]> media
Ethernet interfaces:
1. Data 1 (Autoselect: <100baseTX full-duplex>) 00:06:5b:f3:ba:6d
2. Data 2 (Autoselect: <100baseTX full-duplex>) 00:06:5b:f3:ba:6e
3. Management (Autoselect: <100baseTX full-duplex>) 00:02:b3:c7:a2:da

Choose the operation you want to perform:
- EDIT - Edit an ethernet interface.
[ ]> edit
Enter the name or number of the ethernet interface you wish to edit.
[ ]> 2
Please choose the Ethernet media options for the Data 2 interface.
1. Autoselect
2. 10baseT/UTP half-duplex
3. 10baseT/UTP full-duplex
4. 100baseTX half-duplex

5. 100baseTX full-duplex

6. 1000baseTX half-duplex
7. 1000baseTX full-duplex
[1 ]> 5
Ethernet interfaces:
1. Data 1 (Autoselect: <100baseTX full-duplex>) 00:06:5b:f3:ba:6d
2. Data 2 (100baseTX full-duplex: <100baseTX full-duplex>) 00:06:5b:f3:ba:6e
3. Management (Autoselect: <100baseTX full-duplex>) 00:02:b3:c7:a2:da
Choose the operation you want to perform:
- EDIT - Edit an ethernet interface.
[ ]>
Choose the operation you want to perform:
- MEDIA - View and edit ethernet media settings.
- PAIRING - View and configure NIC Pairing.
- VLAN - View and configure VLANs.
- LOOPBACK - View and configure Loopback.
- MTU - View and configure MTU.
- MULTICAST - Accept or reject ARP replies with a multicast address.
[ ]>

```

Network Interface Card Pairing/Teaming

NIC pairing allows you to combine any two physical data ports in order to provide a backup Ethernet interface if the data path from the NIC to the upstream Ethernet port should fail. Basically, pairing configures the Ethernet interfaces so that there is a primary interface and a backup interface. If the primary interface fails (i.e. if the carrier between the NIC and the upstream node is disrupted), the backup interface becomes active and an alert is sent. When the primary interface is up again, this interface will become active automatically. Within the documentation for this product, NIC pairing is synonymous with NIC teaming.



Note NIC pairing is not available on C170, C190 and C195 appliances .

You can create more than one NIC pair, providing you have enough data ports. When creating pairs, you can combine any two data ports. For example:

Data 1 and Data 2

Data 3 and Data 4

Data 2 and Data 3

etc.

Some appliances contain a fiber optic network interface option. If available, you will see two additional ethernet interfaces (Data 3 and Data 4) in the list of available interfaces on these appliances . These gigabit fiber optic interfaces can be paired with the copper (Data 1, Data 2, and Management) interfaces in a heterogeneous configuration.

NIC Pairing and VLANs

VLANs (see [Virtual Local Area Networks \(VLANs\), on page 1103](#)) are only allowed on the primary interface.

NIC Pair Naming

When creating NIC pairs, you must specify a name to use to refer to the pair. NIC pairs created in versions of AsyncOS prior to version 4.5 will automatically receive the default name of 'Pair 1' following an upgrade.

Any alerts generated regarding NIC pairing will reference the specific NIC pair by name.

NIC Pairing and Existing Listeners

If you enable NIC pairing on an interface that has listeners assigned to it, you are prompted to either delete, reassign, or disable all listeners assigned to the backup interface.

Enabling NIC Pairing via the etherconfig Command



Note NIC pairing is not available on C170, C190 and C195 appliances .

```
mail3.example.com> etherconfig
```

Choose the operation you want to perform:

- MEDIA - View and edit ethernet media settings.
- PAIRING - View and configure NIC Pairing.
- VLAN - View and configure VLANs.
- LOOPBACK - View and configure Loopback.

```
- MTU - View and configure MTU.
- MULTICAST - Accept or reject ARP replies with a multicast address.

[]> pairing

Paired interfaces:

Choose the operation you want to perform:

- NEW - Create a new pairing.

[]> new

Please enter a name for this pair (Ex: "Pair 1"):

[]> Pair 1

Warning: The backup (Data 2) for the NIC Pair is currently configured with one or more
IP addresses. If you continue, the Data 2 interface will be deleted.

Do you want to continue? [N]> y

The interface you are deleting is currently used by listener "OutgoingMail".

What would you like to do?

1. Delete: Remove the listener and all its settings.
2. Change: Choose a new interface.
3. Ignore: Leave the listener configured for interface "Data 2" (the listener will be
disabled until you add a new interface named "Data 2" or edit the listener's settings).

[1]>

Listener OutgoingMail deleted for mail3.example.com.

Interface Data 2 deleted.

Paired interfaces:

1. Pair 1:

Primary (Data 1) Active, Link is up
Backup (Data 2) Standby, Link is up

Choose the operation you want to perform:

- DELETE - Delete a pairing.
- STATUS - Refresh status.

[]>
```

Virtual Local Area Networks (VLANs)

You can configure multiple virtual local area networks (VLANs) on any physical network port on the appliance .

You can use VLANs to:

- Increase the number of networks the appliance can connect to beyond the number of physical interfaces on the appliance .
- Allow more networks to be defined on separate “ports” on existing listeners.
- Segment networks for security purposes, to ease administration, or increase bandwidth.

Example use case:

Two mail servers that are unable to communicate directly due to VLAN limitations can send mail through the appliance . The Data 2 interface on the appliance is configured with VLAN1 and VLAN2. The blue line shows mail coming from the sales network (VLAN1) to the appliance. The appliance processes the mail as normal and then, upon delivery, tags the packets with the destination VLAN2 information (red line).

Using VLANs to Facilitate Communication Between Appliances

Figure 76: Using VLANs to Facilitate Communication Between Appliances

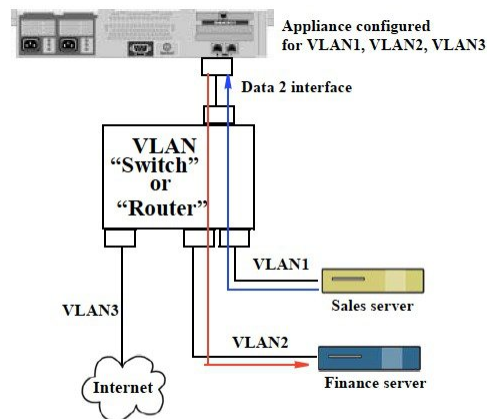

About Configuring VLANs

You can configure multiple VLANs on any physical network port on the appliance , including “Data” and “Management” ports and the fiber optic data ports available on some appliance models. AsyncOS supports up to 30 VLANs.

A physical port does not need an IP address configured in order to be in a VLAN. The physical port on which a VLAN is created can have an IP that will receive non-VLAN traffic, so you can have both VLAN and non-VLAN traffic on the same interface.

VLANs can be used with NIC pairing (available on paired NICs) and with Direct Server Return (DSR).

VLANs appear as dynamic “Data Ports” labeled in the format of: “VLAN DDDD” where the “DDDD” is the ID and is an integer up to 4 digits long (VLAN 2, or VLAN 4094 for example). VLAN IDs must be unique on your appliance.

Related Topics

[FTP, SSH, and SCP Access, on page 1261](#)

Managing VLANs

You can create, edit and delete VLANs via the etherconfig command. Once created, a VLAN can be configured via the Network > Interfaces page or the interfaceconfig command in the CLI. Remember to commit all changes.

Creating a New VLAN via the etherconfig Command

In this example, two VLANs are created (named VLAN 31 and VLAN 34) on the Data 1 port:

```
mail3.example.com> etherconfig
```

```
Choose the operation you want to perform:
```

- MEDIA - View and edit ethernet media settings.
- PAIRING - View and configure NIC Pairing.
- VLAN - View and configure VLANs.
- LOOPBACK - View and configure Loopback.
- MTU - View and configure MTU.
- MULTICAST - Accept or reject ARP replies with a multicast address.

```
[> vlan
```

```
VLAN interfaces:
```

```
Choose the operation you want to perform:
```

- NEW - Create a new VLAN.

```
[> new
```

```
VLAN ID for the interface (Ex: "34"):
```

```
[> 34
```

```
Enter the name or number of the ethernet interface you wish bind to:
```

1. Data 1
2. Data 2
3. Management

```
[1]> 1
```

```
VLAN interfaces:
```

1. VLAN 34 (Data 1)

```
Choose the operation you want to perform:
```

```
- NEW - Create a new VLAN.
- EDIT - Edit a VLAN.
- DELETE - Delete a VLAN.

[ ]> new
VLAN ID for the interface (Ex: "34"):

[ ]> 31
Enter the name or number of the ethernet interface you wish bind to:

1. Data 1
2. Data 2
3. Management

[1]> 1
VLAN interfaces:

1. VLAN 31 (Data 1)
2. VLAN 34 (Data 1)

Choose the operation you want to perform:

- NEW - Create a new VLAN.
- EDIT - Edit a VLAN.
- DELETE - Delete a VLAN.

[ ]>

Choose the operation you want to perform:

- MEDIA - View and edit ethernet media settings.
- PAIRING - View and configure NIC Pairing.
- VLAN - View and configure VLANs.
- LOOPBACK - View and configure Loopback.
- MTU - View and configure MTU.
- MULTICAST - Accept or reject ARP replies with a multicast address.

[ ]>
```

Creating an IP Interface on a VLAN via the interfaceconfig Command

In this example, a new IP interface is created on the VLAN 31 ethernet interface. Making changes to an interface may close your connection to the appliance .

```
mail3.example.com> interfaceconfig

Currently configured interfaces:

1. Data 1 (10.10.1.10/24: example.com)
2. Management (10.10.0.10/24: example.com)

Choose the operation you want to perform:

- NEW - Create a new interface.
- EDIT - Modify an interface.
- GROUPS - Define interface groups.
- DELETE - Remove an interface.

[ ]> new

Please enter a name for this IP interface (Ex: "InternalNet"):

[ ]> InternalVLAN31

Would you like to configure an IPv4 address for this interface (y/n)? [Y]>

IPv4 Address (Ex: 10.10.10.10):

[ ]> 10.10.31.10

Netmask (Ex: "255.255.255.0" or "0xffffffff00"):

[255.255.255.0]>

Would you like to configure an IPv6 address for this interface (y/n)? [N]>

Ethernet interface:

1. Data 1
2. Data 2
3. Management
4. VLAN 31
5. VLAN 34

[1]> 4

Hostname:

[ ]> mail31.example.com

Do you want to enable SSH on this interface? [N]>

Do you want to enable FTP on this interface? [N]>

Do you want to enable HTTP on this interface? [N]>

Do you want to enable HTTPS on this interface? [N]>
```



```
Currently configured interfaces:

1. Data 1 (10.10.1.10/24: example.com)

2. InternalVLAN31 (10.10.31.10/24: mail31.example.com)

3. Management (10.10.0.10/24: example.com)

Choose the operation you want to perform:

- NEW - Create a new interface.

- EDIT - Modify an interface.

- GROUPS - Define interface groups.

- DELETE - Remove an interface.

[ ]>
```

Configuring VLANs Using the Web Interface

After a VLAN is created using the etherconfig command, you can configure it using the Network > Listeners page.

Direct Server Return

Direct Server Return (DSR) is a way of providing support for a light-weight load balancing mechanism to load balance between multiple appliances sharing the same Virtual IP (VIP).

DSR is implemented via an IP interface created on the “loopback” ethernet interface on the appliance .



Note Configuring load balancing for appliances is beyond the scope of this document

Enabling Direct Server Return

Enable DSR by enabling the “loopback” ethernet interface on each participating appliance . Next, create an IP interface on the loopback interface with a virtual IP (VIP) via the **interfaceconfig** command in the CLI or via the Network > Interfaces page in the GUI. Finally, create a listener on the new IP interface via the **listenerconfig** command in the CLI or via the Network > Listeners page in the GUI. Remember to commit all changes.



Note Using the loopback interface prevents the appliance from issuing ARP replies for that specific interface

When enabling DSR, the following rules apply:

All systems use the same Virtual IP (VIP) address

All systems must be on the same switch and subnet as the load balancer

Figure 77: Using DSR to Load Balance Between Multiple Appliances on a Switch

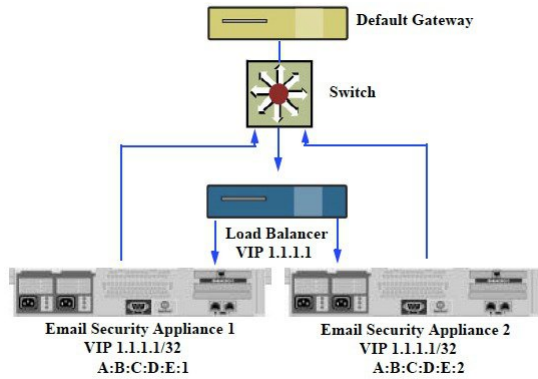

Using DSR to Load Balance Between Multiple Appliances on a Switch

Enabling the Loopback Interface via the etherconfig Command

Once enabled, the loopback interface is treated like any other interface (e.g. Data 1):

```
mail3.example.com> etherconfig
```

Choose the operation you want to perform:

- MEDIA - View and edit ethernet media settings.
- PAIRING - View and configure NIC Pairing.
- VLAN - View and configure VLANs.
- LOOPBACK - View and configure Loopback.
- MTU - View and configure MTU.
- MULTICAST - Accept or reject ARP replies with a multicast address.

```
[> loopback
```

Currently configured loopback interface:

Choose the operation you want to perform:

- ENABLE - Enable Loopback Interface.

```
[> enable
```

Currently configured loopback interface:

```
1. Loopback
```

Choose the operation you want to perform:

- DISABLE - Disable Loopback Interface.

```
[>
```

Choose the operation you want to perform:

```
- MEDIA - View and edit ethernet media settings.
- PAIRING - View and configure NIC Pairing.
- VLAN - View and configure VLANs.
- LOOPBACK - View and configure Loopback.
- MTU - View and configure MTU.
- MULTICAST - Accept or reject ARP replies with a multicast address.

[]>
```

Creating an IP Interface on Loopback via the interfaceconfig Command

Create an IP interface on the loopback interface:

```
mail3.example.com> interfaceconfig
Currently configured interfaces:
1. Data 1 (10.10.1.10/24: example.com)
2. InternalV1 (10.10.31.10/24: mail31.example.com)
3. Management (10.10.0.10/24: example.com)
Choose the operation you want to perform:
- NEW - Create a new interface.
- EDIT - Modify an interface.
- GROUPS - Define interface groups.
- DELETE - Remove an interface.

[]> new
Please enter a name for this IP interface (Ex: "InternalNet"):

[]> LoopVIP
Would you like to configure an IPv4 address for this interface (y/n)? [Y]>
IPv4 Address (Ex: 10.10.10.10):

[]> 10.10.1.11
Netmask (Ex: "255.255.255.0" or "0xffffffff00"):

[255.255.255.0]> 255.255.255.255
Would you like to configure an IPv6 address for this interface (y/n)? [N]>
Ethernet interface:
1. Data 1
2. Data 2
```

```
3. Loopback
4. Management
5. VLAN 31
6. VLAN 34
[1]> 3
Hostname:
[]> example.com
Do you want to enable SSH on this interface? [N]>
Do you want to enable FTP on this interface? [N]>
Do you want to enable HTTP on this interface? [N]>
Do you want to enable HTTPS on this interface? [N]>
Currently configured interfaces:
1. Data 1 (10.10.1.10/24: example.com)
2. InternalV1 (10.10.31.10/24: mail31.example.com)
3. LoopVIP (10.10.1.11/24: example.com)
4. Management (10.10.0.10/24: example.com)
Choose the operation you want to perform:
- NEW - Create a new interface.
- EDIT - Modify an interface.
- GROUPS - Define interface groups.
- DELETE - Remove an interface.
[]>
```

Creating a Listener on the New IP Interface

Create a listener on the new IP interface via the GUI or the CLI. For example, the following figure shows the newly created IP interface available in the Add Listener page in the GUI.

Figure 78: Creating a Listener on the New Loopback IP Interface

Add Listener

| Listener Settings | |
|---------------------------------|---|
| Name: | <input type="text"/> |
| Type of Listener: | <input checked="" type="radio"/> Public
<input type="radio"/> Private |
| Interface: | Data 1 (10.10.1.10/24; example.com) TCP Port: 25 |
| Bounce Profile: | Data 1 (10.10.1.10/24; example.com)
InternalV1 (10.10.31.10/24; mail31.example.com) |
| Disclaimer Above: | LoopVIP (10.10.11.10/24; mail11.example.com)
Management (10.10.2.10/24; example.com)
<small>Disclaimer text will be applied above the message body.</small> |
| Disclaimer Below: | None
<small>Disclaimer text will be applied below the message body.</small> |
| SMTP Authentication Profile: | None |
| Certificate: | System Default |
| ▶ SMTP Address Parsing Options: | Optional settings for controlling parsing in SMTP "MAIL FROM" and "RCPT TO" |
| ▶ Advanced: | Optional settings for customizing the behavior of the Listener |
| ▶ LDAP Queries: | No LDAP Server Profiles have been created. Profiles can be defined at System Administration > LDAP |
| SMTP Call-Ahead Profile: | None |

Cancel Submit

Ethernet Interface's Maximum Transmission Unit

The maximum transmission unit (MTU) is the largest unit of data that an ethernet interface will accept. You can decrease the MTU for an ethernet interface using the etherconfig command. The default MTU size is 1500 bytes, which is the largest MTU that the ethernet interface can accept.

To edit an interface's MTU:

```
mail3.example.com> etherconfig
```

Choose the operation you want to perform:

- MEDIA - View and edit ethernet media settings.
- PAIRING - View and configure NIC Pairing.
- VLAN - View and configure VLANs.
- LOOPBACK - View and configure Loopback.
- MTU - View and configure MTU.
- MULTICAST - Accept or reject ARP replies with a multicast address.

```
[ ]> mtu
```

Ethernet interfaces:

1. Data 1 mtu 1400
2. Data 2 default mtu 1500
3. Management default mtu 1500

Choose the operation you want to perform:

```

- EDIT - Edit an ethernet interface.

[]> edit

Enter the name or number of the ethernet interface you wish to edit.

[]> 2

Please enter a non-default (1500) MTU value for the Data 2 interface.

[]> 1200

Ethernet interfaces:

1. Data 1 mtu 1400

2. Data 2 mtu 1200

3. Management default mtu 1500

Choose the operation you want to perform:

- EDIT - Edit an ethernet interface.

[]>

```

Accept or Reject ARP Replies with a Multicast Address

You can now specify whether to accept or reject ARP replies with a multicast address. Use the MULTICAST subcommand to configure this functionality.

The following example shows how to configure your appliance to accept ARP replies with a multicast address:

```

mail.example.com> etherconfig
Choose the operation you want to perform:
- MEDIA - View and edit ethernet media settings.
- VLAN - View and configure VLANs.
- LOOPBACK - View and configure Loopback.
- MTU - View and configure MTU.
- MULTICAST - Accept or reject ARP replies with a multicast address.
[]> multicast
ARP replies with a multicast address will be rejected.
Choose the operation you want to perform:
- ACCEPT - Accept ARP replies with a multicast address.
[]> accept
ARP replies with a multicast address will be accepted.

```



CHAPTER 43

Logging

This chapter contains the following sections:

- [Overview, on page 1113](#)
- [Log Types, on page 1122](#)
- [Log Subscriptions, on page 1171](#)

Overview

- [Understanding Log Files and Log Subscriptions, on page 1113](#)
- [Log Types, on page 1113](#)
- [Log Retrieval Methods, on page 1120](#)

Understanding Log Files and Log Subscriptions

Logs are a compact, efficient method of gathering critical information about the email operations of AsyncOS. These logs record information regarding activity on your appliance. The information will vary depending upon the log you view, for example, Bounce logs or Delivery logs.

Most logs are recorded in plain text (ASCII) format; however, delivery logs are formatted in binary for resource efficiency. The ASCII text information is readable in any text editor.

Cisco offers the M-Series Content Security Management appliance for centralized reporting and tracking tool for logs from multiple appliances. See your Cisco representative for more information.

A log subscription associates a log type with a name, logging level, and other constraints such as size and destination information; multiple subscriptions for the same log type are permitted.

Log Types

The log type indicates what information will be recorded within the generated log such as message data, system statistics, binary or textual data. You select the log type when creating a log subscription. See [Log Subscriptions, on page 1171](#) for more information.

AsyncOS generates the following log types:

Table 119: Log Types

| Log | Description |
|------------------------|--|
| Text Mail Logs | Text mail logs record information regarding the operations of the email system. For example, message receiving, message delivery attempts, open and closed connections, bounces, TLS connections, and others. |
| qmail Format Mail Logs | qmail format delivery logs record the same information regarding the operations of the email system as delivery logs following, but stored in qmail format. |
| Delivery Logs | Delivery logs record critical information about the email delivery operations of the appliance — for example, information regarding each recipient delivery and bounce at the time of the delivery attempt. The log messages are “stateless,” meaning that all associated information is recorded in each log message and users need not reference previous log messages for information about the current delivery attempt. Delivery logs are recorded in a binary format for resource efficiency. Delivery Log files must be post-processed using a provided utility to convert them to XML or CSV (comma-separated values) format. The conversion tools are located at: https://supportforums.cisco.com/document/33721/cisco-ironport-systems-contributed-tools |
| Bounce Logs | Bounce logs record information about bounced recipients. The information recorded for each bounced recipient includes: the message ID, the recipient ID, the Envelope From address, the Envelope To address, the reason for the recipient bounce, and the response code from the recipient host. In addition, you can choose to log a fixed amount of each bounced recipient message. This amount is defined in bytes and the default is zero. |
| Status Logs | This log file records system statistics found in the CLI status commands, including status detail and dnsstatus . The period of recording is set using the setup subcommand in logconfig . Each counter or rate reported in status logs is the value since the last time the counter was reset. |
| Domain Debug Logs | Domain debug logs record the client and server communication during an SMTP conversation between the appliance and a specified recipient host. This log type can be used to debug issues with specific recipient hosts. You must specify the total number of SMTP sessions to record in the log file. As sessions are recorded, this number decreases. You can stop domain debug before all sessions have been recorded by deleting or editing the log subscription. |
| Injection Debug Logs | Injection debug logs record the SMTP conversation between the appliance and a specified host connecting to the system. Injection debug logs are useful for troubleshooting communication problems between the Email Security appliance and a host on the Internet. |
| System Logs | System logs record the following: boot information, virtual appliance license expiration alerts, DNS status information, and comments users typed using commit command. System logs are useful for troubleshooting the basic state of the appliance . |
| CLI Audit Logs | The CLI audit logs record all CLI activity on the system. |

| Log | Description |
|----------------------|---|
| FTP Server Logs | FTP logs record information about the FTP services enabled on the interface. Connection details and user activity are recorded. |
| GUI Logs | See HTTP Logs. |
| HTTP Logs | <p>HTTP logs record information about the HTTP and/or secure HTTP services enabled on the interface. Because the graphical user interface (GUI) is accessed via HTTP, the HTTP logs are ostensibly the GUI equivalent of the CLI Audit logs. Session data (new session, session expired) and pages accessed in the GUI are recorded.</p> <p>These logs also include information about SMTP transactions, for example information about scheduled reports emailed from the appliance .</p> |
| NTP Logs | NTP logs record the conversation between the appliance and any NTP (Network Time Protocol) servers configured. For more information, see “Editing the Network Time Protocol (NTP) Configuration (Time Keeping Method)” in the “System Administration” chapter. |
| LDAP Debug Logs | LDAP debug logs are meant for debugging LDAP installations. (See the “LDAP Queries” chapter.) Useful information about the queries that the appliance is sending to the LDAP server are recorded here. |
| Anti-Spam Logs | Anti-spam logs record the status of the anti-spam scanning feature of your system, including the status on receiving updates of the latest anti-spam rules. Also, any logs related to the Context Adaptive Scanning Engine are logged here. |
| Anti-Spam Archive | If you enabled an Anti-Spam scanning feature, messages that are scanned and associated with the “archive message” action are archived here. The format is an mbox-format log file. For more information about anti-spam engines, see the “Anti-Spam” chapter. |
| Graymail Engine Logs | Contains information about the graymail engine, status, configuration, and so on. Most information is at Info or Debug level. |
| Graymail Archive | Contains archived messages (the messages that are scanned and associated with the “archive message” action). The format is an mbox-format log file. |
| Anti-Virus Logs | AntiVirus logs record the status of the anti-virus scanning feature of your system, including the status on receiving updates of the latest anti-virus identity files. |
| Anti-Virus Archive | If you enabled an anti-virus engine, messages that are scanned and associated with the “archive message” action are archived here. The format is an mbox-format log file. For more information, see the “Anti-Virus” chapter. |
| AMP Engine Logs | The AMP Engine logs record the status of the Advanced Malware Protection features of the system. For more information, see File Reputation Filtering and File Analysis, on page 457 |

| Log | Description |
|----------------------------|--|
| AMP Archive | If you have configured mail policies to archive messages that Advanced Malware Protection engine has found to have attachments that are unscannable or contain malware, those messages are archived here. The format is an mbox-format log file. |
| Scanning Logs | The scanning log contains all LOG and COMMON messages for scanning engines (see Alerts, on page 1021). This is typically application faults, alert sent, alert failed, and log error messages. This log does not apply to system-wide alerts. |
| Spam Quarantine Logs | Spam Quarantine logs record actions associated with the Spam Quarantine processes. |
| Spam Quarantine GUI Logs | Spam Quarantine logs record actions associated with the Spam Quarantine including configuration via the GUI, end user authentication, and end user actions (releasing email, etc.). |
| SMTP Conversation Logs | The SMTP conversation log records all parts of incoming and outgoing SMTP conversations. |
| Safe/Block Lists Logs | Safelist/blocklist logs record data about the safelist/blocklist settings and database. |
| Reporting Logs | Reporting logs record actions associated with the processes of the centralized reporting service. |
| Reporting Query Logs | Reporting query logs record actions associated with the reporting queries that are run on the appliance . |
| Updater Logs | The updater log records events related to updates for system services, such as McAfee Anti-Virus definition updates. |
| Tracking Logs | Tracking logs record actions associated with the processes of the tracking service. Tracking logs are a subset of the mail logs. |
| Authentication Logs | The authentication log records successful user logins and unsuccessful login attempts. |
| Configuration History Logs | Configuration history logs record the following information: What changes were made on the appliance , and when were the changes made? A new configuration history log is created each time a user commits a change. |
| Upgrade Logs | Status information about upgrade download and installation. |

| Log | Description |
|-----------------------------------|--|
| API Logs | API logs record various events related to the AsyncOS API for the appliance, for example: <ul style="list-style-type: none"> • API has started or stopped • Connection to the API failed or closed (after providing response) • Authentication succeeded or failed • Request contains errors • Error while communicating network configuration changes with AsyncOS API |
| Consolidated Event Logs | The Consolidated Event Logs summarizes each message event in a single log line. Using this log type you can reduce the number of bytes of data (log information) sent to a Security Information and Event Management (SIEM) vendor or application for analysis. The logs are in the Common Event Format (CEF) log message format that is widely used by most SIEM vendors. |
| CSN Logs | The CSN logs contain details about the CSN data uploads. The CSN data (appliance and feature usage details can be seen at the trace level. |
| Advanced Phishing Protection Logs | The Advanced Phishing Protection logs contain information related to Cisco Advanced Phishing Protection Cloud Service. Most information is at the Info or Critical level. |

Log Type Characteristics

The following table summarizes the different characteristics of each log type.

Table 120: Log Type Comparison

| | Contains | | | | | | | | | | | | | |
|----------------------------|---------------|-----------|------------------|-----------------------|--------------------|-----------------------------|-------------------------------|----------------------|-------------------------|-------------------------|-----------------------------|----------------|----------------------------|---------------------------|
| | Transactional | Stateless | Recorded as text | Recorded as mbox file | Recorded as binary | Periodic Status Information | Message Receiving Information | Delivery Information | Individual Hard Bounces | Individual Soft Bounces | Injection SMTP Conversation | Header Logging | Delivery SMTP Conversation | Configuration Information |
| Mail Logs | • | | • | | | • | • | • | • | • | | • | | |
| qmail Format Delivery Logs | | • | | | • | | • | • | • | | | • | | |
| Delivery Log | | • | | | • | | • | • | • | | | • | | |
| Bounce Logs | • | | • | | | | | | • | • | | • | | |

| | | | | | | Contains | | | | | | | | |
|----------------------|---------------|-----------|------------------|-----------------------|--------------------|-----------------------------|-------------------------------|----------------------|-----------------------|-----------------------|-----------------------------|----------------|----------------------------|---------------------------|
| | Transactional | Stateless | Recorded as text | Recorded as mbox file | Recorded as binary | Periodic Status Information | Message Receiving Information | Delivery Information | Individual Hard Bases | Individual Soft Bases | Injection SMTP Conversation | Header Logging | Delivery SMTP Conversation | Configuration Information |
| Status Logs | | • | • | | | • | | | | | | | | |
| Domain Debug Logs | • | | • | | | | | • | • | • | | | • | |
| Injection Debug Logs | • | | • | | | | • | | | | • | | | |
| System Logs | • | | • | | | • | | | | | | | | |
| CLI Audit Logs | • | | • | | | • | | | | | | | | |
| FTP Server Logs | • | | • | | | • | | | | | | | | |
| HTTP Logs | • | | • | | | • | | | | | | | | |
| NTP Logs | • | | • | | | • | | | | | | | | |
| LDAP Logs | • | | • | | | | | | | | | | | |
| Anti-spam Logs | • | | • | | | • | | | | | | | | |
| Anti-Spam Archive | | | | • | | | | | | | | | | |
| Graymail Engine Logs | • | | • | | | • | | | | | | | | |
| Graymail Archive | | | | • | | | | | | | | | | |

| | | | | | | Contains | | | | | | | | |
|-----------------------|---------------|-----------|------------------|-----------------------|--------------------|-----------------------------|-------------------------------|----------------------|-------------------------|-------------------------|-----------------------------|----------------|----------------------------|---------------------------|
| | Transactional | Stateless | Recorded as text | Recorded as mbox file | Recorded as binary | Periodic Status Information | Message Receiving Information | Delivery Information | Individual Hard Bounces | Individual Soft Bounces | Injection SMTP Conversation | Header Logging | Delivery SMTP Conversation | Configuration Information |
| Anti-virus Logs | • | | • | | | • | | | | | | | | |
| Anti-Virus Archive | | | | • | | | | | | | | | | |
| AMP Engine Logs | • | | • | | | • | | | | | | | | |
| AMP Archive | | | | • | | | | | | | | | | |
| Scanning Logs | • | | • | | | • | | | | | | | | • |
| Spam Quarantine | • | | • | | | • | | | | | | | | |
| Spam Quarantine GUI | • | | • | | | • | | | | | | | | |
| Safe/Block Lists Logs | • | | • | | | • | | | | | | | | |
| Reporting Logs | • | | • | | • | | | | | | | | | |
| Reporting Query Logs | • | | • | | • | | | | | | | | | |
| Updater Logs | | | • | | | | | | | | | | | |
| Tracking Logs | • | | | | • | • | • | • | • | • | | • | | |
| Authentication Logs | • | | • | | | | | | | | | | | |

| | | | | | | Contains | | | | | | | | |
|-----------------------------------|---------------|-----------|------------------|-----------------------|--------------------|-----------------------------|-------------------------------|----------------------|-----------------------|-----------------------|-----------------------------|----------------|----------------------------|---------------------------|
| | Transactional | Stateless | Recorded as text | Recorded as mbox file | Recorded as binary | Periodic Status Information | Message Receiving Information | Delivery Information | Individual Hard Bases | Individual Soft Bases | Injection SMTP Conversation | Header Logging | Delivery SMTP Conversation | Configuration Information |
| Configuration History Logs | • | | • | | | | | | | | | | | • |
| API Logs | • | | • | | | | | | | | | | | |
| Consolidated Event Logs | • | | • | | | | • | • | | | | | | |
| CSN Logs | • | | • | | | • | | | | | | | | • |
| Advanced Phishing Protection Logs | • | | • | | | | | | | | | | | |

Log Retrieval Methods

Log files can be retrieved based upon one of the following file transfer protocols. You set the protocol while creating or editing the log subscription in the GUI or via the logconfig command during the log subscription process.



Note When using a Log Push method on a particular log, that log will be locally unavailable for troubleshooting or searching via the CLI.

Table 121: Log Transfer Protocols

| | |
|-------------------|---|
| Manually Download | <p>This method lets you access log files at any time by clicking a link to the log directory on the Log Subscriptions page, then clicking the log file to access. Depending on your browser, you can view the file in a browser window, or open or save it as a text file. This method uses the HTTP(S) protocol and is the default retrieval method.</p> <p>Note Using this method, you cannot retrieve logs for any computer in a cluster, regardless of level (machine, group, or cluster), even if you specify this method in the CLI.</p> |
|-------------------|---|

| | |
|--|--|
| FTP Push | This method periodically pushes log files to an FTP server on a remote computer. The subscription requires a username, passphrase, and destination directory on the remote computer. Log files are transferred based on a rollover schedule set by you. |
| SCP Push | This method periodically pushes log files to an SCP server on a remote computer. This method requires an SSH SCP server on a remote computer using the SSH1 or SSH2 protocol. The subscription requires a username, SSH key, and destination directory on the remote computer. Log files are transferred based on a rollover schedule set by you. |
| Syslog Push | This method sends log messages to a remote syslog server. This method conforms to RFC 3164. You must submit a hostname for the syslog server and choose to use either UDP or TCP for log transmission. The port used is 514. A facility can be selected for the log; however, a default for the log type is pre-selected in the dropdown menu. Only text-based logs can be transferred using syslog push. |
| [Only for Consolidated Event Logs] AWS S3 Push | This method periodically pushes log files to the Amazon Simple Storage Service (S3) Bucket available on the Amazon Web Services (AWS) public cloud. The subscription requires an S3 bucket name, access key, and a secret key to access the Amazon S3 bucket. You can set a rollover schedule to transfer the log files.

Note Make sure that you have a valid AWS S3 bucket to use this retrieval method. For more information, refer to the AWS user documentation at https://docs.aws.amazon.com/IAM/latest/UserGuide/id_credentials_access-keys.html . |

Log Filenames and Directory Structure

AsyncOS creates a directory for each log subscription based on the log subscription name. The actual name of the log file in the directory is composed of the log filename specified by you, the timestamp when the log file was started, and a single-character status code. The filename of logs are made using the following formula:

```
/LogSubscriptionName/LogFilename.@timestamp.statuscode
```

Status codes may be `.current` or `.s` (signifying saved). You should only transfer or delete log files with the saved status.

Log Rollover and Transfer Schedule

Log files are created by log subscriptions, and are rolled over (and transferred, if a push-based retrieval option is selected) based on the first user-specified condition reached: maximum file size or scheduled rollover. Use the `logconfig` command in the CLI or the Log Subscriptions page in the GUI to configure both the maximum file size and time interval for scheduled rollovers. You can also use the **Rollover Now** button in the GUI or the `rollovernow` command in the CLI to rollover selected log subscriptions. See [Rolling Over Log Subscriptions, on page 1176](#) for more information on scheduling rollovers.

Logs retrieved using manual download are saved until they reach the maximum number you specify (the default is 10 files) or until the system needs more space for log files.

Logs Enabled by Default

Your appliance is pre-configured with many log subscriptions enabled by default (other logs may be configured depending on which license keys you have applied). By default, the retrieval method is “Manually Download.”

All pre-configured log subscriptions have a Log Level of 3, except for error_logs which is set at 1 so that it will contain only errors. See [Log Levels, on page 1172](#) for more information. For information about creating new log subscriptions, or modifying existing ones, see [Log Subscriptions, on page 1171](#).

Log Types

- [Using Text Mail Logs, on page 1123](#)
- [Using Delivery Logs, on page 1136](#)
- [Using Bounce Logs, on page 1139](#)
- [Using Status Logs, on page 1140](#)
- [Using Domain Debug Logs, on page 1143](#)
- [Using Injection Debug Logs, on page 1143](#)
- [Using System Logs, on page 1145](#)
- [Using CLI Audit Logs, on page 1145](#)
- [Using FTP Server Logs, on page 1146](#)
- [Using HTTP Logs, on page 1147](#)
- [Using NTP Logs, on page 1148](#)
- [Using Scanning Logs, on page 1148](#)
- [Using Anti-Spam Logs, on page 1149](#)
- [Using Graymail Logs, on page 1149](#)
- [Using Anti-Virus Logs, on page 1150](#)
- [Using AMP Engine Logs, on page 1150](#)
- [Using Spam Quarantine Logs, on page 1155](#)
- [Using Spam Quarantine GUI Logs, on page 1155](#)
- [Using LDAP Debug Logs, on page 1156](#)
- [Using Safelist/Blocklist Logs, on page 1157](#)
- [Using Reporting Logs, on page 1158](#)
- [Using Reporting Query Logs, on page 1159](#)
- [Using Updater Logs, on page 1160](#)
- [Understanding Tracking Logs, on page 1161](#)
- [Using Authentication Logs, on page 1162](#)
- [Using Configuration History Logs, on page 1162](#)
- [Using External Threat Feeds Engine Logs, on page 1163](#)
- [Using Consolidated Event Logs, on page 1164](#)
- [Using CSN Logs, on page 1170](#)
- [Using Advanced Phishing Protection Logs, on page 1171](#)

Timestamps in Log Files

The following log files include the begin and end date of the log itself, the version of AsyncOS, and the GMT offset (provided in seconds, and only at the beginning of the log):

- Anti-Virus log
- LDAP log
- System log
- Mail log

Using Text Mail Logs

They contain details of email receiving, email delivery and bounces. These logs are a useful source of information to understand delivery of specific messages and to analyze system performance.

These logs do not require any special configuration. However, you must configure the system properly to view attachment names, and attachment names may not always be logged. For information, see [Enabling Message Tracking, on page 887](#) and [Message Tracking Overview , on page 887](#).

Information displayed in text mail logs is shown in the following table:

Table 122: Text Mail Log Statistics

| Statistic | Description |
|-----------|---|
| ICID | Injection Connection ID. This is a numerical identifier for an individual SMTP connection to the system, over which 1 to thousands of individual messages may be sent. |
| DCID | Delivery Connection ID. This is a numerical identifier for an individual SMTP connection to another server, for delivery of 1 to thousands of messages, each with some or all of their RIDs being delivered in a single message transmission. |
| RCID | RPC Connection ID. This is a numerical identifier for an individual RPC connection to the Spam quarantine. It is used to track messages as they are sent to and from the Spam Quarantine. |
| MID | Message ID: Use this to track messages as they flow through the logs. |
| RID | Recipient ID: Each message recipient is assigned an ID. |
| New | New connection initiated. |
| Start | New message started. |

Interpreting a Text Mail Log

Use the following sample as a guide to interpret log files.



Note Individual lines in log files are NOT numbered. They are numbered here only for sample purposes.

Table 123: Text Mail Log Detail

| | |
|---|---|
| 1 | <pre>Mon Apr 17 19:56:22 2003 Info: New SMTP ICID 5 interface Management (10.1.1.1) address 10.1.1.209 reverse dns host remotehost.com verified yes</pre> |
|---|---|

| | |
|----|---|
| 2 | Mon Apr 17 19:57:20 2003 Info:
Start MID 6 ICID 5 |
| 3 | Mon Apr 17 19:57:20 2003 Info:
MID 6 ICID 5 From: <sender@remotehost.com> |
| 4 | Mon Apr 17 19:58:06 2003 Info:
MID 6 ICID 5 RID 0 To: <mary@yourdomain.com> |
| 5 | Mon Apr 17 19:59:52 2003 Info:
MID 6 ready 100 bytes from <sender@remotehost.com> |
| 6 | Mon Apr 17 19:59:59 2003 Info: ICID 5 close |
| 7 | Mon Mar 31 20:10:58 2003 Info:
New SMTP DCID 8 interface 192.168.42.42 address 10.5.3.25 |
| 8 | Mon Mar 31 20:10:58 2003 Info:
Delivery start DCID 8 MID 6 to RID [0] |
| 9 | Mon Mar 31 20:10:58 2003 Info:
Message done DCID 8 MID 6 to RID [0] |
| 10 | Mon Mar 31 20:11:03 2003 Info: DCID 8 close |

Use the following table as a guide to reading the preceding log file.

Table 124: Detail of Text Mail Log Example

| Line Number | Description |
|-------------|--|
| 1 | A new connection is initiated into the system and assigned an Injection ID (ICID) of “5.” The connection was received on the Management IP interface and was initiated from the remote host at 10.1.1.209. |
| 2 | The message was assigned a Message ID (MID) of “6” after the MAIL FROM command is issued from the client. |
| 3 | The sender address is identified and accepted. |
| 4 | The recipient is identified and assigned a Recipient ID (RID) of “0.” |
| 5 | MID 5 is accepted, written to disk, and acknowledged. |
| 6 | Receiving is successful and the receiving connection closes. |
| 7 | Next the message delivery process starts. It is assigned a Delivery Connection ID (DCID) of “8” from 192.168.42.42 and to 10.5.3.25. |
| 8 | The message delivery starts to RID “0.” |

| Line Number | Description |
|-------------|--|
| 9 | Delivery is successful for MID 6 to RID "0." |
| 10 | The delivery connection closes. |

Examples of Text Mail Log Entries

Following are some sample log entries based on various situations.

Message Injection and Delivery

A message is injected into the appliance for a single recipient. The message is successfully delivered.

```
Wed Jun 16 21:42:34 2004 Info: New SMTP ICID 282204970 interface mail.example.com
(1.2.3.4) address 2.3.4.5 reverse dns host unknown verified no

Wed Jun 16 21:42:34 2004 Info: ICID 282204970 SBRS None

Wed Jun 16 21:42:35 2004 Info: Start MID 200257070 ICID 282204970

Wed Jun 16 21:42:35 2004 Info: MID 200257070 ICID 282204970 From: <someone@foo.com>

Wed Jun 16 21:42:36 2004 Info: MID 200257070 ICID 282204970 RID 0 To: <user@example.com>

Wed Jun 16 21:42:38 2004 Info: MID 200257070 Message-ID
'<37gva9$5uvbhe@mail.example.com>'

Wed Jun 16 21:42:38 2004 Info: MID 200257070 Subject 'Hello'

Wed Jun 16 21:42:38 2004 Info: MID 200257070 ready 24663 bytes from <someone@foo.com>

Wed Jun 16 21:42:38 2004 Info: MID 200257070 antivirus negative

Wed Jun 16 21:42:38 2004 Info: MID 200257070 queued for delivery

Wed Jun 16 21:42:38 2004 Info: New SMTP DCID 2386069 interface 1.2.3.4 address 1.2.3.4

Wed Jun 16 21:42:38 2004 Info: Delivery start DCID 2386069 MID 200257070 to RID [0]

Wed Jun 16 21:42:38 2004 Info: ICID 282204970 close

Wed Jun 16 21:42:38 2004 Info: Message done DCID 2386069 MID 200257070 to RID [0]
[('X-SBRS', 'None')]

Wed Jun 16 21:42:38 2004 Info: MID 200257070 RID [0] Response 2.6.0
<37gva9$5uvbhe@mail.example.com> Queued mail for delivery

Wed Jun 16 21:42:43 2004 Info: DCID 2386069 close
```

Successful Message Delivery

```
Mon Mar 31 20:10:58 2003 Info: New SMTP DCID 5 interface 172.19.0.11 address
63.251.108.110

Mon Mar 31 20:10:58 2003 Info: Delivery start DCID 5 MID 4 to RID [0]

Mon Mar 31 20:10:58 2003 Info: Message done DCID 5 MID 4 to RID [0]
```

Unsuccessful Message Delivery (Hard Bounce)

```
Mon Mar 31 20:11:03 2003 Info: DCID 5 close
```

Unsuccessful Message Delivery (Hard Bounce)

A message with two recipients is injected into the appliance . Upon delivery, the destination host returns a 5XX error, which indicates that the message cannot be delivered to either recipient. The appliance notifies the sender and removes the recipients from the queue.

```
Mon Mar 31 20:00:23 2003 Info: New SMTP DCID 3 interface 172.19.0.11 address
64.81.204.225
```

```
Mon Mar 31 20:00:23 2003 Info: Delivery start DCID 3 MID 4 to RID [0, 1]
Mon Mar 31 20:00:27 2003 Info: Bounced: DCID 3 MID 4 to RID 0 - 5.1.0 - Unknown address
error ('550', ['<george@yourdomain.com>... Relaying denied']) []
Mon Mar 31 20:00:27 2003 Info: Bounced: DCID 3 MID 4 to RID 1 - 5.1.0 - Unknown address
error ('550', ['<jane@yourdomain.com>... Relaying denied']) []
Mon Mar 31 20:00:32 2003 Info: DCID 3 close
```

Soft Bounce Followed by Successful Delivery

A message is injected into the appliance . On the first delivery attempt, the message soft bounces and is queued for future delivery. On the second attempt, the message is successfully delivered.

```
Mon Mar 31 20:10:58 2003 Info: New SMTP DCID 5 interface 172.19.0.11 address
63.251.108.110
```

```
Mon Mar 31 20:00:23 2003 Info: Delivery start DCID 3 MID 4 to RID [0, 1]
```

```
Mon Mar 31 20:00:23 2003 Info: Delayed: DCID 5 MID 4 to RID 0 - 4.1.0 - Unknown address
error ('466', ['Mailbox temporarily full.'])[]
```

```
Mon Mar 31 20:00:23 2003 Info: Message 4 to RID [0] pending till Mon Mar 31 20:01:23
2003
```

```
Mon Mar 31 20:01:28 2003 Info: DCID 5 close
```

```
Mon Mar 31 20:01:28 2003 Info: New SMTP DCID 16 interface PublicNet address 172.17.0.113
```

```
Mon Mar 31 20:01:28 2003 Info: Delivery start DCID 16 MID 4 to RID [0]
```

```
Mon Mar 31 20:01:28 2003 Info: Message done DCID 16 MID 4 to RID [0]
```

```
Mon Mar 31 20:01:33 2003 Info: DCID 16 close
```

Message Scanning Results for the scanconfig Command

You can use the scanconfig command to determine the system behavior when a message can not be deconstructed into its component parts (when removing attachments). The Options are Deliver , Bounce , or Drop .

The following example shows the Text Mail log with scanconfig set to Deliver .

```
Tue Aug 3 16:36:29 2004 Info: MID 256 ICID 44784 From: <test@virus.org>
```

```
Tue Aug 3 16:36:29 2004 Info: MID 256 ICID 44784 RID 0 To: <joe@example.com>
```

```
Tue Aug 3 16:36:29 2004 Info: MID 256 Message-ID '<137398.@virus.org>'
```

```
Tue Aug 3 16:36:29 2004 Info: MID 256 Subject 'Virus Scanner Test #22'
```

```
Tue Aug 3 16:36:29 2004 Info: MID 256 ready 1627 bytes from <test@virus.org>
Tue Aug 3 16:36:29 2004 Warning: MID 256, Message Scanning Problem: Continuation line
seen before first header

Tue Aug 3 16:36:29 2004 Info: ICID 44784 close
Tue Aug 3 16:36:29 2004 Info: MID 256 antivirus positive 'EICAR-AV-Test'
Tue Aug 3 16:36:29 2004 Info: Message aborted MID 256 Dropped by antivirus
Tue Aug 3 16:36:29 2004 Info: Message finished MID 256 done
```

The following example shows the Text Mail log with scanconfig set to drop .

```
Tue Aug 3 16:38:53 2004 Info: Start MID 257 ICID 44785
Tue Aug 3 16:38:53 2004 Info: MID 257 ICID 44785 From: test@virus.org
Tue Aug 3 16:38:53 2004 Info: MID 257 ICID 44785 RID 0 To: <joe@example.com>
Tue Aug 3 16:38:53 2004 Info: MID 257 Message-ID '<392912.@virus.org>'
Tue Aug 3 16:38:53 2004 Info: MID 25781 Subject 'Virus Scanner Test #22'
Tue Aug 3 16:38:53 2004 Info: MID 257 ready 1627 bytes from <test@virus.org>
Tue Aug 3 16:38:53 2004 Warning: MID 257, Message Scanning Problem: Continuation line
seen before first header
Tue Aug 3 16:38:53 2004 Info: Message aborted MID 25781 Dropped by filter 'drop_zip_c'
Tue Aug 3 16:38:53 2004 Info: Message finished MID 257 done
Tue Aug 3 16:38:53 2004 Info: ICID 44785 close
```

Message with Attachment

In this example, a content filter with condition “Message Body Contains” has been configured to enable identification of attachment names:

```
Sat Apr 23 05:05:42 2011 Info: New SMTP ICID 28 interface Management (192.0.2.10)
address 224.0.0.10 reverse dns host test.com verified yes

Sat Apr 23 05:05:42 2011 Info: ICID 28 ACCEPT SG UNKNOWNLIST match sbrs[-1.0:10.0]
SBRS 0.0

Sat Apr 23 05:05:42 2011 Info: Start MID 44 ICID 28
Sat Apr 23 05:05:42 2011 Info: MID 44 ICID 28 From: <sender1@example.com>
Sat Apr 23 05:05:42 2011 Info: MID 44 ICID 28 RID 0 To: <recipient1@example.org>
Sat Apr 23 05:05:42 2011 Info: MID 44 Message-ID '<000001cba32e$f24ff2e0$d6efd8a0$@com>'
Sat Apr 23 05:05:42 2011 Info: MID 44 Subject 'Message 001'
Sat Apr 23 05:05:42 2011 Info: MID 44 ready 240129 bytes from <sender1@example.com>
Sat Apr 23 05:05:42 2011 Info: MID 44 matched all recipients for per-recipient
policy DEFAULT in the inbound table
Sat Apr 23 05:05:42 2011 Info: ICID 28 close
Sat Apr 23 05:05:42 2011 Info: MID 44 interim verdict using engine: CASE
spam negative
Sat Apr 23 05:05:42 2011 Info: MID 44 using engine: CASE spam negative
Sat Apr 23 05:05:43 2011 Info: MID 44 attachment 'Banner.gif'
Sat Apr 23 05:05:43 2011 Info: MID 44 attachment '=D1=82=D0=B5=D1=81=D1=82.rst'
Sat Apr 23 05:05:43 2011 Info: MID 44 attachment 'Test=20Attachment.docx'
Sat Apr 23 05:05:43 2011 Info: MID 44 queued for delivery
```

Note that the second of the three attachments is Unicode. On terminals that cannot display Unicode, these attachments are represented in quoted-printable format.

Successful Message Delivery with DANE Support

A message reaches the appliance for a single recipient. The appliance requests for a secure DNS MX record, DNS A record, and a TLSA record from the DNS server. If you select DANE as "Mandatory", the TLSA record is validated against the X.509 certificate value of the recipient's domain. If the TLSA record validation is successful, the message is delivery to the recipient.

```
Tue Nov 13 12:13:33 2018 Debug: Trying DANE MANDATORY for example.org
Tue Nov 13 12:13:33 2018 Debug: SECURE MX record(mail.example.org) found for example.org
Tue Nov 13 12:13:33 2018 Debug: DNS query: Q('mail.example.org', 'CNAME')
Tue Nov 13 12:13:33 2018 Debug: DNS query: QN('mail.example.org', 'CNAME',
'recursive_nameserver0.parent')
Tue Nov 13 12:13:33 2018 Debug: DNS query: QIP ('mail.example.org','CNAME','8.8.8.8',60)
Tue Nov 13 12:13:33 2018 Debug: DNS query: Q ('mail.example.org', 'CNAME', '8.8.8.8')
Tue Nov 13 12:13:34 2018 Debug: DNSSEC Response data([], , 0, 1799)
Tue Nov 13 12:13:34 2018 Debug: Received NODATA for domain mail.example.org type CNAME
Tue Nov 13 12:13:34 2018 Debug: No CNAME record(NoError) found for domain(mail.example.org)
Tue Nov 13 12:13:34 2018 Debug: SECURE A record (4.31.198.44) found for
MX(mail.example.org) in example.org
Tue Nov 13 12:13:34 2018 Info: New SMTP DCID 92 interface 10.10.1.191 address 4.31.198.44
port 25
Tue Nov 13 12:13:34 2018 Info: ICID 13 lost
Tue Nov 13 12:13:34 2018 Info: ICID 13 close
Tue Nov 13 12:13:34 2018 Debug: DNS query: Q('_25._tcp.mail.example.org', 'TLSA')
Tue Nov 13 12:13:34 2018 Debug: DNS query: QN('_25._tcp.mail.example.org', 'TLSA',
'recursive_nameserver0.parent')
Tue Nov 13 12:13:34 2018 Debug: DNS query: QIP
('_25._tcp.mail.example.org','TLSA','8.8.8.8',60)
Tue Nov 13 12:13:34 2018 Debug: DNS query: Q ('_25._tcp.mail.example.org', 'TLSA', '8.8.8.8')
Tue Nov 13 12:13:35 2018 Debug: DNSSEC Response data(['0301010c72ac70b745ac19998811b13
1d662c9ac69dbdbe7cb23e5b514b56664c5d3d6'], secure, 0, 1799)
Tue Nov 13 12:13:35 2018 Debug: DNS encache (_25._tcp.mail.example.org, TLSA,
[(2550119024205761L, 0,
'SECURE', '0301010c72ac70b745ac19998811b131d662c9ac69dbdbe7cb23e5b514b56664c5d3d6')])
Tue Nov 13 12:13:35 2018 Debug: SECURE TLSA Record found for MX(mail.example.org) in
example.org
Tue Nov 13 12:13:36 2018 Info: DCID 92 Certificate verification successful
Tue Nov 13 12:13:36 2018 Info: DCID 92 TLS success protocol TLSv1.2 cipher
Tue Nov 13 12:13:36 2018 Info: DCID 92 TLS success protocol TLSv1.2 cipher
ECDHE-RSA-AES256-GCM-SHA384 for example.org
Tue Nov 13 12:13:36 2018 Info: Delivery start DCID 92 MID 23 to RID [0]
```

Message Delivery Failed due to Certificate Verification Failure

A message reaches the appliance for a single recipient. The appliance requests for a secure DNS MX record, DNS A record, and a TLSA record from the DNS server. If you select DANE as "Mandatory", the TLSA record is validated against the X.509 certificate value of the recipient's domain. If the certificate verification fails, the message is delivered at a later time. If secure TLSA record is not found, the message is bounced.

```
Wed Nov 14 05:52:08 2018 Debug: DNS query: QN('server1.example.net', 'CNAME',
'recursive_nameserver0.parent')
Wed Nov 14 05:52:08 2018 Debug: DNS query: QIP
('server1.example.net','CNAME','10.10.2.184',60)
Wed Nov 14 05:52:08 2018 Debug: DNS query: Q ('server1.example.net', 'CNAME', '10.10.2.184')
Wed Nov 14 05:52:08 2018 Debug: DNSSEC Response data([], , 0, 284)
Wed Nov 14 05:52:08 2018 Debug: Received NODATA for domain server1.example.net type CNAME
Wed Nov 14 05:52:08 2018 Debug: No CNAME record(NoError) found for domain(server1.example.net)
Wed Nov 14 05:52:08 2018 Debug: Secure CNAME(server1.example.net) found for
MX(someone.cs2.example.net)
in example.net
Wed Nov 14 05:52:08 2018 Debug: SECURE A record (10.10.1.198) found for
MX(someone.cs2.example.net)
```

```
in example.net
Wed Nov 14 05:52:08 2018 Info: New SMTP DCID 102 interface 10.10.1.191 address 10.10.1.198
port 25
Wed Nov 14 05:52:08 2018 Debug: Fetching TLSA records with CNAME(server1.example.net) for
MX(someone.cs2.example.net) in example.net
Wed Nov 14 05:52:08 2018 Debug: DNS query: Q('_25._tcp.server1.example.net', 'TLSA')
Wed Nov 14 05:52:08 2018 Debug: SECURE TLSA Record found for MX(server1.example.net) in
example.net
Wed Nov 14 05:52:08 2018 Debug: DCID 102 All TLSA records failed for certificate not trusted
Wed Nov 14 05:52:08 2018 Debug: Fetching TLSA records with initial
name(someone.cs2.example.net)
in example.net
Wed Nov 14 05:52:08 2018 Debug: DNS query: Q('_25._tcp.someone.cs2.example.net', 'TLSA')
Wed Nov 14 05:52:08 2018 Debug: SECURE TLSA Record found for MX(someone.cs2.example.net)
in example.net
Wed Nov 14 05:52:08 2018 Info: DCID 102 Certificate verification successful
Wed Nov 14 05:52:08 2018 Info: DCID 102 TLS success protocol TLSv1.2 cipher
DHE-RSA-AES128-SHA256
for example.net
Wed Nov 14 05:52:08 2018 Info: Delivery start DCID 102 MID 26 to RID [0]
Wed Nov 14 05:52:08 2018 Info: Message done DCID 102 MID 26 to RID [0]
Wed Nov 14 05:52:08 2018 Info: MID 26 RID [0] Response 'ok: Message 31009 accepted'
Wed Nov 14 05:52:08 2018 Info: Message finished MID 26 done

Wed Nov 14 06:36:22 2018 Debug: Trying DANE MANDATORY for example.net
Wed Nov 14 06:36:22 2018 Debug: SECURE MX record(someone.cs2.example.net) found for
example.net
Wed Nov 14 06:36:22 2018 Debug: DNS query: Q('someone.cs2.example.net', 'CNAME')
Wed Nov 14 06:36:22 2018 Debug: DNS query: QN('someone.cs2.example.net', 'CNAME',
'recursive_nameserver0.parent')
Wed Nov 14 06:36:22 2018 Debug: DNS query: QIP
('someone.cs2.example.net','CNAME','10.10.2.184',60)
Wed Nov 14 06:36:22 2018 Debug: DNS query: Q ('someone.cs2.example.net', 'CNAME',
'10.10.2.184')
Wed Nov 14 06:36:22 2018 Debug: DNSSEC Response data(['mail.example2.net.'], secure, 0,
3525)
Wed Nov 14 06:36:22 2018 Debug: DNS encache (someone.cs2.example.net, CNAME,
[(2692348132363369L, 0,
'SECURE', 'mail.example2.net')])
Wed Nov 14 06:36:22 2018 Debug: DNS query: Q('mail.example2.net', 'CNAME')
Wed Nov 14 06:36:22 2018 Debug: DNS query: QN('mail.example2.net', 'CNAME',
'recursive_nameserver0.parent')
Wed Nov 14 06:36:22 2018 Debug: DNS query: QIP ('mail.example2.net','CNAME','10.10.2.184',60)
Wed Nov 14 06:36:22 2018 Debug: DNS query: Q ('mail.example2.net', 'CNAME', '10.10.2.184')
Wed Nov 14 06:36:22 2018 Debug: DNSSEC Response data([], , 0, 225)
Wed Nov 14 06:36:22 2018 Debug: Received NODATA for domain mail.example2.net type CNAME
Wed Nov 14 06:36:22 2018 Debug: No CNAME record(NoError) found for domain(mail.example2.net)
Wed Nov 14 06:36:22 2018 Debug: Secure CNAME(mail.example2.net) found for
MX(someone.cs2.example.net)
in example.net
Wed Nov 14 06:36:22 2018 Debug: INSECURE A record (10.10.1.197) found for
MX(someone.cs2.example.net)
in example.net
Wed Nov 14 06:36:22 2018 Debug: Fetching TLSA records with initial
name(someone.cs2.example.net) in example.net
Wed Nov 14 06:36:22 2018 Info: New SMTP DCID 104 interface 10.10.1.191 address 10.10.1.197
port 25
Wed Nov 14 06:36:36 2018 Debug: DNS query: Q('_25._tcp.someone.cs2.example.net', 'TLSA')
Wed Nov 14 06:36:36 2018 Debug: SECURE TLSA Record found for MX(someone.cs2.example.net)
in example.net
Wed Nov 14 06:36:36 2018 Debug: DCID 104 All TLSA records failed for certificate not trusted
Wed Nov 14 06:36:36 2018 Info: MID 27 DCID 104 DANE failed for the domain example.net:
DANE Certificate verification failed
Wed Nov 14 06:36:36 2018 Info: Failed for all MX hosts in example.net
```

Message Delivery Failed due to Invalid TLSA Record

A message reaches the appliance for a single recipient. The appliance requests for a secure DNS MX record, DNS A record, and a TLSA record from the DNS server. If you select DANE as "Mandatory", the TLSA record is validated against the X.509 certificate value of the recipient's domain. If an invalid TLSA record is found, the message delivery is attempted at a later time or the message is bounced.

```
Tue Aug 7 05:15:18 2018 Debug: Trying DANE MANDATORY for example-dane.net
Tue Aug 7 05:15:18 2018 Debug: SECURE MX record (someone.example-dane.net) found for
test-tlsabogus.net
Tue Aug 7 05:15:18 2018 Debug: DNS query: Q ('someone.example-dane.net', 'CNAME')
Tue Aug 7 05:15:18 2018 Debug: DNS query: QN ('someone.example-dane.net', 'CNAME',
'recursive_nameserver0.parent')
Tue Aug 7 05:15:18 2018 Debug: DNS query: QIP
('someone.example-dane.net', 'CNAME', '10.10.2.183', 60)
Tue Aug 7 05:15:18 2018 Debug: DNS query: Q ('someone.example-dane.net', 'CNAME',
'10.10.2.183')
Tue Aug 7 05:15:18 2018 Debug: DNSSEC Response data ([], , 0, 300)
Tue Aug 7 05:15:18 2018 Debug: SECURE A record (10.10.1.198) found for MX
(someone.example-dane.net)
in example-dane.net
Tue Aug 7 05:15:18 2018 Info: ICID 32 close
Tue Aug 7 05:15:18 2018 Info: New SMTP DCID 61 interface 10.10.1.194 address 10.10.1.198
port 25
Tue Aug 7 05:15:18 2018 Debug: DNS query: Q ('_25._tcp.someone.example-dane.net', 'TLSA')
Tue Aug 7 05:15:18 2018 Debug: DNS query: QN ('_25._tcp.someone.example-dane.net', 'TLSA',
'recursive_nameserver0.parent')
Tue Aug 7 05:15:18 2018 Debug: DNS query: QIP
('_25._tcp.someone.example-dane.net', 'TLSA', '10.10.2.183', 60)
Tue Aug 7 05:15:18 2018 Debug: DNS query: Q ('_25._tcp.someone.example-dane.net', 'TLSA',
'10.10.2.183')
Tue Aug 7 05:15:18 2018 Debug: DNSSEC Response data
(['03010160b3f16867357cdfef37bb6acd687af54f
225e3bfa945e1d37bfd37bd4eb6020'], bogus, 0, 60)
Tue Aug 7 05:15:18 2018 Debug: DNS encache (_25._tcp.someone.example-dane.net, TLSA,
[(11065394975822091L,
0, 'BOGUS', '03010160b3f16867357cdfef37bb6acd687af54f225e3bfa945e1d37bfd37bd4eb6020')])
Tue Aug 7 05:15:18 2018 Debug: BOGUS TLSA Record is found for MX (someone.example-dane.net)

in example-dane.net
Tue Aug 7 05:15:18 2018 Debug: Trying next MX record in example-dane.net
Tue Aug 7 05:15:18 2018 Info: MID 44 DCID 61 DANE failed: TLSA record BOGUS
Tue Aug 7 05:15:18 2018 Debug: Failed for all MX hosts in example-dane.net
```

Rolling Back to Opportunistic TLS as TLSA Record Not Found

A message reaches the appliance for a single recipient. The appliance requests for a secure DNS MX record, DNS A record, and a TLSA record from the DNS server. If you select DANE as "Opportunistic", the TLSA record is validated against the X.509 certificate value of the recipient's domain. If TLSA record is not found for the recipient's domain, opportunistic TLS is used for encrypting SMTP conversations.

```
Wed Sep 12 06:51:32 2018 Debug: Trying DANE OPPORTUNISTIC for example-dane.com
Wed Sep 12 06:51:32 2018 Debug: SECURE MX record (mx.example-dane.com) found for
digitalhellion.com
Wed Sep 12 06:51:32 2018 Debug: DNS query: Q ('mx.example-dane.com', 'CNAME')
Wed Sep 12 06:51:32 2018 Debug: DNS query: QN ('mx.example-dane.com', 'CNAME',
'recursive_nameserver0.parent')
Wed Sep 12 06:51:32 2018 Debug: DNS query: QIP ('mx.example-dane.com', 'CNAME', '8.8.8.8', 60)
Wed Sep 12 06:51:32 2018 Debug: DNS query: Q ('mx.example-dane.com', 'CNAME', '8.8.8.8')
Wed Sep 12 06:51:32 2018 Debug: DNSSEC Response data ([], , 0, 1799)
Wed Sep 12 06:51:32 2018 Debug: Received NODATA for domain mx.example-dane.com type CNAME
Wed Sep 12 06:51:32 2018 Debug: No CNAME record (NoError) found for domain
```



```

(mx.example-dane.com)
Wed Sep 12 06:51:32 2018 Debug: SECURE A record (162.213.199.115) found for MX
(mx.example-dane.com)
in example-dane.com
Wed Sep 12 06:51:32 2018 Info: ICID 1 lost
Wed Sep 12 06:51:32 2018 Info: ICID 1 close
Wed Sep 12 06:51:33 2018 Info: New SMTP DCID 2 interface 10.10.1.173 address 162.213.199.115
port 25
Wed Sep 12 06:51:33 2018 Debug: DNS query: Q ('_25._tcp.mx.example-dane.com', 'TLSA')
Wed Sep 12 06:51:33 2018 Debug: DNS query: QN ('_25._tcp.mx.example-dane.com', 'TLSA',
'recursive_nameserver0.parent')
Wed Sep 12 06:51:33 2018 Debug: DNS query: QIP
('_25._tcp.mx.example-dane.com', 'TLSA', '8.8.8.8', 60)
Wed Sep 12 06:51:33 2018 Debug: DNS query: Q ('_25._tcp.mx.example-dane.com', 'TLSA',
'8.8.8.8')
Wed Sep 12 06:51:34 2018 Debug: DNSSEC Response data ([], , 3, 1798)
Wed Sep 12 06:51:34 2018 Debug: Received NXDomain for domain _25._tcp.mx.example-dane.com'
type TLSA
Wed Sep 12 06:51:34 2018 Debug: No TLSA record (NXDomain) found for MX (mx.example-dane.com)
Wed Sep 12 06:51:34 2018 Debug: Falling back to conventional TLS for MX (mx.example-dane.com)

in example-dane.com
Wed Sep 12 06:51:34 2018 Info: MID 1 DCID 2 DANE failed for the domain example-dane.com:
No TLSA Record
Wed Sep 12 06:51:34 2018 Info: DCID 2 TLS success protocol TLSv1.2 cipher
ECDHE-RSA-AES256-GCM-SHA384
Wed Sep 12 06:51:35 2018 Info: Delivery start DCID 2 MID 1 to RID [0]

```

Message received based on Sender's Country of Origin

In this example, the log shows a message received based on the country of origin of a particular sender group.

```

Thu Apr 6 06:50:18 2017 Info: ICID 73 ACCEPT SG ALLOWED_LIST match country[us] SBRS -10.0
country United States

```

Maximum URLs in Message Attachments Exceeds URL Scan Limit

In this example, the log shows the number of URLs in the message attachments that exceeded the URL scan limit

```

Wed Nov 8 13:35:48 2017 Info: MID $mid not completely scanned for URL Filtering. Error:
$error

```

Maximum URLs in Message Body Exceeds URL Scan Limit

In this example, the log shows the number of URLs in the message body that exceeded the URL scan limit.

```

Wed Nov 8 13:37:42 2017 Info: MID 976 not completely scanned for URL Filtering.
Error: The number of URLs in the message body exceeded the URL scan limit.

```

Malicious Shortened URL redirected to Cisco Proxy Server

In this example, the log shows a shortened URL that is marked as malicious due to a URL reputation score of -3, and redirected to the Cisco Security Proxy server.

```

Tue Nov 7 10:42:41 2017 Info: MID 9 having URL: http://ow.ly/Sb6O30fJvVn has been expanded
to http://bit.ly/2frAllx
Tue Nov 7 10:42:42 2017 Info: MID 9 having URL: http://bit.ly/2frAllx has been expanded to
http://thebest01.wayisbetter.cn/?cMFN
Tue Nov 7 10:42:42 2017 Info: MID 9 URL http://thebest01.wayisbetter.cn/?cMFN has reputation
-3.854 matched Action: URL redirected to Cisco Security proxy

```

```
Tue Nov 7 10:42:42 2017 Info: MID 9 rewritten to MID 10 by
url-reputation-proxy-redirect-action filter 'aa'
```

Unable to Expand Shortened URL in Message

In this example, the log shows that the shortened URL in the message could not be expanded to the actual URL.

```
Mon Oct 30 10:58:59 2017 Info: MID 36 having URL: http://ow.ly/P0Kw30fVst3 has been expanded
to http://bit.ly/2ymYWPR
Mon Oct 30 10:59:00 2017 Info: MID 36 having URL: http://bit.ly/2ymYWPR has been expanded
to http://ow.ly/cTS730fVssH
Mon Oct 30 10:59:01 2017 Info: MID 36 having URL: http://ow.ly/cTS730fVssH has been expanded
to http://bit.ly/2xK8PD9
Mon Oct 30 10:59:01 2017 Info: MID 36 having URL: http://bit.ly/2xK8PD9 has been expanded
to http://ow.ly/lWOi30fVssl
Mon Oct 30 10:59:02 2017 Info: MID 36 having URL: http://ow.ly/lWOi30fVssl has been expanded
to http://bit.ly/2ggHv9e
Mon Oct 30 10:59:03 2017 Info: MID 36 having URL: http://bit.ly/2ggHv9e has been expanded
to http://ow.ly/4fSO30fVsqx
Mon Oct 30 10:59:04 2017 Info: MID 36 having URL: http://ow.ly/4fSO30fVsqx has been expanded
to http://bit.ly/2hKEFcW
Mon Oct 30 10:59:05 2017 Info: MID 36 having URL: http://bit.ly/2hKEFcW has been expanded
to http://ow.ly/NyH830fVsqs6
Mon Oct 30 10:59:06 2017 Info: MID 36 having URL: http://ow.ly/NyH830fVsqs6 has been expanded
to http://bit.ly/2ysnsNi
Mon Oct 30 10:59:06 2017 Info: MID 36 having URL: http://bit.ly/2ysnsNi has been expanded
to http://ow.ly/JhUN30fVsnL
Mon Oct 30 10:59:07 2017 Info: MID 36 having URL: http://ow.ly/JhUN30fVsnL has been expanded
to http://bit.ly/2hKQmAe
Mon Oct 30 10:59:07 2017 Info: MID 36 URL http://bit.ly/2hKQmAe is marked malicious due to
: URL depth exceeded
Mon Oct 30 11:04:48 2017 Warning: MID 40 Failed to expand URL http://mail1.example.com/abcd
Reason: Error while trying to retrieve expanded URL
Mon Oct 30 11:04:48 2017 Info: MID 40 not completely scanned for URL Filtering. Error:
Message has a shortened URL that could not be expanded
```

Log Entry for Malicious URL in Message Attachment

In this example, the log shows a URL in the message attachment that is malicious with a reputation score of -9.5.

```
Mon Nov 6 06:50:18 2017 Info: MID 935 Attachment file_1.txt URL http://jrsjvysq.net has
reputation -9.5 matched
Condition: URL Reputation Rule
```

Message marked as Unscannable due to Extraction Failure

In this example, the log shows a message that is not scanned by the Content Scanner due to an attachment extraction failure.

```
Tue Oct 24 08:28:58 2017 Info: Start MID 811 ICID 10
Tue Oct 24 08:28:58 2017 Info: MID 811 ICID 10 From: <sender@example.com>
Tue Oct 24 08:28:58 2017 Info: MID 811 ICID 10 RID 0 To: <recipient@example.com>
Tue Oct 24 08:28:58 2017 Info: MID 811 Message-ID '<example@cisco.com>'
Tue Oct 24 08:28:58 2017 Info: MID 811 Subject 'Test mail'
Tue Oct 24 08:28:58 2017 Info: MID 811 ready 5242827 bytes from <user2@sender.com>
Tue Oct 24 08:28:58 2017 Info: MID 811 matched all recipients for per-recipient policy
DEFAULT in the inbound table
Tue Oct 24 08:28:59 2017 Info: MID 811 attachment 'gzip.tar.gz'
Tue Oct 24 08:28:59 2017 Info: MID 811 was marked as unscannable due to extraction failures.
Reason: Error in extraction process - Decoding Errors.
```

```
Tue Oct 24 08:28:59 2017 Info: ICID 10 close
Tue Oct 24 08:28:59 2017 Info: MID 811 quarantined to "Policy" (Unscannable: due to Extraction Failure)
Tue Oct 24 08:28:59 2017 Info: Message finished MID 811 done
```

Message marked as Unscannable due to RFC Violation

In this example, the log shows a message that is not scanned by the Content Scanner due to an RFC violation.

```
Tue Oct 24 08:23:26 2017 Info: Start MID 807 ICID 6
Tue Oct 24 08:23:26 2017 Info: MID 807 ICID 6 From: <sender@example.com>
Tue Oct 24 08:23:26 2017 Info: MID 807 ICID 6 RID 0 To: <recipient@example.com>
Tue Oct 24 08:23:26 2017 Info: MID 807 Subject 'Test Mail'
Tue Oct 24 08:23:26 2017 Info: MID 807 ready 427 bytes from <sender@example.com>
Tue Oct 24 08:23:26 2017 Info: MID 807 matched all recipients for per-recipient policy DEFAULT in the inbound table
Tue Oct 24 08:23:26 2017 Info: MID 807 was marked as unscannable due to an RFC violation. Reason: A Unix-From header was found in the middle of a header block.
Tue Oct 24 08:23:26 2017 Info: MID 807 queued for delivery
Tue Oct 24 08:23:26 2017 Info: ICID 6 close
```

Log Entries for Generated or Re-Written Messages

Some functions, such as rewrite/redirect actions (alt-rcpt-to filters, anti-spam rcpt rewrite, bcc() actions, anti-virus redirections, etc.), create new messages. When looking through the logs, you might need to check the results and add in further MIDs and possibly DCIDs. Entries such as these are possible:

```
Tue Jun 1 20:02:16 2004 Info: MID 14 generated based on MID 13 by bcc filter 'nonetest'
or:
Tue Jan 6 15:03:18 2004 Info: MID 2 rewritten to 3 by antispam
Fri May 14 20:44:43 2004 Info: MID 6 rewritten to 7 by alt-rcpt-to-filter filter 'testfilt'
```

An interesting point to note about 'rewritten' entries is that they can appear after lines in the log indicating use of the new MID.

Messages Sent to the Spam Quarantine

When you send a message to the quarantine, the mail logs track the movement to and from the quarantine using the RCID (RPC connection ID) to identify the RPC connection. In the following mail log, a message is tagged as spam, and sent to the Spam Quarantine:

```
Wed Feb 14 12:11:40 2007 Info: Start MID 2317877 ICID 15726925
Wed Feb 14 12:11:40 2007 Info: MID 2317877 ICID 15726925 From: <HLD@chasehf.bfi0.com>
Wed Feb 14 12:11:40 2007 Info: MID 2317877 ICID 15726925 RID 0 To: <stevel@healthtrust.org>
Wed Feb 14 12:11:40 2007 Info: MID 2317877 Message-ID '<W1TH05606E5811BEA0734309D4BAF0.323.14460.pimailer44.DumpShot.2@email.chase.com>'
Wed Feb 14 12:11:40 2007 Info: MID 2317877 Subject 'Envision your dream home - Now make it a reality'
Wed Feb 14 12:11:40 2007 Info: MID 2317877 ready 15731 bytes from <HLD@chasehf.bfi0.com>
Wed Feb 14 12:11:40 2007 Info: MID 2317877 matched all recipients for per-recipient policy DEFAULT in the inbound table
```

```

Wed Feb 14 12:11:41 2007 Info: MID 2317877 using engine: CASE spam suspect

Wed Feb 14 12:11:41 2007 Info: EUQ: Tagging MID 2317877 for quarantine
Wed Feb 14 12:11:41 2007 Info: MID 2317877 antivirus negative
Wed Feb 14 12:11:41 2007 Info: MID 2317877 queued for delivery
Wed Feb 14 12:11:44 2007 Info: RPC Delivery start RCID 756814 MID 2317877 to local
IronPort Spam Quarantine

Wed Feb 14 12:11:45 2007 Info: EUQ: Quarantined MID 2317877

Wed Feb 14 12:11:45 2007 Info: RPC Message done RCID 756814 MID 2317877

Wed Feb 14 12:11:45 2007 Info: Message finished MID 2317877 done

```

Example of External Threat Feeds Mail Logs

The Mail Logs contain information about threats detected in incoming messages and actions taken on such messages. Most information is at the Info or Debug level.

```

Thu Jun 7 20:48:10 2018 Info: MID 91 Threat feeds source 'S1' detected malicious URL:
'http://digimobil.mobi/' in attachment(s): malurl.txt. Action: Attachment stripped

```

Examples of SDR Filtering Log Entries

The SDR filtering information is posted to the Mail Logs. Most information is at the Info or Debug level.

- [Sender Domain Reputation Authentication Failure, on page 322](#)
- [Sender Domain Reputation Request Timeout, on page 322](#)
- [Sender Domain Reputation Invalid Host, on page 323](#)
- [Sender Domain Reputation General Errors, on page 323](#)

Sender Domain Reputation Authentication Failure

In this example, the log shows a message that was not filtered based on SDR because of an authentication failure when connecting to the SDR service.

```

Mon Jul 2 08:57:18 2018 Info: New SMTP ICID 3 interface Management (192.0.2.10) address
224.0.0.10 reverse dns host unknown verified no
Mon Jul 2 08:57:18 2018 Info: ICID 3 ACCEPT SG UNKNOWNLIST match ipr[none] ipr not enabled
country not enabled
Mon Jul 2 08:57:18 2018 Info: Start MID 3 ICID 3
Mon Jul 2 08:57:18 2018 Info: MID 3 ICID 3 From: <sender1@example.com>
Mon Jul 2 08:57:18 2018 Info: MID 3 ICID 3 RID 0 To: <recipient1@example.com>
Mon Jul 2 08:57:18 2018 Info: MID 3 Message-ID '<000001cba32e5ff24ff2e0$d6efd8a0$@com>' Mon
Jul 2 08:57:18 2018 Info: MID 3 Subject 'Message 001'
Mon Jul 2 08:57:19 2018 Info: MID 3 SDR: Message was not scanned for Sender Domain Reputation.
Reason: Authentication failure.

```

Solution

Use the `sdradvancedconfig` command in the CLI to configure the required parameters when connecting your email gateway to the SDR service.

Sender Domain Reputation Request Timeout

In this example, the log shows a message that was not filtered based on SDR because of a request timeout error when communicating with the SDR service.

```
Mon Jul 2 09:00:13 2018 Info: New SMTP ICID 4 interface Management (192.0.2.10) address
224.0.0.10 reverse dns host unknown verified no
Mon Jul 2 09:00:13 2018 Info: ICID 4 ACCEPT SG UNKNOWNLIST match ipr[none] ipr not enabled
country not enabled
Mon Jul 2 09:00:13 2018 Info: Start MID 4 ICID 4
Mon Jul 2 09:00:13 2018 Info: MID 4 ICID 4 From: <sender1@example.com>
Mon Jul 2 09:00:13 2018 Info: MID 4 ICID 4 RID 0 To: <recipient1@example.com >
Mon Jul 2 09:00:13 2018 Info: MID 4 Message-ID '<000001cba32e$f24ff2e0$d6efd8a0$@com>'
Mon Jul 2 09:00:13 2018 Info: MID 4 Subject 'Message 001'
Mon Jul 2 09:00:13 2018 Info: MID 4 SDR: Message was not scanned for Sender Domain Reputation.
Reason: Request timed out.
```

Solution

When an SDR request times out, the message is marked as unscannable, and the configured actions are applied to the message.

Sender Domain Reputation Invalid Host

In this example, the log shows a message that was not filtered based on SDR because an invalid SDR service host was configured on your email gateway.

```
Mon Jul 2 09:04:08 2018 Info: ICID 7 ACCEPT SG UNKNOWNLIST match ipr[none] ipr not enabled
country not enabled
Mon Jul 2 09:04:08 2018 Info: Start MID 7 ICID 7
Mon Jul 2 09:04:08 2018 Info: MID 7 ICID 7 From: <sender1@example.com >
Mon Jul 2 09:04:08 2018 Info: MID 7 ICID 7 RID 0 To: <recipient1@example.com >
Mon Jul 2 09:04:08 2018 Info: MID 7 Message-ID '<000001cba32e$f24ff2e0$d6efd8a0$@com>' Mon
Jul 2 09:04:08 2018 Info: MID 7 Subject 'Message 001'
Mon Jul 2 09:04:08 2018 Info: MID 7 SDR: Message was not scanned for Sender Domain Reputation.
Reason: Invalid host configured.
```

Solution

Use the `sdradvancedconfig` command in the CLI to configure the required parameters when connecting your email gateway to the SDR service.

Sender Domain Reputation General Errors

In this example, the log shows a message that was not filtered based on SDR because of an unknown error.

```
Mon Jul 2 09:00:13 2018 Info: New SMTP ICID 4 interface Management (192.0.2.10) address
224.0.0.10 reverse dns host unknown verified no
Mon Jul 2 09:00:13 2018 Info: ICID 4 ACCEPT SG UNKNOWNLIST match ipr[none] ipr not enabled
country not enabled
Mon Jul 2 09:00:13 2018 Info: Start MID 4 ICID 4
Mon Jul 2 09:00:13 2018 Info: MID 4 ICID 4 From: <sender1@example.com >
Mon Jul 2 09:00:13 2018 Info: MID 4 ICID 4 RID 0 To: <recipient1@example.com >
Mon Jul 2 09:00:13 2018 Info: MID 4 Message-ID '<000001cba32e$f24ff2e0$d6efd8a0$@com>'
Mon Jul 2 09:00:13 2018 Info: MID 4 Subject 'Test mail'
Mon Jul 2 09:00:13 2018 Info: MID 4 SDR: Message was not scanned for Sender Domain Reputation.
Reason: Unknown error.
```

Solution

When an unknown error occurs, the message is marked as unscannable, and the configured actions are applied to the message.

Cisco Advanced Phishing Protection Cloud Service Expired

In this example, the log shows that the Cisco Advanced Phishing Protection Cloud Service expired.

```
Wed May 6 11:47:45 2020 Critical: The Cisco Advanced
Phishing Protection Cloud Service has expired and is disabled. Contact
your Cisco Account Manager to renew the service and enable it.
```

Solution: You need to contact your Cisco Account Manager to renew the service and enable it.

Reminder about Cisco Advanced Phishing Protection Cloud Service Expiry Date

In this example, the log shows that the Cisco Advanced Phishing Protection Cloud Service will expire on a particular date.

```
Fri May 8 04:50:26 2020 Info: Cisco Advanced
Phishing Protection Cloud Service expires on
2020-05-10 07:00:00. You need to contact your Cisco Account
Manager to renew the service
```

Solution: You need to contact your Cisco Account Manager to renew the service.

No API Access UID and API Access Secret Key

In this example, the log shows that the appliance was unable to poll for the Cisco Advanced Phishing Protection Cloud Service expiry date because of no API Access UID and API Access Secret key.

```
Wed May 6 17:52:52 2020 Critical: Failed to poll
for the Cisco Advanced Phishing Protection Cloud Service
expiry date. You need to add the API Access UID and API Access
secret key.
```

Solution: You need to add the API Access UID and API Access secret key.

Invalid API Access UID or API Access Secret Key

In this example, the log shows that the appliance was unable to poll for the Cisco Advanced Phishing Protection Cloud Service expiry date because of an invalid API Access UID and API Access Secret key.

```
Wed May 6 17:52:52 2020 Critical: Failed to poll
for the Cisco Advanced Phishing Protection Cloud Service
expiry date because the API Access Key is invalid. You need
to re-configure the API Access UID and secret key
```

Solution: You need to re-configure the API Access UID and secret key.

Using Delivery Logs

Delivery logs record critical information about the email delivery operations of AsyncOS. The log messages are “stateless,” meaning that all associated information is recorded in each log message and users need not reference previous log messages for information about the current delivery attempt.

The delivery log records all information pertaining to email delivery operations for each recipient. All information is laid out in a logical manner and is human-readable after conversion using a utility provided by

Cisco. The conversion tools are located at: <https://supportforums.cisco.com/document/33721/cisco-ironport-systems-contributed-tools>

Delivery logs are recorded and transferred in a binary format for resource efficiency. Information recorded in delivery logs is shown in the following table:

Table 125: Delivery Log Statistics

| Statistic | Description |
|-----------------|--|
| Delivery status | Success (message was successfully delivered) or bounce (message was hard bounced) |
| Del_time | Delivery time |
| Inj_time | Injection time. $\text{del_time} - \text{inj_time}$ = time the recipient message stayed in the queue |
| Bytes | Message size |
| Mid | Message ID |
| Ip | Recipient host IP. The IP address of the host that received or bounced the recipient message |
| From | Envelope From, also known as Envelope Sender or MAIL FROM |
| Source_ip | Source host IP. The IP address of the host of the incoming message |
| Code | SMTP response code from recipient host |
| Reply | SMTP response message from recipient host |
| Rcpt Rid | Recipient ID. Recipient ID starts with <0>, messages with multiple recipients will have multiple recipient IDs |
| To | Envelope To |
| Attempts | Number of delivery attempts |

If the delivery status was bounce, this additional information appears in the delivery log:

Table 126: Delivery Log Bounce Information

| Statistic | Description |
|-----------|--|
| Reason | RFC 1893 Enhanced Mail Status Code interpretation of the SMTP response during the delivery |
| Code | SMTP response code from recipient host |
| Error | SMTP response message from recipient host |

If you have set up logheaders (see [Logging Message Headers, on page 1175](#)), the header information appears after the delivery information:

Table 127: Delivery Log Header Information

| Statistic | Description |
|---------------|---|
| Customer_data | XML tag marking the beginning of logged headers |
| Header Name | Name of the header |
| Value | Contents of the logged header |

Examples of Delivery Log Entries

The examples in this section show a variety of Delivery Log entries.

Successful Message Delivery

```
Mon Mar 31 20:10:58 2003 Info: New SMTP DCID 5 interface 172.19.0.11 address
63.251.108.110

Mon Mar 31 20:10:58 2003 Info: Delivery start DCID 5 MID 4 to RID [0]

Mon Mar 31 20:10:58 2003 Info: Message done DCID 5 MID 4 to RID [0]

Mon Mar 31 20:11:03 2003 Info: DCID 5 close
```

Delivery Status Bounce

```
<bounce del_time="Sun Jan 05 08:28:33.073 2003" inj_time="Mon Jan 05 08:28:32.929 2003"
bytes="4074" mid="94157762" ip="0.0.0.0" from="campaign1@yourdomain.com"
source_ip="192.168.102.1" reason="5.1.0 - Unknown address error" code="550"
error=["Requested action not taken: mailbox unavailable"]">

<rcpt rid="0" to="user@sampledomain.com" attempts="1" />

</bounce>
```

Delivery Log Entry with Logheaders

```
<success del_time="Tue Jan 28 15:56:13.123 2003" inj_time="Tue Jan 28 15:55:17.696 2003"
bytes="139" mid="202" ip="10.1.1.13" from="campaign1@yourdomain.com"
source_ip="192.168.102.1" code="250" reply="sent">

<rcpt rid="0" to="user@sampledomain.com" attempts="1" />

<customer_data>

<header name="xname" value="sh"/>

</customer_data>

</success>
```

Using Bounce Logs

The bounce log records all information pertaining to each bounced recipient. Information recorded in bounce logs is shown in the following table:

Table 128: Bounce Log Statistics

Statistic	Description
Timestamp	The time of the bounce event
Log level	The level of detail in this bounce log
Bounce type	Bounced or delayed (for example, hard or soft-bounce)
MID/RID	Message ID and recipient ID
From	Envelope From
To	Envelope To
Reason	RFC 1893 Enhanced Mail Status Code interpretation of the SMTP response during the delivery
Response	SMTP response code and message from recipient host

In addition, if you have specified message size to log or setup **logheaders** (see [Logging Message Headers, on page 1175](#)), the message and header information will appear after the bounce information:

Table 129: Bounce Log Header Information

Header	The header name and content in the header
Message	Content of the message logged

Examples of Bounce Log Entries

Soft-Bounced Recipient (Bounce Type = Delayed)

```
Thu Dec 26 18:37:00 2003 Info: Delayed: 44451135:0
From:<campaign1@yourdomain.com> To:<user@sampledomain.com>
```

```
Reason: "4.1.1.0 - Unknown address error" Response: "('451',
['<user@sampledomain.com> Automated block triggered by suspicious
activity from your IP address (10.1.1.1). Have your system administrator
send e-mail to postmaster@sampledomain.com if you believe this block is
in error'])"
```

Hard-Bounced Recipient (Bounce Type = Bounced)

```
Thu Dec 26 18:36:59 2003 Info: Bounced: 45346670:0 From:<campaign1@yourdomain.com>
To:<user2@sampledomain.com>
```

```
Reason: "5.1.0 - Unknown address error" Response: "('550', ['There is no such active
account.'])"
```

Bounce Log with Message Body and Logheaders

```
Wed Jan 29 00:06:30 2003 Info: Bounced: 203:0 From:<campaign1@yourdomain.com>
To:<user@sampledomain.com>
```

```
Reason:"5.1.2 - Bad destination host" Response: "('000', [])" Headers: ['xname:
userID2333']' Message: Message-Id:
```

```
<1u5jak$6b@yourdomain.com>\015\012xname: userID2333\015\012subject:
Greetings.\015\012\015\012Hi Tom:'
```



Note The text string \015\012 represents a line break (for example, CRLF).

Using Status Logs

Status logs record system statistics found in the CLI status commands, including `status`, `status detail`, and `dnsstatus`. The period of recording is set using the `setup` subcommand in `logconfig`. Each counter or rate reported in status logs is the value since the last time the counter was reset.

Reading Status Logs

The following table shows the status log labels and the matching system statistics.

Table 130: Status Log Statistics

Statistic	Description
CPULd	CPU Utilization
DskIO	Disk I/O Utilization
RAMUtil	RAM Utilization
QKUsd	Queue Kilobytes Used
QKFre	Queue Kilobytes Free
CrtMID	Message ID (MID)
CrtICID	Injection Connection ID (ICID)
CRTDCID	Delivery Connection ID (DCID)
InjBytes	Total Injected Message Size in Bytes
InjMsg	Injected Messages
InjRcp	Injected Recipients

Statistic	Description
GenBncRcp	Generated Bounce Recipients
RejRcp	Rejected Recipients
DrpMsg	Dropped Messages
SftBncEvt	Soft Bounced Events
CmpRcp	Completed Recipients
HrdBncRcp	Hard Bounced Recipients
DnsHrdBnc	DNS Hard Bounces
5XXHrdBnc	5XX Hard Bounces
FltrHrdBnc	Filter Hard Bounces
ExpHrdBnc	Expired Hard Bounces
OtrHrdBnc	Other Hard Bounces
DlvRcp	Delivered Recipients
DelRcp	Deleted Recipients
GlbUnsbHt	Global Unsubscribe Hits
ActvRcp	Active Recipients
UnatmptRcp	Unattempted Recipients
AtmptRcp	Attempted Recipients
CrtCncIn	Current Inbound Connections
CrtCncOut	Current Outbound Connections
DnsReq	DNS Requests
NetReq	Network Requests
CchHit	Cache Hits
CchMis	Cache Misses
CchEct	Cache Exceptions
CchExp	Cache Expired
CPUTm	Total CPU time used by the application
CPUETm	Elapsed time since the application started
MaxIO	Maximum disk I/O operations per second for the mail process

Statistic	Description
RamUsd	Allocated memory in bytes
SwIn	Memory swapped in.
SwOut	Memory swapped out.
SwPgIn	Memory paged in.
SwPgOut	Memory paged out.
MMLen	Total number of messages in the system
DstInMem	Number of destination objects in memory
ResCon	Resource conservation tarpit value. Acceptance of incoming mail is delayed by this number of seconds due to heavy system load
WorkQ	This is the number of messages currently in the work queue
QuarMsgs	Number of individual messages in policy, virus, or outbreak quarantine (messages present in multiple quarantines are counted only once)
QuarQKUsd	KBytes used by policy, virus, and outbreak quarantine messages
LogUsd	Percent of log partition used
SophLd	Percent CPU used by Sophos anti-virus scanning
McafLd	Percent CPU used by McAfee anti-virus scanning
CASELd	Percent CPU used by CASE scanning
TotalLd	Total CPU consumption
LogAvail	Amount of disk space available for log files
EuQ	Estimated number of messages in the Spam quarantine
EuqRls	Estimated number of messages in the Spam quarantine release queue
RptLD	CPU load during the Reporting process
QtnLd	CPU load during the Quarantine process
EncrQ	Messages in the Encryption Queue

Status Log Example

```

Fri Feb 28 12:11:48 2020 Info: Status: CPULd 45 DskIO 22 RAMUtil 22 QKUsd 6676975
QKFre 1711633 CrtMID 6130195 CrtICID 722770 CrtDCID 54 InjMsg 4572789 InjRcp
4575323 GenBncRcp 255536 RejRcp 20388 DrpMsg 469642 SftBncEvt 0 CmpRcp 3650806 HrdBncRcp
255536
DnsHrdBnc 23 5XXHrdBnc 28 FltrHrdBnc 255485 ExpHrdBnc 0
OtrHrdBnc 0 DlvRcp 3394965 DelRcp 305 GlbUnsbHt 0 ActvRcp 65 UnatmptRcp 65 AtmptRcp 0
CrtCncIn 9

```

```

CrtCncOut 0 DnsReq 7756744 NetReq 7769130 CchHit 8373490 CchMis
1989637 CchEct 1625236 CchExp 1569329 CPUTm 37 CPUETm 62 MaxIO 465600 RAMUsd 1473355956
MMLen 54782
DstInMem 11 ResCon 0 WorkQ 54710 QuarMsgs 375
QuarQKUsd 145096 LogUsd 26 SophLd 15 BMLd 0 CASELd 0 TotalLd 100 LogAvail 116G EuQ 64 EuqRls
0 CmrkLd 0
McafLd 9 SwIn 122 SwOut 5295 SwPgIn 368 SwPg Out 63639
SwapUsage 4% RptLd 0 QtnLd 19 EncrQ 0 InjBytes 516664777890

```

Using Domain Debug Logs

Domain debug logs record the client and server communication during an SMTP conversation between the appliance and a specified recipient host. This log type is primarily used to debug issues with specific recipient hosts.

Table 131: Domain Debug Log Statistics

Statistic	Description
Timestamp	The time of the bounce event
Log level	The level of detail in this bounce log
From	Envelope From
To	Envelope To
Reason	RFC 1893 Enhanced Mail Status Code interpretation of the SMTP response during the delivery
Response	SMTP response code and message from recipient host

Domain Debug Log Example

```

Sat Dec 21 02:37:22 2003 Info: 102503993 Sent: 'MAIL FROM:<daily@dailyf-y-i.net>'
Sat Dec 21 02:37:23 2003 Info: 102503993 Rcvd: '250 OK'
Sat Dec 21 02:37:23 2003 Info: 102503993 Sent: 'RCPT TO:<LLLSMILE@aol.com>'
Sat Dec 21 02:37:23 2003 Info: 102503993 Rcvd: '250 OK'
Sat Dec 21 02:37:23 2003 Info: 102503993 Sent: 'DATA'
Sat Dec 21 02:37:24 2003 Info: 102503993 Rcvd: '354 START MAIL INPUT, END WITH "." ON A
LINE BY ITSELF'
Sat Dec 21 02:37:24 2003 Info: 102503993 Rcvd: '250 OK'

```

Using Injection Debug Logs

Injection debug logs record the SMTP conversation between the appliance and a specified host connecting to the system. Injection debug logs are useful for troubleshooting communication problems between the appliance and a client initiating a connection from the Internet. The log records all bytes transmitted between the two systems and classifies them as “Sent to” the connecting host or “Received from” the connecting host.

You must designate the host conversations to record by specifying an IP address, an IP range, hostname, or partial hostname. Any connecting IP address within an IP range will be recorded. Any host within a partial domain will be recorded. The system performs reverse DNS lookups on connecting IP addresses to convert to hostnames. IP addresses without a corresponding PTR record in DNS will not match hostnames.

You must also specify the number of sessions to record.

Each line within an Injection Debug log contains the following information in the following table.

Table 132: Injection Debug Log Statistics

Statistic	Description
Timestamp	Time that the bytes were transmitted
ICID	The Injection Connection ID is a unique identifier that can be tied to the same connection in other log subscriptions
Sent/Received	Lines marked with “Sent to” are the actual bytes sent to the connecting host. Lines marked with “Received from” are the actual bytes received from the connecting host
IP Address	IP address of the connecting host

Injection Debug Log Example

```

Wed Apr 2 14:30:04 2003 Info: 6216 Sent to '172.16.0.22': '220 postman.example.com
ESMTP\015\012'

Wed Apr 2 14:30:04 2003 Info: 6216 Rcvd from '172.16.0.22': 'HELO
mail.remotehost.com\015\012'
Wed Apr 2 14:30:04 2003 Info: 6216 Sent to '172.16.0.22': '250
postman.example.com\015\012'
Wed Apr 2 14:30:04 2003 Info: 6216 Rcvd from '172.16.0.22': 'MAIL
FROM:<sender@remotehost.com>\015\012'
Wed Apr 2 14:30:04 2003 Info: 6216 Sent to '172.16.0.22': '250 sender
<sender@remotehost.com> ok\015\012'
Wed Apr 2 14:30:04 2003 Info: 6216 Rcvd from '172.16.0.22': 'RCPT
TO:<recipient@example.com>\015\012'
Wed Apr 2 14:30:04 2003 Info: 6216 Sent to '172.16.0.22': '250 recipient
<recipient@example.com> ok\015\012'
Wed Apr 2 14:30:04 Info: 6216 Rcvd from '172.16.0.22': 'DATA\015\012'

Wed Apr 2 14:30:04 2003 Info: 6216 Sent to '172.16.0.22': '354 go ahead\015\012'
Wed Apr 2 14:30:04 2003 Info: 6216 Rcvd from '172.16.0.22': 'To:
recipient@example.com\015\012Date: Apr 02 2003 10:09:44\015\012Subject: Test
Subject\015\012From: Sender <sender@remotehost.com>\015\012'

Wed Apr 2 14:30:04 2003 Info: 6216 Rcvd from '172.16.0.22': 'This is the content of the
message'
Wed Apr 2 14:30:04 Info: 6216 Sent to '172.16.0.22': '250 ok\015\012'

Wed Apr 2 14:30:04 Info: 6216 Rcvd from '172.16.0.22': 'QUIT\015\012'
Wed Apr 2 14:30:04 2003 Info: 6216 Sent to '172.16.0.22': '221
postman.example.com\015\012'

```

Using System Logs

Table 133: System Log Statistics

Statistic	Description
Timestamp	Time that the bytes were transmitted
Message	The logged event

System Log Example

In this example, the System log shows some commit entries, including the name of the user issuing the commit and the comment entered.

```
Wed Sep 8 18:02:45 2004 Info: Version: 4.0.0-206 SN: XXXXXXXXXXXXX-XXX
Wed Sep 8 18:02:45 2004 Info: Time offset from UTC: 0 seconds
Wed Sep 8 18:02:45 2004 Info: System is coming up
Wed Sep 8 18:02:49 2004 Info: bootstrapping DNS cache
Wed Sep 8 18:02:49 2004 Info: DNS cache bootstrapped
Wed Sep 8 18:13:30 2004 Info: PID 608: User admin commit changes: SSW>Password
Wed Sep 8 18:17:23 2004 Info: PID 608: User admin commit changes: Completed Web::SSW
Thu Sep 9 08:49:27 2004 Info: Time offset from UTC: -25200 seconds
Thu Sep 9 08:49:27 2004 Info: PID 1237: User admin commit changes: Added a second CLI
log for examples
Thu Sep 9 08:51:53 2004 Info: PID 1237: User admin commit changes: Removed example CLI
log.
```

Using CLI Audit Logs

Table 134: CLI Audit Log Statistics

Statistic	Description
Timestamp	Time that the bytes were transmitted
PID	Process ID for the particular CLI session in which the command was entered
Message	The message consists of the CLI command entered, the CLI output (including menus, lists, etc.), and the prompt that is displayed

CLI Audit Log Example

In this example, the CLI Audit log shows that, for PID 16434, the following CLI commands were entered: who , textconfig .

```
Thu Sep 9 14:35:55 2004 Info: PID 16434: User admin entered 'who'; prompt was
'\nmail3.example.com> '
```

```
Thu Sep 9 14:37:12 2004 Info: PID 16434: User admin entered 'textconfig'; prompt was
'\nUsername Login Time Idle Time Remote Host What\n=====
=====
===== \nadmin Wed 11AM 3m 45s 10.1.3.14 tail\nadmin 02:32PM
0s 10.1.3.14 cli\nmail3.example.com> '
```

```
Thu Sep 9 14:37:18 2004 Info: PID 16434: User admin entered ''; prompt was '\nThere are
no text resources currently defined.\n\n\nChoose the operation you want to perform:\n-
NEW - Create a new text resource.\n- IMPORT - Import a text resource from a file.\n[> '
```

Using FTP Server Logs

Table 135: FTP Server Log Statistics

Statistic	Description
Timestamp	Time that the bytes were transmitted
ID	Connection ID. A separate ID for each FTP connection
Message	The message section of the log entry can be logfile status information, or FTP connection information (login, upload, download, logout, etc.)

FTP Server Log Example

In this example, the FTP Server log records a connection (ID:1). The IP address of the incoming connection is shown, as well as the activity (uploading and downloading files) and the logout.

```
Wed Sep 8 18:03:06 2004 Info: Begin Logfile
Wed Sep 8 18:03:06 2004 Info: Version: 4.0.0-206 SN: 00065BF3BA6D-9WFWC21
Wed Sep 8 18:03:06 2004 Info: Time offset from UTC: 0 seconds
Wed Sep 8 18:03:06 2004 Info: System is coming up
Fri Sep 10 08:07:32 2004 Info: Time offset from UTC: -25200 seconds
Fri Sep 10 08:07:32 2004 Info: ID:1 Connection from 10.1.3.14 on 172.19.0.86
Fri Sep 10 08:07:38 2004 Info: ID:1 User admin login SUCCESS
Fri Sep 10 08:08:46 2004 Info: ID:1 Upload wording.txt 20 bytes
Fri Sep 10 08:08:57 2004 Info: ID:1 Download words.txt 1191 bytes
Fri Sep 10 08:09:06 2004 Info: ID:1 User admin logout
```

Using HTTP Logs

Table 136: HTTP Log Statistics

Statistic	Description
Timestamp	Time that the bytes were transmitted
ID	Session ID
req	IP address of machine connecting
user	Username of user connecting
Message	Information regarding the actions performed. May include GET or POST commands or system status, etc.

HTTP Log Example

In this example, the HTTP log shows the admin user's interaction with the GUI (running the System Setup Wizard, etc.).

```

Wed Sep 8 18:17:23 2004 Info: http service on 192.168.0.1:80 redirecting to https port 443

Wed Sep 8 18:17:23 2004 Info: http service listening on 192.168.0.1:80

Wed Sep 8 18:17:23 2004 Info: https service listening on 192.168.0.1:443

Wed Sep 8 11:17:24 2004 Info: Time offset from UTC: -25200 seconds

Wed Sep 8 11:17:24 2004 Info: req:10.10.10.14 user:admin id:iaCkEh2h5rZknQarAecg POST
/system_administration/system_setup_wizard HTTP/1.1 303

Wed Sep 8 11:17:25 2004 Info: req:10.10.10.14 user:admin id:iaCkEh2h5rZknQarAecg GET
/system_administration/ssw_done HTTP/1.1 200

Wed Sep 8 11:18:45 2004 Info: req:10.10.10.14 user:admin id:iaCkEh2h5rZknQarAecg GET
/monitor/incoming_mail_overview HTTP/1.1 200

Wed Sep 8 11:18:45 2004 Info: req:10.10.10.14 user:admin id:iaCkEh2h5rZknQarAecg GET
/monitor/mail_flow_graph?injector=&width=365&interval=0&type=recipientsin&height=190
HTTP/1.1 200

Wed Sep 8 11:18:46 2004 Info: req:10.10.10.14 user:admin id:iaCkEh2h5rZknQarAecg GET
/monitor/classification_graph?injector=&width=325&interval=0&type=recipientsin&height=19
0 HTTP/1.1 200

Wed Sep 8 11:18:49 2004 Info: req:10.10.10.14 user:admin id:iaCkEh2h5rZknQarAecg GET
/monitor/quarantines HTTP/1.1 200

```

Using NTP Logs

Table 137: NTP Log Statistics

Statistic	Description
Timestamp	Time that the bytes were transmitted
Message	The message consists of either a Simple Network Time Protocol (SNTP) query to the server, or an adjust: message

NTP Log Example

In this example, the NTP log shows the appliance polling the NTP host twice.

```
Thu Sep 9 07:36:39 2004 Info: sntp query host 10.1.1.23 delay 653 offset -652
Thu Sep 9 07:36:39 2004 Info: adjust: time_const: 8 offset: -652us next_poll: 4096
Thu Sep 9 08:44:59 2004 Info: sntp query host 10.1.1.23 delay 642 offset -1152
Thu Sep 9 08:44:59 2004 Info: adjust: time_const: 8 offset: -1152us next_poll: 4096
```

Using Scanning Logs

The scanning log contains all LOG and COMMON messages for the appliance's scanning engines. See the Alerts section of the “System Administration” chapter for a list of available the COMMON and LOG alert messages.

Table 138: Scanning Log Statistics

Statistic	Description
Timestamp	Time that the bytes were transmitted
Message	The message consists of an application fault, sent alert, failed alert, or log error message for one of the scanning engines.

Scanning Log Example

In this example, the log shows the history of an appliance sending a warning alert concerning Sophos anti-virus.

```
Wed Feb 23 22:05:48 2011 Info: Internal SMTP system attempting to send a message to
alerts@example.com with subject 'Warning <Anti-Virus> mail3.example.com: sophos
antivirus - The Anti-Virus database on this system is...' (attempt #0).
```

```
Wed Feb 23 22:05:48 2011 Info: Internal SMTP system successfully sent a message to
alerts@example.com with subject 'Warning <Anti-Virus> mail3.example.com: sophos
antivirus - The Anti-Virus database on this system is...'.
```

```
Wed Feb 23 22:05:48 2011 Info: A Anti-Virus/Warning alert was sent to alerts@example.com
with subject "Warning <Anti-Virus> mail3.example.com: sophos antivirus - The Anti-Virus
database on this system is...".
```

Using Anti-Spam Logs

Table 139: Anti-Spam Log Statistics

Statistic	Description
Timestamp	Time that the bytes were transmitted
Message	The message consists of the check for the anti-spam updates, as well as the results (whether an update of the engine or the anti-spam rules was needed, etc.)

Anti-Spam Log Example

In this example, the anti-spam log shows the anti-spam engine checking for updates to spam definitions and CASE updates:

```
Fri Apr 13 18:59:47 2007 Info: case antisпам - engine (19103) : case-daemon: server
successfully spawned child process, pid 19111
```

```
Fri Apr 13 18:59:47 2007 Info: case antisпам - engine (19111) : startup: Region profile:
Using profile global
```

```
Fri Apr 13 18:59:59 2007 Info: case antisпам - engine (19111) : fuzzy: Fuzzy plugin v7
successfully loaded, ready to roll
```

```
Fri Apr 13 19:00:01 2007 Info: case antisпам - engine (19110) : uribllocal: running URI
blocklist local
```

```
Fri Apr 13 19:00:04 2007 Info: case antisпам - engine (19111) : config: Finished loading
configuration
```

Using Graymail Logs

Statistic	Description
Timestamp	Time that the bytes were transmitted
Message	The message contains information about the graymail engine, status, configuration, and so on.

Graymail Log Example

```
Tue Mar 24 08:56:45 2015 Info: graymail [BASE] Logging at DEBUG level
```

```
Tue Mar 24 08:56:45 2015 Info: graymail [HANDLER] Initializing request handler
```

```
Tue Mar 24 08:56:50 2015 Info: graymail [ENGINE] Loaded graymail scanner library
```

```
Tue Mar 24 08:56:50 2015 Info: graymail [ENGINE] Created graymail scanner instance
```

```
Tue Mar 24 08:56:50 2015 Info: graymail [HANDLER] Debug mode disabled on graymail process
```

```
Tue Mar 24 08:56:50 2015 Info: graymail [HANDLER] Starting thread WorkerThread_0
```

Using Anti-Virus Logs

Table 140: AntiVirus Log Statistics

Statistic	Description
Timestamp	Time that the bytes were transmitted
Message	The message consists of the check for the anti-virus update, as well as the results (whether an update of the engine or the virus definitions was needed, etc.)

Anti-Virus Log Example

In this example, the Anti-Virus log shows the Sophos anti-virus engine checking for updates to virus definitions (IDE) and the engine itself.

```
Thu Sep 9 14:18:04 2004 Info: Checking for Sophos Update
```

```
Thu Sep 9 14:18:04 2004 Info: Current SAV engine ver=3.84. No engine update needed
```

```
Thu Sep 9 14:18:04 2004 Info: Current IDE serial=2004090902. No update needed.
```

You can temporarily set this to DEBUG level to help diagnose why the anti-virus engine returns a particular verdict for a given message. The DEBUG logging information is verbose; use with caution.

Using AMP Engine Logs

The AMP Engine logs contain details of:

- File reputation query sent to the file reputation server and response received from the file reputation server.
- File analysis, if the file is uploaded to file analysis server. The status of the file analysis is recorded periodically until a response is received from the file analysis server.

Examples of AMP Engine Log Entries

Following are sample AMP Engine log entries based on certain scenarios:

- [Initialization of File Reputation and File Analysis Servers, on page 1150](#)
- [File Reputation Server Not Configured, on page 1151](#)
- [Initialization of File Reputation Query, on page 1151](#)
- [Response Received for File Reputation Query from File Reputation Server, on page 1151](#)
- [File Uploaded for Analysis and File Analysis Process, on page 1152](#)
- [File Not Uploaded for Analysis, on page 1153](#)
- [File Upload Skipped for File Analysis due to File Upload Limit , on page 1153](#)
- [File Upload Skipped for File Analysis due to File Analysis Server Error, on page 1154](#)
- [File Retrospective Verdict Received, on page 1154](#)

Initialization of File Reputation and File Analysis Servers

```
Wed Oct 5 15:17:31 2016 Info: File reputation service initialized successfully
Wed Oct 5 15:17:31 2016 Info: The following file type(s) can be sent for File Analysis:
Microsoft Windows / DOS Executable, Microsoft Office 97-2004 (OLE), Microsoft Office 2007+
```

(Open XML), Other potentially malicious file types, Adobe Portable Document Format (PDF). To allow analysis of new file type(s), go to Security Services > File Reputation and Analysis.
 Wed Oct 5 15:17:31 2016 Info: File Analysis service initialized successfully

File Reputation Server Not Configured

Tue Oct 4 23:15:24 2016 Warning: MID 12 reputation query failed for attachment 'Zombies.pdf' with error "Cloud query failed"

Initialization of File Reputation Query

Fri Oct 7 09:44:04 2016 Info: File reputation query initiating. File Name = 'mod-6.exe', MID = 5, File Size = 1673216 bytes, File Type = application/x-dosexec

Statistic	Description
File Name	The name of the file whose SHA-256 hash identifier is sent to the file reputation server. If the file name is not available, it is termed as unknown .
MID	The Message ID used to track messages that flow through the email pipeline.
File Size	The size of the file whose SHA-256 hash identifier is sent to the file reputation server.
File Type	The type of the file whose SHA-256 hash identifier is sent to the file reputation server. Following are the supported file types: <ul style="list-style-type: none"> • Microsoft Windows / DOS Executable • Microsoft Office 97-2004 (OLE) • Microsoft Office 2007+ (Open XML) • Other potentially malicious file types • Adobe Portable Document Format (PDF)

Response Received for File Reputation Query from File Reputation Server

Fri Oct 7 09:44:06 2016 Info: Response received for file reputation query from Cloud. File Name = 'mod-6.exe', MID = 5, Disposition = MALICIOUS, Malware = W32.061DEF69B5-100.SBX.TG, Reputation Score = 73, sha256 = 061def69b5c100e9979610fa5675bd19258b19a7ff538b5c2d230b467c312f19, upload_action = 2

Statistic	Description
File Name	The name of the file whose SHA-256 hash identifier is sent to the file reputation server. If the file name is not available, it is termed as unknown .
MID	The message ID used to track messages that flow through the email pipeline.

Statistic	Description
Disposition	The file reputation disposition values are: <ul style="list-style-type: none"> • MALICIOUS • CLEAN • FILE UNKNOWN - When the reputation score is zero. • VERDICT UNKNOWN - When the disposition is FILE UNKNOWN and score is non-zero. • LOW RISK - When no dynamic content is found in a file after file analysis, the verdict is Low Risk. The file is not sent for file analysis, and the message continues through the email pipeline.
Malware	The name of the malware threat.
Reputation score	The reputation score assigned to the file by the file reputation server. If the file disposition is VERDICT UNKNOWN , the appliance adjusts the file reputation verdict based on the reputation score and the threshold value.
Upload Action	The upload action value recommended by the file reputation server to take on the given file: <ul style="list-style-type: none"> • 0 - Need not send for upload • 1 - Send file for upload. <p>Note The appliance uploads the file when the upload action value is '1.'</p> <ul style="list-style-type: none"> • 2 - Do not send file for upload • 3 - Send only metadata for upload

File Uploaded for Analysis and File Analysis Process

Wed Sep 28 11:31:58 2016 Info: File uploaded for analysis. SHA256:
e7ae35a8227b380ca761c0317e814e4aaa3d04f362c6b913300117241800f0ea

Wed Sep 28 11:36:58 2016 Info: File Analysis is running for SHA:
e7ae35a8227b380ca761c0317e814e4aaa3d04f362c6b913300117241800f0ea

Fri Oct 7 07:39:13 2016 Info: File Analysis complete. SHA256:
16454aff5082c2e9df43f3e3b9cdba3c6ae1766416e548c30a971786db570bfc, Submit Timestamp:
1475825466, Update Timestamp: 1475825953, Disposition: 3 Score: 100, run_id: 194926004
Details: Analysis is completed for the File
SHA256[16454aff5082c2e9df43f3e3b9cdba3c6ae1766416e548c30a971786db570bfc]
Spyname: [W32.16454AFF50-100.SBX.TG]

Statistic	Description
SHA256	The SHA-256 hash identifier for the corresponding file.
Submit Timestamp	The date and time at which the file is uploaded to the file analysis server by the appliance .
Update Timestamp	The date and time at which the file analysis for the file is complete

Statistic	Description
Disposition	The file reputation disposition values are. <ul style="list-style-type: none"> • 1 - No malware detected • 2 - Clean • 3 - Malware
Score	The analysis score assigned to the file by the file analysis server.
Run ID	The numeric value (ID) assigned to the file by the file analysis server for a particular file analysis.
Details	Additional information if errors are reported during file analysis, otherwise it indicates that the final analysis is complete for the file.
Spy Name	The name of the threat, if a malware is found in the file during file analysis.

File Not Uploaded for Analysis

```
Wed Sep 14 12:27:52 2016 Info: File not uploaded for analysis. MID = 0 File
SHA256[a5f28f1fed7c2fe88bcd403710098977fa12c32d13bfd78bbe27e95b245f82] file
mime[text/plain] Reason: No active/dynamic contents exists
```

Statistic	Description
MID	The message ID used to track messages that flow through the email pipeline.
File MIME	The MIME type of the file.
Reason	Following are one of the reason values for file not uploaded to the file analysis server even when the upload_action is set to '1': <ul style="list-style-type: none"> • File already uploaded by another node - The file is already uploaded to the file analysis server via another appliance . • File analysis in progress - File is already selected for upload which is in progress. • File already uploaded to File Analysis server • Not a supported File type • File size is out of bounds - The upload file size exceeds the threshold limit set by the file analysis server. • Upload queue was full • File Analysis server error • No active/dynamic contents exists • Generic/Unknown Error

File Upload Skipped for File Analysis due to File Upload Limit

```
Tue Jun 20 13:22:56 2017 Info: File analysis upload skipped. SHA256:
b5c7e26491983baa713c9a2910ee868efd891661c6a0553b28f17b8fdc8cc3ef, Timestamp[1454782976]
details[File SHA256[b5c7e26491983baa713c9a2910ee868efd891661c6a0553b28f17b8fdc8cc3ef] file
mime[application/pdf], upload priority[Low] not uploaded, re-tries[3], backoff[986]
discarding ...]
Tue Jun 20 13:22:56 2017 Critical: The attachment could not be uploaded to the
```

File Upload Skipped for File Analysis due to File Analysis Server Error

File Analysis server because the appliance exceeded the upload limit

Statistic	Description
SHA256	The SHA-256 hash identifier for the corresponding file.
Timestamp	The date and time at which the file failed to upload to the file analysis server.
Details	Details of the File Analysis server error.
File MIME	The MIME type of the file.
Upload priority	Upload priority values are: <ul style="list-style-type: none"> • High - For all selected file types, except PDF file type. • Low - For only PDF file types
Re-tries	The number of upload attempts performed on a given file. Note A maximum of three upload attempts can be performed on a given file.
Backoff (x)	The number of (x) seconds before the appliance needs to wait before it makes an attempt to upload the file to the file analysis server. This occurs when the appliance reaches the daily upload limit.
Critical (Reason)	The attachment could not be uploaded to the File Analysis server because the appliance exceeded the upload limit.

File Upload Skipped for File Analysis due to File Analysis Server Error

```
Sat Feb 6 13:22:56 2016 Info:SHA256:
69e17e213732da0d0cbc48ae7030a4a18e0c1289f510e8b139945787f67692a5,Timestamp[1454959409]
details[Server Response HTTP code:[502]]
```

Statistic	Description
SHA256	The SHA-256 hash identifier for the corresponding file.
Timestamp	The date and time at which an attempt is made to upload the file to the file analysis server.
Details	Information about the File Analysis server error.

File Retrospective Verdict Received

```
Fri Oct 7 07:39:13 2016 Info: Retrospective verdict received. SHA256:
16454aff5082c2e9df43f3e3b9cdba3c6ae1766416e548c30a971786db570bfc, Timestamp: 1475832815.7,
Verdict: MALICIOUS, Reputation Score: 0, Spyname: W32.16454AFF50-100.SBX.
```

Statistic	Description
SHA256	The SHA-256 hash identifier for the corresponding file.

Statistic	Description
Timestamp	The date and time at which a file retrospective verdict is received from the file analysis server.
Verdict	The file retrospective verdict value is malicious or clean .
Reputation Score	The reputation score assigned to the file by the file reputation server.
Spyname	The name of the threat, if a malware is found in the file during file analysis.

Using Spam Quarantine Logs

Table 141: Spam Log Statistics

Statistic	Description
Timestamp	Time that the bytes were transmitted
Message	The message consists of actions taken (messages quarantined, released from quarantine, etc.).

Spam Quarantine Log Example

In this example, the log shows a message (MID 8298624) being released from the quarantine to admin@example.com.

```
Mon Aug 14 21:41:47 2006 Info: ISQ: Releasing MID [8298624, 8298625] for all
```

```
Mon Aug 14 21:41:47 2006 Info: ISQ: Delivering released MID 8298624 (skipping work queue)
```

```
Mon Aug 14 21:41:47 2006 Info: ISQ: Released MID 8298624 to admin@example.com
```

```
Mon Aug 14 21:41:47 2006 Info: ISQ: Delivering released MID 8298625 (skipping work queue)
```

```
Mon Aug 14 21:41:47 2006 Info: ISQ: Released MID8298625 to admin@example.com
```

Using Spam Quarantine GUI Logs

Table 142: Spam GUI Log Statistics

Statistic	Description
Timestamp	Time that the bytes were transmitted
Message	The message consists of actions taken, including user authentication, etc.

Spam Quarantine GUI Log Example

In this example, the log shows a successful authentication, login and logout:

```

Fri Aug 11 22:05:28 2006 Info: ISQ: Serving HTTP on 192.168.0.1, port 82
Fri Aug 11 22:05:29 2006 Info: ISQ: Serving HTTPS on 192.168.0.1, port 83
Fri Aug 11 22:08:35 2006 Info: Authentication OK, user admin
Fri Aug 11 22:08:35 2006 Info: logout:- user:pqufOtL6vyI5StCqhCfO session:10.251.23.228
Fri Aug 11 22:08:35 2006 Info: login:admin user:pqufOtL6vyI5StCqhCfO
session:10.251.23.228
Fri Aug 11 22:08:44 2006 Info: Authentication OK, user admin

```

Using LDAP Debug Logs

Table 143: LDAP Debug Log Statistics

Statistic	Description
Timestamp	Time that the bytes were transmitted
Message	LDAP Debug message

LDAP Debug Log Example



Note Individual lines in log files are NOT numbered. They are numbered here only for sample purposes

1	Thu Sep 9 12:24:56 2004 Begin Logfile
2	Thu Sep 9 12:25:02 2004 LDAP: Masquerade query sun.masquerade address employee@routing.qa to employee@mail.qa
3	Thu Sep 9 12:25:02 2004 LDAP: Masquerade query sun.masquerade address employee@routing.qa to employee@mail.qa
4	Thu Sep 9 12:25:02 2004 LDAP: Masquerade query sun.masquerade address employee@routing.qa to employee@mail.qa
5	Thu Sep 9 12:28:08 2004 LDAP: Clearing LDAP cache
6	Thu Sep 9 13:00:09 2004 LDAP: Query '(&(ObjectClass={g})(mailLocalAddress={a}))' to server sun (sun.qa:389)
7	Thu Sep 9 13:00:09 2004 LDAP: After substitute, query is '(&(ObjectClass=inetLocalMailRecipient) (mailLocalAddress=rrouete.d00002b.loc@ldap.route.local.add00002.qa))'

8	Thu Sep 9 13:00:09 2004 LDAP: connecting to server
9	Thu Sep 9 13:00:09 2004 LDAP: connected
10	Thu Sep 9 13:00:09 2004 LDAP: Query (&(ObjectClass=inetLocalMailRecipient) (mailLocalAddress=rroute.d00002b.loc@ldap.route.local.add00002.qa)) returned 1 results
11	Thu Sep 9 13:00:09 2004 LDAP: returning: [<LDAP:>]

Use as a guide to reading the preceding log file.

Table 144: Detail of LDAP Debug Log Example

Line Number	Description
1	The log file is initialized.
2	The listener is configured to use LDAP for masquerading, specifically with the LDAP query named "sun.masquerade."
3	
4	The address employee@routing.qa is looked up in the LDAP server, a match is found, and the resulting masquerade address is employee@mail.qa, which will be written to the message headers and/or the envelope from, depending on the masquerade configuration.
5	The user has manually run ldapflush .
6	A query is about to be sent to sun.qa, port 389. The query template is: (&(ObjectClass={g})(mailLocalAddress={a})). The {g} will be replaced by the groupname specified in the calling filter, either a rcpt-to-group or mail-from-group rule. The {a} will be replaced by the address in question.
7	Now the substitution (described previously) takes place, and this is what the query looks like before it is sent to the LDAP server.
8	The connection to the server is not yet established, so make a connection.
9	The data that is sent to the server.
10	The result is an empty positive, meaning one record was returned, but since the query didn't ask for any fields, there is no data to report. These are used for both group and accept queries when the query checks to see if there is a match in the database.

Using Safelist/Blocklist Logs

The following table shows the statistics recorded in safelist/blocklist logs.

Table 145: Safelist/Blocklist Log Statistics

Statistic	Description
Timestamp	Time that the bytes were transmitted.
Message	The message consists of actions taken, including user authentication, and so forth.

Safelist/Blocklist Log Example

In this example, the safelist/blocklist log shows the appliance creating database snapshots every two hours. It also shows when senders were added to the database.

```
Fri Sep 28 14:22:33 2007 Info: Begin Logfile Fri Sep 28 14:22:33 2007 Info: Version:
6.0.0-425 SN: XXXXXXXXXXXX-XXX Fri Sep 28 14:22:33 2007 Info: Time offset from UTC:
10800 seconds Fri Sep 28 14:22:33 2007 Info: System is coming up.
```

```
Fri Sep 28 14:22:33 2007 Info: SLBL: The database snapshot has been created.
```

```
Fri Sep 28 16:22:34 2007 Info: SLBL: The database snapshot has been created.
```

```
Fri Sep 28 18:22:34 2007 Info: SLBL: The database snapshot has been created.
```

```
Fri Sep 28 20:22:34 2007 Info: SLBL: The database snapshot has been created.
```

```
Fri Sep 28 22:22:35 2007 Info: SLBL: The database snapshot has been created.
```

```
.....
```

```
Mon Oct 1 14:16:09 2007 Info: SLBL: The database snapshot has been created.
```

```
Mon Oct 1 14:37:39 2007 Info: SLBL: The database snapshot has been created.
```

```
Mon Oct 1 15:31:37 2007 Warning: SLBL: Adding senders to the database failed.
```

```
Mon Oct 1 15:32:31 2007 Warning: SLBL: Adding senders to the database failed.
```

```
Mon Oct 1 16:37:40 2007 Info: SLBL: The database snapshot has been created.
```

Using Reporting Logs

The following table shows the statistics recorded in reporting logs.

Table 146: Reporting Log Statistics

Statistic	Description
Timestamp	Time that the bytes were transmitted.
Message	The message consists of actions taken, including user authentication, and so forth.

Reporting Log Example

In this example, the Reporting log shows the appliance set at the information log level.

```

Wed Oct 3 13:39:53 2007 Info: Period minute using 0 (KB)
Wed Oct 3 13:39:53 2007 Info: Period month using 1328 (KB)
Wed Oct 3 13:40:02 2007 Info: Update 2 registered appliance at 2007-10-03-13-40
Wed Oct 3 13:40:53 2007 Info: Pages found in cache: 1304596 (99%). Not found: 1692
Wed Oct 3 13:40:53 2007 Info: Period hour using 36800 (KB)
Wed Oct 3 13:40:53 2007 Info: Period day using 2768 (KB)
Wed Oct 3 13:40:53 2007 Info: Period minute using 0 (KB)
Wed Oct 3 13:40:53 2007 Info: Period month using 1328 (KB)
Wed Oct 3 13:40:53 2007 Info: HELPER checkpointed in 0.00580507753533 seconds
Wed Oct 3 13:41:02 2007 Info: Update 2 registered appliance at 2007-10-03-13-41
Wed Oct 3 13:41:53 2007 Info: Pages found in cache: 1304704 (99%). Not found: 1692
Wed Oct 3 13:41:53 2007 Info: Period hour using 36800 (KB)
Wed Oct 3 13:41:53 2007 Info: Period day using 2768 (KB)
Wed Oct 3 13:41:53 2007 Info: Period minute using 0 (KB)
Wed Oct 3 13:41:53 2007 Info: Period month using 1328 (KB)
Wed Oct 3 13:42:03 2007 Info: Update 2 registered appliance at 2007-10-03-13-42

```

Using Reporting Query Logs

The following table shows the statistics recorded in reporting query logs.

Table 147: Reporting Query Log Statistics

Statistic	Description
Timestamp	Time that the bytes were transmitted.
Message	The message consists of actions taken, including user authentication, and so forth.

Reporting Query Log Example

In this example, the reporting query log shows the appliance running a daily outgoing email traffic query for the period from August 29 to October 10, 2007.

```

Tue Oct 2 11:30:02 2007 Info: Query: Closing interval handle 811804479.
Tue Oct 2 11:30:02 2007 Info: Query: Closing interval handle 811804480.
Tue Oct 2 11:30:02 2007 Info: Query: Closing query handle 302610228.
Tue Oct 2 11:30:02 2007 Info: Query: Merge query with handle 302610229 for
['MAIL_OUTGOING_TRAFFIC_SUMMARY.
DETECTED_SPAM', 'MAIL_OUTGOING_TRAFFIC_SUMMARY.DETECTED_VIRUS',

```

```
'MAIL_OUTGOING_TRAFFIC_SUMMARY.THREAT_CONTENT_FILTER',
'MAIL_OUTGOING_TRAFFIC_SUMMARY.TOTAL_CLEAN_RECIPIENTS',
'MAIL_OUTGOING_TRAFFIC_SUMMARY.TOTAL_RECIPIENTS_PROCESSED'] for rollup period "day" with
interval range 2007-08-29 to 2007-10-01
with key constraints
```

```
None sorting on ['MAIL_OUTGOING_TRAFFIC_SUMMARY.DETECTED_SPAM'] returning results from
0 to 2 sort_ascending=False.
```

```
Tue Oct 2 11:30:02 2007 Info: Query: Closing query handle 302610229.
```

```
Tue Oct 2 11:30:02 2007 Info: Query: Merge query with handle 302610230 for
['MAIL_OUTGOING_TRAFFIC_SUMMARY.
```

```
TOTAL_HARD_BOUNCES', 'MAIL_OUTGOING_TRAFFIC_SUMMARY.TOTAL_RECIPIENTS_DELIVERED',
'MAIL_OUTGOING_TRAFFIC_SUMMARY.TOTAL_RECIPIENTS'] for rollup period "day" with interval
range 2007-08-29 to
2007-10-01 with key constraints None sorting on
['MAIL_OUTGOING_TRAFFIC_SUMMARY.TOTAL_HARD_BOUNCES'] returning
results from 0 to 2 sort_ascending=False.
```

```
Tue Oct 2 11:30:02 2007 Info: Query: Closing query handle 302610230.
```

Using Updater Logs

Table 148: Updater Log Statistics

Statistic	Description
Timestamp	Time that the bytes were transmitted.
Message	The message consists of system service update information, as well as AsyncOS checking for updates and the scheduled date and time of the next update.

Updater Log Example

In this example, the logs show the appliance being updated with new McAfee Anti-Virus definitions.

```
Fri Sep 19 11:07:51 2008 Info: Starting scheduled update
Fri Sep 19 11:07:52 2008 Info: Acquired server manifest, starting update 11
Fri Sep 19 11:07:52 2008 Info: Server manifest specified an update for mcafee
Fri Sep 19 11:07:52 2008 Info: mcafee was signalled to start a new update
Fri Sep 19 11:07:52 2008 Info: mcafee processing files from the server manifest
Fri Sep 19 11:07:52 2008 Info: mcafee started downloading files
Fri Sep 19 11:07:52 2008 Info: mcafee downloading remote file
"http://stage-updates.ironport.com/mcafee/dat/5388"
Fri Sep 19 11:07:52 2008 Info: Scheduled next update to occur at Fri Sep 19 11:12:52
2008
Fri Sep 19 11:08:12 2008 Info: mcafee started decrypting files
Fri Sep 19 11:08:12 2008 Info: mcafee decrypting file
"mcafee/dat/5388" with method "des3_cbc"
```

```
Fri Sep 19 11:08:17 2008 Info: mcafee started decompressing files
Fri Sep 19 11:08:17 2008 Info: mcafee started applying files
Fri Sep 19 11:08:17 2008 Info: mcafee applying file "mcafee/dat/5388"
Fri Sep 19 11:08:18 2008 Info: mcafee verifying applied files
Fri Sep 19 11:08:18 2008 Info: mcafee updating the client manifest
Fri Sep 19 11:08:18 2008 Info: mcafee update completed
Fri Sep 19 11:08:18 2008 Info: mcafee waiting for new updates
Fri Sep 19 11:12:52 2008 Info: Starting scheduled update
Fri Sep 19 11:12:52 2008 Info: Scheduled next update to occur at Fri Sep 19 11:17:52
2008
Fri Sep 19 11:17:52 2008 Info: Starting scheduled update
Fri Sep 19 11:17:52 2008 Info: Scheduled next update to occur at Fri Sep 19 11:22:52
2008
```

Updater Log Example

In this example, the logs show the automatic updates being disabled and backup being applied to the Sophos Anti-Virus definitions.

```
Fri Mar 10 15:05:55 2017 Debug: Skipping update request for "postx"
Fri Mar 10 15:05:55 2017 Debug: postx updates disabled
Fri Mar 10 15:05:55 2017 Debug: Skipping update request for "postx"
Fri Mar 10 15:05:55 2017 Trace: command session starting
Fri Mar 10 15:05:55 2017 Info: Automatic updates disabled for engine Sophos engine
Fri Mar 10 15:05:55 2017 Info: Sophos: Backup update applied successfully
Fri Mar 10 15:05:55 2017 Info: Internal SMTP system attempting to send a message to
abshastr@ironport.com
with subject 'Automatic updates are now disabled for sophos' attempt #0).
Fri Mar 10 15:05:55 2017 Debug: amp feature key disabled
Fri Mar 10 15:05:55 2017 Debug: Skipping update request for "amp"
Fri Mar 10 15:05:55 2017 Debug: amp feature key disabled
```

Understanding Tracking Logs

Tracking logs record information about the email operations of AsyncOS. The log messages are a subset of the messages recorded in the mail logs.

The tracking logs are used by the appliance's message tracking component to build the message tracking database. Because the log files are consumed in the process of building the database, the tracking logs are transient. The information in tracking logs is not designed to be read or analyzed by humans.

You can also view tracking information from multiple appliances using the Cisco Security Management appliance .

Using Authentication Logs

The authentication log records successful user logins and unsuccessful login attempts.

Table 149: Authentication Log Statistics

Statistic	Description
Timestamp	Time that the bytes were transmitted.
Message	The message consists of the username of a user who attempted to log in to the appliance and whether the user was authenticated successfully.

Authentication Log Example

In this example, the log shows the log in attempts by users “admin,” “joe,” and “dan.”

```
Wed Sep 17 15:16:25 2008 Info: Begin Logfile
Wed Sep 17 15:16:25 2008 Info: Version: 6.5.0-262 SN: XXXXXXX-XXXXX
Wed Sep 17 15:16:25 2008 Info: Time offset from UTC: 0 seconds
Wed Sep 17 15:18:21 2008 Info: User admin was authenticated successfully.
Wed Sep 17 16:26:17 2008 Info: User joe failed authentication.
Wed Sep 17 16:28:28 2008 Info: User joe was authenticated successfully.
Wed Sep 17 20:59:30 2008 Info: User admin was authenticated successfully.
Wed Sep 17 21:37:09 2008 Info: User dan failed authentication.
```

Using Configuration History Logs

A configuration history log consists of a configuration file with an additional section listing the name of the user, a description of where in the configuration the user made changes, and the comment the user entered when committing the change. Each time a user commits a change, a new log is created containing the configuration file after the change.

Configuration History Log Example

In this example, the configuration history log shows that the user (admin) added a guest user to the table that defines which local users are allowed to log in to the system.

```
<?xml version="1.0" encoding="ISO-8859-1"?>
<!DOCTYPE config SYSTEM "config.dtd">
<!--
XML generated by configuration change.
```



```
Change comment: added guest user

User: admin

Configuration are described as:

This table defines which local users are allowed to log into the system.

Product: Cisco IronPort M160 Messaging Gateway(tm) Appliance

Model Number: M160

Version: 6.7.0-231

Serial Number: 000000000ABC-D000000

Number of CPUs: 1

Memory (GB): 4

Current Time: Thu Mar 26 05:34:36 2009

Feature "Cisco IronPort Centralized Configuration Manager": Quantity = 10, Time Remaining = "25 days"

Feature "Centralized Reporting": Quantity = 10, Time Remaining = "9 days"

Feature "Centralized Tracking": Quantity = 10, Time Remaining = "30 days"

Feature "Centralized Spam Quarantine": Quantity = 10, Time Remaining = "30 days"

Feature "Receiving": Quantity = 1, Time Remaining = "Perpetual"

-->

<config>
```

Using External Threat Feeds Engine Logs

The ETF Logs contain information about the ETF engine, status, configuration, and so on. Most information is at the Info or Debug level.

Example of External Threat Feeds Engine Logs

```
Thu Jun 7 04:54:15 2018 Info: THREAT_FEEDS: Job failed with exception: Invalid URL or Port
Thu Jun 7 05:04:13 2018 Info: THREAT_FEEDS: A delta poll is scheduled for the source: S1
Thu Jun 7 05:04:13 2018 Info: THREAT_FEEDS: A delta poll has started for the source: S1,
domain: s1.co, collection: sss
Thu Jun 7 05:04:13 2018 Info: THREAT_FEEDS: Observables are being fetched from the source:
S1 between 2018-06-07 04:34:13+00:00 and 2018-06-07 05:04:13.185909+00:00
Thu Jun 7 05:04:13 2018 Info: THREAT_FEEDS: 21 observables were fetched from the source:
S1
Thu Jun 7 05:19:14 2018 Info: THREAT_FEEDS: A delta poll is scheduled for the source: S1
Thu Jun 7 05:19:14 2018 Info: THREAT_FEEDS: A delta poll has started for the source: S1,
domain: s1.co, collection: sss
```

ETF Source Configuration Failure - Invalid Collection Name

In this example, the log shows that your appliance was not able to fetch threat feeds from an external threat feed source because of an invalid collection name.

```
Info: THREAT_FEEDS: [TaxiiClient] Failed to poll threat feeds from following source:
hailataxii.com, cause of failure: Invalid Collection name
```

Solution

Go to *Mail Policies > External Threat Feeds Manager* page in the web interface or use the `threatfeedsconfig > sourceconfig` subcommand in the CLI and enter the correct collection name for the configured external threat feed source.

ETF Source Configuration Failure - HTTP Error

In this example, the log shows that your appliance was not able to fetch threat feeds from an external threat feed source because of an HTTP error.

```
Info: THREAT_FEEDS: [TaxiiClient] Failed to poll threat feeds from following source:
hailataxii.com , cause of failure: HTTP Error
```

Solution

Go to *Mail Policies > External Threat Feeds Manager* page in the web interface or use the `threatfeedsconfig > sourceconfig` subcommand in the CLI and enter the correct polling path or user authentication credentials for the configured external threat feed source.

ETF Source Configuration Failure - Invalid URL

In this example, the log shows that your appliance was not able to fetch threat feeds from an external threat feed source because of an invalid URL.

```
Info: THREAT_FEEDS: [TaxiiClient] Failed to poll threat feeds from following source:
hailataxii.com , cause of failure: HTTP Error
```

Solution

Go to *Mail Policies > External Threat Feeds Manager* page in the web interface or use the `threatfeedsconfig > sourceconfig` subcommand in the CLI and enter the correct hostname or port number for the configured external threat feed source.

Using Consolidated Event Logs

When configuring a log subscription with the log type as Consolidated Event Logs, use the 'Log Fields' option if you want to include specific message attributes in a single log line output.

The following log fields are selected by default when you configure a log subscription with the log type as Consolidated Event Log:

- ICID
- DCID
- Serial Number
- MID



Note You cannot remove any of the default log fields from the Selected Log Fields list.

Example of Consolidated Event Logs

In this example, the log shows all the available fields selected when you configure a log subscription with the log type as Consolidated Event Logs.

```
Sun Aug 25 12:37:08 2019: CEF:0|Cisco|C100V Email Security Virtual Appliance|13.0.0-283|ESA_CONSOLIDATED_LOG_EVENT|Consolidated Log Event|5|cs6Label=SDRRepScore
cs6=Weak deviceExternalId=42157574DD75FA3BD343-C964FC856529 ESAMID=144137
startTime=Sun Aug 25 12:35:39 2019 deviceInboundInterface=IncomingMail
ESADMARCVerdict=Skipped dvc=10.10.2.10 ESAAttachmentDetails={'MSOLE2msword.docx': {'AMP':
{'Verdict': 'FILE UNKNOWN', 'fileHash':
'917a35e8ffdd121c35b47a937dd4399539f0aa5b52a60fd038e0c4fdea78d357'}}, 'BodyScanner': {}}
ESAFriendlyFrom=ec@tester.com deviceDirection=0 ESAMailFlowPolicy=ACCEPT
suser=ec@tester.com cs1Label=MailPolicy cs1=DEFAULT act=QUARANTINED
ESAFinalActionDetails=To POLICY cs4Label=ExternalMsgID
cs4='<20190825173813.6679.31096@vm21bsd0008.cs21>' duser=aroma@mar-
esa.com ESAHeloIP=10.10.4.8 cfp1Label=SBRSScore cfp1=None ESASDRDomainAge=23 years 6 months
19 days cs3Label=SDRThreatCategory cs3=N/A ESASPFVerdict=None sourceHostName=unknown
ESASenderGroup=SUSPECTLIST sourceAddress=10.10.4.8 ESAICID=190746
cs5Label=ESAMsgLanguage cs5=English
msg=[Cousin\=20Domain] [SUSPECTED\=20SPAM]\=20asdfsaf
```

Log Field	CEF Field Name	CEF Field Value
Prefix Fields		
	CEF format version	Example: 0
	Appliance vendor	Example: Cisco
	Appliance product	Example: C100V Email Security Virtual Appliance
	Appliance version	Example: 13.0.0-234
	Event Class ID	Example: ESA_CONSOLIDATED_LOG_EVENT
	Event Name	Example: Consolidated Log Event
	Severity	Example: 5
GUI Fields		
Serial Number	deviceExternalId	Example: 42156AC79142E979C5CD-02DE66639E9C
ICID Timestamp	startTime	Example: Mon Jul 29 11:22:22 2019
ICID	ESAICID	Example: 199

Log Field	CEF Field Name	CEF Field Value
Listener Name	deviceInboundInterface(for incoming mails) deviceOutboundInterface(for outgoing mails)	Example: Inbound Example: Outbound
Sender IP	sourceAddress	Example: 10.10.2.75
Sender Domain	sourceHostName	Example: demo.cisco.com
Mail Direction	deviceDirection	Example: 0 0 -> incoming 1 -> outgoing
Mail Language	cs5	Example: cs5Label=ESAMsgLanguage cs5=English
SBRSScore	cfp1	Example: cfp1Label=SBRSScore, cfp1=1.1
Data IP	dvc	Example: 10.10.2.75
Mail Sender Geo Location	cs2	Example: cs2Label=GeoLocation cs2=India
Message Too Big from Sender	ESAMsgTooBigFromSender	Example: true Possible Values: true/false
Rate Limited IP	ESARateLimitedIP	Example: 10.10.2.75
Mail Policy Name	cs1	Example: cs1Label=MailPolicy cs1=default
Mail Flow Policy Name	ESAMailFlowPolicy	Example: ACCEPT
Sender Group Name	ESASenderGroup	Example: UNKNOWNLIST
DHA IP	ESADHASource	Example: 10.10.2.75
Recipients	duser	Example: demo@test.com
Remote IP/Helo Domain IP	ESAHeloIP	Example: 10.10.2.75
Remote Host/ Helo Domain	ESAHeloDomain	Example: test.com
TLS Outgoing Connection Status	ESATLSOutConnStatus	Example: Success Possible Values: Success/Failure

Log Field	CEF Field Name	CEF Field Value
TLS Outgoing Protocol	ESATLSOutProtocol	Example: TLSv1.2
TLS Outgoing Cipher	ESATLSOutCipher	Example: ECDHE-RSA-AES128-GCM-SHA256
TLS Incoming Connection Status	ESATLSInConnStatus	Example: Success Possible Values: Success/Failure
TLS Incoming Protocol	ESATLSInProtocol	Example: TLSv1.2
TLS Incoming Cipher	ESATLSInCipher	Example: ECDHE-RSA-AES128-GCM-SHA256
DMARC Verdict	ESADMARCVerdict	Example: Success Possible Values: PermFailure/TempFailure/ Reject/Success
DKIM Verdict	ESADKIMVerdict	Example: Pass Possible Values: Pass/Neutral/TempError/ PermError/HardFail/None
SPF Verdict	ESASPFVerdict	Example: Pass Possible Values: Pass/Neutral/SoftFail/Fail/ TempError/PermError
Friendly From	ESAFriendlyFrom	Example: demo@test.com
Mail From	suser	Example: demo@test.com
Reply-To	ESAREplyTo	Example: demo@test.com
Subject	msg	Example: This is a sample subject
MID	ESAMID	Example: 101
Message ID	cs4	Example: cs1Label=ExternalMsgID cs1=20190729112221.42958.40626 @vm21esa0075.cs21
SDR Reputation Score	cs6	Example: cs6Label= SDRRepScore cs6=Tainted

Log Field	CEF Field Name	CEF Field Value
SDR Consolidated Domain Age	ESASDRDomainAge	Example: 1 year 21 days
SDR Consolidated Threat Category	cs3	Example: cs3Label= SDRThreatCategory cs3=mal
Message Filters Verdict	Message Filters Verdict	Example: MATCH Possible Values: NOT EVALUATED/MATCH/NO MATCH
AS Verdict	ESAASVerdict	Example: POSITIVE Possible Values: Not EVALUATED/NEGATIVE/SUSPECT/ BULK_MAIL/SOCIAL_MAIL/MARKE TING_MAIL/POSITIVE
AV Verdict	ESAAVVerdict	Example: POSITIVE Possible Values: NOT EVALUATED/NEGATIVE/REPAIRED /ENCRYPTED/UNSCANNABLE/POSI TIVE
AMP Verdict	ESAAMPVerdict	Example: UNKNOWN Possible Values: NOT EVALUATED/CLEAN/FA_PENDING/ UNKNOWN/SKIPPED/ UNSCANNABLE /LOW_RISK/MALICIOUS
Graymail Verdict	ESAGMVerdict	Example: POSITIVE Possible Values: NOT EVALUATED/POSITIVE/NEGATIVE

Log Field	CEF Field Name	CEF Field Value
Content Filters Verdict	ESACFVerdict	Example: MATCH Possible Values: NOT EVALUATED/MATCH/NO MATCH
Outbreak Filters Verdict	ESAOFVerdict	Example: NEGATIVE Possible Values: NOT EVALUATED/POSITIVE/NEGATIVE
DLP Verdict	ESADLPVerdict	Example: VIOLATION Possible Values: NOT EVALUATED/NO TRIGGER/VIOLATION/NO VIOLATION
URL Details	ESAURLDetails	Example: {url1:{expanded_url:◇, category:◇, wbrs_score:◇, in_attachment:◇, Attachment_with_url:◇,},url2:{...}} Note A URL is truncated if it contains more than 255 characters
File Details	ESAAttachmentDetails	Example: {name1:{source: {◇hash:◇, verdicts:◇}}} Note A filename is truncated if it contains more than 255 characters.
Mailbox Auto-Remediation Details	ESAMARAction	Example: {action:◇;succesful_repts=◇;failed _recipients=◇;filename=◇}
DCID	ESADCID	Example: 199
DCID Timestamp	EndTime	Example: Mon Jul 29 09:55:07 2019

Log Field	CEF Field Name	CEF Field Value
DANE Status	ESADaneStatus	Example: success Possible Values: success/failure
DANE Host	ESADaneHost	Example: testdomain.com
Message Final Action	act	Example: act=DELIVERED Possible Values: DROPPED/BOUNCED/DELIVERED - if the message is not quarantined. QUARANTINED - if the message is quarantined. DQ - if the message is sent to Delayed Quarantine. This is an exception and not a quarantine type.
Message Final Action Details	ESAFinalActionDetails	Example: act=DROPPED ESAFinalActionDetails= By AMP act=QUARANTINED ESAFinalActionDetails=To SPAM



Note If there is no value for a selected log field (for example, 'DKIMVerdict' because DKIM is not enabled on your appliance), the log field is not included in the log message.

Using CSN Logs

The CSN logs contain details about the CSN data uploads. The CSN data (appliance and feature usage details can be seen at the trace level.

Examples of CSN Data Log Entries:

- In this example, the log shows that the appliance was not able to send the CSN data to Cisco because the appliance smart license was not registered with Cisco Smart Software Manager (CSSM).

```
Tue Apr 7 12:52:47 2020 Warning: Device is not
registered with CSSM. Skipping upload of CSN data
```

Solution: Make sure that you register your appliance smart license with Cisco Smart Software Manager (CSSM).

- In this example, the log shows that the appliance was not able to send the CSN data to Cisco because of a Cisco Security Services Exchange (SSE) connectivity error.

```
Thu Apr 9 13:32:46 2020 Warning: The appliance
failed to upload CSN data. reason for failure:
SSE error: HTTP Error 503: Service Unavailable
```

Solution: Make sure that you disable CSN and enable it again on your appliance .

Using Advanced Phishing Protection Logs

The Advanced Phishing Protection logs contain information related to Cisco Advanced Phishing Protection Cloud Service. Most information is at the Info or Critical level.

Examples of Advanced Phishing Protection Data Log Entries:

- In this example, the log shows that the appliance was not able to forward the message headers to Cisco Advanced Phishing Protection Cloud Service because the service expired.

```
Wed May 6 18:21:40 2020 Info: eaas : You cannot
forward the MID [877] Message Headers to Cisco Advanced
Phishing Protection Cloud Service as the service has
expired
```

- In this example, the log shows that the Cisco Advanced Phishing Protection Cloud Service has expired and is disabled in your appliance .

```
Wed May 6 18:21:40 2020 Info: eaas : Cisco
Advanced Phishing Protection Cloud Service has expired
and is disabled. Contact your Cisco Account manager to
renew the service and then enable it.
```

Solution: Contact your Cisco Account manager to renew the service and then enable it.

- In this example, the log shows that the Cisco Advanced Phishing Protection Cloud Service will expire on a particular date.

```
Fri May 8 04:50:26 2020 Info: eaas : Cisco
Advanced Phishing Protection Cloud Service expires on
2020-05-10 07:00:00. You need to contact your Cisco Account
manager to renew the service.
```

Solution: Contact your Cisco Account manager to renew the service.

Log Subscriptions

- [Configuring Log Subscriptions, on page 1171](#)
- [Creating a Log Subscription in the GUI, on page 1173](#)
- [Configuring Global Settings for Logging, on page 1174](#)
- [Rolling Over Log Subscriptions, on page 1176](#)
- [Configuring Host Keys, on page 1180](#)

Configuring Log Subscriptions

It is recommended that you avoid deleting preexisting log subscriptions on appliances .

Use the Log Subscriptions page on the System Administration menu (or the `logconfig` command in the CLI) to configure a log subscription. Log subscriptions create log files that store information about AsyncOS

activity, including errors. A log subscription is either retrieved or delivered (pushed) to another computer. Generally, log subscriptions have the following attributes:

Table 150: Log File Attributes

Attribute	Description
Log type	Defines the type of information recorded and the format of the logs subscriptions. See <i>Table: Log Types</i> for more information.
Log Name	Nickname for the log subscription to be used for your future reference.
Log Fields	Select the required log fields to include in the consolidated event log line for a given message. Note The Serial Number and MID log fields are selected by default, and you cannot deselect these fields. Note This field is only applicable when you are configuring a log subscription with the log type as Consolidated Event Logs.
File Name	Used for the physical name of the file when written to disk. If multiple appliances are being used, the log filename should be unique to identify the system that generated the log file.
Rollover by File Size	The maximum size the file can reach before rolling over.
Rollover by Time	Sets the time interval for file rollovers.
Rate Limit	Sets the maximum number of logged events in the log file, within the specified time range (in seconds). The default time range value is 10 seconds.
Log level	Sets the level of detail for each log subscription.
Retrieval method	Defines how the log subscription will be obtained from the appliance .

Log Levels

Log levels determine the amount of information delivered in a log. Logs can have one of five levels of detail. A more detailed setting creates larger log files and puts more drain on system performance. More detailed settings include all the messages contained in less detailed settings, plus additional messages. As the level of detail increases, system performance decreases.



Note Log levels may be selected for all mail log types.

Table 151: Log Levels

Log Level	Description
Critical	The least detailed setting. Only errors are logged. Using this setting will not allow you to monitor performance and other important activities; however, the log files will not reach their maximum size as quickly. This log level is equivalent to the syslog level “Alert.”
Warning	All errors and warnings created by the system. Using this setting will not allow you to monitor performance and other important activities. This log level is equivalent to the syslog level “Warning.”
Information	The information setting captures the second-by-second operations of the system. For example, connections opened or delivery attempts. The Information level is the recommended setting for logs. This log level is equivalent to the syslog level “Info.”
Debug	Use the Debug log level when you are trying to discover the cause of an error. Use this setting temporarily, and then return to the default level. This log level is equivalent to the syslog level “Debug.”
Trace	The Trace log level is recommended only for developers. Using this level causes a serious degradation of system performance and is not recommended. This log level is equivalent to the syslog level “Debug.”

Creating a Log Subscription in the GUI

Procedure

-
- Step 1** Choose **System Administration > Log Subscriptions**.
 - Step 2** Click **Add Log Subscription**.
 - Step 3** Select a log type and enter the log name (for the log directory) as well as the name for the log file itself.
 - Step 4** [Only for Consolidated Event Logs] Select the required log fields to include in the log line for a given message.
 - Step 5** Specify the maximum file size before AsyncOS rolls over the log file as well as a time interval between rollovers. See [Rolling Over Log Subscriptions, on page 1176](#) for more information on rolling over log files.
 - Step 6** Select the log level. The available options are Critical, Warning, Information, Debug, or Trace.
 - Step 7** Configure the log retrieval method.
 - Step 8** Submit and commit your changes.
-

Editing Log Subscriptions

Procedure

-
- Step 1** Choose **System Administration > Log Subscriptions**.

- Step 2** Click the name of the log in the Log Settings column.
- Step 3** Make changes to the log subscription.
- Step 4** Submit and commit your changes.

Configuring Global Settings for Logging

The system periodically records system measurements within the Text Mail Logs and the Status Logs. Use the **Edit Settings** button in the Global Settings section of the **System Administration > Log Subscriptions** page (or the `logconfig -> setup` command in the CLI) to configure:

- System metrics frequency. This is the amount of time, in seconds, that the system waits between recording measurements.
- Whether to record the Message-ID headers.
- Whether to record the remote response status code.
- Whether to record the subject header of the original message.
- A list of headers that should be logged for each message.

All logs optionally include the following three pieces of data:

1. Message-ID

When this option is configured, every message will have its Message ID header logged, if it is available. Note that this Message-ID may have come from the received message or may have been generated by AsyncOS itself. For example:

```
Tue Apr 6 14:38:34 2004 Info: MID 1 Message-ID Message-ID-Content
```

2. Remote Response

When this option is configured, every message will have its remote response status code logged, if it is available. For example:

```
Tue Apr 6 14:38:34 2004 Info: MID 1 RID [0] Response 'queued as 9C8B425DA7'
```

The remote response string is the human-readable text received after the response to the DATA command during the delivery SMTP conversation. In this example, the remote response after the connection host issued the data command is “queued as 9C8B425DA7.”

```
[...]
```

```
250 ok hostname
```

```
250 Ok: queued as 9C8B425DA7
```

Whitespace, punctuation, (and in the case of the 250 response, the OK characters) are stripped from the beginning of the string. Only whitespace is stripped from the end of the string. For example, appliances, by default, respond to the DATA command with this string: 250 Ok: Message MID accepted. So, the string “Message MID accepted” would be logged if the remote host were another appliance .

3. Original Subject Header

When this option is enabled, the original subject header of each message is included in the log.

```
Tue May 31 09:20:27 2005 Info: Start MID 2 ICID 2
Tue May 31 09:20:27 2005 Info: MID 2 ICID 2 From: <mary@example.com>
Tue May 31 09:20:27 2005 Info: MID 2 ICID 2 RID 0 To: <joe@example.com>
Tue May 31 09:20:27 2005 Info: MID 2 Message-ID '<44e4n$2@example.com>'
Tue May 31 09:20:27 2005 Info: MID 2 Subject 'Monthly Reports Due'
```

Logging Message Headers

In some cases, it is necessary to record the presence and contents of a message's headers as they pass through the system. You specify the headers to record in the Log Subscriptions Global Settings page (or via the `logconfig -> logheaders` subcommand in the CLI). The appliance records the specified message headers in the Text Mail Logs, the Delivery Logs, and the Bounce Logs. If the header is present, the system records the name of the header and the value. If a header is not present, nothing is recorded in the logs.



Note The system evaluates all headers that are present on a message, at any time during the processing of the message for recording, regardless of the headers specified for logging.

The RFC for the SMTP protocol is located at <http://www.faqs.org/rfcs/rfc2821.html> and defines user-defined headers.

If you have configured headers to log via the `logheaders` command, the header information appears after the delivery information:

Table 152: Log Headers

Header name	Name of the header
Value	Contents of the logged header

For example, specifying “date, x-subject” as headers to be logged will cause the following line to appear in the mail log:

```
Tue May 31 10:14:12 2005 Info: Message done DCID 0 MID 3 to RID [0]
[['date', 'Tue, 31 May 2005 10:13:18 -0700'], ('x-subject', 'Logging this header')]
```

Configuring Global Settings for Logging Using the GUI

Procedure

- Step 1** Choose **System Administration > Log Subscriptions**.
- Step 2** Scroll down to the **Global Settings** section.
- Step 3** Click **Edit Settings**.

- Step 4** Specify information including the system measurement frequency, whether to include Message-ID headers in mail logs, whether to include the remote response, and whether to include the original subject header of each message.
- Step 5** Enter any other headers you wish to include in the logs.
- Step 6** Submit and commit your changes.
-

Rolling Over Log Subscriptions

To prevent log files on the appliance from becoming too large, AsyncOS performs a “rollover” and archives a log file when it reaches a user-specified maximum file size or time interval and creates a new file for incoming log data. Based on the retrieval method defined for the log subscription, the older log file is stored on the appliance for retrieval or delivered to an external computer. See [Log Retrieval Methods, on page 1120](#) for more information on how to retrieve log files from the appliance .

When AsyncOS rolls over a log file, it performs the following actions:

- Renames the current log file with the timestamp of the rollover and a letter “s” extension signifying saved.
- Creates a new log file and designates the file as current with the “**current**” extension.
- Transfers the newly saved log file to a remote host (if using the push-based retrieval method).
- Transfers any previously unsuccessful log files from the same subscription (if using the push-based retrieval method).
- Deletes the oldest file in the log subscription if the total number of files to keep on hand has been exceeded (if using the poll-based retrieval method).

You define a log subscription’s rollover settings when creating or editing the subscription using the **System Administration > Log Subscriptions** page in the GUI or the `logconfig` command in the CLI. The two settings available for triggering a log file rollover are:

- A maximum file size.
- A time interval.

Rollover By File Size

AsyncOS rolls over log files when they reach a maximum file size to prevent them from using too much disk space. When defining a maximum file size for rollovers, use the suffix `m` for megabytes and `k` for kilobytes. For example, enter `10m` if you want AsyncOS to roll over the log file when it reaches 10 megabytes.

Rollover By Time

If you want to schedule rollovers to occur on a regular basis, you can select one of the following time intervals:

- **None.** AsyncOS only performs a rollover when the log file reaches the maximum file size.
- **Custom Time Interval.** AsyncOS performs a rollover after a specified amount of time has passed since the previous rollover. To create a custom time interval for scheduled rollovers, enter the number of days, hours, and minutes between rollovers using `d`, `h`, and `m` as suffixes.
- **Daily Rollover.** AsyncOS performs a rollover every day at a specified time. If you choose a daily rollover, enter the time of day you want AsyncOS to perform the rollover using the 24-hour format (HH:MM).

Only the GUI offers the Daily Rollover option. If you want to configure a daily rollover using the `logconfig` command in the CLI, choose the Weekly Rollover option and use an asterisk (*) to specify that AsyncOS should perform the rollover on every day of the week.

- **Weekly Rollover.** AsyncOS performs a rollover on one or more days of the week at a specified time. For example, you can set up AsyncOS to rollover the log file every Wednesday and Friday at midnight. To configure a weekly rollover, choose the days of the week to perform the rollover and the time of day in the 24-hour format (HH:MM).

If you are using the CLI, you can use a dash (-) to specify a range of days, an asterisk (*) to specify every day of the week, or a comma (,) to separate multiple days and times.

The following table shows how to use the CLI to roll over the files for a log subscription on Wednesday and Friday at midnight (00:00).

Table 153: Weekly Log Rollover Settings in the CLI

Do you want to configure time-based log files rollover? [N]> y
Configure log rollover settings:
1. Custom time interval.
2. Weekly rollover.
[1]> 2
1. Monday
2. Tuesday
3. Wednesday
4. Thursday
5. Friday
6. Saturday
7. Sunday
Choose the day of week to roll over the log files. Separate multiple days with comma, or use "*" to specify every day of a week. Also you can use dash to specify a range like "1-5":
[]> 3, 5

Enter the time of day to rollover log files in 24-hour format (HH:MM).
 You can specify hour as "*" to match every hour, the same for minutes.
 Separate multiple times of day with comma:

```
[ ]> 00:00
```

Rolling Over Log Subscriptions on Demand

To roll over log subscriptions immediately using the GUI:

Procedure

-
- Step 1** On the System Administration > Log Subscriptions page, mark the checkbox to the right of the logs you wish to roll over.
 - Step 2** Optionally, you can select all logs for rollover by marking the All checkbox.
 - Step 3** Once one or more logs have been selected for rollover, the **Rollover Now** button is enabled. Click the **Rollover Now** button to roll over the selected logs.
-

Viewing Recent Log Entries in the GUI

Before You Begin

You must have the HTTP or HTTPS service enabled on the Management interface in order to view logs via the GUI.

Procedure

-
- Step 1** Select **System Administration > Log Subscriptions**.
 - Step 2** Select the log subscription in the **Log Files** column of the table.
 - Step 3** Sign in.
 - Step 4** Select a log file to view it in your browser or to save it to disk.
-

Viewing Recent Log Entries in the CLI (tail Command)

AsyncOS supports a tail command, which shows the latest entries of configured logs on the appliance. Issue the tail command and select the number of a currently configured log to view it. Use Ctrl-C to exit from the tail command.

Example

In the following example, the tail command is used to view the system log. (This log tracks user comments from the commit command, among other things.) The tail command also accepts the name of a log to view as a parameter: tail mail_logs .

```
mail3.example.com> tail
```

```
Currently configured logs:
```

1. "antispam" Type: "Anti-Spam Logs" Retrieval: Manual Download
2. "antivirus" Type: "Anti-Virus Logs" Retrieval: Manual Download
3. "asarchive" Type: "Anti-Spam Archive" Retrieval: Manual Download
4. "authentication" Type: "Authentication Logs" Retrieval: Manual Download
5. "avarchive" Type: "Anti-Virus Archive" Retrieval: Manual Download
6. "bounces" Type: "Bounce Logs" Retrieval: Manual Download
7. "cli_logs" Type: "CLI Audit Logs" Retrieval: Manual Download
8. "encryption" Type: "Encryption Logs" Retrieval: Manual Download
9. "error_logs" Type: "IronPort Text Mail Logs" Retrieval: Manual Download
10. "euq_logs" Type: "IronPort Spam Quarantine Logs" Retrieval: Manual Download
11. "euqgui_logs" Type: "IronPort Spam Quarantine GUI Logs" Retrieval: Manual Download
12. "ftpd_logs" Type: "FTP Server Logs" Retrieval: Manual Download
13. "gui_logs" Type: "HTTP Logs" Retrieval: Manual Download
14. "mail_logs" Type: "IronPort Text Mail Logs" Retrieval: Manual Download
15. "reportd_logs" Type: "Reporting Logs" Retrieval: Manual Download
16. "reportqueryd_logs" Type: "Reporting Query Logs" Retrieval: Manual Download
17. "scanning" Type: "Scanning Logs" Retrieval: Manual Download
18. "slbld_logs" Type: "Safe/Block Lists Logs" Retrieval: Manual Download
19. "sntpd_logs" Type: "NTP logs" Retrieval: Manual Download
20. "status" Type: "Status Logs" Retrieval: Manual Download
21. "system_logs" Type: "System Logs" Retrieval: Manual Download
22. "trackerd_logs" Type: "Tracking Logs" Retrieval: Manual Download
23. "updater_logs" Type: "Updater Logs" Retrieval: Manual Download

```
Enter the number of the log you wish to tail.
```

```
[ ]> 19
```

```
Press Ctrl-C to stop.
```

```

Mon Feb 21 12:25:10 2011 Info: PID 274: User system commit changes: Automated Update for
Quarantine Delivery Host

Mon Feb 21 23:18:10 2011 Info: PID 19626: User admin commit changes:

Mon Feb 21 23:18:10 2011 Info: PID 274: User system commit changes: Updated filter logs
config

Mon Feb 21 23:46:06 2011 Info: PID 25696: User admin commit changes: Receiving
suspended.

^Cmail3.example.com>

```

Configuring Host Keys

Use the `logconfig -> hostkeyconfig` subcommand to manage host keys for use with SSH when pushing logs to other servers from the appliance. SSH servers must have a pair of host keys, one private and one public. The private host key resides on the SSH server and cannot be read by remote machines. The public host key is distributed to any client machine that needs to interact with the SSH server.



Note To manage user keys, see [Managing Secure Shell \(SSH\) Keys, on page 979](#).

The `hostkeyconfig` subcommand performs the following functions:

Table 154: Managing Host Keys - List of Subcommands

Command	Description
New	Add a new key.
Edit	Modify an existing key.
Delete	Delete an existing key.
Scan	Automatically download a host key.
Print	Display a key.
Host	Display system host keys. This is the value to place in the remote system's 'known_hosts' file.
Fingerprint	Display system host key fingerprints.
User	Display the public key of the system account that pushes the logs to the remote machine. This is the same key that is displayed when setting up an SCP push subscription. This is the value to place in the remote system's 'authorized_keys' file.

In the following example, AsyncOS scans for host keys and add them for the host:

```

mail3.example.com> logconfig

Currently configured logs:

[ list of logs ]

```

```
Choose the operation you want to perform:
- NEW - Create a new log.
- EDIT - Modify a log subscription.
- DELETE - Remove a log subscription.
- SETUP - General settings.
- LOGHEADERS - Configure headers to log.
- HOSTKEYCONFIG - Configure SSH host keys.
[ ]> hostkeyconfig

Currently installed host keys:
1. mail3.example.com ssh-dss [ key displayed ]

Choose the operation you want to perform:
- NEW - Add a new key.
- EDIT - Modify a key.
- DELETE - Remove a key.
- SCAN - Automatically download a host key.
- PRINT - Display a key.
- HOST - Display system host keys.
- FINGERPRINT - Display system host key fingerprints.
- USER - Display system user keys.
[ ]> scan

Please enter the host or IP address to lookup.
[ ]> mail3.example.com

Choose the ssh protocol type:
1. SSH1:rsa
2. SSH2:rsa
3. SSH2:dsa
4. All
[4]>

SSH2:dsa
mail3.example.com ssh-dss

[ key displayed ]

SSH2:rsa
```

```
mail3.example.com ssh-rsa
[ key displayed ]
SSH1:rsa
mail3.example.com 1024 35
[ key displayed ]

Add the preceding host key(s) for mail3.example.com? [Y]>
Currently installed host keys:
1. mail3.example.com ssh-dss [ key displayed ]
2. mail3.example.com ssh-rsa [ key displayed ]
3. mail3.example.com 1024 35 [ key displayed ]

Choose the operation you want to perform:
- NEW - Add a new key.
- EDIT - Modify a key.
- DELETE - Remove a key.
- SCAN - Automatically download a host key.
- PRINT - Display a key.
- HOST - Display system host keys.
- FINGERPRINT - Display system host key fingerprints.
- USER - Display system user keys.

[ ]>

Currently configured logs:
[ list of configured logs ]

Choose the operation you want to perform:
- NEW - Create a new log.
- EDIT - Modify a log subscription.
- DELETE - Remove a log subscription.
- SETUP - General settings.
- LOGHEADERS - Configure headers to log.
- HOSTKEYCONFIG - Configure SSH host keys.

[ ]>
```



CHAPTER 44

Centralized Management Using Clusters

This chapter contains the following sections:

- [Overview of Centralized Management Using Clusters](#) , on page 1183
- [Cluster Requirements](#), on page 1184
- [Cluster Organization](#), on page 1184
- [Creating and Joining a Cluster](#), on page 1186
- [Managing Clusters](#), on page 1192
- [Administering a Cluster from the GUI](#), on page 1197
- [Cluster Communication](#), on page 1200
- [Loading a Configuration in Clustered Appliances](#) , on page 1204
- [Best Practices and Frequently Asked Questions](#), on page 1206

Overview of Centralized Management Using Clusters

The Cisco centralized management feature allows you to manage and configure multiple appliances at the same time, reducing administration time and ensuring a consistent configuration across your network. You do not need to purchase additional hardware for managing multiple appliances . The centralized management feature provides increased reliability, flexibility, and scalability within your network, allowing you to manage globally while complying with local policies.

A *cluster* is defined as a set of machines that share configuration information. Within the cluster, machines (appliances) are divided into *groups* ; every cluster will contain at least one group. A given machine is a member of one and only one group. An administrator user can configure different elements of the system on a cluster-wide, group-wide, or per-machine basis, enabling the segmentation of appliances based on network, geography, business unit, or other logical relationships.

Clusters are implemented as a *peer-to-peer* architecture; there is no primary/secondary relationship within a cluster. You may log into any machine to control and administer the cluster. (Some configuration commands, however, are limited. See [Restricted Commands](#), on page 1196.)

The user database is shared across all machines in the cluster. That is, there will be only one set of users and one administrator user (with the associated passphrases) for an entire cluster. All machines that join a cluster will share a single administrator passphrase which is referred to as the *admin passphrase* of the cluster.



Note Having more than 20 appliances in a cluster can cause errors in cluster communication.

Cluster Requirements

- Machines in a cluster must have resolvable hostnames in DNS. Alternatively, you can use IP addresses instead, but you may not mix the two.

See [DNS and Hostname Resolution, on page 1200](#). Cluster communication is normally initiated using the DNS hostnames of the machines.

- A cluster must consist entirely of machines running the same version of AsyncOS.

See [Upgrading Machines in a Cluster, on page 1194](#) for how to upgrade members of a cluster.

- Machines can either join the cluster via SSH (typically on port 22) *or* via the Cluster Communication Service (CCS).

See [Cluster Communication, on page 1200](#).

- Once machines have joined the cluster, they can communicate via SSH or via Cluster Communication Service. The port used is configurable. SSH is typically enabled on port 22, and by default CCS is on port 2222, but you can configure either of these services on a different port.

In addition to the normal firewall ports that must be opened for the appliance, clustered machines communicating via CCS must be able to connect with each other via the CCS port. See [Cluster Communication, on page 1200](#).

- You must use the Command Line Interface (CLI) command `clusterconfig` to create, join, or configure clusters of machines.

Once you have created a cluster, you can manage non-cluster configuration settings from either the GUI or the CLI.

See [Creating and Joining a Cluster, on page 1186](#) and [Administering a Cluster from the GUI, on page 1197](#).

Cluster Organization

Within a cluster, configuration information is divided into 3 groupings or *levels*. The top level describes cluster settings; the middle level describes group settings; and the lowest level describes machine-specific settings.

Figure 79: Cluster Level Hierarchy

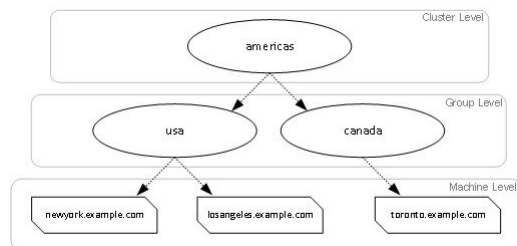

Within each level there will be one or more specific members for which settings may be configured; these are referred to as modes. A mode refers to a named member at a specified level. For example, the group “usa” represents one of two group modes in the diagram. While levels are a general term, modes are specific; modes are always referred to by name. The cluster depicted in the above figure has six modes.

Although settings are configured at a given level, they are always configured for a specific mode. It is not necessary to configure settings for all modes within a level. The cluster mode is a special case. Because there can only be one cluster, all settings configured for the cluster mode can be said to be configured at the cluster level.

You should normally configure most settings at the cluster level. However, settings that have been specifically configured at lower levels will override settings configured at higher levels. Thus, you can override cluster-mode settings with group-mode or machine-mode settings.

For example, you might start by configuring the Good Neighbor Table in cluster mode; all machines in the cluster would use that configuration. Then, you might also configure this table in machine mode for machine newyork . In this case, all other machines in the cluster will still use the good neighbor table defined at the cluster level, but the machine newyork will override the cluster settings with its individual machine mode settings.

The ability to override cluster settings for specific groups or machines gives you a lot of flexibility. However, if you find yourself configuring many settings individually in machine mode, you will lose much of the ease of administration that clusters were intended to provide.

Initial Configuration Settings

For most features, when you begin to configure settings for a new mode, those settings will initially be empty by default. There is a distinction between empty settings and having no settings in a mode. As an example, consider a very simple cluster composed of one group and one machine. Imagine that you have an LDAP query configured at the cluster level. There are no settings configured at the group or machine levels:

Cluster	(ldap queries: a, b, c)
Group	
Machine	

Now, imagine that you create new LDAP query settings for the group. The result will be something like this:

Cluster	(ldap queries: a, b, c)
Group	(ldap queries: None)
Machine	

The group-level settings now override the cluster-level setting; however, the new group settings are initially empty. The group mode does not actually have any LDAP queries of its own configured. Note that a machine within this group will inherit this “empty” set of LDAP queries from the group.

Next, you can add an LDAP query to the group, for example:

Cluster	(ldap queries: a, b, c)
Group	(ldap queries: d)
Machine	

Now the cluster level has one set of queries configured while the group has another set of queries. The machine will inherit its queries from the group.

Creating and Joining a Cluster

You cannot create or join a cluster from the Graphical User Interface (GUI). You must use the Command Line Interface (CLI) to create, join, or configure clusters of machines. Once you have created a cluster, you can change configuration settings from either the GUI or the CLI.

The `clusterconfig` Command

A machine can create or join a cluster only via the `clusterconfig` command.

- When a new cluster is *created*, all of that cluster's initial settings will be inherited from the machine that creates the cluster. If a machine was previously configured in “standalone” mode, its standalone settings are used when creating the cluster.
- When a machine *joins* a cluster, all of that machine's clusterable settings will be inherited from the cluster level. In other words, everything except certain machine-specific settings (IP addresses, etc) will be lost and will be replaced with the settings from the cluster and/or the group selected for that machine to join. If a machine was previously configured in “standalone” mode, its standalone settings are used when creating the cluster, and no settings at the machine level are maintained.

If the current machine is not already part of a cluster, issuing the `clusterconfig` command presents the option to join an existing cluster or create a new one.

At this point you can add machines to the new cluster. Those machines can communicate via SSH or CCS.

```
newyork.example.com> clusterconfig

Do you want to join or create a cluster?

1. No, configure as standalone.
2. Create a new cluster.
3. Join an existing cluster over SSH.
4. Join an existing cluster over CCS.

[1]> 2

Enter the name of the new cluster.

[]> americas

New cluster committed: Wed Jun 22 10:02:04 2005 PDT

Creating a cluster takes effect immediately, there is no need to commit.

Cluster americas

Choose the operation you want to perform:

- ADDGROUP - Add a cluster group.
- SETGROUP - Set the group that machines are a member of.
- RENAMEGROUP - Rename a cluster group.
- DELETGROUP - Remove a cluster group.
```



```

- REMOVEMACHINE - Remove a machine from the cluster.
- SETNAME - Set the cluster name.
- LIST - List the machines in the cluster.
- LISTDETAIL - List the machines in the cluster with detail.
- DISCONNECT - Temporarily detach machines from the cluster.
- RECONNECT - Restore connections with machines that were previously detached.
- PREPJOIN - Prepare the addition of a new machine over CCS.

[1]>

```

Joining an Existing Cluster

From the host you want to add to the cluster, issue the `clusterconfig` command to join the existing cluster. You can choose to join the cluster over SSH or over CCS (cluster communication service).

In order to join a host to an existing cluster, you must:

- be able to validate the SSH host key of a machine in the cluster
- know the IP address of a machine in the cluster and be able to connect to this machine in the cluster (for example, via SSH or CCS)
- know the administrator passphrase for the admin user on a machine belonging to the cluster

Joining an Existing Cluster over SSH

The following table demonstrates adding the machine `losangeles.example.com` to the cluster using the SSH option.

```
losangeles.example.com> clusterconfig
```

```
Do you want to join or create a cluster?
```

1. No, configure as standalone.
2. Create a new cluster.
3. Join an existing cluster over SSH.
4. Join an existing cluster over CCS.

```
[1]> 3
```

While joining a cluster, you will need to validate the SSH host key of the remote machine to which you are joining. To get the public host key

```
fingerprint of the remote host, connect to the cluster and run: logconfig ->
hostkeyconfig -> fingerprint.
```

WARNING: All non-network settings will be lost. System will inherit the values set at the group or cluster mode for the non-network settings. Ensure that the cluster settings are compatible with your network settings (e.g. `dnsconfig` settings)

```
Do you want to enable the Cluster Communication Service on
```

```

losangeles.example.com? [N]> n

Enter the IP address of a machine in the cluster.

[ ]> IP address is entered

Enter the remote port to connect to. The must be the normal admin ssh
port, not the CCS port.

[22]> 22

Enter the admin passphrase for the cluster.
The administrator passphrase for the clustered machine is entered

Please verify the SSH host key for IP address:

Public host key fingerprint: xx:xx:xx:xx:xx:xx:xx:xx:xx:xx:xx:xx:xx:xx:xx

Is this a valid key for this host? [Y]> y

Joining cluster group Main_Group.

Joining a cluster takes effect immediately, there is no need to commit.

Cluster americas

Choose the operation you want to perform:

- ADDGROUP - Add a cluster group.
- SETGROUP - Set the group that machines are a member of.
- RENAMEGROUP - Rename a cluster group.
- DELETEGROUP - Remove a cluster group.
- REMOVEMACHINE - Remove a machine from the cluster.
- SETNAME - Set the cluster name.
- LIST - List the machines in the cluster.
- LISTDETAIL - List the machines in the cluster with detail.
- DISCONNECT - Temporarily detach machines from the cluster.
- RECONNECT - Restore connections with machines that were previously detached.
- PREPJOIN - Prepare the addition of a new machine over CCS.

[ ]>

(Cluster americas)>

```

Joining an Existing Cluster over CCS

Use CCS instead of SSH if you cannot use SSH. The only advantage of CCS is that only cluster communication happens over that port (no user logins, SCP, etc). To add another machine to an existing cluster via CCS, use the `prepjoin` subcommand of `clusterconfig` to prepare the machine to be added to the cluster. In this example, the `prepjoin` command is issued on the machine `newyork` to prepare the machine `losangeles` to be added to the cluster.

The `prepjoin` command involves obtaining the user key of the host you want to add to the cluster by typing `clusterconfig prepjoin print` in the CLI of that host, and then copying the key into the command line of the host that is currently in the cluster.

Once a machine is already part of a cluster, the `clusterconfig` command allows you to configure various settings for the cluster.

Choose the operation you want to perform:

- ADDGROUP - Add a cluster group.
- SETGROUP - Set the group that machines are a member of.
- RENAMEGROUP - Rename a cluster group.
- DELETEGROUP - Remove a cluster group.
- REMOVEMACHINE - Remove a machine from the cluster.
- SETNAME - Set the cluster name.
- LIST - List the machines in the cluster.
- LISTDETAIL - List the machines in the cluster with detail.
- DISCONNECT - Temporarily detach machines from the cluster.
- RECONNECT - Restore connections with machines that were previously detached.
- PREPJOIN - Prepare the addition of a new machine over CCS.

```
[> prepjoin
```

```
Prepare Cluster Join Over CCS
```

```
No host entries waiting to be added to the cluster.
```

```
Choose the operation you want to perform:
```

- NEW - Add a new host that will join the cluster.

```
[> new
```

```
Enter the hostname of the system you want to add.
```

```
[> losangeles.example.com
```

```
Enter the serial number of the host mail3.example.com.
```

```
[> unique serial number is added
```

```
Enter the user key of the host losangeles.example.com. This can be obtained by typing "clusterconfig prepjoin print" in the CLI on mail3.example.com. Press enter on a blank line to finish.
```

```
unique user key from output of prepjoin print is pasted
```

```
Host losangeles.example.com added.
```

```
Prepare Cluster Join Over CCS
```

```
1. losangeles.example.com (serial-number)
```

Choose the operation you want to perform:

- NEW - Add a new host that will join the cluster.
- DELETE - Remove a host from the pending join list.

[]>

(Cluster Americas)> clusterconfig

Cluster americas

Choose the operation you want to perform:

- ADDGROUP - Add a cluster group.
- SETGROUP - Set the group that machines are a member of.
- RENAMEGROUP - Rename a cluster group.
- DELETEGROUP - Remove a cluster group.
- REMOVEMACHINE - Remove a machine from the cluster.
- SETNAME - Set the cluster name.
- LIST - List the machines in the cluster.
- LISTDETAIL - List the machines in the cluster with detail.
- DISCONNECT - Temporarily detach machines from the cluster.
- RECONNECT - Restore connections with machines that were previously detached.
- PREPJOIN - Prepare the addition of a new machine over CCS.

[]>

Joining an Existing Cluster over SSH with Pre-Shared Keys

The following table demonstrates how to join the machine (testmachine.example.com) to the cluster (test_cluster) over SSH using pre-shared keys.

```
testmachine.example.com> clusterconfig
```

Do you want to join or create a cluster?

1. No, configure as standalone.
2. Create a new cluster.
3. Join an existing cluster over SSH.
4. Join an existing cluster over CCS.

[1]> 3

While joining a cluster, you will need to validate the SSH host key of the remote machine to which you are joining. To get the public host key

fingerprint of the remote host, connect to the cluster and run: `logconfig -> hostkeyconfig -> fingerprint.`

WARNING: All non-network settings will be lost. System will inherit the values set at the group or cluster mode for the non-network settings. Ensure that the cluster settings are compatible with your network settings (e.g. `dnsconfig` settings)

Do you want to enable the Cluster Communication Service on `testmachine.example.com`? [N]>

Enter the IP address of a machine in the cluster.

[]> **IP address entered**

Enter the remote port to connect to. The must be the normal admin ssh port, not the CCS port.

[22]>

Would you like to join this appliance to a cluster using pre-shared keys?

To join this appliance to a cluster using pre-shared keys, log in to the cluster machine, run the `clusterconfig > prepjoin > command`, enter the following details, and commit your changes.

Host: `pod1226-esa07.ibesa`
 Serial Number: `42291A18D741EDB4C601-BC14E5579F34`
 User Key:

```
ssh-dss
AAAAB3NzaC1kc3MAAACBAJ6Xm+ja4aaU9n4DOcJs/gWgEDEUWgERYchhgWApKt6IW+s58I7knGM81rQgQbNdNCO58D
EqavGmP0VyB0TTpgvh6f0mr80OuTgWh9bqg4uiOjvbKv1TvDt0o7//mTklm159zr2KT/qFH+9L5i+8iIMX62R5y+a
6E8JV0BrJCNAAAFQCmK+WOU9HSribsC0f/5dVoADdxEwAAAI5p7NR74rlSrs0JWWYItNAtE1SamAN+ggCOdUWGPpHT
qdrtBilPQ9tfFoThZElqY4Tx81ku9laasoRLruQ2Z36R3bQGzIn4jzQqujvVbxTvLK9eLoSr8yFbEE3ZvuUo0+vhDn
LIDX2N65AQSqsTaOrKX+yQZ8yAVt48CsctpsDrgAAAIAVROGlWoS18g3FFm2eRTa+/oZ+cMjv+pSZiZoiUCoaIlouc
u1ZDpN413QBnf6p/3D8wVD8m5uo8O4N/HXasAMektZvGoP4Sf+shItPuISRv3lrMTEYsD0sqVcMc7vIXUeD2jpOk7MB
ooVktZB/rdTbNMfXrhDkNJ2IAPQQiUKVnw==
```

Before you proceed to the next step, make sure you add the 'Host', Serial Number' and 'User Key' details to the cluster machine.

Would you like to continue? [Y]> **yes**

Joining cluster group `Main_Group`.

Joining a cluster takes effect immediately, there is no need to commit.

Cluster **test_cluster**

Choose the operation you want to perform:

- ADDGROUP - Add a cluster group.
- SETGROUP - Set the group that machines are a member of.
- RENAMEGROUP - Rename a cluster group.
- DELETEGROUP - Remove a cluster group.
- REMOVEMACHINE - Remove a machine from the cluster.

```

- SETNAME - Set the cluster name.
- LIST - List the machines in the cluster.
- LISTDETAIL - List the machines in the cluster with detail.
- DISCONNECT - Temporarily detach machines from the cluster.
- RECONNECT - Restore connections with machines that were previously detached.
- PREPJOIN - Prepare the addition of a new machine over CCS.

[]>

(Cluster test_cluster)>

```

Adding Groups

All clusters must contain at least one group. When you create a new cluster, a default group called **Main_Group** is created automatically. However, you may decide to create additional groups within your cluster. This example shows how to create additional groups within an existing cluster and assign machines to the new group(s).

Procedure

-
- Step 1** Issue the **clusterconfig** command.
 - Step 2** Choose the **addgroup** subcommand and enter the name of the new group.
 - Step 3** Use the **setgroup** subcommand to choose machines for the new group.
-

Managing Clusters

Administering a Cluster from the CLI

For machines that are part of a cluster, the CLI can be switched into different modes. Recall that a mode refers to a specific, named, member of a level.

The CLI mode determines precisely where a configuration setting will be modified. The default is “machine” mode for the machine the user logged into, the “login host.”

Use the **clustermode** command to switch between different modes.

Table 155: Administering Clusters

Command Example	Description
<code>clustermode</code>	Prompt to switch cluster mode
<code>clustermode group northamerica</code>	Switch to group mode for the group “northamerica”

Command Example	Description
<code>clustermode machine losangeles.example.com</code>	Switch to machine mode for the machine “losangeles”

The prompt in the CLI changes to indicate your current mode.

```
(Cluster Americas)>
```

or

```
(Machine losangeles.example.com)>
```

In machine mode, the prompt will include the fully qualified domain name of the machine.

Copying and Moving Settings

All non-restricted (see [Restricted Commands, on page 1196](#)) commands have new operations: **CLUSTERSHOW** and **CLUSTERSET**. **CLUSTERSHOW** is used to show in which modes a command is configured (see [New Operation Added, on page 1196](#)). The **CLUSTERSET** operation allows you to move or copy the current settings (configurable with the current command) from one mode to another or between levels (e.g. from a machine to a group).

A *copy* retains the settings for the current mode. A *move* resets (clears) the configuration of the current mode; i.e., following a move, no settings will be configured for the current mode.

For example, if you have configured Good Neighbor Table settings (the **destconfig** command) for group **northamerica**, and you decide that you want the entire cluster to have these settings, you can use the **clusteraset** operation from within the **destconfig** command to copy (or move) the current settings to the cluster mode. (See [Experimenting with New Configurations, on page 1193](#).)



Caution

Exercise caution when moving or copying configuration settings to avoid inconsistent dependencies. For example, if you move or copy listeners with disclaimer stamping configured to another machine, and that new machine does not have the same disclaimers configured, disclaimer stamping will not be enabled on the new machine.

Experimenting with New Configurations

One of the most advantageous ways to use clusters is to experiment with new configuration settings. First you make changes at the machine mode, in an isolated environment. Then, when you are satisfied with your configuration, you move those configuration changes up to the cluster mode to make them available on all machines.

The following example shows the steps to change a listener setting on one machine and then publish the setting to the rest of the cluster when ready. Because listeners are normally configured at the cluster level, the example starts by pulling the configuration down to machine mode on one machine before making and testing the changes. You should test experimental changes of this type on one machine before making the change to the other machines in the cluster.

Procedure

- Step 1** Use the `clustermode cluster` command to change to the cluster mode.
- Remember: the `clustermode` command is the CLI command you use to change modes to the cluster, group, and machine levels.
- Step 2** Type `listenerconfig` to see the listener settings configured for the cluster.
- Step 3** Choose the machine you want to experiment with, then use the `clusterset` command to copy settings from the cluster “down” to machine mode.
- Step 4** Use the `clustermode` command to navigate to machine mode for the experimental machine, e.g.:
- ```
clustermode machine newyork.example.com
```
- Step 5** In machine mode, on the experimental machine, issue the `listenerconfig` command to make changes specifically for the experimental machine.
- Step 6** Commit the changes.
- Step 7** Continue to experiment with the configuration changes on the experimental machine, remembering to commit the changes.
- Step 8** When you are ready to apply your new settings to all the other machines, use the `clusterset` command to move the settings up to the cluster mode.
- Step 9** Commit the changes.
- 

## Leaving a Cluster Permanently (Removal)

You use the `REMOVEMACHINE` operation of `clusterconfig` to remove a machine permanently from a cluster. When a machine is permanently removed from a cluster, its configuration is “flattened” such that it will work the same as it did when it was part of the cluster. For example, if there is only a cluster-mode Global Unsubscribe table, the Global Unsubscribe table data will be copied to the machine’s local configuration when the machine is removed from the cluster.

## Upgrading Machines in a Cluster

A cluster does not allow the connected machines to have different versions of AsyncOS.

Before you install an AsyncOS upgrade, you need to disconnect each machine in the cluster via the `clusterconfig` command. After you upgrade all the machines, the cluster can be reconnected via the `clusterconfig` command. You can have two separate clusters running while you upgrade machines to the same version. You can also upgrade clustered machines on the GUI Upgrades page.

You can download the upgrade in the background so that you do not need to disconnect the cluster machines until you are ready to install the upgrade.



---

**Note** If you use the upgrade command before disconnecting the individual machine from the cluster, AsyncOS disconnects all the machines in the cluster. Cisco Systems recommends that you disconnect each machine from the cluster before upgrading it. Then, other machines can continue working as a cluster until each is disconnected and upgraded.

---



## Procedure

---

- Step 1** On a machine in the cluster, use the disconnect operation of clusterconfig . For example, to disconnect the machine losangeles.example.com , type clusterconfig disconnect losangeles .example.com. No commit is necessary.
- Step 2** Optionally, use the suspendlistener command to halt acceptance of new connections and messages during the upgrade process.
- Step 3** Issue the upgrade command to upgrade AsyncOS to a newer version.
- Note** Disregard any warnings or confirmation prompts about disconnecting all of the machines in the cluster. Because you have disconnected the machine, AsyncOS does not disconnect the other machines in the cluster at this point.
- Step 4** Select the version of AsyncOS for the machine. The machine will reboot after the upgrade is complete.
- Step 5** Use the resume command on the upgraded machine to begin accepting new messages.
- Step 6** Repeat steps 1 - 5 for each machine in the cluster.
- Note** After you disconnect a machine from the cluster, you cannot use it to change the configurations of other machines. Although you can still modify the cluster configuration, do not change it while machines are disconnected because settings can become unsynchronized.
- Step 7** After you have upgraded all the machines, use the reconnect operation of clusterconfig for each upgraded machine to reconnect it. For example, to reconnect the machine losangeles.example.com , type clusterconfig reconnect losangeles .example.com. Note that you can only connect a machine to a cluster that is running the same version of AsyncOS.
- 

## CLI Command Support

### All Commands Are Cluster-aware

All CLI commands in AsyncOS are now cluster-aware. The behavior of some commands will change slightly when issued in a cluster mode. For example, the behavior of the following commands changes when issued on a machine that is part of a cluster:

#### The commit and clearchanges Commands

##### commit

The commit command commits all changes for all three levels of the cluster, regardless of which mode you are currently in.

##### commitdetail

The commitdetail command provides details about configuration changes as they are propagated to all machines within a cluster.

## clearchanges

The `clearchanges` ( `clear` ) command clears all changes for all three levels of the cluster, regardless of which mode you are currently in.

## New Operation Added

### CLUSTERSHOW

Within each command, there is now a `CLUSTERSHOW` operation that allows you to see in which modes a command is configured.

When you enter a CLI command to perform an action that will be overridden by existing settings at a lower level, you will be presented with a notification. For example, if you are in cluster mode and enter a command, you may see a notification like this:

Note: Changes to these settings will not affect the following groups and machines because they are overriding the cluster-wide settings:

```
East_Coast, West_Coast
facilities_A, facilities_B, receiving_A
```

A similar message would be printed if you are editing settings for a group mode.

## Restricted Commands

Most CLI commands and their corresponding GUI pages can be run in any mode (cluster, group, or machine). However, some commands and pages are restricted to one mode only.

The system interface (either the GUI and the CLI) will always will make it clear that a command is restricted and how it is restricted. It is easy to switch to the appropriate mode for configuring the command.

- In the GUI, use the “Change Mode” menu or the “Settings for this features are currently defined at:” links to switch modes.
- In the CLI, use the `clustermode` command to switch modes.

**Table 156: Commands Restricted to Cluster Mode**

|                            |                         |
|----------------------------|-------------------------|
| <code>clusterconfig</code> | <code>sshconfig</code>  |
| <code>clustercheck</code>  | <code>userconfig</code> |
| <code>passwd</code>        |                         |

If a you try to run one of these commands in group or machine mode, you will be given a warning message and the opportunity to switch to the appropriate mode.



#### Note

The `passwd` command is a special case because it needs to be usable by guest users. If a guest user issues the `passwd` command on a machine in a cluster, it will not print the warning message but will instead just silently operate on the cluster level data without changing the user’s mode. All other users will get the above written behavior (consistent with the other restricted configuration commands).

The following commands are restricted to *machine mode* :

|                  |                  |              |                 |
|------------------|------------------|--------------|-----------------|
| antispamstatus   | etherconfig      | resume       | suspenddel      |
| antispamupdate   | featurekey       | resumedel    | suspendlistener |
| antivirusstatus  | hostrate         | resumelister | techsupport     |
| antivirusupdate  | hoststatus       | rollovernow  | tophosts        |
| bouncerecipients | interfaceconfig  | routeconfig  | topin           |
| deleterecipients | ldapflush        | sbstatus     | trace           |
| delivernow       | ldaptest         | setgateway   | version         |
| diagnostic       | nslookup         | sethostname  | vofflush        |
| dnsflush         | quarantineconfig | settime      | vofstatus       |
| dnslistflush     | rate             | shutdown     | workqueue       |
| dnslistttest     | reboot           | status       |                 |
| dnsstatus        | resetcounters    | suspend      |                 |

If a you try to run one of the commands above in cluster or group mode, you will be given a warning message and the opportunity to switch to an appropriate mode.

The following commands are further restricted to the *login host* (i.e., the specific machine you are logged into). These commands require access to the local file system.

**Table 157: Commands Restricted to Login Host Mode**

|      |                |        |         |
|------|----------------|--------|---------|
| last | resetconfig    | tail   | upgrade |
| ping | supportrequest | telnet | who     |

## Administering a Cluster from the GUI

Although you cannot create or join clusters or administer cluster specific settings from the GUI (the equivalent of the **clusterconfig** command), you can browse machines in the cluster, create, delete, copy, and move settings among the cluster, groups, and machines (that is, perform the equivalent of the **clustermode** and **clusterset** commands) from within the GUI.

The Incoming Mail Overview page is an example of a command that is restricted to the login host, because the Mail Flow Monitoring data you are viewing is stored on the local machine. To view the Incoming Mail Overview reports for another machine, you must log into the GUI for that machine.

Note the URL in the browser's address field when clustering has been enabled on an appliance. The URL will contain the word **machine**, **group**, or **cluster** as appropriate. For example, when you first log in, the URL of the Incoming Mail Overview page will appear as:

`https:// hostnamemachine/serial_number /monitor/incoming_mail_overview`



**Note** The Incoming Mail Overview and Incoming Mail Details pages on the Monitor menu are restricted to the login machine.

The Mail Policies, Security Services, Network, and System Administration tabs contain pages that are not restricted to the local machine. If you click the Mail Policies tab, the centralized management information in the GUI changes.

**Figure 80: Centralized Management Feature in the GUI: No Settings Defined**

The screenshot shows the 'Incoming Mail Policies' page. At the top, the mode is set to 'Machine: example.com'. Below this, there are 'Centralized Management Options' including 'Inheriting settings from Cluster: americas' and an 'Override Settings' link. A section indicates 'Settings for this feature are currently defined at: Cluster: americas'. There is a 'Find Policies' section with an 'Email Address' input field and radio buttons for 'Recipient' and 'Sender'. Below that is a table of policies:

| Order | Policy Name    | Anti-Spam                                            | Anti-Virus                                                                             | Virus Outbreak Filters | Content Filters | Delete |
|-------|----------------|------------------------------------------------------|----------------------------------------------------------------------------------------|------------------------|-----------------|--------|
|       | Default Policy | IronPort<br>Positive: Deliver<br>Suspected: Disabled | Repaired: Deliver<br>Encrypted: Deliver<br>Uncannable: Deliver<br>Virus Positive: Drop | Enabled                | Disabled        |        |

At the bottom right, there is a legend: Key: Default Custom Disabled.

In the above figure, the machine is inheriting all of its configuration settings for the current feature from the cluster mode. The settings being inherited in a light grey (preview). You can retain these settings or change them, overriding the cluster level settings for this machine.



**Note** The inherited settings (preview display) will always show the settings inherited from the cluster. Use caution when enabling or disabling dependent services among group and cluster levels. For more information, see [Copying and Moving Settings, on page 1193](#).

If you click the Override Settings link, you are taken to a new page for that feature. This page allows you to create new configuration settings for machine mode. You may begin with the default settings, or, if you've already configured settings in another mode, you can copy those settings to this machine.

**Figure 81: Centralized Management Feature in the GUI: Create New Settings**



Alternatively, as shown in *Figure Centralized Management Feature in the GUI: No Settings Defined*, you can also navigate to modes where this configuration setting is already defined. The modes are listed in the lower half of the centralized management box, under “Settings for this feature are currently defined at:”. Only those modes where the settings are actually defined will be listed here. When you view a page for settings that are defined in (and inherited from) another mode, the page will display those settings for you.

If you click on one of the listed modes (for example, the Cluster: Americas link as shown in *Figure Centralized Management Feature in the GUI: No Settings Defined*), you will be taken to a new page that allows you to view and manage the settings for that mode.

**Figure 82: Centralized Management Feature in GUI: Settings Defined**

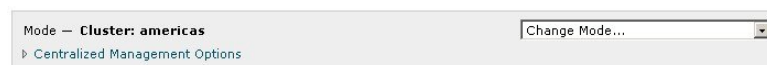

When settings are defined for a given mode, the centralized management box is displayed on every page in a minimized state. Click the “Centralized Management Options” link to expand the box to show a list of options available for the current mode with respect to the current page. Clicking the “Manage Settings” button allows you to copy or move the current settings to a different mode or to delete those settings completely.

For example, in the following figure, the Centralized Management Options link has been clicked to present the available options.

**Figure 83: Centralized Management Feature in GUI: Manage Settings**



On the right side of the box is the “Change Mode” menu. This menu displays your current mode and provides the ability to navigate to any other mode (cluster, group, or machine) at any time.

**Figure 84: The Change Mode Menu**

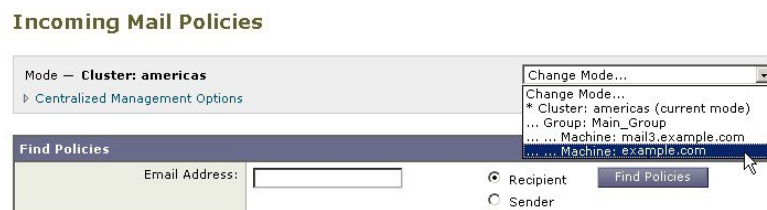

When you navigate to a page that represents a different mode, the “Mode —” text on the left side of the centralized management box will flash yellow, briefly, to alert you that your mode has changed.

Some pages within certain tabs are restricted to machine mode. However, unlike the Incoming Mail Overview page (which is restricted to the current login host), these pages can be used for any machine in the cluster.

**Figure 85: Centralized Management Feature: Machine Restricted**



Choose which machine to administer from the Change Mode menu. You will see a brief flashing of the text to remind you that you have changed modes.

## Cluster Communication

Machines within a cluster communicate with each other using a mesh network. By default, all machines connect to all other machines. If one link goes down, other machines will not be prevented from receiving updates.

By default, all intra-cluster communication is secured with SSH. Each machine keeps an in-memory copy of the route table and makes in-memory changes as necessary if links go down or up. Each machine also performs a periodic “ping” (every 1 minute) of every other machine in the cluster. This ensures up-to-date link status and maintains the connections in case a router or NAT has a timeout.



### Note

If your appliances are in a cluster mode, and you plan to access data (not related to configuration, for example, viewing messages present in the quarantine or refreshing reports at a fast rate) of another appliance remotely; there will be cluster reconnection attempts that can generate alerts and errors. The appliances automatically will reconnect and manual intervention is not required.

## DNS and Hostname Resolution

DNS is required to connect a machine to the cluster. Cluster communication is normally initiated using the DNS hostnames of the machines (not the hostname of an interface on the machine). A machine with an unresolvable hostname would be unable to actually communicate with any other machines in the cluster, even though it is technically part of the cluster.

Your DNS must be configured to have the hostname point to the correct IP interface on the appliance that has SSH or CCS enabled. This is very important. If DNS points to another IP address that does not have SSH or CCS enabled it will not find the host. Note that centralized management uses the “main hostname,” as set with the `sethostname` command, not the per-interface hostname.

If you use an IP address to connect to another machine in the cluster, the machine you connect to must be able to make a reverse look up of the connecting IP address. If the reverse look up times out because the IP address isn't in the DNS, the machine cannot connect to the cluster.

## Clustering, Fully Qualified Domain Names, and Upgrading

DNS changes can cause a loss of connectivity after upgrading AsyncOS. Please note that if you need to change the fully qualified domain name of a machine in the cluster (not the hostname of an interface on a machine

in the cluster), you must change the hostname settings via `sethostname` and update the DNS record for that machine *prior* to upgrading AsyncOS.

## Cluster Communication Security

Cluster Communication Security (CCS) is a secure shell service similar to a regular SSH service. Cisco implemented CCS in response to concerns regarding using regular SSH for cluster communication. SSH communication between two machines opens regular logins (admin, etc.) on the same port. Many administrators prefer not to open regular logins on their clustered machines.

Tip: never enable Cluster Communication Services, even though it is the default, unless you have firewalls blocking port 22 between some of your clustered machines. Clustering uses a full mesh of SSH tunnels (on port 22) between all machines. If you have already answered Yes to enabling CCS on any machine, remove all machines from the cluster and start again. Removing the last machine in the cluster removes the cluster.

CCS provides an enhancement where the administrator can open up cluster communication, but not CLI logins. By default, the service is disabled. You will be prompted to enable CCS from the `interfaceconfig` command when you are prompted to enable other services. For example:

```
Do you want to enable SSH on this interface? [Y]>
```

```
Which port do you want to use for SSH?
```

```
[22]>
```

```
Do you want to enable Cluster Communication Service on this interface?
```

```
[N]> y
```

```
Which port do you want to use for Cluster Communication Service?
```

```
[2222]>
```

The default port number for CCS is 2222. You may change this to another open, unused, port number if you prefer. After the join is complete and the joining machine has all the configuration data from the cluster, the following question is presented:

```
Do you want to enable Cluster Communication Service on this interface? [N]> y
```

```
Which port do you want to use for Cluster Communication Service?
```

```
[2222]>
```

## Cluster Consistency

The machines that are “cluster aware” will continually verify network connections to other machines within the cluster. This verification is done by periodic “pings” sent to other machines in the cluster.

If all attempts to communicate with a particular machine fail, then the machine that has been trying to communicate will log a message saying that the remote host has disconnected. The system will send an alert to the administrator that the remote host went down.

Even if a machine is down, the verification pings will continue to be sent. When a machine rejoins the cluster network, a synchronization command will be issued so that any previously offline machines can download any updates. The synchronization command will also determine if there have been any changes on one side but not the other. If so, then the previously down machine will silently download the updates.

## Disconnect/Reconnect

A machine may be disconnected from a cluster. Occasionally, you may intend to deliberately disconnect the machine, for example, because you are upgrading the machine. A disconnect could also occur by accident, for example, due to a power failure or other software or hardware error. A disconnect can also occur if one appliance attempts to open more than the maximum number of SSH connections allowed in a session. A machine that is disconnected from a cluster can still be accessed directly and configured; however, any changes made will not be propagated to other machines within the cluster until the disconnected machine becomes reconnected.

When a machine reconnects to the cluster, it tries to reconnect to all machines at once.

In theory, two machines in a cluster that are disconnected could commit a similar change to their local databases at the same time. When the machines are reconnected to the cluster, an attempt will be made to synchronize these changes. If there is a conflict, the most recent change is recorded (supersedes any other changes).

During a commit, the appliance checks every variable that is being changed. The commit data includes version information, sequence identification numbers, and other information that can be compared. If the data you are about to change is found to be in conflict with previous changes, you will be given the option to discard your changes. For example, you might see something like this:

```
(Machine mail3.example.com)> clustercheck

This command is restricted to "cluster" mode. Would you like to switch to "cluster"
mode? [Y]> y

Checking Listeners (including HAT, RAT, bounce profiles)...

Inconsistency found!

Listeners (including HAT, RAT, bounce profiles) at Cluster enterprise:

mail3.example.com was updated Mon Sep 12 10:59:17 2005 PDT by 'admin' on
mail3.example.com

test.example.com was updated Mon Sep 12 10:59:17 2005 PDT by 'admin' on
mail3.example.com

How do you want to resolve this inconsistency?

1. Force entire cluster to use test.example.com version.

2. Force entire cluster to use mail3.example.com version.

3. Ignore.

[1]>
```

If you choose not to discard your changes, they are still intact (but uncommitted). You can review your changes against the current settings and decide how to proceed.

You can also use the `clustercheck` command at any time to verify that the cluster is operating correctly.

```
losangeles> clustercheck

Do you want to check the config consistency across all machines in the cluster? [Y]> y
```



```
Checking losangeles...
Checking newyork...
No inconsistencies found.
```

## Interdependent Settings

It is recommended that you avoid configuring the following settings on the appliance .

In a centrally managed environment, some interdependent settings are configured in different modes. The flexibility of the configuration model allows you to configure settings at multiple modes, and the laws of inheritance govern which settings will be used on a per-machine basis. However, some settings have dependencies on other settings, and the availability of the dependent settings' configuration is not limited to settings at the same mode. Thus, it is possible to configure a setting for one level that references a setting that is configured for a specific machine at a different level.

The most common example of an interdependent setting involves a select field on a page that pulls data from a different cluster section. For example, the following features can be configured in different modes:

- using LDAP queries
- using dictionaries or text resources
- using bounce or SMTP authentication profiles.

Within centralized management, there are restricted and non-restricted commands. (See [Restricted Commands, on page 1196](#).) Non-restricted commands are generally configuration commands that can be shared across the cluster.

The **listenerconfig** command is an example of a command that can be configured for all machines in a cluster. Non-restricted commands represent commands that can be mirrored on all machines in a cluster, and do not require machine-specific data to be modified.

Restricted commands, on the other hand, are commands that only apply to a specific mode. For example, users cannot be configured for specific machines — there must be only one user set across the whole cluster. (Otherwise, it would be impossible to login to remote machines with the same login.) Likewise, since the Mail Flow Monitor data, System Overview counters, and log files are only maintained on a per-machine basis, these commands and pages must be restricted to a machine.

You will notice that while Scheduled Reports may be configured identically across the whole cluster, the viewing of reports is machine-specific. Therefore, within a single Scheduled Reports page in the GUI, configuration must be performed at the cluster mode, but viewing of reports must be done at the machine mode.

The System Time pages encompass the **settz** , **ntpconfig** , and **settime** commands, and thus represents a mixture of restricted and non-restricted commands. In this case, **settime** must be restricted to machine-only modes (since time settings are specific for machine), while **settz** and **ntpconfig** may be configured at cluster or group modes.

Figure 86: Example of Interdependent Settings

In this representation, the listener “IncomingMail” is referencing a footer named “disclaimer” that has been configured at the machine level only. The drop-down list of available footer resources shows that the footer is not available on the machine “buttercup.run” which is also available in the cluster. There are two solutions to this dilemma:

- promote the footer “disclaimer” from the machine level to the cluster level
- demote the listener to the machine level to remove the interdependency

In order to fully maximize the features of a centrally managed system, the former solution is preferred. Be aware of interdependencies among settings as you tailor the configuration of your clustered machines.

## Loading a Configuration in Clustered Appliances

AsyncOS allows you to load a cluster configuration in clustered appliances . You can load the cluster configuration in the following scenarios:

- If you are migrating from an on-premise environment to a hosted environment and you want to migrate the on-premise cluster configuration to the hosted environment.
- If an appliance in a cluster is down or needs to be retired and you want to load the configuration from this appliance to a new appliance that you plan to add to the cluster.
- If you are adding more appliances to your cluster and you want to load the configuration from one of the existing appliances in the cluster to the newly added appliances .
- If you want to load a backed-up configuration to a cluster.

Depending on your requirements, you can load a cluster configuration or appliance configuration from a valid cluster configuration file.



### Note

You cannot load the configuration of a standalone appliance on a clustered appliance .

### Before You Begin

- Make sure that you have a valid and complete XML configuration. See [Loading a Configuration File, on page 997](#).
- Create a backup of the current configuration of the appliance to which you plan to load the configuration. See [Saving and Exporting the Current Configuration File, on page 996](#).
- Create a cluster setup with all the appliances that you plan to have in your setup. See [Creating and Joining a Cluster, on page 1186](#).



**Note** You can have all the appliances under one group. Ensure that the interfaces for cluster communication in your setup have same names and SSH and CCS settings as in the XML configuration.

---

### Procedure

---

- Step 1** Click **System Administration > Configuration File**.
- Step 2** Choose the cluster from the **Mode** drop-down menu.
- Step 3** Depending on whether you want to load cluster or appliance configuration, do one of the following:
- **Load Cluster Configuration**
    - a. In the Load Configuration section, choose **Cluster** from the drop-down list.
    - b. Load the cluster configuration, and click **Load**. See [Loading a Configuration File, on page 997](#).
    - c. Assign groups from the loaded configuration to the appliances in the cluster, and copy appliance configuration from the appliances in the selected group to the respective appliances. Use the **Group Configuration** and **Appliance Configuration** drop-down lists.

If you do not want to copy an appliance configuration, choose **Don't Copy** from the **Appliance Configuration** drop-down list.

      1. Review the configuration. Click **Review**.
      2. Click **Confirm**.
      3. Click **Continue**.
  - **Load Appliance Configuration**
    - a. In the Load Configuration section, choose **Appliance in cluster** from the drop-down list.
    - b. Load the configuration, and click **Load**. See [Loading a Configuration File, on page 997](#). Note that you cannot load the configuration of a standalone appliance on a clustered appliance.
    - c. Choose the appliance configuration from the loaded configuration and the intended appliance in the cluster to which you want to load the configuration. Use the drop-down lists.
    - d. Click **OK**.
    - e. Click **Continue**.
    - f. To load the appliance configuration to more appliances, repeat Step a through Step e.
- Step 4** Review the network settings of the clustered appliances, and commit your changes.
-

# Best Practices and Frequently Asked Questions

## Best Practices

When you create the cluster, the machine you happen to be logged into is automatically added to the cluster as the first machine, and also added to the Main\_Group. Its machine level settings effectively get moved to the cluster level as much as possible. There are no settings at the group level, and the only settings left at the machine level are those which do not make sense at the cluster level, and cannot be clustered. Examples are IP addresses, featurekeys, etc.

Leave as many settings at the cluster level as possible. If only one machine in the cluster needs a different setting, copy that cluster setting to the machine level for that machine. Do not move that setting. If you move a setting which has no factory default (e.g. HAT table, SMTPROUTES table, LDAP server profile, etc.), the systems inheriting the cluster settings will have blank tables and will probably not process email.

To have that machine re-inherit the cluster setting, manage the CM settings and delete the machine setting. You will only know if a machine is overriding the cluster setting when you see this display:

Settings are defined:

To inherit settings from a higher level: Delete Settings for this feature at this mode.

You can also Manage Settings.

Settings for this feature are also defined at:

**Cluster:** **xxx**

Or this display:

Delete settings from:

**Cluster:** **xxx**

**Machine:** **yyyy.domain.com**

## Copy vs Move

When to copy: when you want the cluster to have a setting, and a group or machine to also have no settings or to have different settings.

When to move: when you want the cluster to have no setting at all, and for the group or machine to have the settings.

## Good CM Design Practices

When you LIST your CM machines, you want to see something like this:

cluster = CompanyName

Group Main\_Group:

Machine lab1.example.com (Serial #: XXXXXXXXXXXXX-XXXXXXX)

Machine lab2.example.com (Serial #: XXXXXXXXXXXXX-XXXXXXX)

Group Paris:

Machine lab3.example.com (Serial #: XXXXXXXXXXXXX-XXXXXXX)

Machine lab4.example.com (Serial #: XXXXXXXXXXXXX-XXXXXXX)

Group Rome:

Machine lab5.example.com (Serial #: XXXXXXXXXXXXX-XXXXXXX)

Machine lab6.example.com (Serial #: XXXXXXXXXXXXX-XXXXXXX)

Be careful not to lose track of the level at which you are making changes. For example, if you have changed the name of your Main\_Group (using RENAMEGROUP) to London, it will look like this:

```
cluster = CompanyName
```

Group London:

```
Machine lab1.cable.nu (Serial #: 000F1FF7B3F0-CF2SX51)
```

...

However, this configuration tends to confuse many administrators, because they begin making changes to the London systems at the group level, and they stop using the Cluster level as the normal configuration level for basic settings.

**Tip:** it is not a good practice to have a group with the same name as the cluster, e.g. cluster London, group London. If you are using site names for group names, it is not good practice to have a cluster name that refers to a location.

The correct method, as explained above, is to leave as many settings at the cluster level as possible. In most cases you should leave your primary site or main collection of machines in the Main\_Group, and use groups for your additional sites. This is true even if you consider that both sites are “equal.” Remember, CM has no primary/secondary servers — all clustered machines are peers.

**Tip:** if you will be using extra groups you can easily prepare the groups before those extra machines are joined to the cluster.

## Best Practices for Accessing Spam or Policy Quarantines in Cluster Setup

Accessing spam or policy quarantines of other appliances in a cluster from the logged-in appliance may cause excessive CPU usage on the logged-in appliance. To avoid this scenario, you can access the spam or policy quarantines by logging into the required appliances.

## Procedures: Configuring an Example Cluster

To configure this example cluster, log out of all GUIs on all machines before running clusterconfig . Run clusterconfig on any one of the primary site machines. You will then join to this cluster only the other local and remote machines that need the maximum possible shared settings (allowing for the machine only-settings like IP address). The clusterconfig command cannot be used to join a remote machine to the cluster — you must use the CLI on the remote machine and run clusterconfig (“join an existing cluster”).

In our example above we log in to lab1, run clusterconfig and create a cluster called CompanyName. We have only one machine with identical requirements, so we log in to lab2, and saveconfig the existing configuration (it will be drastically altered when it inherits most of lab1 settings.) On lab2 we can then use clusterconfig to join an existing cluster. Repeat if you have additional machines at this site needing similar policies and settings.

Run CONNSTATUS to confirm that DNS resolves correctly. As machines are joined to the cluster, the new machines inherit almost all of their settings from lab1 and their older settings are lost. If they are production

machines you will need to anticipate if mail will still be processed using the new configuration instead of their previous configuration. If you remove them from the cluster, they will not revert to their old, private configs.

Next, we count the number of exceptional machines. If there is only one, it should receive a few extra machine level settings and you will not need to create an extra group for it. Join it to the cluster and begin copying settings down to the machine level. If this machine is an existing production machine you must back up the configuration and consider the changes to mail processing as above.

If there are two or more, as in our example, decide if those two will share any settings with each other that are not shared with the cluster. In that case, you will be creating one or more groups for them. Otherwise, you will make machine level settings for each, and do not need to have extra groups.

In our case we want to run `clusterconfig` from the CLI on any of the machines already in the cluster, and select `ADDGROUP`. We will do this twice, once for Paris and once for Rome.

Now you can begin using the GUI and CLI to build configuration settings for the cluster and for ALL the groups, even if the groups have no machines in them yet. You will only be able to create machine specific settings for machines *after* they have joined the cluster.

The best way to create your override or exceptional settings is to copy the settings from the higher (e.g. cluster) level down to a lower (e.g. group) level.

For example, after creating the cluster our `dnsconfig` settings initially looked like this:

Configured at mode:

Cluster: Yes

Group Main\_Group: No

Group Paris: No

Group Rome: No

Machine lab2.cable.nu: No

If we "Copy to Group" the DNS settings, it will look like this:

Configured at mode:

Cluster: Yes

Group Main\_Group: No

Group Paris: Yes

Group Rome: No

Machine lab2.cable.nu: No

Now you can edit the Paris group-level DNS settings, and other machines in the Paris group will inherit them. Non-Paris machines will inherit the cluster settings, unless they have machine-specific settings. Besides DNS settings, it is common to create group level settings for `SMTPROUTES`.



---

**Tip**

When using the CLI `CLUSTERSET` function in various menus, you can use a special option to copy settings to All Groups, which is not available through the GUI.

Complete listeners will be automatically inherited from the group or cluster, and you normally only create these on the first system in the cluster. This reduces administration considerably. However, for this to work *you must name the Interfaces identically throughout your group or cluster*.

---

Once the settings are defined correctly at the group level, you can join machines to the cluster and make them part of this group. This requires two steps:

First, to join our remaining 4 systems to the cluster, we run `clusterconfig` on each. The larger and more complex the cluster, the longer it takes to join, and this can take several minutes. You can monitor the joining progress with the `LIST` and `CONNSTATUS` sub-commands. After the joins are complete you can use `SETGROUP` to move the machines from the `Main_Group` into `Paris` and `Rome`. There is no way to avoid the fact that initially, all machines added to the cluster inherit the `Main_Group` settings, not the `Paris` and `Rome` settings. This could affect mail flow traffic if the new systems are already in production.



**Tip** Do not make your lab machines part of the same cluster as your production machines. Use a new cluster name for lab systems. This provides an added layer of protection against unexpected changes (someone changing a lab system and accidentally losing production mail, for example).

## Summary of GUI Options for Using CM Settings Other Than the Cluster Default

Override settings, and start with default settings. For example, the default settings for the `SMTPROUTES` configuration is a blank table, which you can then build from scratch.

Override settings, but start with a copy of the settings currently inherited from Cluster xxx, or group yyy. For example, you may want a new copy of the `SMTPROUTES` table at the group level which is initially identical to the cluster table. All appliances that are contained in that same group (`SETGROUP`) will get this table. Machines not in the group will still use the cluster level settings. Changing the `SMTPROUTES` on this independent copy of the table will not affect other groups, machines inheriting the cluster settings, or machines where the setting is defined at the individual machine level. This is the most common selection.

Manage settings, a sub-menu of Centralized Management Options. From this menu you can copy as above, but you can also move or delete settings. If you move the `SMTPROUTES` to a group or machine level, then the routes table will be blank at the cluster level but will exist at the more specific level.

Manage settings. Continuing our `SMTPROUTES` example, using the delete option will also result in a blank `SMTPROUTES` table for the cluster. This is fine if you previously configured definitions for `SMTPROUTES` at the group level or machine levels. It is not a best practice to delete the cluster level settings and rely only on group or machine settings. The cluster-wide settings are useful as defaults on newly added machines, and keeping them reduces the number of group or site settings you have to maintain by one.

## Setup and Configuration Questions

**Q.** I have a previously configured standalone machine and I join an existing cluster. What happens to my settings?

**A.** When a machine joins a cluster, all of that machine's clusterable settings will be inherited from the cluster level. Upon joining a cluster, all locally configured non-network settings will be lost, overwritten with the settings of the cluster and any associated groups. (This includes the user/passphrase table; passphrases and users are shared within a cluster).

**Q.** I have a clustered machine and I remove it (permanently) from the cluster. What happens to my settings?

**A.** When a machine is permanently removed from a cluster, its configuration hierarchy is "flattened" such that the machine will continue to work the same as it did when it was part of the cluster. All settings that the machine has been inheriting will be applied to the machine in the standalone setting.

For example, if there is only a cluster-mode Global Unsubscribe table, that Global Unsubscribe table data will be copied to the machine's local configuration when the machine is removed from the cluster.

## General Questions

**Q.** Are log files aggregated within centrally managed machines?

**A.** No. Log files are still retained for each individual machines. The Security Management appliance can be used to aggregate mail logs from multiple machines for the purposes of tracking and reporting.

**Q.** How does User Access work?

**A.** The appliance share one database for the entire cluster. In particular, there is only admin account (and passphrase) for the entire cluster.

**Q.** How should I cluster a data center?

**A.** Ideally, a data center would be a “group” within a cluster, not its own cluster. However, if the data centers do not share much between themselves, you may have better results with separate clusters for each data center.

**Q.** What happens if systems are offline and they reconnect?

**A.** Systems attempt to synchronize upon reconnecting to the cluster.

## Network Questions

**Q.** Is the centralized management feature a “peer-to-peer” architecture or a “primary/secondary” architecture?

**A.** Because every machine has all of the data for all of the machines (including all machine-specific settings that it will never use), the centralized management feature can be considered a peer-to-peer architecture.

**Q.** How do I set up a box so it is not a peer? I want a “secondary” system.

**A.** Creating a true “secondary” machine is not possible with this architecture. However, you can disable the HTTP (GUI) and SSH (CLI) access at the machine level. In this manner, a machine without GUI or CLI access *only* be configured by clusterconfig commands (that is, it can never be a login host). This is similar to having a secondary machine, but the configuration can be defeated by turning on login access again.

**Q.** Can I create multiple, segmented clusters?

**A.** Isolated “islands” of clusters are possible; in fact, there may be situations where creating them may be beneficial, for example, for performance reasons.

**Q.** I would like to reconfigure the IP address and hostname on one of my clustered appliances . If I do this, will I lose my GUI/CLI session before being able to run the reboot command?

**A.** Follow these steps:

1. Add the new IP address
2. Move the listener onto the new address
3. Leave the cluster
4. Change the hostname
5. Make sure that oldmachinename does not appear in the clusterconfig connections list when viewed from any machine
6. Make sure that all GUI sessions are logged out
7. Make sure that CCS is not enabled on any interface (check via interfaceconfig or Network > Listeners)
8. Add the machine back into the cluster



**Q.** Can the Destination Controls function be applied at the cluster level, or is it local machine level only?

**A.** It may be set at a cluster level; however, the limits are on a per-machine basis. So if you limit to 50 connections, that is the limit set for each machine in the cluster.

## Planning and Configuration

**Q.** What can I do to maximize efficiency and minimize problems when setting up a cluster?

**1.** Initial Planning

- Try to configure as many things as possible at the cluster level.
- Manage by machines only for the exceptions.
- If you have multiple data centers, for example, use groups to share traits that are neither cluster-wide nor necessarily machine-specific.
- Use the same name for Interfaces and Listeners on each of the appliances .

**2.** Be aware of restricted commands.

**3.** Pay attention to interdependencies among settings.

For example, the `listenerconfig` command (even at the cluster level) depends on interfaces that only exist at a machine level. If the interface does not exist at the machine level on all machines in the cluster, that listener will be disabled.

Note that deleting an interface would also affect `listenerconfig` .

**4.** Pay attention to your settings!

Remember that previously-configured machines will lose their independent settings upon joining a cluster. If you want to re-apply some of these previously configured settings at the machine level, be sure to take note of all settings before joining the cluster.

Remember that a “disconnected” machine is still part of the cluster. When it is reconnected, any changes you made while it was offline will be synchronized with the rest of the cluster.

Remember that if you permanently remove a machine from a cluster, it will retain all of the settings it had as part of that cluster. However, if you change your mind and re-join the cluster, the machine will lose all standalone settings.

Use the `saveconfig` command to keep records of settings.





## CHAPTER 45

# Testing and Troubleshooting

---

This chapter contains the following sections:

- [Debugging Mail Flow Using Test Messages: Trace](#), on page 1213
- [Using the Listener to Test the Appliance](#) , on page 1219
- [Troubleshooting the Network](#), on page 1222
- [Troubleshooting the Listener](#), on page 1227
- [Troubleshooting Email Delivery From the Appliance](#), on page 1229
- [Troubleshooting Performance](#), on page 1231
- [Web Interface Appearance and Rendering Issues](#) , on page 1232
- [Responding to Alerts](#) , on page 1232
- [Troubleshooting Hardware Issues](#) , on page 1232
- [Remotely Resetting Appliance Power](#) , on page 1232
- [Working with Technical Support](#), on page 1233

## Debugging Mail Flow Using Test Messages: Trace

You can use **System Administration > Trace** page (the equivalent of the trace command in the CLI) to debug the flow of messages through the system by emulating sending a test message. The Trace page (and **trace** CLI command) emulates a message as being accepted by a listener and prints a summary of features that would have been “triggered” or affected by the current configuration of the system (*including uncommitted changes* ). The test message is not actually sent. The Trace page (and **trace** CLI command) can be a powerful troubleshooting or debugging tool, especially if you have combined many of the advanced features available on the Cisco appliance .



---

**Note** Trace is not effective for testing file reputation scanning.

---

The Trace page (and **trace** CLI command) prompts you for the input parameters listed in the following table.

Table 158: Input for the Trace page

| Value                                        | Description                                                                                                                                                                                                                                                                                                                                                                                                                                                                                                                                        | Example                                                       |
|----------------------------------------------|----------------------------------------------------------------------------------------------------------------------------------------------------------------------------------------------------------------------------------------------------------------------------------------------------------------------------------------------------------------------------------------------------------------------------------------------------------------------------------------------------------------------------------------------------|---------------------------------------------------------------|
| Source IP address                            | Type the IP address of the remote client to mimic the source of the remote domain. This can be an Internet Protocol version 4 (IPv4) or version 6 (IPv6) address.<br><br>Note: The trace command prompts for an IP address and a fully-qualified domain name. It does <i>not</i> attempt to reverse the IP address to see if it matches the fully-qualified domain name. The trace command does not allow the fully-qualified domain name field to be blank, so it is impossible to test a scenario where the DNS does not reverse match properly. | <b>203.45.98.109</b><br><b>2001:0db8:85a3::8a2e:0370:7334</b> |
| Fully Qualified Domain Name of the Source IP | Type the fully-qualified remote domain name to mimic. If left null, a reverse DNS lookup will be performed on the source IP address.                                                                                                                                                                                                                                                                                                                                                                                                               | <b>smtp.example.com</b>                                       |
| Listener to Trace Behavior on                | Choose from the list of listeners configured on the system to emulate sending the test message to.                                                                                                                                                                                                                                                                                                                                                                                                                                                 | <b>InboundMail</b>                                            |
| Network Owner Organization ID                | Type the unique identification number of the network owner, or allow the system to Lookup network owner ID associated with source IP address. You can view this information if you added network owners to sender groups via the GUI.                                                                                                                                                                                                                                                                                                              | <b>34</b>                                                     |
| IP Reputation Score                          | Type the IP Reputation score you want to provide for the spoofed domain, or allow the system to look up the IP Reputation score associated with the source IP address. This can be helpful when testing policies that use IP Reputation scores. Note that manually entered IP Reputation scores are not passed to the Context Adaptive Scanning Engine (CASE). See <a href="#">Editing IP Reputation Filtering Score Thresholds for a Listener</a> , on page 88 for more information.                                                              | <b>-7.5</b>                                                   |
| Envelope Sender                              | Type the Envelope Sender of the test message.                                                                                                                                                                                                                                                                                                                                                                                                                                                                                                      | <b>admin@example.net</b>                                      |
| Envelope Recipients                          | Type a list of recipients for the test message. Separate multiple entries with commas.                                                                                                                                                                                                                                                                                                                                                                                                                                                             | <b>joe</b><br><b>frank@example.com</b>                        |

| Value        | Description                                                                                                                                                                                                                                                                                                           | Example                                                                                        |
|--------------|-----------------------------------------------------------------------------------------------------------------------------------------------------------------------------------------------------------------------------------------------------------------------------------------------------------------------|------------------------------------------------------------------------------------------------|
| Message Body | Type the message body for the test message, including headers. Type a period on a separate line to end entering the message body. Note that “headers” are considered part of a message body (separated by a blank line), and omitting headers, or including poorly formatted ones can cause unexpected trace results. | <b>To: 1@example.com</b><br>From: ralph<br>Subject: Test<br><b>this is a test message</b><br>. |

After you have entered the values, click **Start Trace**. A summary of all features configured on the system affecting the message is printed.

You can upload message bodies from your local file system. (In the CLI, you can test with message bodies you have uploaded to the `/configuration` directory. See [FTP, SSH, and SCP Access, on page 1261](#) for more information on placing files for import onto the Cisco appliance.)

After the summary is printed, you are prompted to view the resulting message and re-run the test message again. If you enter another test message, the Trace page and the trace command uses any previous values from the above table you entered.



**Note** The sections of configuration tested by the trace command listed in the following table are performed *in order*. This can be extremely helpful in understanding how the configuration of one feature affects another. For example, a recipient address transformed by the domain map feature will affect the address as it is evaluated by the RAT. A recipient that is affected by the RAT will affect the address as it is evaluated by alias table, and so on.

**Table 159: Viewing Output When Performing a Trace**

| trace Command Section                                                                                                                                                                                                                                                                                                                         | Output                                                                                                                                                                                                                                                                                                                                                                                                                                                                                                                                                                                                                                              |
|-----------------------------------------------------------------------------------------------------------------------------------------------------------------------------------------------------------------------------------------------------------------------------------------------------------------------------------------------|-----------------------------------------------------------------------------------------------------------------------------------------------------------------------------------------------------------------------------------------------------------------------------------------------------------------------------------------------------------------------------------------------------------------------------------------------------------------------------------------------------------------------------------------------------------------------------------------------------------------------------------------------------|
| Host Access Table (HAT) and Mail Flow Policy Processing                                                                                                                                                                                                                                                                                       | <p>The Host Access Table settings for the listener you specified are processed. The system reports which entry in the HAT matched from the remote IP address and remote domain name you entered. You can see the default mail flow policies and sender groups and which one matched the given entries.</p> <p>If the Cisco appliance was configured to reject the connection (either through a REJECT or TCPREFUSE access rule), the trace command exits at the point in the processing.</p> <p>For more information on setting HAT parameters, see <a href="#">Understanding Predefined Sender Groups and Mail Flow Policies, on page 102</a>.</p> |
| <p><b>Envelope Sender Address Processing</b></p> <p>These sections summarize how the appliance configuration affects the Envelope Sender you supply. (That is, how the MAIL FROM command would be interpreted by the configuration of the appliance.) The <b>trace</b> command prints “<b>Processing MAIL FROM:</b>” before this section.</p> |                                                                                                                                                                                                                                                                                                                                                                                                                                                                                                                                                                                                                                                     |

| trace Command Section                                                                                                                                                                                                                                                                                                 | Output                                                                                                                                                                                                                                                                                                                                                                             |
|-----------------------------------------------------------------------------------------------------------------------------------------------------------------------------------------------------------------------------------------------------------------------------------------------------------------------|------------------------------------------------------------------------------------------------------------------------------------------------------------------------------------------------------------------------------------------------------------------------------------------------------------------------------------------------------------------------------------|
| Default Domain                                                                                                                                                                                                                                                                                                        | <p>If you specified that a listener to change the default sender domain of messages it receives, any change to the Envelope Sender is printed in this section.</p> <p>For more information, see <a href="#">Configuring the Gateway to Receive Email, on page 69</a>.</p>                                                                                                          |
| Masquerading                                                                                                                                                                                                                                                                                                          | <p>If you specified that the Envelope Sender of a message should be transformed, the change is noted here. You enable masquerading for the Envelope Sender on private listeners using the <b>listenerconfig -&gt; edit -&gt; masquerade -&gt; config subcommands</b>.</p> <p>For more information, see <a href="#">Configuring Routing and Delivery Features, on page 671</a>.</p> |
| <p><b>Envelope Recipient Processing</b></p> <p>These sections summarize how the appliance affects the Envelope Recipients you supply. (That is, how the RCPT TO command would be interpreted by the configuration of the appliance.) The trace command prints “ Processing Recipient List: ” before this section.</p> |                                                                                                                                                                                                                                                                                                                                                                                    |
| Default Domain                                                                                                                                                                                                                                                                                                        | <p>If you specified that a listener to change the default sender domain of messages it receives, any changes to the Envelope Recipients are printed in this section.</p> <p>For more information, see <a href="#">Configuring the Gateway to Receive Email, on page 69</a>.</p>                                                                                                    |
| Domain Map Translation                                                                                                                                                                                                                                                                                                | <p>The domain map feature transforms the recipient address to an alternate address. If you specified any domain map changes and a recipient address you specified matches, the transformation is printed in this section.</p> <p>For more information, see <a href="#">Configuring Routing and Delivery Features, on page 671</a>.</p>                                             |
| Recipient Access Table (RAT)                                                                                                                                                                                                                                                                                          | <p>Each Envelope Recipient that matches an entry in the RAT is printed in this section, in addition to the policy and parameters. (For example, if a recipient was specified to bypass limits in the listener’s RAT.)</p> <p>For more information on specifying recipients you accept, see <a href="#">Configuring the Gateway to Receive Email, on page 69</a>.</p>               |
| Alias Table                                                                                                                                                                                                                                                                                                           | <p>Each Envelope Recipient that matches an entry in the alias tables configured on the appliance (and the subsequent transformation to one or more recipient addresses) is printed in this section.</p> <p>For more information, see <a href="#">Configuring Routing and Delivery Features, on page 671</a>.</p>                                                                   |

| trace Command Section                                                                                                                                                                                                                                                                                                                                                                                     | Output                                                                                                                                                                                                                                                                                                                                                                                                                                                                                                                           |
|-----------------------------------------------------------------------------------------------------------------------------------------------------------------------------------------------------------------------------------------------------------------------------------------------------------------------------------------------------------------------------------------------------------|----------------------------------------------------------------------------------------------------------------------------------------------------------------------------------------------------------------------------------------------------------------------------------------------------------------------------------------------------------------------------------------------------------------------------------------------------------------------------------------------------------------------------------|
| <p><b>Pre-Queue Message Operations</b></p> <p>These sections summarize how the appliance affects each message after the message contents have been received, but before the messages are enqueued on the work queue. This processing occurs before the final <b>250 ok</b> command is returned to the remote MTA.</p> <p>The <b>trace</b> command prints “Message Processing : ” before this section.</p> |                                                                                                                                                                                                                                                                                                                                                                                                                                                                                                                                  |
| Virtual Gateways                                                                                                                                                                                                                                                                                                                                                                                          | <p>The <b>altsrchost</b> command assigns messages to a specific interface, based on a match of the Envelope Sender’s full address, domain, or name, or IP address. If an Envelope Sender matches entries from the <b>altsrchost</b> command, that information is printed in this section.</p> <p>Note that the virtual gateway address assigned at this point may be overridden by message filter processing below.</p> <p>For more information, see <a href="#">Configuring Routing and Delivery Features, on page 671</a>.</p> |
| Bounce Profiles                                                                                                                                                                                                                                                                                                                                                                                           | <p>Bounce profiles are applied at three different points in the processing. This is the first occurrence. If a listener has a bounce profile assigned to it, it is assigned at this point in the process. That information is printed in this section.</p> <p>For more information, see <a href="#">Configuring Routing and Delivery Features, on page 671</a>.</p>                                                                                                                                                              |
| <p><b>Work Queue Operations</b></p> <p>The following group of functions are performed on messages in the work queue. This occurs after the message has been accepted from the client, but before the message is enqueued for delivery on a destination queue. “Messages in Work Queue” is reported by the status and status detail commands.</p>                                                          |                                                                                                                                                                                                                                                                                                                                                                                                                                                                                                                                  |
| Masquerading                                                                                                                                                                                                                                                                                                                                                                                              | <p>If you specified that the To:, From:, and CC: headers of messages should be masked (either from a static table entered from a listener or via an LDAP query), the change is noted here. You enable masquerading for the message headers on private listeners using the <b>listenerconfig -&gt; edit -&gt; masquerade -&gt; config subcommands</b>.</p> <p>For more information, see <a href="#">Configuring Routing and Delivery Features, on page 671</a>.</p>                                                               |
| LDAP Routing                                                                                                                                                                                                                                                                                                                                                                                              | <p>If LDAP queries have been enabled on a listener, the results of LDAP acceptance, re-routing, masquerading, and group queries are printed in this section.</p> <p>For more information, see <a href="#">LDAP Queries, on page 749</a>.</p>                                                                                                                                                                                                                                                                                     |

| trace Command Section                                                                                                                                                                                                                                                                                                                                                                                                                 | Output                                                                                                                                                                                                                                                                                                                                                                                                                                                                                                                                                                                                                                                                                                                                                        |
|---------------------------------------------------------------------------------------------------------------------------------------------------------------------------------------------------------------------------------------------------------------------------------------------------------------------------------------------------------------------------------------------------------------------------------------|---------------------------------------------------------------------------------------------------------------------------------------------------------------------------------------------------------------------------------------------------------------------------------------------------------------------------------------------------------------------------------------------------------------------------------------------------------------------------------------------------------------------------------------------------------------------------------------------------------------------------------------------------------------------------------------------------------------------------------------------------------------|
| Message Filters Processing                                                                                                                                                                                                                                                                                                                                                                                                            | <p>All messages filters that are enabled on the system are evaluated by the test message at this point. For each filter, the rule is evaluated, and if the end result is “true,” each of the actions in that filter are then performed in sequence. A filter may contain other filters as an action, and the nesting of filters is unlimited. If a rule evaluates to “false” and a list of actions is associated with an else clause, those actions are evaluated instead. The results of the message filters, processed in order, are printed in this section.</p> <p>See <a href="#">Using Message Filters to Enforce Email Policies, on page 131</a>.</p>                                                                                                  |
| <p><b>Mail Policy Processing</b></p> <p>The mail policy processing section displays the Anti-Spam, Anti-Virus, Outbreak Filters feature, and disclaimer stamping for all recipients you supplied. If multiple recipients match multiple policies in Email Security Manager, the following sections will be repeated for each matching policy. The string: “Message Going to” will define which recipients matched which policies.</p> |                                                                                                                                                                                                                                                                                                                                                                                                                                                                                                                                                                                                                                                                                                                                                               |
| Anti-Spam                                                                                                                                                                                                                                                                                                                                                                                                                             | <p>This section notes messages that are not flagged to be processed by anti-spam scanning. If messages are to be processed by anti-spam scanning for the listener, the message is processed and the verdict returned is printed. If the Cisco appliance is configured to bounce or drop the messages based on the verdict, that information is printed and the <b>trace</b> command processing stops.</p> <p>Note: This step is skipped if anti-spam scanning is unavailable on the system. If anti-spam scanning is available but has not been enabled with a feature key, that information is also printed in this section.</p> <p>See <a href="#">Managing Spam and Graymail, on page 359</a>.</p>                                                         |
| Anti-Virus                                                                                                                                                                                                                                                                                                                                                                                                                            | <p>This section notes messages that are not flagged to be processed by anti-virus scanning. If messages are to be processed by anti-virus scanning for the listener, the message is processed and the verdict returned is printed. If the Cisco appliance is configured to “clean” infected messages, that information is noted. If configured to bounce or drop the messages based on the verdict, that information is printed and the trace command processing stops.</p> <p>Note: This step is skipped if anti-virus scanning is unavailable on the system. If anti-virus scanning is available but has not been enabled with a feature key, that information is also printed in this section.</p> <p>See the <a href="#">Anti-Virus, on page 341</a>.</p> |
| Content Filters Processing                                                                                                                                                                                                                                                                                                                                                                                                            | <p>All content filters that are enabled on the system are evaluated by the test message at this point. For each filter, the rule is evaluated, and if the end result is “true,” each of the actions in that filter are then performed in sequence. A filter may contain other filters as an action, and the nesting of filters is unlimited. The results of the content filters, processed in order, are printed in this section.</p> <p>See <a href="#">Content Filters, on page 271</a>.</p>                                                                                                                                                                                                                                                                |



| trace Command Section                                                                                                                                                                                                               | Output                                                                                                                                                                                                                                                                                                                                                                                                                                            |
|-------------------------------------------------------------------------------------------------------------------------------------------------------------------------------------------------------------------------------------|---------------------------------------------------------------------------------------------------------------------------------------------------------------------------------------------------------------------------------------------------------------------------------------------------------------------------------------------------------------------------------------------------------------------------------------------------|
| Outbreak Filters Processing                                                                                                                                                                                                         | <p>This section notes that messages that contain attachments are to bypass the Outbreak Filters feature. If messages are to be processed by Outbreak Filters for the recipient, the message is processed and the evaluation. If the appliance is configured to quarantine, bounce, or drop the messages based on the verdict, that information is printed and the processing stops.</p> <p>See <a href="#">Outbreak Filters, on page 401</a>.</p> |
| Footer Stamping                                                                                                                                                                                                                     | <p>This section notes whether a footer text resource was appended to the message. The name of the text resource is displayed. See <a href="#">Message Disclaimer Stamping, on page 620 in Text Resources, on page 619</a>.</p>                                                                                                                                                                                                                    |
| <p><b>Delivery Operations</b></p> <p>The following sections note operations that occur when a message is delivered. The trace command prints “ Message Enqueued for Delivery ” before this section.</p>                             |                                                                                                                                                                                                                                                                                                                                                                                                                                                   |
| Global Unsubscribe per Domain and per User                                                                                                                                                                                          | <p>If any recipients you specified as input for the trace command match recipients, recipient domains, or IP addresses listed in the in the Global Unsubscribe feature, any unsubscribed recipient addresses are printed in this section.</p> <p>See <a href="#">Configuring Routing and Delivery Features, on page 671</a>.</p>                                                                                                                  |
| <p><b>Final Result</b></p> <p>When all processing has been printed, you are prompted with the final result. In the CLI, Answer y to the question, “Would you like to see the resulting message?” to view the resulting message.</p> |                                                                                                                                                                                                                                                                                                                                                                                                                                                   |

## Using the Listener to Test the Appliance

“Sinkhole” listeners allow you to test your message generation systems and to also get a rough measure of receiving performance. Two types of sinkhole listeners are *queueing* and *non-queueing*.

- The queueing listener saves the message to the queue, but then immediately deletes it. Use a queueing listener when you are interested in measuring the performance of the entire injection portion of your message generation system.
- The non-queueing listener accepts a message, and then immediately deletes it without saving it. Use the non-queueing listener when you want to troubleshoot the connection from your message generation system to the appliance.

For example, in the following figure, you could create a sinkhole listener “C” to mirror the private listener labeled “B.” A non-queueing version tests the performance path of the system from the groupware client to the groupware server to the appliance. A queueing version tests that same path *and* the appliance's ability to enqueue messages and prepare them for delivery via SMTP.

Figure 87: Sinkhole Listener for an Enterprise Gateway

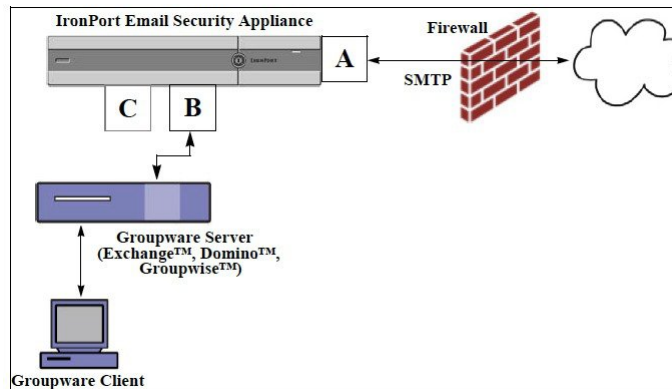

In the following example, the `listenerconfig` command is used to create a sinkhole queueing listener named `Sinkhole_1` on the Management interface. This Host Access Table (HAT) for the listener is then edited to accept connections from the following hosts:

- `yoursystem.example.com`
- `10.1.2.29`
- `badmail.tst`
- `.tst`



**Note** The final entry, `.tst`, configures the listener so that any host in the `.tst` domain can send email to the listener named `Sinkhole_1`.

## Example

```
mail3.example.com> listenerconfig

Currently configured listeners:

1. InboundMail (on PublicNet, 192.168.2.1) SMTP Port 25 Public
2. OutboundMail (on PrivateNet, 192.168.1.1) SMTP Port 25 Private

Choose the operation you want to perform:

- NEW - Create a new listener.
- EDIT - Modify a listener.
- DELETE - Remove a listener.
- SETUP - Change global settings.

[]> new

Please select the type of listener you want to create.

1. Private
2. Public
```

```
3. Sinkhole

[2]> 3

Do you want messages to be queued onto disk? [N]> y

Please create a name for this listener (Ex: "OutboundMail"):

[]> Sinkhole_1

Please choose an IP interface for this Listener.

1. Management (192.168.42.42/24: mail3.example.com)
2. PrivateNet (192.168.1.1/24: mail3.example.com)
3. PublicNet (192.168.2.1/24: mail3.example.com)

[1]> 1

Choose a protocol.

1. SMTP
2. QMQP

[1]> 1

Please enter the IP port for this listener.

[25]> 25

Please specify the systems allowed to relay email through the IronPort C60.
Hostnames such as "example.com" are allowed.
Partial hostnames such as ".example.com" are allowed.
IP addresses, IP address ranges, and partial IP addresses are allowed.
Separate multiple entries with commas.

[]> yoursystem.example.com, 10.1.2.29, badmail.tst, .tst

Do you want to enable rate limiting per host? (Rate limiting defines
the maximum number of recipients per hour you are willing to receive from a remote
domain.) [N]> n

Default Policy Parameters
=====

Maximum Message Size: 100M

Maximum Number Of Connections From A Single IP: 600

Maximum Number Of Messages Per Connection: 10,000

Maximum Number Of Recipients Per Message: 100,000

Maximum Number Of Recipients Per Hour: Disabled
```

```

Use SenderBase for Flow Control: No

Spam Detection Enabled: No

Virus Detection Enabled: Yes

Allow TLS Connections: No

Allow SMTP Authentication: No

Require TLS To Offer SMTP authentication: No

Would you like to change the default host access policy? [N]> n

Listener Sinkhole_1 created.

Defaults have been set for a Sinkhole Queuing listener.

Use the listenerconfig->EDIT command to customize the listener.

Currently configured listeners:

1. Sinkhole_1 (on Management, 192.168.42.42) SMTP Port 25 Sinkhole Queuing
2. InboundMail (on PublicNet, 192.1681.1) SMTP Port 25 Public
3. OutboundMail (on PrivateNet, 192.168.1.1) SMTP Port 25 Private

Choose the operation you want to perform:

- NEW - Create a new listener.
- EDIT - Modify a listener.
- DELETE - Remove a listener.
- SETUP - Change global settings.

[]>

```



---

**Note** Remember to issue the commit command for these changes to take effect.

---

After you have configured a sinkhole queuing listener and modified the HAT to accept connections from your injection system, use your injection system to begin sending email to the appliance. Use the `status`, `status detail`, and `rate` commands to monitor system performance. You can also monitor the system via the Graphical User Interface (GUI). For more information, see:

- [Monitoring Using the CLI, on page 1069](#)
- [Other Tasks in the GUI, on page 1097](#)

## Troubleshooting the Network

If you suspect that the appliance has network connectivity issues, first confirm that the appliance is working properly.

# Testing the Network Connectivity of the Appliance

## Procedure

---

- Step 1** Connect to the system and log in as the administrator. After successfully logging in, the following messages are displayed:

```
Last login: day month date hh:mm:ss from IP address
```

```
Copyright (c) 2001-2003, IronPort Systems, Inc.
```

```
AsyncOS x.x for Cisco
```

```
Welcome to the Cisco Messaging Gateway Appliance(tm)
```

- Step 2** Use the `status` or `status detail` commands.

```
mail3.example.com> status
```

or

```
mail3.example.com> status detail
```

The `status` command returns a subset of the monitored information about email operations. The statistics returned are grouped into two categories: counters and gauges. For complete monitoring information about email operations including rates, use the `status detail` command. Counters provide a running total of various events in the system. For each counter, you can view the total number of events that have occurred since the counter was reset, since the last system reboot, and over the system's lifetime. (For more information, see [Monitoring Using the CLI, on page 1069](#).)

- Step 3** Use the `mailconfig` command to send mail to a known working address.

The `mailconfig` command generates a human-readable file including all configuration settings available to the appliance. Attempt to send the file from the appliance to a known working email address to confirm that the appliance is able to send email over the network.

```
mail3.example.com> mailconfig
```

```
Please enter the email address to which you want to send the configuration file.
```

```
Separate multiple addresses with commas.
```

```
[]> user@example.com
```

```
Do you want to include passphrases? Please be aware that a configuration without passphrases will fail when reloaded with loadconfig. [N]> y
```

```
The configuration file has been sent to user@example.com.
```

```
mail3.example.com>
```

---

## Troubleshooting

After you have confirmed that the appliance is active on the network, use the following commands to pinpoint any network problems.

- You can use the `netstat` command to display network connections (both incoming and outgoing), routing tables, and a number of network interface statistics, including the following information:
  - List of active sockets
  - State of network interfaces
  - Contents of routing tables
  - Size of the listen queues
  - Packet traffic information
- You can use the `diagnostic -> network -> flush` command to flush all network related caches.
- You can use the `diagnostic -> network -> arpshow` command to show the system ARP cache.
- You can use the `packetcapture` command to intercept and display TCP/IP and other packets being transmitted or received over a network to which the computer is attached.

To use `packetcapture`, set the network interface and the filter. The filter uses the same format the UNIX `tcpdump` command. Use `start` to begin the packet capture and `stop` to end it. After stopping the capture, you need to use SCP or FTP to download the files from the `/pub/captures` directory. For more information, see [Running a Packet Capture, on page 1237](#).

- Use the `ping` command to a known working host to confirm that the appliance has an active connection on the network and is able to reach specific segments of your network.

The `ping` command allows you to test connectivity to a network host from the appliance .

```
mail3.example.com> ping
```

```
Which interface do you want to send the pings from?
```

1. Auto
2. Management (192.168.42.42/24: mail3.example.com)
3. PrivateNet (192.168.1.1/24: mail3.example.com)
4. PublicNet (192.168.2.1/24: mail3.example.com)

```
[1]> 1
```

```
Please enter the host you wish to ping.
```

```
[]> anotherhost.example.com
```

```
Press Ctrl-C to stop.
```

```

PING anotherhost.example.com (x.x.x.x): 56 data bytes
64 bytes from 10.19.0.31: icmp_seq=9 ttl=64 time=0.133 ms
64 bytes from 10.19.0.31: icmp_seq=10 ttl=64 time=0.115 ms
^C
--- anotherhost.example.com ping statistics ---
11 packets transmitted, 11 packets received, 0% packet loss
round-trip min/avg/max/stddev = 0.115/0.242/1.421/0.373 ms

```



---

**Note** You must use Control-C to end the ping command.

---

- Use the `traceroute` command to test connectivity to a network host from the appliance and debug routing issues with network hops.

```

mail3.example.com> traceroute
Which interface do you want to trace from?
1. Auto
2. Management (192.168.42.42/24: mail3.example.com)
3. PrivateNet (192.168.1.1/24: mail3.example.com)
4. PublicNet (192.168.2.1/24: mail3.example.com)
[1]> 1
Please enter the host to which you want to trace the route.
[]> 10.1.1.1
Press Ctrl-C to stop.
traceroute to 10.1.1.1 (10.1.1.1), 64 hops max, 44 byte packets
1 gateway (192.168.0.1) 0.202 ms 0.173 ms 0.161 ms
2 hostname (10.1.1.1) 0.298 ms 0.302 ms 0.291 ms
mail3.example.com>

```

- Use the `diagnostic -> network -> smtping` command to test a remote SMTP server.
- Use the `nslookup` command to check the DNS functionality.

The `nslookup` command can confirm that the appliance is able to reach and resolve hostnames and IP addresses from a working DNS (domain name service) server.

```

mail3.example.com> nslookup
Please enter the host or IP to resolve.

```

```
[]> example.com

Choose the query type:

1. A
2. CNAME
3. MX
4. NS
5. PTR
6. SOA
7. TXT

[1]>

A=192.0.34.166 TTL=2d
```

**Table 160: Checking DNS Functionality: Query Types**

|       |                                                                                              |
|-------|----------------------------------------------------------------------------------------------|
| A     | the host's Internet address                                                                  |
| CNAME | the canonical name for an alias                                                              |
| MX    | the mail exchanger                                                                           |
| NS    | the name server for the named zone                                                           |
| PTR   | the hostname if the query is an Internet address, otherwise the pointer to other information |
| SOA   | the domain's "start-of-authority" information                                                |
| TXT   | the text information                                                                         |

- Use the `tophosts` command via the CLI or the GUI, and sort by Active Recipients.

The `tophosts` command returns a list of the top 20 recipient hosts in queue. This command can help you determine if network connectivity problems are isolated to a single host or group of hosts to which you are attempting to send email. (For more information, see "Determining the Make-up of the Mail Queue".)

```
mail3.example.com> tophosts

Sort results by:

1. Active Recipients
2. Connections Out
3. Delivered Recipients
4. Soft Bounced Events
5. Hard Bounced Recipients
```



```
[1]> 1
Status as of: Mon Nov 18 22:22:23 2003
ActiveConn.Deliv.SoftHard
Recipient HostRecipOutRecip.BouncedBounced
1 aol.com36510255218
2 hotmail.com29071982813
3 yahoo.com13461231119
4 excite.com9838494
5 msn.com8427633 29
^C
```

- “Drill-down” to use the `hoststatus` command on the top domains listed from the `tophosts` command results.

The `hoststatus` command returns monitoring information about email operations relating to a specific recipient host. DNS information stored in the AsyncOS cache and the last error returned from the recipient host are also given. Data returned is cumulative since the last `resetcounters` command. (For more information, see [Monitoring the Status of a Mail Host, on page 1072](#).)

Using the `hoststatus` command on the top domains can isolate the performance issues with DNS resolution to the either the appliance or the internet. For example, if the `hoststatus` command for the top active recipient host shows many pending outbound connections, then try to determine if that particular host is down or unreachable, or if the appliance cannot connect to all or the majority of hosts.

- Check firewall permissions.

The appliance may need all of the following ports to be opened in order to function properly: ports 20, 21, 22, 23, 25, 53, 80, 123, 443, and 628. (See [Firewall Information, on page 1289](#).)

- Send email from the appliance on your network to `dnscheck@ironport.com`

Send an email from within your network to `dnscheck@ironport.com` to perform basic DNS checks on your system. An auto-responder email will respond with the results and details of the following four tests:

**DNS PTR Record** - Does the IP address of the Envelope From match the PTR record for the domain?

**DNS A Record** - Does the PTR record for the domain match the IP address of the Envelope From?

**HELO match** - Does the domain listed in the `SMTP HELO` command match the DNS hostname in the Envelope From?

**Mail server accepting delayed bounce messages** - Does the domain listed in the `SMTP HELO` command have MX records that resolve IP addresses for that domain?

## Troubleshooting the Listener

If you suspect problems with injecting email, use the following strategies:

- Confirm the IP address that you are injecting from, and then use the `listenerconfig` command to check for allowed hosts.

Is the IP address allowed to connect to the listener you have created? Use the `listenerconfig` command to examine the Host Access Table (HAT) for the listener. Use these commands to print the HAT for a listener:

```
listenerconfig -> edit -> listener_number -> hostaccess -> print
```

The HAT can be configured to refuse connections by IP address, block of IP addresses, hostname, or domains. For more information, see “Specifying Hosts that are Allowed to Connect”.

You can also use the `limits` subcommand to check the maximum number of connections allowed for a listener:

```
listenerconfig -> edit -> listener_number -> limits
```

- On the machine that you are injecting from, use Telnet or FTP to manually connect to the appliance . For example:

```
injection_machine% telnet appliance_name
```

You can also use the `telnet` command within the appliance itself to connect from the listener to the actual appliance :

```
mail3.example.com> telnet
```

```
Please select which interface you want to telnet from.
```

1. Auto
2. Management (192.168.42.42/24: mail3.example.com)
3. PrivateNet (192.168.1.1/24: mail3.example.com)
4. PublicNet (192.168.2.1/24: mail3.example.com)

```
[1]> 3
```

```
Enter the remote hostname or IP.
```

```
[> 193.168.1.1
```

```
Enter the remote port.
```

```
[25]> 25
```

```
Trying 193.168.1.1...
```

```
Connected to 193.168.1.1.
```

```
Escape character is '^'.
```

If you cannot connect from one interface to another, you may have issues with the way in which the appliance's Management and Data1 and Data2 interfaces are connected to your network. See [FTP, SSH, and SCP Access, on page 1261](#) for more information. You can telnet to port 25 of the listener and enter SMTP commands manually (if you are familiar with the protocol).

- Examine the IronPort text mail logs and injection debug logs to check for receiving errors.

Injection debug logs record the SMTP conversation between the appliance and a specified host connecting to the system. Injection debug logs are useful for troubleshooting communication problems between the appliance and a client initiating a connection from the Internet. The log records all bytes transmitted between the two systems and classifies them as “Sent to” the connecting host or “Received from” the connecting host.

For more information, see [Using Text Mail Logs, on page 1123](#) and [Using Injection Debug Logs, on page 1143](#).

## Troubleshooting Email Delivery From the Appliance

If you suspect problems with delivering email from the appliance, try the following strategies:

- Determine if the problem is domain-specific.

Use the `tophosts` command to get immediate information about the email queue and determine if a particular recipient domain has delivery problems.

Are there problem domains returned when you sort by “Active Recipients?”

When you sort by Connections Out, does any one domain reach the maximum connections specified for a listener? The default maximum number of connections for a listener is 600. The default maximum system-wide number of connections is 10,000 (set by the `deliveryconfig` command). You can examine the maximum number of connections for a listener using the command:

```
listenerconfig -> edit -> listener_number -> limits
```

Are the connections for a listener further limited by the `destconfig` command (either by system maximum or by Virtual Gateway addresses)? Use this command to examine the `destconfig` connection limits:

```
destconfig -> list
```

- Use the `hoststatus` command.

“Drill-down” using the `hoststatus` command on the top domains listed from the results listed by the `tophosts` command.

Is the host available and accepting connections?

Are there problems with one specific MX record mail server for the given host?

The `hoststatus` command reports the last “5XX” status code and description returned by the host if there is a 5XX error (Permanent Negative Completion reply) for the specified host. If the last outgoing TLS connection to the host failed, the `hoststatus` command displays the reason why it failed.

- Configure and/or examine the domain debug, bounce, and text mail logs to check if the recipient host is available.

**Domain debug logs** record the client and server communication during an SMTP conversation between the appliance and a specified recipient host. This log file type can be used to debug issues with specific recipient hosts.

For more information, see [Using Domain Debug Logs, on page 1143](#).

Bounce logs record all information pertaining to each bounced recipient.

For more information, see [Using Bounce Logs, on page 1139](#).

**Text mail** logs contain details of email receiving, email delivery and bounces. These logs are a useful source of information to understand delivery of specific messages and to analyze system performance.

For more information, see [Using Text Mail Logs, on page 1123](#).

- Use the `telnet` command to connect from the appliance to the problem domain:

```
mail3.example.com> telnet

Please select which interface you want to telnet from.

1. Auto
2. Management (192.168.42.42/24: mail3.example.com)
3. PrivateNet (192.168.1.1/24: mail3.example.com)
4. PublicNet (192.168.2.1/24: mail3.example.com)

[1]> 1

Enter the remote hostname or IP.

[]> problemdomain.net

Enter the remote port.

[25]> 25
```

- You can use the `tlsverify` command to establish an outbound TLS connection on demand and debug any TLS connection issues concerning a destination domain. To create the connection, specify the domain to verify against and the destination host. AsyncOS checks the TLS connection based on the Required (Verify) TLS setting.

```
mail3.example.com> tlsverify

Enter the TLS domain to verify against:

[]> example.com

Enter the destination host to connect to. Append the port (example.com:26) if you are
not connecting on port 25:

[example.com]> mx.example.com:25

Connecting to 1.1.1.1 on port 25.

Connected to 1.1.1.1 from interface 10.10.10.10.

Checking TLS connection.

TLS connection established: protocol TLSv1, cipher RC4-SHA.

Verifying peer certificate.

Verifying certificate common name mx.example.com.

TLS certificate match mx.example.com
```

```
TLS certificate verified.
TLS connection to 1.1.1.1 succeeded.
TLS successfully connected to mx.example.com.
TLS verification completed.
```

## Troubleshooting Performance

If you suspect that there are performance problems with the appliance, utilize the following strategies:

- Use the `rate` and `hostrate` commands to check the current system activity.

The `rate` command returns real-time monitoring information about email operations. For more information, see [Displaying Real-time Activity, on page 1075](#).

The `hostrate` command returns real-time monitoring information for a specific host.

- Use the `status` command to cross-check the historical rates to check for degradation.
- Use the `status detail` command to check the RAM utilization.

You can use the `status detail` command to quickly see the system's RAM, CPU, and Disk I/O utilization.



---

**Note** RAM utilization should always be less than 45%. If RAM utilization exceeds 45%, then, the appliance will enter “resource conservation mode;” it initiates a “back-off” algorithm to prevent over-subscription of resources and sends out the following email alert:

---

```
This system (hostname: hostname) has entered a 'resource conservation' mode in order
to
prevent the rapid depletion of critical system resources.
```

```
RAM utilization for this system has exceeded the resource conservation threshold of
45%.
The allowed injection rate for this system will be gradually decreased as RAM
utilization approaches 60%.
```

This situation occurs only with an aggressive injection with poor deliverability facilities. If you encounter RAM utilization exceeding 45%, check the number of messages in the queue and see if a particular domain is down or unavailable for delivery (via the `hoststatus` or `hostrate` commands). Also check the status of the system and ensure that delivery is not suspended. If after stopping the injection you continue to experience a high RAM utilization, contact Cisco Customer Support.

- Is the problem specific to one domain?

Use the `tophosts` command to get immediate information about the email queue and determine if a particular recipient domain has delivery problems.

Check the size of the queue. You can delete, bounce, suspend, or redirect messages in the email queue to manage its size, or to deal with recipients to a specific, problematic domain. For more information, see [Managing the Email Queue, on page 1079](#). Use these commands:

- `deleterecipients`
- `bouncerecipients`
- `redirectrecipients`
- `suspenddel / resumedel`
- `suspendlistener / resumelister`

Use the `tophosts` command to check the number of soft and hard bounces. Sort by “Soft Bounced Events” (option 4) or “Hard Bounced Recipients” (option 5). If the performance for a particular domain is problematic, use the commands above to manage the delivery to that domain.

## Web Interface Appearance and Rendering Issues

See [Overriding Internet Explorer Compatibility Mode, on page 1061](#).

## Responding to Alerts

- [Troubleshooting Alerts That Miscellaneous Disk Usage is Approaching the Quota, on page 1232](#)

## Troubleshooting Alerts That Miscellaneous Disk Usage is Approaching the Quota

### Problem

You receive an alert that Miscellaneous disk usage is approaching its quota.

### Solution

You can either increase the quota or delete files. See [Managing Disk Space for the Miscellaneous Quota, on page 1001](#).

## Troubleshooting Hardware Issues

Lights on the front and/or rear panels of your hardware appliance indicate health and status of your appliance. For descriptions of these indicators, see the hardware guides, such as the *Cisco x90s Series Content Security Appliances Installation and Maintenance Guide*, available from <http://www.cisco.com/c/en/us/support/security/email-security-appliance/products-installation-guides-list.html>.

Specifications for your appliance, such as temperature ranges, are also available in these documents.

## Remotely Resetting Appliance Power

If the appliance requires a hard reset, you can reboot the appliance chassis remotely using a third-party Intelligent Platform Management Interface (IPMI) tool.

### Restrictions

- Remote power cycling is available only on certain hardware.

For specifics, see [Enabling Remote Power Cycling , on page 1016](#).

- If you want be able to use this feature, you must enable it in advance, before you need to use it.

For details, see [Enabling Remote Power Cycling , on page 1016](#).

- Only the following IPMI commands are supported:
  - **status, on, off, cycle, reset, diag, soft**
  - Issuing unsupported commands will produce an “insufficient privileges” error.

### Before You Begin

- Obtain and set up a utility that can manage devices using IPMI version 2.0.
- Understand how to use the supported IPMI commands. See the documentation for your IPMI tool.

### Procedure

- 
- Step 1** Use IPMI to issue a supported power-cycling command to the IP address assigned to the Remote Power Cycle port, which you configured earlier, along with the required credentials.

For example, from a UNIX-type machine with IPMI support, you might issue the command:

```
ipmitool -I lan -H 192.0.2.1 -U remoteresetuser -P password chassis power reset
```

where **192.0.2.1** is the IP address assigned to the Remote Power Cycle port and **remoteresetuser** and **password** are the credentials that you entered while enabling this feature.

- Step 2** Wait at least eleven minutes for the appliance to reboot.
- 

## Working with Technical Support

- [Technical Support for Virtual Appliances , on page 1233](#)
- [Opening or Updating a Support Case From the Appliance , on page 1234](#)
- [Enabling Remote Access for Cisco Technical Support Personnel , on page 1234](#)
- [Running a Packet Capture, on page 1237](#)

## Technical Support for Virtual Appliances

Requirements for getting technical support for your virtual appliance are described in the Cisco Content Security Virtual Appliance Installation Guide available from <http://www.cisco.com/c/en/us/support/security/email-security-appliance/products-installation-guides-list.html>.

## Opening or Updating a Support Case From the Appliance

Do not contact Cisco IronPort Customer Support for help with Cloud Email Security. See the *Cisco IronPort Cloud Email Security / Hybrid Email Security Overview Guide* for information on getting support for Cloud and Hybrid Email Security.

### Before You Begin

- If your issue is urgent, do not use this method. Instead, contact support using one of the other methods listed in [Cisco Customer Support, on page 8](#).
  - Use the following procedure only for issues such as a request for information or a problem for which you have a workaround, but would like an alternate solution.
  - Consider other options for getting help:
    - [Knowledge Base, on page 8](#)
    - [Cisco Support Community, on page 8](#)
  - To access Cisco technical support directly from the appliance, your Cisco.com user ID must be associated with your service agreement contract for this appliance. To view a list of service contracts that are currently associated with your Cisco.com profile, visit the Cisco.com Profile Manager at [https://rpfa.cloudapps.cisco.com/rpfa/profile/profile\\_management.do](https://rpfa.cloudapps.cisco.com/rpfa/profile/profile_management.do). If you do not have a Cisco.com user ID, register to get one. See [Registering for a Cisco Account, on page 9](#).
- Be sure to save your Cisco.com user ID and support contract ID in a safe location.
- When you open a support case using this procedure, the appliance configuration file is sent to Cisco Customer Support. If you do not want to send the appliance configuration, you can contact Customer Support using a different method.
  - In cluster configurations, support requests and their saved values are machine-specific.
  - The appliance must be connected to the internet and able to send email.
  - If you are sending information about an existing case, make sure you have the case number.

### Procedure

---

**Step 1** Sign in to the appliance.

**Step 2** Choose **Help and Support > Contact Technical Support**.

**Step 3** Complete the form.

**Step 4** Click **Send**.

**Note** CCO User IDs and the last-entered Contract ID are saved on the appliance for future use.

---

## Enabling Remote Access for Cisco Technical Support Personnel

Only Cisco Customer Assistance can access your appliance using these methods.

- [Enabling Remote Access to Appliances With an Internet Connection, on page 1235](#)
- [Enabling Remote Access to Appliances Without a Direct Internet Connection, on page 1235](#)
- [Disabling Remote Access, on page 1236](#)



- [Disabling a Tech Support Tunnel , on page 1236](#)
- [Checking the Status of the Support Connection , on page 1236](#)

## Enabling Remote Access to Appliances With an Internet Connection

Support accesses the appliance through an SSH tunnel that this procedure creates between the appliance and the `upgrades.ironport.com` server.

### Before You Begin

Identify a port that can be reached from the internet. The default is port 25, which will work in most environments because the system also requires general access over that port in order to send email messages. Connections over this port are allowed in most firewall configurations.

### Procedure

- Step 1** Log in to the appliance .
- Step 2** From the top right side of the GUI window, choose **Help and Support > Remote Access**.
- Step 3** Click **Enable**.
- Step 4** Enter information:

| Option        | Description                                                                                                                                                                         |
|---------------|-------------------------------------------------------------------------------------------------------------------------------------------------------------------------------------|
| Seed String   | The seed string is used to generate a secure shared secret to be used by Cisco Customer Support to access this appliance .                                                          |
| Secure Tunnel | Select the check box to use a secure tunnel for the remote access connection.<br>Enter a port for the connection.<br>The default is port 25 , which will work in most environments. |

- Step 5** Click **Submit**.

### What to do next

When remote access for support personnel is no longer required, see [Disabling a Tech Support Tunnel , on page 1236](#).

## Enabling Remote Access to Appliances Without a Direct Internet Connection

For appliances without a direct internet connection, access is made through a second appliance that is connected to the internet.

### Before You Begin

- The appliance must be able to connect on port 22 to a second appliance that is connected to the internet.
- On the appliance with the internet connection, follow the procedure in [Enabling Remote Access to Appliances With an Internet Connection , on page 1235](#) to create a support tunnel to that appliance .

### Procedure

---

- Step 1** From the command-line interface of the appliance requiring support, enter the **techsupport** command.
- Step 2** Enter **sshaccess**.
- Step 3** Follow the prompts.
- 

### What to do next

When remote access for support personnel is no longer required, see the following:

- [Disabling Remote Access](#) , on page 1236
- [Disabling a Tech Support Tunnel](#) , on page 1236

## Disabling a Tech Support Tunnel

An enabled techsupport tunnel remains connected to upgrades.ironport.com for 7 days. After that time, established connections will not be disconnected but will be unable to re-attach to the tunnel once disconnected.

To disable the tunnel manually:

### Procedure

---

- Step 1** Log in to the appliance .
- Step 2** From the top right side of the GUI window, choose **Help and Support > Remote Access**.
- Step 3** Click **Disable**.
- 

## Disabling Remote Access

A remote access account that you create using the techsupport command remains active until you deactivate it.

### Procedure

---

- Step 1** From the command-line interface, enter the techsupport command.
- Step 2** Enter sshaccess .
- Step 3** Enter disable .
- 

## Checking the Status of the Support Connection

### Procedure

---

- Step 1** From the command-line interface, enter the techsupport command.

**Step 2** Enter status .

---

## Running a Packet Capture

Packet Capture allows support personnel to see the TCP/IP data and other packets going into and out of the appliance . This allows Support to debug the network setup and to discover what network traffic is reaching the appliance or leaving the appliance .

### Procedure

---

**Step 1** Choose **Help and Support > Packet Capture**.

**Step 2** Specify packet capture settings:

- a) In the **Packet Capture Settings** section, click **Edit Settings**.
- b) (Optional) Enter duration, limits, and filters for the packet capture.

Your Support representative may give you guidance on these settings.

If you enter a capture duration without specifying a unit of time, AsyncOS uses seconds by default.

In the **Filters** section:

- Custom filters can use any syntax supported by the UNIX tcpdump command, such as host 10.10.10.10 && port 80 .
- The client IP is the IP address of the machine connecting to the appliance , such as a mail client sending messages through the appliance .
- The server IP is the IP address of the machine to which the appliance is connecting, such as an Exchange server to which the appliance is delivering messages.
- You can use the client and server IP addresses to track traffic between a specific client and a specific server, with the appliance in the middle.

c) Click **Submit**.

**Step 3** Click **Start Capture**.

- Only one capture may be running at a time.
- When a packet capture is running, the Packet Capture page shows the status of the capture in progress by showing the current statistics, such as file size and time elapsed.
- The GUI only displays packet captures started in the GUI, not from the CLI. Similarly, the CLI only displays the status of a current packet capture run started in the CLI.
- The packet capture file is split into ten parts. If the file reaches the maximum size limit before the packet capture ends, the oldest part of the file is deleted (the data is discarded) and a new part starts with the current packet capture data. Only 1/10 of the packet capture file is discarded at a time.
- A running capture started in the GUI is preserved between sessions. (A running capture started in the CLI stops when the session ends.)

**Step 4** Allow the capture to run for the specified duration, or, if you have let the capture run indefinitely, manually stop the capture by clicking **Stop Capture**.

**Step 5** Access the packet capture file:

- Click the file in the **Manage Packet Capture Files** list and click **Download File**.
- Use FTP or SCP to access the file in the captures subdirectory on the appliance .

---

### What to do next

Make the file available to Support:

- If you allow remote access to your appliance , technicians can access the packet capture files using FTP or SCP. See [Enabling Remote Access for Cisco Technical Support Personnel](#) , on page 1234.
- Email the file to Support.



## CHAPTER 46

# Optimizing the Appliance for Outbound Mail Delivery Using D-Mode

---

This chapter contains the following sections:

- [Feature Summary: D-Mode for Optimized Outbound Delivery](#) , on page 1239
- [Setting Up the Appliance for Optimized Outbound Mail Delivery](#) , on page 1241
- [Sending Bulk Mail Using IronPort Mail Merge \(IPMM\)](#), on page 1242

## Feature Summary: D-Mode for Optimized Outbound Delivery

D-Mode is a feature key-enabled feature that optimizes certain appliances for outbound email delivery. Features specific to inbound mail handling are disabled in D-Mode.

- [Features Unique to D-Mode-Enabled Appliances](#) , on page 1239
- [Standard Features Disabled in D-Mode-Enabled Appliances](#) , on page 1240
- [Standard Features Applicable to D-Mode-Enabled Appliances](#) , on page 1240

## Features Unique to D-Mode-Enabled Appliances

- 256 Virtual Gateway Addresses - The Cisco Virtual Gateway technology allows you to configure enterprise mail gateways for all domains you host — with distinct IP addresses, hostname and domains — and create separate corporate email policy enforcement and anti-spam strategies for those domains, while hosted within the same physical appliance . See information about “Customizing Listeners” in [Configuring the Gateway to Receive Email](#), on page 69
- IronPort Mail Merge (IPMM) - IronPort Mail Merge (IPMM) removes the burden of generating individual personalized messages from customer systems. By removing the need to generate thousands of individual messages and transmit them between message generating systems and the email gateway, users benefit from the decreased load on their systems and increased throughput of email delivery. For more information, see [Sending Bulk Mail Using IronPort Mail Merge \(IPMM\)](#), on page 1242.
- Resource-conserving bounce setting - You can configure D-Mode-enabled appliances to detect potential blocked destinations and bounce all messages bound for that destination. For more information, see [Configuring Resource-Conserving Bounce Settings](#), on page 1241.
- Enhanced performance for outbound delivery

## Standard Features Disabled in D-Mode-Enabled Appliances

- IronPort anti-spam scanning and on or off box spam quarantining — Because anti-spam scanning pertains mostly to incoming mail, the IronPort Anti-Spam scanning engine is disabled. The Anti-Spam chapter is, therefore, not applicable.
- Outbreak Filters — Because the Outbreak Filters feature is used to quarantine incoming mail, this feature is disabled on D-Mode-enabled appliances . Information in the Outbreak Filters chapter is, therefore, not applicable.
- Service Logs - The Service Logs feature is disabled on D-mode enabled appliances .
- Reporting — Reporting is limited. Some reports are not available, and the reporting that does occur is set to run at a very limited level for performance reasons.



### Note

The totals shown in the Email Security Monitor Overview report for D-Mode-enabled appliances may erroneously include spam and suspect spam counts, even though these features are disabled on D-Mode-enabled appliances.

- Data Loss Prevention — DLP scanning for outgoing messages is disabled on D-Mode-enabled appliancea

## Standard Features Applicable to D-Mode-Enabled Appliances

*Table 161: AsyncOS Features Included in D-Mode Enabled Appliances*

| Feature                    | More Information                                                                                                                                                                                                                                                                                                                             |
|----------------------------|----------------------------------------------------------------------------------------------------------------------------------------------------------------------------------------------------------------------------------------------------------------------------------------------------------------------------------------------|
| Anti-virus scanning        | See <a href="#">Anti-Virus</a> , on page 341                                                                                                                                                                                                                                                                                                 |
| Domain Key signing         | DKIM/Domain Keys is a method for verifying authenticity of email based on a signing key used by the sender. See <a href="#">Email Authentication</a> , on page 577                                                                                                                                                                           |
| Centralized management     | See <a href="#">Centralized Management Using Clusters</a> , on page 1183                                                                                                                                                                                                                                                                     |
| Delivery throttling        | For each domain, you can assign a maximum number of connections and recipients that will never be exceeded by the system in a given time period. This “good neighbor” table is defined through the destconfig command.<br><br>For more information, see <a href="#">Controlling Email Delivery Using Destination Controls</a> , on page 708. |
| Bounce Verification        | Verify the authenticity of bounce messages. See <a href="#">Bounce Verification</a> , on page 709.                                                                                                                                                                                                                                           |
| Delegated administration   | See <a href="#">Distributing Administrative Tasks</a> , on page 949                                                                                                                                                                                                                                                                          |
| Trace (debug)              | See <a href="#">Debugging Mail Flow Using Test Messages: Trace</a> , on page 1213.                                                                                                                                                                                                                                                           |
| VLAN, NIC-pairing          | See <a href="#">Advanced Network Configuration</a> , on page 1099                                                                                                                                                                                                                                                                            |
| Optional Anti-virus engine | You can add optional anti-virus scanning to ensure the integrity of your outbound messages. See <a href="#">Anti-Virus Scanning Overview</a> , on page 341.                                                                                                                                                                                  |

# Setting Up the Appliance for Optimized Outbound Mail Delivery

## Procedure

---

**Step 1** Apply the provided feature key. You will need to apply the key to your appliance *prior to running the system setup wizard* (prior to configuring the appliance). Apply the key via the System Administration > Feature Key page or by issuing the `featurekey` command in the CLI.

**Note** The preceding feature keys include a sample 30 day Sophos or McAfee Anti-Virus license you can use to test anti-virus scanning on outbound mail.

**Step 2** Reboot the appliance .

**Step 3** Run the system setup wizard (GUI or CLI) and configure your appliance .

Keep in mind that appliances that are optimized for outbound delivery do not include anti-spam scanning or the Outbreak Filters feature. (Please ignore these chapters.)

**Note** In a clustered environment, you cannot combine appliances that are configured with the D-Mode feature key with AsyncOS appliances that are not configured with the delivery performance package.

---

## Configuring Resource-Conserving Bounce Settings

Once the appliance is configured for optimized outbound mail delivery, you can configure the system to detect potential delivery problems and bounce all messages for a destination.



**Note** Using this setting will bounce all messages in the queue for a destination domain that is deemed undeliverable. You will need to re-send the message once the delivery issues have been resolved.

---

## Example of Enabling Resource-Conserving Bounce Settings

```
mail3.example.com> bounceconfig
```

```
Choose the operation you want to perform:
```

- NEW - Create a new profile.
- EDIT - Modify a profile.
- DELETE - Remove a profile.
- SETUP - Configure global bounce settings.

```
[]> setup
```

```
Do you want to bounce all enqueued messages bound for a domain if the host is down? [N]>
```

```
Y
```

When using this feature, a host is considered “down” after at least 10 consecutive connection attempts fail. AsyncOS scans for down hosts every 15 minutes, so it is possible that more than 10 attempts will be made before the queue is cleared.

## Sending Bulk Mail Using IronPort Mail Merge (IPMM)



---

**Note** IronPort Mail Merge is available only on appliances that are D-Mode-enabled.

---

### Overview of IronPort Mail Merge

IronPort Mail Merge removes the burden of generating individual personalized messages from customer systems. It removes the need to generate thousands of individual messages and transmit them between message generating systems and the email gateway, resulting in decreased load on your systems and increased throughput of email delivery.

With IPMM, a single message body is created with variables representing locations in the message to be replaced for personalization. For each individual message recipient, only the recipient email address and the variable substitutions need to be transmitted to the email gateway. In addition, IPMM can be used to send certain recipients specific “parts” of the message body, while excluding certain parts from others recipients. (For example, suppose you needed to include a different copyright statements at the end of your messages to recipients in two different countries.)

### Benefits of the Mail Merge Function

- Ease of use for the mail administrator. The complexities of creating personalized messages for each recipient are removed, as IPMM provides variable substitution and an abstracted interface in many common languages.
- Reduced load on message generation systems. By requiring one copy of the message body and a table of required substitutions, most of the message generation “work” is off-loaded from message generation systems and moved to the appliance that is configured for optimized outbound mail delivery.
- Increased delivery throughput. By reducing the resources necessary to accept and queue thousands of incoming messages, the appliance can significantly increase out-bound delivery performance.
- Queue storage efficiency. By storing less information for each message recipient, users can achieve orders-of- magnitude, better use of queue storage on the D-Mode enabled appliance .

### Using Mail Merge

#### SMTP Injection

IPMM extends SMTP as the transport protocol. There is no special configuration that needs to be made to the appliance . (By default, IPMM can be enabled for private listeners and disabled for public listeners on the D-Mode-enabled appliance .) However, if you are not currently using SMTP as your injection protocol, you must create a new private listener that utilizes SMTP through the D-Mode enabled appliance interface.



Use the `setipmm` subcommand of `listenerconfig` to enable IPMM on the listener. For more information, see [Configuring the Gateway to Receive Email, on page 69](#)

IPMM modifies SMTP by altering two commands — MAIL FROM and DATA — and adding another: XDFN . The MAIL FROM command is replaced with XMRG FROM and, the DATA command is replaced with XPRT .

To generate a Mail Merge message, the commands used to generate the message need to be issued in a particular sequence.

1. The initial EHLO statement, identifying the sending host.
2. Each message starts with an XMRG FROM: statement, indicating the sender address.
3. Each recipient is then defined:
4. One or more XDFN variable allocation statements are made, including defining the parts (XDFN \*PART=1,2,3...), and any other recipient specific variables.
5. The recipient email address is defined with the RCPT TO: statement. Any variable allocations prior to the RCPT TO:, but after the prior XMRG FROM, or RCPT TO command, will be mapped to this recipient email address.
6. Each part is defined using the XPRT n command, with each part terminated by a period (.) character similar to the DATA command. The last part is defined by the XPRT n LAST command.

## Variable Substitution

Any part of the message body, including message headers, can contain variables for substitution. Variables can appear in HTML messages, as well. Variables are user-defined and must begin with the ampersand ( & ) character and end with the semi-colon character ( ; ). Variable names beginning with an asterisk ( \* ) are reserved and cannot be used.

## Reserved Variables

IPMM contains five special “reserved” variables that are predefined.

**Table 162: IPMM: Reserved Variables**

|        |                                                                                                                                                                                                                                                |
|--------|------------------------------------------------------------------------------------------------------------------------------------------------------------------------------------------------------------------------------------------------|
| *FROM  | The reserved variable *FROM is derived from the “Envelope From” parameter. The “Envelope From” parameter is set by the “XMRG FROM:” command.                                                                                                   |
| *TO    | The reserved variable *TO is derived from the envelope recipient value, as set by the “RCPT TO:” command.                                                                                                                                      |
| *PARTS | The reserved variable *PARTS holds a comma separated list of parts. It is set prior to defining a recipient with the “RCPT TO:” and determines which of the “XPRT n” message body blocks a given user will receive.                            |
| *DATE  | The reserved variable *DATE is replaced with the current date stamp.                                                                                                                                                                           |
| *DK    | The reserved variable *DK is used to specify a DomainKeys Signing profile (this profile must already exist in AsyncOS). For more information about creating DomainKeys Signing profiles, see <a href="#">Email Authentication, on page 577</a> |

## Example Message 1

The following example message body (including headers) contains four distinct variables and five substitution locations that will be replaced in the final message. Note that the same variable may be used more than once in the message body. Also, the reserved variable `&*TO;` is used, which will be replaced with the recipient email address. This reserved variable does not need to be passed in as a separate variable. The variables in the example appear in bold.

```
From: Mr.Spacely <spacely@example.com>
To: &first_name;&last_name;&*TO;

Subject: Thanks for Being an Example.Com Customer

Dear &first_name;,
Thank you for purchasing a &color; sprocket.
```

This message needs only be injected once into the appliance . For each recipient, the following additional information is required:

- A recipient email address
- Name-value pairs for the variable substitution

## Part Assembly

Where SMTP uses a single DATA command for each message body, IPMM uses one or many XPRT commands to comprise a message. Parts are assembled based upon the order specified per-recipient. Each recipient can receive any or all of the message parts. Parts can be assembled in any order.

The special variable `*PARTS` holds a comma separated list of parts.

For example, the following example message contains two parts.

The first part contains the message headers and some of the message body. The second part contains an offer that can be variably included for specific customers.

## Example Message 2, Part 1

```
From: Mr. Spacely <spacely@example.com>

To: &first_name; &last_name; &*TO;

Subject: Thanks for Being an Example.Com Customer

Dear &first_name;,

Thank you for purchasing a &color; sprocket.
```

## Example Message 2, Part 2

Please accept our offer for 10% off your next sprocket purchase.

The message parts need only be injected once into the appliance . In this case, each recipient requires the following additional information:

- The ordered list of parts to be included in the final message

- A recipient email address
- Name value pairs for the variable substitution

## IPMM and DomainKeys Signing

IPMM does support DomainKeys Signing. Use the `*DK` reserved variable to specify a DomainKeys profile. For example:

```
XDFN first_name="Jane" last_name="User" color="red" *PARTS=1,2 *DK=mass_mailing_1
```

In this example, “mail\_mailing\_1” is the name of a previously configured DomainKeys profile.

## Command Descriptions

When a client injects IPMM messages to the listener, it uses extended SMTP with the following key commands.

### XMRG FROM

Syntax:

```
XMRG FROM: <sender email address>
```

This command replaces the SMTP MAIL FROM: command and indicates that what follows is an IPMM message. An IPMM job is initiated with the XMRG FROM: command.

### XDFN

Syntax:

```
XDFN <KEY=VALUE> [KEY=VALUE]
```

The XDFN command sets the per-recipient metadata. Note that key-value pairs can optionally be enclosed in angle brackets or square brackets.

`*PARTS` is a special reserved variable that indicates the index number as defined by the XPRT command (described below). The `*PARTS` variable is split as a comma-delimited list of integers. The integers match the body parts to be sent as defined by the XPRT commands. The other reserved variables are: `*FROM`, `*TO`, and `*DATE`.

### XPRT

Syntax:

```
XPRT index_number LAST
```

Message

.

The `XPRT` command replaces the SMTP `DATA` command. The command accepts the transfer of the message part after the command is issued. The command is completed with a single period on a line followed by a return (which is the same way an SMTP `DATA` command is completed).

The special keyword `LAST` indicates the end of the mail merge job and must be used to specify the final part that will be injected.

After the `LAST` keyword is used, the message is queued, and delivery begins.

## Notes on Defining Variables

- When you define variables with the XDFN command, note that the actual command line cannot exceed the physical limit of the system. In the case of the D-Mode-enabled appliance, this limit is 4 kilobytes per line. Other host systems may have lower thresholds. Use caution when defining multiple variables on very large lines.
- You can escape special characters using the forward slash “/” character when defining variables key-value pairs. This is useful if your message body contains HTML character entities that might be mistakenly replaced with variable definitions. (For example, the character entity &trade; defines the HTML character entity for a trademark character. If you created the command XDFN trade=foo and then created a IPMM message containing the HTML character entity “&trade;” the assembled message would contain the variable substitution (“foo”) instead of the trademark character. The same concept is true for the ampersand character “&” which is sometimes used in URLs containing GET commands.

## Example IPMM Conversation

The following is an example IPMM conversation of Example Message #2 (shown above). The message will be sent to two recipients in this example: “Jane User” and “Joe User.”

In this example, the type in `bold` represents what you would type in a manual SMTP conversation with the D-Mode-enabled appliance, type in `monospaced type` represents the responses from the SMTP server, and *italic type* represents comments or variables.

A connection is established:

```
220 ESMTP
```

```
EHLO foo
```

```
250 - ehlo responses from the listener enabled for IPMM
```

The conversation is started:

```
XMRG FROM:<user@domain.com> [Note: This replaces the MAIL FROM: SMTP command.]
```

```
250 OK
```

Variables and parts are set for each recipient:

```
XDFN first_name="Jane" last_name="User" color="red" *PARTS=1,2
```

*[Note: This line defines three variables (first\_name, last\_name, and color) and then uses the \*PARTS reserved variable to define that the next recipient defined will receive message parts numbers 1 and 2.]*

```
250 OK
```

```
RCPT TO:<jane@company.com>
```

```
250 recipient <jane@company.com> ok
```

```
XDFN first_name="Joe" last_name="User" color="black" *PARTS=1
```

*[Note: This line defines three variables (first\_name, last\_name, and color) and then uses the \*PARTS reserved variable to define that the next recipient defined will receive*

*message parts numbers 1 only.]*

```
RCPT TO:<joe@company1.com>
250 recipient <joe@company1.com> ok
Next, part 1 is transmitted:
XPRT 1 [Note: This replaces the DATA SMTP command.]
354 OK, send part
From: Mr. Spacely <spacely@example.com>
To: &first_name; &last_name; &*TO;
Subject: Thanks for Being an Example.Com Customer
&*DATE;
Dear &first_name;,
Thank you for purchasing a &color; sprocket.
.
```

And then part 2 is transmitted. Note that the LAST keyword is used to identify Part 2 as the final part to assemble:

```
XPRT 2 LAST
Please accept our offer for 10% off your next sprocket purchase.
.
250 Ok, mailmerge message enqueued
```

The “250 Ok, mailmerge message queued” notes that the message has been accepted.

Based on this example, recipient Jane User will receive this message:

```
From: Mr. Spacely <spacely@example.com>
To: Jane User <jane@company.com>
Subject: Thanks for Being an Example.Com Customer
```

*message date*

Dear Jane,

Thank you for purchasing a red sprocket.

Please accept our offer for 10% off your next sprocket purchase.

Recipient Joe User will receive this message:

**From:** Mr. Spacely <spacely@example.com>

**To:** Joe User <joe@company1.com>

**Subject:** Thanks for Being an Example.Com Customer

*message date*

Dear Joe,

Thank you for purchasing a black sprocket.

## Example Code

Cisco has created libraries in common programming languages to abstract the task of injecting IPMM messages into the appliance listener enabled for IPMM. Contact Cisco Customer Support for examples of how to use the IPMM library. The code is commented extensively to explain its syntax.



## CHAPTER 47

# Centralizing Services on a Cisco Content (M-Series) Security Management Appliance

---

This chapter contains the following sections:

- [Overview of Cisco Content Security Management Appliance Services](#) , on page 1249
- [Network Planning](#) , on page 1250
- [Working with an External Spam Quarantine](#) , on page 1250
- [About Centralizing Policy, Virus, and Outbreak Quarantines](#) , on page 1253
- [Configuring Centralized Reporting](#) , on page 1257
- [Configuring Centralized Message Tracking](#) , on page 1258
- [Using Centralized Services](#) , on page 1259

## Overview of Cisco Content Security Management Appliance Services

The Cisco Content Security Management appliance (M-Series appliance) is an external or “off box” location that provides a single interface to certain services on multiple Email Security appliances .

The Cisco Content Security Management appliance includes the following features:

- External spam quarantine. Holds spam and suspected spam messages for end users, and allow end users and administrators to review messages that are flagged as spam before making a final determination.
- Centralized policy, virus, and outbreak quarantines. Provide a single location behind the firewall to store and manage messages quarantined by anti-virus scanning, outbreak filters, and policies.
- Centralized reporting. Run reports on aggregated data from multiple Email Security appliances .
- Centralized tracking. Track email messages that traverse multiple Email Security appliances .

For complete information about configuring and using your Cisco Content Security Management appliance , see the Cisco Content Security Management appliance User Guide.

## Network Planning

The Cisco Content Security Management appliance lets you separate the end-user interfaces (such as mail applications) from the more secure gateway systems residing in your various DMZs. Using a two-layer firewall can provide you with flexibility in network planning so that end users do not connect directly to the outer DMZ.

The following figure shows a typical network configuration incorporating Cisco Content Security Management appliance and multiple DMZs.

**Figure 88: Typical Network Configuration with Cisco Content Security Management Appliance**

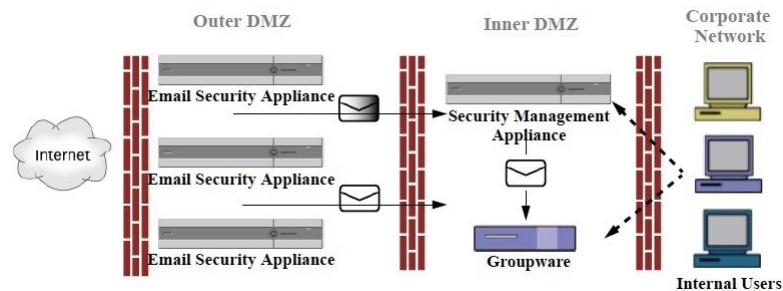

Large corporate data centers can share one Cisco Content Security Management appliance which acts as an external spam quarantine for one or more Email Security appliances. Meanwhile, remote offices can maintain local spam quarantines on Email Security appliances for local use.

## Working with an External Spam Quarantine

- [Mail Flow and External Spam Quarantine](#) , on page 1250
- [Migrating from a Local Spam Quarantine to an External Quarantine](#), on page 1251
- [Enabling an External Spam Quarantine and External Safelist/Blocklist](#) , on page 1251
- [Disabling the Local Spam Quarantine to Activate the External Quarantine](#) , on page 1252
- [Troubleshooting an External Spam Quarantine](#) , on page 1253

## Mail Flow and External Spam Quarantine

If your network is configured as described in [Network Planning, on page 1250](#), incoming mail from the Internet is received by appliances in the outer DMZ. Clean mail is sent along to the mail transfer agent (MTA) (groupware) in the inner DMZ and eventually to the end users within the corporate network.

Spam and suspected spam (depending on your mail flow policy settings) is sent to the spam quarantine on Cisco Content Security Management appliance. End users may then access the quarantine and elect to delete spam and release messages that they would like to have delivered to themselves. Messages remaining in the spam quarantine are automatically deleted after a configurable amount of time.

Messages that are released from the external quarantine on the Cisco Content Security Management appliance are returned to the originating Email Security appliance for delivery. These messages do not normally pass through the following processes before delivery: HAT and other policy or scanning settings, RAT, domain exceptions, aliasing, incoming filters, masquerading, bounce verification, and the work queue.



An Email Security appliance that is configured to send mail to a Cisco Content Security Management appliance will automatically expect to receive mail released from the Cisco Content Security Management appliance and will not reprocess those messages when they are received back. For this to work, the IP address of the Cisco Content Security Management appliance must not change. If the IP address of the Cisco Content Security Management appliance changes, the receiving Email Security appliance will process the message as it would any other incoming message. You should always use the same IP address for receiving and delivery on the Cisco Content Security Management appliance .

The Cisco Content Security Management appliance accepts mail for quarantining from the IP addresses specified in the spam quarantine settings. To configure the spam quarantine on the Security Management appliance, see the Cisco Content Security Management appliance User Guide.

Mail released by the Cisco Content Security Management appliance is delivered to the primary and secondary hosts (content security appliance or other groupware host) as defined in the spam quarantine settings (see the Cisco Content Security Management appliance User Guide). Therefore, regardless of the number of Email Security appliances delivering mail to the Cisco Content Security Management appliance , all released mail, notifications, and alerts are sent to a single host (groupware or content security appliance). Take care not to overburden the primary host for delivery from the Cisco Content Security Management appliance .

## Migrating from a Local Spam Quarantine to an External Quarantine

If you are currently using the local spam quarantine on an Email Security appliance but would like to migrate to an external spam quarantine hosted on a Cisco Content Security Management appliance — while retaining access to the messages in the local quarantine — you should prevent new messages from entering the local quarantine during the transition.

Consider the following possible strategies:

- Configuring anti-spam settings — Configure the anti-spam settings on your mail policy specifying Cisco Content Security Management appliance as the alternate host. This action sends new spam to the external quarantine while still allowing access to the local quarantine.
- Setting a shorter expiration time — Configure the Schedule Delete After setting on the local quarantine to a shorter duration.
- Deleting all of the remaining messages — To delete all remaining messages in the local quarantine, disable the quarantine and click the “Delete All” link on the local quarantines page (see [Deleting Messages from the Spam Quarantine, on page 946](#)). This link only becomes available when a local spam quarantine with messages still contained in it has been disabled.

You should now be ready to enable the external quarantine and disable the local quarantine.



---

**Note** If both the local quarantine and the external quarantine are enabled, the local quarantine is used.

---

## Enabling an External Spam Quarantine and External Safelist/Blocklist

You can enable only one external spam quarantine on an Email Security appliance .

### Before You Begin

- Review the information in [Mail Flow and External Spam Quarantine , on page 1250](#) .
- Review and take action on the information in [Migrating from a Local Spam Quarantine to an External Quarantine, on page 1251](#).

- Configure Cisco Content Security Management appliance to support the centralized spam quarantine and safelist/blocklist features. See the documentation for your Cisco Content Security Management appliance .
- If a different external spam quarantine was previously configured for the Email Security appliance, first disable the external spam quarantine setting.

Complete the following procedure on each Email Security appliance .

### Procedure

- 
- Step 1** Select **Security Services > Centralized Services > Spam Quarantine**.
- Step 2** Click **Configure**.
- Step 3** Select **Enable External Spam Quarantine**.
- Step 4** In the Name field, enter the name of Cisco Content Security Management appliance
- The name is not significant, and is used for reference only. For example, enter the hostname of Cisco Content Security Management appliance .
- Step 5** Enter an IP address and port number.
- These must match the IP address and port number that are specified on Cisco Content Security Management appliance in the Spam Quarantines Settings page (**Management Appliance > Centralized Services > Spam Quarantine**.)
- Step 6** (Optional) Select the check box to enable the **External Safelist/Blocklist** feature, and specify the appropriate blocklist action.
- Step 7** Submit and commit your changes.
- Step 8** Repeat this procedure for each Email Security appliance .
- 

### What to do next

If you have been using a local quarantine, see [Disabling the Local Spam Quarantine to Activate the External Quarantine](#) , on page 1252.

### Related Topics

- [Local Versus External Spam Quarantine](#) , on page 919
- [Spam Quarantine](#), on page 919
- [Managing Spam and Graymail](#), on page 359
- [How to Configure the Appliance to Scan Messages for Spam](#), on page 360

## Disabling the Local Spam Quarantine to Activate the External Quarantine

If you were using a local spam quarantine before enabling an external spam quarantine, you must disable the local quarantine in order to send messages to the external quarantine.

### Before You Begin

Follow all directions, including information in the Before You Begin section, in [Enabling an External Spam Quarantine and External Safelist/Blocklist](#) , on page 1251.

## Procedure

---

**Step 1** Select **Monitor > Spam Quarantine**.

**Step 2** In the Spam Quarantine section, click the **Spam Quarantine** link.

**Step 3** Deselect **Enable Spam Quarantine**.

Ignore any warnings to adjust mail policies as a result of this change. Mail policies automatically send messages to the external spam quarantine if you have configured the external quarantine settings.

**Step 4** Submit and commit your changes.

---

## Troubleshooting an External Spam Quarantine

### Email Security Appliance Reprocesses Messages Released from External Quarantine

**Problem:** Messages released from Cisco Content Security Management appliance are unnecessarily reprocessed by the Email Security appliance .

**Solution:** This can occur if the IP address of Cisco Content Security Management appliance has changed. See [Mail Flow and External Spam Quarantine](#) , on page 1250.

## About Centralizing Policy, Virus, and Outbreak Quarantines

- [Centralized Policy, Virus, and Outbreak Quarantines](#) , on page 1253
- [About Migration of Policy, Virus, and Outbreak Quarantines](#) , on page 1254
- [Centralizing Policy, Virus, and Outbreak Quarantines](#) , on page 1255
- [About Disabling Centralized Policy, Virus, and Outbreak Quarantines](#) , on page 1256
- [Troubleshooting Centralized Policy, Virus, and Outbreak Quarantines](#) , on page 1257

## Centralized Policy, Virus, and Outbreak Quarantines

You can centralize policy, virus, and outbreak quarantines on a Cisco Content Security Management appliance . Messages are processed by Email Security appliances but are stored in quarantines on Cisco Content Security Management appliance .

Centralizing policy, virus, and outbreak quarantines offers the following benefits:

- Administrators can manage quarantined messages from multiple Email Security appliances in one location.
- Quarantined messages are stored behind the firewall instead of in the DMZ, reducing security risk.
- Centralized quarantines can be backed up using the standard backup functionality on Cisco Content Security Management appliance .

For complete information, see the user guide or online help for your Cisco Content Security Management appliance .

## Restrictions and Limitations of Centralized Policy, Virus, and Outbreak Quarantines

- On each Email Security appliance , either all policy, virus, and outbreak quarantines must be centralized or all must be stored locally.

- Because scanning engines are not available on Cisco Content Security Management appliances, you cannot manually test messages in policy, virus, or outbreak quarantines for viruses.

## Requirements for Centralized Policy, Virus, and Outbreak Quarantines in Cluster Configurations

You can enable centralized policy, virus, and outbreak quarantines at any level for clustered appliances.

Requirements:

- Before you enable centralized policy, virus, and outbreak quarantines on an Email Security appliance at a particular level (machine, group, or cluster), all appliances that belong to the same level must first be added to Cisco Content Security Management appliance .
- Content and message filters and DLP message actions must be configured at the same level and not overridden at any level below that level.
- Centralized policy, virus, and outbreak quarantines settings must be configured at the same level and not be overridden at any level below the configured level.
- Ensure that the interface to be used for communications with Cisco Content Security Management appliance has the same name on all appliances in the group or cluster.

For example:

If you want to enable centralized policy, virus, and outbreak quarantines at the cluster or group level, but an Email Security appliance which is connected to the cluster has these settings defined at the machine level, you must remove the centralized quarantines settings configured at the machine level before you can enable the feature at the cluster or group level.

## About Migration of Policy, Virus, and Outbreak Quarantines

When you centralize policy, virus, and outbreak quarantines, existing policy, virus, and outbreak quarantines on your Email Security appliance migrate to Cisco Content Security Management appliance.

You will configure migration on Cisco Content Security Management appliance , but migration occurs when you commit the change enabling centralized policy, virus, and outbreak quarantines on the Email Security appliance .

As soon as you commit this change, the following occur:

- Local policy, virus, and outbreak quarantines on the Email Security appliance are disabled. All new messages entering these quarantines will be quarantined on Cisco Content Security Management appliance .
- Migration of existing non-spam quarantines to Cisco Content Security Management appliance begins.
- All local policy, virus, and outbreak quarantines are deleted. If you configured a custom migration, any local policy quarantines that you chose not to migrate are also deleted. For effects of deleting policy quarantines, see [About Deleting Policy Quarantines](#) , on page 906.
- A message that was in multiple quarantines before migration will be in the corresponding centralized quarantines after migration.
- Migration happens in the background. The amount of time it takes depends on the size of your quarantines and on your network. When you enable centralized quarantines on the Email Security appliance , you can enter one or more email addresses that will receive notification when migration is complete.
- The settings in the centralized quarantine, not those of the originating local quarantine, apply to the messages. However, the original expiration time still applies to each message.



---

**Note** All centralized quarantines that are automatically created during migration have the default quarantine settings.

---

## Centralizing Policy, Virus, and Outbreak Quarantines

### Before you begin



---

**Note** Perform this procedure during a maintenance window or off-peak hours.

---

- You must first configure your Cisco Content Security Management appliance for centralized policy, virus, and outbreak quarantines. See the table in the “Centralizing Policy Virus, and Outbreak Quarantines” section in the “Centralized Policy, Virus, and Outbreak Quarantines” chapter in the online help or user guide for Cisco Content Security Management appliance .
- If the space allocated to centralized quarantines on Cisco Content Security Management appliance will be smaller than the amount of space that your existing local quarantines collectively occupy, messages will be expired early based on the quarantine settings on Cisco Content Security Management appliance . Before migration, consider taking manual action to reduce quarantine sizes. For more information about early expiration, see [Default Actions for Automatically Processed Quarantined Messages , on page 903](#).
- If you have chosen automatic migration, or configured custom migration to create centralized quarantines during migration, consider noting the current quarantine settings on your Email Security appliances in order to use them as guidelines for configuring the centralized quarantines.
- If your Email Security appliances are deployed in a cluster configuration, see [Requirements for Centralized Policy, Virus, and Outbreak Quarantines in Cluster Configurations , on page 1254](#).
- Be aware of the changes that will occur as soon as you commit the changes in this procedure. See [About Migration of Policy, Virus, and Outbreak Quarantines , on page 1254](#).

### Procedure

---

- Step 1** Choose **Security Services > Centralized Services > Policy, Virus, and Outbreak Quarantines**.
- Step 2** Click **Enable**.
- Step 3** Enter the interface and port to use for communication with Cisco Content Security Management appliance .  
Make sure the interface and port are reachable from Cisco Content Security Management appliance .  
If your Email Security appliances are clustered, the interface you select must be available on all machines in the cluster.
- Step 4** To receive notification when migration is complete, enter one or more email addresses.
- Step 5** Verify the information about quarantines to be migrated to be sure that this is what you want.
- Step 6** If you are completing a Custom migration, note any quarantines that will be deleted when you commit the changes in this procedure.
- Step 7** Verify that the information about content and message filters and DLP message actions to be updated is as you expect it to be.

**Note** For cluster configurations, filters and message actions can be automatically updated on a particular level only if filters and message actions are defined at that level and not overridden at any level below that level. After migration, you may need to manually reconfigure filters and message actions with centralized quarantine names.

**Step 8** If you need to reconfigure migration mapping:

- a) Return to Cisco Content Security Management appliance .
- b) Reconfigure the migration mapping.

On Cisco Content Security Management appliance , select a quarantines to remap, then click **Remove from Centralized Quarantine**. Then you can remap the quarantine.

- c) Commit the new migration configuration on Cisco Content Security Management appliance .
- d) Start this procedure from the beginning.

**Important!** Be sure to reload the **Security Services > Centralized Services > Policy, Virus, and Outbreak Quarantines** page.

**Step 9** Click **Submit**.

**Step 10** If you need to reconfigure migration mapping, follow the procedure in Step 8.

**Step 11** Commit your changes.

**Note** While migration is in progress, avoid making configuration changes on Email Security appliance or Cisco Content Security Management appliance .

**Step 12** Look at the top of the page to monitor migration status, or, if you entered an email address when configuring migration, await the email notifying you that migration is complete.

### What to do next

Perform the remaining tasks described in the table in the “Centralizing Policy, Virus, and Outbreak Quarantines” topic in the online help or user guide for Cisco Content Security Management appliance .

### Related Topics

- [Which User Groups Can Access Policy, Virus, and Outbreak Quarantines](#) , on page 908

## About Disabling Centralized Policy, Virus, and Outbreak Quarantines

When you disable centralized policy, virus, and outbreak quarantines on the Email Security appliance :

- Local quarantines are automatically enabled on the Email Security appliance .
- System-created quarantines and quarantines that are referenced by message filters, content filters, and DLP message actions are automatically created on the Email Security appliance . The Virus, Outbreak, and Unclassified quarantines are created with the same settings that they had before quarantines were centralized, including assigned user roles. All other quarantines are created with default settings.
- Newly quarantined messages go immediately to local quarantines.
- Messages in the centralized quarantine at the time it is disabled remain there until one of the following occurs:
  - Messages are manually deleted or automatically deleted when they expire.
  - Messages are manually or automatically released, if one of the following is also true:

\* An alternate release appliance is configured on Cisco Content Security Management appliance . See the online help or documentation for Cisco Content Security Management appliance .

\* Centralized quarantines are again enabled on the Email Security appliance .

## Disabling Centralized Policy, Virus, and Outbreak Quarantines

### Before you begin

- Understand the impacts of disabling centralized policy, virus, and outbreak quarantines.
- Do one of the following:
  - Process all messages that are currently in centralized policy, virus, and outbreak quarantines.
  - Ensure that you have designated an alternate release appliance to process messages that are released from the centralized quarantine after you disable it. For information, see the online help or user guide for your Cisco Content Security Management appliance .

### Procedure

---

- Step 1** On the Email Security appliance , choose **Security Services > Centralized Services > Policy, Virus, and Outbreak Quarantines**.
- Step 2** Disable centralized policy, virus, and outbreak quarantines.
- Step 3** Submit and commit the change.
- Step 4** Customize the settings of the newly created local quarantines.
- 

## Troubleshooting Centralized Policy, Virus, and Outbreak Quarantines

### If a Cisco Content Security Management Appliance Goes Out of Service

If Policy, Virus, and Outbreak Quarantines are centralized on a Cisco Content Security Management appliance that goes out of service, you should disable these centralized quarantines on the Email Security appliance .

If you deploy a replacement Cisco Content Security Management appliance , you must reconfigure quarantine migration on Cisco Content Security Management appliance and on each Email Security appliance . See the table in the “Centralizing Policy Virus, and Outbreak Quarantines” section in the “Centralized Policy, Virus, and Outbreak Quarantines” chapter in the online help or user guide for Cisco Content Security Management appliance .

## Configuring Centralized Reporting

### Before you begin

- Enable and configure centralized reporting on a Cisco Content Security Management appliance . See prerequisites and instructions in Cisco Content Security Management Appliance User Guide.
- Ensure that sufficient disk space is allocated to the reporting service on Cisco Content Security Management appliance .

**Procedure**

- 
- Step 1** Click **Security Services > Reporting**.
- Step 2** In the Reporting Service section, select the Centralized Reporting option.
- Step 3** Submit and commit your changes.
- 

## Requirements for Advanced Malware Protection Reporting

For required configurations for full reporting on Advanced Malware Protection (file reputation and file analysis) features on Cisco Content Security Management appliance, see the information about Advanced Malware Protection reports in the email reporting chapter of the online help or user guide for your version of Cisco Content Security Management appliance software.

## Availability of Reporting Information after Changing to Centralized Reporting

When centralized reporting is enabled on an Email Security appliance :

- Existing data on the Email Security appliance for the monthly report is not transferred to Cisco Content Security Management appliance .
- Archived reports on the Email Security appliance are not available.
- The Email Security appliance stores only a week's worth of data.
- New data for the monthly and yearly reports is stored on Cisco Content Security Management appliance .
- Scheduled reports on the Email Security appliance are suspended.
- You can no longer access the scheduled report configuration page on the Email Security appliance .

## About Disabling Centralized Reporting

If you disable centralized reporting on the Email Security appliance, the Email Security appliance begins storing new monthly report data, scheduled reports resume, and you can access its archived reports. After disabling centralized reporting, the appliance only displays data for the past hour and day, but not the past week or month. This is temporary. The appliance will display the reports for the past week and month after it accumulates enough data. If the Email Security appliance is placed back into centralized reporting mode, it will display data for the past week in the interactive reports.

## Configuring Centralized Message Tracking

**Before you begin**

---

**Note** You cannot enable both centralized and local tracking on an Email Security appliance .

---



## Procedure

---

- Step 1** Click **Security Services > Message Tracking**.
- Step 2** In the Message Tracking Service section, click **Edit Settings**.
- Step 3** Select the **Enable Message Tracking Service** check box.
- Step 4** Select the Centralized Tracking option.
- Step 5** (Optional) Select the check box to save information for rejected connections.

**Note** Saving tracking information for rejected connections can adversely affect the performance of Cisco Content Security Management appliance .

- Step 6** Submit and commit your changes.

### What To Do Next

To use centralized tracking, you must enable the feature on the Email Security appliances *and* Cisco Content Security Management appliance . To enable centralized tracking on S Cisco Content Security Management appliance , see Cisco Content Security Management Appliance User Guide.

---

## Using Centralized Services

For instructions on using centralized services, see the Cisco Content Security Management Appliance User Guide.





# APPENDIX **A**

## FTP, SSH, and SCP Access

This appendix contains the following sections:

- [IP Interfaces, on page 1261](#)
- [Configuring FTP Access to the Email Security Appliance , on page 1262](#)
- [Secure Copy \(scp\) Access , on page 1264](#)
- [Accessing the Email Security appliance via a Serial Connection, on page 1265](#)

## IP Interfaces

An IP interface contains the network configuration data needed for an individual connection to the network. You can configure multiple IP interfaces to a physical Ethernet interface. You can assign an Internet Protocol version 4 (IPv4) or version 6 (IPv6) to an IP interface or both.

**Table 163: Services Enabled by Default on Interfaces**

|         |              | Enabled by default?               |                           |
|---------|--------------|-----------------------------------|---------------------------|
| Service | Default port | Management interface <sup>2</sup> | New interfaces you create |
| FTP     | 21           | No                                | No                        |
| SSH     | 22           | Yes                               | No                        |
| HTTP    | 80           | Yes                               | No                        |
| HTTPS   | 443          | Yes                               | No                        |

<sup>2</sup> The “Management Interface” settings shown here are also the default settings for the Data 1 Interface on Cisco C170 appliance .

- If you need to access the appliance via the graphical user interface (GUI), you must enable HTTP and/or HTTPS on an interface.
- If you need to access the appliance for the purposes of uploading or downloading configuration files, you must enable FTP on an interface.
- You can also upload or download files using secure copy ( scp ).

You can configure HTTP or HTTPS access to the spam quarantine via an IP interface.

For email delivery and Virtual Gateways, each IP interface acts as one Virtual Gateway address with a specific IP address and hostname. You can also “join” interfaces into distinct groups (via the CLI), and the system will cycle through these groups when delivering email.

Joining or grouping Virtual Gateways is useful for load-balancing large email campaigns across several interfaces. You can also create VLANs, and configure them just as you would any other interface (via the CLI). For more information, see [Advanced Network Configuration, on page 1099](#)

#### Related Topics

- [How AsyncOS Selects Default IP Interface, on page 1262](#)

## How AsyncOS Selects Default IP Interface

AsyncOS selects the default IP interface based on the lowest IP address in which the IP interfaces appear under **Network > IP Interfaces** page or in the `ifconfig` CLI command. The first IP interface in the list that resides on the subnet in question is used.

If there are multiple IP addresses configured within the same subnet as the default gateway, the IP address with the lowest number is used. For example, if the following IP addresses are configured within the same subnet,

- 10.10.10.2/24
- 10.10.10.30/24
- 10.10.10.100/24
- 10.10.10.105/24

AsyncOS chooses 10.10.10.2/24 as the default IP interface.

## Configuring FTP Access to the Email Security Appliance

### Procedure

**Step 1** Use the **Network > IP Interfaces** page or the `interfaceconfig` command to enable FTP access for the interface.

**Danger** By disabling services via the `interfaceconfig` command, you have the potential to disconnect yourself from the CLI, depending on how you are connected to the appliance. Do not disable services with this command if you are not able to reconnect to the appliance using another protocol, the Serial interface, or the default settings on the Management port.

**Step 2** Submit and commit your changes.

**Step 3** Access the interface via FTP. Ensure you are using the correct IP address for the interface. For example:

```
§ ftp 192.168.42.42
```

**Note** Many browsers also allow you to access interfaces via FTP.

**Step 4** Browse to the directory for the specific task you are trying to accomplish. After you have accessed an interface via FTP, you can browse the following directories to copy and add (“GET” and “PUT”) files. See the following table.

| Directory Name | Description                                                                                                                                                                                                                                                                                                                                                                                                                                                                                                                                                                                                                                                                                                                                                                                                                                                                                                                                                |
|----------------|------------------------------------------------------------------------------------------------------------------------------------------------------------------------------------------------------------------------------------------------------------------------------------------------------------------------------------------------------------------------------------------------------------------------------------------------------------------------------------------------------------------------------------------------------------------------------------------------------------------------------------------------------------------------------------------------------------------------------------------------------------------------------------------------------------------------------------------------------------------------------------------------------------------------------------------------------------|
| /configuration | <p>The directory where data from the following commands is exported to and/or imported (saved) from:</p> <ul style="list-style-type: none"> <li>• Virtual Gateway mappings ( <code>altsrchost</code> )</li> <li>• configuration data in XML format ( <code>saveconfig</code>, <code>loadconfig</code> )</li> <li>• Host Access Table (HAT) ( <code>hostaccess</code> )</li> <li>• Recipient Access Table (RAT) ( <code>rcptaccess</code> )</li> <li>• SMTP routes entries ( <code>smtproutes</code> )</li> <li>• alias tables ( <code>aliasconfig</code> )</li> <li>• masquerading tables ( <code>masquerade</code> )</li> <li>• message <b>filters</b> ( <code>filters</code> )</li> <li>• global unsubscribe data ( <code>unsubscribe</code> )</li> <li>• test messages for the <code>trace</code> command</li> <li>• Safelist/Blocklist backup file, saved in the following format:<br/><i>sbl&lt;timestamp&gt;&lt;serial number&gt;.csv</i></li> </ul> |
| /antivirus     | <p>The directory where the Anti-Virus engine log files are kept. You can inspect the log files this directory to manually check for the last successful download of the virus definition file ( <code>scan.dat</code> ).</p>                                                                                                                                                                                                                                                                                                                                                                                                                                                                                                                                                                                                                                                                                                                               |

| Directory Name    | Description                                                                                                                                                                                      |
|-------------------|--------------------------------------------------------------------------------------------------------------------------------------------------------------------------------------------------|
| /configuration    | Created automatically for <b>logging</b> via the <code>logconfig</code> and <code>rollovernow</code> commands. See <a href="#">Logging, on page 1113</a> for a detailed description of each log. |
| /system_logs      |                                                                                                                                                                                                  |
| /cli_logs         | See “Log File Type Comparison” for the differences between each log file type.                                                                                                                   |
| /status           |                                                                                                                                                                                                  |
| /reportd_logs     |                                                                                                                                                                                                  |
| reportqueryd_logs |                                                                                                                                                                                                  |
| /ftpd_logs        |                                                                                                                                                                                                  |
| /mail_logs        |                                                                                                                                                                                                  |
| /asarchive        |                                                                                                                                                                                                  |
| /bounces          |                                                                                                                                                                                                  |
| /error_logs       |                                                                                                                                                                                                  |
| /avarchive        |                                                                                                                                                                                                  |
| /gui_logs         |                                                                                                                                                                                                  |
| /sntpd_logs       |                                                                                                                                                                                                  |
| /RAID.output      |                                                                                                                                                                                                  |
| /euq_logs         |                                                                                                                                                                                                  |
| /scanning         |                                                                                                                                                                                                  |
| /antispam         |                                                                                                                                                                                                  |
| /antivirus        |                                                                                                                                                                                                  |
| /euqgui_logs      |                                                                                                                                                                                                  |
| /ipmitool.output  |                                                                                                                                                                                                  |

**Step 5** Use your FTP program to upload and download files to and from the appropriate directory.

## Secure Copy (scp) Access

If your client operating system supports a secure copy ( `scp` ) command, you can copy files to and from the directories listed in the previous table. For example, in the following example, the file `/tmp/test.txt` is copied from the client machine to the configuration directory of the appliance with the hostname of `mail3.example.com`.

Note that the command prompts for the passphrase for the user ( `admin` ). This example is shown for reference only; your particular operating system’s implementation of secure copy may vary.

```
% scp /tmp/test.txt admin@mail3.example.com:configuration
```

```
The authenticity of host 'mail3.example.com (192.168.42.42)' can't be established.
```

```

DSA key fingerprint is 69:02:01:1d:9b:eb:eb:80:0c:a1:f5:a6:61:da:c8:db.
Are you sure you want to continue connecting (yes/no)? yes

Warning: Permanently added 'mail3.example.com ' (DSA) to the list of known hosts.
admin@mail3.example.com's passphrase: (type the passphrase)
test.txt 100% |*****| 1007 00:00
%

```

In this example, the same file is copied from the appliance to the client machine:

```

% scp admin@mail3.example.com:configuration/text.txt .
admin@mail3.example.com's passphrase: (type the passphrase)
test.txt 100% |*****| 1007 00:00
%

```

You can use secure copy ( `scp` ) as an alternative to FTP to transfer files to and from the appliance .



**Note** Only users in the operators and administrators group can use secure copy ( `scp` ) to access the appliance . For more information, see [Adding Users](#) , on page 952.

## Accessing the Email Security appliance via a Serial Connection

If you are connecting to the appliance via a serial connection, use the following information for the console port.

Complete information about this port is in the hardware installation guide for your appliance.

### Pinout Details for the Serial Port in 80- and 90- Series Hardware

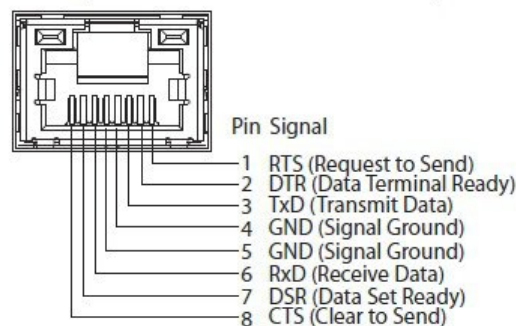

## Pinout Details for the Serial Port in 70-Series Hardware

The following figure illustrates the pin numbers for the serial port connector, and the following table defines the pin assignments and interface signals for the serial port connector.

**Figure 89: Pin Numbers for the Serial Port**

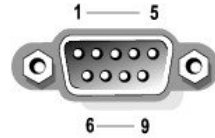

**Table 164: Serial Port Pin Assignments**

| Pin   | Signal | I/O | Definition          |
|-------|--------|-----|---------------------|
| 1     | DCD    |     | Data carrier detect |
| 2     | SIN    |     | Serial input        |
| 3     | SOUT   |     | Serial output       |
| 4     | DTR    |     | Data terminal ready |
| 5     | GND    | n/a | Signal ground       |
| 6     | DSR    |     | Data set ready      |
| 7     | RTS    |     | Request to send     |
| 8     | CTS    |     | Clear to send       |
| 9     | RI     |     | Ring indicator      |
| Shell | n/a    | n/a | Chassis ground      |





## APPENDIX **B**

# Assigning Network and IP Addresses

This appendix contains the following sections:

- [Ethernet Interfaces, on page 1267](#)
- [Selecting IP Addresses and Netmasks, on page 1267](#)
- [Strategies for Connecting Your Content Security Appliance , on page 1269](#)

## Ethernet Interfaces

Appliances have up to four Ethernet interfaces located on the rear panel of the system, depending on the configuration (whether or not you have the optional optical network interface). They are labeled:

- Management
- Data1
- Data2
- Data3
- Data4

## Selecting IP Addresses and Netmasks

When you configure the network, the appliance must be able to select a unique interface to send an outgoing packet. This requirement drives some of the decisions regarding IP address and netmask selection for the Ethernet interfaces. The rule is that only one interface can be on a single network (as determined through the applications of netmasks to the IP addresses of the interfaces).

An IP address identifies a physical interface on any given network. A physical Ethernet interface can have more than one IP address for which it accepts packets. An Ethernet interface that has more than one IP address can send packets over that interface with any one of the IP addresses as the source address in the packet. This property is used in implementing Virtual Gateway technology.

The purpose of a netmask is to divide an IP address into a network address and a host address. The network address can be thought of as the network part (the bits matching the netmask) of the IP address. The host address is the remaining bits of the IP address. The number of bits in a four octet address that are significant are sometimes expressed in Classless Inter-Domain Routing (CIDR) style. This is a slash followed by the number of bits (1-32).

A netmask can be expressed in this way by simply counting the ones in binary, so 255.255.255.0 becomes “ /24 ” and 255.255.240.0 becomes “ /20. ”

## Sample Interface Configurations

This section shows sample interface configurations based on some typical networks. The example uses two interfaces called Int1 and Int2. In the case of the appliance, these interface names can represent any two interfaces out of the three interfaces (Management, Data1, Data2).

### Network 1:

Separate interfaces must appear to be on separate networks.

| Interface | IP Address   | Netmask       | Net Address    |
|-----------|--------------|---------------|----------------|
| Int1      | 192.168.1.10 | 255.255.255.0 | 192.168.1.0/24 |
| Int2      | 192.168.0.10 | 255.255.255.0 | 192.168.0.0/24 |

Data addressed to 192.168.1.X (where X is any number from 1 through 255, except for your own address, 10 in this case) go out on Int1. Anything addressed to 192.168.0.X goes out on Int2. Any packet headed for some other address not in these formats, most likely out on a WAN or the Internet, is sent to the default gateway, which must be on one of these networks. The default gateway then forwards the packet on.

### Network 2:

The network addresses (network parts of the IP addresses) of two different interfaces cannot be the same.

| Ethernet Interface | IP Address   | Netmask     | Net Address    |
|--------------------|--------------|-------------|----------------|
| Int1               | 192.168.1.10 | 255.255.0.0 | 192.168.0.0/16 |
| Int2               | 192.168.0.10 | 255.255.0.0 | 192.168.0.0/16 |

This situation presents a conflict in that two different Ethernet interfaces have the same network address. If a packet from the content security appliance is sent to 192.168.1.11, there is no way to decide which Ethernet interface should be used to deliver the packet. If the two Ethernet interfaces are connected to two separate physical networks, the packet may be delivered to the incorrect network and never find its destination. The appliance does not allow you to configure your network with conflicts.

You can connect two Ethernet interfaces to the same physical network, but you must construct IP addresses and netmasks to allow the appliance to select a unique delivery interface.

## IP Addresses, Interfaces, and Routing

When you select an interface on which to perform a command or function in the GUI or CLI that allows you to select an interface (for example, upgrading AsyncOS or configuring DNS), routing (your default gateway) takes precedence over your selection.

For example, suppose that you have a appliance with the three network interfaces configured, each on a different network segment (assume all /24):

| Ethernet   | IP           |
|------------|--------------|
| Management | 192.19.0.100 |
| Data1      | 192.19.1.100 |

| Ethernet | IP           |
|----------|--------------|
| Data2    | 192.19.2.100 |

And your default gateway is 192.19.0.1.

Now, if you perform an AsyncOS upgrade (or other command or function that allows you to select an interface) and you select the IP that is on Data1 (192.19.1.100), you would expect all the TCP traffic to occur over the Data1 Ethernet interface. However, instead the traffic goes out of the interface that is set as your default gateway, in this case Management, but is stamped with the source address of the IP on Data1.

## Summary

The content security appliance must always be able to identify a unique interface over which a packet can be delivered. To make this decision, the appliance uses a combination of the packet's destination IP address, and the network and IP address settings of its Ethernet interfaces. The following table summarizes the preceding examples:

|                              | Same Network | Different Network |
|------------------------------|--------------|-------------------|
| Same Physical Interface      | Allowed      | Allowed           |
| Different Physical Interface | Not allowed  | Allowed           |

## Strategies for Connecting Your Content Security Appliance

Keep the following in mind when connecting your appliance :

- Administrative traffic (CLI, web interface, log delivery) is usually little compared to email traffic.
- If two Ethernet interfaces are connected to the same network switch, but end up talking to a single interface on another host downstream, or are connected to a network hub where all data are echoed to all ports, no advantage is gained by using two interfaces.
- SMTP conversations over an interface operating at 1000Base-T are slightly faster than conversations over the same interfaces operating at 100Base-T, but only under ideal conditions.
- There is no point in optimizing connections to your network if there is a bottleneck in some other part of your delivery network. Bottlenecks most often occur in the connection to the Internet and further upstream at your connectivity provider.

The number of interfaces that you choose to connect and how you address them should be dictated by the complexity of your underlying network. It is not necessary to connect multiple interfaces if your network topology or data volumes do not call for it. It is also possible to keep the connection simple at first as you familiarize yourself with the gateway and then increase the connectivity as volume and network topology require it.





## APPENDIX **C**

# Example of Mail Policies and Content Filters

This appendix contains the following sections:

- [Overview of Incoming Mail Policies](#) , on page 1271

## Overview of Incoming Mail Policies

The following example demonstrates the features of mail policies by illustrating the following tasks:

1. Editing the anti-spam, anti-virus, Outbreak Filter, and Content Filters for the default Incoming Mail Policy.
2. Adding two new policies for different sets of users — the sales organization and the engineering organization — and then configuring different email security settings for each.
3. Creating three new content filters to be used in the Incoming Mail Overview policy table.
4. Editing the policies again to enable the content filters for some groups, but not for others.

This example is meant to show the power and flexibility with which you can manage different recipient-based settings for anti-spam, anti-virus, Outbreak Filter, and Content Filters for mail policies. This example assigns these a custom user role called “Policy Administrator” that has mail policy and content filters access privileges. For more detailed information about how anti-spam, anti-virus, Outbreak filters, and delegated administration work, refer to the chapters following this one:

- [Managing Spam and Graymail](#), on page 359
- [Anti-Virus](#), on page 341
- [Outbreak Filters](#), on page 401
- [Distributing Administrative Tasks](#), on page 949

## Accessing Mail Policies

You can access incoming and outgoing mail policies by using the Mail Policies menu.

On brand new systems, if you completed all steps in the system setup wizard and you chose to enable Anti-Spam, Sophos or McAfee Anti-Virus, and Outbreak Filters, the Incoming Mail Policies Page will resemble in the following figure.

By default, these settings are enabled for the default Incoming Mail Policy:

- Anti-Spam (if the Spam Quarantine is enabled): Enabled
  - Positively-identified spam: quarantine, prepend the message subject
  - Suspected spam: quarantine, prepend the message subject

- Marketing email: scanning not enabled
- Anti-Spam (if the Spam Quarantine is not enabled): Enabled
  - Positively-identified spam: deliver, prepend the message subject
  - Suspected spam: deliver, prepend the message subject
  - Marketing email: scanning not enabled
- Anti-Virus: Enabled, Scan and Repair viruses, include an X-header with anti-virus scanning results
  - Repaired messages: deliver, prepend the message subject
  - Encrypted messages: deliver, prepend the message subject
  - Unscannable messages: deliver, prepend the message subject
  - Virus infected messages: drop
- Outbreak Filters: Enabled
  - No file extensions are excepted
  - Retention time for messages with suspect viral attachments is 1 day
  - Message modification is not enabled
- Content Filters: Disable

**Figure 90: Incoming Mail Policies Page: Defaults for a Brand New Appliance**

**Incoming Mail Policies**

**Find Policies**

Email Address:

Recipient  
 Sender

[Find Policies](#)

| Policies                      |                |                                                                                                     |                                                                              |                 |                                 |        |
|-------------------------------|----------------|-----------------------------------------------------------------------------------------------------|------------------------------------------------------------------------------|-----------------|---------------------------------|--------|
| <a href="#">Add Policy...</a> |                |                                                                                                     |                                                                              |                 |                                 |        |
| Order                         | Policy Name    | Anti-Spam                                                                                           | Anti-Virus                                                                   | Content Filters | Outbreak Filters                | Delete |
|                               | Default Policy | IronPort Anti-Spam<br>Positive: Quarantine<br>Suspected: Quarantine<br>Marketing Messages: Disabled | Sophos<br>Encrypted: Deliver<br>Unscannable: Deliver<br>Virus Positive: Drop | Disabled        | Retention Time:<br>Virus: 1 day |        |

Key: Default Custom Readonly



**Note** In this example, the Incoming Mail Policy will use the default anti-spam settings for when the Spam Quarantine is enabled.

## Enabled, Disabled, and “Not Available”

The columns in a mail policy table (either incoming or outgoing) display links for the state of the security service for each policy name. If a service is enabled, the word “Enabled” or a summary of the configuration is displayed. Similarly, the word “Disabled” is displayed if a service is disabled.

“Not Available” is displayed as a link if the license agreement for a service has not been accepted yet or a service has expired. In these cases, clicking the “Not Available” link will display the global page within the Security Services tab, rather than the page where you can configure per-policy settings for a service. An alert is displayed to let you know that your page has changed to a different tab. See the following figure.

Figure 91: Security Services Not Available

**Incoming Mail Policies**

Find Policies

Email Address:   Recipient  Sender

**Policies**

| Order | Policy Name    | Anti-Spam     | Anti-Virus    | Content Filters | Outbreak Filters | Delete |
|-------|----------------|---------------|---------------|-----------------|------------------|--------|
|       | Default Policy | Not Available | Not Available | Disabled        | Not Available    |        |

Key:

## Configuring the Default Anti-Spam Policies for Incoming Messages

Each row in the mail policy table represents a different policy. Each column represents a different security service.

- To edit the default policy, click any of the links for a security service in the bottom row of the incoming or outgoing mail policy table.

In this example, you will change the anti-spam settings for the default policy for incoming mail to be more aggressive. The default value is to quarantine positively identified and suspected spam messages, with marketing email scanning disabled. This example shows how to change the setting so that positively identified spam is dropped. Suspected spam continues to be quarantined. Marketing email scanning is enabled, with marketing messages being delivered to the intended recipients. The subjects of marketing messages will be prepended with the text [MARKETING].

### Procedure

- 
- Step 1** Click the link for the anti-spam security service.
- Note** For default security service settings, the first setting on the page defines whether the service is enabled for the policy. You can click “Disable” to disable the service altogether.
- Step 2** In the “Positively Identified Spam Settings” section, change the “Action to apply to this message” to Drop.
- Step 3** In the “Marketing Email Settings” section, click **Yes** to enable marketing email scanning.
- If enabled, the default action is to deliver legitimate marketing messages while prepending the subject with the text [MARKETING].
- The “Add text to message” field only accepts US-ASCII characters.
- Step 4** Click **Submit**. Note that the summary link for the anti-spam security service in the Incoming Mail Policies table has changed to reflect the new values.
- Similar to the steps above, you can change the default anti-virus and virus outbreak filter settings for the default policy.

Figure 92: Anti-Spam Settings Page

**Mail Policies: Anti-Spam**

| Anti-Spam Settings                                                                                 |                                                                                                           |
|----------------------------------------------------------------------------------------------------|-----------------------------------------------------------------------------------------------------------|
| <b>Policy:</b>                                                                                     | Default                                                                                                   |
| Enable Anti-Spam Scanning for This Policy:                                                         | <input checked="" type="radio"/> Use IronPort Anti-Spam service<br><input type="radio"/> Disabled         |
| <b>Positively-Identified Spam Settings</b>                                                         |                                                                                                           |
| Apply This Action to Message:                                                                      | Drop                                                                                                      |
| Add Text to Subject:                                                                               | Prepend [SPAM]                                                                                            |
| Advanced Optional settings for custom header and message delivery.                                 |                                                                                                           |
| <b>Suspected Spam Settings</b>                                                                     |                                                                                                           |
| Enable Suspected Spam Scanning:                                                                    | <input type="radio"/> No <input checked="" type="radio"/> Yes                                             |
| Apply This Action to Message:                                                                      | Spam Quarantine                                                                                           |
| <i>Note: If local and external quarantines are defined, mail will be sent to local quarantine.</i> |                                                                                                           |
| Add Text to Subject:                                                                               | Prepend [SUSPECTED SPAM]                                                                                  |
| Advanced Optional settings for custom header and message delivery.                                 |                                                                                                           |
| <b>Marketing Email Settings</b>                                                                    |                                                                                                           |
| Enable Marketing Email Scanning:                                                                   | <input type="radio"/> No <input checked="" type="radio"/> Yes                                             |
| Apply This Action to Message:                                                                      | Deliver                                                                                                   |
| Send to Alternate Host (optional):                                                                 |                                                                                                           |
| Add Text to Subject:                                                                               | Prepend [MARKETING]                                                                                       |
| Advanced Optional settings for custom header and message delivery.                                 |                                                                                                           |
| <b>Spam Thresholds</b>                                                                             |                                                                                                           |
| <i>Spam is scored on a 1-100 scale. The higher the score, the more likely a message is a spam.</i> |                                                                                                           |
| IronPort Anti-Spam:                                                                                | <input checked="" type="radio"/> Use the Default Thresholds<br><input type="radio"/> Use Custom Settings: |
| Positively Identified Spam:                                                                        | Score > 90 (50 - 100)                                                                                     |
| Suspected Spam:                                                                                    | Score > 50 (minimum 25, cannot exceed positive spam score)                                                |

Cancel Submit

## Creating a Mail Policy for a Group of Sender and Recipients

In this part of the example, you will create two new policies: one for the sales organization (whose members will be defined by an LDAP acceptance query), and another for the engineering organization. Both policies will be assigned to the Policy Administrator custom user role to make delegated administrators belonging to this role responsible for managing these policies. You will then configure different email security settings for each.

### Procedure

- Step 1** Click the **Add Policy** button to begin creating a new policy.
- Step 2** Define a unique name for and adjust the order of the policy (if necessary).  
The name of the policy must be unique to the Mail Policies table (either incoming or outgoing) in which it is defined.  
Remember that each recipient is evaluated for each policy in the appropriate table (incoming or outgoing) in a top-down fashion.
- Step 3** Click the Editable by (Roles) link and select the custom user roles for the delegated administrators who will be responsible for managing the mail policy.



When you click the link, AsyncOS displays the custom roles for delegated administrators that have edit privileges for mail policies. Delegated administrators can edit a policy's Anti-Spam, Anti-Virus, and Outbreak Filters settings and enable or disable content filters for the policy. Only operators and administrators can modify a mail policy's name or its senders, recipients, or groups. Custom user roles that have full access to mail policies are automatically assigned to mail policies.

See the [Distributing Administrative Tasks, on page 949](#) for more information on delegated administration.

#### Step 4 Define users for the policy.

You define whether the user is a sender or a recipient. (See [Examples of Policy Matching, on page 260](#) for more detail.) The form shown in the following figure defaults to recipients for incoming mail policies and to senders for outgoing mail policies.

Users for a given policy can be defined in the following ways:

- Full email address: user@example.com
- Partial email address: user@
- All users in a domain: @example.com
- All users in a partial domain: @.example.com
- By matching an LDAP Query

**Note** Entries for users are case-insensitive in both the GUI and CLI in AsyncOS. For example, if you enter the recipient Joe@ for a user, a message sent to joe@example.com will match.

If you store user information within LDAP directories in your network infrastructure — for example, in Microsoft Active Directory, SunONE Directory Server (formerly known as “iPlanet Directory Server”), or Open LDAP directories — you can configure the appliance to query your LDAP servers for the purposes of accepting recipient addresses, rerouting messages to alternate addresses and/or mail hosts, masquerading headers, and determining if messages have recipients or senders from specific groups.

If you have configured the appliance to do so, you can use the configured queries to define users for a mail policy.

See [LDAP Queries, on page 749](#) for more information.

**Figure 93: Defining Users for a Policy**

The screenshot shows the 'Add Incoming Mail Policy' configuration window. It is divided into several sections:

- Add Policy:**
  - Policy Name: Sales\_Team (with a help icon and example text: e.g. my IT policy)
  - Editable by (Roles): No roles selected
  - Insert Before Policy: 1 (Default Policy)
- Add Users:**
  - Radio buttons for 'Sender' and 'Recipient' (selected).
  - Text input for 'Email Address(es)' with an 'Add >' button.
  - Example text: (e.g. user@example.com, user@, @example.com, @.example.com)
  - 'Remove' button.
  - 'LDAP Group Query' section:
    - Query: Sales\_West.group
    - Group: (empty input field)
- Current Users:**
  - List box containing: Recipient: Sales\_West.group: West

At the bottom of the window are 'Cancel' and 'Submit' buttons.

#### Step 5 Click the **Add** button to add users into the Current Users list.

Policies can contain mixtures of senders, recipients, and LDAP queries.

Use the **Remove** button to remove a defined user from the list of current users.

**Step 6** When you are finished adding users, click **Submit**.

Note that all security services settings are set to use the default values when you first add a policy.

**Figure 94: Newly Added Policy — Sales Group**

| Policies      |                |                                                                                                     |                                                                              |                 |                                 |        |
|---------------|----------------|-----------------------------------------------------------------------------------------------------|------------------------------------------------------------------------------|-----------------|---------------------------------|--------|
| Add Policy... |                |                                                                                                     |                                                                              |                 |                                 |        |
| Order         | Policy Name    | Anti-Spam                                                                                           | Anti-Virus                                                                   | Content Filters | Outbreak Filters                | Delete |
| 1             | Sales_Team     | (use default)                                                                                       | (use default)                                                                | (use default)   | (use default)                   |        |
|               | Default Policy | IronPort Anti-Spam<br>Positive: Quarantine<br>Suspected: Quarantine<br>Marketing Messages: Disabled | Sophos<br>Encrypted: Deliver<br>Unscannable: Deliver<br>Virus Positive: Drop | Disabled        | Retention Time:<br>Virus: 1 day |        |

**Step 7** Click the **Add Policy** button again to add another new policy.

In this policy, individual email addresses for members of the engineering team are defined:

**Figure 95: Creating a Policy for the Engineering Team**

**Add Incoming Mail Policy**

**Add Policy**

Policy Name:  (e.g. my IT policy)

Editable by (Roles): Policy Administrator

Insert Before Policy: 2 (Default Policy) ▼

---

**Add Users**

Sender

Recipient ?

Email Address(es)

mary@example.com  
fred@example.com

(e.g. user@example.com, user@, @example.com, @.example.com)

LDAP Group Query

Query: Sales\_West.group ▼

Group:

**Current Users**

Recipient: bob@example.com  
Recipient: mary@example.com  
Recipient: fred@example.com

**Step 8** When you are finished adding users for the engineering policy, click **Submit**.

**Step 9** Commit your changes.

**Figure 96: Newly Added Policy — Engineering Team**

| Policies      |                |                                                                                                     |                                                                              |                 |                                 |        |
|---------------|----------------|-----------------------------------------------------------------------------------------------------|------------------------------------------------------------------------------|-----------------|---------------------------------|--------|
| Add Policy... |                |                                                                                                     |                                                                              |                 |                                 |        |
| Order         | Policy Name    | Anti-Spam                                                                                           | Anti-Virus                                                                   | Content Filters | Outbreak Filters                | Delete |
| 1             | Sales_Team     | (use default)                                                                                       | (use default)                                                                | (use default)   | (use default)                   |        |
| 2             | Engineering    | (use default)                                                                                       | (use default)                                                                | (use default)   | (use default)                   |        |
|               | Default Policy | IronPort Anti-Spam<br>Positive: Quarantine<br>Suspected: Quarantine<br>Marketing Messages: Disabled | Sophos<br>Encrypted: Deliver<br>Unscannable: Deliver<br>Virus Positive: Drop | Disabled        | Retention Time:<br>Virus: 1 day |        |

**Note** At this point, both newly created policies have the same settings applied to them as those in the default policy. Messages to users of either policy will match; however, the mail processing settings are not any different from the default policy. Therefore, messages that match users in the “Sales\_Group” or “Engineering” policies will not be processed any differently than the default policy.

## Default, Custom, and Disabled

The key at the bottom of the table shows how the color coding of cells for specific policies relates to the policy defined for the default row:

- Yellow shading shows that the policy is using the same settings as the default policy.
- No shading (white) shows that the policy is using different settings than the default policy.
- Grey shading shows that the security service has been disabled for the policy.

## Creating Mail Policies for Different Groups of Senders and Recipients

In this part of the example, you will edit the two policies just created in the previous section.

- For the sales group, you will change the anti-spam settings to be even more aggressive than the default policy. (See [Configuring the Default Anti-Spam Policies for Incoming Messages, on page 1273](#).) The default policy of dropping positively identified spam messages will be kept. However, in this example, you will change the setting for marketing messages so that they will be sent to the Spam quarantine.

This aggressive policy has the effect of minimizing unwanted messages being sent to sales team inboxes.

See [Managing Spam and Graymail, on page 359](#) for more information on anti-spam settings.

- For the engineering team, customize the Outbreak Filters feature setting so that it will modify the URLs in suspicious messages, except for links to example.com. Attachment files with the extension “dwg” will be bypassed by the Outbreak Filter scanning.

See [Outbreak Filters, on page 401](#) for more information on configuring Outbreak Filters.

To edit the anti-spam settings for the sales team policy:

### Procedure

- 
- Step 1** Click the link for the Anti-Spam security service (the Anti-Spam) column in the sales policy row. Because the policy was just added, the link is named: (use default) .
- Step 2** On the anti-spam security service page, change the value for “Enable Anti-Spam Scanning for this Policy” from “Use Default Settings” to “Use Anti-Spam service.”
- Choosing “Use Anti-Spam service” here allows you to override the settings defined in the default policy.
- Step 3** In the “Positively-Identified Spam Settings” section, change the “Apply This Action to Message” to “Drop.”
- Step 4** In the “Suspected Spam Settings” section, click **Yes** to enable suspected spam scanning.
- Step 5** In the “Suspected Spam Settings” section, change the “Apply This Action to Message” to “Spam Quarantine.”

**Note** Selecting the Spam quarantine forwards mail according to the settings defined in the Spam Quarantine chapter.

**Step 6** In the “Add text to subject” field, click **None**.

Messages delivered to the Spam quarantine will have no additional subject tagging.

**Step 7** In the “Marketing Email Settings” section, click **Yes** to enable scanning for marketing mail from legitimate sources.

**Step 8** In the “Apply This Action to Message” section, select “Spam Quarantine.”

**Step 9** Submit and commit your changes.

Not that the shading shows that the policy is using different settings than the default policy.

At this point, any message that is suspected spam and whose recipient matches the LDAP query defined for the sales team policy will be delivered to the Spam Quarantine.

## Creating Mail Policies for Different Groups of Senders and Recipients

To edit the Outbreak Filter settings for the engineering team policy:

### Procedure

**Step 1** Click the link for the Outbreak Filters feature security service (the Outbreak Filters column) in the engineering policy row.

Because the policy was just added, the link is named: (use default) .

**Step 2** On the Outbreak Filters feature security service page, change the scanning setting for the policy to “Enable Outbreak Filtering (Customize settings).”

Choosing “(Customize settings)” here allows you to override the settings defined in the default policy.

Doing so will also enable the contents of the rest of the page to allow you to select different settings.

**Step 3** In the “Bypass Attachment Scanning” section of the page, type **dwg** in the in the file extension field.

The file extension “ dwg ” is not in the list of known file type that the appliance can recognize by its fingerprint when attachment scanning.

**Note** You do not need to type the period ( . ) before the three letter filename extension.

**Step 4** Click **Add Extension** to add .dwg files to the list of file extensions that will bypass Outbreak Filters feature scanning.

**Step 5** Click **Enable Message Modification**.

Enabling message modification allows the appliance to scan for targeted threats, such as phishing and scams, and URLs to suspicious or malicious websites. The appliance can rewrite links in messages to redirect the user through the Cisco Security proxy if they attempt to access the website.

**Note** Anti-spamming scanning must be enabled on the mail policy in order for Outbreak Filters to scan for targeted, non-viral threats.

**Step 6** Select for **Enable for Unsigned Messages**.

This allows the appliance to rewrite URLs in signed messages. You must enable URL rewriting to be able to configure other Message Modification settings and the length of time that messages found to be non-viral threats stay in the quarantine before being released. This example uses the default retention time of 4 hours.

**Step 7** Enter example.com in the **Bypass Domain Scanning** field.

The appliance will not modify links to example.com.

**Step 8** Select System Generated for the **Threat Disclaimer**.

The appliance can insert a disclaimer above the message body to warn the user about the message's contents. The following example uses the system generated threat disclaimer.

**Figure 97: Outbreak Filters Settings**

**Mail Policies: Outbreak Filters**

Outbreak Filtering for Policy: Sales\_Team  
 Enable Outbreak Filtering (Customize settings)

**Outbreak Filter Settings**

Quarantine Threat Level:

Maximum Quarantine Retention: Viral Attachments:  Days  
 Other Threats:  Hours

Bypass Attachment Scanning:    **File Extensions to Bypass**  
 None defined

**Message Modification**

Enable Message Modification

Message Modification Threat Level:

Message Subject: Prepend

URL Rewriting: Cisco Security proxy scans and rewrites suspicious or malicious URLs.  
 Enable only for unsigned messages (recommended)  
 Enable for all messages  
 Disable

Bypass Domain Scanning   
 (examples: example.com, crm.example.com, 10.0.0.1, 10.0.0.0/24)

Threat Disclaimer:

Disclaimer text will be applied to the top of the message body for Suspicious and Quarantined messages. To create custom disclaimers go to Mail Policies > Text Resources

**Step 9** Submit and commit your changes.

Note that the shading shows that the policy is using different settings than the default policy.

At this point, any message that contains an attachment whose file extension is dwg — and whose recipient matches the recipients defined for the engineering team policy — will bypass the Outbreak Filter scanning and continue processing. Messages that contain links to the example.com domain will not have their links modified to redirect through the Cisco Security proxy and will not be considered suspicious.

## Finding Senders or Recipients in Mail Policies

Use the “Find Policies” button to search for users already defined in policies defined in the Incoming or Outgoing Mail Policies pages.

For example, typing joe@example.com and clicking the Find Policies button will display results showing which policies contain defined users that will match the policy.

Click the name of the policy to jump to the Edit Policy page to edit the users for that policy.

Note that the default policy will always be shown when you search for any user, because, by definition, if a sender or recipient does not match any other configured policies, it will *always* match the default policy.

## Managed Exceptions

Using the steps shown in the two examples above, you can begin to create and configure policies on a *managed exception* basis. In other words, after evaluating your organization’s needs you can configure policies so that the majority of messages will be handled by the default policy. You can then create additional “exception” policies for specific users or user groups, managing the differing policies as needed. In this manner, message splintering will be minimized and you are less likely to impact system performance from the processing of each splinter message in the work queue.

You can define policies based on your organizations’ or users’ tolerance for spam, viruses, and policy enforcement. The following table outlines several example policies. “Aggressive” policies are designed to minimize the amount of spam and viruses that reach end-users mailboxes. “Conservative” policies are tailored to avoid false positives and prevent users from missing messages, regardless of policies.

**Table 165: Aggressive and Conservative Mail Policy Settings**

|               | <b>Aggressive Settings</b>                                                                                                                  | <b>Conservative Settings</b>                                                                                                                            |
|---------------|---------------------------------------------------------------------------------------------------------------------------------------------|---------------------------------------------------------------------------------------------------------------------------------------------------------|
| Anti-Spam     | Positively identified spam: Drop<br>Suspected spam: Quarantine<br>Marketing mail: Deliver and prepend “[Marketing]” to the subject messages | Positively identified spam: Quarantine<br>Suspected spam: Deliver and prepend “[Suspected Spam]” to the subject of messages<br>Marketing mail: Disabled |
| Anti-Virus    | Repaired messages: Deliver<br>Encrypted messages: Drop<br>Unscannable messages: Drop<br>Infectious messages: Drop                           | Repaired messages: Deliver<br>Encrypted messages: Quarantine<br>Unscannable messages: Quarantine<br>Infectious messages: Drop                           |
| Virus Filters | Enabled, no specific filename extensions or domains allowed to bypass<br>Enable message modification for all messages                       | Enabled with specific filename extensions or domains allowed to bypass<br>Enable message modification for unsigned messages                             |

## Filtering Messages Based on Content

In this part of the example, you will create three new content filters to be used in the Incoming Mail Policy table. All of these content filters will be editable by delegated administrators belonging to the Policy Administration custom user role. You will create the following:

1. “scan\_for\_confidential”

This filter will scan messages for the string “confidential.” If the string is found, a copy of the message will be sent to email alias hr@example.com , and the message will be sent to the Policy quarantine area.

2. “no\_mp3s”

This filter will strip MP3 attachments and notify the recipients that an MP3 file was stripped.

3. “ex\_employee”

This content filter will scan for messages sent to a specific envelope recipient address (an ex-employee). If the message matches, a specific notification message will be sent to the sender of the message and then the message will be bounced.

After creating the content filters, you will then configure each of the policies (including the default policy) to enable the specific content filters in differing combinations.

## Quarantining Message with “Confidential” in the Subject

The first example content filter contains one condition and two actions.

### Procedure

---

- Step 1** Click the Mail Policies tab.
- Step 2** Click Incoming Content Filters.
- Step 3** Click the **Add Filter** button.
- Step 4** In the Name field, type scan\_for\_confidential as the name of the new filter.
- Filter names can contain ASCII characters, numbers, underscores or dashes. The first character of a content filter name must be a letter or an underscore.
- Step 5** Click the **Editable By (Roles)** link, select the Policy Administrator and click **OK**.
- Delegated administrators who belong to the Policy Administrator user role will be able to edit this content filter and use it in their mail policies.
- Step 6** In the Description field, type the description. For example: scan all incoming mail for the string ‘confidential’.
- Step 7** Click Add Condition.
- Step 8** Select Message Body.
- Step 9** Type confidential in the Contains text: field and click **OK**.
- The Add Content Filter page shows the condition added.
- Step 10** Click Add Action.
- Step 11** Select Send Copy To (Bcc:).

- Step 12** In the Email Addresses field, type `hr@example.com` .
- Step 13** In the Subject field, type `[message matched confidential filter]` .
- Step 14** Click **OK**.

The Add Content Filter page shows the action added.

- Step 15** Click Add Action.
- Step 16** Select Quarantine.
- Step 17** In the drop-down menu, select the Policy quarantine area.
- Step 18** Click **OK**.

The Add Content Filter page shows the second action added.

- Step 19** Submit and commit your changes.

At this point, the content filter is not enabled for any incoming Mail Policy; in this example, you have only added a new content filter to the primary list. Because it has not been applied to any policy, no email processing by the appliance will be affected by this filter.

---

## Stripping MP3 Attachments from Messages

The second example content filter contains no conditions and one action.

### Procedure

- Step 1** Click the **Add Filter** button.
- Step 2** In the Name field, type `no_mp3s` as the name of the new filter.
- Step 3** Click the **Editable By (Roles)** link, select the Policy Administrator and click **OK**.
- Step 4** In the Description field, type the description. For example: `strip all MP3 attachments` .
- Step 5** Click Add Action.
- Step 6** Select Strip Attachment by File Info.
- Step 7** Select File type is .
- Step 8** In the drop-down field, select `-- mp3` .
- Step 9** Enter a replacement message if desired.
- Step 10** Click **OK**.
- Step 11** Submit and commit your changes.

**Note** It is not necessary to specify a condition when creating a content filter. When no condition is defined, any actions defined will always apply in the rule. (Specifying no condition is equivalent to using the `true()` message filter rule — all messages will be matched if the content filter is applied to a policy.)

---

## Bouncing Messages Sent to a Former Employee

The third content filter example uses one condition and two actions.



## Procedure

---

- Step 1** Click the **Add Filter** button.
- Step 2** In the Name: field, type **ex\_employee** as the name of the new filter.
- Step 3** Click the **Editable By (Roles)** link, select the Policy Administrator and click **OK**.
- Step 4** In the Description: field, type the description. For example: **bounce messages intended for Doug**.
- Step 5** Click **Add Condition**.
- Step 6** Select **Envelope Recipient**.
- Step 7** For the envelope recipient, select **Begins with**, and type **doug@**.
- Step 8** Click **OK**.
- The Content Filters page refreshes to show the condition added. Note that you could create an LDAP directory containing the email addresses of former employees. As ex-employees are added to that directory, this content filter would be dynamically updated.
- Step 9** Click Add Action.
- Step 10** Select Notify.
- Step 11** Select the checkbox for Sender and, in the **Subject** field, type message bounced for ex-employee of **example.com**.
- Step 12** In the Use template section, select a notification template.
- Note** Some sections of the content filter rule builder will not appear in the user interface if the resource has not been preconfigured. For example, content dictionaries, notification templates, and message disclaimers will not appear as options if they have not been configured previously via the **Mail Policies > Dictionaries** page (or the **dictionaryconfig** command in the CLI). For more information about creating dictionaries, see [Content Dictionaries, on page 619](#).
- Step 13** Click **OK**.
- The Add Content Filters page shows the action added.
- Step 14** Click Add Action.
- Step 15** Select Bounce (Final Action) and click **OK**.
- You can only specify one final action for a content filter. If you try to attempt to add more than one final action, the GUI displays an error.
- Adding this action may will cause senders of messages to this ex-employee to potentially receive two messages: one for the notification template, and one for the bounce notification template.
- Step 16** Submit and commit your changes.
- 

## Applying Individual Content Filters to Different Groups of Recipients

In the examples above, you created three content filters using the Incoming Content Filters pages. The Incoming Content Filters and Outgoing Content filters pages hold the “primary lists” of all possible content filters that can be applied to a policy.

Figure 98: Incoming Content Filters: Three Filters Created

## Incoming Content Filters

| Filters       |                       |                                                      |           |        |
|---------------|-----------------------|------------------------------------------------------|-----------|--------|
| Add Filter... |                       |                                                      |           |        |
| Order         | Filter Name           | Description   Rules   Policies                       | Duplicate | Delete |
| 1             | scan_for_confidential | scan all incoming mail for the string 'confidential' |           |        |
| 2             | no_mp3s               | strip all MP3 attachments                            |           |        |
| 3             | ex_employee           | bounce messages intended for Doug                    |           |        |

In this part of the example, you will apply the three new content filters to be used in the Incoming Mail Policy table.

- The default policy will receive all three content filters.
- The engineering group will *not* receive the no\_mp3s filter.
- The sales group will receive the content filters as the default incoming mail policy.

## Enabling Content Filters for All Recipients by Default

Click the links to enable and select content filters for individual policies.

### Procedure

- 
- Step 1** Click Incoming Mail Policies to return to the Incoming Mail Policy table.
- The page is refreshed to show the default policy and the two policies added in [Creating a Mail Policy for a Group of Sender and Recipients, on page 1274](#). Note that content filtering is disabled by default for all policies.
- Step 2** Click the link for the Content Filters security service (the Content Filters column) in the default policy row.
- Step 3** On the Content Filtering security service page, change the value Content Filtering for Default Policy from “Disable Content Filters” to “Enable Content Filters (Customize settings).”
- The content filters defined in the primary list (which were created in [Overview of Content Filters , on page 271](#) using the Incoming Content Filters pages) are displayed on this page. When you change the value to “Enable Content Filters (Customize settings),” the checkboxes for each filter change from disabled (greyed out) to become enabled.
- Step 4** Check the **Enable** checkbox for each content filter.
- Step 5** Click **Submit**.
- The table on the Incoming Mail Policies page shows the names of the filters that have been enabled for the default policy.
- 

## Allowing MP3 Attachments for Recipients in Engineering

To disable the “no\_mp3s” content filters for the “engineering” policy:

## Procedure

---

- Step 1** Click the link for the Content Filters security service (the Content Filters column) in the engineering team policy row.
- Step 2** On the Content Filtering security service page, change the value for Content Filtering for Policy: Engineering from “Enable Content Filtering (Inherit default policy settings)” to “Enable Content Filtering (Customize settings).”
- Because this policy was using the default values, when you change the value from “Use Default Settings” to “Yes,” the checkboxes for each filter change from disabled (greyed out) to become enabled.
- Step 3** Deselect the checkbox for the “no\_mp3s” filter.
- Step 4** Click **Submit**.
- The table on the Incoming Mail Policies page shows the names of the filters that have been enabled for the engineering policy.
- Step 5** Commit your changes.
- 

## What to do next

At this point, incoming messages that match the user list for the engineering policy will not have MP3 attachments stripped; however, all other incoming messages will have MP3 attachments stripped.

## Notes on Configuring Content Filters in the GUI

- It is not necessary to specify a condition when creating a content filter. When no action is defined, any actions defined will always apply in the rule. (Specifying no action is equivalent to using the true() message filter rule — all messages will be matched if the content filter is applied to a policy.)
- If you do not assign a custom user role to a content filter, the content filter is public and can be used by any delegated administrator for their mail policies. See [Distributing Administrative Tasks, on page 949](#) for more information on delegated administrators and content filters.
- Administrators and operators can view and edit all content filters on an appliance, even when the content filters are assigned to custom user roles.
- When entering text for filter rules and actions, the following meta characters have special meaning in regular expression matching: . ^ \$ \* + ? { [ ] \ | ( )

If you do not wish to use regular expression you should use a '\' (backslash) to escape any of these characters. For example: "\"\*Warning\"\*"

- When you define more than one Condition for a content filter, you can define whether *all* of the defined actions (that is, a logical AND) or any of the defined actions (logical OR) need to apply in order for the content filter to be considered a match.
- You can test message splintering and content filters by creating “benign” content filters. For example, it is possible to create a content filter whose only action is “deliver.” This content filter will not affect mail processing; however, you can use this filter to test how the mail policy processing affects other elements in the system (for example, the mail logs).
- Conversely, using the “primary list” concept of the Incoming or Outgoing Content Filters, it is possible to create very powerful, wide-sweeping content filters that will immediately affect message processing for all mail handled by the appliance. The process for this is to:

- Use the Incoming or Outgoing Content Filters page to create a new content filter whose order is 1.
  - Use the Incoming or Outgoing Mail Policies page to enable the new content filter for the default policy.
  - Enable the content filter for all remaining policies.
- The Bcc: and Quarantine actions available in Content Filters can help you determine the retention settings of quarantines you create. (See [Policy, Virus, and Outbreak Quarantines, on page 899](#)) You can create filters that would simulate mail flow into and out of your policy quarantines so that messages are not released too quickly from the system (that is, the quarantine areas do not fill their allotted disk space too quickly).
  - Because it uses the same settings as the Scan Behavior page or the scanconfig command, the “Entire Message” condition does not scan a message’s headers; choosing the “Entire Message” will scan only the message body and attachments. Use the “Subject” or “Header” conditions to search for specific header information.
  - Configuring users by LDAP query will only appear in the GUI if you have LDAP servers configured on the appliance (that is, you have configured the appliance to query specific LDAP servers with specific strings using the ldapconfig command).
  - Some sections of the content filter rule builder will not appear in the GUI if the resource has not been preconfigured. For example, notification templates and message disclaimers will not appear as options if they have not been configured previously using the Text Resources page or the textconfig command in the CLI.
  - Content filters features will recognize, can contain, and/or scan for text in the following character encodings:
    - Unicode (UTF-8)
    - Unicode (UTF-16)
    - Western European/Latin-1 (ISO 8859-1)
    - Western European/Latin-1 (Windows CP1252)
    - Traditional Chinese (Big 5)
    - Simplified Chinese (GB 2312)
    - Simplified Chinese (HZ GB 2312)
    - Korean (ISO 2022-KR)
    - Korean (KS-C-5601/EUC-KR)
    - Japanese (Shift-JIS (X0123))
    - Japanese (ISO-2022-JP)
    - Japanese (EUC)

You can mix and match multiple character sets within a single content filter. Refer to your web browser’s documentation for help displaying and entering text in multiple character encodings. Most browsers can render multiple character sets simultaneously.

**Figure 99: Multiple Character Sets in a Content Filter**



- On the Incoming or Outgoing Content Filters summary pages, use the links for “Description,” “Rules,” and “Policies” to change the view presented for the content filters:
  - The **Description** view shows the text you entered in the description field for each content filter. (This is the default view.)
  - The **Rules** view shows the rules and regular expressions build by the rule builder page.
  - The **Policies** shows the policies for which each content filter is enabled.





## APPENDIX **D**

# Firewall Information

This chapter contains the following sections:

- [Firewall Information, on page 1289](#)
- [Protecting Email Gateway from Network Attacks, on page 1293](#)

## Firewall Information

The following table lists the possible ports that may need to be opened for proper operation of Cisco Secure Email Gateway (these are the default values).

**Table 166: Firewall Ports**

| Default Port | Protocol | In/Out    | Hostname                | Purpose                                                                                                                                                                                                                    |
|--------------|----------|-----------|-------------------------|----------------------------------------------------------------------------------------------------------------------------------------------------------------------------------------------------------------------------|
| 20/21        | TCP      | In or out | AsyncOS IPs, FTP server | FTP for aggregation of log files.<br>Data ports TCP 1024 and higher must also all be open.<br>For more information, search for FTP port information in the Knowledge Base. See <a href="#">Knowledge Base, on page 8</a> . |
| 22           | TCP      | In        | AsyncOS IPs             | SSH access to the CLI, aggregation of log files.                                                                                                                                                                           |
| 22           | TCP      | Out       | SSH Server              | SSH aggregation of log files.                                                                                                                                                                                              |
| 22           | TCP      | Out       | SCP server              | SCP push to log server.                                                                                                                                                                                                    |
| 25           | TCP      | Out       | Any                     | SMTP to send email.                                                                                                                                                                                                        |
| 25           | TCP      | In        | AsyncOS IPs             | SMTP to receive bounced email or if injecting email from outside firewall.                                                                                                                                                 |

|             |         |          |                               |                                                                                                                        |
|-------------|---------|----------|-------------------------------|------------------------------------------------------------------------------------------------------------------------|
| 53          | UDP/TCP | Out      | DNS servers                   | DNS if configured to use Internet root servers or other DNS servers outside the firewall. Also for SenderBase queries. |
| 80          | HTTP    | In       | AsyncOS IPs                   | HTTP access to the GUI for system monitoring.                                                                          |
| 80          | HTTP    | Out      | downloads.ironport.com        | and McAfee definitions.                                                                                                |
| 80          | HTTP    | Out      | updates.ironport.com          | AsyncOS upgrades and McAfee definitions.                                                                               |
| 80          | HTTP    | Out      | TAXII servers                 | Used to allow your email gateway to consume external threat feeds.                                                     |
| 82          | HTTP    | In       | AsyncOS IPs                   | Used for viewing the spam quarantine.                                                                                  |
| 83          | HTTPS   | In       | AsyncOS IPs                   | Used for viewing the spam quarantine.                                                                                  |
| 110         | TCP     | Out      | POP server                    | POP authentication for end users for spam quarantine.                                                                  |
| 123         | UDP     | In & Out | NTP server                    | NTP if time servers are outside firewall.                                                                              |
| 143         | TCP     | Out      | IMAP server                   | IMAP authentication for end users for spam quarantine.                                                                 |
| 161         | UDP     | In       | AsyncOS IPs                   | SNMP Queries.                                                                                                          |
| 162         | UDP     | Out      | Management station            | SNMP Traps.                                                                                                            |
| 389 or 3268 | LDAP    | Out      | LDAP servers                  | LDAP if LDAP directory servers are outside firewall. LDAP authentication for Cisco Spam Quarantine.                    |
| 636 or 3269 | LDAPS   | Out      | LDAPS                         | LDAPS — ActiveDirectory's global catalog server (uses SSL).                                                            |
| 443         | TCP     | In       | AsyncOS IPs                   | Secure HTTP ( https ) access to the GUI for system monitoring.                                                         |
| 443         | TCP     | Out      | res.cisco.com                 | Verify the latest files for the update server.                                                                         |
| 443         | TCP     | Out      | update-manifests.ironport.com | Obtain the list of the latest files from the update server (for physical hardware email gateways.)                     |



|     |     |          |                                                                                                                                                                                                                                                                                                                                 |                                                                                                                                                          |
|-----|-----|----------|---------------------------------------------------------------------------------------------------------------------------------------------------------------------------------------------------------------------------------------------------------------------------------------------------------------------------------|----------------------------------------------------------------------------------------------------------------------------------------------------------|
| 443 | TCP | Out      | update-manifests.sco.cisco.com                                                                                                                                                                                                                                                                                                  | Obtain the list of the latest files from the update server (for virtual email gateways.)                                                                 |
| 443 | TCP | Out      | serviceconfig.talos.cisco.com<br>grpc.talos.cisco.com<br>email-sender-ip-rep-grpc.talos.cisco.com<br>For IP -based firewall:<br>146.112.62.0/24<br>146.112.63.0/24<br>146.112.255.0/24<br>146.112.59.0/24<br>2a04:e4c7:ffff::/48<br>2a04:e4c7:fffe::/48                                                                         | Cisco Talos Intelligence Services - to obtain IP reputation, URL reputation and category, and to send Service Logs details.                              |
| 443 | TCP | Out      | kinesis.us-west-2.amazonaws.com<br>sensor-provisioner.ep.prod<br>.agari.com<br>houston.sensor.prod.agari.com                                                                                                                                                                                                                    | Register and send header details to Cisco Advanced Phishing Protection cloud service.                                                                    |
| 443 | TCP | Out      | As configured in Security Services > File Reputation and Analysis, Advanced Settings for File Reputation section, Cloud Server Pool parameter.                                                                                                                                                                                  | If configured, the port for access to cloud services for obtaining file reputation. The default port is 32137. For file analysis services, see port 443. |
| 443 | TCP | Out      | As configured in Security Services > File Reputation and Analysis, Advanced Settings for File Analysis section.                                                                                                                                                                                                                 | Access to cloud services for file analysis. For file reputation services, see port 443 or 32137.                                                         |
| 443 | TCP | In & Out | As configured in Security Services > File Reputation and Analysis, Advanced Settings for File Reputation section, AMP for Endpoints Console Integration parameter.<br>api.amp.sourcefire.com<br>api.eu.amp.sourcefire.com<br>api.apjc.amp.sourcefire.com<br>api.amp.cisco.com<br>api.eu.amp.cisco.com<br>api.apjc.amp.cisco.com | Access to AMP for Endpoints console servers.                                                                                                             |

|                 |         |            |                                                      |                                                                                                                                             |
|-----------------|---------|------------|------------------------------------------------------|---------------------------------------------------------------------------------------------------------------------------------------------|
| 443             | TCP     | In & Out   | outlook.office365.com<br>login.microsoftonline.com.  | Access to Office 365 services for mailbox auto remediation.                                                                                 |
| 443             | TCP     | In & Out   | Hostname of the Microsoft On-premise exchange server | Access to Microsoft On-premise exchange servers for remedating messages from the mailbox.                                                   |
| 443             | TCP     | Out        | aggregator.cisco.com                                 | Access to the Cisco Aggregator server.                                                                                                      |
| 443             | HTTPS   | Out        | logapi.ces.cisco.com                                 | To upload the debug logs that are collected by Cisco TAC.                                                                                   |
| 443             | HTTPS   | Out        | TAXII servers                                        | Used to allow your email gateway to consume external threat feeds.                                                                          |
| 443             | HTTPS   | In and Out | api-sse.cisco.com                                    | Used to register your email gateway with Cisco Threat Response.                                                                             |
| 443             | HTTPS   | In and Out | api.eu.sse.itd.cisco.com                             | Used to register your email gateway with Cisco Threat Response.                                                                             |
| 443             | HTTPS   | In and Out | api.apj.sse.itd.cisco.com                            | Used to register your email gateway with Cisco Threat Response.                                                                             |
| 443             | HTTPS   | In and Out | est.sco.cisco.com                                    | Used to download a certificate to verify whether your email gateway is accessing a verified site when registering to Cisco Threat Response. |
| 443             | HTTPS   | In and Out | AsyncOS IPs                                          | HTTPS access to the GUI using <code>trailblazerconfig</code> CLI command.                                                                   |
| 514             | UDP/TCP | Out        | Syslog server                                        | Syslog logging.                                                                                                                             |
| 628             | TCP     | In & In    | AsyncOS IPs                                          | QMQP if injecting email from outside firewall.                                                                                              |
| 990             | TCP/FTP | Out        | support-ftp.cisco.com                                | To upload the debug logs that are collected by Cisco TAC.                                                                                   |
| 1024 and higher | —       | —          | —                                                    | See information above for Port 21 (FTP.)                                                                                                    |
| 2222            | CCS     | In & In    | AsyncOS IPs                                          | Cluster Communication Service (for Centralized Management).                                                                                 |
|                 | TCP     | Out        | AsyncOS IPs                                          | Cisco Spam Quarantine.                                                                                                                      |

|      |       |            |             |                                                                                                                                                                        |
|------|-------|------------|-------------|------------------------------------------------------------------------------------------------------------------------------------------------------------------------|
| 7025 | TCP   | In and out | AsyncOS IPs | Pass policy, virus, and outbreak quarantine data between Cisco Secure Email Gateways and Cisco Secure Manager Email and Web Gateways when this feature is centralized. |
| 6080 | HTTP  | In or Out  | AsyncOS IPs | Access to API ports for HTTP Server                                                                                                                                    |
| 6443 | HTTPS | In or Out  | AsyncOS IPs | Access to API ports for HTTPS Server                                                                                                                                   |

## Protecting Email Gateway from Network Attacks

Make sure that you perform the following prerequisites to protect your email gateway from network attacks:

- Do not expose port 22 (SSH) to your email gateway external IP address.
- Enable only specific IP addresses to manage your email gateway using the web interface and CLI configuration settings.
- [If required] Enable Host Header protection using the `adminaccessconfig` CLI command.
- Enable Cross Scripting protection using the `adminaccessconfig` CLI command.
- Do not configure a Relay rule on a public listener.



---

**Note** If you require a relay rule on an external listener, configure ‘SMTP AUTH’ on a normal public listener.

---





## APPENDIX **E**

# End User License Agreement

---

This appendix contains the following sections:

- [Cisco Systems End User License Agreement](#) , on page 1295
- [Supplemental End User License Agreement for Cisco Systems Content Security Software](#) , on page 1301

## Cisco Systems End User License Agreement

**IMPORTANT: PLEASE READ THIS END USER LICENSE AGREEMENT CAREFULLY. IT IS VERY IMPORTANT THAT YOU CHECK THAT YOU ARE PURCHASING CISCO SOFTWARE OR EQUIPMENT FROM AN APPROVED SOURCE AND THAT YOU, OR THE ENTITY YOU REPRESENT (COLLECTIVELY, THE "CUSTOMER") HAVE BEEN REGISTERED AS THE END USER FOR THE PURPOSES OF THIS CISCO END USER LICENSE AGREEMENT. IF YOU ARE NOT REGISTERED AS THE END USER YOU HAVE NO LICENSE TO USE THE SOFTWARE AND THE LIMITED WARRANTY IN THIS END USER LICENSE AGREEMENT DOES NOT APPLY. ASSUMING YOU HAVE PURCHASED FROM AN APPROVED SOURCE, DOWNLOADING, INSTALLING OR USING CISCO OR CISCO-SUPPLIED SOFTWARE CONSTITUTES ACCEPTANCE OF THIS AGREEMENT.**

CISCO SYSTEMS, INC. OR ITS SUBSIDIARY LICENSING THE SOFTWARE INSTEAD OF CISCO SYSTEMS, INC. ("CISCO") IS WILLING TO LICENSE THIS SOFTWARE TO YOU ONLY UPON THE CONDITION THAT YOU PURCHASED THE SOFTWARE FROM AN APPROVED SOURCE AND THAT YOU ACCEPT ALL OF THE TERMS CONTAINED IN THIS END USER LICENSE AGREEMENT PLUS ANY ADDITIONAL LIMITATIONS ON THE LICENSE SET FORTH IN A SUPPLEMENTAL LICENSE AGREEMENT ACCOMPANYING THE PRODUCT OR AVAILABLE AT THE TIME OF YOUR ORDER (COLLECTIVELY THE "AGREEMENT"). TO THE EXTENT OF ANY CONFLICT BETWEEN THE TERMS OF THIS END USER LICENSE AGREEMENT AND ANY SUPPLEMENTAL LICENSE AGREEMENT, THE SUPPLEMENTAL LICENSE AGREEMENT SHALL APPLY. BY DOWNLOADING, INSTALLING, OR USING THE SOFTWARE, YOU ARE REPRESENTING THAT YOU PURCHASED THE SOFTWARE FROM AN APPROVED SOURCE AND BINDING YOURSELF TO THE AGREEMENT. IF YOU DO NOT AGREE TO ALL OF THE TERMS OF THE AGREEMENT, THEN CISCO IS UNWILLING TO LICENSE THE SOFTWARE TO YOU AND (A) YOU MAY NOT DOWNLOAD, INSTALL OR USE THE SOFTWARE, AND (B) YOU MAY RETURN THE SOFTWARE (INCLUDING ANY UNOPENED CD PACKAGE AND ANY WRITTEN MATERIALS) FOR A FULL REFUND, OR, IF THE SOFTWARE AND WRITTEN MATERIALS ARE SUPPLIED AS PART OF ANOTHER PRODUCT, YOU MAY RETURN THE ENTIRE PRODUCT FOR A FULL REFUND. YOUR RIGHT TO RETURN AND REFUND EXPIRES 30 DAYS AFTER PURCHASE FROM AN APPROVED SOURCE, AND APPLIES ONLY IF YOU ARE THE ORIGINAL AND REGISTERED END USER

PURCHASER. FOR THE PURPOSES OF THIS END USER LICENSE AGREEMENT, AN "APPROVED SOURCE" MEANS (A) CISCO; OR (B) A DISTRIBUTOR OR SYSTEMS INTEGRATOR AUTHORIZED BY CISCO TO DISTRIBUTE / SELL CISCO EQUIPMENT, SOFTWARE AND SERVICES WITHIN YOUR TERRITORY TO END USERS; OR (C) A RESELLER AUTHORIZED BY ANY SUCH DISTRIBUTOR OR SYSTEMS INTEGRATOR IN ACCORDANCE WITH THE TERMS OF THE DISTRIBUTOR'S AGREEMENT WITH CISCO TO DISTRIBUTE / SELL THE CISCO EQUIPMENT, SOFTWARE AND SERVICES WITHIN YOUR TERRITORY TO END USERS.

*THE FOLLOWING TERMS OF THE AGREEMENT GOVERN CUSTOMER'S USE OF THE SOFTWARE (DEFINED BELOW), EXCEPT TO THE EXTENT: (A) THERE IS A SEPARATE SIGNED CONTRACT BETWEEN CUSTOMER AND CISCO GOVERNING CUSTOMER'S USE OF THE SOFTWARE, OR (B) THE SOFTWARE INCLUDES A SEPARATE "CLICK-ACCEPT" LICENSE AGREEMENT OR THIRD PARTY LICENSE AGREEMENT AS PART OF THE INSTALLATION OR DOWNLOAD PROCESS GOVERNING CUSTOMER'S USE OF THE SOFTWARE. TO THE EXTENT OF A CONFLICT BETWEEN THE PROVISIONS OF THE FOREGOING DOCUMENTS, THE ORDER OF PRECEDENCE SHALL BE (1) THE SIGNED CONTRACT, (2) THE CLICK-ACCEPT AGREEMENT OR THIRD PARTY LICENSE AGREEMENT, AND (3) THE AGREEMENT. FOR PURPOSES OF THE AGREEMENT, "SOFTWARE" SHALL MEAN COMPUTER PROGRAMS, INCLUDING FIRMWARE AND COMPUTER PROGRAMS EMBEDDED IN CISCO EQUIPMENT, AS PROVIDED TO CUSTOMER BY AN APPROVED SOURCE, AND ANY UPGRADES, UPDATES, BUG FIXES OR MODIFIED VERSIONS THERETO (COLLECTIVELY, "UPGRADES"), ANY OF THE SAME WHICH HAS BEEN RELICENSED UNDER THE CISCO SOFTWARE TRANSFER AND RE-LICENSING POLICY (AS MAY BE AMENDED BY CISCO FROM TIME TO TIME) OR BACKUP COPIES OF ANY OF THE FOREGOING.*

**License.** Conditioned upon compliance with the terms and conditions of the Agreement, Cisco grants to Customer a nonexclusive and nontransferable license to use for Customer's internal business purposes the Software and the Documentation for which Customer has paid the required license fees to an Approved Source. "Documentation" means written information (whether contained in user or technical manuals, training materials, specifications or otherwise) pertaining to the Software and made available by an Approved Source with the Software in any manner (including on CD-Rom, or on-line). In order to use the Software, Customer may be required to input a registration number or product authorization key and register Customer's copy of the Software online at Cisco's website to obtain the necessary license key or license file.

Customer's license to use the Software shall be limited to, and Customer shall not use the Software in excess of, a single hardware chassis or card or such other limitations as are set forth in the applicable Supplemental License Agreement or in the applicable purchase order which has been accepted by an Approved Source and for which Customer has paid to an Approved Source the required license fee (the "Purchase Order").

Unless otherwise expressly provided in the Documentation or any applicable Supplemental License Agreement, Customer shall use the Software solely as embedded in, for execution on, or (where the applicable Documentation permits installation on non-Cisco equipment) for communication with Cisco equipment owned or leased by Customer and used for Customer's internal business purposes. No other licenses are granted by implication, estoppel or otherwise.

For evaluation or beta copies for which Cisco does not charge a license fee, the above requirement to pay license fees does not apply.

*General Limitations.* This is a license, not a transfer of title, to the Software and Documentation, and Cisco retains ownership of all copies of the Software and Documentation. Customer acknowledges that the Software and Documentation contain trade secrets of Cisco or its suppliers or licensors, including but not limited to the specific internal design and structure of individual programs and associated interface information. Except as otherwise expressly provided under the Agreement, Customer shall only use the Software in connection with the use of Cisco equipment purchased by the Customer from an Approved Source and Customer shall have no right, and Customer specifically agrees not to:

- (i) transfer, assign or sublicense its license rights to any other person or entity (other than in compliance with any Cisco relicensing/transfer policy then in force), or use the Software on Cisco equipment not purchased by the Customer from an Approved Source or on secondhand Cisco equipment, and Customer acknowledges that any attempted transfer, assignment, sublicense or use shall be void;
- (ii) make error corrections to or otherwise modify or adapt the Software or create derivative works based upon the Software, or permit third parties to do the same;
- (iii) reverse engineer or decompile, decrypt, disassemble or otherwise reduce the Software to human-readable form, except to the extent otherwise expressly permitted under applicable law notwithstanding this restriction or except to the extent that Cisco is legally required to permit such specific activity pursuant to any applicable open source license;
- (iv) publish any results of benchmark tests run on the Software;
- (v) use or permit the Software to be used to perform services for third parties, whether on a service bureau or time sharing basis or otherwise, without the express written authorization of Cisco; or
- (vi) disclose, provide, or otherwise make available trade secrets contained within the Software and Documentation in any form to any third party without the prior written consent of Cisco. Customer shall implement reasonable security measures to protect such trade secrets.

To the extent required by applicable law, and at Customer's written request, Cisco shall provide Customer with the interface information needed to achieve interoperability between the Software and another independently created program, on payment of Cisco's applicable fee, if any. Customer shall observe strict obligations of confidentiality with respect to such information and shall use such information in compliance with any applicable terms and conditions upon which Cisco makes such information available.

**Software, Upgrades and Additional Copies.** NOTWITHSTANDING ANY OTHER PROVISION OF THE AGREEMENT: (1) CUSTOMER HAS NO LICENSE OR RIGHT TO MAKE OR USE ANY ADDITIONAL COPIES OR UPGRADES UNLESS CUSTOMER, AT THE TIME OF MAKING OR ACQUIRING SUCH COPY OR UPGRADE, ALREADY HOLDS A VALID LICENSE TO THE ORIGINAL SOFTWARE AND HAS PAID THE APPLICABLE FEE TO AN APPROVED SOURCE FOR THE UPGRADE OR ADDITIONAL COPIES; (2) USE OF UPGRADES IS LIMITED TO CISCO EQUIPMENT SUPPLIED BY AN APPROVED SOURCE FOR WHICH CUSTOMER IS THE ORIGINAL END USER PURCHASER OR LESSEE OR OTHERWISE HOLDS A VALID LICENSE TO USE THE SOFTWARE WHICH IS BEING UPGRADED; AND (3) THE MAKING AND USE OF ADDITIONAL COPIES IS LIMITED TO NECESSARY BACKUP PURPOSES ONLY.

*Proprietary Notices.* Customer agrees to maintain and reproduce all copyright, proprietary, and other notices on all copies, in any form, of the Software in the same form and manner that such copyright and other proprietary notices are included on the Software. Except as expressly authorized in the Agreement, Customer shall not make any copies or duplicates of any Software without the prior written permission of Cisco.

*Term and Termination.* The Agreement and the license granted herein shall remain effective until terminated. Customer may terminate the Agreement and the license at any time by destroying all copies of Software and any Documentation. Customer's rights under the Agreement will terminate immediately without notice from Cisco if Customer fails to comply with any provision of the Agreement. Upon termination, Customer shall destroy all copies of Software and Documentation in its possession or control. All confidentiality obligations of Customer, all restrictions and limitations imposed on the Customer under the section titled "General Limitations" and all limitations of liability and disclaimers and restrictions of warranty shall survive termination of this Agreement. In addition, the provisions of the sections titled "U.S. Government End User Purchasers" and "General Terms Applicable to the Limited Warranty Statement and End User License Agreement" shall survive termination of the Agreement.

*Customer Records.* Customer grants to Cisco and its independent accountants the right to examine Customer's books, records and accounts during Customer's normal business hours to verify compliance with this Agreement. In the event such audit discloses non-compliance with this Agreement, Customer shall promptly pay to Cisco the appropriate license fees, plus the reasonable cost of conducting the audit.

*Export, Re-Export, Transfer and Use Controls.* The Software, Documentation and technology or direct products thereof (hereafter referred to as Software and Technology), supplied by Cisco under the Agreement are subject to export controls under the laws and regulations of the United States (U.S.) and any other applicable countries' laws and regulations. Customer shall comply with such laws and regulations governing export, re-export, transfer and use of Cisco Software and Technology and will obtain all required U.S. and local authorizations, permits, or licenses. Cisco and Customer each agree to provide the other information, support documents, and assistance as may reasonably be required by the other in connection with securing authorizations or licenses. Information regarding compliance with export, re-export, transfer and use may be located at the following URL:

[https://www.cisco.com/web/about/doing\\_business/legal/global\\_export\\_trade/general\\_export/contract\\_compliance.html](https://www.cisco.com/web/about/doing_business/legal/global_export_trade/general_export/contract_compliance.html)

*U.S. Government End User Purchasers.* The Software and Documentation qualify as "commercial items," as that term is defined at Federal Acquisition Regulation ("FAR") (48 C.F.R.) 2.101, consisting of "commercial computer software" and "commercial computer software documentation" as such terms are used in FAR 12.212. Consistent with FAR 12.212 and DoD FAR Supp. 227.7202-1 through 227.7202-4, and notwithstanding any other FAR or other contractual clause to the contrary in any agreement into which the Agreement may be incorporated, Customer may provide to Government end user or, if the Agreement is direct, Government end user will acquire, the Software and Documentation with only those rights set forth in the Agreement. Use of either the Software or Documentation or both constitutes agreement by the Government that the Software and Documentation are "commercial computer software" and "commercial computer software documentation," and constitutes acceptance of the rights and restrictions herein.

*Identified Components; Additional Terms.* The Software may contain or be delivered with one or more components, which may include third-party components, identified by Cisco in the Documentation, readme.txt file, third-party click-accept or elsewhere (e.g. on <https://www.cisco.com/>) (the "Identified Component(s)") as being subject to different license agreement terms, disclaimers of warranties, limited warranties or other terms and conditions (collectively, "Additional Terms") than those set forth herein. You agree to the applicable Additional Terms for any such Identified Component(s)."

### **Limited Warranty**

Subject to the limitations and conditions set forth herein, Cisco warrants that commencing from the date of shipment to Customer (but in case of resale by an Approved Source other than Cisco, commencing not more than ninety (90) days after original shipment by Cisco), and continuing for a period of the longer of (a) ninety (90) days or (b) the warranty period (if any) expressly set forth as applicable specifically to software in the warranty card accompanying the product of which the Software is a part (the "Product") (if any): (a) the media on which the Software is furnished will be free of defects in materials and workmanship under normal use; and (b) the Software substantially conforms to the Documentation. The date of shipment of a Product by Cisco is set forth on the packaging material in which the Product is shipped. Except for the foregoing, the Software is provided "AS IS". This limited warranty extends only to the Software purchased from an Approved Source by a Customer who is the first registered end user. Customer's sole and exclusive remedy and the entire liability of Cisco and its suppliers under this limited warranty will be (i) replacement of defective media and/or (ii) at Cisco's option, repair, replacement, or refund of the purchase price of the Software, in both cases subject to the condition that any error or defect constituting a breach of this limited warranty is reported to the Approved Source supplying the Software to Customer, within the warranty period. Cisco or the Approved Source supplying the Software to Customer may, at its option, require return of the Software and/or Documentation as a condition to the remedy. In no event does Cisco warrant that the Software is error free or that Customer



will be able to operate the Software without problems or interruptions. In addition, due to the continual development of new techniques for intruding upon and attacking networks, Cisco does not warrant that the Software or any equipment, system or network on which the Software is used will be free of vulnerability to intrusion or attack.

*Restrictions.* This warranty does not apply if the Software, Product or any other equipment upon which the Software is authorized to be used (a) has been altered, except by Cisco or its authorized representative, (b) has not been installed, operated, repaired, or maintained in accordance with instructions supplied by Cisco, (c) has been subjected to abnormal physical or electrical stress, abnormal environmental conditions, misuse, negligence, or accident; or (d) is licensed for beta, evaluation, testing or demonstration purposes. The Software warranty also does not apply to (e) any temporary Software modules; (f) any Software not posted on Cisco's Software Center; (g) any Software that Cisco expressly provides on an "AS IS" basis on Cisco's Software Center; (h) any Software for which an Approved Source does not receive a license fee; and (i) Software supplied by any third party which is not an Approved Source.

### **DISCLAIMER OF WARRANTY**

**EXCEPT AS SPECIFIED IN THIS WARRANTY SECTION, ALL EXPRESS OR IMPLIED CONDITIONS, REPRESENTATIONS, AND WARRANTIES INCLUDING, WITHOUT LIMITATION, ANY IMPLIED WARRANTY OR CONDITION OF MERCHANTABILITY, FITNESS FOR A PARTICULAR PURPOSE, NON-INFRINGEMENT, SATISFACTORY QUALITY, NON-INTERFERENCE, ACCURACY OF INFORMATIONAL CONTENT, OR ARISING FROM A COURSE OF DEALING, LAW, USAGE, OR TRADE PRACTICE, ARE HEREBY EXCLUDED TO THE EXTENT ALLOWED BY APPLICABLE LAW AND ARE EXPRESSLY DISCLAIMED BY CISCO, ITS SUPPLIERS AND LICENSORS. TO THE EXTENT THAT ANY OF THE SAME CANNOT BE EXCLUDED, SUCH IMPLIED CONDITION, REPRESENTATION AND/OR WARRANTY IS LIMITED IN DURATION TO THE EXPRESS WARRANTY PERIOD REFERRED TO IN THE "LIMITED WARRANTY" SECTION ABOVE. BECAUSE SOME STATES OR JURISDICTIONS DO NOT ALLOW LIMITATIONS ON HOW LONG AN IMPLIED WARRANTY LASTS, THE ABOVE LIMITATION MAY NOT APPLY IN SUCH STATES. THIS WARRANTY GIVES CUSTOMER SPECIFIC LEGAL RIGHTS, AND CUSTOMER MAY ALSO HAVE OTHER RIGHTS WHICH VARY FROM JURISDICTION TO JURISDICTION.** This disclaimer and exclusion shall apply even if the express warranty set forth above fails of its essential purpose.

*Disclaimer of Liabilities - Limitation of Liability.* IF YOU ACQUIRED THE SOFTWARE IN THE UNITED STATES, LATIN AMERICA, CANADA, JAPAN OR THE CARIBBEAN, NOTWITHSTANDING ANYTHING ELSE IN THE AGREEMENT TO THE CONTRARY, ALL LIABILITY OF CISCO, ITS AFFILIATES, OFFICERS, DIRECTORS, EMPLOYEES, AGENTS, SUPPLIERS AND LICENSORS COLLECTIVELY, TO CUSTOMER, WHETHER IN CONTRACT, TORT (INCLUDING NEGLIGENCE), BREACH OF WARRANTY OR OTHERWISE, SHALL NOT EXCEED THE PRICE PAID BY CUSTOMER TO ANY APPROVED SOURCE FOR THE SOFTWARE THAT GAVE RISE TO THE CLAIM OR IF THE SOFTWARE IS PART OF ANOTHER PRODUCT, THE PRICE PAID FOR SUCH OTHER PRODUCT. THIS LIMITATION OF LIABILITY FOR SOFTWARE IS CUMULATIVE AND NOT PER INCIDENT (I.E. THE EXISTENCE OF TWO OR MORE CLAIMS WILL NOT ENLARGE THIS LIMIT).

IF YOU ACQUIRED THE SOFTWARE IN EUROPE, THE MIDDLE EAST, AFRICA, ASIA OR OCEANIA, NOTWITHSTANDING ANYTHING ELSE IN THE AGREEMENT TO THE CONTRARY, ALL LIABILITY OF CISCO, ITS AFFILIATES, OFFICERS, DIRECTORS, EMPLOYEES, AGENTS, SUPPLIERS AND LICENSORS COLLECTIVELY, TO CUSTOMER, WHETHER IN CONTRACT, TORT (INCLUDING NEGLIGENCE), BREACH OF WARRANTY OR OTHERWISE, SHALL NOT EXCEED THE PRICE PAID BY CUSTOMER TO CISCO FOR THE SOFTWARE THAT GAVE RISE TO THE CLAIM OR IF THE SOFTWARE IS PART OF ANOTHER PRODUCT, THE PRICE PAID FOR SUCH OTHER PRODUCT. THIS LIMITATION OF LIABILITY FOR SOFTWARE IS CUMULATIVE AND NOT PER INCIDENT

(I.E. THE EXISTENCE OF TWO OR MORE CLAIMS WILL NOT ENLARGE THIS LIMIT). NOTHING IN THE AGREEMENT SHALL LIMIT (I) THE LIABILITY OF CISCO, ITS AFFILIATES, OFFICERS, DIRECTORS, EMPLOYEES, AGENTS, SUPPLIERS AND LICENSORS TO CUSTOMER FOR PERSONAL INJURY OR DEATH CAUSED BY THEIR NEGLIGENCE, (II) CISCO'S LIABILITY FOR FRAUDULENT MISREPRESENTATION, OR (III) ANY LIABILITY OF CISCO WHICH CANNOT BE EXCLUDED UNDER APPLICABLE LAW.

*Disclaimer of Liabilities - Waiver of Consequential Damages and Other Losses.* IF YOU ACQUIRED THE SOFTWARE IN THE UNITED STATES, LATIN AMERICA, THE CARIBBEAN OR CANADA, REGARDLESS OF WHETHER ANY REMEDY SET FORTH HEREIN FAILS OF ITS ESSENTIAL PURPOSE OR OTHERWISE, IN NO EVENT WILL CISCO OR ITS SUPPLIERS BE LIABLE FOR ANY LOST REVENUE, PROFIT, OR LOST OR DAMAGED DATA, BUSINESS INTERRUPTION, LOSS OF CAPITAL, OR FOR SPECIAL, INDIRECT, CONSEQUENTIAL, INCIDENTAL, OR PUNITIVE DAMAGES HOWEVER CAUSED AND REGARDLESS OF THE THEORY OF LIABILITY OR WHETHER ARISING OUT OF THE USE OF OR INABILITY TO USE SOFTWARE OR OTHERWISE AND EVEN IF CISCO OR ITS SUPPLIERS OR LICENSORS HAVE BEEN ADVISED OF THE POSSIBILITY OF SUCH DAMAGES. BECAUSE SOME STATES OR JURISDICTIONS DO NOT ALLOW LIMITATION OR EXCLUSION OF CONSEQUENTIAL OR INCIDENTAL DAMAGES, THE ABOVE LIMITATION MAY NOT APPLY TO YOU.

IF YOU ACQUIRED THE SOFTWARE IN JAPAN, EXCEPT FOR LIABILITY ARISING OUT OF OR IN CONNECTION WITH DEATH OR PERSONAL INJURY, FRAUDULENT MISREPRESENTATION, AND REGARDLESS OF WHETHER ANY REMEDY SET FORTH HEREIN FAILS OF ITS ESSENTIAL PURPOSE OR OTHERWISE, IN NO EVENT WILL CISCO, ITS AFFILIATES, OFFICERS, DIRECTORS, EMPLOYEES, AGENTS, SUPPLIERS AND LICENSORS BE LIABLE FOR ANY LOST REVENUE, PROFIT, OR LOST OR DAMAGED DATA, BUSINESS INTERRUPTION, LOSS OF CAPITAL, OR FOR SPECIAL, INDIRECT, CONSEQUENTIAL, INCIDENTAL, OR PUNITIVE DAMAGES HOWEVER CAUSED AND REGARDLESS OF THE THEORY OF LIABILITY OR WHETHER ARISING OUT OF THE USE OF OR INABILITY TO USE SOFTWARE OR OTHERWISE AND EVEN IF CISCO OR ANY APPROVED SOURCE OR THEIR SUPPLIERS OR LICENSORS HAVE BEEN ADVISED OF THE POSSIBILITY OF SUCH DAMAGES.

IF YOU ACQUIRED THE SOFTWARE IN EUROPE, THE MIDDLE EAST, AFRICA, ASIA OR OCEANIA, IN NO EVENT WILL CISCO, ITS AFFILIATES, OFFICERS, DIRECTORS, EMPLOYEES, AGENTS, SUPPLIERS AND LICENSORS, BE LIABLE FOR ANY LOST REVENUE, LOST PROFIT, OR LOST OR DAMAGED DATA, BUSINESS INTERRUPTION, LOSS OF CAPITAL, OR FOR SPECIAL, INDIRECT, CONSEQUENTIAL, INCIDENTAL, OR PUNITIVE DAMAGES, HOWSOEVER ARISING, INCLUDING, WITHOUT LIMITATION, IN CONTRACT, TORT (INCLUDING NEGLIGENCE) OR WHETHER ARISING OUT OF THE USE OF OR INABILITY TO USE THE SOFTWARE, EVEN IF, IN EACH CASE, CISCO, ITS AFFILIATES, OFFICERS, DIRECTORS, EMPLOYEES, AGENTS, SUPPLIERS AND LICENSORS, HAVE BEEN ADVISED OF THE POSSIBILITY OF SUCH DAMAGES. BECAUSE SOME STATES OR JURISDICTIONS DO NOT ALLOW LIMITATION OR EXCLUSION OF CONSEQUENTIAL OR INCIDENTAL DAMAGES, THE ABOVE LIMITATION MAY NOT FULLY APPLY TO YOU. THE FOREGOING EXCLUSION SHALL NOT APPLY TO ANY LIABILITY ARISING OUT OF OR IN CONNECTION WITH: (I) DEATH OR PERSONAL INJURY, (II) FRAUDULENT MISREPRESENTATION, OR (III) CISCO'S LIABILITY IN CONNECTION WITH ANY TERMS THAT CANNOT BE EXCLUDED UNDER APPLICABLE LAW.

Customer acknowledges and agrees that Cisco has set its prices and entered into the Agreement in reliance upon the disclaimers of warranty and the limitations of liability set forth herein, that the same reflect an allocation of risk between the parties (including the risk that a contract remedy may fail of its essential purpose and cause consequential loss), and that the same form an essential basis of the bargain between the parties.

*Controlling Law, Jurisdiction.* If you acquired, by reference to the address on the purchase order accepted by the Approved Source, the Software in the United States, Latin America, or the Caribbean, the Agreement and warranties ("Warranties") are controlled by and construed under the laws of the State of California, United States of America, notwithstanding any conflicts of law provisions; and the state and federal courts of California shall have exclusive jurisdiction over any claim arising under the Agreement or Warranties. If you acquired the Software in Canada, unless expressly prohibited by local law, the Agreement and Warranties are controlled by and construed under the laws of the Province of Ontario, Canada, notwithstanding any conflicts of law provisions; and the courts of the Province of Ontario shall have exclusive jurisdiction over any claim arising under the Agreement or Warranties. If you acquired the Software in Europe, the Middle East, Africa, Asia or Oceania (excluding Australia), unless expressly prohibited by local law, the Agreement and Warranties are controlled by and construed under the laws of England, notwithstanding any conflicts of law provisions; and the English courts shall have exclusive jurisdiction over any claim arising under the Agreement or Warranties. In addition, if the Agreement is controlled by the laws of England, no person who is not a party to the Agreement shall be entitled to enforce or take the benefit of any of its terms under the Contracts (Rights of Third Parties) Act 1999. If you acquired the Software in Japan, unless expressly prohibited by local law, the Agreement and Warranties are controlled by and construed under the laws of Japan, notwithstanding any conflicts of law provisions; and the Tokyo District Court of Japan shall have exclusive jurisdiction over any claim arising under the Agreement or Warranties. If you acquired the Software in Australia, unless expressly prohibited by local law, the Agreement and Warranties are controlled by and construed under the laws of the State of New South Wales, Australia, notwithstanding any conflicts of law provisions; and the State and federal courts of New South Wales shall have exclusive jurisdiction over any claim arising under the Agreement or Warranties. If you acquired the Software in any other country, unless expressly prohibited by local law, the Agreement and Warranties are controlled by and construed under the laws of the State of California, United States of America, notwithstanding any conflicts of law provisions; and the state and federal courts of California shall have exclusive jurisdiction over any claim arising under the Agreement or Warranties.

For all countries referred to above, the parties specifically disclaim the application of the UN Convention on Contracts for the International Sale of Goods. Notwithstanding the foregoing, either party may seek interim injunctive relief in any court of appropriate jurisdiction with respect to any alleged breach of such party's intellectual property or proprietary rights. If any portion hereof is found to be void or unenforceable, the remaining provisions of the Agreement and Warranties shall remain in full force and effect. Except as expressly provided herein, the Agreement constitutes the entire agreement between the parties with respect to the license of the Software and Documentation and supersedes any conflicting or additional terms contained in any Purchase Order or elsewhere, all of which terms are excluded. The Agreement has been written in the English language, and the parties agree that the English version will govern.

Product warranty terms and other information applicable to Cisco products are available at the following URL:

<http://www.cisco.com/go/warranty>

## Supplemental End User License Agreement for Cisco Systems Content Security Software

IMPORTANT: READ CAREFULLY

This Supplemental End User License Agreement ("SEULA") contains additional terms and conditions for the Software product licensed under the End User License Agreement ("EULA") between You ("You" as used herein means You and the business entity you represent or "Company") and Cisco (collectively, the "Agreement"). Capitalized terms used in this SEULA but not defined will have the meanings assigned to them

in the EULA. To the extent that there is a conflict between the terms and conditions of the EULA and this SEULA, the terms and conditions of this SEULA will take precedence.

In addition to the limitations set forth in the EULA on your access and use of the Software, you agree to comply at all times with the terms and conditions provided in this SEULA.

DOWNLOADING, INSTALLING, OR USING THE SOFTWARE CONSTITUTES ACCEPTANCE OF THE AGREEMENT, AND YOU ARE BINDING YOURSELF AND THE BUSINESS ENTITY THAT YOU REPRESENT TO THE AGREEMENT. IF YOU DO NOT AGREE TO ALL OF THE TERMS OF THE AGREEMENT, THEN CISCO IS UNWILLING TO LICENSE THE SOFTWARE TO YOU AND (A) YOU MAY NOT DOWNLOAD, INSTALL OR USE THE SOFTWARE, AND (B) YOU MAY RETURN THE SOFTWARE (INCLUDING ANY UNOPENED CD PACKAGE AND ANY WRITTEN MATERIALS) FOR A FULL REFUND, OR, IF THE SOFTWARE AND WRITTEN MATERIALS ARE SUPPLIED AS PART OF ANOTHER PRODUCT, YOU MAY RETURN THE ENTIRE PRODUCT FOR A FULL REFUND. YOUR RIGHT TO RETURN AND REFUND EXPIRES 30 DAYS AFTER PURCHASE FROM CISCO OR AN AUTHORIZED CISCO RESELLER, AND APPLIES ONLY IF YOU ARE THE ORIGINAL END USER PURCHASER.

For purposes of this SEULA, the Product name and the Product description You have ordered is any of the following Cisco Systems Email Security Appliance ("ESA"), Cisco Systems Web Security Appliance ("WSA") and Cisco Systems Security Management Application ("SMA") (collectively, "Content Security") and their Virtual Appliance equivalent ("Software"):

Cisco AsyncOS for Email

Cisco AsyncOS for Web

Cisco AsyncOS for Management

Cisco Email Anti-Spam, Sophos Anti-Virus

Cisco Email Outbreak Filters

Cisco Image Analyzer

McAfee Anti-Virus

Cisco Intelligent Multi-Scan

Cisco Data Loss Prevention

Cisco Email Encryption

Cisco Email Delivery Mode

Cisco Web Usage Controls

Cisco Web Reputation

Sophos Anti-Malware

Webroot Anti-Malware

McAfee Anti-Malware

Cisco Email Reporting

Cisco Email Message Tracking

Cisco Email Centralized Quarantine

Cisco Web Reporting

Cisco Web Policy and Configuration Management  
Cisco Advanced Web Security Management with Splunk  
Email Encryption for Encryption Appliances  
Email Encryption for System Generated Bulk Email  
Email Encryption and Public Key Encryption for Encryption Appliances  
Large Attachment Handling for Encryption Appliances  
Secure Mailbox License for Encryption Appliances

## Definitions

For purposes of this SEULA, the following definitions apply:

"Company Service" means the Company's email, Internet, security management services provided to End Users for the purposes of conducting Company's internal business.

"End User" means: (1) for the WSA and SMA, the employee, contractor or other agent authorized by Company to access the Internet and the SMA via the Company Service; and (2) for the ESA, the email boxes of the employees, contractors, or other agent authorized by Company to access or use the email services via the Company Service.

"Ordering Document" means the purchase agreement, evaluation agreement, beta, pre-release agreement or similar agreement between the Company and Cisco or the Company and a Cisco reseller, or the valid terms of any purchase order accepted by Cisco in connection therewith, containing the purchase terms for the Software license granted by this Agreement.

"Personally Identifiable Information" means any information that can be used to identify an individual, including, but not limited to, an individual's name, user name, email address and any other personally identifiable information.

"Server" means a single physical computer or devices on a network that manages or provides network resources for multiple users.

"Services" means Cisco Software Subscription Services.

"Service Description" means the description of the Software Subscription Support Services at <https://www.cisco.com/c/en/us/about/legal/service-descriptions.html>

"Telemetry Data" means samples of Company's email and web traffic, including data on email message and web request attributes and information on how different types of email messages and web requests were handled by Company's Cisco hardware products. Email message metadata and web requests included in Telemetry Data are anonymized and obfuscated to remove any Personally Identifiable Information.

"Term" means the length of the Software subscription You purchased, as indicated in your Ordering Document.

"Virtual Appliance" means the virtual version of Cisco's email security appliances, web security appliances, and security management appliances.

"Virtual Machine" means a software container that can run its own operating system and execute applications like a Server.

## Additional License Terms and Conditions

### LICENSE GRANTS AND CONSENT TO TERMS OF DATA COLLECTION

#### License of Software.

By using the Software and the Documentation, Company agrees to be bound by the terms of this Agreement, and so long as Company is in compliance with this Agreement, Cisco hereby grants to Company a nonexclusive, non-sublicensable, non-transferable, worldwide license during the Term to use the Software only on Cisco's hardware products, or in the case of the Virtual Appliances, on a Virtual Machine, solely in connection with the provision of the Company Service to End Users. The number of End Users licensed for the use of the Software is limited to the number of End Users specified in the Ordering Documents. In the event that the number of End Users in connection with the provision of the Company Service exceeds the number of End Users specified in the Ordering Documents, Company shall contact an Approved Source to purchase additional licenses for the Software. The duration and scope of this license(s) is further defined in the Ordering Document. The Ordering Document supersedes the EULA with respect to the term of the Software license. Except for the license rights granted herein, no right, title or interest in any Software is granted to the Company by Cisco, Cisco's resellers or their respective licensors. Your entitlement to Upgrades to the Software is subject to the Service Description. This Agreement and the Services are co-terminus.

**Consent and License to Use Data.**

Subject to the Cisco Privacy Statement at <https://www.cisco.com/c/en/us/about/legal/privacy.html>, Company hereby consents and grants to Cisco a license to collect and use Telemetry Data from the Company. Cisco does not collect or use Personally Identifiable Information in the Telemetry Data. Cisco may share aggregated and anonymous Telemetry Data with third parties to assist us in improving your user experience and the Software and other Cisco security products and services. Company may terminate Cisco's right to collect Telemetry Data at any time by disabling Service Logs in the Software. Instructions to enable or disable Service Logs are available in the Software configuration guide.

**Description of Other Rights and Obligations**

Please refer to the Cisco Systems, Inc. End User License Agreement, Privacy Statement and Service Description of Software Subscription Support Services.



## INDEX

< [70](#), [1070](#), [1073](#), [1074](#), [1075](#), [1077](#), [1078](#), [1079](#), [1080](#), [1082](#), [1083](#), [1084](#),  
[1085](#), [1086](#)

\$EnvelopeSender variable [119](#)  
\$TRUSTED mail flow policy [352](#)

### A

accepting email [94](#)  
access privileges for custom user roles [959](#)  
Active Directory Wizard [40](#)  
Adaptive Scanning [413](#)  
address rewriting [676](#)  
address tagging key [719](#)  
    purging [719](#)  
Advanced Malware Protection [457](#)  
alert messages [34](#), [54](#)  
alert settings [34](#), [54](#)  
alertlisting [1024](#)  
alerts [413](#), [1021](#)  
    enabling for Outbreak Filters [413](#)  
    severities [1021](#)  
ALL entry [94](#), [95](#), [126](#)  
    in HAT [94](#), [95](#)  
    in RAT [126](#)  
ALLOWED\_LIST sender group [352](#)  
alternate address [341](#)  
always rule [408](#)  
AMP Archive [1113](#)  
AMP Engine Logs [1113](#)  
AMP. See Advanced Malware Protection. [457](#)  
anti-spam [81](#), [342](#), [361](#), [381](#), [382](#), [383](#), [399](#)  
    HAT parameter [81](#)  
    IronPort Anti-Spam [361](#)  
    reporting false positives and negatives [383](#)  
    scanning appliance-generated messages [382](#)  
    selecting a default scanning engine [381](#)  
    testing [399](#)  
    using multiple scanning engines [342](#)  
Anti-Spam Archive Logs [1113](#)  
Anti-spam logs [1113](#)  
anti-virus [348](#), [349](#), [350](#), [351](#), [352](#), [637](#)  
    actions [349](#)  
    add custom header [351](#)  
    advanced options [349](#)  
    archive original message [350](#)

anti-virus (*continued*)

    dropping attachments [348](#)  
    Encrypted [348](#), [349](#)  
    modify message recipient [351](#)  
    modify message subject [350](#)  
    scan and repair [348](#)  
    scan only [348](#)  
    send custom alert notification [352](#)  
    send to alternate destination host [351](#)  
    sending default notification [351](#)  
    Unscannable [349](#)  
    Virus Infected [349](#)  
Anti-Virus Archive Logs [1113](#)  
Anti-Virus Logs [1113](#)  
anti-virus quarantine. See quarantine, virus [900](#)  
archivemessage command [1086](#)  
AsyncOS reversion [1017](#)  
AsyncOS upgrades [1012](#)  
AutoSupport feature [35](#), [54](#), [1021](#)

### B

Base DN [760](#)  
base entropy value, for passphrase strength [967](#)  
blackhole listener [70](#), [1219](#)  
body scanning [163](#)  
Bounce Logs [1113](#)  
bouncerecipients command [1080](#)  
bouncing recipients [1081](#)  
    all [1081](#)  
    by Envelope From [1081](#)  
    by hostname [1081](#)  
bypassing [129](#), [211](#)  
    anti-spam [211](#)  
    throttling [129](#)

### C

call-ahead SMTP server [643](#), [649](#)  
    routing [649](#)  
CASE (Context Adaptive Scanning Engine [TM]) [396](#)  
case-sensitivity [153](#), [760](#), [764](#)  
    in LDAP queries [760](#), [764](#)  
    in message filters [153](#)

- categories [444](#)
  - adult [444](#)
  - advertisements [444](#)
  - alcohol [444](#)
  - arts [444](#)
  - astrology [444](#)
  - auctions [444](#)
  - business and industry [444](#)
  - chat and instant messaging [444](#)
  - cheating and plagiarism [444](#)
  - child abuse content [444](#)
  - computer security [444](#)
  - computers and internet [444](#)
  - dating [444](#)
  - digital postcards [444](#)
  - dining and drinking [444](#)
  - dynamic and residential [444](#)
  - education [444](#)
  - entertainment [444](#)
  - extreme [444](#)
  - fashion [444](#)
  - file transfer services [444](#)
  - filter avoidance [444](#)
  - finance [444](#)
  - freeware and shareware [444](#)
  - gambling [444](#)
  - games [444](#)
  - government and law [444](#)
  - hacking [444](#)
  - hate speech [444](#)
  - health and nutrition [444](#)
  - humor [444](#)
  - illegal activities [444](#)
  - illegal downloads [444](#)
  - illegal drugs [444](#)
  - infrastructure and content delivery networks [444](#)
  - internet telephony [444](#)
  - job search [444](#)
  - lingerie and swimsuits [444](#)
  - lotteries [444](#)
  - mobile phones [444](#)
  - nature [444](#)
  - news [444](#)
  - non-governmental organizations [444](#)
  - non-sexual nudity [444](#)
  - online communities [444](#)
  - online storage and backup [444](#)
  - online trading [444](#)
  - organizational email [444](#)
  - parked domains [444](#)
  - peer file transfer [444](#)
  - personal sites [444](#)
  - photo searches and images [444](#)
  - politics [444](#)
  - pornography [444](#)
  - professional networking [444](#)
- categories (*continued*)
  - real estate [444](#)
  - reference [444](#)
  - religion [444](#)
  - SaaS and B2B [444](#)
  - safe for kids [444](#)
  - science and technology [444](#)
  - search engines and portals [444](#)
  - sex education [444](#)
  - shopping [444](#)
  - social networking [444](#)
  - social science [444](#)
  - society and culture [444](#)
  - software updates [444](#)
  - sports and recreation [444](#)
  - streaming audio [444](#)
  - streaming video [444](#)
  - tobacco [444](#)
  - transportation [444](#)
  - travel [444](#)
  - unclassified [444](#)
  - weapons [444](#)
  - web hosting [444](#)
  - web page translation [444](#)
  - web-based email [444](#)
- centralized management [1002](#)
- Centralized Management [909, 1210](#)
  - and Destination Controls [1210](#)
  - and quarantines [909](#)
- certificate [655](#)
  - certificate authority [655](#)
- Certificate Signing Request [655](#)
- certificates [45, 535, 651, 654, 655](#)
  - demo [45](#)
  - generating a request [535](#)
  - generating and signing your own [655](#)
  - importing [651](#)
  - intermediate certificates [654](#)
- chain query [775](#)
  - creating [775](#)
- charset [924](#)
- CIDR address block [95](#)
- Cisco Security Intelligence Operations [403](#)
- Cisco Web Security Services [428](#)
- clean messageemail [814](#)
  - clean message [814](#)
- CLI [11](#)
  - see Command Line Interface [11](#)
- CLI Audit Logs [1113](#)
- Cloud user types [954](#)
- cluster [429](#)
- Code-in-Body> [70, 1070, 1073, 1074, 1075, 1077, 1078, 1079, 1080, 1082, 1083, 1084, 1085, 1086](#)
- community string [1088](#)
- conformance level [600](#)
  - SPF/SIDF verification [600](#)



- connectivity issues, troubleshooting [1222](#)
- content filters [272, 280, 287, 291, 900, 1281, 1282, 1285](#)
  - actions [280](#)
  - conditions [272](#)
  - example [1281, 1282](#)
  - non-ascii character sets [291, 1285](#)
  - variables [287](#)
- content matching classifier [493](#)
- Content Scanner [217](#)
- counters [1064](#)
- CPU usage [1066](#)
- CRAM-MD5 [782](#)
- CSV data [839](#)
- custom header [392](#)
- custom SMTP response [119](#)
  - variable [119](#)

**D**

- D-Mode [486](#)
- data loss prevention [900](#)
- default [30, 34, 35, 43, 44, 125](#)
  - domain [125](#)
  - gateway [35, 44](#)
  - hostname [34, 43](#)
  - IP address [30](#)
  - router [35, 44](#)
- default DNS server [1045](#)
- default router [35](#)
- delete all messages in the spam quarantine [946](#)
- deleterecipients command [1079](#)
- delivering mail [721](#)
  - message time out [721](#)
  - possible delivery [721](#)
- delivernow command [1085](#)
- Delivery Connection ID (DCID) [1064](#)
- Delivery Logs [1113](#)
- delivery queue [1079](#)
- delivery queue, monitoring [1074](#)
- demo certificate [45](#)
- Destination Controls [1210](#)
  - and Centralized Management [1210](#)
- detection rule [496, 500](#)
- Direct Server Return (DSR) [1107](#)
- Directory Harvest Attack (DHA) [776](#)
- disclaimer stamping [632, 634](#)
  - multiple encodings [634](#)
- disclaimers [630, 631, 632](#)
  - adding to messages [632](#)
  - HTML text resources [630](#)
  - using text resources [631](#)
- DKIM verification [597](#)
  - Authentication-Results header [597](#)
- DLP [486, 493, 494, 496, 500, 504, 511, 512, 514](#)
  - false positives, minimizing [486, 493, 494, 496, 500](#)

- DLP (*continued*)
  - including sensitive content in Message Tracking [511](#)
  - risk factor score [500](#)
  - severity scale [504](#)
  - troubleshooting [514](#)
  - updating the engine and classifiers [512](#)
- DLP policies [493, 496, 500, 503](#)
  - content matching classifier [493](#)
  - detection rule [496, 500](#)
  - filtering attachments [503](#)
  - filtering senders and recipients [503](#)
- DNS [35, 45, 817, 1044, 1045](#)
  - authoritative server [1044](#)
  - disabling reverse DNS lookup timeoutReverse DNS Lookup [1045](#)
    - disabling [1045](#)
  - double lookup [817](#)
  - priority [1044](#)
  - servers [35, 45](#)
  - setting [35, 45](#)
  - splitting [1044](#)
  - timeout [1044](#)
  - timeout for reverse DNS lookups [1045](#)
- DNS cache [1077](#)
- DNS list [166](#)
- DNS lookup [1077](#)
- DNS servers [1044](#)
- DNSBL [166](#)
- dnsstatus command [1077](#)
- Domain Debug Logs [1113](#)
- Domain Keys [577, 578, 580, 587](#)
  - importing signing keys [587](#)
  - signing key size [580](#)
  - verification [577](#)
  - verifying signatures [578](#)
- Domain Name Service (DNS) [35, 45](#)
  - settings [35, 45](#)
- domain profile [590](#)
  - deleting all existing profiles [590](#)
- double-DNS verified [818, 866](#)
- drop-attachments-where-dictionary-match [226](#)
- DSR [1107](#)
  - load balancing [1107](#)
  - loopback interface [1107](#)
  - Virtual IP (VIP) [1107](#)
- DTD (document type definition) [997](#)
- dual DKIM and DomainKey signing [583](#)
- dummy accounts [89](#)
- duplex settings, editing [1099](#)

**E**

- Early Expiration [902](#)
  - for quarantine [902](#)
- email [676](#)
  - rewriting addresses [676](#)

email injector [45](#)  
 see listener [45](#)

Email Security Monitor [807, 813, 817, 818, 839, 849, 866](#)  
 automated reporting [839](#)  
 external domains received listing [817](#)  
 Items Displayed menu [818, 866](#)  
 summary table [813, 849](#)  
 Time Range menu [813, 849](#)

encoding [634](#)  
 in disclaimers [634](#)

encryption [80, 522, 541, 651](#)  
 use with filter action [522, 541](#)

encryption headers [525](#)

End User Quarantine [938](#)  
 see spam quarantine, end user access [938](#)

enterprise gateway [55](#)

Enterprise Gateway configuration [82](#)

Envelope Recipient [158](#)

Envelope Recipient, rewriting [676](#)

Envelope Sender [158](#)

envelope sender DNS verification [118](#)

evaluation key [53](#)  
 McAfee [53](#)  
 Sophos [53](#)

evaluation key for IronPort Anti-Spam [52](#)

evaluation key for Outbreak Filters [40, 53](#)

explained [118](#)

exporting [629, 630](#)  
 HTML text resources [630](#)  
 text resources [629](#)

external authentication [786, 971, 972](#)  
 enabling LDAP [971](#)  
 enabling RADIUS [972](#)

**F**

factory configuration [30](#)

feedback about this documentation, sending [9](#)

filtering unparseable messages [157](#)

filters [131, 133, 140, 152, 157, 163, 167](#)  
 comment character [133](#)  
 matching dictionary terms [140, 167](#)  
 matching empty headers [157](#)  
 regular express and Python [152](#)  
 scannable archive file types [163](#)  
 unparseable messages [157](#)

final entry, in HAT [94](#)

findevent [1087](#)

finding senders [107](#)

forcing updates [357](#)

forward DNS lookup [1076](#)

FTP [1261](#)

FTP Access [1262](#)

FTP Server Logs [1113](#)

fully-qualified domain name [95](#)

**G**

gauges [1066](#)

global counters [1078](#)

good neighbor table [660](#)

graphical user interface [11](#)  
 see GUI [11](#)

graphs [1098](#)

grouping, of appliances for File Analysis result details in the cloud [469](#)

GUI [11, 12, 45, 1097](#)  
 accessing [12](#)  
 browser requirements [11](#)  
 enabling [45, 1097](#)  
 GUI logs. See HTTP logs [1113](#)  
 GUI session timeout [977, 978](#)

**H**

hard power reset [1016, 1232](#)

HAT [102, 107, 113](#)  
 exporting [113](#)  
 testing HAT variables [102](#)

HAT order [106](#)  
 editing via GUI [106](#)

headers [676](#)

headers, inserting [525](#)

headers, logging [397](#)

headers, stripping with message filters [208](#)

Host Access Table (HAT) [106](#)  
 reordering in GUI [106](#)

hostname [34, 43](#)  
 specifying the hostname during setup [34](#)

hostrate command [1075](#)

hoststatus command [1073](#)

HTTP [45, 1097, 1261](#)  
 enabling [45](#)  
 GUI [1097](#)

HTTP authentication [840](#)

HTTP Logs [1113](#)

HTTPS [45, 669, 1097, 1261](#)  
 certificate for [669](#)  
 enabling [45](#)  
 GUI [1097](#)

HTTPS login [12](#)

**I**

image analysis [220, 272, 280](#)

image scanning [220](#)

image verdicts [220](#)

IMAP authentication [938](#)

implementsv [119](#)

importing [629, 630](#)  
 HTML text resources [630](#)  
 text resources [629](#)

- importing signing keys [587](#)
  - incoming relay [392, 393](#)
    - custom header [392](#)
    - received header [393](#)
  - incoming relays [597](#)
  - Incoming Relays [397](#)
    - example log entry [397](#)
  - Injection Connection ID (ICID) [1064](#)
  - injection control counter reset [116](#)
  - injection control periodicity [116](#)
  - Injection Debug Logs [1113](#)
  - injector [45](#)
    - see listener [45](#)
  - insecure relay [126](#)
  - inserting headers [525](#)
  - installation [1017](#)
    - reverting [1017](#)
  - invalid recipient [814](#)
  - IP interfaces [35, 45](#)
    - assigning [35](#)
    - defining listeners on [45](#)
  - IronPort Anti-Spam [39, 52, 360, 399](#)
    - evaluation key [39, 52](#)
    - filters [360](#)
    - testing [399](#)
  - IronPort Email Encryption [515, 518, 522, 541](#)
    - configuring [515](#)
    - envelope settings [518](#)
    - key server settings [518](#)
    - message settings [518](#)
    - notification settings [518](#)
    - use with filter action [522, 541](#)
  - IronPort Spam Quarantine [64](#)
    - released messages and email pipeline [64](#)
  - IronPort Spam Quarantine. See Spam quarantine [900](#)
  - IronPort Text Mail Logs [1113](#)
- ## K
- key size [580](#)
- ## L
- LDAP [158, 159, 754, 757, 759, 760, 761, 764, 766, 767, 780, 786, 790, 792, 936, 938, 971](#)
    - alias consolidation query [790](#)
    - alias expansion [767](#)
    - anonymous queries [761](#)
    - base DN [760](#)
    - connection pooling [780](#)
    - connections [764](#)
    - external authentication [786, 971](#)
    - failover [792](#)
    - group queries [158, 159](#)
    - LDAPS certificate [761](#)
    - LDAP (*continued*)
      - load-balancing [792](#)
      - Microsoft Exchange 5.5 support [757](#)
      - multiple servers [792](#)
      - OpenLDAP queries [766](#)
      - query tokens [760](#)
      - recursive queries [761](#)
      - SSL [761](#)
      - SunONE queries [766](#)
      - test servers [754](#)
      - testing queries [759, 764](#)
      - testing servers [754](#)
    - LDAP Debug Logs [1113](#)
    - LDAP errors [765](#)
    - LDAP routing query [648](#)
      - with SMTP call-ahead recipient validation [648](#)
    - LDAPS certificate [761](#)
    - limits [673](#)
      - SMTP Routes [673](#)
    - link aggregation [1100](#)
    - listener [79, 80, 632](#)
      - adding disclaimers [632](#)
      - encryption on [80](#)
      - malformed MAIL FROM and default domain [79](#)
    - listenerconfig command [70](#)
    - load [1066](#)
    - log file type [1113](#)
    - log subscription [350, 1113](#)
      - Sophos [350](#)
    - log subscriptions [1121](#)
    - logging,headers [397](#)
    - logical IP interface [35](#)
    - logs [1113, 1117, 1121, 1162, 1172, 1174, 1176, 1227](#)
      - Anti-Spam Archive [1113](#)
      - Anti-Virus [1113](#)
      - Anti-Virus Archive [1113](#)
      - Bounce Logs [1113](#)
      - CLI Audit Logs [1113](#)
      - comparison [1117](#)
      - Configuration History Logs [1162](#)
      - definition [1113](#)
      - Delivery Logs [1113](#)
      - extensions in filenames [1176](#)
      - format [1113](#)
      - FTP Server Logs [1113](#)
      - global attributes [1174](#)
      - HTTP Logs [1113](#)
      - Injection Debug Logs [1113](#)
      - IronPort Text Mail Logs [1113](#)
      - LDAP Debug Logs [1113](#)
      - levels [1172](#)
      - log subscription defined [1113](#)
      - NTP Logs [1113](#)
      - qmail Format Delivery Logs [1113](#)
      - Scanning [1113](#)
      - Status Logs [1113](#)

logs (*continued*)

- subscriptions [1121](#)
- troubleshooting with [1227](#)
- loopback interface [1107](#)

**M**

- M-Series [1249](#)
- MAIL FROM [140, 272](#)
- mail loops, detecting [249](#)
- mail policies [260](#)
  - First Match Wins [260](#)
- mail policies, outgoing [505](#)
  - DLP [505](#)
- mail protocol [70](#)
  - defining in < [70](#)
- mail transfer agent. See MTA. [1250](#)
- mailtable feature [671](#)
- mailing lists [943](#)
  - notifications [943](#)
- malware [342](#)
  - defined [342](#)
- marketing messages [814](#)
- matching empty headers [157](#)
- maximum [81, 89](#)
  - message size in HAT [81](#)
  - messages per connection in HAT [81](#)
  - recipients per hour in HAT [89](#)
  - recipients per message in HAT [81](#)
- maximum recipients per hour [81](#)
- mbox format [207](#)
- mbox-format log file [350](#)
- McAfee [53](#)
  - evaluation key [53](#)
- McAfee anti-virus engine [345](#)
- memory [1066](#)
- message body scanning [164](#)
- message encoding [236](#)
  - modifying [236](#)
- message filter [186](#)
  - filter actions [186](#)
- message filter action variables [632](#)
  - using in disclaimers [632](#)
- message filter for SBRS [90](#)
- message filters [131, 132, 133, 135, 140, 161, 162, 163, 164, 167, 195, 230, 233, 234, 900](#)
  - adding [230](#)
  - attachment-protected [140](#)
  - attachment-unprotected [140](#)
  - body-dictionary-match [167](#)
  - combining [133, 140](#)
  - deleting [230](#)
  - encryption [164](#)
  - exporting [234](#)
  - importing [233](#)
  - making (in)active [230](#)

message filters (*continued*)

- MIME types [163](#)
- moving [230](#)
- ordering [135](#)
- overview [131](#)
- random numbers in [162](#)
- rules [132](#)
- SenderBase Reputation Score [167](#)
- status [230](#)
- syntax [133](#)
- time and date [161](#)
- variables [195](#)
- message headers [161](#)
- message headers, inserting with message filters [208](#)
- Message ID (MID) [1064](#)
- message modification level threshold [417](#)
- message replication [186, 203](#)
- message splintering [261](#)
  - defined [261](#)
- message tracking [396](#)
  - Incoming Relays [396](#)
- Message Tracking [511](#)
  - and sensitive content [511](#)
- message variables [940](#)
  - spam quarantine notifications [940](#)
- MIB file [1089](#)
- monitoring [1069](#)
- monitoring Virtual Gateway addresses [730](#)
- MTA [55, 82, 651](#)
- multilayer anti-virus scanning [342](#)
- multiple appliances [30](#)
- multiple recipients [261](#)
- MX [17](#)

**N**

- negative scores [98](#)
- netmask [35](#)
- network access list [975](#)
- network time protocol (NTP) [34, 54](#)
  - settings [34, 54](#)
- NIC pairing [1100, 1101](#)
  - alerts [1101](#)
  - named on upgrade [1101](#)
- NIC teaming [1100](#)
- Normal Expiration [902](#)
  - for quarantine [902](#)
- not.double.verified [118](#)
- NTP Logs [1113](#)
- NTP server [1059](#)
  - removing [1059](#)
- NXDOMAIN [118, 124](#)

**O**

- oldmessage command [1086](#)
- open relay, definition [126](#)
- opening links in a separate window [813](#)
- Outbreak Filters [40](#), [53](#), [280](#), [401](#), [403](#), [404](#), [405](#), [406](#), [407](#), [408](#), [409](#), [410](#), [413](#), [415](#), [416](#), [417](#), [422](#)
  - Adaptive rules defined [406](#)
  - Adaptive Scanning [413](#)
  - alerts [422](#)
  - always rule [408](#)
  - anti-virus updates [409](#)
  - bypassed file extensions [416](#)
  - Context Adaptive Scanning EngineOutbreak Filters [404](#)
    - CASE [404](#)
  - delaying messages [404](#)
  - enabling alerts [413](#)
  - evaluation key [40](#), [53](#)
  - modifying messagesOutbreak Filters [406](#)
    - message modification [406](#)
  - multiple scores [409](#)
  - non-viral threats [403](#)
  - Outbreak rules defined [406](#)
  - overview [401](#)
  - re-evaluating messages [409](#), [410](#)
  - redirecting links [405](#)
  - rule [407](#)
  - setting a message modification level threshold [417](#)
  - setting a quarantine level threshold [416](#)
  - skipping [280](#)
  - SNMP Traps [422](#)
  - threat categoriesOutbreak Filters [403](#)
    - virus outbreaks [403](#)
  - updating rules [415](#)
  - using without anti-virus scanning [409](#)
- overflow [409](#)

**P**

- partial address [95](#), [128](#)
  - in HAT [95](#)
  - in RAT [128](#)
- passphrase [966](#)
  - settings [966](#)
- pausing the work queue [1085](#)
- PEM format, for certificates [535](#)
- performance [1231](#)
- phased approach to reputation filters [87](#)
- pinout for serial connection [25](#)
- POP authentication [938](#)
- POP/IMAP servers [82](#)
- positive scores [98](#)
- possible delivery [721](#)
- private injector [48](#)
- private key [651](#)

- private listeners [94](#)
  - default entries [94](#)
- prototcol [70](#)
  - see mail protocol [70](#)
- proxy server for IronPort Anti-Spam Rules [1007](#)
- public blocked list [166](#)
- public listeners [94](#)
  - default entries [94](#)
- purging address tagging keys [719](#)
- PVO. See quarantines, policy, virus, and outbreak [900](#)

**Q**

- qmail Format Delivery Logs [1113](#)
- quarantine [474](#), [900](#), [902](#), [903](#), [906](#), [910](#), [911](#), [913](#), [915](#), [917](#)
  - applying actions to messages in [911](#)
  - default action [903](#), [906](#)
  - displaying non-ascii characters in subject [474](#)
  - early expiration [902](#)
  - In other quarantines [913](#)
  - international character sets [910](#)
  - normal expiration [902](#)
  - outbreak [900](#)
  - outbreak, reporting messages to Cisco [917](#)
  - retention time [902](#)
  - spam. See Spam quarantine [900](#)
  - stripping attachments [474](#)
  - subject tagging [474](#)
  - testing messages for viruses [915](#)
  - unclassified [906](#)
  - virus [900](#)
- quarantine level threshold [416](#)
- quarantine overflow [409](#)
- Quarantine Threat Level Threshold [407](#)
  - recommended default [407](#)
  - setting [407](#)
- quarantines [900](#), [901](#), [909](#)
  - centralized policy, virus, and outbreak quarantines [909](#)
  - policy [900](#)
  - policy, virus, and outbreak [909](#)
    - centralized [909](#)
  - policy, virus, and outbreak, managing [901](#)
  - types [900](#)
- queries [766](#), [767](#), [768](#), [770](#), [779](#), [786](#), [790](#)
  - acceptance [766](#)
  - external authentication [786](#)
  - group [770](#)
  - masquerading [768](#)
  - routing [767](#)
  - SMTP authentication [779](#)
  - spam quarantine alias consolidation [790](#)
- queue [70](#)

## R

RADIUS external authentication **972**  
RAM **1231**  
RAM Utilization **1066**  
RAT **129**  
    bypassing recipients **129**  
    bypassing recipients (CLI) **129**  
    bypassing recipients (GUI) **129**  
rate command **1075**  
rates **1068**  
RBL **140**  
RCPT TO **140, 272**  
RCPT TO command **127**  
real-time monitoring **1075**  
received header **393**  
receiving control, bypass **129**  
receiving errors **1227**  
Recipient Access Table (RAT) **125, 126**  
    default entry **126**  
    definition **125**  
    editing via CLI **126**  
recipient validation **643**  
recipients, counting in message filters **163**  
reconfigure **30**  
recursive DNS queries **1045**  
recursive queries, LDAP **761**  
redirecting email **36**  
redirecting URLs in messages **434**  
redirectrecipients **1081**  
relaying email **94**  
relaying messages **45**  
remote **1004**  
removemessage command **1086**  
reporting **396**  
    Incoming Relays **396**  
required TLS **659**  
resetcounters command **1078**  
Resource Conservation mode **1066, 1231**  
resume command **1085**  
resumedel command **1083**  
resumelister command **1084**  
resuming email delivery **1083**  
resuming receiving **1084**  
Retention Time **902**  
    for quarantines **902**  
retrospective verdict **481**  
retry message delivery **823**  
reverse DNS lookup **100, 723, 1076**  
revert **1017**  
    installation **1017**  
rewriting email addresses **676**  
rewriting URLs in messages **434**  
RFC **9, 259, 474, 651, 1088**  
    1065 **1088**  
    1066 **1088**

RFC (*continued*)

1067 **1088**  
1213 **1088**  
1907 **1088**  
2047 **474**  
2487 **651**  
2821 **9**  
821 **259**  
822 **259**  
risk factor score **486, 500**  
    DLP **500**  
rolling over log files **1176**  
root servers (DNS) **35, 45**  
routing **649**  
    SMTP call-ahead server **649**

## S

safelist/blocklist **925, 926, 927, 934, 935**  
    and external spam quarantine **927**  
    backing up and restoring **934**  
    enabling **926**  
    importing and exporting **934**  
    managing **927**  
    troubleshooting **935**  
    workqueue **925**  
SBRS **89, 98, 167**  
    none **98, 167**  
    testing **89**  
SBRS see Senderbase Reputation Service Score **98**  
scannable archive file types **163**  
scanning images **220**  
Scanning Logs **1113**  
scheduled log rollover **1176**  
scp command **1264**  
SDS. See Cisco Web Security Services **428**  
secure copy **1264**  
secure HTTP (https) **651**  
Secure LDAP **761**  
Secure Socket Layer (SSL) **651**  
selecting a notification **637**  
SenderBase **81, 98**  
    SBO in sender groups **98**  
SenderBase Affiliate network **85**  
SenderBase Network Owner Identification Number **95**  
SenderBase Reputation score **396**  
SenderBase Reputation Score **86, 98**  
SenderBase Reputation Scores, syntax in CLI **98**  
SenderBase Reputation Service **85, 807**  
SenderBase Reputation Service Score **98**  
SenderBase, querying **98**  
separate window icon **813**  
serial connection pinouts **1265**  
SERVFAIL **118, 124**  
severity scale **504**  
    DLP **504**

- showmessage command **1086**
- showrecipients **1082**
- SIDF records **598, 599**
  - testing **599**
  - valid **598**
- SIDF verification **140, 597, 600, 604, 607**
  - configuring **597**
  - conformance level **600**
  - enabling **600**
  - results **604**
  - testing **607**
- signing key **580**
  - size **580**
- signing keys **588**
  - deleting all existing keys **588**
  - removing specific keys **588**
- SMI file **1089**
- SMTP **82, 127, 399**
  - messages **82**
  - response **127**
  - testing IronPort Anti-Spam **399**
- SMTP Auth **779, 782**
  - DIGEST-MD5 **782**
  - MD5 **779**
  - SHA **779**
  - supported authentication mechanisms **779**
  - TLS **782**
- SMTP authenticated user match filter rule **172**
- SMTP Authentication profile **782**
- SMTP call-ahead recipient validation **643, 647, 648, 649**
  - bypassing **649**
  - conversation workflow **643**
  - SMTP server responses **647**
  - with LDAP routing query **648**
- SMTP Call-Ahead Server Profile **645, 648**
  - creating **645**
  - enabling on a listener **648**
- SMTP conversation **643**
  - SMTP call-ahead server **643**
- SMTP daemon **45**
  - see injector **45**
  - see listener **45**
- SMTP Routes **671, 673, 674**
  - limits **673**
  - mail delivery and splintering **674**
- SNMP **1088, 1089, 1090**
  - community string **1088**
  - MIB file **1089**
  - overview **1088**
  - SMI file **1089**
  - specifying multiple trap targets **1090**
  - traps **1090**
- SNMP (Simple Network Management Protocol) **1088**
- snmpconfig command **1090**
- SNMPv1 **1088**
- SNMPv2 **1088**
- Sophos **39, 53, 357**
  - evaluation key **39, 53**
  - updates **357**
- Sophos virus scanning **351**
  - filters **351**
- spam **399**
  - testing **399**
- spam message **814**
- spam quarantine **919, 921, 936, 937, 938, 940, 943, 945, 946, 947, 1251**
  - alias consolidation **943**
  - behavior when full **921**
  - deleting all messages **946, 947**
  - disabling **947**
  - end user access **938**
  - end-user access **936**
  - external **919, 1251**
  - IMAP/POP authentication **937**
  - LDAP authentication **937**
  - local **919**
  - message details **945**
  - message variables **940**
  - notification **940**
  - receiving multiple notifications **943**
  - released messages and email pipeline **946**
  - testing notifications **943**
- specifying an offset **1059**
- SPF records **598, 599**
  - testing **599**
  - valid **598**
- SPF verification **597, 600, 603, 604, 607**
  - configuring **597**
  - conformance level **600**
  - enabling **600**
  - received SPF header **603**
  - results **604**
  - testing **607**
- spf-passed filter rule **140, 606**
- spf-status filter rule **140, 605**
- SPFverification **140**
- SSH **15**
- SSL **761**
- STARTTLS **651**
  - definition **651**
- stateless logs **1136**
- status command **1070**
- status detail command **1070**
- Status Logs **1113**
- stopped by content filter **814**
- stopped by reputation filtering **814**
- streaming upgrades **1004**
- strip headers **208**
- strip-header filter action **208**
- subnet **35**
- suspenddel command **1082**
- suspending email delivery **1082**
- suspending receiving **1083**

suspendlistener command [1084](#)  
 synchronizing time [34, 54](#)  
 System Capacity [834, 835, 836, 852, 853, 854](#)  
   All page [836, 854](#)  
   Incoming Mail page [835, 853](#)  
   memory page swapping [836, 854](#)  
   Outgoing Mail page [835, 853](#)  
   System Load page [835, 853](#)  
   WorkQueue page [834, 852](#)  
 system clock [34, 54](#)  
 System Logs [1113](#)  
 system quarantine. See quarantines, policy, virus, and outbreak [900](#)  
 system setup wizard [30](#)  
 system time [34, 54](#)  
   setting [34, 54](#)

## T

testing [355, 399](#)  
   IronPort Anti-Spam [399](#)  
   Sophos virus engine [355](#)  
 testing HAT variables [102](#)  
 text resources [628, 629, 630, 631](#)  
   code view [630](#)  
   disclaimers [631](#)  
   exporting [629](#)  
   exporting and importing into HTML resources [630](#)  
   HTML-based [630](#)  
   importing [629](#)  
   managing [628](#)  
   using in policies and settings [631](#)  
 third-party relay [126](#)  
 Threat Level [406](#)  
   defined [406](#)  
 Threat Operations Center (TOC) [406](#)  
 thresholds, in SenderBase Reputation Scores [98](#)  
 throttling [85](#)  
 time servers [34, 54](#)  
 time zone [1059](#)  
 time zone, setting [34, 54](#)  
 time, system [34, 54](#)  
 TLS [651, 660](#)  
   certificates [651](#)  
   default [660](#)  
   preferred [660](#)  
   required [660](#)  
 tophosts command [1074](#)  
 topin command [1077](#)  
 trace [396](#)  
 trace command [89](#)  
 troubleshooting [514](#)  
   DLP [514](#)  
 trustworthiness [98](#)  
 TTL [1072](#)

## U

unary form, in message filters [162](#)  
 unclassified quarantine. See quarantine, unclassified [900](#)  
 unparsable messages [157](#)  
 unsolicited commercial email [85](#)  
 updates [512](#)  
   DLP engine and classifiers [512](#)  
 upgrades [1004, 1005, 1016](#)  
   available [1016](#)  
   local [1004](#)  
   obtaining via GUI [1005](#)  
   streaming [1004](#)  
 URL reputation [425](#)  
 user accounts [949, 966](#)  
   limits [949](#)  
   locking and unlocking [966](#)  
 user groups [949, 950](#)  
 user types [950](#)  
 uuencoded attachments [135](#)

## V

verdict [272, 280](#)  
   image analysis [272, 280](#)  
 verification [597](#)  
   SIDF [597](#)  
   SPF [597](#)  
 version [837](#)  
 virtual appliance [1113](#)  
   license [1113](#)  
 virtual Email Security appliance [24](#)  
   loading the license [24](#)  
 Virtual Gateway addresses [207](#)  
 Virtual Gateway queue [723](#)  
 Virtual IP (VIP) [1107](#)  
 virus message [814](#)  
 virus quarantine. See quarantine [900](#)  
   virus. [900](#)  
 VLAN [1103](#)  
   defined [1103](#)  
   labels [1103](#)

## W

WBRS [425](#)  
   See URL reputation [425](#)  
 web interface [45](#)  
   enabling [45](#)  
 web reputation [178, 214](#)  
   message filters [178, 214](#)  
 Web UI session timeout [977, 978](#)  
 weekly status updates [54](#)  
 white space [150](#)  
 whitespace [350](#)



wizard [30, 40](#)  
    Active Directory [40](#)  
    system setup [30](#)  
work queue [1066, 1085](#)  
work queue, pausing [1085](#)

## X

X-headers, adding [474](#)  
X-IronPort-AV header [348](#)  
XML [997, 1098, 1113](#)  
XML Status feature [1098](#)

