

# Cisco Ultra-Reliable Wireless Backhaul FM4500 Mobile

## Installation and Configuration Manual

(Formerly Fluidmesh)  
Model FM4500 | Edition 1.18 | Firmware 9.3.0

Copyright © Cisco and the Cisco logo are trademarks or registered trademarks of Cisco and/or its affiliates in the U.S. and other countries. To view a list of Cisco trademarks, go to this URL: [www.cisco.com/go/trademarks](http://www.cisco.com/go/trademarks). Third-party trademarks mentioned are the property of their respective owners. The use of the word 'partner' does not imply a partnership relationship between Cisco and any other company. (1110R) © 2018–2020 Cisco Systems, Inc. All rights reserved.

# Table of Contents

- 1. HAZARDOUS CONDITION WARNINGS..... 7
  - 1.1. Water Ingress Hazard..... 8
  - 1.2. Radio-Frequency Transmission Hazard ..... 9
  - 1.3. Hot Surfaces Hazard ..... 10
- 2. Reporting Mistakes And Recommending Improvements..... 11
- 3. Getting Started ..... 12
  - 3.1. Introduction..... 12
    - 3.1.1. Cisco FM4500 Mobi..... 12
      - The Cisco FM4500 Mobi Radio Transceiver ..... 12
      - Introduction..... 12
      - Unit Function And Throughput Speed ..... 13
      - Data Throttling..... 13
      - MPLS Protocol ..... 13
      - Unit Configuration ..... 13
      - Environmental Rating..... 13
      - Product Specifications ..... 13
      - Transceiver And Gateway Unit Power Consumption ..... 13
    - 3.2. Fluidmesh Architecture..... 15
      - 3.2.1. Overview ..... 15
        - Wireless Network Architectures..... 15
      - 3.2.2. Fluidmesh Technologies..... 15
        - Prodigy ..... 15
        - Fluidity ..... 16
        - FM Racer ..... 16
      - 3.2.3. Point-To-Point Wireless Bridge..... 16
      - 3.2.4. Mesh Network Architecture ..... 17
    - 3.3. Fluidmesh Network Addressing ..... 18
      - 3.3.1. Bridge IP Addressing..... 18
      - 3.3.2. Unit Identification And Addressing ..... 19
        - Mesh- And Bridge-Capable Radio Transceiver Identification ..... 19
        - Operating The Unit In Mesh Point Mode Or Mesh End Mode..... 20
        - Network Addressing ..... 21
          - Fluidmesh Radio Transceivers..... 21
          - Connecting And Configuring An Ethernet Edge Device..... 21
          - Fluidmesh Radio Transceivers..... 22
- 4. Installing The Radio..... 23
  - 4.1. Installing The Radio Using Tie-Wraps Or Hose Clamps ..... 23
  - 4.2. Installation On A DIN Rail ..... 24
  - 4.3. Installation Using The Sliding Bracket..... 25
- 5. Hardware Installation ..... 27
  - 5.1. Fluidmesh Hardware Installation..... 27
    - 5.1.1. Installing The Cisco FM4500 Mobi ..... 27
      - Environmental Rating And Unit Roles ..... 27
      - Installation Hardware ..... 27
    - 5.1.2. Cisco FM4500 Mobi Status And Link LEDs ..... 27
      - Unit And Link Quality Status ..... 27
      - Boot Sequence ..... 28
    - 5.1.3. Supplying Power To The Cisco FM4500 Mobi ..... 28
      - Connecting Power To The Cisco FM4500 Mobi ..... 29
        - DC IN, LAN1/POE And LAN2 Ports..... 29



5.1.4. Rebooting The Firmware And Resetting The Unit To Factory Defaults .....	30
Device Firmware Reboot .....	30
Resetting The Unit To Factory Settings .....	31
5.1.5. Suitability For Outdoor Installation.....	31
5.2. Connecting The Fluidmesh Cisco FM4500 Mobi To A Network And Antennas .....	32
5.2.1. Terminal Assignments For Power And Data Connectors .....	32
M12 A-Coded .....	32
M12 A-Coded (Five-Pin).....	32
M12 A-Coded Eight-Pin (Pre-September 2016 Only).....	33
M12 X-Coded .....	34
5.2.2. Connecting A DC IN Power Source To The Unit .....	35
5.2.3. Connecting LAN Cables To The Unit.....	36
M12X LAN Cables .....	36
5.2.4. Connecting The Antennas To The Cisco FM4500 Mobi .....	38
QMA Antenna Connections .....	38
6. Using The Fluidmesh Partner Portal .....	41
6.1. Accessing The Partner Portal .....	41
6.2. Enabling Two-Factor Authentication For Security.....	42
6.3. Administering Plug-In License Codes.....	43
6.4. Using The RACER™ Radio Configuration Interface .....	44
6.5. Viewing The Technical Documentation For Your Fluidmesh Device.....	44
7. Device Configuration Using The Configurator Interface .....	45
7.1. Software And Hardware Prerequisites .....	47
7.2. Accessing The Cisco FM4500 Mobi For Device Configuration .....	47
7.2.1. Local Access And Login For Initial Configuration .....	48
7.2.2. Initial Configuration With The Unit In Provisioning Mode.....	51
7.3. Switching Between Offline And Online Modes.....	57
Uploading A Device Configuration File From FM Racer .....	58
7.4. Viewing And Accessing The FM Monitor Settings .....	59
7.5. General Settings.....	61
7.5.1. The General Mode Window .....	61
Changing The Operational Mode .....	62
Changing The Operational Mode On A Mesh Network-Capable Unit .....	62
Changing The Prodigy Version .....	64
Changing The LAN Parameters.....	65
7.5.2. Wireless Settings .....	66
Modifying The Wireless Settings .....	66
Important Considerations For Wireless Settings .....	68
Co-Location Considerations .....	68
Channel Width Considerations .....	68
Dynamic Frequency Selection Considerations .....	69
7.5.3. Antenna-Alignment Tools And Physical Statistics .....	71
7.6. Network Control.....	72
7.6.1. Ping Softdog .....	72
7.6.2. FM-QUADRO .....	74
FM-QUADRO For Mesh Network-Capable Devices .....	74
Plotting And Interpreting The Wireless Links .....	75
Viewing Live Data For A Radio Or Wireless Link .....	79
Viewing Live RSSI Data For A Wireless Link .....	82
Manipulating The FM-QUADRO View .....	83
Changing The Relative Position Of Device Icons.....	83

Showing KPI Values For Wireless Links .....	85
Showing Real-Time Color Codes For Radio Transceiver Key Performance Indicators.....	86
Adding An Aerial Map To The FM-QUADRO View.....	86
Adjusting The Transparency Of The Aerial Map View .....	88
Exporting A Network Representation File .....	88
7.6.3. Advanced Tools .....	89
Using The Ping Test Tool.....	89
Using The Bandwidth Test Tool .....	90
Using The Path MTU Discovery Tool .....	91
7.7. Advanced Settings .....	92
7.7.1. Advanced Radio Settings .....	92
Using The FluidMAX Management Setting.....	93
Using The Max TX Power Setting .....	94
Using The Max TX Power Setting.....	94
Using The Select Antenna Gain Setting.....	95
Using The Data Packet Encryption Setting.....	95
Using The Maximum Link Length Setting .....	96
7.7.2. Static Routes .....	96
7.7.3. Pass Lists And Block Lists.....	97
7.7.4. Multicast .....	101
Multicast Management For Mesh Network-Capable Devices .....	101
Configuring Multicast Within A Layer-3 Network.....	103
7.7.5. SNMP Configuration.....	104
Using SNMP V2c.....	105
Using SNMP V3.....	106
7.7.6. RADIUS Configuration .....	108
7.7.7. NTP Configuration .....	111
7.7.8. L2TP Configuration.....	112
7.7.9. VLAN Settings .....	113
VLAN Configuration.....	113
Rules For Packet Management.....	115
7.7.10. Fluidity Settings.....	116
Handoff Logic And Rate Adaptation Settings .....	119
7.7.11. Miscellaneous Settings .....	120
7.8. Management Settings.....	122
7.8.1. View Mode Settings.....	122
7.8.2. Changing The Administrator Username And Password.....	125
Enabling Remote Access To The Unit By Telnet .....	126
7.8.3. Overwriting And Upgrading The Unit Firmware.....	127
7.8.4. Plug-In Management.....	129
7.8.5. The Device Status View.....	133
The Device Status Window .....	133
7.8.6. Saving And Restoring The Unit Settings .....	135
7.8.7. Resetting The Unit To Factory Defaults .....	137
Rebooting The Unit .....	137
7.8.8. Logging Out .....	138
7.8.9. Viewing The End-User License Agreement.....	138
8. Software Plug-Ins .....	140
8.1. Available Plug-Ins.....	140
8.2. Plug-In Management Procedures .....	144
8.2.1. Plug-In Activation.....	144
8.2.2. Deactivating An Active Plug-In.....	146
8.2.3. Reactivating A Deactivated Plug-In.....	149



8.2.4. Exporting And Uploading Multiple Activation Codes.....	150
8.2.5. Sharing License Codes And Accepting Shared License Codes.....	151
9. Troubleshooting .....	153
9.1. I Cannot Get The Log-In Screen .....	153
9.2. I Cannot Log In To The FM Racer Interface.....	153
9.3. I Forgot The Administrator Password.....	153
9.4. The Wireless Link Is Poor Or Non-Existent In Bridge Mode .....	154
10. Electrical Power Requirements .....	155
11. Heat Radiation Data .....	158
12. Federal Communications Commission (FCC) Radio Interference Statement.....	160
13. Agência Nacional De Telecomunicações (Anatel) Radio Interference Statement.....	163
14. Device Certification For Taiwan (RoC).....	164
15. Notices And Copyright .....	166
16. Fluidmesh End-User License Agreement .....	168
16.1. Preamble .....	168
16.2. Notice.....	168
16.3. Definitions.....	168
16.4. License Grant .....	169
16.5. Uses And Restrictions On Use.....	169
16.6. Open-Source Software.....	170
16.7. Termination .....	170
16.8. Feedback.....	171
16.9. Consent To Use Of Data.....	171
16.10. Warranty Disclaimer .....	172
16.11. Limitation Of Liability.....	172
16.12. Exclusion Of Liability For Emergency Services .....	173
16.13. Export Control.....	173
16.14. General.....	174
17. Contact Us .....	175

## 1. HAZARDOUS CONDITION WARNINGS

Like all other global technology vendors, Fluidmesh is required to comply with all local health and government regulations in the locations in which we operate. This includes meeting radio frequency (RF) exposure limits for our products.

Our equipment is tested in accordance with regulatory requirements as a condition to our ability to market and sell in any given jurisdiction. As an equipment manufacturer, Fluidmesh defers to expert national and international health organizations responsible for guidance on the safety of RF signals, specifically the US Food and Drug Administration (FDA), Health Canada, the World Health Organization (WHO), and other national and global health agencies.

In May 2019, the FDA stated that there is "no link between adverse health effects and exposure at or under the current RF energy exposure limit", and that the current FCC RF exposure limits are sufficient to insure the safety of users.

If any Fluidmesh hardware unit breaks down or malfunctions, emits smoke or an unusual smell, if water or other foreign matter enters the unit enclosure, or if the unit is dropped onto a hard surface or damaged in any way, power off the unit immediately and contact an authorized Fluidmesh Networks dealer for assistance.

If you are adjusting and/or controlling a Fluidmesh device using control software such as the RACER™ interface or the device's local Configurator interface, do not make configuration changes unless you know with certainty that your changes will not negatively impact people or animals in the vicinity of the device and its antennas.

## 1.1. Water ingress hazard



### CAUTION

In all circumstances where the Cisco FM4500 Mobi will be installed in an outdoor location, it is compulsory to mount the Cisco FM4500 Mobi inside an FM-SHIELD auxiliary mounting kit.

The FM-SHIELD auxiliary mounting kit is a proprietary Fluidmesh solution, and is designed specifically to assure the long-term durability and reliability of compatible radio transceivers that have been installed in outdoor environments.

If you need further information regarding the recommended usage of FM-SHIELD, contact your Fluidmesh Networks representative.

Relevant technical specifications for FM-SHIELD can be found in the *Fluidmesh FM-SHIELD installation manual*.



## 1.2. Radio-frequency transmission hazard



### WARNING

The system shown in this manual is designed to be installed and operated in a way that avoids contact with the antennas by human beings. The legislation quoted in this section is designed to reduce overall exposure of human beings to RF radiation.

This section gives minimum separation distances between antennas and humans. It is strongly recommended that the system be installed in a location where these minimum separation distances can be maintained at all times.

**United States:** This system has been evaluated for RF exposure for humans, in accordance with FCC regulation CFR 47 Part 2.1091. To maintain compliance, the minimum separation distance from the antenna to general bystanders is 20cm/7.9in. (all FM Ponte kit and x200 radio transceivers), or 21cm/8.3 in. (all FM1300 Otto and x500 radio transceivers).

**Canada:** This system has been evaluated for RF exposure for humans, in accordance with ISED regulation RSS-102. To maintain compliance, the minimum separation distance from the antenna to general bystanders is 20cm/7.9in. for all Fluidmesh radio transceivers.

**Europe / Australia / New Zealand:** This system has been evaluated for RF exposure for humans, in accordance with standard EN 62232. To maintain compliance, the minimum separation distance from the antenna to general bystanders is 20cm/7.9in. for all Fluidmesh radio transceivers.

Before activating any device capable of transmitting RF signals, make sure that all persons and animals are protected from possible RF exposure.

Make sure that all RF feeds are securely connected to an appropriate antenna. Never activate any RF-capable device that is not connected to an antenna.

### 1.3. Hot surfaces hazard

**WARNING**

The outer surfaces of transceiver and gateway unit enclosures may become hot during normal operation. During normal operation, do not touch or handle the unit enclosure without personal protective equipment.

## 2. Reporting mistakes and recommending improvements

You can help improve this manual.

If you find any mistakes, or if you know of a way to improve the procedures that are given, please let us know by E-mailing your suggestions to [documentation@fluidmesh.com](mailto:documentation@fluidmesh.com).

## 3. Getting Started

### 3.1. Introduction

#### 3.1.1. Cisco FM4500 Mobi

*The Cisco FM4500 Mobi radio transceiver*

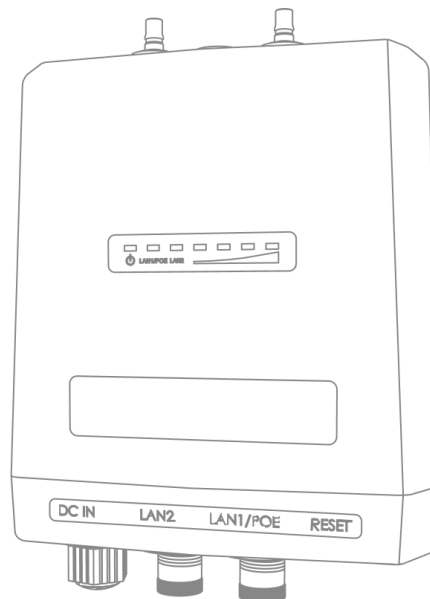

#### *Introduction*

The Cisco FM4500 Mobi (model FM4500) is designed to operate in the sub-6 GHz range as a static-mount wireless data link. In non-technical terms, this means it is designed to function as an intermediate radio link between a core wired data network and a sub-network. The unit is specifically designed for enhanced survivability in harsh environments such as seaside ports, railways and mines. It provides reliable service in high-speed applications (for example, servicing extremely fast-moving trains) and must be connected to one or more external antennas. The unit is designed primarily for mobility applications based on Fluidity technology, in which specialized antennas need to be deployed (for example, train-to-ground, automated mining vehicles, industrial automation and similar applications).

The Cisco FM4500 Mobi is configured as a multiple input/multiple output (MIMO) 2x2 radio transceiver. In a 2x2 scenario, two separate spatial streams are transmitted by one transceiver unit, and are available to be re-combined by the radio chipset of a second transceiver unit.

### *Unit function and throughput speed*

The unit is designed to handle mission-critical video, voice, and data with extremely high reliability. It can be used to create point-to-point or mesh network links, with real throughput of up to 500 Mbps to vehicles travelling at up to 225 mph (360 Km/h), under optimal wireless link conditions.

### *Data throttling*

The unit's FluidThrottle functionality allows you to specify the maximum amount of data throughput the unit will be required to handle at any time. The unit's throughput capacity can be upgraded to different levels using software plug-ins.

### *MPLS protocol*

Two different Multi-Protocol Label Switching (MPLS)-based protocol versions can be chosen. If a newer network is being built or upgraded, the advanced Prodigy 2.0 protocol can be selected to boost performance. If an older network incorporating Fluidmesh components is being upgraded, the Prodigy 1.0 protocol with limited functionality can be selected to guarantee compatibility. Prodigy uses a traffic optimization algorithm that allows every Fluidmesh radio to assign a specific priority level to every forwarded data packet.

### *Unit configuration*

The unit is compatible with Fluidmesh RACER™. This is a centralized, web-based interface that allows you to configure, monitor, and troubleshoot the unit (and in certain cases, the entire wireless network) in real time, without the need for any offline software. In cases where an initial connection cannot be made to the internet, the unit can be configured using a built-in offline Configurator interface.

### *Environmental rating*

The unit is certified for outdoor usage, equipped with vibration-proof connectors, and designed for fast installation and enhanced reliability in harsh environments.

### *Product specifications*

For detailed product specifications, refer to the product data sheet for the Cisco FM4500 Mobi.

### *Transceiver and gateway unit power consumption*

In service, Fluidmesh transceiver units and gateway units consume electrical power at the rates given in the table below.



**IMPORTANT**

In service, transceiver and gateway units will consume power at various levels between the quoted lower limit and upper limit, depending on data traffic load, signal strength, environmental conditions such as line-of-sight and atmospheric moisture, and other factors.

Note that the power consumption of transceiver units tends to be affected in inverse proportion to the unit temperature (in other words, power consumption tends to rise when the temperature of the unit falls, and the other way around).

**Table 1. Power consumption figures (transceiver units)**

Unit series	Minimum power consumption	Nominal power consumption (typical conditions)	Maximum power consumption (realistic system-design assumption)
<b>FM Ponte kit</b> (Model FM1200V-HW)	4 Watts	6 to 7 Watts	10 Watts
<b>FM1200 Volo</b> (Model FM1200V-HW)	4 Watts	6 to 7 Watts	10 Watts
<b>FM1300 Otto</b>	8 Watts	10 to 12 Watts	15 Watts
<b>FM3200-series</b> (Model FM3200)	4 Watts	6 to 7 Watts	10 Watts
<b>FM4200-series</b> (Models FM4200F and FM4200)	4 Watts	6 to 7 Watts	10 Watts
<b>FM3500 Endo</b> (Model FM3500)	8 Watts	10 to 12 Watts	15 Watts
<b>FM4500-series</b> (Models FM4500F and FM4500)	8 Watts	10 to 12 Watts	15 Watts
<b>FM 4800 Fiber</b>	13 Watts	15 to 17 Watts	20 Watts

**Table 2. Power consumption figures (gateway units)**

Unit	Maximum power consumption (realistic system-design assumption)
<b>FM1000 Gateway</b>	60 Watts
<b>FM10000 Gateway (Gen. 1)</b>	275 Watts (redundant AC power supply) 250 Watts (non-redundant AC power supply)
<b>FM10000 Gateway (Gen. 2)</b>	300 Watts (redundant AC power supply)

## 3.2. Fluidmesh architecture

### 3.2.1. Overview

#### *Wireless network architectures*

Depending on the network design and the type of components used, the Cisco FM4500 Mobi can be used to create wireless network architectures, including:

- Point-to-point (P2P) links.
- Mesh networks.
- Mobility networks.
- Mixed networks that are capable of using any combination of types listed above.

### 3.2.2. Fluidmesh technologies

#### *Prodigy*

Prodigy is Fluidmesh's proprietary implementation of the Multi-Protocol-Label-Switching (MPLS) standard.



#### **IMPORTANT**

A Fluidmesh device only features Prodigy selection if the installed Prodigy engine includes the selection feature.

Fluidmesh devices that are designed to operate exclusively in *Bridge Mode* (in other words, point-to-point configuration) do not feature Prodigy.

Prodigy 2.0 offers greatly improved performance compared to Prodigy 1.0. New features include:

- Fluidity (through software plug-ins)
- Traffic engineering
- Advanced Quality of Service (QoS)

Note that Prodigy 2.0 is only compatible with device firmware versions 6.5 and higher.



**IMPORTANT**

Prodigy 1.0 and Prodigy 2.0 are **not** compatible with each other. Do not implement the two protocol versions within the same network.

If you are expanding an existing network using new Fluidmesh hardware components, make sure that all components are compatible with each other by:

1. Upgrading all network components within the same network to firmware version 6.5 or higher, and:
2. Configuring all network components within the same network to operate using *either* Prodigy 1.0 or Prodigy 2.0.

Use of Prodigy 1.0 is only recommended if the network contains older Fluidmesh devices that are not compatible with Prodigy 2.0.

Select the Prodigy version you need by using the *General Mode* page of the Configurator interface.

### Fluidity

Fluidity is the proprietary track-side and vehicle-to-ground data transfer protocol developed by Fluidmesh.

Fluidity supports video, voice and data communication, ensuring usable throughput of up to 500 Mbps for high-speed railway trains and other vehicles capable of traveling at up to 225 mph or 360 Km/h (under optimal wireless link conditions).

For detailed information on the operational concepts, and instructions on how to configure Fluidity, refer to the *Fluidmesh Networks Fluidity Configuration Manual*.

### FM Racer

RACER™ is Fluidmesh's web-based configuration portal. It is the primary interface with which to configure Fluidmesh radio devices.

You can operate FM Racer using any internet-connected computer with a web browser.



**IMPORTANT**

For a detailed description of the differences between FM Racer and the local Configurator interface, refer to [“Device configuration using the configurator interface” \(page 45\)](#).

### 3.2.3. Point-to-point wireless bridge

A point-to-point wireless bridge allows two local networks to communicate with each other. A simplified example is shown in [Figure 1 \(page 17\)](#).



In context of the overall network architecture, the two local networks are called *network segments*.

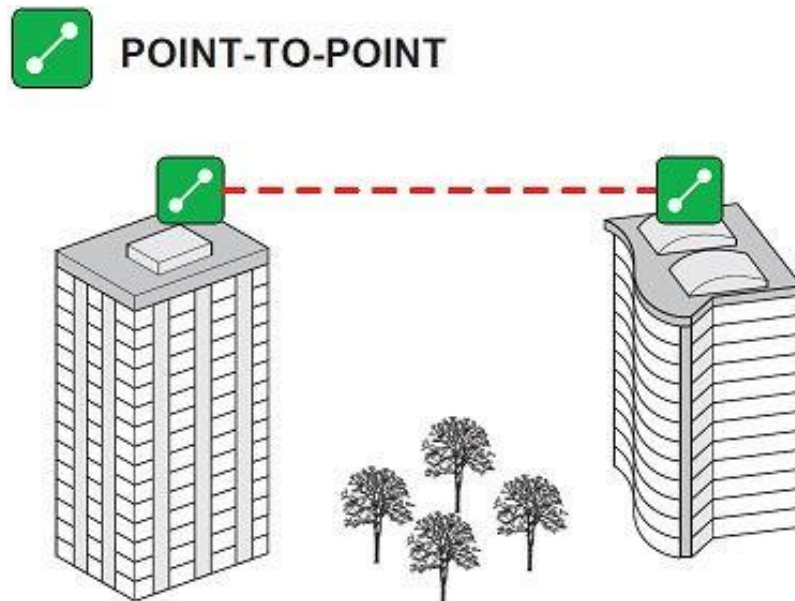

**Figure 1. Point-to-point network architecture**

All network activity that takes place on wireless bridges is 'transparent' to the network hosts. In other words, a wireless bridge forwards packets from one network segment to another according to a 'Forwarding table'. The forwarding table is built by learning the network topology from analysis of incoming traffic.

In this configuration, no explicit interaction takes place between the wireless bridge and the network hosts. The network segments on either side of the wireless bridge share the same IP subnet. Therefore, each network host must use a unique IP address within the subnet.

### 3.2.4. Mesh network architecture

Fluidmesh Networks offers wireless networking solutions that are based on the *mesh networking* architecture, but can also fill more traditional networking roles if needed. This allows substantial reliability and flexibility advantages when compared to traditional wireless solutions.

A simplified example of a wireless mesh network is shown in [Figure 2 \(page 18\)](#). In such a network, every Fluidmesh hardware component transmits the data packets that come from the components directly linked to it.

In a reliable mesh network with an acceptable amount of redundancy, every stream of data packets may reach the base station through any of a variety of paths. The Cisco FM4500 Mobi is designed to act as an 'intelligent router' that is able to forward packets coming from other

Fluidmesh components in real time, based on an optimal, software-determined path. In addition, the absence of any single point of failure greatly increases reliability when compared to any other wireless or wired data-transmission technology.

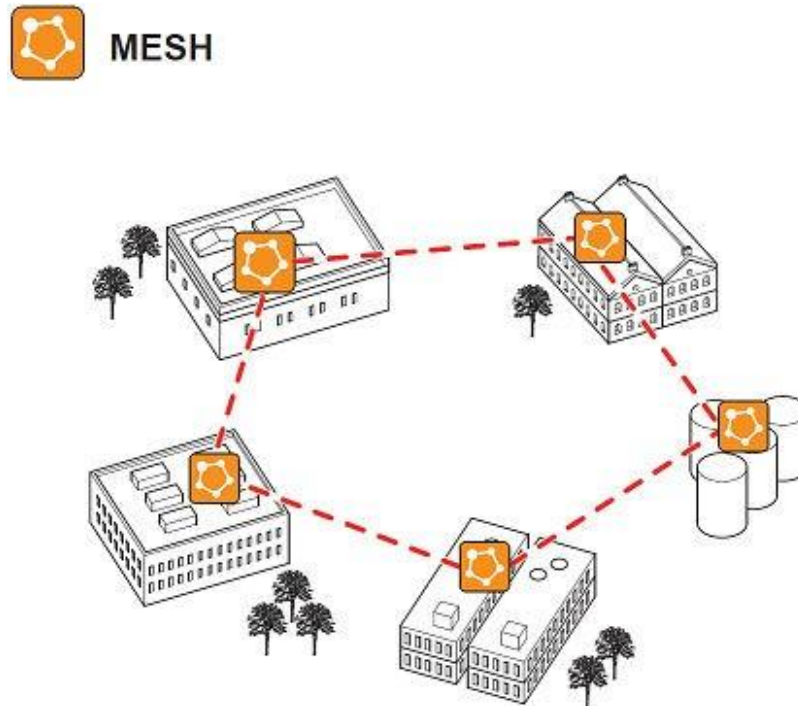

**Figure 2. Fluidmesh Mesh Networking Architecture**

### 3.3. Fluidmesh Network Addressing

#### 3.3.1. Bridge IP addressing

If needed, the Cisco FM4500 Mobi can be operated in *Bridge mode*. This creates a single point-to-point connection between two network segments. A simplified example of a Bridge mode connection is shown in [Figure 3 \(page 19\)](#).

As shipped from the factory, the wired ethernet ports of all Fluidmesh hardware components are assigned the same default IP address of **192.168.0.10/24**.

No default IP address is associated with the wireless interface.



192.168.0.10 is the default IP address of all Fluidmesh Radios.  
It is recommended to change the IP address of both units

**Figure 3. Wireless network architecture (bridge configuration)**

### 3.3.2. Unit identification and addressing

#### Mesh- and bridge-capable radio transceiver identification



#### CAUTION

This section contains theoretical explanations of the underlying concepts behind mesh network addressing, and is intended for use by qualified network engineers only.

- For specific instructions on Fluidmesh hardware installation, see [“Hardware installation” \(page 27\)](#).
- For specific instructions on how to configure a Fluidmesh radio transceiver unit using the configurator interface, see [“Device configuration using the configurator interface” \(page 45\)](#).

Regardless of its configuration and operating mode, every Fluidmeshradio transceiver is shipped from the factory with a unique unit identification (ID) number. This number always takes the following form:

#### 5.a.b.c

The triplet a.b.c uniquely identifies the individual physical hardware unit, and cannot be changed.

The unit ID number is used to identify the physical hardware units within the configurator interface that is used for configuration of the unit.

A simplified diagram demonstrating the relationship between a wired LAN, and a linked mesh radio network containing a mesh end unit and mesh point units, is shown in [Figure 4 \(page 20\)](#).

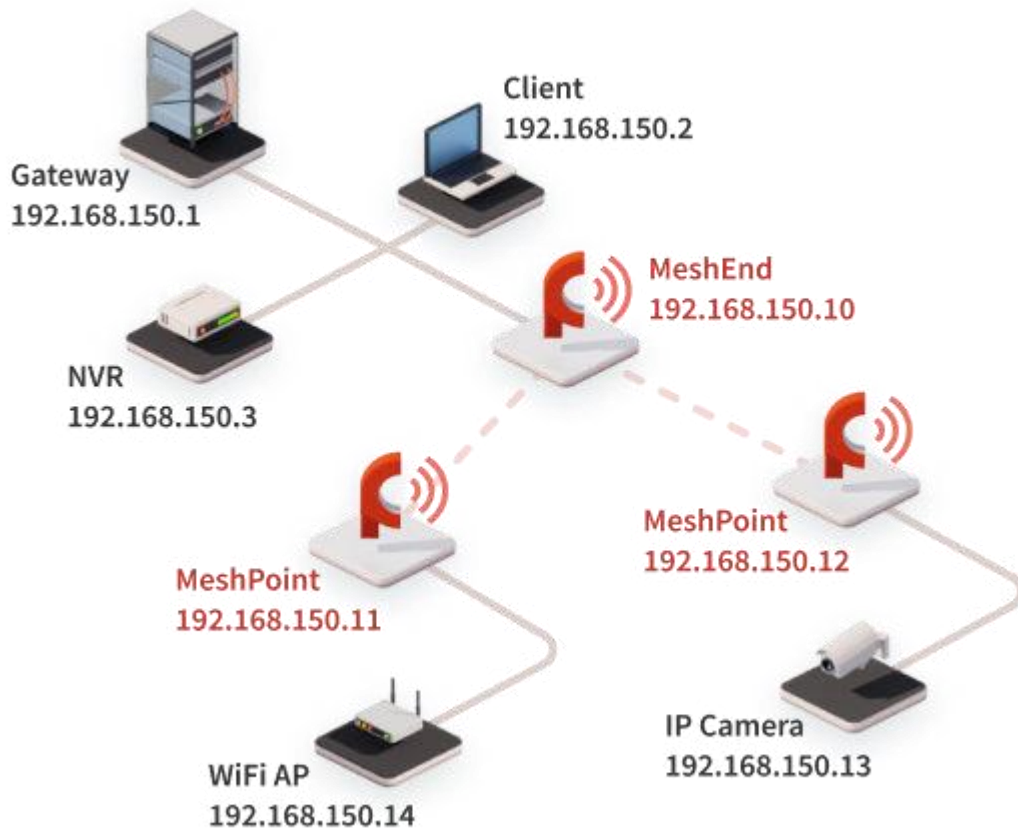

**Figure 4. Fluidmesh Network Addressing**

*Operating the unit in Mesh Point mode or Mesh End mode*

If the Cisco FM4500 Mobi radio transceiver unit is installed as part of a mesh network architecture, it can be set to operate in either of two operating modes:

- **Mesh Point Mode:** This is the default operating mode. Each radio transceiver unit that is part of the network, but is **not** connected to the wired LAN backbone, must be set in **Mesh Point** mode.
- **Mesh End Mode:** Each radio transceiver unit that is part of the network and **is** connected to the wired LAN backbone must be set in **Mesh End** Mode. A Mesh End transceiver unit is always the junction point between the wireless network and any IP-based wired network.

## Network addressing

### Fluidmesh radio transceivers

Fluidmesh data link layer (layer 2) addressing allows you to configure each Cisco FM4500 Mobi transceiver unit, and each IP device connected to the unit, according to the IP address class used in the private LAN to which the **Mesh End** unit is connected.

Each Fluidmesh radio transceiver unit has a factory-set IP address of **192.168.0.10**, and a Netmask of **255.255.255.0**.



#### NOTE

Each individual Fluidmesh radio transceiver unit has a factory-set *5.a.b.c* Mesh identification number. Each unit is shipped from the factory with the same IP address, but with a unique Mesh identification number.

When a Fluidmesh wireless network is connected to a wired LAN, the LAN is usually the private control room LAN. Therefore, Fluidmesh radio transceivers, and all other edge devices that connect the wireless network to the wired LAN, must be assigned individual LAN IP addresses that are part of the same subnet. The edge devices will be accessed using those IP addresses.

A typical network configuration (*Fluidmesh Network Addressing*) is shown in [“Operating the unit in Mesh Point mode or Mesh End mode” \(page 20\)](#). In this configuration, the private LAN IP address class is 192.168.150.0, with netmask 255.255.255.0. Note that each device has an IP address belonging to this subnet.



#### IMPORTANT

IP addresses must not be duplicated within a network. If addresses are duplicated, IP address conflicts will occur.

Multiple Fluidmesh radio transceiver units can be connected through a network switch, forming radio clusters. The proprietary routing protocol will run automatically on the wired part of the network. To activate the cluster feature, transceiver units that are capable of being set in **Mesh Point** mode must be set in that mode.

### Connecting and configuring an Ethernet edge device

Ethernet edge devices such as IP cameras and Wi-Fi access points can be connected to the Ethernet ports of the Cisco FM4500 Mobi. Such edge devices must be configured using the IP subnet scheme defined for the broadcast domain.

The default *IP subnet mask* for all Fluidmesh devices is *192.168.0.0 / 255.255.255.0*.

The default *IP address* for all Fluidmesh devices is *192.168.0.10 / 255.255.255.0*.

You can configure any Ethernet device manually or automatically, using a DHCP server that resides on the LAN network. The Fluidmesh network is totally transparent to DHCP, therefore, DHCP requests and responses can be forwarded transparently across the network.



#### IMPORTANT

If an Ethernet-based system using multiple peripheral components is connected to the wireless network, assign each peripheral component a fixed IP address. If dynamic IP addressing is used, the components may not be accessible to third-party software that relies on the components for data input.

A typical example is a video surveillance system equipped with multiple CCTV cameras. Each camera must be assigned a fixed IP address to be accessible to the video-recording software.

#### *Fluidmesh radio transceivers*

A wide variety of Ethernet edge devices, such as IP cameras and Wi-Fi access points, can be connected to the Ethernet ports of the Cisco FM4500 Mobi. You can configure any Ethernet device manually or automatically by using a DHCP server that resides on the LAN network.

The Fluidmesh network is totally transparent to DHCP. Therefore, DHCP requests and responses can be forwarded transparently across the network.



#### IMPORTANT

If a video surveillance system is connected to the wireless network, assign each camera a fixed IP address. If dynamic IP addressing is used, the cameras may not be accessible to the video-recording software.

## 4. Installing the radio

### 4.1. Installing the radio using tie-wraps or hose clamps

To install the radio transceiver on a wooden or metal utility pole using tie-wraps or metal hose clamps, do the following steps:

1. Decide where on the utility pole the radio must be mounted, taking access to the radio and line-of-sight into account.
2. Place the radio against the utility pole at the chosen mounting point (below).

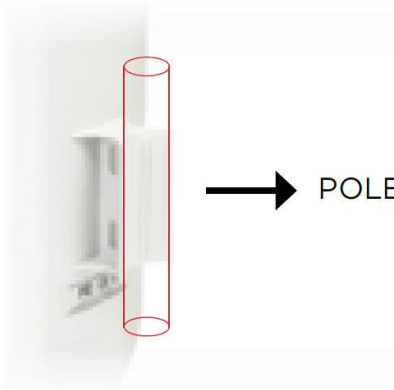

3. Route the two tie-wraps or metal hose clamps through the clamp holes of the radio's mounting lug (below).

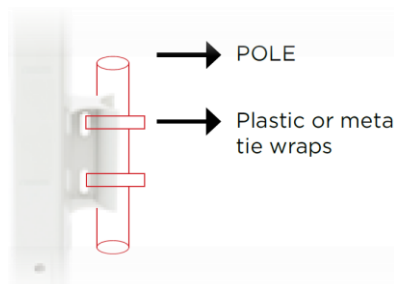

4. Join the ends of the tie-wraps or metal hose clamps. Tighten the tie-wraps or clamps just enough that the radio can be easily moved in the horizontal plane.
5. Aim and adjust the radio correctly. You can aim the unit in the horizontal plane only.
6. Tighten the tie-wraps or hose clamps until the radio assembly is secure.

## 4.2. Installation on a DIN rail

All FM3200-series, FM4200-series, FM3500 Endo, FM4500-series and FM4800 Fiber transceivers are capable of being mounted on DIN rails (DIN-standardized metal rails widely used for mounting circuit breakers and industrial control equipment on equipment racks). To do this, the DIN mounting plate included with the transceiver unit must be installed.

To install the included DIN mounting plate on the radio transceiver unit, do the following steps:

1. Place the transceiver unit on a flat surface so that the unit's mounting lug faces upward.
2. Place the included DIN mounting plate over the plate mounting holes (below). Note that a FM4500 Mobi radio is shown for demonstration.



### IMPORTANT

Note the orientation of the DIN mounting plate in relation to the radio (above). The folded end of the plate faces *upward and away* from the unit's mounting lug.

3. Screw the DIN mounting plate to the main body of the transceiver using the supplied machine screws (below).





To mount the transceiver unit on a DIN rail, do the following steps:

1. Align the transceiver unit with the DIN rail so that the folded end of the DIN mounting plate is in line with the DIN rail.
2. Gently press the transceiver unit backward and downward, so that the DIN mounting plate slots onto the DIN rail.

### 4.3. Installation using the sliding bracket

All FM3200 Endo, FM3500 Endo, FM4200-series, FM4500-series and FM4800 Fiber transceivers can take advantage of quick-release installation if they are installed using the sliding bracket (part number *FM- BRKT- SLIDING*).



#### TIP

To install the unit on a concrete or brick wall, or on a wooden structure, the procedure in this section can be modified by substituting appropriately-sized wall plugs or self-tapping wood screws for high-tensile screws.

To mount the unit on a metal backing plate (not included), you will need the following:

- 4x M3x8 high-tensile countersunk screws.
- An appropriately-sized metal backing plate, drilled and tapped for the mounting hole pattern as the sliding bracket.

To install a transceiver unit on a metal backing plate, do the following steps:

1. Decide where on the wall the unit must be mounted, taking access to the unit into account.
2. Place the backing plate against the wall.
3. The backing plate will have four holes. Mark the locations of the four holes on the wall using chalk, a carpenter's pencil or similar.
4. Install the backing plate on the wall, using the appropriate method. Note the orientation of the mounting holes on the backing plate.
5. Using the M3x8 countersunk screws, screw the sliding bracket onto the backing plate with the safety catchment portion facing *downward* (below).

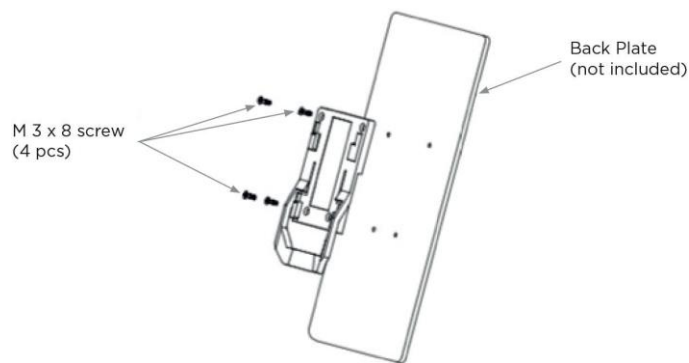

6. Slide the radio unit downward into the mounting bracket, in such a way that the mounting lug on the back of the radio engages the mounting bracket. Note that the antenna terminals of the radio unit must face *up* (below).

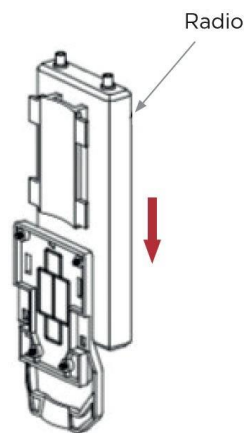

## 5. Hardware installation

### 5.1. Fluidmesh Hardware Installation

#### 5.1.1. Installing the Cisco FM4500 Mobi

##### *Environmental rating and unit roles*

The Cisco FM4500 Mobi (model number FM4500) is a wireless radio transceiver unit.

The hardware is contained in an outdoor-rated metal enclosure that can be easily mounted on poles or walls.

The Cisco FM4500 Mobi can operate in any of the following networking roles:

- As a point-to-point wireless bridge (see [“Point-to-point wireless bridge” \(page 16\)](#) for details).
- As a single radio unit within a wireless mesh network (see [“Mesh network architecture” \(page 17\)](#) for details).

##### *Installation hardware*

Metal clamps are supplied as part of the installation package, to allow mounting of the unit on utility poles. Refer to the Cisco FM4500 Mobi installation instructions for details.

#### 5.1.2. Cisco FM4500 Mobi Status and link LEDs

##### *Unit and link quality status*

The front panel of the Cisco FM4500 Mobi (as seen below) contains seven LEDs. The panel is used to check the unit status and wireless link quality status.

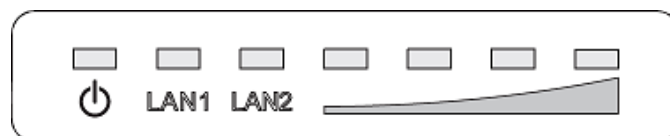

**Figure 5. Status and link/boot LEDs**

During normal operation, the seven LEDs indicate the following conditions:

- **Power:** The Cisco FM4500 Mobi is receiving power.
- **LAN1:** Network activity on Ethernet port 1.
- **LAN2:** Network activity on Ethernet port 2.

- **SIGNAL STRENGTH (red):** Signal strength very poor.
- **SIGNAL STRENGTH (yellow):** Signal strength inadequate.
- **SIGNAL STRENGTH (green):** Signal strength acceptable.
- **SIGNAL STRENGTH (green):** Signal strength excellent.

**TIP**

During normal operation, the readings from the four **SIGNAL STRENGTH** LEDs can be used to do radio antenna alignment (see [“Antenna-alignment tools and physical statistics”](#) (page 71) for more information).

### Boot sequence

During the unit's boot sequence, the four **SIGNAL STRENGTH** LEDs light up in sequence. During the boot sequence, the LEDs indicate the following conditions:

1. **Red:** Core system boot in progress.
2. **Yellow:** Wireless system boot in progress.
3. **First green:** Routing engine boot in progress.
4. **Second green:** Unit configuration boot in progress.

If the boot sequence above stops at any LED, an error has been detected during that stage of the boot sequence.

### 5.1.3. Supplying power to the Cisco FM4500 Mobi

**CAUTION**

When connecting the Cisco FM4500 Mobi to a power supply, be sure to follow the instructions in this section at all times.

Failure to follow these instructions may result in irreparable damage to the unit and/or other connected hardware, and will also invalidate the product warranty.



**IMPORTANT**

The radio transceiver package does *not* include a DC IN power source (devices capable of accepting DC IN power only), a PoE injector, or a powered Ethernet switch. A suitable power source must be ordered separately.

For technical data on which power sources are compatible with the Cisco FM4500 Mobi, refer to [“Electrical power requirements”](#) (page 155).

The Cisco FM4500 Mobi can be provided with power using the following methods:

- A compatible 48 Vdc passive PoE injector conforming to [IEEE 802.3at](#).



**CAUTION**  
Do not connect any PoE injector conforming to [IEEE 802.3af](#) to the unit.

Such injectors have a higher voltage variance than the design specification of the unit allows for, and may result in unreliable performance.

- A 48 Vdc power source equipped with an M12A connector.

When providing the power source for the Cisco FM4500 Mobi, remember the following important points:

- Install the power source as close to the unit as possible to minimize voltage drop. The maximum suggested distance is 165ft (50m).

### Connecting power to the Cisco FM4500 Mobi



**NOTE**  
For detailed comparative information on which Fluidmesh hardware devices are capable of accepting power through IEEE 802.3at or IEEE 802.3af power sources, or through a DC IN power source, refer to [“Electrical power requirements” \(page 155\)](#).

### DC IN, LAN1/POE and LAN2 ports

The Cisco FM4500 Mobi radio transceiver unit has three connector ports ([Figure 6 \(page 29\)](#)):

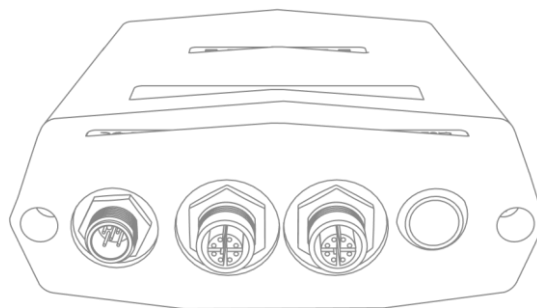

**Figure 6. Device connector ports**

- The **DC IN** connection (left-most connector) is a 5-pin M12A port, exclusively designed to accept passive 48 Vdc power.
- The **LAN2** connection (middle connector) is an 8-pin M12X port, exclusively designed to connect the unit to a local area network (LAN) switch.

- The **LAN1/POE** connection (right-most connector) is an 8-pin M12X port, designed to connect the unit to a local area network (LAN) switch and/or to an IEEE 802.3 48 Vdc power source.

 **IMPORTANT**  
The Cisco FM4500 Mobi can accept power from a power source conforming to *IEEE 802.3at* ONLY.

#### 5.1.4. Rebooting the firmware and resetting the unit to factory defaults

The Cisco FM4500 Mobi hardware can be rebooted and reset to factory default condition using the procedures in this section.

 **IMPORTANT**  
The following procedure shows how to do a 'hard' (device firmware) reboot. To do a 'soft' (device software) reboot, refer to [“Resetting the unit to factory defaults” \(page 137\)](#).

To do a 'hard' (device firmware) reboot under emergency conditions (for example, if the unit malfunctions), do the steps in the following sub-section.

#### Device firmware reboot

- Press the **RESET** button on the bottom cover of the unit ([Figure 7 \(page 30\)](#)) for one second, then release the button immediately.

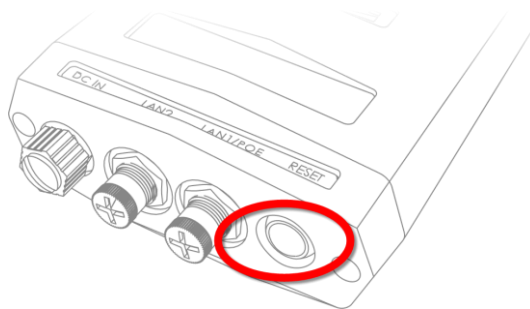

**Figure 7. Cisco FM4500 Mobi (Hardware RESET button)**

- The unit will reboot.

## Resetting the unit to factory settings



### CAUTION

Do not do a factory reset unless the unit needs to be reconfigured using its factory configuration as a starting point.

A factory reset will reset the unit's IP address and administrator password, and will disconnect the unit from the network.

The following methods are available to do a factory reset:

1. To do the reset using the offline Configurator interface, refer to [“Resetting the unit to factory defaults” \(page 137\)](#).
2. To do the reset using FM Racer, refer to the *Fluidmesh Networks FM Racer User Manual*.
3. To do the reset by physically accessing the unit, follow the procedure below.

To reset the radio to its factory default settings, do the steps that follow:

1. Power ON the unit.
2. Wait approximately 40 seconds for the unit to boot up.
3. When the unit has completed its boot sequence, press the **RESET** button for 7 seconds.
  - The LEDs will blink.
  - The unit will be restored to factory default settings (including its default IP address of **192.168.0.10** and subnet mask of **255.255.255.0**).
  - The unit will reboot.
  - The administrator user name and password will both be reset to **admin**.

### 5.1.5. Suitability for outdoor installation

The Cisco FM4500 Mobi was specifically designed for installation in harsh outdoor environments. Under operating conditions, the unit is completely sealed, and is capable of high-performance operation in outdoor environments, and under severe conditions such as water spray, salt, and extreme fluctuations in cold and heat.

The Cisco FM4500 Mobi has successfully passed stringent environmental certification tests, including European Committee for Standardization [EN 50155](#) (electronic equipment used on rolling stock for railway applications) and [EN 45545](#) (fire protection on railway vehicles) tests.

Examples of specific certification tests included:

- Verification of resistance to salt water intrusion and corrosion. This consisted of subjecting the unit to running, high-pressure salt water for 24 hours, followed by a 24-hour drying time. The unit was then

carefully examined to verify that no corrosion or water ingress were found.

- Verification of resistance to fluctuating temperatures. This consisted of placing the unit in a climatic chamber and subjecting it to operating ranges between -40°C and 80°C, for four hours.

## 5.2. Connecting the Fluidmesh Cisco FM4500 Mobi to a network and antennas

### 5.2.1. Terminal assignments for power and data connectors



#### IMPORTANT

Always use outdoor-rated, RF-shielded Ethernet cables when connecting the Power and LAN ports of a Fluidmesh hardware device to external hardware.

#### M12 A-coded

This section describes the terminal assignments for M12 A-coded connectors equipped with five pins (power only) and with eight pins (power and data).

#### M12 A-coded (five-pin)

The terminal assignments for female M12 A-coded five-pin connectors are as follows:



**Terminal 1:** V1+ (Brown wire)



**Terminal 2:** Not used

**Terminal 3:** V1- (Blue wire)

**Terminal 4:** Not used

**Terminal 5:** Ground / Earth (Gray wire)



**NOTE**  
The radio transceiver does not make use of a dual-redundant power supply. Therefore, terminals 2 and 4 are not used.

*M12 A-coded eight-pin (pre-September 2016 only)*

Female M12 A-coded eight-pin connectors (below) are used only on Fluidmesh Cisco 4200-series and Cisco 4500-series units manufactured before September 2016.

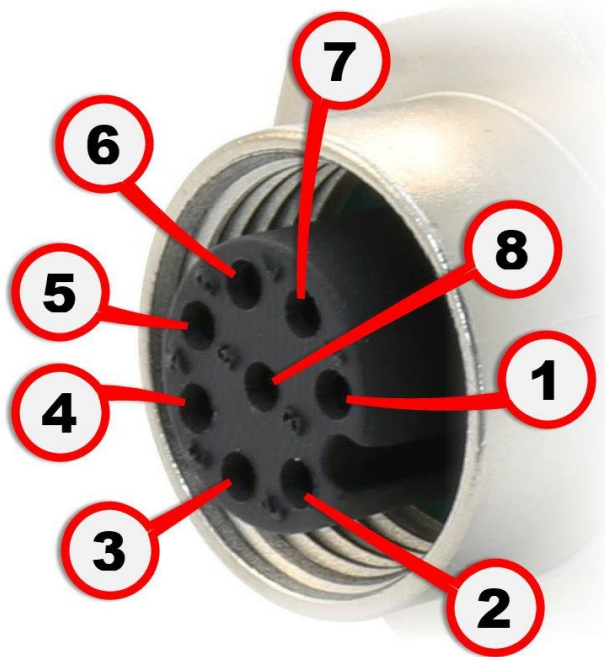

When splicing a female M12 A-coded eight-pin connector to one end of an Ethernet cable, and a male RJ45 Ethernet connector to the other end of the Ethernet cable, the terminal assignments are as follows:

- **Terminal 1** of M12A (Blue wire with white tracer) to **terminal 5** of RJ45.
- **Terminal 2** of M12A (Brown wire with white tracer) to **terminal 7** of RJ45.
- **Terminal 3** of M12A (Brown wire) to **terminal 8** of RJ45.
- **Terminal 4** of M12A (Orange wire) to **terminal 2** of RJ45.

- **Terminal 5** of M12A (Green wire with white tracer) to **terminal 3** of RJ45.
- **Terminal 6** of M12A (Orange wire with white tracer) to **terminal 1** of RJ45.
- **Terminal 7** of M12A (Blue wire) to **terminal 4** of RJ45.
- **Terminal 8** of M12A (Green wire) to **terminal 6** of RJ45.

When splicing a female M12 A-coded eight-pin connector to one end of an Ethernet jumper cable, and a male M12 X-coded connector to the other end of the Ethernet jumper cable, the terminal assignments are as follows:

- **Terminal 1** of M12A (Blue wire with white tracer) to **terminal 7** of M12X.
- **Terminal 2** of M12A (Brown wire with white tracer) to **terminal 5** of M12X.
- **Terminal 3** of M12A (Brown wire) to **terminal 6** of M12X.
- **Terminal 4** of M12A (Orange wire) to **terminal 2** of M12X.
- **Terminal 5** of M12A (Green wire with white tracer) to **terminal 3** of M12X.
- **Terminal 6** of M12A (Orange wire with white tracer) to **terminal 1** of M12X.
- **Terminal 7** of M12A (Blue wire) to **terminal 8** of M12X.
- **Terminal 8** of M12A (Green wire) to **terminal 4** of M12X.

### *M12 X-coded*

M12 X-coded connectors are used on all Fluidmesh Cisco 4200-series and Cisco 4500-series units manufactured after September 2016.

When splicing a male M12 X-coded connector to one end of an Ethernet cable, and a male RJ45 Ethernet connector to the other end of the Ethernet cable, the terminal assignments are as follows:



- **Terminal 1** of M12X (Orange wire with white tracer) to **terminal 1** of RJ45.
- **Terminal 2** of M12X (Orange wire) to **terminal 2** of RJ45.
- **Terminal 3** of M12X (Green wire with white tracer) to **terminal 3** of RJ45.
- **Terminal 4** of M12X (Green wire) to **terminal 6** of RJ45.
- **Terminal 5** of M12X (Brown wire with white tracer) to **terminal 7** of RJ45.
- **Terminal 6** of M12X (Brown wire) to **terminal 8** of RJ45.
- **Terminal 7** of M12X (Blue wire with white tracer) to **terminal 5** of RJ45.
- **Terminal 8** of M12X (Blue wire) to **terminal 4** of RJ45.

### 5.2.2. Connecting a DC IN power source to the unit



#### NOTE

If the unit must be powered using an IEEE 802.3at-compliant network switch or PoE injector, disregard this section and proceed to [“Connecting LAN cables to the unit” \(page 36\)](#).

When the Cisco FM4500 Mobi is mounted in its final location, connect the unit to a 48V DC IN power supply by doing the following steps:

1. Only use a power cable that terminates in an M12A connector to connect the power source to the unit.
2. Make sure that the terminal pin assignments for the M12A plug comply with the accepted standard for M12A connectors.

Next, proceed to the steps in the following table:

<p><b>3.</b> Remove the protective plastic cover from the port labelled <b>DC IN</b>.</p>	<p><b>4.</b> Wrap PTFE thread-sealing tape around the threads of the M12A connector on the unit. Use enough tape to ensure a watertight seal.</p> <p><b>5.</b> Insert the M12A connector leading from the power source into the port labelled <b>DC IN</b>.</p> <p><b>6.</b> Screw the threaded sleeve of the male connector onto the female connector. Tighten the connection by hand.</p>

### 5.2.3. Connecting LAN cables to the unit

#### M12X LAN cables



**IMPORTANT**

If a local area network (LAN) connection must be made to the unit *and* the unit must be powered using a compatible network switch or PoE injector, follow the instructions in this section.

If non-powered local area network (LAN) connections must be made to the unit through *both* LAN ports, follow the instructions for connecting the LAN cables as shown in this section. Then, connect a 48V DC IN power supply to the unit as shown in [“Connecting a DC IN power source to the unit” \(page 35\)](#).

When the Cisco FM4500 Mobi is mounted in its final location, connect the unit to LAN connection(s) and/or a PoE power supply by doing the following steps:

1. Only use a shielded CAT5/6 cable that terminates in an M12X connector to connect any LAN cable to the unit.
2. Make sure that the terminal pin assignments for the M12X plug(s) comply with the accepted standard for M12X LAN/PoE connectors.

Next, proceed to the steps in the following table:

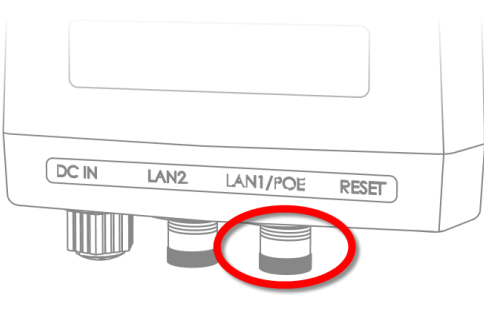
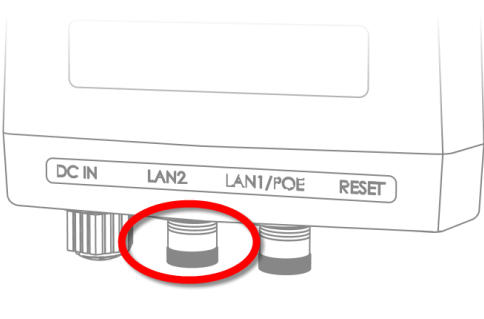
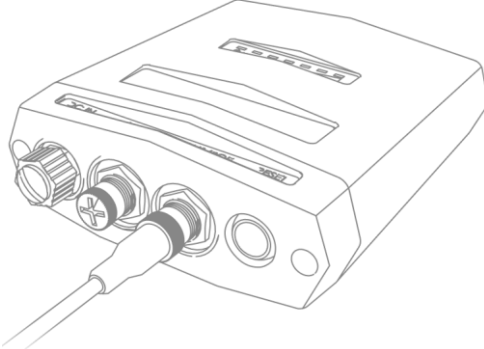
	
<p><b>3. Remove LAN port covers as follows:</b></p> <ul style="list-style-type: none"> <li>• If connecting a Gigabit LAN/power-over-Ethernet connection to the unit, remove the protective plastic cover from the port labelled <b>LAN1/POE</b>.</li> </ul>	<ul style="list-style-type: none"> <li>• If connecting a service LAN to the unit, remove the protective plastic cover from the port labelled <b>LAN2</b>.</li> </ul>
	
<p><b>4.</b> Wrap PTFE thread-sealing tape around the threads of the exposed M12X connector(s) on the unit. Use enough tape to ensure a watertight seal.</p> <p><b>5.</b> Insert the correct M12X connector(s) leading from the local LAN hardware into the <b>LAN1/POE</b> port and, if needed, the <b>LAN2</b> port.</p> <p><b>6.</b> Screw the threaded sleeves of the female connectors onto the male connectors. Tighten the connections by hand.</p>	

## 5.2.4. Connecting the antennas to the Cisco FM4500 Mobi

### *QMA antenna connections*



#### **IMPORTANT**

The FM4500 Mobi is ingress-protection rated to standards specified by EN 50155 and EN 45545.

To ensure the FM4500 Mobi remains waterproof and dustproof, follow all instructions in this section.

Following the instructions in this section will also ensure that the FM4500 Mobi is well prepared for any ingress-protection testing.

Radio antennas are connected to the Cisco FM4500 Mobi using quick-disconnect sub-miniature version A (QMA) connectors.



#### **WARNING**

Before activating the unit, make sure that all RF feeds are securely connected to an appropriate antenna. Never activate any transceiver unit that is not connected to an antenna.

Fluidmesh uses copper-tin-zinc-plated female QMA connectors. These connectors are capable of corrosion resistance that exceeds the demands imposed by [ASTM B117](#) salt spray testing. The connectors are virtually immune to corrosion, provided that they do not remain in contact with standing salt water for long periods of time.

In the opinion of Fluidmesh engineers, certain brands of QMA plug have shown outstanding performance. We can confidently recommend the following brands:

- Amphenol
- Huber+Suhner
- Rosenberger
- Radiall



#### **CAUTION**

Do not remove the protective rubber sleeves from a female QMA plug (below) if an antenna will not be connected to the plug. Unprotected QMA plug contacts that are exposed to water will oxidize, causing degraded performance.

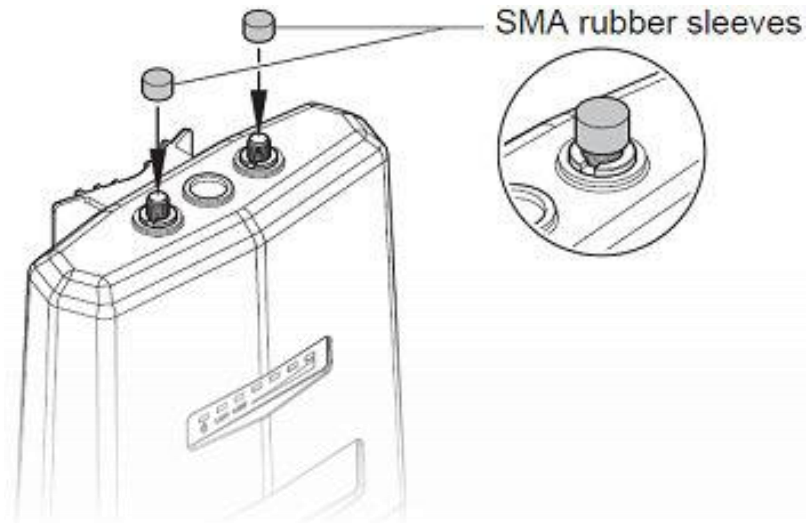
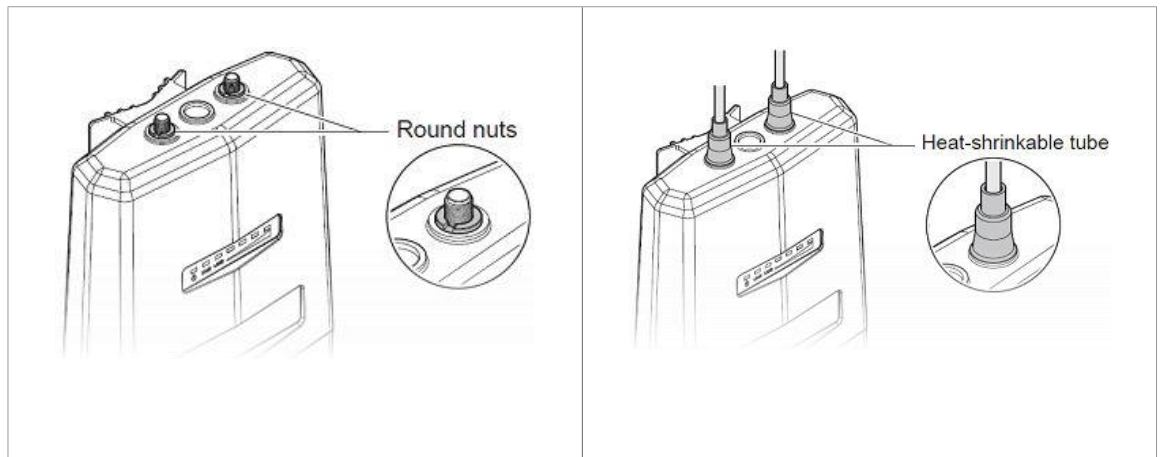

**Figure 8. Protective rubber sleeves**

Connect the antennas to the unit by doing the following steps:

1. The number and types of antennas to be connected to the unit will have been decided at the network design stage. Verify which antenna will be connected to each QMA plug.
2. Only remove the rubber sleeve from a QMA plug (above) if an antenna must be connected to the plug.

Next, proceed to the steps in the following table:



<p><b>3.</b> Check the round, knurled nuts of the QMA connectors for tightness (above). If any round nuts are loose, tighten them by hand only.</p>	<p><b>4.</b> Slide a section of Nylon heat-shrinkable tubing over each unconnected antenna cable (above).</p> <p><b>5.</b> Push the male QMA plug of the antenna cable into the female QMA plug of the unit.</p> <p><b>6.</b> Screw the threaded sleeve of the male plug onto the female plug. Tighten the connection by hand only.</p> <p><b>7.</b> Slide the lengths of Nylon heat-shrinkable tubing over the tightened QMA connectors.</p> <p><b>8.</b> Use a heat gun to shrink the tubing onto the connectors.</p>
---	---



## 6. Using the Fluidmesh Partner Portal

The Fluidmesh Partner Portal is the main web-based portal through which the following activities are done:

1. Participating in Fluidmesh E-learning
2. Using and sharing plug-in license codes for Fluidmesh devices
3. Using the RACER™ radio configuration interface
4. Viewing the technical documentation for your Fluidmesh devices

### 6.1. Accessing the Partner Portal

Access to the Partners Portal is granted only to Fluidmesh's official partners and customers, and requires registration.

To access the Fluidmesh Partner Portal, do the following steps:

1. Make sure a current web browser is installed on your computer. For detailed information on which browsers are supported, refer to [Table 3 \(page 41\)](#) below. If needed, upgrade your browser version.
2. Click [this link](#).
  - The Fluidmesh Partner Portal **Sign In** dialog will be shown.
3. Register as a portal user by clicking the **Create Account** link and following the software prompts.

**Table 3. Supported web browsers**

	Version	Computer operating systems	Compatibility	Reason
Mozilla Firefox	32 to 38	Linux, Windows 7, 8 and 10, OS X Mavericks	Partial	Icons and fonts do not display correctly in position modality
	39	Linux, Windows 7, 8 and 10, OS X Mavericks	Full	-
	40 onward	Linux, Windows 7, 8 and 10, OS X Mavericks	Full	-
Google Chrome	36 onward	Linux, Windows 7, 8 and 10, OS X Mavericks	Partial	Vertical scrolling in unit/template detail does not work correctly
	56 onward	Linux, Windows 7, 8 and 10, OS X Mavericks	Full	-

	Version	Computer operating systems	Compatibility	Reason
Microsoft Internet Explorer	11 onward	Windows 7, 8 and 10	Full	-
Microsoft Edge	13 onward	Windows 7, 8 and 10	Full	-
Apple Safari	8 onward	OS X Yosemite or later	Full	-

## 6.2. Enabling Two-Factor Authentication for security

To enhance cyber-security on the Partner Portal, Fluidmesh uses two-factor authentication (2FA).

2FA works by providing an extra security layer that works independently of your Partner Portal login password. With 2FA activated, you will be asked to provide a secure one-time password (OTP) for each login.

To set up two-factor authentication, do the following steps:

1. Install an app capable of generating authentication codes on your mobile phone. Apps recommended for specific platforms are:
  - **Google Authenticator** or **Authy** (iPhone, Android)
  - **Microsoft Authenticator** (Windows Mobile)
2. Log into the [Fluidmesh Partner Portal](#) using your normal access password.
3. Hover the mouse cursor over the Profile icon in the upper right-hand corner of the web page ([Figure 9 \(page 42\)](#)). Click the **Account** option.

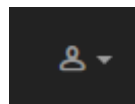

**Figure 9. Partner Portal (Profile icon)**

- Your portal account page will be shown.
4. Click the **Two Factor Auth.** link on the left-hand side of the web page ([Figure 10 \(page 42\)](#)).

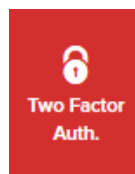

**Figure 10. Partner Portal (Two Factor Auth. icon)**

- The **Two Factor Authentication page** will be shown.
  - The current two-factor authentication status of your portal account will be shown near the top of the page.
5. Click the **Set Up Two Factor Authentication** button.
    - A two-factor authentication dialog will ask to confirm your identity. If the name and E-mail address shown in the dialog are yours, enter your current portal password and click the **Validate identity** button.
  6. An E-mail will be sent to your E-mail address with a verification code in the body of the mail. Enter the verification code in the **Verification code** field of the Two Factor Authentication web page.
    - The Two Factor Authentication web page will show a QR code.
  7. Use the authentication app on your mobile phone to scan the QR code on the web page. [Figure 11 \(page 43\)](#) is a typical example of the QR code you will be shown.



**Figure 11. Two Factor Authentication (typical QR code)**

- The authenticator app will generate an authentication code. Enter this code in the **Authentication code** field of the Two Factor Authentication web page, and click the **Enable Two Factor Authentication** button.
- A list of ten *recovery codes* will be shown on the Two Factor Authentication web page. It is recommended that you save these codes in case you lose your mobile phone. Download the recovery codes as a \*.TXT file by clicking the **Download** button, or print a hard copy of the codes by clicking the **Print** button.

### 6.3. Administering plug-in license codes

The Partner Portal Plug-ins page can be used to do the following tasks:

- Convert plug-in License codes to Activation codes
- Deactivate active plug-in License codes

- Reactivate deactivated plug-in License codes
- Export multiple Activation codes
- Share License codes with other Fluidmesh device users
- Accept shared License codes from other Fluidmesh device users

To do the tasks above, refer to “[Plug-In management](#)” (page 129).

## 6.4. Using the RACER™ radio configuration interface

RACER™ is Fluidmesh's web-based configuration portal. It is the primary interface with which to configure Fluidmesh radio devices.

You can operate FM Racer using any internet-connected computer with a web browser.

To access the FM Racer portal, do the following steps:

1. Log in to the Fluidmesh Partners Portal using your login credentials.
2. Click [this link](#).

For detailed instructions on how to use the FM Racer interface, refer to the *Fluidmesh Networks RACER™ User Manual*.



### IMPORTANT

For a detailed description of the differences between FM Racer and the local Configurator interface, refer to “[Device configuration using the configurator interface](#)” (page 45).

## 6.5. Viewing the technical documentation for your Fluidmesh device

All documentation relating to your Fluidmesh device (such as product brochures, technical data sheets, installation instructions and user manuals) can be found in the Documentation section of the Partner Portal.

To find documentation relating to your Fluidmesh device, do the following steps:

1. Log in to the Fluidmesh Partners Portal using your login credentials.
2. Click [this link](#).
3. All documents are arranged by category. Browse the folders for the documentation you need.

## 7. Device configuration using the configurator interface

Fluidmesh radio devices that are capable of operating as part of a mesh network, including the Cisco FM4500 Mobi, are shipped from the factory in **Mesh Point** mode.

All Fluidmesh radio transceiver devices are shipped with IP address **192.168.0.10**, and Netmask **255.255.255.0**.

The Cisco FM4500 Mobi can be configured by using:

- The RACER™ Radio Configuration interface, or
- The on-board Configurator interface.

The difference between these interfaces is as follows:

*FM Racer* is a centralized, internet-based configuration software platform that is accessed from the Fluidmesh Partner Portal.

- An internet connection must be made between the Fluidmesh device and the FM Racer Cloud Server (an internet-based radio management service).
- Devices can be configured on an *Online* basis only: configuration settings are applied to one or more devices without the need for a configuration (\*.CONF) file, and manual configuration is disabled.
- If devices must be configured on an *Offline* basis (in other words, if the device is not connected to the internet, and therefore cannot access its configuration settings from the FM Racer Cloud Server), a separate configuration file can be uploaded to the device using the Configurator (described below).

The *Configurator* is a localized configuration software platform that resides on the Fluidmesh device.

- Local configuration is done by connecting a computer to the device through a direct hardware connection, or through the internet.
- Using the Configurator, devices can be configured on an *Offline* basis only. A configuration (\*.CONF) file can be manually applied to set the device parameters, or each device parameter can be manually set by the device user.
- Offline configuration settings for more than one Fluidmesh device type can be integrated into a single configuration file. When the configuration file is uploaded to each device, the device automatically loads the correct configuration settings for its device type.

To configure the unit using *FM Racer*, refer to the **Fluidmesh Networks FM Racer User Manual**.

To configure the unit using the *Configurator*, refer to the following subsections.



## IMPORTANT

The FM Racer Radio Configuration interface and command-line interface (CLI) contain device configuration parameters that are not available in the on-board Configurator interface.

Note that some configuration features may not be applicable to your specific Fluidmesh device.

Configuration parameters and control tabs that are exclusive to FM Racer and the CLI include:

- **Project name** (The device has been assigned to the Project listed in this field.)
- **Position** (Shows the current physical location of the unit.)
- **Invoice No.** (Shows the Fluidmesh sales invoice number for the unit.)
- **Shared With** (If responsibility for the unit is shared with other users, the details of the responsible users are shown in this field.)
- **Enable RTS Protection** (FM3500 Endo and FM4500-series transceivers only - shows the unit's current IEEE 802.11 request-to-send (RTS) setting.)
- **Promisc** ('Promiscuous' Mode: Shows the unit's current setting for backwards compatibility with legacy Fluidmesh units that are no longer in production.)
- **Noise floor Calibration** (Shows the unit's current noise floorcalibration setting.)
- **MAX Transmission MCS** (Used to choose the modulation and coding scheme by which the unit automatically chooses its maximum data transmission rate.)
- **TX Power** (Controls the effective isotropic radiated power output of the unit.)
- **Automatic link distance** (Lets the system choose the maximum effective distance between the relevant wireless links.)
- **Ethernet speed** (Selects the correct data exchange speed for each Ethernet port.)
- **FLUIDMESH WI-FI** tab (Allows you to set up a second, segregated Wi-Fi interface that allows technicians access to the unit for configuration and maintenance purposes.)
- **FLUIDITY ADVANCED** tab (Allows you to adjust the load-balancing, handoff and network optimization characteristics of a transceiver unit.)
- **FLUIDITY POLE BAN** tab (Allows you to greatly reduce sudden degradations in bandwidth that happen when a mobile unit approaches, then leaves behind, a static unit.)

- **FLUIDITY FREQUENCY SCAN** tab (Used where mobile Fluidity units are configured with different frequencies.)
- **SPANNING TREE** tab (Allows you to build a logical topology for Ethernet networks, including backup links to provide fault tolerance if an active link fails.)
- **QOS** tab (Contains controls for Quality of Service and Class of Service settings.)
- **MPLS** tab (Contains controls for adjustment of the unit's multiprotocol label switching settings.)
- **FAST FAILOVER (TITAN)** tab (Contains controls to enable fast fail-over capability on networks where backup units are installed.)
- **ARP** tab (Contains controls for Address Resolution Protocol settings used for discovering MAC addresses that are associated with IP addresses.)
- **INTRA-CAR** tab (Contains controls to create and maintain a wireless backbone network throughout physically large, compartmentalized vehicles.)

For a detailed description of the configuration options featured in the FM Racer interface, refer to the *Available configuration parameters* section of the *Fluidmesh Networks FM Racer User Manual*.

## 7.1. Software and hardware prerequisites

To access the Configurator graphical user interface (GUI) and use the Configurator to program the Cisco FM4500 Mobi, you need the following:

- A desktop, laptop or tablet computer equipped with:
  - Any current web browser. For a list of compatible web browsers, refer to the *Supported web browsers* table in “[Using the Fluidmesh Partner Portal](#)” (page 41).
  - Any Microsoft Windows, Mac OS or Linux operating system.
  - An integrated Ethernet port.
- A CAT5/6 Ethernet cable with an RJ45 connector at one end, and an M12X connector at the other end.

## 7.2. Accessing the Cisco FM4500 Mobi for device configuration

Before the unit can be made part of a wireless network, it must be configured.

The on-board Configurator can be used to configure a Fluidmesh device in either of two ways:

- By connecting a control device directly to the Fluidmesh device using an Ethernet cable (Local access)

- By connecting a control device to the Fluidmesh device through an internet connection (Internet access)

### 7.2.1. Local access and login for initial configuration



#### NOTE

If your computer has a wireless WiFi card, you may have to disable the card to avoid routing issues between the computer's wired and wireless network interfaces.

To use the Configurator interface to access the Cisco FM4500 Mobidirectly, do the steps that follow:

1. Power ON the unit.
2. Wait approximately one minute for the boot sequence to complete.
3. Connect one end of a CAT5/6 Ethernet cable to the computer that will be used to configure the Cisco FM4500 Mobi.
4. Connect the other end of the Ethernet cable to the *Console* LAN port on the Cisco FM4500 Mobi.
5. Manually set the computer's IP address and Netmask to be recognizable by the Cisco FM4500 Mobi. The correct settings are as follows:
  - **IP address:** 192.168.0.10 (or any other IP address belonging to subnet 192.168.0.0/255.255.255.0)
  - **Netmask:** 255.255.255.0
6. Launch the computer's web browser.
7. Enter the IP address of the Cisco FM4500 Mobi in the browser's URL entry field.
  - If the Configurator interface is shown immediately, proceed to [Step 9](#) below.
  - Alternatively, you may see the following window:



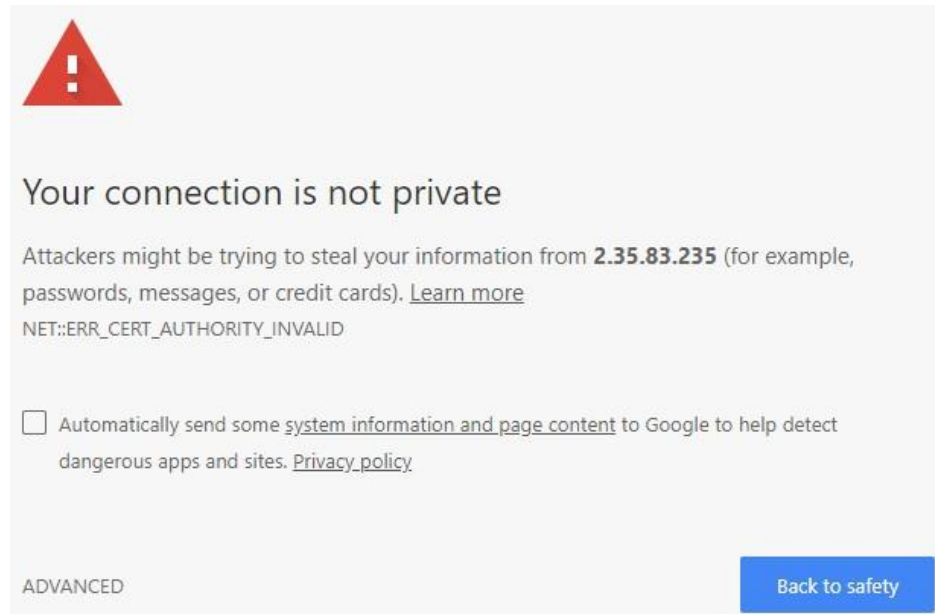

**Figure 12. 'Connection Not Private' warning (Google Chrome)**



**IMPORTANT**

Due to rising levels of cyber crime, most modern web browsers are built to alert you to possible threats, such as hacking, spoofing and identity theft.

Because the Cisco FM4500 Mobi is connected to the computer using an unsecured connection (in this case, a CAT5/6 cable), the web browser may show you security warnings like the one above.

This is normal and expected. During the configuration process, it is safe to ignore these warnings.

- a. Click the **ADVANCED** link.
  - You will see the following window:

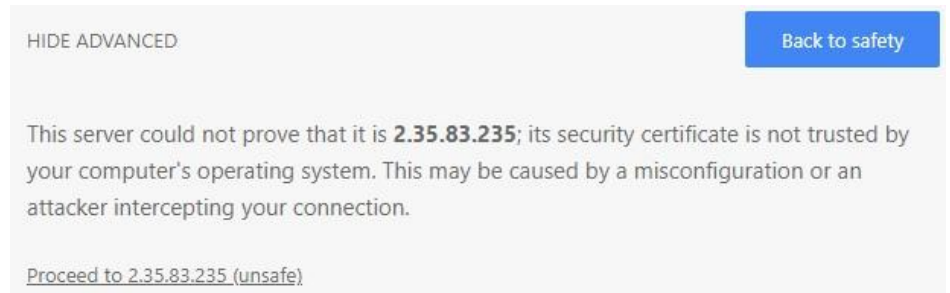

**Figure 13. Security certificate warning (Google Chrome)**

- b. Click **Proceed to [the URL] (unsafe)**.
  - The device login window will be shown:

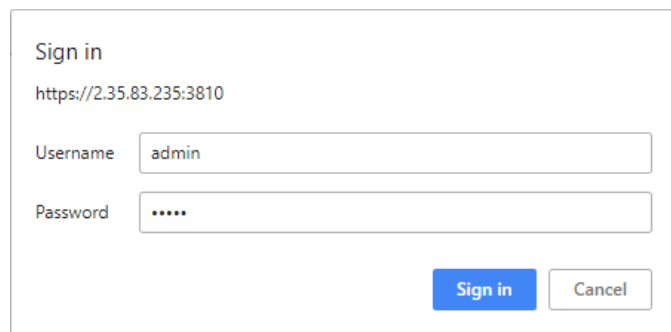

**Figure 14. Fluidmesh device login window**

8. The factory-set login details are as follows:
  - Username: **admin**
  - Password: **admin**
9. Enter the correct username and password. Press 'Enter'.  
 If your browser shows a time-out or similar message, the computer may be trying to access the Fluidmesh device through a proxy server. To resolve the issue, do the following steps:
  1. Go to **Control Panel > Internet Options > Connections > LAN Settings**.

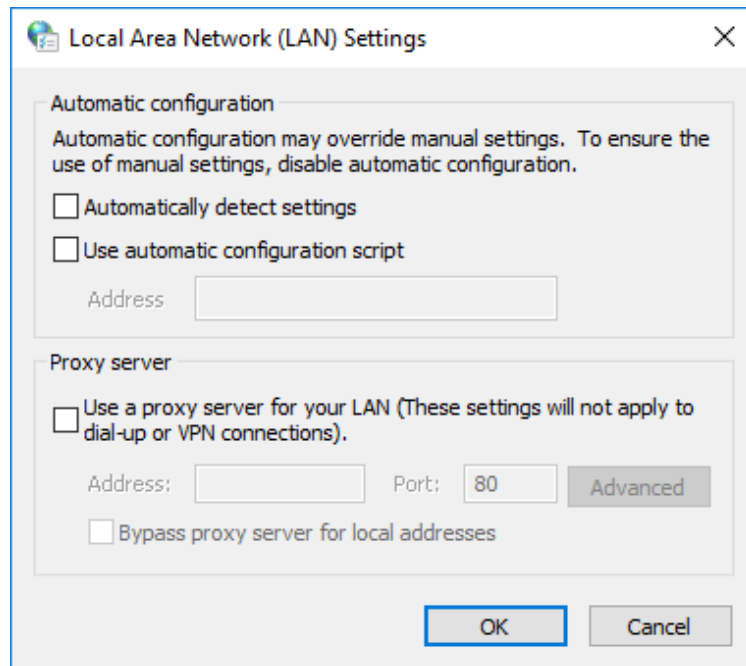

2. Disable proxy connections by un-checking the check boxes for the following options:
    - **Automatically detect settings**
    - **Use automatic configuration script**
    - **Use a proxy server for your LAN**
  3. Click the **OK** button.
  4. Enter your user name and password in the device login window, and press 'Enter'.
10. To ensure system security, change the default password when the installation is completed. If the **Sign in** window does not appear, refer to [“Changing the Administrator username and password”](#) (page 125).

### 7.2.2. Initial configuration with the unit in Provisioning Mode

The Cisco FM4500 Mobi cannot be operated without entering some basic configuration settings. These settings allow the unit to connect to a local network and communicate with the network hardware.

If a new unit is being configured for use for the first time, or has been reset to factory default configuration for any reason, the unit will enter *Provisioning Mode*. This mode allows you to program the unit's initial configuration settings.

If the unit is in Provisioning Mode, it will try to connect to the internet using Dynamic Host Configuration Protocol (DHCP):

- If the unit successfully connects to the internet, you can do a centralized configuration of the unit using the FM Racer interface, or do a local configuration using the Configurator interface.
- If the unit fails to connect to the internet, you must do a local configuration using the Configurator interface.



**NOTE**

By default, the local IP address of the unit is set as *192.168.0.10*, and the subnet mask is set as *255.255.255.0* (as shown in the **Current IP Configuration** section).

In Provisioning Mode, the unit connects to the cloud server through a WebSocket connection with 4 096-bit asymmetric encryption and verified security certificates, protecting the communication from cyber-security threats.

- Check that the unit is in Provisioning Mode by looking at the colored icon to the right of the **RACER™** tag in the upper left-hand corner of the screen (Figure 15 (page 52)).

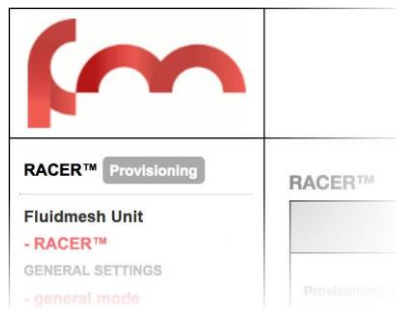

**Figure 15. FM Racer status icon (Provisioning Mode)**

- If the icon reads **Provisioning**, the unit is in Provisioning Mode. Configure the unit by doing the steps shown in this section.
- If the icon reads **Online** or **Offline**, the unit has been configured before. In this case, you must choose between two further options:
  - If you want to do a new configuration by reverting the unit to Provisioning Mode, reset the unit as shown in [“Resetting the unit to factory defaults”](#) (page 137).
  - If you want to change the connection settings, but keep the current configuration, change the settings as shown in [“General settings”](#) (page 61).

If the Cisco FM4500 Mobi is in Provisioning Mode:

- The **RACER™** dialog will be shown (Figure 16 (page 53)).

RACER™ Cloud connection info	
Status:	Disconnected
Current IP Configuration	
Current IP:	192.168.0.10 (fallback)
Current Netmask:	255.255.255.0

Configure DHCP to connect to RACER™	
Use this section to connect the radio to the Internet via DHCP to use RACER™ Cloud Management. Set fall-back IP settings if DHCP is not available.	
DHCP fall-back configuration	
Local IP:	<input type="text" value="192.168.0.11"/>
Local Netmask:	<input type="text" value="255.255.255.0"/>
Default Gateway:	<input type="text"/>
Local Dns 1:	<input type="text"/>
Local Dns 2:	<input type="text"/>

**Figure 16. FM Racer dialog**

- The unit's **Local IP** address will be set to **169.254.a.b**, where **a** and **b** are the last two parts of the unit's unique unit identification (ID) number. For example, if the unit ID number is **5.12.34.56**, the unit's IP address will be set as **169.254.34.56**.
- The unit can also be reached using the DHCP fallback IP address (*192.168.0.10/24*).
- The unit's Status and link/boot LEDs will blink continuously from left to right (*green-green-orange-red*), then from right to left (*red- orange-green-green*). The LEDs will repeat this cycle until the unit either enters a Fallback condition, or enters **Online** or **Offline** mode.
- The unit will attempt to connect to the internet using DHCP.



**NOTE**  
DHCP is disabled when the unit leaves *Provisioning Mode*.

Make sure that the Cisco FM4500 Mobi is connected to a local network that supports DHCP. If the unit connects successfully to the internet *and* to the Partners Portal, the **RACER™ Cloud connection info** Status will be shown as **Connected** (Figure 17 (page 54)).

RACER™ Cloud connection info	
Status:	Connected
Current IP Configuration	
Current IP:	10.11.1.152 (dhcp)
Current Netmask:	255.255.0.0

**Figure 17. RACER™ Cloud connection info status (Connected)**

Configure the unit using either of the following methods:

- To do a centralized (online) configuration of the unit using the FM Racer interface, refer to the *Fluidmesh Networks FM Racer User Manual*.
- To do a local (offline) configuration using the Configurator interface, refer to [“Device configuration using the configurator interface” \(page 45\)](#).

If the unit is not able to connect to the internet:

- The unit will revert to a *Fallback* state.
- The unit’s Status and link/boot LEDs will blink continuously from the outer red and green to the inner green and orange. The LEDs will repeat this cycle until the unit exits the Fallback state, or is set as either **Online** or **Offline**.
- The unit’s IP address will automatically be set to **192.168.0.10/24**.

If the unit connects to the internet in Provisioning Mode, but cannot connect to the Partners Portal, the unit’s IP address will automatically be set to 192.168.0.10/24. If the unit cannot connect to the Partners Portal, verify that the Partners Portal can be reached by doing the following steps:

1. Check that the Ethernet cable leading to the unit is properly connected.
2. Check that the local DNS server can resolve [this address](#).
3. Check that the local DNS server can resolve the IP address of the FM Racer Cloud server, and that the address can be reached.
4. Check the network firewall settings. Port 443 must be enabled.
5. Click [this link](#).
  - The Fluidmesh Partners Portal page should open in your browser.
6. If the Partners Portal cannot be accessed, contact the Fluidmesh support desk by sending an E-mail to [support@fluidmesh.com](mailto:support@fluidmesh.com).
7. If the Partners Portal does not come back online, do a local (offline) configuration using the Configurator interface. For further information, refer to [“Device configuration using the configurator interface” \(page 45\)](#).

If the unit cannot connect to the internet in Provisioning Mode, try to connect to the internet by doing the following steps:

1. Enter alternative **Local IP**, **Local Netmask**, **Default Gateway**, **Local Dns 1** and **Local Dns 2** values as needed, using the **RACER™** dialog.
2. Click the **Save fallback IP** button ([Figure 16 \(page 53\)](#)).
  - The web browser will show the unit reboot dialog ([Figure 18 \(page 55\)](#)).

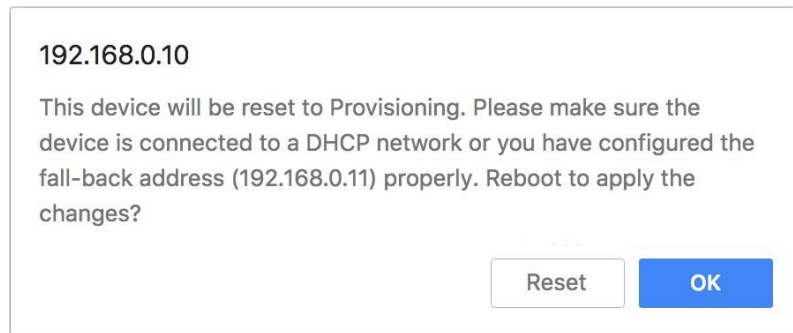

**Figure 18. Unit reboot dialog (typical)**

3. Click the **OK** button to proceed, or click the **Reset** button to go back to the **RACER™** dialog and adjust the settings.
  - If you click the **OK** button, the unit will reboot, but will remain in Provisioning Mode.
  - The unit will attempt to connect to the internet using the new connection values.

If the unit cannot connect to the internet using the **DHCP fall-back configuration** settings, the **RACER™ Cloud connection** info Status will be shown as **Disconnected** ([Figure 19 \(page 55\)](#)).

RACER™ Cloud connection info	
Status:	Disconnected 
Current IP Configuration	
Current IP:	10.11.1.152 (dhcp)
Current Netmask:	255.255.0.0

**Figure 19. RACER™ Cloud connection info status (Disconnected)**

Configure the unit by doing the following steps:

1. Click the **Reset to Provisioning** button at the bottom of the **DHCP fall-back configuration** section.

2. Do a local (offline) configuration using the Configurator interface. For further information, refer to [“Device configuration using the configurator interface” \(page 45\)](#).

For a quick overview of the initial configuration process, refer to the flowchart below.

**NOTE**

Each individual Fluidmesh radio transceiver unit has a factory-set mesh identification number that takes the form **5.w.x.y**.

If the unit's IP address is set to **169.254.x.y/24** as in Case 2 below, the values **x** and **y** represent parts **x** and **y** of the unit's mesh identification number.



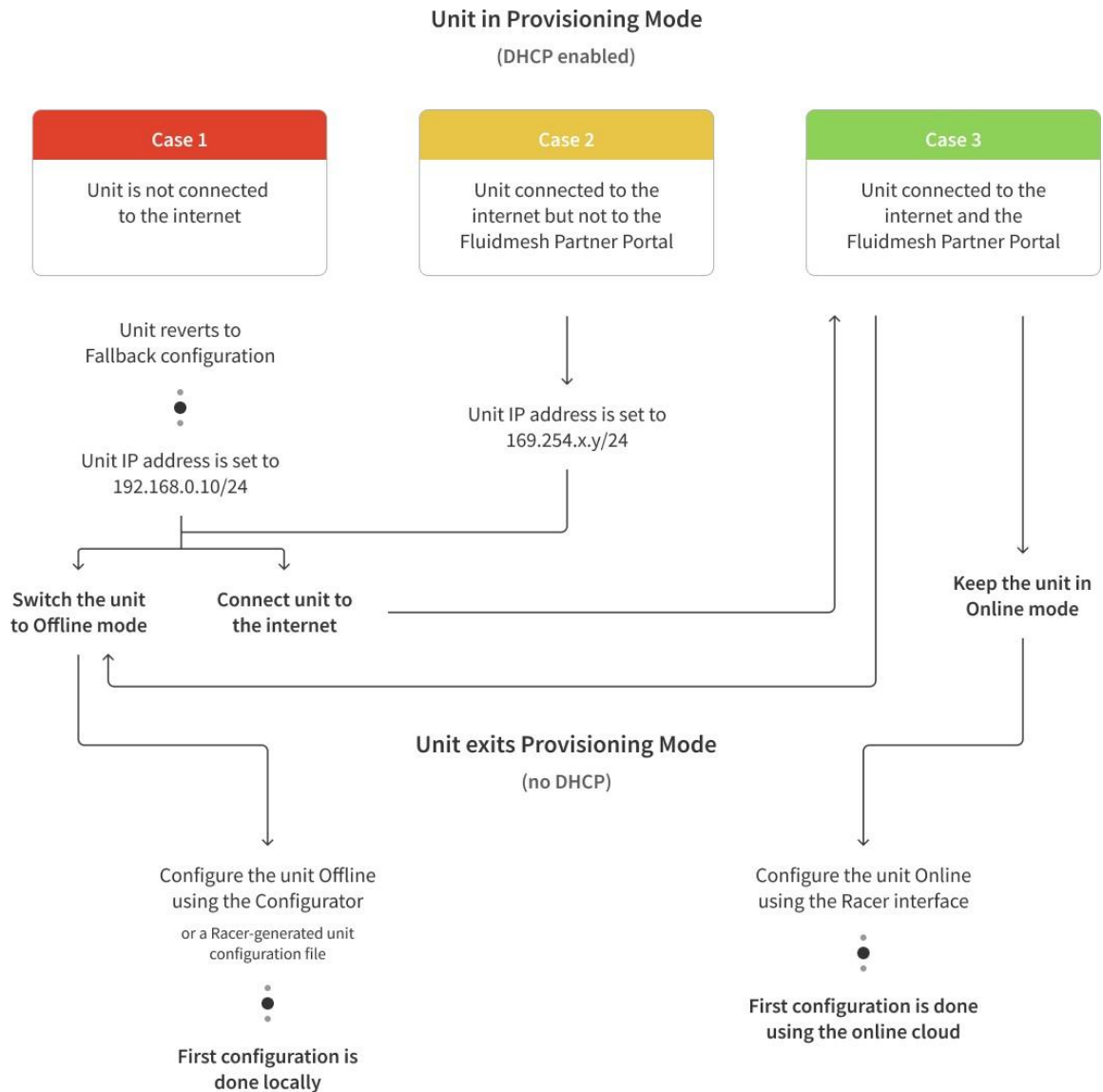

### 7.3. Switching between offline and online modes

The Configurator interface may not be in the needed mode when you log in. To switch between *Offline* and *Online* modes, do the steps that follow:

1. Log in to the Configurator interface as shown in [“Accessing the Cisco FM4500 Mobi for device configuration”](#) (page 47).
  - The Configurator landing page will be shown ([Figure 20](#) (page 58)).

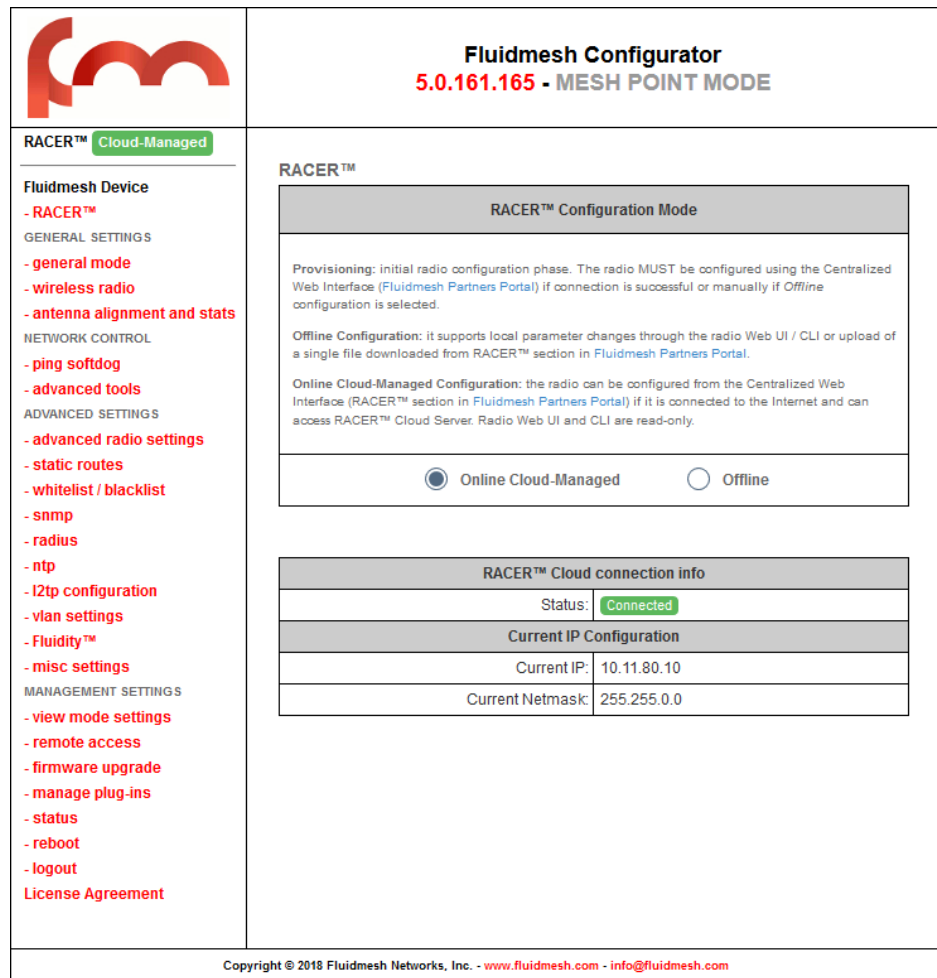

**Figure 20. Fluidmesh Configurator (landing page)**

2. The lower section of the **RACER™ Configuration Mode** box has two radio buttons that show whether the unit is in **Online (Cloud-Managed)** mode, or **Offline** mode.
3. If the unit is not in the correct mode, click the **Online (Cloud-Managed)** or **Offline** radio button as needed.
  - A confirmation dialog will be shown, asking if you want to switch the unit to the chosen mode.
4. To switch the radio to the chosen mode, click the **Confirm** button.
  - A ten-second countdown will be shown.
  - The Configurator interface web page will reload.
  - The unit will be switched to the chosen configuration mode.

## Uploading a device configuration file from FM Racer

A FM Racer device configuration template contains a set of pre-configured parameters that can be customized and applied to a single Fluidmesh device, or to a group of devices.

FM Racer configuration files use the \*.FMCONF file extension.

If the unit is not connected to the Internet, you can still use the FM Racer configuration interface to define a configuration file, then upload it to the unit. This can be done in either of two different ways:

- A range of ready-made configuration templates are available from the FM Racer interface. Each template caters to a particular configuration scenario, and can be copied and modified to your needs.
- Alternatively, you can create a new, custom configuration template.

For instructions on how to copy, modify or create a configuration template using the FM Racer interface, refer to the *Fluidmesh Networks FM Racer User Manual*.

A configuration file that has been created using the FM Racer interface must be uploaded to the unit. To upload a FM Racer configuration file, do the following steps:

1. Switch the unit to Offline mode as shown in “[Switching between offline and online modes](#)” (page 57).
2. Click the **-RACER™** link in the left-hand settings menu.
  - The Configurator landing page will be shown.
3. Click the **Choose File** button in the **Upload Configuration File** section ([Figure 21 \(page 59\)](#)).

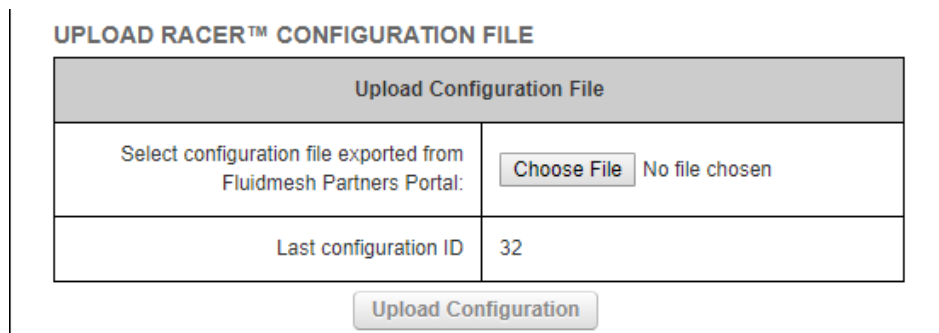

**Figure 21. Configurator interface (FM Racer configuration file upload dialog)**

- Find and choose the correct configuration file by following the software prompts.
4. Click the **Upload Configuration** button.
    - The configuration file will be uploaded and applied to the unit.

## 7.4. Viewing and accessing the FM Monitor settings

FM Monitor is Fluidmesh's diagnostic and analysis interface.

FM Monitor is used to:

- Monitor the real-time condition of Fluidmesh-based networks.
- Generate statistics from network history.
- Verify that device configuration settings are optimal for current network conditions.
- Detect network-related events for diagnostic and repair purposes, and generate alerts if network-related faults arise.
- Analyse network data with the goal of increasing system uptime and maintaining optimum network performance.
- Generate and back up network statistics databases for future reference.



### IMPORTANT

FM Monitor cannot be used to configure Fluidmesh gateway and radio transceiver devices. Fluidmesh devices can be configured using any of the following methods:

- You can apply a pre-created Cloud-based configuration, or do manual configuration of a device, using the FM Racer interface. For instructions on how to use the FM Racer interface, refer to the *Cisco FM Racer Configuration Manual*.
- You can manually configure a device by using the device's built-in Configurator interface. For instructions on how to use the Configurator interface, refer to the relevant section of this manual.
- You can do command-line-based manual configuration of a device by using the device's built-in CLI interface. For instructions on how to use the CLI interface, refer to the *Fluidmesh Command-line interface user manual*.

To view and access the FM Monitor settings, do the steps that follow:

1. Log in to the Configurator interface as shown in [“Accessing the Cisco FM4500 Mobi for device configuration” \(page 47\)](#).
2. Click the **MONITOR™** link in the left-hand settings menu.
  - The **MONITOR™** landing page will be shown (below).

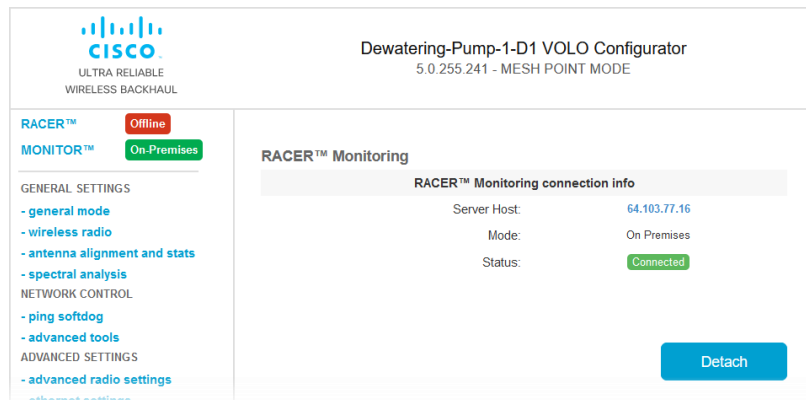

3. A colored icon will be shown to the right of the red MONITOR™ link. The icon shows a summary of the current mode and status parameters:
  - If the icon is red and reads *Disabled*, the FM Monitor application has been disabled.
  - If the icon is gray and reads *On-Premises*, the FM Monitor application is enabled, but the device is not currently connected to the FM Monitor server. A possibility is that the FM Monitor server cannot be reached.
  - If the icon is green and reads *On-Premises*, the FM Monitor application is enabled and the device is connected to the FM Monitor server.
4. For more information on how to use the controls and configure FM Monitor, refer to the *Fluidmesh Radio Monitoring Dashboard Configuration Manual*.

## 7.5. General settings

### 7.5.1. The General Mode window

The General Mode window contains controls to monitor and/or change the following settings:

- The unit's operational mode.
- The version of Prodigy currently being used by the unit.
- The unit's LAN parameters.
- If the local unit is in *Bridge Mode*, the Bridge ID of the remote unit to which the local unit must be linked.

To change the General Mode settings, do the following steps:

- Click the **-general mode** link under **GENERAL SETTINGS** in the left-hand settings menu (below).

GENERAL MODE	
<b>General Mode</b>	
Select MESH POINT mode if you are attaching an IP edge device (i.e. network camera, encoder, etc.) to this Fluidmesh FM3500 or if you are using this unit as a relay point in the mesh network.	
Mode:	<input type="radio"/> bridge <input checked="" type="radio"/> mesh point <input type="radio"/> mesh end
<b>Prodigy Version</b>	
Select the Prodigy protocol version. Please note the Prodigy 1.0 is NOT compatible with Prodigy 2.0. Please make sure to use the same Prodigy version for the entire network.	
Protocol:	<input checked="" type="radio"/> Prodigy 1.0 <input type="radio"/> Prodigy 2.0
<b>LAN Parameters</b>	
Local IP:	<input type="text" value="10.11.80.10"/>
Local Netmask:	<input type="text" value="255.255.0.0"/>
Default Gateway:	<input type="text" value="10.11.0.1"/>
Local Dns 1:	<input type="text" value="8.8.8.8"/>
Local Dns 2:	<input type="text" value="8.8.4.4"/>
<input type="button" value="Reset"/> <input type="button" value="Save"/>	

**Figure 22. Configurator GUI (General Mode)**

- The **GENERAL MODE** dialog will be shown (Figure 22 (page 62)).

### Changing the operational mode

#### Changing the operational mode on a mesh network-capable unit

The **General Mode** box (below) contains the operational mode controls.

General Mode	
Select MESH END mode if you are installing this Fluidmesh Unit at the head end and connecting this unit to a wired network (i.e. LAN).	
Mode:	<input type="radio"/> bridge <input type="radio"/> mesh point <input checked="" type="radio"/> mesh end

Fluidmesh radio transceiver units that are capable of operating within a mesh radio network are shipped from the factory in **Mesh End** mode.



**IMPORTANT**

When designing the required network layout, remember that the wireless network must always connect to the wired LAN through a unit configured to be a **Mesh End** unit.

This is necessary for correct wireless mesh network operation, even if the network consists only of two wireless units.

If needed, change the unit's operational mode by clicking one of the following **Mode:** radio buttons:

- **bridge** (This mode creates a layer 2 connection between the local unit and another Bridge unit.)
- **mesh point** (This mode allows you to use the unit as a relay point in the mesh network and/or attach an IP edge device, such as a CCTV camera or video encoder, to the unit.)
- **mesh end** (This mode allows you to install the unit as the junction point between the wireless network and a wired LAN.)



**NOTE**

If the **bridge** option is chosen, the Fluidmesh device ID number of the unit that forms the opposite side of the wireless bridge will be shown in the Configurator window heading block (Figure 23 (page 63)).

**Fluidmesh Device - BRIDGE MODE**

LOCAL BRIDGE ID **5.0.157.185**

ASSOCIATED WITH REMOTE BRIDGE ID **5.1.783.211**

**Figure 23. Configurator window heading block**

If the unit has been set to **Bridge Mode**, you must set the Bridge ID of the remote unit to which the local unit must be linked. Set the Bridge ID by doing the following steps:

1. Click the **Remote [Unit model] Bridge ID:** drop-down (Figure 24 (page 64)).

Local Dns 1:	8.8.8.8
Local Dns 2:	8.8.4.4
Remote Bridge Unit	
You can choose the Bridge ID (Identification) of the remote Fluidmesh Device to associate with.	
Remote Fluidmesh Device Bridge ID:	AUTO ▾
<input type="button" value="Reset"/> <input type="button" value="Save"/>	

**Figure 24. General Mode window (Remote Bridge Unit section)**

2. Click one of the following options:
  - **AUTO**: The local unit will automatically establish a wireless bridge connection with the closest available Fluidmesh unit that is set to *Bridge Mode*.
  - Alternatively, choose the correct unit from the list of available units.
3. Save the operational mode settings by clicking the **Save** button. Alternatively, clear the settings by clicking the **Reset** button.

### Changing the Prodigy version



**IMPORTANT**

Prodigy version selection is only available if the Cisco FM4500 Mobi is set to **Mesh Point** mode or **Mesh End** mode. If the unit is set to **Bridge** mode, the Prodigy Version selector will not be available.

The **Prodigy Version** box (below) contains the Prodigy version selector.

Prodigy Version	
Select the Prodigy protocol version. Please note the Prodigy 1.0 is NOT compatible with Prodigy 2.0. Please make sure to use the same Prodigy version for the entire network.	
Protocol:	<input type="radio"/> Prodigy 1.0 <input checked="" type="radio"/> Prodigy 2.0

Remember that all Fluidmesh devices within a network *must* use the same Prodigy version.





**IMPORTANT**

Prodigy 2.0 is **not** compatible with Prodigy 1.0. Do not implement the two protocol versions within the same network.

If you are expanding an existing network using new Fluidmesh hardware components, make sure that all components are compatible with each other by:

1. Upgrading all network components within the same network to firmware version 6.5 or higher.
2. Configuring all network components within the same network to operate using either Prodigy 1.0 or Prodigy 2.0.

Option 2 is recommended if the network does not contain older Fluidmesh devices that are not compatible with Prodigy 2.0.

If needed, change the unit's Prodigy version by clicking the **Prodigy 1.0** radio button or **Prodigy 2.0** radio button.

Save the Prodigy version settings by clicking the **Save** button. Alternatively, clear the settings by clicking the **Reset** button.

*Changing the LAN parameters*

The LAN Parameters box (below) contains the entry controls for local-address setting.

LAN Parameters	
Local IP:	<input type="text" value="10.11.80.10"/> 
Local Netmask:	<input type="text" value="255.255.0.0"/>
Default Gateway:	<input type="text" value="10.11.0.1"/>
Local Dns 1:	<input type="text" value="8.8.8.8"/>
Local Dns 2:	<input type="text"/>



**NOTE**

When the **General Mode** window is opened for the first time, the **Local IP** and **Local Netmask** LAN parameters will be factory-set default values.

The information needed is self-explanatory. To enter a parameter, click the field and type the parameter.

If needed, enter the local primary DNS address in the **Dns 1** field, and enter the local secondary DNS address in the **Dns 2** field.

Save the LAN settings by clicking the **Save** button. Alternatively, clear the settings by clicking the **Reset** button.

## 7.5.2. Wireless settings

### Modifying the wireless settings



**IMPORTANT**

If the Cisco FM4500 Mobi was purchased in the USA or Canada, the Country selection is set to the country of purchase, and the **Country:** drop-down will be disabled.

The **WIRELESS RADIO** window contains controls to change the following settings:

- The shared network passphrase.
- The national territory in which the wireless network is installed.
- The operational radio frequency and bandwidth settings.

To change the Wireless Settings, do the following steps:

1. Click the **-wireless radio** link under **GENERAL SETTINGS** in the left-hand settings menu.
  - The **WIRELESS RADIO** dialog will be shown ([Figure 25 \(page 66\)](#)).

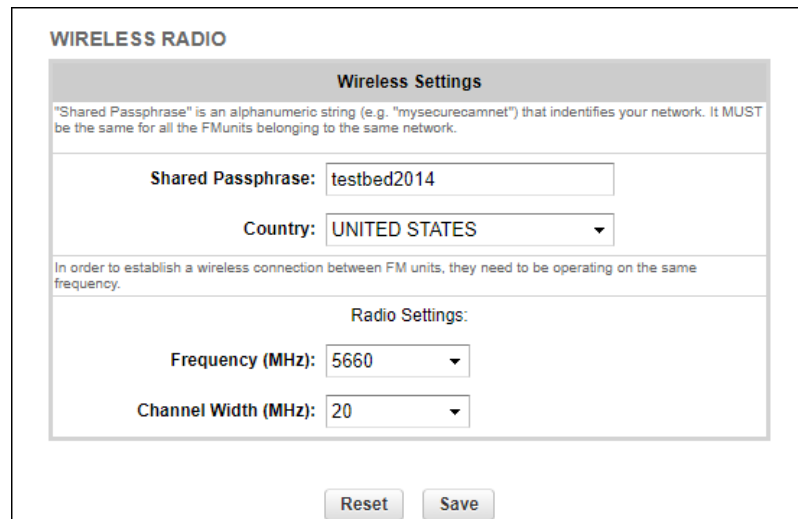

**Figure 25. Configurator GUI (Wireless Radio dialog)**

2. Enter a defined network passphrase in the Shared Passphrase field.



**IMPORTANT**

If a shared passphrase is defined, the same passphrase must be used for all Fluidmesh units in the same network.

The shared passphrase can be composed of any ASCII characters except the following: " " \ \$ =

- Specify the country in which the unit is installed by selecting the correct option from the **Country** drop-down menu.



**CAUTION**

Different countries frequently have differing telecommunications regulations. If the Country listing is not set correctly, the unit may violate national telecommunications legislation.

- Specify the unit's operating frequency by clicking the correct option in the **Frequency (MHz)** drop-down.



**CAUTION**

Make sure that the chosen country listing matches the country in which the unit is installed before changing the **Frequency (MHz)** value.

- You can change the frequency of each radio link in order to minimize interference with other wireless networks operating in the same area. The frequencies shown on the **Frequency (MHz)** selector are the carrier frequencies.
  - Operation in the 4.9 GHz band must be enabled using a Fluidmesh software plug-in. Refer to ["Plug-In management" \(page 129\)](#) for details. Note that the 4.9 GHz band is not available in Brazil and Canada.
- If **Advanced** configuration mode was selected, choose the required channel bandwidth from the **Channel Width (MHz)** drop-down. Note that the radio units on both sides of a wireless link must be set to the same channel width value. A channelwidth mismatch will result in degraded communication between the units.



**CAUTION**

Before finalizing the settings on the **WIRELESS RADIO** window, refer to ["Important considerations for wireless settings" \(page 68\)](#) below. This section contains important information that may influence your choice of wireless settings.

### Important considerations for wireless settings

The following sub-sections contain important technical and regulatory information that influences the settings on the **WIRELESS RADIO** window.

- For information on how to avoid network co-location interference, refer to [“Co-location considerations”](#) (page 68).
- For information on the effects of channel width on data rate and throughput, refer to [“Channel width considerations”](#) (page 68).
- For information on using dynamic frequency selection to avoid interference with terminal doppler weather radar, refer to [“Dynamic frequency selection considerations”](#) (page 69).

#### Co-location considerations

To avoid radio interference caused by unit co-location, set the frequencies of co-located transceivers as far apart as practically possible.

Before a network is deployed, frequency allocations for every unit-to-unit link must be planned in advance. A safe method is to use the narrowest channel width that can realistically support the needed amount of data throughput whilst separating the individual channels as much as possible.

Even if two radios are not transmitting on the same channel, their side lobes may still cause them to interfere with each other. It is good practice to space the radios as far apart as practically possible in the vertical plane, with a minimum of 3ft/1m and an ideal distance of 5ft/1.5m between them.

Mounting radio transceiver units back-to-back or side by side may cause co-location interference that will degrade performance across your network.

#### Channel width considerations

Whenever practically possible, setting the unit to operate at a narrower channel width can help reduce overall network interference by increasing the number of available channels.



#### WARNING

Before changing the channel width value, make sure that the overall frequency range you will be using is legal for your territory. Changing the operating channel width may violate the local telecommunication authority’s regulations, lead to illegal wireless operation, and have other harmful consequences.

The following table correlates different channel widths with their theoretical maximum data rates and achievable throughput, assuming that the unit is being used as part of a point-to-point configuration.



### IMPORTANT

The following table shows theoretical values under ideal conditions. Actual throughput may vary depending on environmental and other conditions.

**Table 4. Available Radio Channel Widths**

Channel width	Max.modulation speed	Max. throughput
20 MHz	150 Mb/s	90 Mb/s
40 MHz	300 Mb/s	150 Mb/s
80 MHz	866 Mb/s	500 Mb/s

### Dynamic frequency selection considerations

To ensure that commercial and military flight operations proceed without interference to terminal doppler weather radar (TDWR), operation of the unit in the 5.250 GHz-to-5.350 GHz band (known as U-NII Mid or U- NII-2A) and the 5.470 GHz-to-5.725 GHz band (known as U-NII Worldwide or U-NII-2C / U-NII-2E) is discouraged.

Operation of the unit within these frequency ranges is disabled by default.



### WARNING

If the unit is operated in the U-NII Mid or U-NII Worldwide frequency ranges, dynamic frequency selection (DFS) may be a legal requirement in your national territory.

For information on whether legislation requires that you use DFS, [click here](#).



### IMPORTANT

The dynamic frequency selection feature must be enabled using a software plug-in (Fluidmesh part number *FM-UNII2*). Contact your Fluidmesh Networks representative for details.

If it is essential that the unit is operated in the U-NII Mid or U-NII Worldwide frequency ranges, do the following steps:

1. Make sure that local legislation permits operation of the unit in the U-NII Mid and/or U-NII Worldwide frequency ranges. Use of these frequency ranges may be prohibited in some territories.
2. Make a note of the exact physical locations of the unit antennas.
3. Consult your local Fluidmesh Networks representative. He or she will be able to determine whether the unit can be safely used in its current location.
4. If the unit can be safely operated in the U-NII Mid or U-NII Worldwide frequency ranges in its current location, your

Fluidmesh Networks representative will forward you the Fluidmesh UNII2 plug-in (part number *FM-UNII2*) free of charge. This plug-in unlocks access to these frequency bands.

Every Fluidmesh unit uses a proprietary distributed-channel switching algorithm. If the UNII2 plug-in is installed, and a TDWR radar transmission is detected:

- The algorithm will attempt to switch communicating Fluidmesh units to the next radar-free channel, allowing uninterrupted communications with no radar interference.
- The number of detected radars is reported in the command-line interface (CLI).

The number of TDWR transmissions detected by the unit is shown in the command-line interface (CLI), and in [“The device status view” \(page 133\)](#).

To enable the use of U-NII-2A, U-NII-2C and U-NII-2E frequency bands on the unit, do the following steps:

1. Contact your Fluidmesh Networks representative to obtain the the DFS plug-in (part number *FM-UNII2*) free of charge.
2. Install the UNII2 plug-in as shown in [“Plug-in management procedures” \(page 144\)](#).
3. When you activate the UNII2 plug-in through the Fluidmesh Partner Portal, you will be prompted to point out the exact location where the unit will be installed.
  - The Partner Portal will verify that there are no TDWR radar installations within 40 miles (64 Km) of the Fluidmesh unit. If no TDWR radar installations are found, the plug-in will grant permission for the unit to be set to frequencies within the 5.250 GHz-to-5.350 GHz band, and the 5.470 GHz- to-5.725 GHz band.
  - If the unit is already set to an operating frequency that is within the above frequency bands, a banner will appear in the Configurator UI, recommending that you contact Fluidmesh Support to request the *FM-UNII2* plug-in, and verify the location of the unit.



### IMPORTANT

Fluidmesh Networks Inc. will not, under any circumstances, be held liable for any incidental, consequential or special damages, whether based on tort, contract, or otherwise, arising out of or in connection with improper use or operation of the channel width functionality and/or UNII2 functionality.

### 7.5.3. Antenna-alignment tools and physical statistics

The **ANTENNA ALIGNMENT AND STATS** window contains controls to monitor current and average radio link status during operation of the unit, allowing you to easily adjust the alignment of the unit's antennas.

The window shows a list of wireless links to other Fluidmesh units that have been detected by the local unit, and the relative strength of each wireless link in decibel-milliwatts (dBm).

To do an accurate alignment of a local antenna for a specific wireless link, do the following steps:

1. Click the **-antenna alignment and stats** link under **GENERAL SETTINGS** in the left-hand settings menu.
  - The **ANTENNA ALIGNMENT AND STATS** window will be shown (Figure 26 (page 71)).

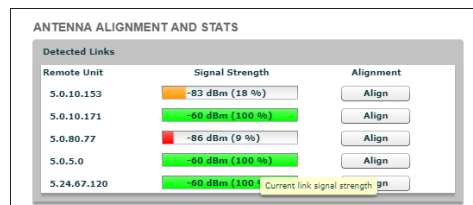

**Figure 26. Configurator GUI (Antenna alignment and stats dialog)**

2. More than one two-way wireless link may be shown in the **Detected Links** table. Find the two-way link for which the local antenna must be adjusted.
3. Click the **Align** button.
  - The **ANTENNA ALIGNMENT AND STATS** tool will be shown (Figure 27 (page 72)).



#### IMPORTANT

The Fluidmesh Transmission Power Control (TPC) algorithm will be disabled during the antenna alignment process. This eliminates the possibility of false radio-transmission power readings.

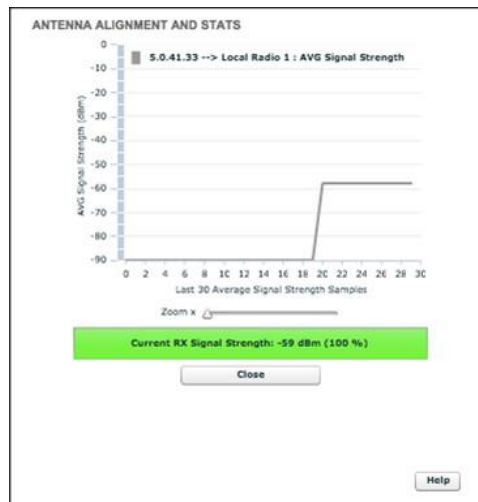

**Figure 27. Antenna alignment and stats tool**

4. The tool consists of:
  - A graph that reports average signal strength over the last 30 strength-sampling periods.
  - A bar that reports the quality of the signal currently being detected at the local unit receiver.
5. Do the physical antenna alignment by manually adjusting the location and direction of the relevant antenna. During the alignment, use the graph and bar readings to monitor variations in signal strength.
6. To increase the readability of the average signal strength graph, click-and-drag the **Zoom x** slider.
7. When the antenna alignment is complete, click the **Close** button.
  - The antenna alignment and stats tool will be closed.

## 7.6. Network control

### 7.6.1. Ping softdog

The **PING SOFTDOG** window contains controls to set up a constant series of pings to one or more IP addresses.

If connectivity is lost between the unit and any of the saved IP addresses, an option can also be set to automatically reboot the Cisco FM4500 Mobi.



#### TIP

As well as being a fail-safe mechanism to monitor network connectivity, the constant ping can also be used as a 'keep-alive' message to devices that need uninterrupted connectivity, such as VoIP telephones.



To use the constant ping and automatic reboot functions, do the following steps:

1. Click the **-ping softdog** link under **NETWORK CONTROL** in the left-hand settings menu.
  - The **PING SOFTDOG** dialog will be shown (Figure 28 (page 73)).

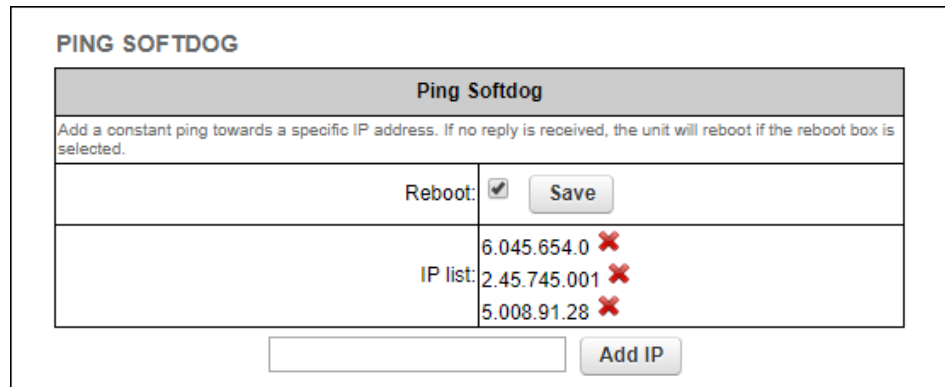

**Figure 28. Configurator GUI (Ping Softdog dialog)**

2. To set up a constant ping to one or more IP addresses, do the following steps:
  1. Enter the IP address in the field to the left of the **Add IP** button.
  2. Click the **Add IP** button.
    - The IP Address will be added to the IP list.
    - There is no limit on the number of IP addresses that can be entered.
  3. To delete an IP address from the IP list, click the red cross to the right of the IP address listing.
3. To automatically reboot the unit if connectivity is lost between the unit and any IP address, do the following steps:
  1. Check the **Reboot:** check-box.
  2. Click the **Save** button.

## 7.6.2. FM-QUADRO

### *FM-QUADRO for mesh network-capable devices*



#### **IMPORTANT**

The FM-QUADRO tool is only available if the Cisco FM4500 Mobi is set to **Mesh End** mode or **Bridge** mode. If the unit is set to **Mesh Point** mode, the **-FMQuadro™** menu option will not be available.

FM-QUADRO does not feature an integrated full-network view. It is designed to monitor network clusters only from the level of the connected Mesh-end device. If a Fluidity Layer-3 network is being monitored, you must use the FM-QUADRO view of the local Global Gateway to see the network topology between the Global Gateway and the Mesh ends to which the Gateway is connected. You must use the FM-QUADRO view of each Mesh End if you want to see the topology and device handoffs within a network cluster governed by the Mesh end.

If you need a fully integrated view of the entire network, you must use FM Monitor as the primary network monitoring tool.

The **FMQuadro** window contains controls to do the following functions:

- Plot all stationary wireless devices within a network, or plot all stationary wireless devices in a Fluidity network in relation to the mobile wireless-equipped vehicles from which they receive relayed traffic.
- Plot all wireless links within a network.
- Show important information about each static device, mobile device and wireless link.
- Diagnose problems with wireless links.
- Show user-configured physical positions of all Cisco Ultra-Reliable Wireless Backhaul components in a wireless network, against the background of an aerial map.



#### **IMPORTANT**

For detailed information on the operational concepts that govern Fluidity, refer to the *Cisco Ultra-Reliable Wireless Backhaul Fluidity Specifications* document.

Plotting and interpreting the wireless links





**NOTE**

The statistical information refresh period is:

- One second for Fluidity (mobile) networks.
- Six seconds for stationary networks.

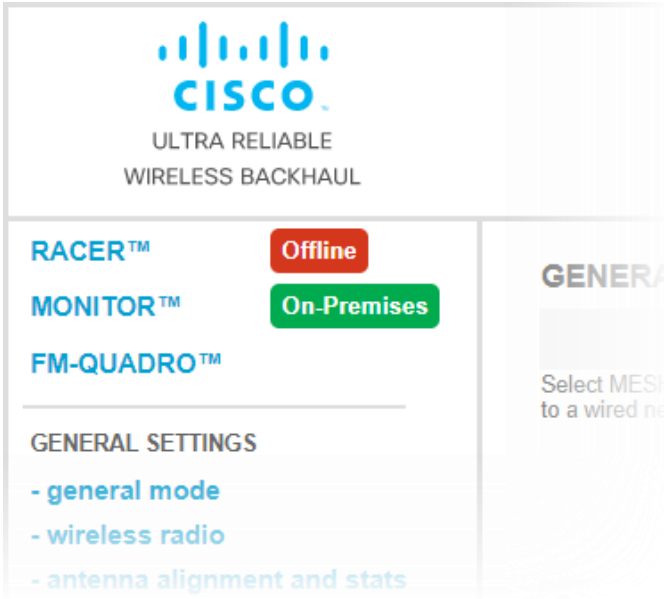
To plot and interpret all wireless links in the current network, click the **FM-QUADRO™** link in the upper left part of the settings menu (below).





**IMPORTANT**

If you are working within a Fluidity Layer-3 network cluster, and the network cluster has more than one Mesh-end radio, access FM-QUADRO through the Configurator interface of the cluster's *Primary* Mesh-end.

Find the Primary Mesh-end by comparing the Mesh ID values of the Mesh-end radios. The Primary Mesh-end will have a numerically lower Mesh ID value than the Secondary Mesh-end.

If you access the FM-QUADRO interface belonging to the cluster's *Secondary* Mesh-end, the network topology view will be shown, but some statistics and configuration information may not be available to view.

- A graphical view of the current network topology will be shown. A typical example is shown below.

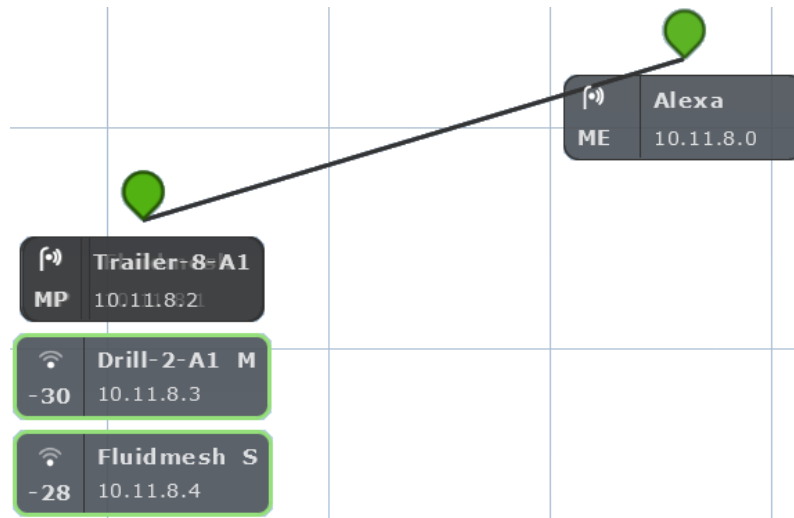

- Stationary (wayside, or infrastructure) Fluidmesh radio transceivers are shown as colored icons (below).



- Stationary radio transceiver icons are colored according to the performance of their data links relative to preset KPI thresholds:
  - If an icon is white, KPI checking is not currently enabled for the FM Quadro view.
  - If an icon is red, the performance of at least one link is below standard (red link line).
  - If an icon is orange, the performance of at least one link is acceptable, but not optimal (orange link line).
  - If an icon is green, the performance of all links is optimal (green link lines).
- A tooltip is shown below each stationary transceiver icon (below).

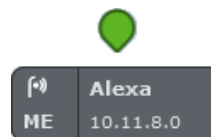

- In clockwise order, the tooltip shows the following information:
  - The *device type icon*. Depending on device type, any of three icons may be seen:
    - The icon below will be shown if the device is a stationary non-Fluidity radio device:



- The icon below will be shown if the device is a stationary radiodevice that is part of a Fluidity network:



- The dynamic Wi-Fi reception-style icon below will be shown if the radio device is a mobile device that is part of a Fluidity network. This icon shows whether the radio's current RSSI is weak, acceptable or strong.



- The icon below will be shown if the device is an Ultra-reliable Wireless Backhaul Gateway device.



- The device label, corresponding to the device's name configuration parameter (*A/lexa* in the image above).
- If the device is a mobile radio transceiver, the device's Principal/Subordinate setting will be shown. A Principal device is marked M (for *Master*), and a Subordinate device is marked S (for *Slave*).
- The device's IP address.
- If the device is a stationary mesh end, it will be marked *ME*. If it is a stationary mesh point, it will be marked *MP*. If it is a mobile radio, the RSSI (in dBm) between the radio and the stationary radio to which it is connected will be shown.
- If the device does not currently have a configured IP address or device label, the device's Fluidmesh Mesh ID number will be shown.
- If the network is a Fluidity network, mobile Fluidmesh radio transceivers that are part of the network are shown as tooltips with colored borders. The tooltip representing a mobile Fluidmesh radio is always shown below the tooltip of

the stationary transceiver to which it is currently connected (below).

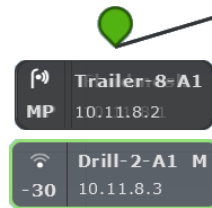

- Mobile-radio tooltip borders are colored according to the radio's performance relative to its currently configured KPI thresholds:
  - If LER is less than or equal to 15%, PER is 0%, and RSSI is greater than or equal to -81 dBm, radio performance is optimal, and the tooltip border will be green.
  - If LER is between 15% and 30% or RSSI is between -86 dBm and -81 dBm, radio performance is acceptable, and the tooltip border will be orange.
  - If LER is greater than 30%, PER is greater than 0%, or RSSI is less than -86 dBm, radio performance is below standard, and the tooltip border will be red.



**IMPORTANT**

The KPI thresholds that govern tooltip border color cannot be changed.

If you need to adjust KPI thresholds to custom values, you must use FM Monitor as the primary network monitoring tool.

If a mobile radio connected to a stationary radio hands off to another stationary radio, the tooltip representing the mobile radio will move to a position underneath the tooltip of the connected stationary radio. If a stationary or mobile radio is disconnected from the network or cannot be reached, it will not be shown in the FM-QUADRO view.

Network connectivity links between stationary radio transceivers are shown as lines:

- A wired LAN link is shown as a solid black line (below).

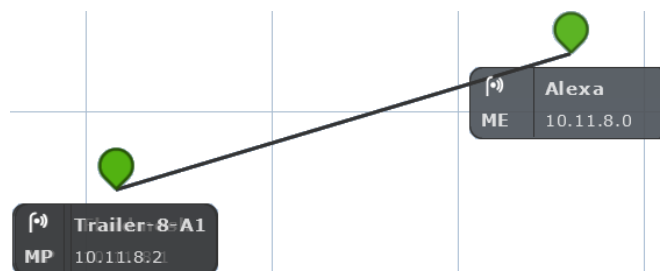

- A wireless LAN link is shown as a colored line (a typical example is shown below).

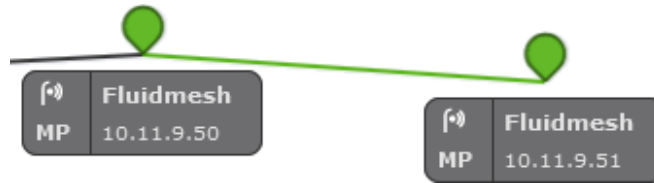

Wireless LAN link lines are colored according to the link's performance relative to its currently configured KPI thresholds:

- If LER is less than or equal to 15%, PER is 0%, and RSSI is greater than or equal to -81 dBm, link performance is optimal, and the link line will be green.
- If LER is between 15% and 30% or RSSI is between -86 dBm and -81 dBm, link performance is acceptable, and the link line will be orange.
- If LER is greater than 30%, PER is greater than 0%, or RSSI is less than -86 dBm, link performance is below standard, and the link line will be red.
- If a wireless link is currently in use as a wireless route, but KPI checking is not enabled, the link will be shown as a solid light blue line.



### IMPORTANT

The KPI thresholds that govern wireless link line color cannot be changed.

If you need to adjust KPI thresholds to custom values, you must use FM Monitor as the primary network monitoring tool.

### [Viewing live data for a radio or wireless link](#)

The device elements shown in the main view are interactive. To get additional real-time information on any Ultra-Reliable Wireless Backhaul device or wireless link, click its icon or tooltip.

- For stationary radio transceivers, an information sidebar will be shown on the right side of the view (a typical sidebar is shown below).

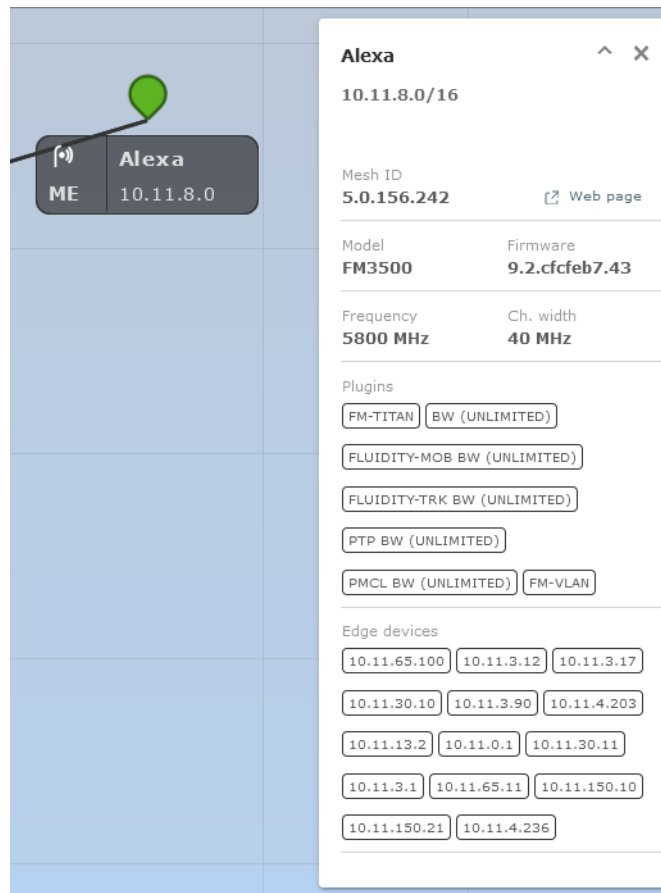



- When an information sidebar is shown for a stationary radio, the sidebar shows the following information:
  - The device name label.
  - The device's IP address and netmask (a typical example might be 10.11.8.0/16).
  - The device's Mesh ID number.
  - A **Web page** link. Clicking this link will open the device's offline Configurator interface in a new window.
  - The device model name.
  - The device's current firmware version.
  - The device's operating frequency.
  - The device's operating channel width.
  - A list of the software plug-ins currently installed on the device.
  - If the device is a stationary radio, a list of IP addresses belonging to all non-Cisco edge devices currently connected to the device will be shown.

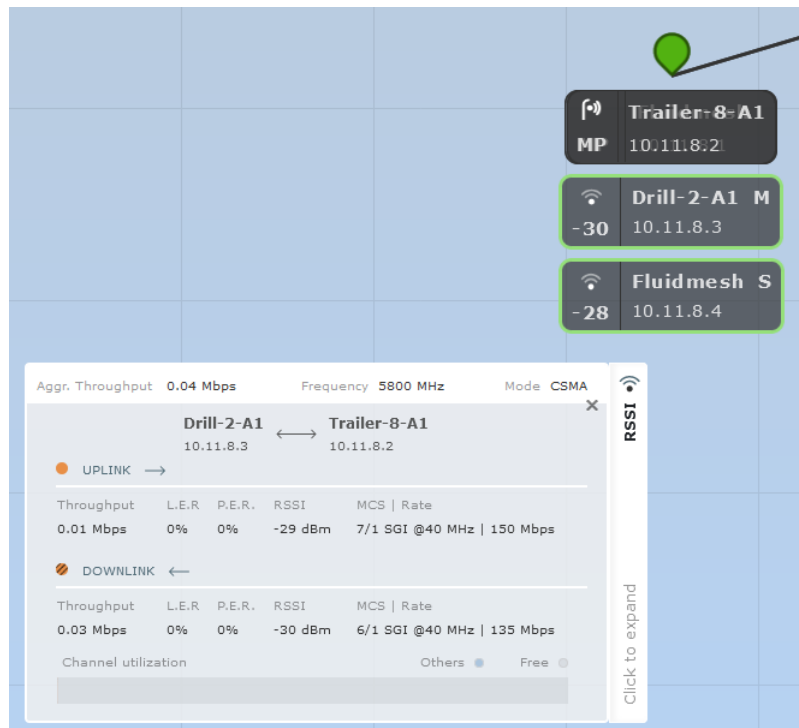

 **NOTE**  
Only one device information sidebar can be shown at any time.

- For mobile radio transceivers, the same information sidebar will be shown on the right side of the view. An information widget will also be shown on the lower left part of the view.
- For wireless links, only the information widget will be shown. A typical information widget is shown below:



 **NOTE**  
A maximum of two radio information widgets can be shown at any time.

When an information widget is shown for a mobile radio or a wireless link, the widget shows the following information:

- The widget header shows the aggregate throughput, operating frequency, and channel-access mode of the link between the mobile transceiver and the stationary transceiver to which it is connected.
- The two radios connected by the wireless link are shown as name labels with IP addresses, connected by a double-pointed line.
- The main body of the widget contains live readings on uplink and downlink throughput, LER, PER, RSSI, MCS, and modulation rates.

A channel-utilization bar shows uplink and downlink utilization for the selected pair of devices, as well as link utilization by other links.

*Viewing live RSSI data for a wireless link*

To see an RSSI information chart for any wireless link between a stationary radio and mobile radio, click the **Click to expand** link on the mobile radio's information widget (below).



A typical RSSI information chart is shown below:

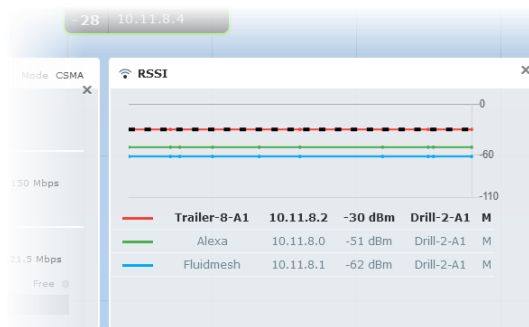

When an RSSI information chart is shown for a wireless link, the chart shows the following information:

- The bold dashed line on the upper part of the graph is the RSSI envelope for the wireless link between the relevant mobile radio and the stationary radio to which it is currently connected.
- The solid lines on the upper part of the graph are RSSI readings for other stationary and mobile radios that are part of the network.

- The table on the lower part of the information chart contains device identification and real-time RSSI readings for other stationary and mobile radios that are part of the network.

### Manipulating the FM-QUADRO view

FM-QUADRO can be manipulated and edited to make any network easy to view.

To change the overall position of the network view, click any blank part of the view, and drag the view to any position on the screen.

To very quickly zoom into or out of the network view, click any blank part of the view, and scroll back and forth with the mouse wheel.

- The view will snap between four pre-determined zoom settings.

To apply fine zoom adjustment to the network view, do the steps that follow:

1. Click the *Zoom* icon on the upper right part of the FM-QUADRO view (upper icon, below).



- The Zoom slider and buttons will be shown (above).
2. Click the **+** button to zoom into the view, or click the **-** button to zoom out of the view. Alternatively, click-and-drag the zoom slider to adjust the zoom level.

### Changing the relative position of device icons

All Ultra-Reliable Wireless Backhaul devices represented by icons or tooltips can be placed in any position on the FM-QUADRO view. To move any icon or tooltip, do the steps that follow:

1. Click the *Edit Mode* icon on the upper right part of the FM-QUADRO view (below).



Alternatively, enter Edit mode by clicking the *Settings* icon on the upper right part of the FM-QUADRO view, and clicking the **Edit Mode** switch in the *Appearance / Background* dialog from **Off** to **On**.

- The *Edit mode* dialog will be shown.
2. Click the **Continue to Edit Mode** button to enable Edit Mode.
    - An *Edit Mode: ON* notification will appear in the view.

To move any icon and its tooltip to a different position, do the steps that follow:

1. Click the *Devices* portion of the **Devices | Background** button (below).



2. Click-and-drag any of the stationary device icons or tooltips to any needed position in the Topology view. Note that tooltips representing mobile radios do not appear in Edit mode. Alternatively, you can reset the Topology view to a strictly hierarchical structure by clicking the **Apply hierarchical view** link in the lower right part of the view.

If needed, you can add an aerial image to the Topology view. This allows you to superimpose the network view over a map of the terrain on which the network has been installed. For instructions on how to add an aerial image as a background to the Topology view, refer to [“Adding an aerial map to the FM-QUADRO view” \(page 86\)](#).

To move an uploaded background image to a different position, do the steps that follow:

1. Click the *Background* portion of the **Devices | Background** button (below).



2. Click-and-drag the background image to any needed position in the Topology view.
3. Adjust the scale of the background image by clicking-and-dragging the **Adjust background scale** slider.
4. Adjust the relative transparency of the background image by clicking-and-dragging the **Adjust background transparency** slider.

When you are finished editing, click the **Save changes** button to save your changes. Alternatively, click the **Discard changes** button to revert to your previous configuration.

- The Topology view will revert to View mode.

### Showing KPI values for wireless links

To show an information ribbon containing key performance indicators next to all wireless link lines, do the steps that follow:

1. Click the *Settings* icon on the upper right part of the FM-QUADRO view (below).



- The *Appearance / Background* dialog will be shown.
2. If the *Background* settings are shown, click the **Appearance** heading.
  3. Click the **KPI values on routes** switch from **Off** to **On**.
  4. Click the check-boxes for each KPI you want to see for all wireless links. Available options are:
    - L.E.R. (Current link error rate, shown as a percentage)
    - P.E.R. (Current packet error rate, shown as a percentage)
    - RSSI (Current received signal strength, shown in dBm)
    - Link Utilization (shown as a percentage)
  5. To save your changes, click the **Save changes** button. Alternatively, click the **Discard** button to leave the dialog without saving any changes.
    - An information ribbon containing the chosen key performance indicators will be shown next to all wireless link lines (a typical example is shown below).

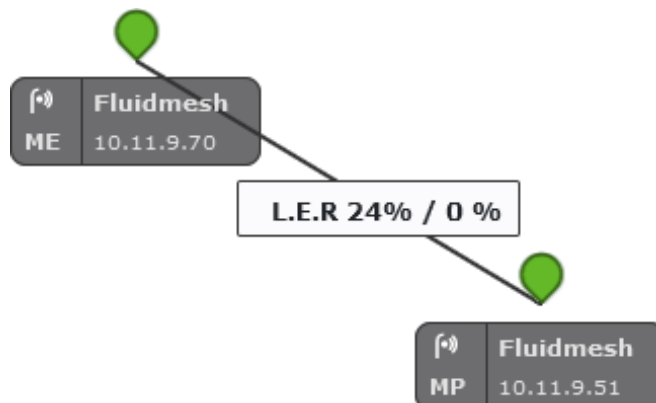

### Showing real-time color codes for radio transceiver key performance indicators

To show performance status indications (in the form of colored device icons) for radio transceivers in real time, do the steps that follow:

1. Click the *Settings* icon on the upper right part of the FM- QUADRO view (below).



- The *Appearance / Background* dialog will be shown.
2. If the *Background* settings are shown, click the **Appearance** heading.
  3. Click the **Default Thresholds** switch from **Off** to **On**.
  4. In the **Thresholds per KPI** section, click the check-boxes for each KPI you want to influence the device icon status coloring. Available options are:
    - L.E.R. (Current link error rate)
    - P.E.R. (Current packet error rate)
    - RSSI (Current received signal strength)



#### NOTE

The KPI thresholds that determine device icon colors cannot be adjusted. The preset KPI thresholds are as follows:

- Optimal radio performance (green icon): LER  $\leq 15\%$ , PER = 0%, RSSI  $\geq -81$  dBm
- Acceptable radio performance (orange icon): LER 15 to 30%, PER = 0%, RSSI -86 to -81 dBm
- Sub-standard radio performance (red icon): LER  $\geq 30\%$ , PER  $> 0\%$ , RSSI  $< -86$  dBm

5. To save your changes, click the **Save changes** button. Alternatively, click the **Discard** button to leave the dialog without saving any changes.
  - All device icons representing radio transceivers will be shown in the FM Quadro view as appropriately colored icons.

### Adding an aerial map to the FM-QUADRO view

You can add an aerial image to the FM-QUADRO view. This allows you to superimpose the network map over a map of the actual terrain on which

the network has been installed, making it easier to visualize component placement, line-of-sight between antennas, and other factors.

To add an aerial terrain map to the FM-QUADRO view, do the following steps:

1. Get an aerial image of the area in which the wireless network and LAN are installed. The image must conform to the following requirements:
  - *Image formats:* \*.PNG, \*.JPG, \*.JPEG or \*.SVG only.
  - *File size:* Less than or equal to 500 Kilobytes (FM1000 and FM10000 Gateways only), or less than or equal to 150 Kilobytes (all radio transceivers).



#### TIP

Suitable aerial images can be created and downloaded using [Google Earth](#). Basic instructions on how to use Google Earth are available [here](#).

- Images can be uploaded to FM-QUADRO using Google Chrome, Firefox, Safari or Microsoft Internet Explorer. Cisco recommends using the latest version of Google Chrome or Firefox.
2. Click the *Settings* icon on the upper right part of the FM- QUADRO view (below).



- The *Appearance / Background* dialog will be shown.
3. If the *Appearance* settings are shown, click the **Background** heading.
  4. Click the **Image** radio button.
    - **Upload your file** and **Preview** sections will be shown.
  5. Use the **Upload your file** section to upload the aerial image.
  6. To save your changes, click the **Save changes** button. Alternatively, click the **Discard** button to leave the dialog without saving any changes.
    - Your chosen aerial image will be shown as a visual layer underneath the current network view.
  7. If needed, move the device icons and/or tooltips to suit the aerial image as shown in [“Changing the relative position of deviceicons” \(page 83\)](#).

## Adjusting the transparency of the aerial map view

You can adjust the transparency level of the aerial map view. This is a useful way to increase the visual definition of device icons, tooltips and link lines against strong background colors.

To adjust the transparency of the current aerial map view, do the steps that follow:

1. Click the *Edit Mode* icon on the upper right part of the FM-QUADRO view (below).



Alternatively, enter Edit mode by clicking the *Settings* icon on the upper right part of the FM-QUADRO view, and clicking the **Edit Mode** switch in the *Appearance / Background* dialog from **Off** to **On**.

- The *Edit mode* dialog will be shown.
2. Click the **Continue to Edit Mode** button to enable Edit Mode.
    - An *Edit Mode: ON* notification will appear in the view.
    - The **Devices | Background** switch control will appear in the view.
  3. Click the switch to *Background*.
  4. Click-and-drag the *Adjust background transparency* slider to the position that gives a comfortable level of visual contrast between the network representation and the uploaded map view.
  5. When the visual contrast is correct, click the **Save changes** button.
    - The *Save new layout* dialog will be shown.
  6. To save your changes, click the **Save changes** button. Alternatively, click the **Keep editing** button to return to Edit Mode, or click the **Discard** button to leave Edit Mode without saving any changes.

## Exporting a network representation file

You can export a representation file of the current network layout. This allows Cisco Technical Support to visualize the network for troubleshooting purposes.

To export a representation file for the current network, do the steps that follow:

1. Click the *Export as JSON* icon on the upper right part of the FM-QUADRO view (below).





- The *Export as JSON* dialog will be shown.



#### IMPORTANT

The dialog contains important information regarding confidentiality and FM-QUADRO functionality. Read and understand the dialog before you click the **Export** button.

2. Click the **Export** button to export the network representation as a \*.JSON file. Alternatively, click the **Cancel** button to leave the dialog without exporting.
  - If you clicked the **Export** button, the \*.JSON file will be downloaded as a \*.ZIP package. Open the \*.ZIP package to access the \*.JSON file.
3. Forward the \*.JSON file, and the diagnostic file exported from the device status page, to Cisco Technical Support.

### 7.6.3. Advanced tools

The Advanced Tools window contains tools to diagnose the condition of the wireless network.

- The Ping test tool sends pings to a user-specified IP address.
- The Bandwidth test tool tests the bandwidth capacity of the wireless link between the Fluidmesh unit and a user-specified IP address.
- The Path MTU tool tests the size of the maximum transmission unit.

To open the Advanced Tools dialog, click the **-advanced tools** link under **NETWORK CONTROL** in the left-hand settings menu.

#### *Using the Ping test tool*

The Ping test can be run while the network is under load (to test operational performance), or with the network unloaded (to test installed capacity). To use the Ping test tool, do the following steps:

1. Determine which wireless link is to be tested between the Fluidmesh unit and another unit in the wireless network. Get the IP address of the other unit.
2. Enter the IP address of the other unit in the **Ping (10 packets only)** field ([Figure 29 \(page 90\)](#)).

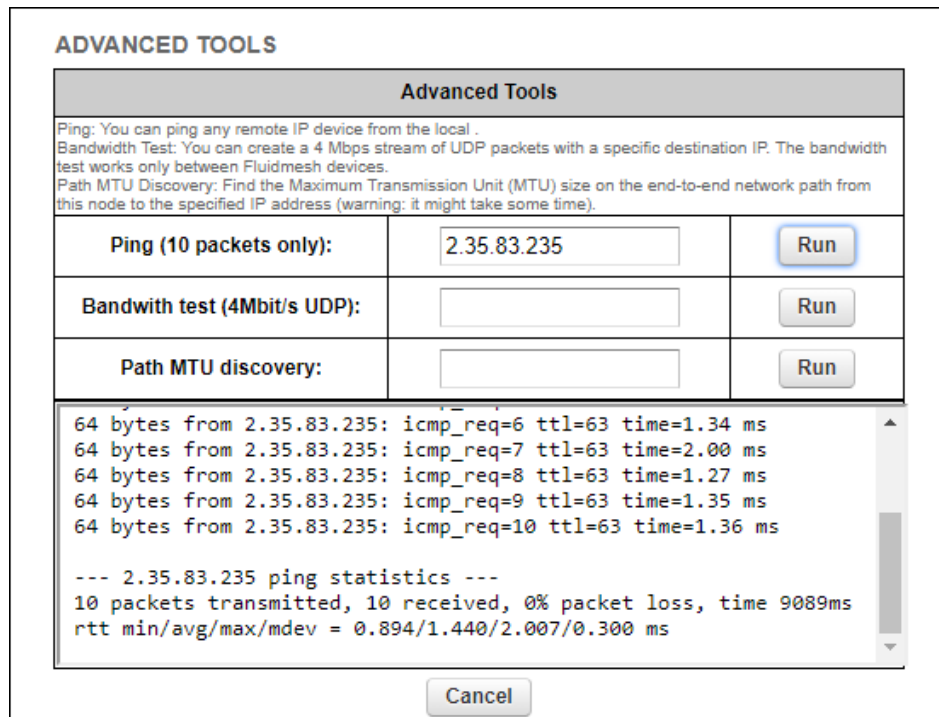

**Figure 29. Advanced Tools window (Ping test tool)**

3. Click the **Run** button to the right of the IP address field.
  - The ping test result will be shown below the test controls.

### Using the Bandwidth Test tool

The Bandwidth test can be run with the network under load (to test operational performance), or with the network unloaded (to test installed capacity). The test tool generates a stream of packets at a rate of 4 Mbits/sec to test available network path throughput.



**IMPORTANT**

Bandwidth rate computation is CPU-intensive, and must be regarded as indicative only. Note that bandwidth testing tends to underestimate the actual link throughput.

To use the Bandwidth test tool, do the following steps:

1. Determine what wireless link is to be tested between the Fluidmesh unit and another unit in the wireless network. Get the IP address of the other unit.
2. Enter the IP address of the other unit in the **Bandwidth test(4Mbit/s UDP):** field (Figure 30 (page 91)).

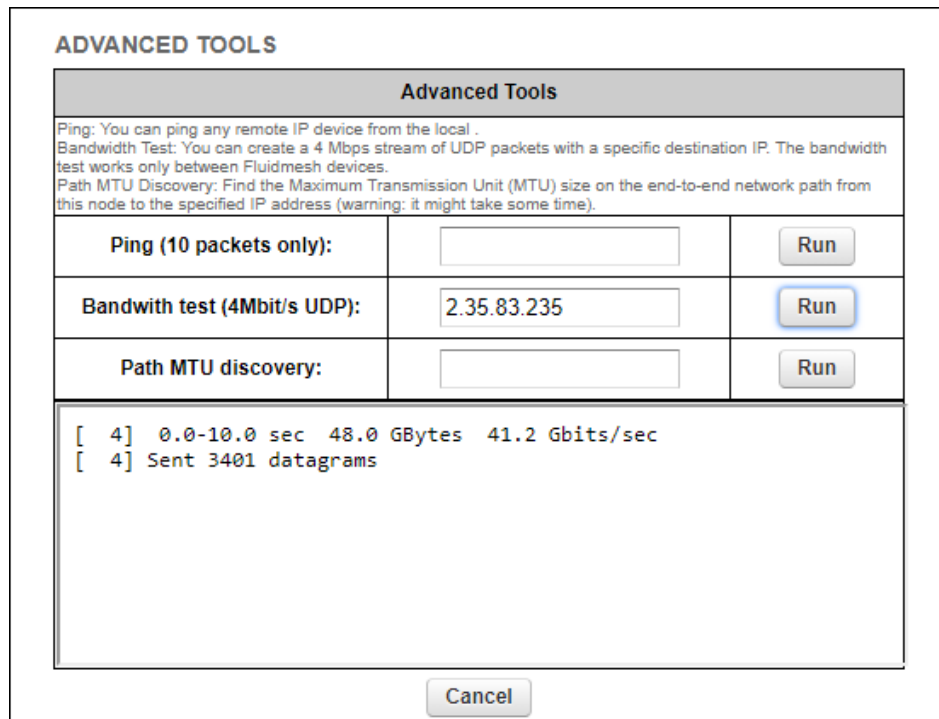

**Figure 30. Advanced Tools window (Bandwidth test tool)**

3. Click the **Run** button to the right of the IP address field.
  - The bandwidth test result will be shown below the test controls.

### Using the Path MTU discovery tool

The Path MTU discovery tool tests the size of the maximum transmission unit (in other words, the largest protocol data unit that can be communicated in a single network layer transaction).

To use the Path MTU discovery tool, do the following steps:

1. Determine what wireless link is to be tested between the Fluidmesh unit and another unit in the wireless network. Get the IP address of the other unit.
2. Enter the IP address of the second unit in the **Path MTU discovery** field ([Figure 31 \(page 92\)](#)).

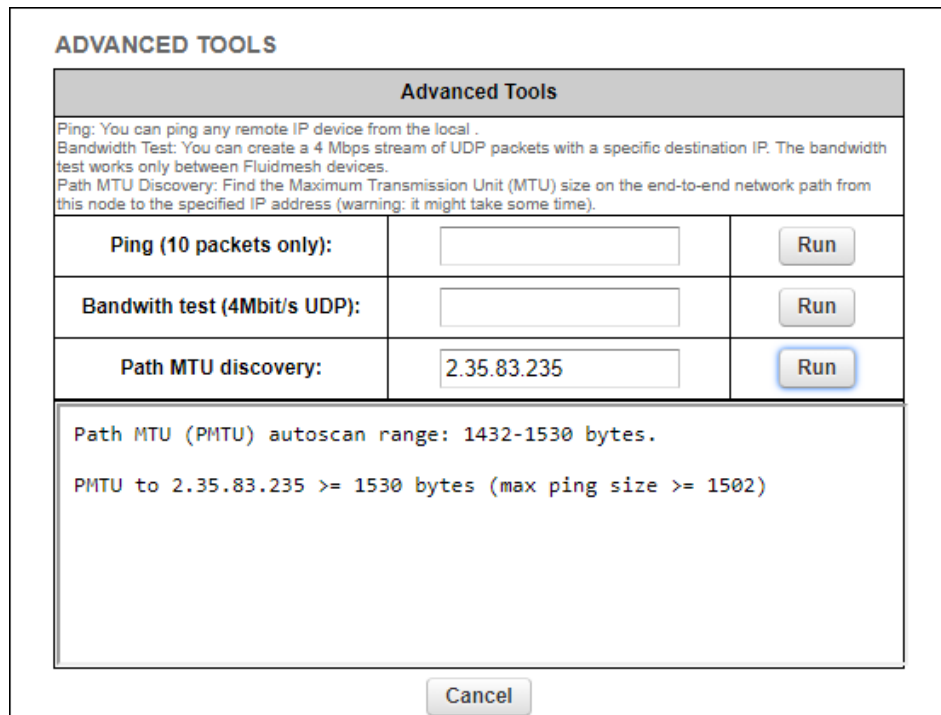

**Figure 31. Advanced Tools window (Path MTU test tool)**

3. Click the **Run** button to the right of the IP address field.
  - The Path MTU test result will be shown below the test controls.

## 7.7. Advanced settings

### 7.7.1. Advanced radio settings

The advanced radio settings menu item is used to configure the following wireless parameters:

- The device's FluidMAX operating mode
- The maximum radio transmission power level
- The AES data encryption setting
- The maximum distance over which the unit is capable of transmitting

To open the Advanced Radio Settings dialog, click the **-advanced radio settings** link under **ADVANCED SETTINGS** in the left-hand settings menu (below).

ADVANCED RADIO SETTINGS	
FluidMAX™ Management	
Force the FluidMAX™ operating mode of this unit. If the operating mode is Master/Slave a FluidMAX Cluster ID can be set. If the FluidMAX Autoscan is enabled, the Slave units will scan the frequencies to associate with the Master with the same Cluster ID. In this case, the frequency selection on the Slaves will be disabled.	
Radio Mode:	MASTER
FluidMAX Cluster ID:	p2mp2
Max TX Power	
Select the max power that the radio shall use to transmit. The Fluidmesh TPC (Transmit Power Control) will automatically select the optimum transmission power according to the channel condition while not exceeding the MAX TX Power parameter. Note: in Europe TPC is automatically enabled.	
Select TX Max Power:	AUTO
Select Antenna Gain:	1 dBm
Data Packet Encryption	
Enable AES to cypher all wireless traffic. This setting must be the same on all the Fluidmesh units.	
Enable AES:	Disabled
Maximum link length	
Insert the length of the longest link in the net, or let the system select an optimal value.	
Automatic:	<input checked="" type="checkbox"/>
Distance:	
Unit:	<input type="radio"/> Km <input type="radio"/> Miles
<input type="button" value="Cancel"/> <input type="button" value="Save"/>	

**Figure 32. Configurator (Advanced Radio Settings menu)**

### Using the FluidMAX Management Setting

The **FluidMAX™ Management** controls are used to set the unit's FluidMAX™ operating mode.

Note that the **FluidMAX™ Management** controls are only available under the following conditions:

- If the unit's firmware is equipped with the FluidMAX engine.
- If the unit is currently being operated as part of a point-to-multipoint network topology.

To use the FluidMAX Management menu, do the following steps:

1. Click the **Radio Mode** drop-down menu.
2. Choose the correct FluidMAX operating mode from the following list of options:
  - **AUTO:** The FluidMAX engine is enabled, and the unit role is set automatically. Depending on various factors, the unit will automatically choose whether to transmit using the

time-division multiple access (TDMA) protocol or the carrier-sense multiple access (CSMA) protocol.

- **principal:** The unit will be set as the center unit within a mesh cluster featuring a 'star' topology. If the unit is set as a *principal*, it will dictate the operating frequency of the mesh cluster of which it is a principal unit.
  - **SUBORDINATE:** The unit will be set as a subordinate unit within a mesh cluster featuring a 'star' topology. If the unit is set as a *Subordinate*, and its Autoscan feature is enabled, the unit will scan the spectrum of available frequencies for a principal unit that shares its Cluster ID, and its frequency selection feature will be disabled.
  - **OFF:** The FluidMAX engine will be disabled.
3. If the operating mode is set to *principal* or *SUBORDINATE*, enter a unique cluster ID tag in the **FluidMAX Cluster ID** field.
  4. If the operating mode is set to *SUBORDINATE*, check the **FluidMAX Autoscan** check-box to allow the principal unit of the local mesh cluster to dictate the frequency on which the unit will transmit and receive.
  5. If the **FluidMAX Autoscan** check-box is checked, the **Include 5-10 MHz Channels in Autoscan** check-box will become available. Check this check-box to increase the scan resolution from the default of 20, 40 or 80 MHz to 5-10 MHz.



#### NOTE

Under normal circumstances, leave the **Include 5-10 MHz Channels in Autoscan** check-box unchecked.

6. Click the **Save** button to save your settings. Alternatively, clear the settings by clicking the **Cancel** button.

### Using the Max TX Power setting

The radio automatically computes the maximum transmission power it can legally use at any moment. It does by subtracting the fixed antenna gain value from the maximum power level prescribed by the FCC EIRP regulation governing each U-NII band.

Due to this operating characteristic, you can only adjust the **Select TX Max Power** setting to values lower than the maximum available transmission power value.

### Using the Max TX Power setting

This setting controls the effective isotropic radiated power (EIRP) output of the unit. By default, EIRP is automatically regulated using Fluidmesh's Transmission Power Control (TPC) algorithm. The algorithm tries to obtain an optimal link signal strength of approximately -55 dBm on both sides of

the radio link while not exceeding the user-defined maximum transmission power threshold.



#### NOTE

if **Max TX Power** is set to **AUTO**, the maximum transmission power may vary at any moment depending on the operating frequency of the unit, atmospheric conditions, and other factors.

If the unit's country selection is set to any country within Europe, TPC is automatically enabled.

To use the **Max TX Power** setting, do the following steps:

1. Click the **Select TX Max Power:** drop-down menu.
2. Choose the correct transmission power level from the following list of options:
  - Transmission power can be manually adjusted from -3 dBm to 24 dBm.
  - If you select the **AUTO** option, the unit will automatically choose the most efficient transmission power level according to prevailing conditions. However, the unit will not exceed the last manually selected **Max TX Power** parameter.
3. Click the **Save** button to save your settings. Alternatively, clear the settings by clicking the **Cancel** button.

#### *Using the Select Antenna Gain setting*

This setting controls the maximum antenna gain in dBm. By default, antenna gain is not pre-set at the factory.

To use the **Select Antenna Gain** setting, do the following steps:

1. Click the **Select Antenna Gain:** drop-down menu.
2. Choose the correct antenna gain level. Gain can be manually adjusted from 0 dBm to 36 dBm.
3. Click the **Save** button to save your settings. Alternatively, clear the settings by clicking the **Cancel** button.

#### *Using the Data Packet Encryption setting*

This setting controls whether Advanced Encryption Standard (AES) encryption is applied to outgoing data packets.



#### IMPORTANT

The Data Packet Encryption setting must be the same on all Fluidmesh units that are part of the same network.

In Fluidmesh devices, AES is applied using a proprietary encoding algorithm, enabling industry-grade network security.



#### IMPORTANT

The AES feature must be enabled using a software plug-in (*FM-AES*). Contact your Fluidmesh Networks representative for details.

To use the **Data Packet Encryption** setting, do the following steps:

1. Click the **Data Packet Encryption** drop-down menu.
2. Choose the correct encryption activation setting from the list of drop-down options.



#### NOTE

If Fluidmesh plug-in FM-AES is not installed, the **ENABLED** drop-down option will not be available.

3. Click the **Save** button to save your settings. Alternatively, clear the settings by clicking the **Cancel** button.

### Using the Maximum link length setting

This setting is used to set the maximum distance between the relevant wireless links. It is also used to set media access control (MAC) layer timeouts for transmitted packets.

To choose the **Maximum link length** setting manually, do the following steps:

1. Choose the unit of distance measurement (Kilometres or Miles) by clicking the correct radio button.
2. Enter a distance setting in the **Distance** field.



#### IMPORTANT

If too short a distance value is entered, unnecessary packet re-transmissions may occur, degrading overall link performance.

3. Click the **Save** button to save your settings. Alternatively, clear the settings by clicking the **Cancel** button.

To let the system choose the optimal **Maximum link length** setting and MAC layer timeouts automatically, check the **Automatic** check-box.

### 7.7.2. Static routes

The Static routes window is used to set static routing rules (in other words, manually-configured routing entries, as opposed to routing instructions from a dynamic routing table) for a Fluidmesh unit.



Static routes are typically used if there is a need to do any of the following in context of the network:

- Access a remote subnet that does not belong to a local network
- Access other Fluidmesh radio units or client devices across the local network
- Reach gateways (such as Internet gateways)
- Create networks that include 'fixed' devices (such as CCTV cameras)

To change the Static Routes settings, click the **-static routes** link under **ADVANCED SETTINGS** in the left-hand settings menu.

- The **Static Routes** dialog will be shown (Figure 33 (page 97)).

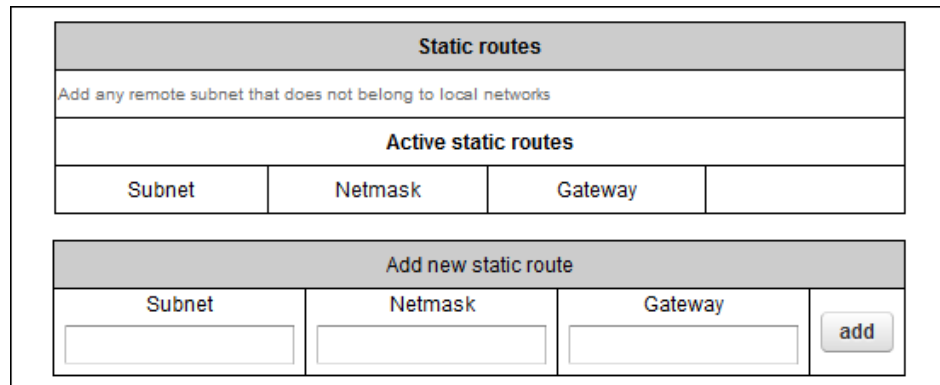

Static routes			
Add any remote subnet that does not belong to local networks			
Active static routes			
Subnet	Netmask	Gateway	
Add new static route			
Subnet	Netmask	Gateway	
<input type="text"/>	<input type="text"/>	<input type="text"/>	<input type="button" value="add"/>

**Figure 33. Configurator GUI (Static Routes window)**

To enter a new static route, do the following steps:

1. Enter the **Subnet**, **Netmask** and **Gateway** designators in the correct fields of the **Add new static route** section.
2. Click the **add** button.
  - If the new static route is valid, it will be added to the **Active static routes** list.

### 7.7.3. Pass lists and Block lists



**IMPORTANT**

The Pass list or Block list feature is only available if the Cisco FM4500 Mobi is set to **Mesh Point** mode or **Mesh End** mode. If the unit is set to **Bridge** mode, the **-pass list / block list** menu option will not be available.

The Pass list or Block list function is a security feature that prevents fake IP addresses from intercepting or intruding on the network.

A Pass list is a group of Fluidmesh transceivers, described as a list of linked pairs. Within the list, each transceiver unit is considered a valid hop in the routing table. If a Pass list is created, all transceiver units that are not on the Pass list are excluded from packet routing.

Conversely, a Block list is a group of Fluidmesh transceivers that are excluded by the routing table computation, and to which data packets must not be routed. If a Block list is created, all transceiver units that are on the Block list are excluded from packet routing.



### IMPORTANT

The same Pass list or Block list must be applied to all transceiver units that are part of a defined network.

Failure to use the same Pass list or Block list may cause units to incorrectly receive, or be incorrectly excluded from, network traffic.

If a Pass list or Block list is applied to a network, the list must be created as a \*.CSV file before being uploaded to each unit in the network. This procedure is described below.

To create a Pass list or Block list, do the following steps:

1. Create a \*.CSV file. Open the file for editing.
2. Enter the Pass list or Block list into the \*.CSV file. Use the following syntax rules to create the list:
  - A Pass list and Block list are mutually exclusive. Pass lists and Block lists are always separate lists, and are never combined.
  - A Pass list is always expressed in the form of `<source>,<destination>,<routing priority>`, where `<source>` is the unique unit ID number of the sending unit, `<destination>` is the unique unit ID number of the receiving unit, and `<routing priority>` is a natural number with a minimum value of 0 and a maximum value of 3.
  - The *smaller* the routing priority value, the *greater* the



### IMPORTANT

*Source* and *destination* values are always unit ID numbers. Do not enter a unit's IP address as a source or destination value.

The unit ID number is printed on the identification label of each unit. This number always takes the following form: **5.a.b.c**

routing priority.

- Block list syntax is the same as shown above, except for one additional rule: Block lists do *not* include routing priority numbers.
  - Unit ID numbers and routing priority values are always separated with commas (,) and never with spaces.
  - To make sure that the packet flow is allowed or blocked in *both* directions, the unit ID numbers for each link in a Pass list or Block list must be listed in forward order *and* in reverse order.
  - If a wireless link is not specified in a Pass list, it will be assigned the lowest routing priority, but will not be completely excluded from routing.
3. **Example 1:** If you want to create a simple Pass list that includes the link between unit ID numbers 5.2.22.136 and 5.29.252.213 ([Figure 34 \(page 99\)](#)), and give the link routing priority 0 (the highest possible priority):
- Cell A1 of the \*.CSV file would contain the parameter `5.2.22.136,5.29.252.213,0`
  - Cell A2 of the \*.CSV file would contain the parameter `5.29.252.213, 5.2.22.136,0`

	A	B
1	<code>5.2.22.136,5.29.252.213,0</code>	
2	<code>5.29.252.213, 5.2.22.136,0</code>	
3		

**Figure 34. Sample Pass list (Example 1)**

4. **Example 2:** If you want to create a Pass list that includes the links between unit ID numbers 5.2.22.136 and 5.29.252.213 (with routing priority 0), and between unit ID numbers 5.29.252.213 and 5.155.105.128 (with routing priority 1) ([Figure 35 \(page 100\)](#)):
- Cell A1 of the \*.CSV file would contain the parameter `5.2.22.136,5.29.252.213,0`
  - Cell A2 of the \*.CSV file would contain the parameter `5.29.252.213, 5.2.22.136,0`
  - Cell A3 of the \*.CSV file would contain the parameter `5.29.252.213,5.155.105.128,1`
  - Cell A4 of the \*.CSV file would contain the parameter `5.155.105.128,5.29.252.213,1`

	A	B
1	5.2.22.136,5.29.252.213,0	
2	5.29.252.213, 5.2.22.136,0	
3	5.29.252.213,5.155.105.128,1	
4	5.155.105.128,5.29.252.213,1	
5		

**Figure 35. Sample Pass list (Example 2)**

- Example 3:** If you want to create a simple Block list that includes the links between unit ID numbers 5.2.22.136 and 5.29.252.213 (Figure 36 (page 100)):
  - Cell A1 of the \*.CSV file would contain the parameter 5.2.22.136,5.29.252.213
  - Cell A2 of the \*.CSV file would contain the parameter 5.29.252.213, 5.2.22.136

	A	B
1	5.2.22.136,5.29.252.213	
2	5.29.252.213, 5.2.22.136	
3		

**Figure 36. Sample Block list (Example 3)**

- Save and close the \*.CSV file.

To upload a Pass list or Block list using the Configurator interface, do the following steps:

- Click the **-pass list / Block list** link under **ADVANCED SETTINGS** in the left-hand settings menu.

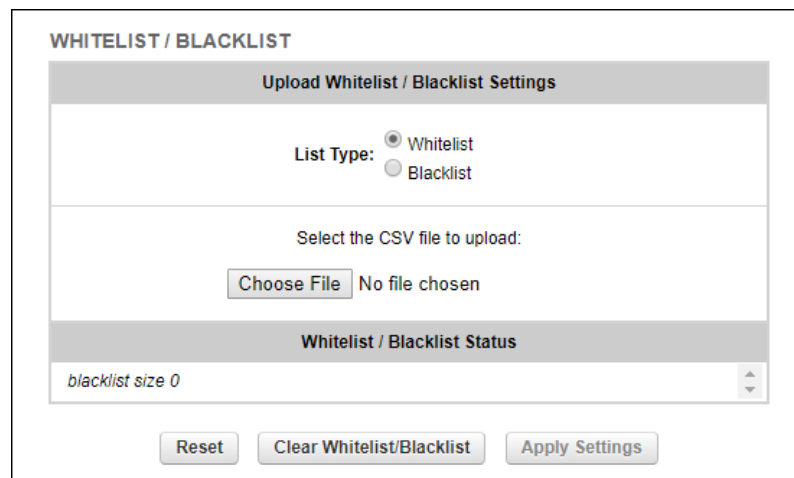

**Figure 37. Configurator (Pass list / Block list dialog)**

- The **Pass list / Block list** dialog will be shown ([Figure 37 \(page 100\)](#)).
2. Choose the type of list to be uploaded by clicking the correct **List Type:** radio button.
  3. Click the **Choose File** button. Upload the saved \*.CSV file using the upload dialog.
    - The contents of the uploaded \*.CSV file will be shown in the **Pass list / Block list Status** section.

To apply the list settings contained in the \*.CSV file, click the **Apply Settings** button.

To clear the Pass list or Block list settings without deleting the \*.CSV file, click the **Clear Pass list or Block list** button.

To delete the Pass list or Block list \*.CSV file, click the **Reset** button.

#### 7.7.4. Multicast

##### *Multicast management for mesh network-capable devices*

Multicast is a group-communication method in which data transmissions are addressed simultaneously to more than one destination computer. Multicast transmissions can be point-to-multipoint, or multipoint-to-multipoint.

By default, if CCTV cameras and devices that operate in a similar fashion are linked to a Fluidmesh transceiver unit operating in **Mesh Point** mode, the unit forwards all multicast traffic generated by the cameras to the closest **Mesh End** unit in the wireless network.

However, depending on network configuration, it may be convenient to forward multicast traffic from one Mesh Point unit to another Mesh Point unit, to allow such tasks as remote recording of the video data flow.

By default, units operating in **Mesh End** mode do not forward multicast traffic to a wireless network. The only exceptions to this rule are universal plug and play (UPnP) and Internet Group Management Protocol (IGMP) traffic.

To redirect traffic flow to a **Mesh Point** unit, all multicast flow redirection information must be specified using the Multicast settings on a **Mesh End** unit.



#### NOTE

To change the unit's Multicast settings, make sure that the unit is in **Mesh End** mode as shown in ["Changing the operational mode" \(page 62\)](#). Multicast controls are not available if the unit is set to **Mesh Point** mode.

To set multicast rules on a **Mesh End** unit, do the following steps:

1. Find the **Mesh End** unit in the wireless network that is most suitable for forwarding multicast traffic.



**NOTE**

Multicast flow redirection information can only be specified from a **Mesh End** unit. The Mesh End unit will distribute the multicast data to all other Fluidmesh devices in the wireless network.

2. Connect to the Mesh End unit as shown in “[Accessing the Cisco FM4500 Mobi for device configuration](#)” (page 47).
3. Click the **-multicast** link under **ADVANCED SETTINGS** in the left-hand settings menu.
  - The **MULTICAST** dialog will be shown ([Figure 38 \(page 102\)](#)).

**MULTICAST**

**Multicast routes**

List of multicast routes already present. You can manually add multicast routes.  
Multicast network masks and wildcard addresses are ignored in Prodigy 1.0 mode.

Multicast Group	Destination Address

**Add a new multicast route**

Use these forms to add new static multicast routes.  
In the Multicast Group field it is possible to specify multicast network masks such as 224.1.1.0/24.  
The Destination Address field accepts the following special values:  
- 5.255.255.255 is a wildcard address that indicates all units of the mesh network.  
- 5.0.0.0 is special address that forces each unit to send multicast traffic to the primary mesh end. This is particularly useful when the mesh ends fast-failover is enabled.

<div style="border: 1px solid #ccc; width: 100%; height: 20px; margin-bottom: 5px;"></div> <p style="font-size: small; margin: 0;">Multicast Group</p>	<div style="border: 1px solid #ccc; width: 100%; height: 20px; margin-bottom: 5px;"></div> <p style="font-size: small; margin: 0;">Destination Address</p>	<input type="button" value="add"/>
--	--	------------------------------------

**Figure 38. Multicast dialog (Mesh End mode)**

4. Compile the needed multicast rule. Use the following syntax rules to create the rule:
  - A multicast rule consists of two parts: a multicast group designator and a destination address.
  - Define the multicast group designator. For example, the designator *224.1.1.0/24* indicates all multicast groups in the range *224.1.1.1* through *224.1.1.254*.
  - The destination address consists of one or more Fluidmesh unit ID numbers, in the form **5.a.b.c**. These ID numbers belong to the physical Fluidmesh device or devices to which the multicast traffic must be forwarded.
  - Destination-address wildcards can also be used. For example, the destination address *5.255.255.255* represents all Fluidmesh units in the wireless network.

5. Enter the multicast group designator in the **Multicast Group** field.
6. Enter the destination address in the **Destination Address** field.
7. Click the **add** button.
  - The new multicast route will be shown in the **Multicast routes** section.

To enable or disable multicast forwarding on a **Bridge** unit, do the following steps:

1. Connect to the Bridge unit as shown in “[Accessing the Cisco FM4500 Mobi for device configuration](#)” (page 47).
2. Click the **-multicast** link under **ADVANCED SETTINGS** in the left-hand settings menu ([Figure 39 \(page 103\)](#)).
  - The **Multicast** dialog will be shown.



**Figure 39. Multicast dialog (Bridge mode)**

- The unit ID number of the local unit is shown as the **LOCAL BRIDGE ID** ([Figure 40 \(page 103\)](#)).
- The unit ID number of the Bridge unit to which the local unit is linked is shown to the right of '**ASSOCIATED WITH REMOTE BRIDGE ID**'.

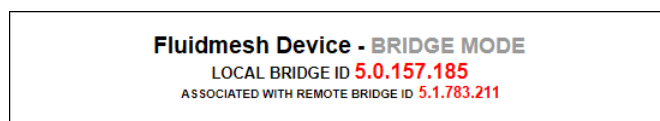

**Figure 40. Configurator interface (Unit ID information)**

3. Choose the Enabled or Disabled option from the **Multicast Forwarding:** drop-down menu.
4. Save the multicast settings by clicking the **Save** button. Alternatively, clear the settings by clicking the **Reset** button.

### Configuring Multicast within a Layer-3 network

Within a typical Layer-3 network, consider a scenario in which Multicast traffic must be routed in both directions between Fluidity-enabled, vehicle-mounted radio transceivers, and the global gateway unit that governs data traffic through the core network.

In the case above, since different multicast groups must be used for upstream and downstream traffic, consider that group designator 224.5.5.5 is being used to route traffic from the vehicle radios to the global gateway, and that group designator 224.5.5.6 is being used to route traffic from the global gateway to the vehicle radios.

Apply the needed multicast rules by doing the steps that follow:

1. Identify all Mesh End units belonging to each subnet cluster in the Layer-3 network.
2. Enable upstream (vehicle to infrastructure) Multicast traffic by adding multicast route 224.5.5.5 / 5.a.b.c to the Mesh End unit in each subnet cluster, where 5.a.b.c is the actual Mesh ID number of the global gateway unit.



**IMPORTANT**

If TITAN is enabled at core network level and dual-redundant global gateway units are installed, do not enter the global gateway's actual Mesh ID number as the Destination Address. Instead, use Destination Address 5.0.0.0

3. Enable downstream (infrastructure to vehicle) Multicast traffic by adding multicast route 224.5.5.6 / 5.255.255.255 to the global gateway unit, *and* to the Mesh End unit in each subnet cluster.



**NOTE**

5.255.255.255 is the wildcard address for all Mesh ID destinations within the network.

### 7.7.5. SNMP configuration

The SNMP window can be used to configure an SNMP v2c or SNMP v3 service to run on the Cisco FM4500 Mobi.

Walk-throughs (no agent-to-manager notifications) and traps (agent-to-manager notifications enabled) are both supported. If SNMP traps are enabled, you can specify the server address to which monitoring information must be sent.



**IMPORTANT**

The same SNMP configuration must be set for all Fluidmesh units in the wireless network.

For detailed information on Fluidmesh unit SNMP configuration, refer to the *Fluidmesh SNMP FM-MIB OID Table* and MIB configuration files. These can be downloaded from the Fluidmesh Partner Portal (**Documentation** section > **User Manuals** > **Advanced Manuals**.)



To change the SNMP settings, do the following steps:

- Click the **-snmp** mode link under **ADVANCED SETTINGS** in the left-hand settings menu.
  - The default **SNMP** dialog will be shown (Figure 41 (page 105)).

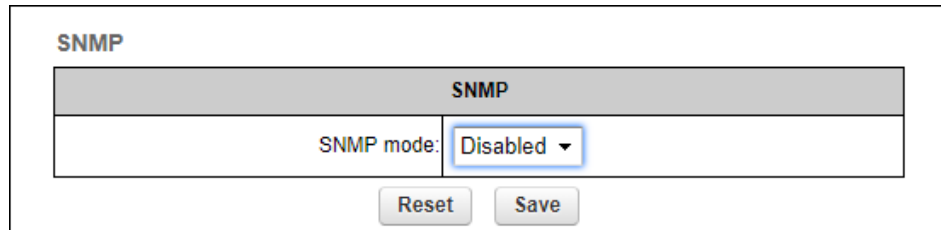

The screenshot shows the SNMP configuration dialog. At the top, it says "SNMP". Below that is a table with a header row "SNMP" and one data row. The data row has a label "SNMP mode:" and a dropdown menu currently set to "Disabled". Below the table are two buttons: "Reset" and "Save".

**Figure 41. SNMP dialog (SNMP disabled)**



**NOTE**

By default, Fluidmesh units are shipped from the factory with SNMP disabled.

*Using SNMP v2c*

To change the unit's SNMP mode to **v2c** and configure the unit accordingly, do the following steps:

1. Click the **SNMP mode** drop-down, and click the **v2c** option.
  - The **SNMP v2c** settings dialog will be shown (Figure 42 (page 105)).

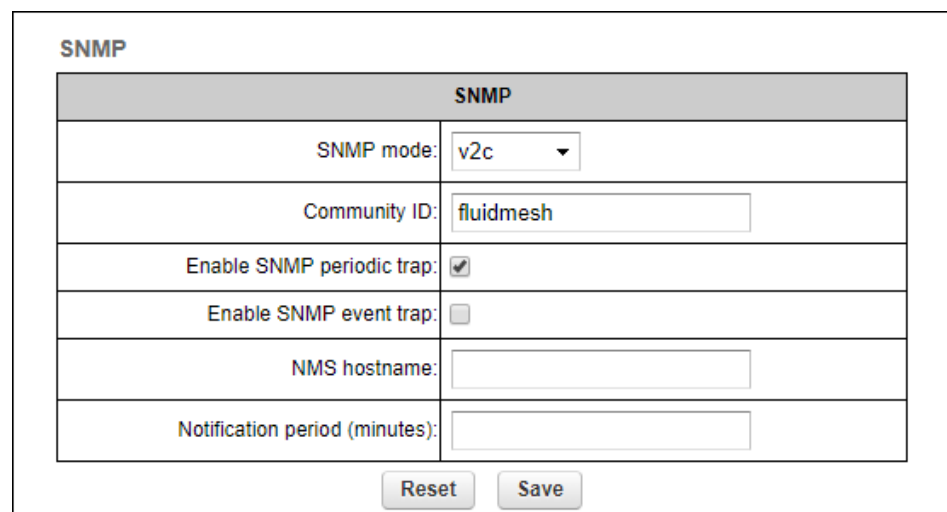

The screenshot shows the SNMP configuration dialog with v2c selected. At the top, it says "SNMP". Below that is a table with a header row "SNMP" and several data rows. The data rows are: "SNMP mode:" with a dropdown menu set to "v2c"; "Community ID:" with a text input field containing "fluidmesh"; "Enable SNMP periodic trap:" with a checked checkbox; "Enable SNMP event trap:" with an unchecked checkbox; "NMS hostname:" with an empty text input field; and "Notification period (minutes):" with an empty text input field. Below the table are two buttons: "Reset" and "Save".

**Figure 42. SNMP dialog (v2c selected)**

2. Enter a community identity value in the **Community ID:** field.



#### IMPORTANT

The same community identity value must be set for all Fluidmesh units in the wireless network.

3. SNMP traps can be enabled for significant system-related events. If needed, enable SNMP event traps by checking the **Enable SNMP event trap:** check-box, and enter the name of the network management station (NMS) host in the **NMS hostname:** field.



#### IMPORTANT

The NMS host to which traps are sent must have an SNMP agent that is configured to collect SNMP v2c traps.

4. You can also configure the unit to send SNMP traps at defined periodic intervals. If needed, enable periodic SNMP traps by checking the **Enable SNMP periodic trap:** check-box, and enter the name of the network management station (NMS) host in the **NMS hostname:** field.
5. Save the SNMP settings by clicking the **Save** button. Alternatively, clear the settings by clicking the **Reset** button.

### Using SNMP v3

To change the unit's SNMP mode to **v3** and configure the unit accordingly, do the following steps:

1. Click the **SNMP mode** drop-down, and click the **v3** option.
  - The **SNMP v3** settings dialog will be shown ([Figure 43 \(page 107\)](#)).

SNMP	
SNMP mode:	v3
SNMP v3 username:	fluidmesh
SNMP v3 password:	.....
Show SNMP v3 password:	<input type="checkbox"/>
SNMP v3 authentication proto:	MD5
SNMP v3 encryption:	No Encryption
SNMP v3 encryption passphrase:	.....
Show SNMP v3 encryption passphrase:	<input type="checkbox"/>
Enable SNMP periodic trap:	<input type="checkbox"/>
Enable SNMP event trap:	<input type="checkbox"/>
Engine ID:	0x80001f88804879aadd5b313a99
NMS hostname:	
Notification period (minutes):	

**Figure 43. SNMP dialog (v3 selected)**

- Enter an SNMP v3 user name in the **SNMP v3 username:** field.



**IMPORTANT**

The same SNMP v3 user name must be set for all Fluidmesh units in the wireless network.

- To change the current SNMP v3 password, enter a new password in the **SNMP v3 password:** field. The default password is **fluidmesh**. To show the password as it is being typed, check the **Show SNMP v3 password:** check-box.
- Choose the correct authentication protocol from the **SNMP v3 authentication proto:** drop-down. The available options are **MD5** and **SHA**.



**IMPORTANT**

The same SNMP authentication protocol must be set for all Fluidmesh units in the wireless network.

- If needed, choose the correct encryption protocol from the **SNMP v3 encryption:** drop-down. The available options are **No**

**Encryption, DES** (Data Encryption Standard) and **AES** (Advanced Encryption Standard).



**IMPORTANT**

The same encryption protocol must be set for all Fluidmesh units in the wireless network.

6. To change the current encryption passphrase, enter a new passphrase in the **SNMP v3 encryption passphrase:** field. The default encryption passphrase is *fluidmesh*. To show the passphrase as it is being typed, check the **Show SNMP v3 encryption passphrase:** check-box.
7. SNMP traps can be enabled for significant system-related events. If needed, enable SNMP event traps by checking the **Enable SNMP event trap:** check-box, and enter the name of the network management station (NMS) host in the **NMS hostname:** field.



**IMPORTANT**

The NMS host to which traps are sent must have an SNMP agent configured to collect v2c traps.

8. You can also configure the unit to send SNMP traps at defined periodic intervals. If needed, enable periodic SNMP traps by checking the **Enable SNMP periodic trap:** check-box, and enter the name of the network management station (NMS) host in the **NMS hostname:** field.
9. Save the SNMP settings by clicking the **Save** button. Alternatively, clear the settings by clicking the **Reset** button.

### 7.7.6. RADIUS configuration

The **RADIUS** window contains the controls to provide centralized authentication, authorization, and accounting management using the remote authentication dial-in user service (RADIUS) networking protocol.



**IMPORTANT**

The RADIUS feature is only available if the Cisco FM4500 Mobi is set to **Mesh Point** mode or **Mesh End** mode. If the unit is set to **Bridge** mode, the **-radius** menu option will not be available.

The RADIUS functionality will fail to operate if the network time protocol (NTP) feature is not enabled and configured.



**IMPORTANT**

Use of this window requires extensive familiarity with the RADIUS networking protocol. Do not change these settings unless there is a specific need to do so.

To change the RADIUS settings for the Fluidmesh unit, do the following steps:

1. Enable and configure network time protocol (NTP) as shown in [“NTP Configuration” \(page 111\)](#).
2. Click the **-radius** link under **ADVANCED SETTINGS** in the left-hand settings menu.
  - The **RADIUS** dialog will be shown ([Figure 44 \(page 109\)](#)).

**RADIUS**

RADIUS	
RADIUS Mode:	Enabled ▾
IP address / hostname:	<input type="text"/>
Port:	1812 ▾
Secondary IP address / hostname:	<input type="text"/>
Secondary Port:	1812 ▾
Secret:	<input type="text"/> <input type="checkbox"/> show
Expiration (s):	28800 ▾
Authentication	
Authentication Method:	MSCHAPV2 ▾
Username:	<input type="text"/>
Password:	<input type="text"/> <input type="checkbox"/> show
Inner Authentication Method:	none ▾

**Figure 44. Configurator GUI (RADIUS dialog)**

3. Choose the RADIUS mode for the device by clicking the **RADIUS Mode** drop-down and selecting one of the following options:
  - **Disabled:** RADIUS functionality will be disabled.
  - **Enabled:** RADIUS functionality will be enabled, and the configuration options will be shown.

- **Passthrough:** If the device is a trackside-mounted Fluidity device, this parameter can be used to simultaneously activate RADIUS device authentication, and enable RADIUS passthrough (communication between RADIUS-authenticated vehicle-mounted devices and non-authenticated trackside-mounted devices).
4. Enter the IP address or host name of the RADIUS server in the **IP address / hostname** field.
  5. By default, the RADIUS port number is **1812**. Do not change the port number unless there is a specific need to do so.
  6. Enter the RADIUS access password in the **Secret** field. To read the password as it is typed, check the **show** check-box.
  7. By default, the RADIUS inactivity **Expiration (s)** period is 28 800 seconds (8 hours). Do not change the expiration period unless there is a specific need to do so.
  8. Choose the data authentication method by clicking the **Authentication Method** drop-down and clicking the correct option. Available options are:
    - **MSCHAPV2** (Microsoft Challenge-Handshake Authentication Protocol V2)
    - **MD5** (Hash function producing a 128-bit hash value)
    - **GTC** (Generic Token Card)
    - **TTLS** (Tunneled Transport Layer Security)
    - **PEAP** (Protected Extensible Authentication Protocol)
  9. Enter the personal username for access to the RADIUS server in the **Username** field.
  10. Enter the personal password for access to the RADIUS server in the **Password** field. To read the password as it is typed, check the **show** check-box.
  11. Available *Inner Authentication Methods* depend on which *Authentication Method* has been chosen. If applicable, choose an inner authentication method by clicking the **Inner Authentication Method** drop-down and clicking the correct option. Available options are shown in the following table:

**Table 5. Available inner authentication methods (per authentication methods)**

Authentication Method	Available Inner Authentication Methods
MSCHAPV2	None
MD5	None
GTC	None

Authentication Method	Available Inner Authentication Methods
TTLS	<ul style="list-style-type: none"> <li>• PAP (Password Authentication Protocol)</li> <li>• CHAP (Challenge-Handshake Authentication Protocol)</li> <li>• MSCHAP (Microsoft Challenge-Handshake Authentication Protocol)</li> <li>• MSCHAPV2</li> <li>• MD5</li> <li>• GTC</li> </ul>
PEAP	<ul style="list-style-type: none"> <li>• MSCHAPV2</li> <li>• MD5</li> <li>• GTC</li> </ul>

12. Save the RADIUS settings by clicking the **Save** button. Alternatively, clear the settings by clicking the **Reset** button.

### 7.7.7. NTP Configuration

All Fluidmesh radio transceiver units have a built-in clock.

No manual time-setting controls are provided. Instead, the unit has network time protocol (NTP) functionality that allows it to synchronize its time settings with a chosen internet time server. If the unit cannot synchronize with its primary time server, and the host name of a backup time server is entered, the unit defaults to synchronizing with the backup server.



**CAUTION**

The same NTP configuration must be set for all Fluidmesh units in the wireless network.

If the same NTP settings are not applied to all units, the network may encounter timestamp conflicts and/or equipment malfunctions.

To change the NTP settings, do the following steps:

1. Click the **-ntp** link under **ADVANCED SETTINGS** in the left-hand settings menu.
  - The **NTP** dialog will be shown ([Figure 45 \(page 112\)](#)).

**NTP - Network Time Protocol**

NTP	
Enable NTP:	<input checked="" type="checkbox"/>
NTP server hostname:	<input type="text" value="time.windows.com"/>
Secondary NTP server (optional):	<input type="text" value="time.nist.gov"/>
Select Timezone:	<input type="text" value="Europe/Paris"/>

**Figure 45. Configurator GUI (NTP dialog)**

2. Enable NTP synchronization by checking the **Enable NTP** checkbox.
3. Enter the host name of a chosen primary NTP server in the **NTP server hostname:** field.



**IMPORTANT**

The NTP server host names shown in [Figure 45](#)(page 112) are for reference purposes only. Your company policy may dictate that you use one or more specific time servers.

4. If needed, enter the host name of a chosen secondary NTP server in the **Secondary NTP server (optional):** field.
5. Select the time zone in which the unit is installed by clicking the **Select Timezone:** drop-down menu and clicking the correct time zone option.
6. Save the NTP settings by clicking the **Save** button. Alternatively, clear the settings by clicking the **Reset** button.

### 7.7.8. L2TP configuration



**IMPORTANT**

The L2TP configuration option is only available if the Cisco FM4500 Mobi is set to **Mesh Point** mode or **Mesh End** mode. If the unit is set to **Bridge** mode, the **-l2tp configuration** menu option will not be available.

The L2TP feature must be enabled using a software plug-in (Fluidmesh part number *FM-L2TP*). Contact your Fluidmesh Networks representative for details.

Layer 2 Tunneling Protocol (L2TP) functionality allows Fluidmesh radio transceivers to support integration with virtual private networks (VPNs).



Fluidmesh hardware devices are shipped from the factory with L2TP functionality disabled. To change the unit's L2TP settings, do the following steps:

1. Click the **-l2tp configuration** link under **ADVANCED SETTINGS** in the left-hand settings menu.

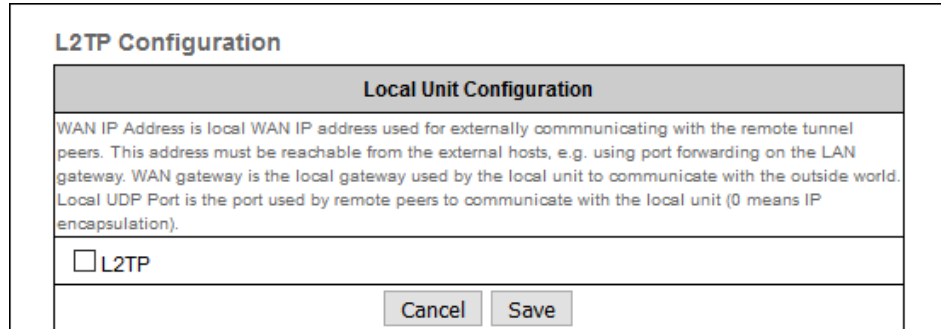

**Figure 46. Configurator GUI (L2TP Configuration dialog)**

- The **L2TP Configuration** dialog will be shown ([Figure 46 \(page 113\)](#)).
2. To enable L2TP functionality for the unit, check the **L2TP** checkbox.
    - The L2TP configuration settings window will be shown.
  3. When the L2TP configuration has been set, save the settings by clicking the **Save** button. Alternatively, clear the settings by clicking the **Reset** button.



**IMPORTANT**  
A detailed description of L2TP configuration methods is beyond the scope of this manual. For detailed instructions on how to set the L2TP configuration, refer to the *Fluidmesh Networks L2TPv3 Configuration Manual*.

### 7.7.9. VLAN settings

#### VLAN configuration

The **VLAN SETTINGS** window contains controls to connect the Cisco FM4500 Mobi to one or more virtual local area networks (VLANs) that are part of the local wireless network.



**IMPORTANT**  
The VLAN feature must be enabled using a software plug-in (Fluidmesh part number *FM-VLAN*). Contact your Fluidmesh Networks representative for details.

The Cisco FM4500 Mobi features smart self-management of integration with connected VLANs, with minimal configuration time and avoidance of potential configuration errors. This is done by A) relying on the data-processing configuration of a connected network switch, and B) obeying predefined rules for management of incoming and outgoing data packets.



**IMPORTANT**  
 For detailed information on the predefined rules for smartVLAN packet management, refer to the [“Rules for packet management” \(page 115\)](#) table at the bottom of this section.

To connect the unit to a VLAN that is part of the local wireless network, do the following steps:

1. Click the **-vlan settings** link under **ADVANCED SETTINGS** in the left-hand settings menu.
  - The **VLAN SETTINGS** dialog will be shown ([Figure 47 \(page 114\)](#)).

**VLAN SETTINGS**

When the Native VLAN is enabled (VID != 0), untagged packets received on the trunk port will be assigned to the specified VLAN ID. When disabled (VID = 0), VLAN trunking will operate according to the IEEE 802.1Q standard, i.e. only tagged packets will be allowed on the port (including those of the management VLAN).

VLAN Settings	
Enable VLANs:	<input type="checkbox"/>
Management VLAN ID:	<input type="text" value="1"/>
Native VLAN ID:	<input type="text" value="1"/>

**Figure 47. Configurator GUI (VLAN SETTINGS dialog)**

2. Connect the unit to a VLAN that is part of the local wireless network by checking the **Enable VLANs** check-box.
3. Check the **Enable VLANs** check-box.
4. Enter the management identification number of the VLAN (used to communicate with the device's operating system) in the **Management VLAN ID:** field.



**NOTE**  
 The same Management VLAN ID must be used on all Fluidmesh devices that are part of the same mesh network.

5. Enter the native identification number (the VLAN ID implicitly assigned to untagged packets received on trunk ports) in the **Native VLAN ID:** field.

6. Save the VLAN settings by clicking the **Save** button. Alternatively, clear the settings by clicking the **Reset** button.

### Rules for packet management

Parameter	Default value
<b>Default VLAN configuration</b>	
The factory-set VLAN parameters for the unit are as follows:	
Management VLAN ID (MVID)	1
Native VLAN ID (NVID)	1
Native VLAN processing	Enabled
Port mode (all Ethernet ports)	Smart
<b>Traffic classes</b>	
The system classifies incoming data packets according to the following definitions:	
Signaling	Ethernet protocol type \$8847 or \$09xx
User	All other traffic
Packet tagged with MVID	Packet passed
<b>Access port rules for incoming packets (Case and Action)</b>	
Untagged packet from Fluidmesh device	Packet passed
Untagged packet, VID not configured	Packet passed
Untagged packet, VID configured	Packet tagged with specified VID
Tagged packet with valid VID	Packet dropped
Tagged packet with null (0) VID	Packet dropped
<b>Access port rules for outgoing packets (Case and Action)</b>	
Tagged packet with configured and allowed VID	Packet passed
Packet from Fluidmesh device	Packet passed
Tagged packet, port VID not configured	Packet passed
Tagged packet with valid but disallowed VID	Packet dropped
Tagged packet with null (0) VID	Packet dropped
<b>Access port rules for incoming packets with unit in Smart Mode (Case and Action)</b>	
Untagged packet	If native VLAN = ON: Packet passed (tagged with NVID) If native VLAN = OFF: Packet dropped
Tagged packet (any VID, no checks)	Packet passed with original tag
<b>Access port rules for outgoing packets with unit in Smart Mode (Case and Action)</b>	
Packets originating from Fluidmesh devices (for example: FM Racer interface)	Packet implicitly tagged with MVID, next rules apply
Signalling traffic	Packet implicitly tagged with MVID, next rules apply

Parameter	Default value
Tagged with valid VID (1 – 4095), not NVID	Packet passed (tagged)
Tagged with null VID (0) or NVID	Packet passed (untagged)
<b>Access port rules for incoming packets with unit in Bridge Mode (Case and Action)</b>  The Native VLAN enable setting is used to control whether the <i>Management VLAN</i> should be tagged or not.	
Untagged packet, to remote devices	Pass packet to remote peer
Tagged packet (any VID), to remote devices	Pass packet to remote peer with original tag
Untagged packet, to local unit kernel	If native VLAN = ON: Packet passed to kernel, tagged with NVID  If native VLAN = OFF: Packet not passed to kernel
Tagged packet (any VID), to local unit kernel	If native VLAN = ON: Packet not passed to kernel  If native VLAN = OFF: Packet passed to kernel if VID = NVID
<b>Access port rules for outgoing packets with unit in Bridge Mode (Case and Action)</b>	
Tagged packet with valid VID from remote peer	Packet passed (tagged)
Tagged packet with null (0) VID from remote peer	Packet passed (untagged)
Packet from local unit kernel	If native VLAN not equal to MVID: Packet passed, tagged with MVID  If native VLAN = MVID: Packet passed, untagged

### 7.7.10. Fluidity settings



#### IMPORTANT

The Fluidity tool is only available if the Cisco FM4500 Mobi is set to **Mesh Point** mode or **Mesh End** mode. If the unit is set to **Bridge** mode, the **-Fluidity™** menu option will not be available.

Fluidity™ is Fluidmesh's proprietary trackside and vehicle-to-ground data transfer protocol for video, voice and data communication.

The **FLUIDITY** window contains controls to change the unit's Fluidity settings. To change the settings, do the following steps:

1. Click the **-Fluidity™** link under **ADVANCED SETTINGS** in the left-hand settings menu.

- The **FLUIDITY** dialog will be shown (Figure 48 (page 117)).

**FLUIDITY**

Fluidity Settings	
<p>The unit can operate in 3 modes: Infrastructure, Infrastructure (wireless relay), Vehicle.                      The unit must be set as Infrastructure when it acts as the entry point of the infrastructure for the mobile vehicles and it is connected to a wired network (backbone) which possibly includes other Infrastructure nodes. The unit must be set as Infrastructure (wireless relay) ONLY when it is used as a wireless relay agent to other Infrastructure units. In this operating mode, the unit MUST NOT be connected to the wired network backbone as it will use the wireless connection to relay the data coming from the mobile units. The unit must be set as Vehicle when it is mobile. Vehicle ID must be set ONLY when the unit is configured as Vehicle. Specifically, Vehicle ID must be a unique among all the mobile units installed on the same vehicle. Unit installed on different vehicles must use different Vehicle IDs.                      The Network Type field must be set according to the general network architecture. Choose Flat if the mesh and the infrastructure networks belong to a single layer-2 broadcast domain. Use Multiple Subnets if they are organized as different layer-3 routing domains.</p>	
Fluidity	<input type="checkbox"/> Enable
Unit Role:	Infrastructure <span style="float: right;">▼</span>
Network Type:	Flat <span style="float: right;">▼</span>
<p>The following advanced settings allow to fine-tune the performance of the system depending on the specific environment. Please do not alter this settings unless you have read the manual first and you know what you are doing.</p> <p>The Handoff Logic controls the algorithm used by a mobile radio to select the best infrastructure point to connect to. In Normal mode, the point providing the strongest signal is selected. In Load Balancing mode, the mobile radio prefers the point which provides the best balance between signal strength and amount of traffic carried.</p> <p>The Rate Adaptation selects the rate control algorithm which will be used by the radio to determine the optimal modulation coding and speed for packet transmission.</p>	
Handoff Logic:	Standard <span style="float: right;">▼</span>
Rate Adaptation:	Standard <span style="float: right;">▼</span>

**Figure 48. Configurator GUI (FLUIDITY dialog for transceiver devices)**

2. Fluidmesh radio transceivers are shipped from the factory with Fluidity functionality disabled. Enable Fluidity functionality by checking the **Fluidity** check-box.
3. Select the correct role for the unit by clicking the **Unit Role:** drop-down and clicking the correct option from the list below:
  - **Infrastructure:** Choose this setting if the unit is connected to a wired LAN and/or a network that includes other Infrastructure nodes, and the unit acts as the network infrastructure entry point for mobile vehicles.
  - **Infrastructure (wireless relay):** Only choose this setting if the unit is used as a wireless relay agent to other infrastructure units.



**IMPORTANT**

If a unit is set to **Infrastructure (wireless relay)** mode, do not connect the unit to the wired LAN.

- **Vehicle:** Choose this setting if the unit is installed on or in a moving vehicle.
4. If the **Unit Role** has been set as **Vehicle**, assign the unit a vehicle identity using either of the methods below:
- Allow the unit to automatically generate a unique vehicle identity by checking the **Enable** check-box to the right of the **Automatic Vehicle ID:** heading.
  - Assign a vehicle identity manually by un-checking the **Enable** check-box to the right of the **Automatic Vehicle ID:** heading, and manually entering an identification string in the **Vehicle ID:** field.



**IMPORTANT**

If vehicle identities have been manually assigned, the **Vehicle ID** string must be unique for every individual Fluidmesh unit operating on the same network, even if more than one Fluidmesh unit is installed on the same vehicle.

5. The network type must be set in accordance with the general network architecture. Select the correct network type designation for the unit by clicking the **Network Type:** drop-down and clicking the correct option from the list below:
- **Flat:** Choose this setting if the wireless mesh network and the infrastructure network both belong to a single layer-2 broadcast domain.
  - **Multiple Subnets:** Choose this setting if the wireless mesh network and the infrastructure network are organized as separate layer-3 routing domains.
6. Save the Fluidity settings by clicking the **Save** button. Alternatively, clear the settings by clicking the **Reset** button.

## Handoff logic and rate adaptation settings



### CAUTION

The following settings are intended for use by qualified network engineers. Do not change these settings unless there is a specific need to do so.

For detailed information on how to set Handoff logic and Rate adaptation, refer to the *Fluidmesh Networks Fluidity Configuration Manual*.

The Handoff Logic setting controls the unit's choice of infrastructure point with which to connect. Select the correct handoff logic setting for the unit by clicking the **Handoff Logic**: drop-down and clicking the correct option from the list below:

- **Standard:** The unit connects to the transceiver providing the strongest signal.
- **Load Balancing:** The unit connects to the transceiver that provides the most suitable balance between signal strength and the amount of traffic presently being carried.
- **Allow V2V:** in cases where a vehicle-mounted unit is not able to communicate directly with an infrastructure point, this setting allows data traffic to be routed from the source vehicle through a second vehicle to an infrastructure point.



### IMPORTANT

If the Allow V2V setting is chosen, note the following points:

- *Ad hoc* communication (in other words, communication between vehicle radio units that bypasses infrastructure radio units) is not supported.
- A maximum of two hops are allowed (for example, vehicle-to-vehicle-to-infrastructure).

The Rate Adaptation setting controls the unit's choice of modulation coding and speed of packet transmission. Select the correct rate adaptation setting for the unit by clicking the **Rate Adaptation**: drop-down and clicking the correct option from the list below:

- **Standard:** This option applies a standard reactive rate selection as used by WiFi access points.
- **Advanced:** This option applies Fluidmesh's proprietary predictive rate selection algorithm.

Save the Fluidity settings by clicking the **Save** button. Alternatively, clear the settings by clicking the **Reset** button.

### 7.7.11. Miscellaneous settings



#### IMPORTANT

Support for FIPS, CANBUS, PROFINET and QNET are only available if the corresponding plug-ins are installed. If the corresponding plug-in is not installed, the check-box for the relevant option will not be available.

The following plug-ins are needed to activate these features:

- FIPS: *FM-FIPS*
- CANBUS: *FM-CANBUS*
- PROFINET: *FM-PROFINET*
- QNET: *FM-QNET*

Note that FIPS support is not available for the FM1000 Gateway and FM10000 Gateway.

Contact your Fluidmesh Networks representative for details.

The **MISC SETTINGS** window contains controls to change the following settings:

- The device name, as used to identify the Cisco FM4500 Mobi within the FMQuadro network map and to other Fluidmesh utilities.
- The operation of the physical Reset button on the unit.
- Device firmware upgrades by trivial file transfer protocol (TFTP).
- The unit's federal information processing standards (FIPS) 140-2 compliance settings (if applicable).
- The unit's controller area network (CANBUS) support settings (if applicable).
- The unit's process field net (PROFINET) support settings (if applicable).
- The unit's Neutrino Qnet (QNET) support settings (if applicable).

To change any of the miscellaneous settings, do the following steps:

1. Click the **-misc settings** link under **ADVANCED SETTINGS** in the left-hand settings menu.
  - The **MISC SETTINGS** dialog will be shown ([Figure 49 \(page 121\)](#)).



MISC SETTINGS	
<b>Device</b>	
Name:	<input type="text" value="In-pit-Camera-2-D1"/>
<b>Reset Button Settings</b>	
Reset Button function:	<input type="text" value="Enabled"/>
<b>CANBUS Settings</b>	
Enable CANBUS:	<input checked="" type="checkbox"/>
<b>Automatic TFTP Firmware Upgrade</b>	
Enable Automatic Upgrade:	<input type="checkbox"/>
TFTP Server:	<input type="text"/>
Check Period (hours):	<input type="text" value="1"/>
<input type="button" value="Check Now"/>	
<input type="button" value="Reset"/> <input type="button" value="Save"/>	

**Figure 49. Configurator GUI (MISC SETTINGS dialog)**

- Set the device name by typing it in the **Name:** field.



**NOTE**

It is not essential to specify the device name, but it is strongly recommended. Failure to specify the device name may make the unit difficult to recognize in situations where more than one unit is being dealt with at the same time (for example, when using utilities such as the FMQuadro network map).

- Set the functionality of the unit's hardware **Reset** button by clicking the **Reset Button function:** drop-down and clicking the needed option as described below:

- Disabled:** The hardware **Reset** button will be disabled.



**NOTE**

If the **Disabled** option is chosen, you can still reboot or do a hard reset of the unit using the Configurator GUI. See ["Resetting the unit to factory defaults" \(page 137\)](#) for more information.

- Enabled:** The hardware **Reset** button will be enabled.
- Factory:** The hardware **Reset** button functionality will be set to its factory default configuration (enabled).

4. To enforce FIPS 140-2 compliance for data transmitted by the unit, make sure the FM-FIPS plug-in is installed, then check the **Enable FIPS:** check-box.
5. To enable CANBUS support for the unit, make sure the FM-CANBUS plug-in is installed, then check the **Enable CANBUS:** check-box.
6. To enable PROFINET support for the unit, make sure the FM-PROFINET plug-in is installed, then check the **Enable PROFINET:** check-box.
7. To enable QNET support for the unit, make sure the FM-QNET plug-in is installed, then check the **Enable QNET:** check-box.
8. To enable automatic device firmware updates using TFTP, do the steps that follow:
  - a. Check the **Enable Automatic Upgrade** check-box.
  - b. Enter the IP address of the authorized TFTP server containing the firmware-update source files in the **TFTP Server** field.
  - c. Enter the periodic interval at which the device checks for a newer firmware upgrade package in the **Check Period (hours)** field.
  - d. To do an immediate check for a newer firmware upgrade package, click the **Check Now** button.
    - If a newer firmware package than the existing package is found, the newer package will be installed immediately.
9. Save the miscellaneous settings by clicking the **Save** button. Alternatively, clear the settings by clicking the **Reset** button.

## 7.8. Management settings

### 7.8.1. View Mode settings

The View Mode window allows the system administrator to grant and prohibit access to device configuration settings by category.



**IMPORTANT**

Changing the default password to a strong password is an extremely important step in preventing security breaches.

If you have logged into the configurator interface using default login credentials, you will see a notification banner at the bottom of the screen ([Figure 50 \(page 123\)](#)).

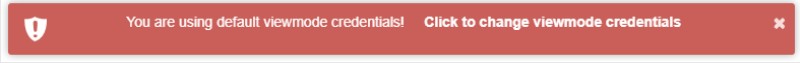

**Figure 50. Default credentials notification banner**

Click the banner to change the view mode credentials. You will be taken to the **VIEW MODE SETTINGS** section.

To gain editing privileges for the View Mode settings window requires the correct administrator user name and password. To change the administrator user name and password for the current user, do the following steps:

1. Click the **-view mode settings** link under **MANAGEMENT SETTINGS** in the left-hand settings menu. **VIEW MODE SETTINGS**
  - The **Viewmode Credentials** section will be shown ([Figure 51 \(page 123\)](#)).

Viewmode Credentials	
View Mode Username:	<input style="width: 80%;" type="text" value="user"/>
View Mode User Password:	<input style="width: 80%;" type="password" value="••••••••"/>
Show Password:	<input type="checkbox"/>

**Figure 51. VIEW MODE SETTINGS dialog (Viewmode Credentials section)**

2. Enter the new user name in the **View Mode Username:** field.
3. The default password is *viewmode*. Enter the new password in the **View Mode User Password:** field.



**NOTE**

The new password must be a minimum of eight characters, and include at least one capital letter and one number.

4. To show the password as it is being typed, check the **Show Password** check-box.
5. Save the Viewmode Credentials settings by clicking the **Change** button. Alternatively, clear the settings by clicking the **Reset** button.

To change the View Mode settings, do the following steps:

1. Log in to the unit's Configurator GUI with Administrator credentials. See [“Accessing the Cisco FM4500 Mobi for device configuration” \(page 47\)](#) for more information.
2. Click the **-view mode settings** link under **MANAGEMENT SETTINGS** in the left-hand settings menu ([Figure 52 \(page 124\)](#)).

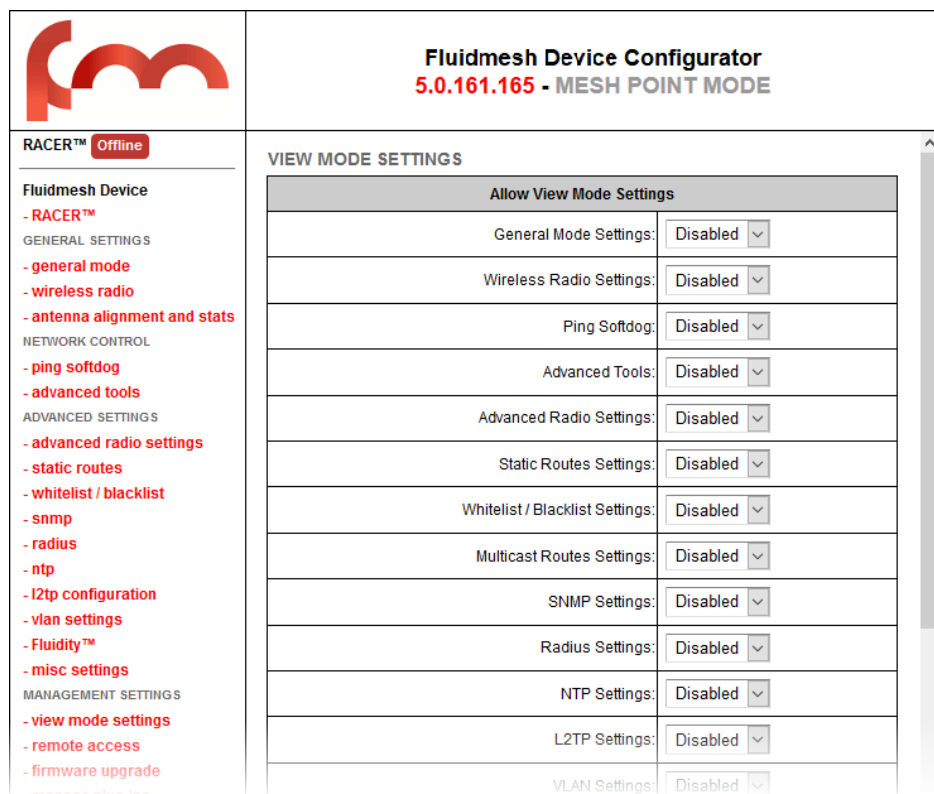

**Figure 52. Configurator GUI (VIEW MODE SETTINGS dialog)**

- The **VIEW MODE SETTINGS** dialog will be shown.
3. To allow or prohibit access to any device-configuration settings, click the relevant drop-down, and click the **Disabled** or **Enabled** setting:
    - If the **Disabled** option is selected for a device-configuration setting, the setting for that category will be visible but not accessible to ordinary users.
    - If the **Enabled** option is selected for a device-configuration setting, the setting can be modified by ordinary users.



**IMPORTANT**

If you are logged in to the Configurator interface with Administrator credentials, you can enable or disable any device-configuration setting.

If you are logged in to the Configurator interface as an ordinary user, you will be able to view the device-configuration settings, but cannot change the settings.

4. Save the view mode settings by clicking the **Save** button in the **Allow View Mode Settings** section. Alternatively, clear the settings by clicking the **Reset** button.

### 7.8.2. Changing the Administrator username and password

The **CHANGE USERNAME AND PASSWORD** section contains controls to change the Administrator's user name and password for the Fluidmesh unit.



**IMPORTANT**

Changing the default password to a strong password is an extremely important step in preventing security breaches.

If you have logged into the configurator interface using default administrator's credentials, you will see a notification banner at the bottom of the screen ([Figure 53 \(page 125\)](#)).

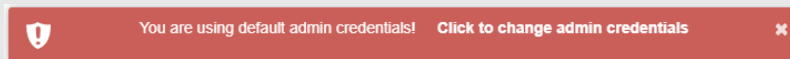

**Figure 53. Default admin credentials notification banner**

Click the banner to change the admin credentials. You will be taken to the **CHANGE USERNAME AND PASSWORD** section.

To change the Administrator's user name and password for the unit, do the following steps:

1. Click the **-remote access** link under **MANAGEMENT SETTINGS** in the left-hand settings menu.
  - The **CHANGE USERNAME AND PASSWORD** dialog will be shown ([Figure 54 \(page 126\)](#)).

CHANGE USERNAME AND PASSWORD

Change Username and Password

Username:	<input type="text" value="admin"/>
Old password:	<input type="password"/>
New password:	<input type="password"/>
Confirm new password:	<input type="password"/>
Show password:	<input type="checkbox"/>

TELNET ACCESS

Telnet Access

Enable telnet access:	<input type="checkbox"/>
-----------------------	--------------------------

**Figure 54. Management Settings dialog (Change Username and Password)**

2. Enter the new administrator user name in the **Username:** field.
3. Enter the current password in the **Old password:** field.
4. Enter the new password in the **New password:** field.
5. Confirm that the new password is correctly spelled by checking the **Show Password:** check-box to show the text of the password, then re-entering the password in the **Confirm New password:** field.
6. Save the changed password settings by clicking the **Change** button. Alternatively, revert to the old password settings by clicking the **Reset** button.



#### IMPORTANT

Keep the Administrator name and password in a safe place. If the Administrator name and password are lost, the only way to log in to the unit is to do a hard reset.

If you need to do a hard reset, refer to [“Resetting the unit to factory defaults” \(page 137\)](#) for more information.

### *Enabling remote access to the unit by Telnet*

The **TELNET ACCESS** section contains controls to enable remote access to the unit using Telnet.



### IMPORTANT

The Telnet protocol suffers from serious security weaknesses that limit its usefulness in environments where the network cannot be fully trusted.

Telnet is used at your own risk.

To enable Telnet access to the unit, do the following steps:

1. Click the **-remote access** link under **MANAGEMENT SETTINGS** in the left-hand settings menu.
  - The **TELNET ACCESS** dialog will be shown (see [Figure 54 \(page 126\)](#) in the previous section).
2. Enable Telnet access by checking the **Enable telnet access:** check-box.
3. Save the changed Telnet settings by clicking the **Change** button. Alternatively, revert to the old password settings by clicking the **Reset** button.

### 7.8.3. Overwriting and upgrading the unit firmware

The **FIRMWARE UPGRADE** window contains controls to overwrite the device firmware of the Cisco FM4500 Mobi, or upgrade the firmware to the latest available version.



### CAUTION

Overwriting the firmware of any electronic device must be done with great care, and always contains an element of risk.

It is not advisable to overwrite the firmware on a functioning Fluidmesh unit unless a specific firmware-related issue needs to be resolved.



### IMPORTANT

To access firmware image files, you need an approved Fluidmesh extranet account. To create an extranet account, register for free at the [Fluidmesh Partner Portal](#).

To download the needed firmware image file to your computer, do the following steps:

1. Navigate to [the Documentation section of the Fluidmesh Partner Portal](#).
2. Find and open the device sub-folder for your specific Fluidmesh device in the **FIRMWARE AND TOOLS** folder.
3. Download the firmware image (\*.BIN) file to your computer.

**CAUTION**

Make sure that you download the specific \*.BIN file for your device type. Uploading incorrect firmware for the device type will cause the firmware overwrite to fail, and may damage the unit.

The following procedure describes how to overwrite the existing firmware on a Fluidmesh device. This procedure assumes that the wireless network is currently active.

To overwrite the existing firmware on the Fluidmesh device, do the following steps:

1. Power OFF all Fluidmesh devices connected to the wireless network.
2. Disconnect all Ethernet cables from the Fluidmesh device.
3. With the Fluidmesh device disconnected from the wireless network, power ON the device.

**CAUTION**

Do not restart or power OFF the device while firmware overwriting is in progress.

Restarting or powering OFF the unit before overwriting is complete will permanently damage the unit.

4. Connect the computer containing the firmware image file directly to the Fluidmesh unit, using an Ethernet cable. For detailed information on direct connection, refer to [“Accessing the Cisco FM4500 Mobi for device configuration” \(page 47\)](#).
5. As a precaution, save the unit's existing device configuration file to the computer. For detailed information on how to save the existing configuration file, refer to [“Saving and restoring the unit settings” \(page 135\)](#).
6. Click the **-firmware upgrade** link under **MANAGEMENT SETTINGS** in the left-hand settings menu.
  - The **FIRMWARE UPGRADE** dialog will be shown ([Figure 55 \(page 129\)](#)).



**FIRMWARE UPGRADE**

Firmware upgrade	
Upload and upgrade the firmware using a firmware upgrade file. Firmware upgrades are available to registered users at <a href="http://www.fluidmesh.com">www.fluidmesh.com</a> .	
WARNING: POWERING OFF OR UNPLUGGING A FLUIDMESH UNIT DURING A FIRMWARE UPGRADE PROCEDURE WILL PERMANENTLY DAMAGE THE UNIT	
Current version:	9.0.1
Select the firmware file to upload and start the upgrade:	
<input type="button" value="Choose File"/> No file chosen	

**Figure 55. Configurator GUI (typical FIRMWARE UPGRADE dialog)**

7. Upload the firmware image file to the unit by clicking the **Choose File** button and following the software prompts.
  - The **Upgrade** button will become available.
8. Click the **Upgrade** button. Follow the software prompts until the firmware overwrite is complete.
  - When the overwrite is complete, the unit will automatically reboot.

If the previous firmware was overwritten with a newer version of firmware, check that the firmware upgraded correctly by doing the following steps:

- When the overwrite is complete, make sure that the upgraded firmware has a greater version number than the firmware that was previously installed.
  - If the firmware version has not changed, the firmware upgrade has failed. Repeat the overwrite from step [Step 1](#) above.

#### 7.8.4. Plug-In management



#### IMPORTANT

For a complete list of software plug-ins that are currently available for the Cisco FM4500 Mobi, refer to [“Available plug-ins” \(page 140\)](#).

The MANAGE PLUG-INS page shows which software plug-ins are currently active on the unit, and contains controls that allow you to do the following functions:

- Upload activation codes that allow the unit's accessory software plug-ins to function.
- Activate uploaded software plug-ins for use with the unit.
- Deactivate uploaded software plug-ins so they can be used on other Fluidmesh units.

- Activate a non-repeatable Demo mode that allows full 4.9 GHz, AES and unlimited plug-in functionality for an 8-hour trial period.

**IMPORTANT**

The 4.9 GHz band is not available in Brazil or Canada.

- Show and erase the log files for plug-in installation.

To open the **MANAGE PLUG-INS** dialog, do the following steps:

- Click the **-manage plug-ins** link under **MANAGEMENT SETTINGS** in the left-hand settings menu.
  - The **MANAGE PLUG-INS** dialog will be shown ([Figure 56 \(page 131\)](#)).

### MANAGE PLUG-INS

**Manage Plug-ins**

Use the window below to activate new plug-ins. Please contact your Fluidmesh Networks representative for more information on the Plug-Ins available.

**Plug-in List**

FM____-120: 120 Mb/s LICENSED	REMOVE
FM____-MOB-MOB-60: 60 Mb/s LICENSED	REMOVE
FM____-MOB-TRK-UN LICENSED	REMOVE
FM-AES LICENSED	REMOVE
FM-PROFINET LICENSED	REMOVE
FM-LF LICENSED	REMOVE
FM-VLAN LICENSED	REMOVE
FM-MOB LICENSED	REMOVE
FM-L2TP LICENSED	REMOVE
FM-FIPS LICENSED	REMOVE
FM-UNII2 LICENSED	
FM-QNET LICENSED	REMOVE
FM-WORLD LICENSED	

**Plug-in Activation Code**

Plug-in Activation Code:

**Upload Plug-ins CSV**

Select the CSV file to upload

No file selected.

**Plug-in Deactivation Codes**

List of de-activated plug-ins. If you have deactivated a plug-in, please use the deactivation code to get a new License Code.

Plug-in Type	Deactivation Code
FM-TITAN	66090979

Plugin Installation Logs:

**Figure 56. Configurator GUI (typical MANAGE PLUG-INS dialog)**

To activate Plug-in Demo mode, do the following steps:

1. Click the **Demo Mode** button at the bottom of the **MANAGE PLUG-INS** dialog.
  - The **Demo Mode** activation dialog will be shown ([Figure 57 \(page 132\)](#)). A countdown timer shows how much Demo time remains.

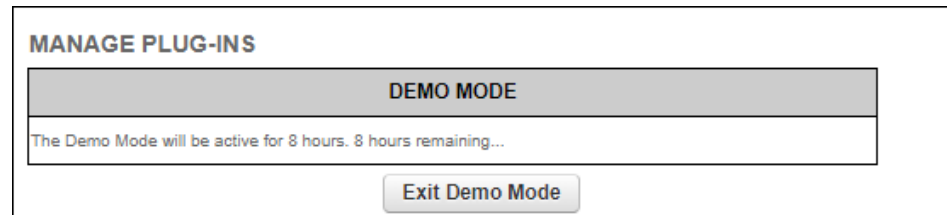

**Figure 57. MANAGE PLUG-INS dialog (Demo Mode activated)**

2. To leave Demo mode before expiry of the 8-hour trial period, click the **Exit Demo Mode** button.
  - Demo mode will be deactivated, and the unit will reboot.
3. If the 8-hour Demo mode limit is reached, the unit will reboot and Demo mode will not be accessible again.

To upload one or more plug-in activation codes, refer to [“Plug-in management procedures” \(page 144\)](#).

To assign a software plug-in on the Partner Portal to the unit, do the following steps:

1. Enter the activation code for the plug-in in the **Plug-in Activation Code:** field.
2. Click the **Add** button.
  - The plug-in will be activated, and the plug-in functionality can be used.
  - A **REMOVE** link will be shown in red to the right of the relevant plug-in description in the **Plug-in List**.

To deactivate an uploaded software plug-in for use with another Fluidmesh unit, refer to [“Plug-in management procedures” \(page 144\)](#).

To show and erase the plug-in installation log files, do the following steps:

1. Click the **Show Logs** button in the **Plug-in Installation Logs:** section.
  - The log files for plug-in installation will be shown in the **Plug-in Installation Logs:** section.
2. If needed, erase the log files for plug-in installation by clicking the **Clear Logs** button in the **Plug-in Installation Logs:** section.

### 7.8.5. The device status view

#### The device status window

The device status window contains information on basic Fluidmesh device settings (including the unit's MAC address), and controls that allow you to download diagnostic data files and view device-event logs.

To use the status window, do the following steps:

- Click the **-status** link under **MANAGEMENT SETTINGS** in the left-hand settings menu.
  - The status dialog will be shown (below).

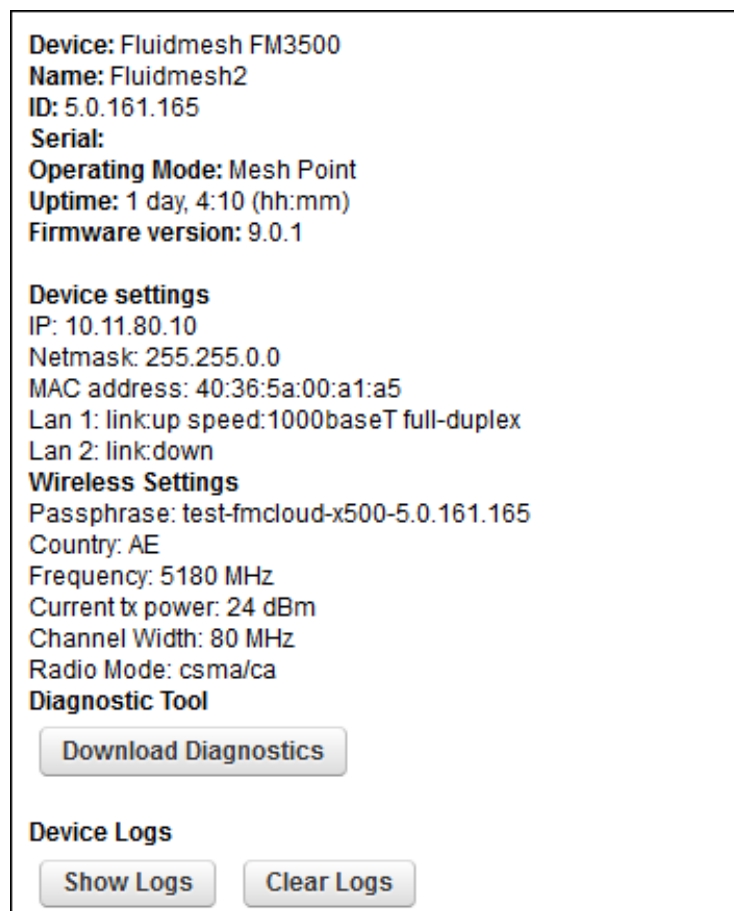

**Figure 58. Configurator GUI (typical Status dialog)**

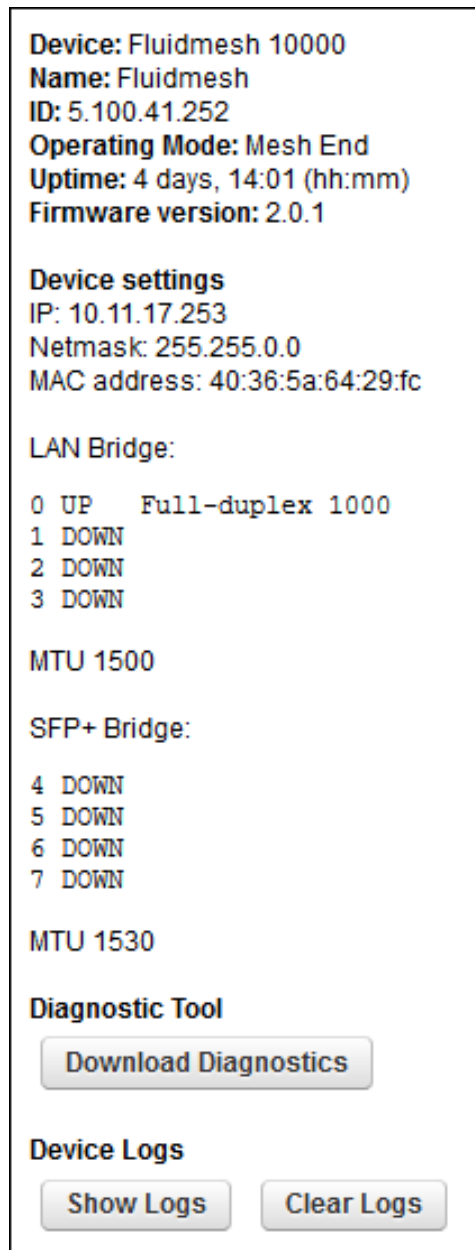

**Figure 59. Typical Status dialog (second-generation FM1000 gateway gateway)**

- Status information on the unit's basic characteristics, device settings and wireless settings is shown in the upper part of the window.

To download and forward the current diagnostic file for the unit, do the following steps:

1. Click the **Download Diagnostics** button.
2. Follow the software prompts to download the \*.FM diagnostic file to your computer.

3. Log a support call with the Fluidmesh Help desk. Ask for a reference number.
4. Attach the \*.FM diagnostic file to an E-mail, and enter the support call reference number in the subject line of the E-mail. Send the mail to [support@fluidmesh.com](mailto:support@fluidmesh.com).



#### IMPORTANT

Do not forward diagnostic files unless the Fluidmesh Help desk requests them. If diagnostic files arrive when they have not been requested, they cannot be traced to specific problems.

To show the current device log for the unit, click the **Show Logs** button.

- The current device log will be shown in the Device Logs window above the **Show Logs** button.
- The status messages shown in the log relate to possible Ethernet port flapping, and will also alert you if duplicate IP addresses are present in the LAN. Refer to the text below for a description of the log messages.



#### NOTE

Ethernet port flapping is an issue in which the Ethernet port goes offline and comes back online at an excessively high rate within a given time period.

Some possible causes of this problem may be auto-negotiation issues, chipset incompatibility, or faulty CAT5/6 cabling.

Some status messages that may be shown in the log have the following meanings:

- *ethX phy:X is up/down*: Ethernet port X is currently online/offline.
- *chatter: VBR: duplicate IP A? MACX --> MAXY at &lt;timestamp>*: Possible duplicate IP address 'A' has migrated from MAC address 'X' to MAC address 'Y', at the time shown.

### 7.8.6. Saving and restoring the unit settings



#### IMPORTANT

Device software configuration (\*.CONF) files are not interchangeable with FM Racer configuration setup (\*.FMCONF) files.

The **LOAD OR RESTORE SETTINGS** window contains controls that allow you to:

- Save the unit's existing software configuration as a configuration (\*.CONF) file.

- Upload and apply a saved configuration file to the current unit.



**TIP**

Saved configuration files can be copied and distributed for use on more than one Fluidmesh unit of the same type, simplifying the configuration of other deployed units.

Saved configuration files can also be used for configuration backup. This can greatly speed up re-deployment if a damaged unit must be replaced with a unit of the same type.

To download the unit's existing configuration settings to your computer, do the following steps:

1. Click the **-configuration settings** link under **MANAGEMENT SETTINGS** in the left-hand settings menu.
  - The **LOAD OR RESTORE SETTINGS** dialog will be shown (Figure 60 (page 136)).

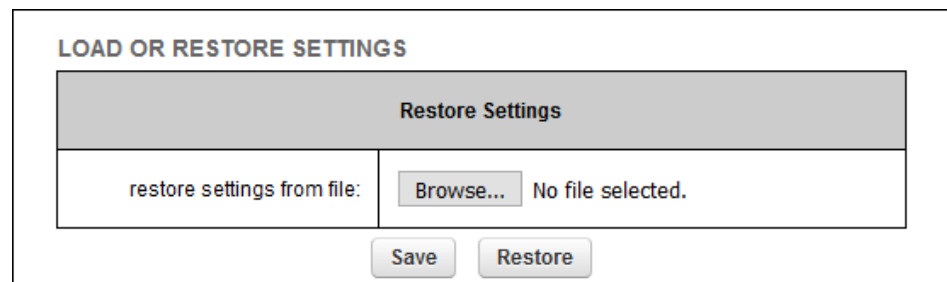

**Figure 60. Configurator GUI (LOAD OR RESTORE SETTINGS dialog)**

2. Download the unit's configuration (\*.CONF) file to your computer by clicking the **Save** button and following the software prompts.

To upload a saved configuration file to the Fluidmesh unit, do the following steps:

1. Find the configuration (\*.CONF) file that must be uploaded to the unit by clicking the **Browse...** button and following the software prompts.
  - The name of the configuration file to be uploaded will be shown to the right of the **Browse...** button.
2. Apply the configuration settings to the unit by clicking the **Restore** button.
  - The configuration will be applied, and the unit will reboot.



### 7.8.7. Resetting the unit to factory defaults

The **reset factory default** window contains controls that allow you to restore the Cisco FM4500 Mobi to its default factory settings (in other words, to do a 'hard reset').



**IMPORTANT**

Doing a hard reset will revert all unit configuration settings, including the unit's IP address and administrator password, to factory defaults.

If you want to reboot the unit instead, refer to [“Rebooting the unit” \(page 137\)](#) below.

To reset the unit to its factory defaults, do the following steps:

1. Click the **-reset factory defaults** link under **MANAGEMENT SETTINGS** in the left-hand settings menu.
  - The unit reset dialog will be shown ([Figure 61 \(page 137\)](#)).

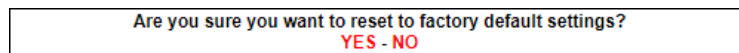



**CAUTION**

Do not do a hard reset unless the unit needs to be reconfigured using its factory configuration as a starting point.

A hard reset will reset the unit's IP address and administrator password, and will disconnect the unit from the network.

**Figure 61. Configurator GUI (unit reset dialog)**

2. Reset the unit to its factory defaults by clicking the **YES** link. Alternatively, abort the factory reset by clicking the **NO** link.
  - If the **YES** link was clicked, the unit will do a factory reset, and will reboot.
3. If you have previously saved a device configuration file for the unit, you can restore the saved configuration settings to the unit as shown in [“Saving and restoring the unit settings” \(page 135\)](#).

#### [Rebooting the unit](#)

The **reboot** window contains controls that allow you to reboot the Cisco FM4500 Mobi (in other words, to re-start the unit's operating system).

To reboot the unit, do the following steps:

1. Click the **-reboot** link under **MANAGEMENT SETTINGS** in the left-hand settings menu.
  - The unit reboot dialog will be shown (Figure 62 (page 138)).

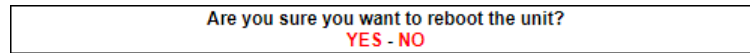

**Figure 62. Configurator GUI (unit reboot dialog)**

2. Reboot the unit by clicking the **YES** link. Alternatively, abort the reboot by clicking the **NO** link.
  - If the **YES** link was clicked, the unit will reboot.

### 7.8.8. Logging out

If clicked, the logout option logs the current user off the unit, and out of the Configurator interface.

- To log out, click the **-logout** link under **MANAGEMENTSETTINGS** in the left-hand settings menu.
  - You will be logged off the unit and out of the Configurator interface with no further prompting.
  - The web browser will show the **Authentication Required** dialog (Figure 63 (page 138)). If needed, use the dialog to log in again.

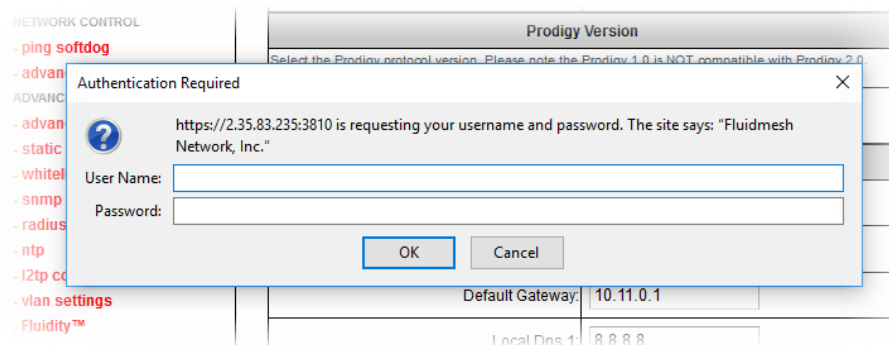

**Figure 63. Web browser (Authentication Required dialog)**

### 7.8.9. Viewing the end-user license agreement

The **License Agreement** window contains the Fluidmesh end-user license agreement for the Cisco FM4500 Mobi, its firmware and control software.

To view the terms and conditions of the license agreement, click the **License Agreement** link under **MANAGEMENT SETTINGS** in the left-hand settings menu.

- The license agreement dialog will be shown ([Figure 64 \(page 139\)](#)).

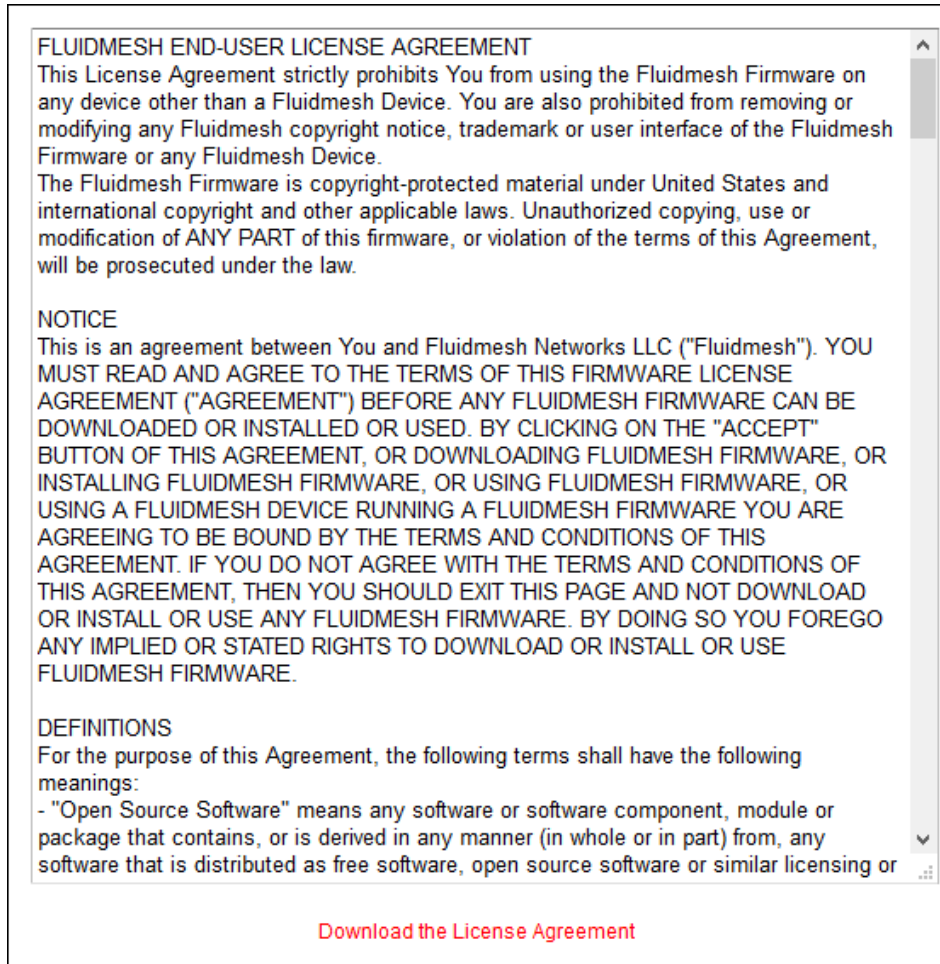

**Figure 64. Configurator GUI (End-user license agreement)**

To read the end-user license agreement as an \*.HTML web page in your browser, left-click the **Download the License Agreement** link.

- The end-user license agreement will be shown under a new tab in your web browser.

To download the end-user license agreement as a standard text (\*.TXT) file, do the following steps:

1. Right-click the **Download the License Agreement** link.
2. Click the **Save Link as...** option and follow the software prompts to download the agreement as a text file.

## 8. Software Plug-Ins

### 8.1. Available plug-ins

Like other Fluidmesh radio transceivers, the Cisco FM4500 Mobi is able to take advantage of plug-in software upgrades that add features and enhance the performance of the unit.

The following table lists all available software plug-ins for all Fluidmesh hardware devices, their specific functions, and their plug-in part numbers.

The tables that follow this table describe which plug-ins are compatible with specified Fluidmesh devices.

**Table 6. Available Fluidmesh software plug-ins**

Plug-in	Is the plug-in package removable and re-installable?	Function	Part number
Bandwidth	Yes	A range of plug-ins are available to enable increased traffic forwarding bandwidth, up to and including the amount of bandwidth specified in the part number (including unlimited bandwidth).	FM[model number]-[bandwidth limit]
Bandwidth upgrade	Yes	If an existing bandwidth plug-in is installed, this plug-in allows bandwidth to be upgraded to a higher, specified value.  Note that if a bandwidth upgrade plug-in is removed, the unit's bandwidth capability is not restored to the level of the previous upgrade (if any). Rather, the bandwidth capability is restored to the factory default level.	FM[model number]-UPG-[existing bandwidth limit/new bandwidth limit]

Plug-in	Is the plug-in package removable and re-installable?	Function	Part number
Fluidity-Bandwidth (Mobile)	<b>Yes</b>	Enables Fluidity capability for mobile Fluidmesh devices.  Allows traffic forwarding up to and including the amount of bandwidth specified in the part number.	FM[model number]-MOB-MOB-[bandwidth limit] (FMx200 models)  FM[model number]-FLU-MOB-[bandwidth limit] (FMx500 models)
Fluidity-Bandwidth (Trackside)	<b>Yes</b>	Enables Fluidity capability for static-mount Fluidmesh devices.  Allows traffic forwarding up to and including the amount of bandwidth specified in the part number.	FM[model number]-MOB-TRK-[bandwidth limit] (FMx200 models)  FM[model number]-FLU-TRK-[bandwidth limit] (FMx500 models)
4.9 GHz band	<b>Yes</b>	Enables operation in the 4.9 GHz emergency band.  Note that the 4.9 GHz band is not available in Brazil and Canada.	FM-49
Licensed Frequencies	<b>Yes</b>	Enables the use of any operating frequency, regardless of country selection.	FM-LF
World Frequencies	No	Unlocks the country drop-down selector on units sold in territories where the selector is locked.	FM-WORLD
AES	<b>Yes</b>	Enables data exchange according to the regular Advanced Encryption Standard.	FM-AES
Fluidmesh Access Points	<b>Yes</b>	Enables WiFi access-point capability.	FM-AP
VLAN	<b>Yes</b>	Enables virtual LAN capability.	FM-VLAN
Virtual Gigabit	<b>Yes</b>	Enables Fluidmesh Virtual Gigabit capability.	FM-VGBE
L2TP	<b>Yes</b>	Enables layer 2 transfer protocol capability.	FM-L2TP

Plug-in	Is the plug-in package removable and re-installable?	Function	Part number
PROFINET	Yes	Enables process field net capability.	FM-PROFINET
QNET	Yes	Enables Neutrino Qnet capability.	FM-QNET
FIPS	Yes	Enables Federal Information Processing Standards capability.	FM-FIPS
TITAN	Yes	Enables fast fail-over capability on networks where redundant (backup) units are installed.	FM-TITAN
UNII2	No	Enables use of frequencies in the Unlicensed National Information Infrastructure (U-NII) bands.  Supported bands are U-NII-2A (5.250 to 5.350 GHz) and U-NII-2C / U-NII-2E (5.470 to 5.725 GHz).	FM-UNII2

The following tables describe which plug-ins are compatible with specified Fluidmesh devices.

**Table 7. Device plug-in compatibility (FM1000 Gateway to FM FM1300 Otto)**

Plugin	FM1000 Gateway Gateway  FM10000 Gateway Gateway	FM Ponte kit	FM FM1200 Volo	FM FM1300 Otto
Bandwidth	Available	Not available	Available	Available
Bandwidth upgrade	Available	Not available	Available	Available
Fluidity-Bandwidth (Mobile)	Not available	Not available	Not available	Not available
Fluidity-Bandwidth (Trackside)	Not available	Not available	Not available	Not available
Fluidity	<i>Firmware embedded</i>	Not available	Not available	Not available
4.9 GHz band	Not available	Not available	Available	Not available

Plugin	FM1000 Gateway Gateway  FM10000 Gateway Gateway	FM Ponte kit	FM FM1200 Volo	FM FM1300 Otto
Licensed frequencies	Not available	Not available	Available	Not available
World frequencies	Not available	Not available	Available	Not available
AES	Not available	Not available	Available	Available
Fluidmesh Access Points	Not available	Not available	Available	Not available
VLAN	<i>Firmware embedded</i>	Available	Available	Not available
Virtual Gigabit	Not available	Not available	Available	Not available
L2TP	<i>Firmware embedded</i>	Not available	Available	Not available
PROFINET	<i>Firmware embedded</i>	Not available	Available	Not available
QNET	<i>Firmware embedded</i>	Not available	Available	Not available
FIPS	Not available	Not available	Available	Not available
TITAN	Available	Not available	Available	Not available
UNII2	Not available	Not available	Available	Not available

**Table 8. Device plug-in compatibility (FM Cisco 3200-series to FM 4800)**

Plugin	FM FM3200 Base  FM FM3200 Endo	FM Cisco FM3500 Endo	FM FM4200 Fiber  FM FM4200 Mobi	FM FM4500 Fiber  FM FM4500 Mobi	FM 4800
Bandwidth	Available	Available	Available	Available	Available
Bandwidth upgrade	Available	Available	Available	Available	Available
Fluidity-Bandwidth (Mobile)	Available	Available	Available	Available	Available
Fluidity-Bandwidth (Trackside)	Available	Available	Available	Available	Available
Fluidity	Available	Available	Available	Available	Available
4.9 GHz band	Available	Available	Available	Available	Not available

Plugin	FM FM3200 Base	FM Cisco FM3500 Endo	FM FM4200 Fiber	FM FM4500 Fiber	FM 4800
	FM FM3200 Endo		FM FM4200 Mobi	FM FM4500 Mobi	
Licensed frequencies	Available	Available	Available	Available	Available
World frequencies	Available	Available	Available	Available	Available
AES	Available	Available	Available	Available	Available
Fluidmesh Access Points	Available	Not available	Available	Not available	Not available
VLAN	Available	Available	Available	Available	Available
Virtual Gigabit	Not available	Not available	Not available	Not available	Not available
L2TP	Available	Available	Available	Available	Available
PROFINET	Available	Available	Available	Available	Available
QNET	Available	Available	Available	Available	Available
FIPS	Available	Available	Available	Available	Available
TITAN	Available	Available	Available	Available	Available
UNII2	Available	Available	Available	Available	Available

To purchase any of the software plug-ins, please contact your Fluidmesh Networks representative.

## 8.2. Plug-in management procedures

### 8.2.1. Plug-in activation

The Plug-in management procedure has been standardized, and is the same for all Fluidmesh hardware devices.

To obtain a plug-in activation code for a Fluidmesh device, do the following steps:

1. Contact your Fluidmesh Networks representative to purchase a generic 16-digit *License code* for plug-in activation.
2. Quote the unique mesh unit identification number (**5.a.b.c**) of the Fluidmesh hardware device.
3. Using the Fluidmesh Partner Portal, associate the *License code* with the quoted Fluidmesh device to get an *Activation code*.
4. Enter the Activation code on the **MANAGE PLUG-INS** window for the unit.

You can also deactivate a plug-in Activation code that is currently in use so it can be used with a different Fluidmesh unit. To deactivate an active plug-in, refer to [The PLUGINS sub-tab](#).



To convert a License code into an Activation code for a Fluidmesh device, do the following steps:

1. Log on to the [Fluidmesh Partner Portal](#).
2. Click the **Plug-ins** link.
  - When you purchase a generic 16-digit *License code*, the License code and corresponding plug-in will be listed on the Plug-ins page ([Figure 65 \(page 145\)](#)).

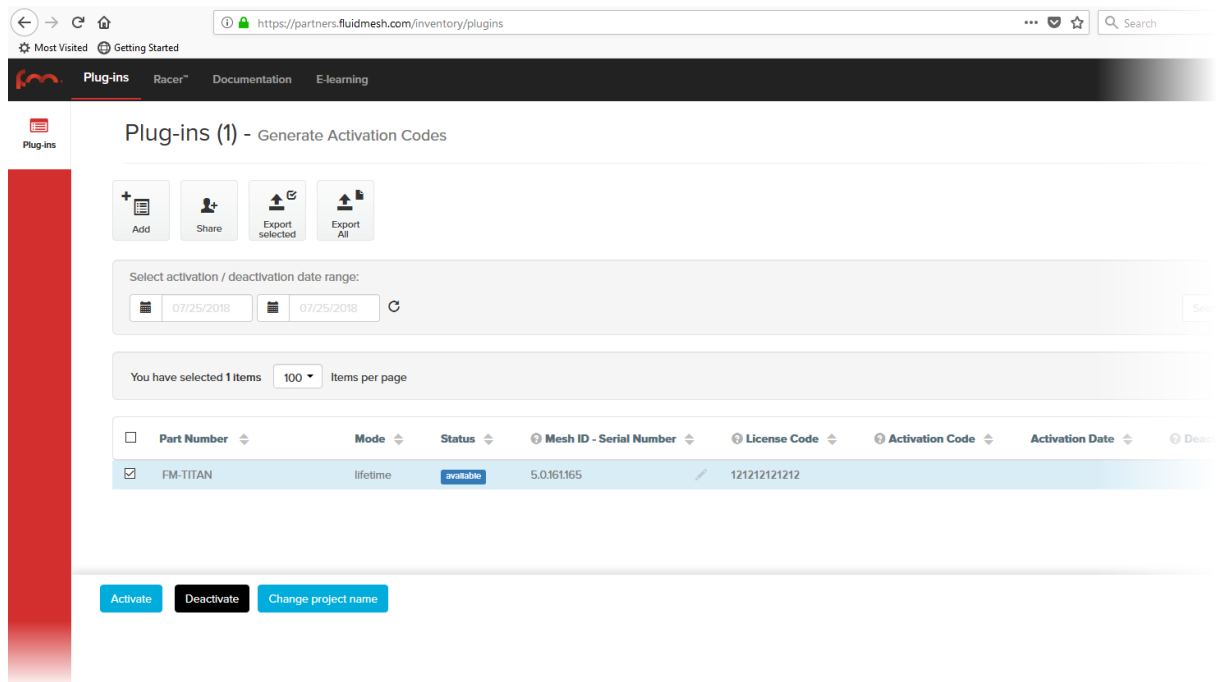

**Figure 65. Partner Portal Plug-ins page (License code plug-in)**

- When the generic License code was purchased, you will have received an E-mail from *plugins@fluidmesh.com* containing the License code. If the License code and corresponding plug-in are *not* listed on the Plug-ins page, click the **Add** button in the upper left-hand corner of the Plug-ins web page, and enter the License code using the dialog.
3. Enter the unit identification number (**5.a.b.c**) or the unit serial number of the Fluidmesh unit in the **Mesh ID - Serial Number** field.
  4. If needed, enter the name of the relevant technical project in the **Project Name** field.

**TIP**

If you cannot see the **Project Name** field, reduce the magnification on the Plug-ins web page until all the headings are visible.

5. Click the **Activate** button on the Plug-ins web page.
  - The **Plug-in Activation** dialog will be shown. Check that the given E-mail address is correct, and click the **Activate** button.
  - You will receive an E-mail from *plugins@fluidmesh.com* containing the Activation code.
  - The **Activation Code** and **Activation Date** will be shown in the relevant fields on the Plug-ins web page.
  - The plug-in Status will change from **available** to **active**.
6. Use the Activation code to activate the plug-in. Refer to [“Plug-In management” \(page 129\)](#) for details.
  - The plug-in will be activated, and the relevant functionality can be used.

### 8.2.2. Deactivating an active plug-in

A plug-in *Activation code* that is currently in use can be *deactivated*. This allows the corresponding *License code* to be used in a different Fluidmesh unit, or transferred to another Fluidmesh user.

To deactivate an activated License code for use with another Fluidmesh unit, do the following steps:

1. On the Configurator interface, click the **PLUGINS** sub-tab under the **SERVICES** tab (FM FM1300 Otto only) or click the **-manage plug-ins** link under **MANAGEMENT SETTINGS** in the left-hand settings menu (all other devices).
  - The **Manage Plugins** dialog will be shown (see below).

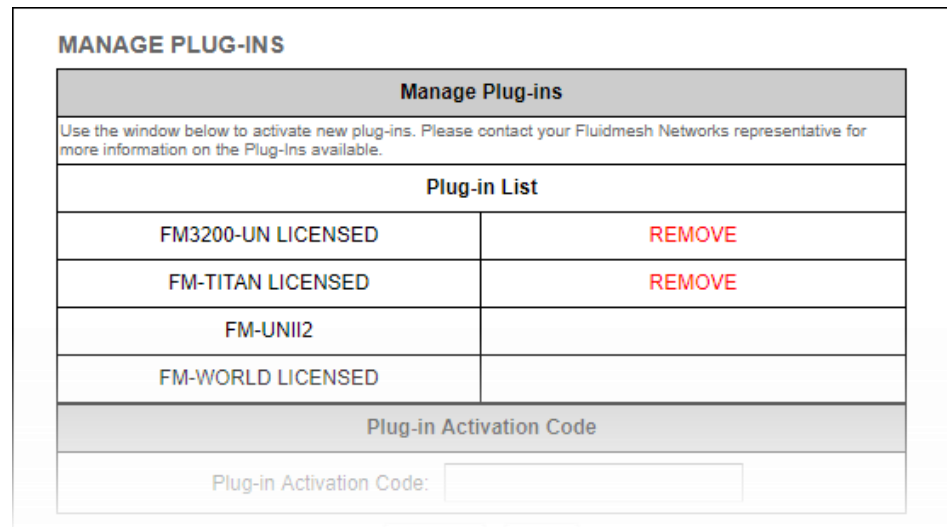

**Figure 66. Configurator interface (MANAGE PLUG-INS dialog)**

2. Click the red **REMOVE** link to the right of the correct plug-in listing.
  - The web browser will inform you that deactivating the plug-in will reboot the unit, and ask for confirmation that you want to deactivate.
3. Confirm the deactivation.
  - The unit will reboot.
  - The Deactivation code for the plug-in will be shown to the right of the plug-in listing, in the **Plug-in Deactivation Codes** section (see below).

Plug-in Deactivation Codes	
List of de-activated plug-ins. If you have deactivated a plug-in, please use the deactivation code to get a new License Code.	
Plug-in Type	Deactivation Code
FM-TITAN	66037e03

**Figure 67. MANAGE PLUG-INS DIALOG (Plug-in Deactivation Codes section)**

4. Make a note of the Deactivation code.
5. Log on to the Fluidmesh Partner Portal.
6. Click the **Plug-ins** link.
  - The Plug-ins web page will be shown ([Figure 68 \(page 148\)](#)).

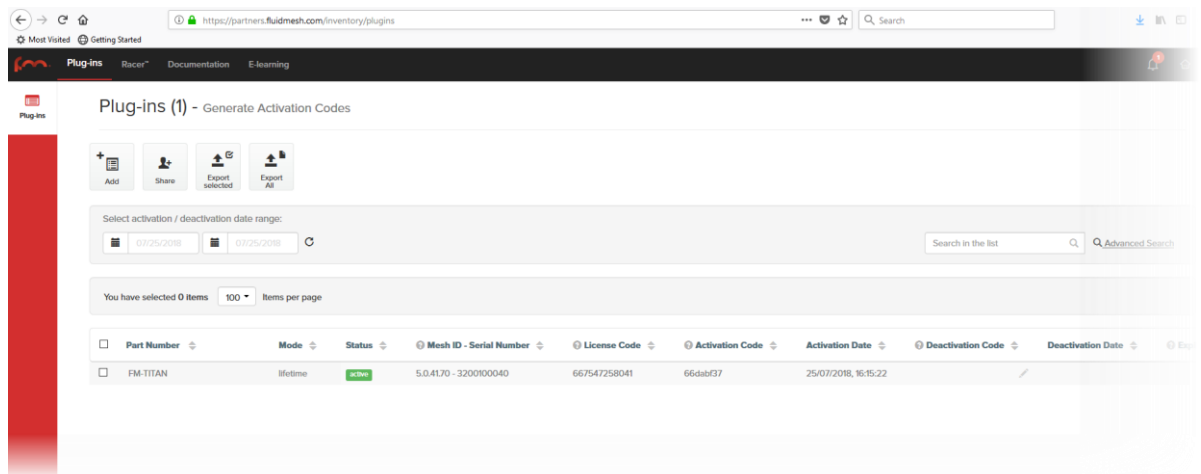

**Figure 68. Partner Portal Plug-ins page (License code deactivation)**

7. Check the selection check-box to the left of the relevant plug-in listing.
  - The plug-in control buttons will be shown at the bottom of the web page.
8. Enter the Deactivation code for the plug-in in the Deactivation Code field ([Figure 69 \(page 148\)](#)).

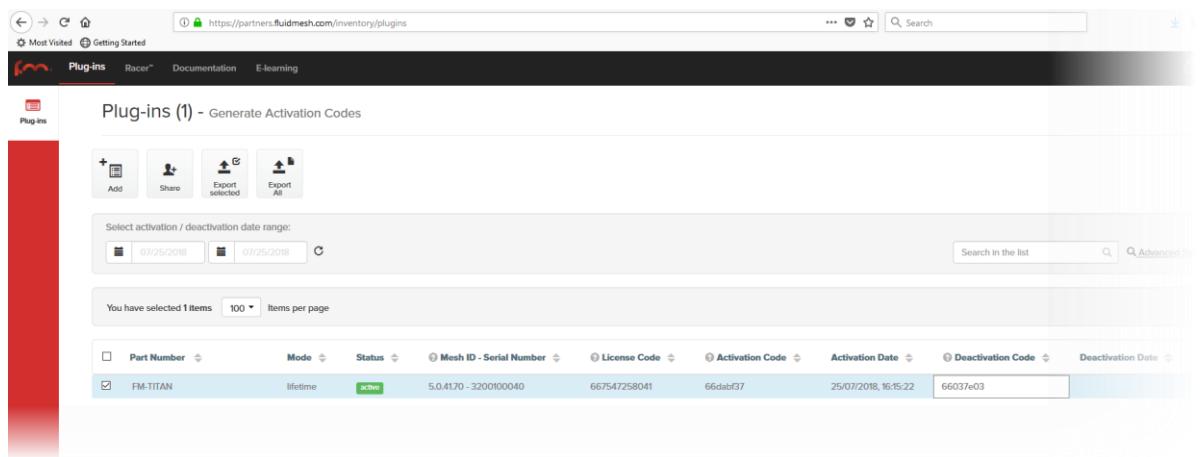

**Figure 69. Partner Portal Plug-ins page (deactivation code entry)**

9. Click the **Deactivate** button at the bottom of the web page.
  - The **PLUG-IN DEACTIVATION** dialog will be shown.
10. To do a normal deactivation, click the **Deactivate** button. If for any reason it is not possible to retrieve the deactivation code, click the **Force Deactivation** button.



**IMPORTANT**

Only click the **Force Deactivation** button if you have no way to retrieve the deactivation code (for example, if the unit's boot sequence cannot be completed, or if the unit is damaged and cannot be powered ON).

- The plug-in will be deactivated.
- The Deactivation code will be shown in the **Deactivation Code** column of the plug-in listing.
- The Deactivation code will remain on the Partner Portal, and can be used to generate a new Activation code if needed.

8.2.3. Reactivating a deactivated plug-in

To use a Deactivation code to generate an new Activation code, do the following steps:

1. Log on to the [Fluidmesh Partner Portal](#).
2. Click the **Plug-ins** link.
  - The Plug-ins web page will be shown ([Figure 70 \(page 149\)](#)).

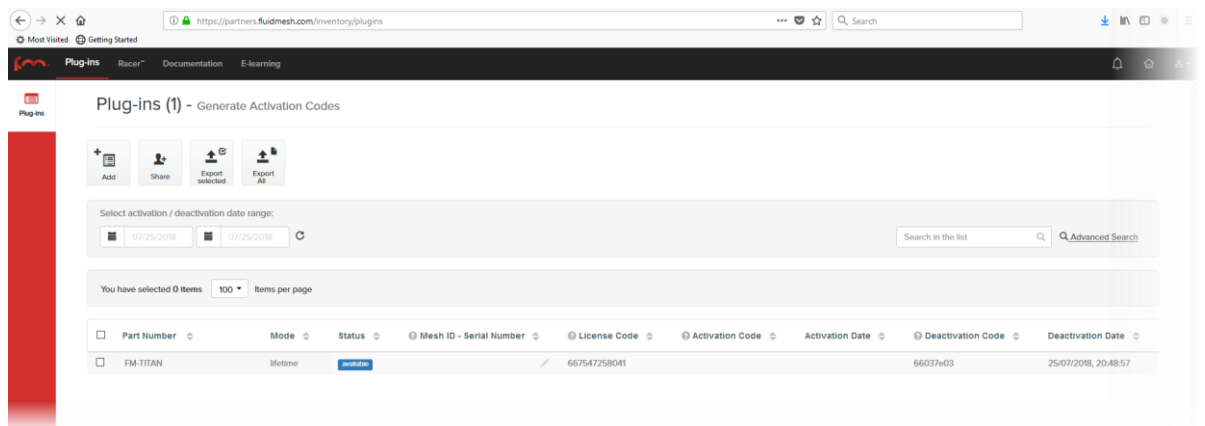

**Figure 70. Partner Portal (Plug-ins web page)**

3. Check the selection check-box to the left of the relevant plug-in listing.
  - The plug-in control buttons will be shown at the bottom of the web page.
4. Enter the unit identification number (**5.a.b.c**) or the unit serial number of the Fluidmesh unit in the **Mesh ID - Serial Number** field.

5. Complete the plug-in activation process as shown in “Plug-in activation” (page 144).

#### 8.2.4. Exporting and uploading multiple Activation codes

If more than one plug-in Activation code must be uploaded to a Fluidmesh radio transceiver unit at the same time, the need to upload codes one by one can be avoided by exporting multiple codes, or all codes, from the Partner Portal as a \*.CSV file.

To export a collection of Activation codes from the Partner Portal as a \*.CSV file, do the following steps:

1. Log on to the [Fluidmesh Partner Portal](#).
2. Click the **Plug-ins** link.
  - The Plug-ins web page will be shown.
3. Convert all needed License codes and/or Deactivation codes to Activation codes as shown in “Plug-in activation” (page 144)
4. To export only selected Activation codes, check the selection check-boxes to the left of each plug-in that must be included in the \*.CSV file, then click the **Export selected** button. Alternatively, export all Activation codes by clicking the **ExportAll** button (Figure 71 (page 150)).



#### IMPORTANT

If all Activation codes are exported, only the Activation codes that are linked to the unit identification number (5.a.b.c), or the unit serial number of the target unit, will be assigned to the unit.

All codes that are not relevant to the unit will remain unused.

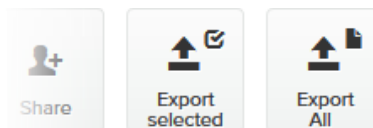

**Figure 71. Plug-ins web page (code export controls)**

5. Follow the software prompts to download the exported \*.CSV file to your computer. Save the file in a safe place.
6. On the configurator interface, click the **-manage plug-ins** link under **MANAGEMENT SETTINGS** in the left-hand settings menu.
  - The **MANAGE PLUG-INS** dialog will be shown.
7. Upload the \*.CSV file to the unit by clicking the **Choose File** button in the **Upload Plug-ins CSV** section (Figure 72 (page 151)) and following the software prompts.

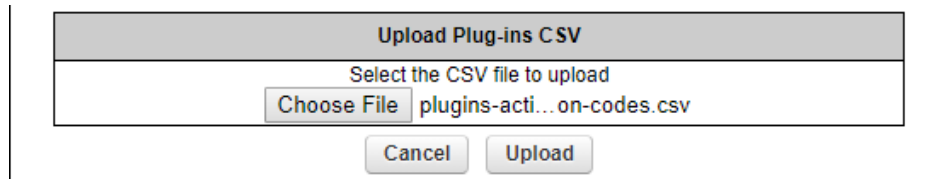

**Figure 72. MANAGE PLUG-INS DIALOG (Upload Plug-ins CSV section)**

- The chosen \*.CSV file will be listed to the right of the **Choose File** button.
8. Click the **Upload** button.
    - The plug-ins will be uploaded to the unit and activated, and the relevant functionality can be used.

### 8.2.5. Sharing License codes and accepting shared License codes

If needed, you can share license codes with other Fluidmesh device users, and also have other Fluidmesh device users share their license codes with you.

To share one or more license codes with another Fluidmesh device user, do the steps that follow:

1. Log on to the [Fluidmesh Partner Portal](#).
2. Click the **Plug-ins** link.
  - The Plug-ins web page will be shown.
3. Check the selection check-boxes to the left of the plug-ins that must be shared.
4. Click the **Share** button in the upper left-hand corner of the **Plug-ins** web page ([Figure 73 \(page 151\)](#)).

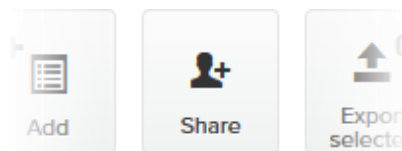

**Figure 73. Plug-ins web page (Share button)**

- The **Share License Codes** dialog will be shown.
5. Enter one or more E-mail addresses to which the License codes must be sent. Click the **Share** button.
    - An E-mail containing the selected License codes will be sent to the specified E-mail addresses.

- The License codes contained in the E-mail can be converted to plug-in Activation codes in the normal way.

If needed, you can also ask another device user to share one or more license codes with you. If a License code is shared with you, it will be listed on your Partner Portal Plug-ins web page.



## 9. Troubleshooting

The troubleshooting section will allow you to solve the most common problems encountered when configuring and installing Fluidmesh products.

### 9.1. I cannot get the Log-in screen

If you have directly connected a Windows computer to your Fluidmesh device for device configuration, but you cannot access the log-in form on your web browser, check the following points:

*Are you trying to access the unit using a valid IP address?*

You must manually set the computer's IP address and Netmask to be recognizable by the Fluidmesh device. The correct settings are as follows:

- **IP address:** 192.168.0.10 (or any other IP address belonging to subnet 192.168.0.0/255.255.255.0)
- **Netmask:** 255.255.255.0

*Have you disabled the 'Access the Internet using a proxy server' function?*

If your browser shows a time-out or similar message, the computer may be trying to access the Fluidmesh device through a proxy server. To stop the computer from trying to access the unit through a proxy connection, refer to [“Accessing the Cisco FM4500 Mobi for device configuration”](#) (page 47).

### 9.2. I cannot log in to the FM Racer interface



#### IMPORTANT

For a detailed description of the differences between the FM Racer configuration interface and the local Configurator interface, refer to [“Device configuration using the configurator interface”](#) (page 45).

If you are not able to log in to the FM Racer web-based configuration interface, check that you have entered the correct user name and password.

The factory-set user name for the FM Racer configuration interface is **admin**. The factory-set password is **admin**

To change the factory-set user name and password, refer to the *Fluidmesh Networks FM Racer User Manual*.

### 9.3. I forgot the Administrator password

If you have forgotten the Administrator user name and/or password for the Configurator interface, and you must access the unit to configure it using the Configurator interface, do the following steps:

1. Physically access the unit.
2. Use the hardware **Reset** button to reset the unit to its factory default settings. Refer to [“Resetting the unit to factory defaults” \(page 137\)](#) for more information.

## 9.4. The wireless link is poor or non-existent in Bridge mode

If the unit is set to **Bridge** mode, and is showing any or all of the following symptoms:

- There is no wireless link
- The link LED on the device enclosure shows constant red
- The wireless link is constantly below 60% signal strength

Check the following points to improve the wireless link strength:

1. **Antenna alignment:** The antennas belonging to both units forming part of the affected link must face each other as directly as possible.
2. **Line-of-sight:** The antennas belonging to both units forming part of the affected link must have clear line-of-sight (in other words, there must be no physical obstructions between the two antennas).
3. **Power:** Verify that both units forming part of the affected link are receiving enough power from their Ethernet connections or PoE injectors.
4. **Frequency value and channel width:** Both units forming part of the affected link must be set to the same frequency value, and to the same channel width.

## 10. Electrical power requirements

The following table describes:

- The electrical power requirements for each Fluidmesh hardware device type.
- Which Fluidmesh hardware devices are capable of receiving power through an IEEE 802.3 Ethernet port (whether from a power-supplying device like a compatible network switch, or from a power-over-Ethernet (PoE) injector), or through a DC IN power supply port, or both.
- The specific voltage-variation tolerances of each Fluidmesh radio transceiver unit type.

**Table 9. Individual power requirements (FM1000 Gateway and FM10000 Gateway)**

	Required input power	FM1000 Gateway	FM10000 Gateway
DC IN	12 Vdc (from mains AC power adapter producing a minimum of 60W (12V/5A)).	X	
First-generation FM10000 Gateway: unit may be equipped with single 250W non-redundant AC power supply unit (input power: 100 Vac to 240 Vac at 50 Hz to 60 Hz).		X	

**Table 10. Individual power requirements (FM Ponte kit to FM4200 Mobi)**

		FM Ponte kit (model FM1200V-HW)	FM1200 Volo (model FM1200V-HW)	FM1300 Otto	FM3200 Base (model FM3200)	FM3200 Endo (model FM3200)	FM4200 Mobi (model FM4200)
PoE	24V passive PoE	X	X				
	48V passive PoE				X	X	X

	IEEE 802.3af PoE  (voltage range at PD: 37V to 57V)			X	X	X	X
	IEEE 802.3at PoE  (voltage range at PD: 42.5V to 57V)			X	X	X	X
DC IN	Permanent DC power, min. 24V max. 60V						X
	EN 50155 compliance at 48V						X

**Table 11. Individual power requirements (FM4200 Fiber to FM4800 Fiber)**

		FM4200 Fiber (model FM4200F)	FM3500 Endo (model FM3500)	FM4500 Mobi (model FM4500)	FM4500 Fiber (model FM4500F)	FM4800 Fiber
PoE	24V passive PoE					
	48V passive PoE	X	X	X	X	X
	IEEE 802.3af PoE  (voltage range at PD: 37V to 57V)	X				
	IEEE 802.3at PoE  (voltage range at PD: 42.5V to 57V)	X	X	X	X	X

		<b>FM4200 Fiber (model FM4200F)</b>	<b>FM3500 Endo (model FM3500)</b>	<b>FM4500 Mobi (model FM4500)</b>	<b>FM4500 Fiber (model FM4500F)</b>	<b>FM4800 Fiber</b>
DC IN	Permanent DC  power, min. 24V  max. 60V	X		X	X	X
	EN 50155 compliance at 48V	X		X	X	X

## 11. Heat radiation data

When in use, all Fluidmesh gateway units and radio transceivers generate heat as a by-product of electrical activity.

Heat radiated by a Fluidmesh device may be of concern in confined locations such as server rooms (where the cumulative heat generated by a collection of electrical and electronic devices may cause damage to sensitive electronic components) and outdoor equipment enclosures (in which electronic components may overheat if the enclosure is not properly ventilated).



**WARNING**

The outer surfaces of some Fluidmesh units may become hot during normal operation. Such units have a 'Hot Surfaces' warning triangle on their outer enclosures.

During normal operation, do not touch or handle such unit enclosures without personal protective equipment.

The following table shows nominal heat-radiation figures for all Fluidmesh devices under idle conditions, and under full-load conditions.

All heat-radiation figures are given in British Thermal Units (BTU) per hour.

Device	Fiber-optic module installed	Idle @ 115 Vac / 60 Hz	Idle @ 230 Vac / 60 Hz	Full load @ 115 Vac / 60 Hz	Full load @ 230 Vac / 60 Hz
FM1000 Gateway		25.590	33.780	25.250	33.100
FM10000 Gateway (first and second generations)		271.595	267.159	436.395	437.078
FM Ponte kit (model FM1200V-HW)		6.479	6.138	19.778	19.437
FM1200 Volo (model FM1200V-HW)		6.479	6.138	19.778	19.437
All 3200-series transceivers (model FM3200)		10.230	10.230	24.552	24.552
FM3500 Endo (model FM3500)		9.889	9.889	26.939	26.939
FM4200 Mobi (model FM4200)		10.230	10.230	24.552	24.552
FM4200 Fiber (model FM4200F)	No	12.617	12.617	26.939	26.939

Device	Fiber-optic module installed	Idle @ 115 Vac / 60 Hz	Idle @ 230 Vac / 60 Hz	Full load @ 115 Vac / 60 Hz	Full load @ 230 Vac / 60 Hz
	Yes	15.004	15.004	29.326	28.985
FM4500 Mobi (model FM4500)		9.889	9.889	26.939	26.939
FM4500 Fiber (model FM4500F)	No	9.889	9.889	26.598	26.257
	Yes	12.958	12.958	29.326	29.326
FM4800 Fiber	No	23.529	23.529	47.399	47.058
	Yes	27.280	26.939	51.832	50.468

## 12. Federal Communications Commission (FCC) radio interference statement

This equipment has been tested and found to comply with the limits for a Class A digital device, pursuant to part 15 of the FCC Rules. These limits are designed to provide reasonable protection against harmful interference when the equipment is operated in a commercial environment. This equipment generates, uses, and can radiate radio frequency energy and, if not installed and used in accordance with the instruction manual, may cause harmful interference to radio communications. Operation of this equipment in a residential area is likely to cause harmful interference, in which case the user will be required to correct the interference at his own expense.

**FCC Caution:** to assure continued compliance, use only shielded interface cables when connecting to computer or peripheral devices. You are cautioned that changes or modifications not expressly approved by the party responsible for compliance could void the user's authority to operate the equipment. This transmitter must not be co-located or operating in conjunction with any other antenna or transmitter.

### **FCC Radiation Exposure Statement**

This equipment complies with FCC RF radiation exposure limits set forth for an uncontrolled environment. This equipment should be installed and operated with a minimum distance of 20 centimeters between the radiator and your body.

This device has been assembled using components that comply with Part 15 of the FCC Rules. Operation is subject to the following two conditions:

1. This device may not cause harmful interference.
2. This device must accept any interference received, including interference that may cause undesired operation.

### **Industry Canada**

The use of this device in a system operating either partially or completely outdoors may require the user to obtain a license for the system according to the Canadian regulations.

### **Industry Canada Statement**

This device complies with RSS-247 of Industry Canada.

Operation is subject to the following two conditions: (1) this device may not cause interference, and (2) this device must accept any interference, including interference that may cause undesired operation of the device.

### **Avis d'industrie Canada**

Le présent appareil est conforme aux CNR d'Industrie Canada applicables aux appareils radio exempts de licence.

L'exploitation est autorisée aux deux conditions suivantes:



(1) l'appareil ne doit pas produire de brouillage, et, and (2) l'utilisateur de l'appareil doit accepter tout brouillage radioelectrique subi, meme si le brouillage est susceptible d'en compromettre le fonctionnement.

**IC RF Radiation Exposure Statement:**

This equipment complies with IC radiation exposure limits set forth for an uncontrolled environment. This equipment should be installed and operated with minimum distance 20cm between the radiator & your body. This transmitter must not be co-located or operating in conjunction with any other antenna or transmitter.

**Déclaration d'exposition aux radiations:**

Cet équipement est conforme aux limites d'exposition aux rayonnements IC établies pour un environnement non contrôlé. Cet équipement doit être installé et utilisé avec un minimum de 20 cm de distance entre la source de rayonnement et votre corps.

This device has been approved by Industry Canada to operate with the antenna types listed below with the maximum permissible gain indicated. Antenna types not included in this list, having a gain greater than the maximum gain indicated for that type, are strictly prohibited for use with this device.

Cet appareil a été approuvé par Industrie Canada pour fonctionner avec les types d'antenne répertoriés ci-dessous avec le gain maximal admissible indiqué. Les types d'antennes non inclus dans cette liste, ayant un gain supérieur au gain maximum indiqué pour ce type, sont strictement interdits pour une utilisation avec cet appareil.

Antenna Type/ Types d'Antennes	Freq. (MHz)	Peak Antenna Gain (dBi) / Gain Maximal d'Antenne
SHARK DUAL	5250~5350	13
	5470~5725	13
	5725~5850	13
TUBE	5250~5350	14.6
	5470~5725	14.6
	5725~5850	14.6

**EC Declaration of Conformity**

Fluidmesh Networks, Inc. declares under its sole responsibility that the Cisco FM4500 Mobi is compliant with the following directives, and has been designed and manufactured to the following specifications:

<b>EMC</b>	<b>EN 61000-6-1; EN 61000-6-2; EN 61000-6-3; EN 61000-6-4; EN 489-17</b>
R&TTE	EN 300 328-1 V. 1.3.1; EN 300 328-2 V. 1.2.1; EN 301 893-1 V. 1.2.1; EN 300 440-2 V. 1.3.1
Safety	EN 60950-1:2001

**Caution:** This equipment is intended to be used in all EU and EFTA countries. Contact local Authority for procedure to follow.

**Note:**

Class A ITE is a category of all other ITE which satisfies the class A ITE but not the class B ITE limits.

Such equipment should not be restricted in its sale but the following warning shall be included in the instruction for use:

**WARNING:** this is a class A product. In a domestic environment, this product may cause radio interference in which case the user may be required to take adequate measures.

For more details on legal combinations of power levels and antennas, contact Fluidmesh Networks, Inc.

**Belgique**

Dans le cas d'une utilisation privée, à l'extérieur d'un bâtiment, au-dessus d'un espace public, aucun enregistrement n'est nécessaire pour une distance de moins de 300m. Pour une distance supérieure à 300m un enregistrement auprès de l'IBPT est requise. Pour une utilisation

publique a l'exterieur de batiments, une licence de l'IBPT est requise. Pour les enregistrements et licences, veuillez contacter l'IBPT.

**France**

Vous pouvez contacter l'Autorite de Regulation des Telecommunications (<http://www.art-telecom.fr>) pour de plus amples renseignements.

## 13. Agência Nacional de Telecomunicações (Anatel) radio interference statement

### **Portugues do Brasil:**

Este produto não é apropriado para uso em ambientes domésticos, pois poderá causar interferências eletromagnéticas que obrigam o usuário a tomar medidas necessárias para minimizar estas interferências

*Anatel Resolução 680* - Este equipamento não tem direito à proteção contra interferência prejudicial e não pode causar interferência em sistemas devidamente autorizados.

### **English:**

This product is not suitable for use in a domestic environment, as it may cause electromagnetic interference, which may require the user to take necessary measures to minimize such interference.

*Anatel Resolution 680* - This equipment is not entitled to protection against harmful interference, and is prohibited from causing interference in duly authorized systems.

## 14. Device certification for Taiwan (RoC)

EMC 電磁兼容:

- EN 55032:2015/A1:2016 Class A
- EN 61000-3-2:2014
- EN61000-3-3:2013
- EN 55024:2010 BSMI

BSMI 經濟部標準檢驗局:

- EMC standard: CNS 13438
- Safety standard: CNS 14336-1

最大操作溫度 (T<sup>max</sup>) (建議有): 70 °C

RoHS 資訊表格。

單元 Unit	限用物質及其化學符號 Restricted substances and their chemical symbols					
	鉛 Lead (Pb)	汞 Mercury (Hg)	鎘 Cadmium (Cd)	六價鉻 Hexavalent chromium (Cr <sup>+6</sup> )	多溴聯苯 Polybrominated biphenyls (PBB)	多溴二苯醚 Polybrominated diphenyl ethers (PBDE)
機箱/檔 Enclosure	-	○	○	○	○	○
金屬機械部 件 (支架,散 熱器, 緊固 件等) Metallic mechanical parts (bracket, heatsink, fasteners etc.)	-	○	○	○	○	○
電路板組件 PCBA	-	○	○	○	○	○
電線/連接器 Cables/ connectors	-	○	○	○	○	○
配件 Accessories	-	○	○	○	○	○
備考 1. “超出 0.1 wt %” 及 “超出 0.01 wt %” 係指限用物質之百分比含量超出百分比含量基準值。 備考 2. “○” 係指該項限用物質之百分比含量未超出百分比含量基準值。 備考 3. “-” 係指該項限用物質為排除項目。						

台灣製造商或台灣進口商公司名稱, 地址, 電話:

中文公司名稱 (Manufacturing company name)	思科系統
中文公司名稱 (Manufacturing company name)	Cisco Systems, Inc.
英文公司地址 (Manufacturing company address)	170 West Tasman Dr. San Jose, CA 95134, USA

此為甲類資訊技術設備，於居住環境中使用時，可能會造成射頻擾動，在此種情況下，使用者會被要求採取某些適當的對策。

根據 NCC LP0002 低功率射頻器材技術規範\_章節 3.8.2: 取得審驗證明之低功率射頻器材，非經核准，公司、商號或使用者均不得擅自變更頻率、加大功率或變更原設計之特性及功能。低功率射頻器材之使用不得影響飛航安全及干擾合法通信；經發現有干擾現象時，應立即停用，並改善至無干擾時方得繼續使用。前述合法通信，指依電信管理法規定作業之無線電通信。低功率射頻器材須忍受合法通信或工業、科學及醫療用電波輻射性電機設備之干擾。

## 15. Notices and copyright



### WARNING

Installation of Cisco hardware devices and their supporting infrastructure must be done by suitably qualified personnel only. In some countries, installation by a certified electrician may be required.

Hardware installations must comply with all applicable local legislation.



### WARNING

Never disassemble a Cisco hardware device to any extent that is not described in the relevant device user's manual. Cisco devices contain no user-serviceable parts. Disassembling a Cisco hardware device will invalidate the device warranty, and may compromise the operational integrity of the device.

On some Cisco radio transceiver devices, the lower access cover must be removed to gain access to the hardware *Reset* button. Do not operate a radio transceiver device for extended periods if its lower access cover has been removed.



### WARNING

To avoid danger from non-ionizing radiation and/or electric shock and/or high-intensity laser or LED light sources, be sure to install the unit only in a location with restricted access.



### WARNING

To avoid danger from electric shock, do not expose the unit to water or high humidity if the unit is powered ON, or if any access covers have been removed from the unit enclosure.

Do not place liquid-filled objects on or above the unit.

### NOTICE TO THE USER

Copyright © 2020 Cisco and/or its affiliates. All rights reserved. This manual and the software described herein shall not, in whole or in part, be reproduced, translated or reduced to any machine-readable form without the prior written consent of Cisco Systems.

Cisco and/or its affiliates provides no warranty with regard to this manual, software or other information contained herein, and hereby expressly disclaims any implied warranties of merchantability or fitness for any particular purpose with regard to this manual, the software or such other information. In no event shall Cisco Systems be held liable for any

incidental, consequential or special damages, whether based on tort, contract or otherwise, arising out of or in connection with this manual, the software or other information contained herein, or use thereof.

Cisco Systems reserves the right to make any modification to this manual or the information contained herein at any time, without notice. The software described herein may also be governed by the terms of a separate end-user license agreement.

Fluidmesh is a registered trademark of Cisco Systems. MeshWizard, EasyMesh, FMQuadro, FluidThrottle, VOLO, Fluidity, Virtual Gig, ENDO and MOBI are trademarks of Fluidmesh Networks LLC.

Microsoft, Windows, Internet Explorer and Microsoft Edge are registered trademarks of the Microsoft Corporation in the United States and/or other countries.

Ethernet is a registered trademark of the Xerox Corporation.

Adobe and Flash Player are registered trademarks of Adobe Systems Incorporated in the United States and/or other countries.

All other brands and product names that appear in this manual may be trademarks or registered trademarks. Such brands and product names are the property of their respective owners.



## 16. Fluidmesh end-user license agreement

### 16.1. Preamble

This License Agreement strictly prohibits you from using the Fluidmesh Firmware on any device other than a Fluidmesh Device. You are also prohibited from removing or modifying any Cisco or Fluidmesh copyright notice, trademark or user interface of the Fluidmesh Firmware or any Fluidmesh Device.

The Fluidmesh Firmware is copyright-protected material under United States and international copyright and other applicable laws. Unauthorized copying, use or modification of any part of this firmware, or violation of the terms of this Agreement, will be prosecuted to the maximum extent allowable under law.

### 16.2. Notice

This is an agreement between you and Fluidmesh, a division of Cisco (hereafter known as 'Fluidmesh').

You must read and agree to the terms of this firmware license agreement (hereafter known as the 'agreement') before any Fluidmesh firmware can be downloaded, installed or used. By clicking the 'Accept' button on any Fluidmesh firmware download webpage, or by downloading, installing or using Fluidmesh firmware and/or by using any Fluidmesh device running Fluidmesh firmware, you are agreeing to be bound by the terms and conditions of this agreement. If you do not agree with the terms and conditions of this agreement, then you should not download, install or use any Fluidmesh firmware, and you agree to forego any implied or stated rights to download, install or use Fluidmesh firmware.

### 16.3. Definitions

For the purpose of this Agreement, the following terms shall have the following meanings:

'Open Source Software' means any software or software component, module or package that contains, or is derived in any manner (in whole or in part) from, any software that is distributed as free software, opensource software or similar licensing or distribution models, including, without limitation, software licensed or distributed under any of the following licenses or distribution models, or licenses or distribution modelssimilar to any of the following: (a) GNU's General Public License (GPL) or Lesser/Library GPL (LGPL); (b) the Artistic License (e.g., PERL); (c) the Mozilla Public License; (d) the BSD License; and (e) the Apache License;

'Fluidmesh Device' means a Fluidmesh networking device that you purchase or otherwise rightfully acquire;

'Fluidmesh Firmware' means the firmware in object code form made available by Fluidmesh for Fluidmesh Devices; and

'You' and 'Your' mean the company, entity or individual who owns or otherwise rightfully acquires the Fluidmesh Device into which the Fluidmesh Firmware will be incorporated.

## 16.4. License grant

Fluidmesh grants you a non-exclusive, non-transferable license to use a copy of the Fluidmesh Firmware and accompanying documentation and any updates or upgrades thereto provided by Fluidmesh according to the terms set forth below. You are authorized by this license to use the Fluidmesh Firmware in object code form only, and solely in conjunction with applicable and permitted Fluidmesh-branded products and/or services and in accordance with the applicable documentation. You are granted a limited and non-exclusive license (without the right to sub-license) to use the software solely for the Fluidmesh Devices that you own and control, and solely for use in conjunction with the Fluidmesh Firmware.

## 16.5. Uses and restrictions on use

You may:

(a) download and use Fluidmesh Firmware for use in Fluidmesh Devices, and make copies of the Fluidmesh Firmware as reasonably necessary for such use, provided that you reproduce, unaltered, all proprietary notices that exist on or in the copies.

You may not, and shall not permit others to:

(a) use the Fluidmesh Firmware on any devices or products that are not owned by you or your business organization;

(b) use the Fluidmesh Firmware on any non-Fluidmesh Devices;

(c) copy the Fluidmesh Firmware (except as expressly permitted above), or copy the accompanying documentation;

(d) modify, translate, reverse engineer, decompile, disassemble or otherwise attempt (i) to defeat, avoid, bypass, remove, deactivate, or otherwise circumvent any software protection mechanisms in the Fluidmesh Firmware, including without limitation any such mechanism used to restrict or control the functionality of the Fluidmesh Firmware, or (ii) to derive the source code or the underlying ideas, algorithms, structure or organization from the Fluidmesh Firmware (except that the foregoing limitation does not apply to the extent that such activities may not be prohibited under applicable law); or

(e) distribute, rent, transfer or grant any rights in the Fluidmesh Firmware or modifications thereof or accompanying documentation in any form to any person without the prior written consent of Fluidmesh.

(f) remove any Cisco or Fluidmesh copyright notice, or Cisco or Fluidmesh branding from the Fluidmesh Firmware or modify any user interface of the Fluidmesh Firmware or Fluidmesh Device.

Fluidmesh Devices must be properly installed and they are sold for installation by a professional installer only. Fluidmesh Devices must be installed by a professional installer of wireless networking products certified by Fluidmesh, and they are not designed for installation by the general public. It is your responsibility to follow local country regulations, including operation within legal frequency channels, output power, and Dynamic Frequency Selection (DFS) requirements. You are responsible for keeping the devices working according to these rules.

(g) The Fluidmesh Firmware contains technological protection or other security features designed to prevent unauthorized use of the Fluidmesh Firmware, including features to protect against use of the Fluidmesh Firmware beyond the scope of the license granted herein, or in a manner prohibited herein. You agree that you shall not, and shall not attempt to, remove, disable, circumvent or otherwise create or implement any workaround to, any such copy protection or security features.

This license is not a sale. Title and copyrights to the Fluidmesh Firmware, and any copy made by you, remain with Fluidmesh and its suppliers. Unauthorized copying of the Fluidmesh Firmware or the accompanying documentation, or failure to comply with the above restrictions, will result in automatic termination of this license and will make other legal remedies available to Fluidmesh.

## 16.6. Open-source software

You hereby acknowledge that the Fluidmesh Firmware may contain Open Source Software. You agree to review any documentation that accompanies the Fluidmesh Firmware or is identified in the documentation for the Fluidmesh Firmware, in order to determine which portions of the Fluidmesh Firmware are Open Source Software and are licensed under an Open Source Software license. To the extent that any such license requires that Fluidmesh provide you with rights to copy, modify, distribute or otherwise use any Open Source Software that are inconsistent with the limited rights granted to you in this Agreement, then such rights in the applicable Open Source Software license shall take precedence over the rights and restrictions granted in this Agreement, but solely with respect to such Open Source Software. You acknowledge that the Open Source Software license is solely between you and the applicable licensor of the Open Source Software. You shall comply with the terms of all applicable Open Source Software licenses, if any. Copyrights to the Open Source Software are held by the copyright holders indicated in the copyright notices in the corresponding source files, or as disclosed at [www.fluidmesh.com](http://www.fluidmesh.com).

## 16.7. Termination

This license will continue until terminated. Unauthorized copying of the Fluidmesh Firmware or failure to comply with the above restrictions will result in automatic termination of this Agreement and will make other legal

remedies available to Fluidmesh. This license will also automatically terminate if you go into liquidation, suffer or make any winding-up petition, make an arrangement with your creditors, or suffer or file any similar action in any jurisdiction in consequence of debt.

Furthermore, Fluidmesh may immediately terminate this Agreement if (i) you fail to cure a breach of this Agreement (other than a breach pursuant to Fluidmesh intellectual property rights) within thirty (30) calendar days after its receipt of written notice regarding such breach, or (ii) you breach any Fluidmesh intellectual property right. Upon termination of this license for any reason, you agree to destroy all copies of the Fluidmesh Firmware. Any use of the Fluidmesh Firmware after termination is unlawful.

## 16.8. Feedback

You may provide suggestions, comments or other feedback ('Feedback') with respect to Fluidmesh Firmware, and Fluidmesh Devices. Feedback, even if designated as confidential by you, shall not impose any confidentiality obligations on Fluidmesh. You agree that Fluidmesh is free to use, disclose, reproduce, license or otherwise distribute and exploit any Feedback provided by you as Fluidmesh sees fit, entirely without obligation or restriction of any kind on account of intellectual property rights, or otherwise.

## 16.9. Consent to use of data

You acknowledge and agree that Fluidmesh may, directly or indirectly through the services of third parties, collect and store information regarding the use and performance of the Fluidmesh Firmware and Fluidmesh Devices, and about equipment through which it otherwise is accessed and used.

You further agree that Fluidmesh may use such information for any purpose related to any use of the Fluidmesh Firmware and Fluidmesh Devices by you, including, without limitation, improving the performance of the Fluidmesh Firmware or developing updates and verifying your compliance with the terms of this Agreement and enforcing Fluidmesh's rights, including all intellectual property rights in and to the Fluidmesh Firmware.

Fluidmesh shall have the right to collect and analyze data and other information relating to the provision, use and performance of various aspects of the Fluidmesh Firmware and Fluidmesh Devices and related systems and technologies ('Data'), and you give Fluidmesh the right to use and disclose such Data (during and after the term of this Agreement) in accordance with Fluidmesh's Privacy Policy. If you choose to allow diagnostic and usage collection, you agree that Fluidmesh and its subsidiaries and agents may collect, maintain, process and use diagnostic, technical, usage and related information, including but not limited to unique system or hardware identifiers, information about your

device, system and software, that is gathered periodically to provide and improve Fluidmesh's products and services, facilitate the provision of software updates, product support and other services to you (if any) related to Fluidmesh products, and to verify compliance with the terms of this license. Fluidmesh may use this information, as long as it is collected in a form that does not personally identify you, for the purposes described above.

To enable Fluidmesh's partners and third-party developers to improve their software, hardware and services designed for use with Fluidmesh products, Fluidmesh may also provide any such partner or third-party developer with a subset of diagnostic information that is relevant to that partner's or developer's software, hardware and/or services, as long as the diagnostic information is in a form that does not personally identify you.

## 16.10. Warranty disclaimer

Fluidmesh Firmware, including without limitation any open source software, any Fluidmesh Device, and any accompanying documentation are provided 'As is', and Fluidmesh and its suppliers make, and you receive, no warranties or conditions, whether express, implied, statutory or otherwise, or in any communication with you, and Fluidmesh and its suppliers specifically disclaim any implied warranty of merchantability, satisfactory quality, fitness for a particular purpose, or non-infringement and their equivalents.

Fluidmesh does not warrant that the operation of the Fluidmesh Firmware will be uninterrupted or error-free or that the Fluidmesh Firmware will meet your specific requirements. You acknowledge that Fluidmesh has no support or maintenance obligations for the Fluidmesh Firmware.

## 16.11. Limitation of liability

Except to the extent that liability may not by law be limited or excluded, in no event will Fluidmesh or its suppliers be liable for loss of, or corruption to data, lost profits or loss of contracts, cost of procurement of substitute products or other special, incidental, punitive, consequential or indirect damages arising from the supply or use of the Fluidmesh Firmware, howsoever caused and on any theory of liability (including without limitation negligence).

This limitation will apply even if Fluidmesh or an authorized distributor or authorized reseller has been advised of the possibility of such damages, and notwithstanding the failure of essential purpose of any limited remedy. In no event shall Fluidmesh's or its suppliers' or its resellers' liability exceed five hundred United States dollars (US\$ 500). You acknowledge that this provision reflects a reasonable allocation of risk.

## 16.12. Exclusion of liability for emergency services

Fluidmesh does not support, nor are the services intended to support or carry, emergency calls to any emergency services, including but not limited to 911 dialing.

Fluidmesh will not be held responsible for any liability or any losses, and you, on behalf of yourself and all persons using the services through the licensed products, hereby waive any and all such claims or causes of action for losses arising from, or relating to, any party's attempts to contact emergency service providers using the licensed products, including but not limited to calls to public safety answering points.

Fluidmesh will not be held liable for any losses, whether in contract, warranty, tort (including negligence), or any other form of liability, for any claim, damage, or loss, (and you hereby waive any and all such claims or causes of action), arising from or relating to your (i) inability to use the services to contact emergency services, or (ii) failure to make additional arrangements to access emergency services.

The parties expressly acknowledge and agree that Fluidmesh has set its prices and entered into this agreement in reliance upon the limitations of liability and disclaimers of warranties specified herein, which allocate the risk between Fluidmesh and the end user and form a basis of the bargain between the parties.

## 16.13. Export control

You acknowledge that the Fluidmesh Devices, Fluidmesh Firmware, documents, technical data, and any other materials delivered under this Agreement are subject to U.S. export control laws, and may also be subject to export or import regulations in other countries. You agree to comply strictly with these laws and regulations and acknowledge that you have the responsibility to obtain any licenses to export, re-export, or import as may be required after delivery to you. You shall not, directly or indirectly, export, re-export or release the Fluidmesh Devices and Fluidmesh Firmware, to, or make the Fluidmesh Devices and Fluidmesh Firmware accessible from any jurisdiction or country to which export, re-export or release is prohibited by law, rule or regulation. In particular, but without limitation, the Fluidmesh Devices and Fluidmesh Firmware may not be exported or re-exported (a) into any U.S. embargoed countries or (b) to anyone on the U.S. Treasury Department's list of Specially Designated Nationals or the U.S. Department of Commerce Denied Person's List or Entity List.

By using the Fluidmesh Devices and Fluidmesh Firmware, you represent and warrant that you are not located in any such country or on any such list. You acknowledge and agree that you shall strictly comply with all applicable laws, regulations and rules, and complete all required undertakings (including obtaining any necessary export license or other governmental approval), prior to operating the Fluidmesh Devices and

Fluidmesh Firmware, or exporting, re-exporting, releasing or otherwise making the Fluidmesh Devices and Fluidmesh Firmware available outside the U.S. You acknowledge and agree that Fluidmesh has no further responsibility after the initial delivery to you, and you hereby agree to indemnify and hold Fluidmesh harmless from and against all claim, loss, liability or damage suffered or incurred by Fluidmesh resulting from, or related to your failure to comply with all export or import regulations.

## 16.14. General

This Agreement shall not be governed by the 1980 U.N. Convention on Contracts for the International Sale of Goods. Rather, this Agreement shall be governed by the laws of the State of Illinois, including its Uniform Commercial Code, without reference to conflicts of laws principles. You agree to the exclusive jurisdiction and venue of the State and Federal courts in Illinois, United States.

This Agreement is the entire agreement between you and Fluidmesh, and supersedes any other communications or advertising with respect to the Fluidmesh Firmware and accompanying documentation. If any provision of this Agreement is held invalid or unenforceable, such provision shall be revised to the extent necessary to cure the invalidity or unenforceability, and the remainder of the Agreement shall continue in full force and effect.

This Agreement and all documents, notices, evidence, reports, opinions and other documents given or to be given under this Agreement (collectively with this Agreement, 'Documents') are and will be written in the English language only. In the event of any inconsistency between any Document in the English language and any translation of it into another language, the English-language Document shall prevail. If you are acquiring the Fluidmesh Firmware on behalf of any part of the U.S. Government, the following provisions apply: The Fluidmesh Firmware and accompanying documentation are deemed to be 'commercial computer software' and 'commercial computer software documentation' respectively, pursuant to DFAR Section 227.7202 and FAR 12.212(b), as applicable. Any use, modification, reproduction, release, performance, display or disclosure of the Fluidmesh Firmware and/or the accompanying documentation by the U.S. Government or any of its agencies shall be governed solely by the terms of this Agreement and shall be prohibited except to the extent expressly permitted by the terms of this Agreement. Any technical data provided that is not covered by the above provisions is deemed to be 'technical data-commercial items' pursuant to DFAR Section 227.7015(a). Any use, modification, reproduction, release, performance, display or disclosure of such technical data shall be governed by the terms of DFAR Section 227.7015(b).

Fluidmesh is a trademark of Cisco Systems in the United States and worldwide.

## 17. Contact us

**Worldwide Headquarters:**

Fluidmesh Networks LLC

81 Prospect Street

Brooklyn, New York 11201

United States of America

Tel. +1 (617) 209 -6080

Fax. +1 (866) 458-1522

[info@fluidmesh.com](mailto:info@fluidmesh.com)

Technical Support desk: [support@fluidmesh.com](mailto:support@fluidmesh.com)

[www.fluidmesh.com](http://www.fluidmesh.com)

**Regional headquarters for Europe, the Middle East and Africa:**

Tel. +39 02 0061 6189

**Regional headquarters for the United Kingdom:**

Tel. +44 2078 553 132

**Regional headquarters for France:**

Tel. +33 1 82 88 33 6

**Regional headquarters for Australia and New Zealand:**

Tel: +61 401 747 403