









Cisco 1.2 GHz GainMaker Line Extender Installation and Operation Guide

For Your Safety

Explanation of Warning and Caution Icons

Avoid personal injury and product damage! Do not proceed beyond any symbol until you fully understand the indicated conditions.

The following warning and caution icons alert you to important information about the safe operation of this product:

-  You may find this symbol in the document that accompanies this product. This symbol indicates important operating or maintenance instructions.
-  You may find this symbol affixed to the product. This symbol indicates a live terminal where a dangerous voltage may be present; the tip of the flash points to the terminal device.
-  You may find this symbol affixed to the product. This symbol indicates a protective ground terminal.
-  You may find this symbol affixed to the product. This symbol indicates a chassis terminal (normally used for equipotential bonding).
-  You may find this symbol affixed to the product. This symbol warns of a potentially hot surface.
-  You may find this symbol affixed to the product and in this document. This symbol indicates an infrared laser that transmits intensity-modulated light and emits invisible laser radiation or an LED that transmits intensity-modulated light.

Important

Please read this entire guide. If this guide provides installation or operation instructions, give particular attention to all safety statements included in this guide.

Notices

Trademark Acknowledgments

- Cisco, the Cisco logo, Cisco Systems, the Cisco Systems logo, and GainMaker are trademarks or registered trademarks of Cisco Systems, Inc. and/or its affiliates in the U.S. and certain other countries.
- *All other trademarks mentioned in this document are the property of their respective owners.*

Publication Disclaimer

Cisco Systems, Inc., assumes no responsibility for errors or omissions that may appear in this publication. We reserve the right to change this publication at any time without notice. This document is not to be construed as conferring by implication, estoppel, or otherwise any license or right under any copyright or patent, whether or not the use of any information in this document employs an invention claimed in any existing or later issued patent.

Copyright

© 2016 Cisco Systems, Inc. All rights reserved. Printed in the United States of America.

Information in this publication is subject to change without notice. No part of this publication may be reproduced or transmitted in any form, by photocopy, microfilm, xerography, or any other means, or incorporated into any information retrieval system, electronic or mechanical, for any purpose, without the express permission of Cisco Systems, Inc.

Contents

Important Safety Instructions	vii
--------------------------------------	------------

Introduction	1
---------------------	----------

Description.....	3
Characteristics	3
Power Supply	4
Input and Output Ports.....	4
Configuration	4
Test Points.....	4
AC Shunt Power Directors	6
Ordering Information.....	6
Illustrations	7
Line Extender Test Points	7
Line Extender Accessories.....	8
Block Diagrams	9

Installation and Configuration	11
---------------------------------------	-----------

Before You Begin.....	12
Required Tools	12
Torque Specifications	12
Module Cover.....	13
Module and Housing Compatibility.....	13
Housing Dimensions.....	13
Opening the Line Extender Housing.....	15
To Open the Line Extender Housing	15
Upgrading Existing Housing Seizures.....	16
To Install the New Housing Seizures.....	16
Upgrading an Existing Housing Lid.....	18
To Install the New Housing Lid	18
Installing the Power Supply	20
To Install the Power Supply Module	20
To Set the AC Undervoltage Lockout Selector	22
Attaching the Coaxial Connectors.....	24
To Trim the Center Conductor.....	24
To Connect the Coaxial Cable Pin Connector to the Line Extender Housing.....	24
Installing the Housing.....	25
To Install the Housing on a Strand (Aerial)	25

Contents

To Install the Housing in a Pedestal.....	26
Installing Accessories	28
To Install Attenuator Pads.....	28
To Install Equalizers	29
To Install the Crowbar Surge Protector	30
Installing the Line Extender Module	33
To Install the Line Extender Module.....	33
Removing the Line Extender Module from the Housing.....	36
To Remove the Line Extender Module	36
Removing and Installing AC Shunt Power Directors.....	38
To Remove and Install AC Shunt Power Directors.....	38
Closing the Line Extender Housing	40
To Close the Line Extender Housing	40
Torquing Sequence	40

Balancing and Setup 41

Preparing for Forward Path Balancing	42
Understanding Switch S1 Functions	42
To Verify the Input Signal Level.....	45
Balancing the Forward Path	47
To Select the Forward Path Balancing Procedure	48
Forward Path Balancing for AGC Stations Using Manual Setup Mode	48
Forward Path Balancing for AGC Stations Using Thermal Setup Mode.....	58
Forward Path Balancing for Thermal Stations Using Line Extender Only Compensation Mode	66
Forward Path Balancing for Thermal Stations Using Line Extender and Coax Compensation Mode	69
Forward Path Balancing for Manual Stations.....	73
No Switch 1 Setting for Manual Stations	73
Forward Path Balancing Using Trim Networks	75
Balancing the Reverse Path.....	77
About Reverse Path Balancing.....	77
To Prepare the Line Extender for Reverse Path Balancing	79
To Calculate the Proper RF Signal Level	80
To Complete Reverse Path Balancing	81

Troubleshooting 83

Equipment.....	84
No AC Power.....	85
No AC Power Troubleshooting Table.....	86
No DC Power.....	87
No DC Power Troubleshooting Table.....	88

No Forward RF Signal.....	89
No Forward RF Signal Troubleshooting Table.....	89
Low or Degraded Forward RF Signal.....	90
Low or Degraded Forward RF Signal Troubleshooting Table.....	90
No Reverse RF Signal.....	92
No Reverse RF Signal Troubleshooting Table.....	92
Low or Degraded Reverse RF Signal.....	93
Low or Degraded Reverse RF Signal Troubleshooting Table.....	93

Customer Support Information 95

Appendix A Technical Information 97

“Linear” Tilt Charts.....	98
Line Extender Output “Linear” Tilt Chart for 1.2 GHz.....	98
Line Extender Output “Linear” Tilt Chart for 1 GHz.....	98
Line Extender Output “Linear” Tilt Chart for 870 MHz.....	99
Forward Cable Equalizer Charts.....	101
1.2 GHz Forward Cable Equalizer Loss Chart.....	101
1 GHz Forward Cable Equalizer Loss Chart.....	102
870 MHz Forward Cable Equalizer Loss Chart.....	103
Reverse Cable Equalizer Charts.....	104
42 MHz and 40 MHz Reverse Cable Equalizer Loss Chart.....	104
55 MHz Reverse Cable Equalizer Loss Chart.....	105
65 MHz Reverse Cable Equalizer Loss Chart.....	106

Glossary 107

Index 111

Important Safety Instructions

Read and Retain Instructions

Carefully read all safety and operating instructions before operating this equipment, and retain them for future reference.

Follow Instructions and Heed Warnings

Follow all operating and use instructions. Pay attention to all warnings and cautions in the operating instructions, as well as those that are affixed to this equipment.

Terminology

The terms defined below are used in this document. The definitions given are based on those found in safety standards.

Service Personnel - The term *service personnel* applies to trained and qualified individuals who are allowed to install, replace, or service electrical equipment. The service personnel are expected to use their experience and technical skills to avoid possible injury to themselves and others due to hazards that exist in service and restricted access areas.

User and Operator - The terms *user* and *operator* apply to persons other than service personnel.

Ground(ing) and Earth(ing) - The terms *ground(ing)* and *earth(ing)* are synonymous. This document uses *ground(ing)* for clarity, but it can be interpreted as having the same meaning as *earth(ing)*.

Electric Shock Hazard

This equipment meets applicable safety standards.



WARNING:

To reduce risk of electric shock, perform only the instructions that are included in the operating instructions. Refer all servicing to qualified service personnel only.

Electric shock can cause personal injury or even death. Avoid direct contact with dangerous voltages at all times.

Know the following safety warnings and guidelines:

Important Safety Instructions

- Only qualified service personnel are allowed to perform equipment installation or replacement.
- Only qualified service personnel are allowed to remove chassis covers and access any of the components inside the chassis.

Equipment Placement



WARNING:

Avoid personal injury and damage to this equipment. An unstable mounting surface may cause this equipment to fall.

To protect against equipment damage or injury to personnel, comply with the following:

- Install this equipment in a restricted access location (access restricted to service personnel).
- Make sure the mounting surface or rack is stable and can support the size and weight of this equipment.

Strand (Aerial) Installation



CAUTION:

Be aware of the size and weight of strand-mounted equipment during the installation operation.

Ensure that the strand can safely support the equipment's weight.

Pedestal, Service Closet, Equipment Room or Underground Vault Installation



WARNING:

Avoid the possibility of personal injury. Ensure proper handling/lifting techniques are employed when working in confined spaces with heavy equipment.

- Ensure this equipment is securely fastened to the mounting surface or rack where necessary to protect against damage due to any disturbance and subsequent fall.
- Ensure the mounting surface or rack is appropriately anchored according to manufacturer's specifications.
- Ensure the installation site meets the ventilation requirements given in the equipment's data sheet to avoid the possibility of equipment overheating.

- Ensure the installation site and operating environment is compatible with the equipment's International Protection (IP) rating specified in the equipment's data sheet.

Connecting to Utility AC Power

Important: If this equipment is a Class I equipment, it must be grounded.

- If this equipment plugs into an outlet, the outlet must be near this equipment, and must be easily accessible.
- Connect this equipment only to the power sources that are identified on the equipment-rating label, which is normally located close to the power inlet connector(s).
- This equipment may have two power sources. Be sure to disconnect all power sources before working on this equipment.
- If this equipment **does not** have a main power switch, the power cord connector serves as the disconnect device.
- Always pull on the plug or the connector to disconnect a cable. Never pull on the cable itself.

Connection to Network Power Sources

Refer to this equipment's specific installation instructions in this manual or in companion manuals in this series for connection to network ferro-resonant AC power sources.

AC Power Shunts

AC power shunts may be provided with this equipment.

Important: The power shunts (where provided) must be removed before installing modules into a powered housing. With the shunts removed, power surge to the components and RF-connectors is reduced.



CAUTION:

RF connectors and housing seizure assemblies can be damaged if shunts are not removed from the equipment before installing or removing modules from the housing.

Grounding (Utility AC Powered Equipment in Pedestals, Service Closets, etc.)

This section provides instructions for verifying that the equipment is properly grounded.

Safety Plugs (USA Only)

This equipment is equipped with either a 3-terminal (grounding-type) safety plug or a 2-terminal (polarized) safety plug. The wide blade or the third terminal is provided for safety. Do not defeat the safety purpose of the grounding-type or polarized safety plug.

To properly ground this equipment, follow these safety guidelines:

- **Grounding-Type Plug** - For a 3-terminal plug (one terminal on this plug is a protective grounding pin), insert the plug into a grounded mains, 3-terminal outlet.
Note: This plug fits only one way. If this plug cannot be fully inserted into the outlet, contact an electrician to replace the obsolete 3-terminal outlet.
- **Polarized Plug** - For a 2-terminal plug (a polarized plug with one wide blade and one narrow blade), insert the plug into a polarized mains, 2-terminal outlet in which one socket is wider than the other.
Note: If this plug cannot be fully inserted into the outlet, try reversing the plug. If the plug still fails to fit, contact an electrician to replace the obsolete 2-terminal outlet.

Grounding Terminal

If this equipment is equipped with an external grounding terminal, attach one end of an 18-gauge wire (or larger) to the grounding terminal; then, attach the other end of the wire to a ground, such as a grounded equipment rack.

Safety Plugs (European Union)

- **Class I Mains Powered Equipment** – Provided with a 3-terminal AC inlet and requires connection to a 3-terminal mains supply outlet via a 3-terminal power cord for proper connection to the protective ground.
Note: The equipotential bonding terminal provided on some equipment is not designed to function as a protective ground connection.
- **Class II Mains Powered Equipment** – Provided with a 2-terminal AC inlet that may be connected by a 2-terminal power cord to the mains supply outlet. No connection to the protective ground is required as this class of equipment is provided with double or reinforced and/or supplementary insulation in

addition to the basic insulation provided in Class I equipment.

Note: Class II equipment, which is subject to EN 50083-1, is provided with a chassis mounted equipotential bonding terminal. See the section titled **Equipotential Bonding** for connection instructions.

Equipotential Bonding

If this equipment is equipped with an external chassis terminal marked with the IEC 60417-5020 chassis icon () , the installer should refer to CENELEC standard EN 50083-1 or IEC standard IEC 60728-11 for correct equipotential bonding connection instructions.

General Servicing Precautions



WARNING:

Avoid electric shock! Opening or removing this equipment's cover may expose you to dangerous voltages.



CAUTION:

These servicing precautions are for the guidance of qualified service personnel only. To reduce the risk of electric shock, do not perform any servicing other than that contained in the operating instructions unless you are qualified to do so. Refer all servicing to qualified service personnel.

Be aware of the following general precautions and guidelines:

- **Servicing** - Servicing is required when this equipment has been damaged in any way, such as power supply cord or plug is damaged, liquid has been spilled or objects have fallen into this equipment, this equipment has been exposed to rain or moisture, does not operate normally, or has been dropped.
- **Wristwatch and Jewelry** - For personal safety and to avoid damage of this equipment during service and repair, do not wear electrically conducting objects such as a wristwatch or jewelry.
- **Lightning** - Do not work on this equipment, or connect or disconnect cables, during periods of lightning.
- **Labels** - Do not remove any warning labels. Replace damaged or illegible warning labels with new ones.
- **Covers** - Do not open the cover of this equipment and attempt service unless instructed to do so in the instructions. Refer all servicing to qualified service personnel only.
- **Moisture** - Do not allow moisture to enter this equipment.

Important Safety Instructions

- **Cleaning** - Use a damp cloth for cleaning.
- **Safety Checks** - After service, assemble this equipment and perform safety checks to ensure it is safe to use before putting it back into operation.

Electrostatic Discharge

Electrostatic discharge (ESD) results from the static electricity buildup on the human body and other objects. This static discharge can degrade components and cause failures.

Take the following precautions against electrostatic discharge:

- Use an anti-static bench mat and a wrist strap or ankle strap designed to safely ground ESD potentials through a resistive element.
- Keep components in their anti-static packaging until installed.
- Avoid touching electronic components when installing a module.

Fuse Replacement

To replace a fuse, comply with the following:

- Disconnect the power before changing fuses.
- Identify and clear the condition that caused the original fuse failure.
- Always use a fuse of the correct type and rating. The correct type and rating are indicated on this equipment.

Batteries

This product may contain batteries. Special instructions apply regarding the safe use and disposal of batteries:

Safety

- Insert batteries correctly. There may be a risk of explosion if the batteries are incorrectly inserted.
- Do not attempt to recharge 'disposable' or 'non-reusable' batteries.
- Please follow instructions provided for charging 'rechargeable' batteries.
- Replace batteries with the same or equivalent type recommended by manufacturer.
- Do not expose batteries to temperatures above 100°C (212°F).

Disposal

- The batteries may contain substances that could be harmful to the environment
- Recycle or dispose of batteries in accordance with the battery manufacturer's instructions and local/national disposal and recycling regulations.



廢電池請回收

- The batteries may contain perchlorate, a known hazardous substance, so special handling and disposal of this product might be necessary. For more information about perchlorate and best management practices for perchlorate-containing substance, see www.dtsc.ca.gov/hazardouswaste/perchlorate.

Modifications

This equipment has been designed and tested to comply with applicable safety, laser safety, and EMC regulations, codes, and standards to ensure safe operation in its intended environment. Refer to this equipment's data sheet for details about regulatory compliance approvals.

Do not make modifications to this equipment. Any changes or modifications could void the user's authority to operate this equipment.

Modifications have the potential to degrade the level of protection built into this equipment, putting people and property at risk of injury or damage. Those persons making any modifications expose themselves to the penalties arising from proven non-compliance with regulatory requirements and to civil litigation for compensation in respect of consequential damages or injury.

Accessories

Use only attachments or accessories specified by the manufacturer.

Electromagnetic Compatibility Regulatory Requirements

This equipment meets applicable electromagnetic compatibility (EMC) regulatory requirements. Refer to this equipment's data sheet for details about regulatory compliance approvals. EMC performance is dependent upon the use of correctly shielded cables of good quality for all external connections, except the power source, when installing this equipment.

- Ensure compliance with cable/connector specifications and associated installation instructions where given elsewhere in this manual.

EMC Compliance Statements

Where this equipment is subject to USA FCC and/or Industry Canada rules, the following statements apply:

FCC Statement for Class A Equipment

This equipment has been tested and found to comply with the limits for a Class A digital device, pursuant to Part 15 of the FCC Rules. These limits are designed to provide reasonable protection against harmful interference when this equipment is operated in a commercial environment.

This equipment generates, uses, and can radiate radio frequency energy and, if not installed and used in accordance with the instruction manual, may cause harmful interference to radio communications. Operation of this equipment in a residential area is likely to cause harmful interference in which case users will be required to correct the interference at their own expense.

Industry Canada - Industrie Canadienne Statement

This apparatus complies with Canadian ICES-003.
Cet appareil est conforme à la norme NMB-003 du Canada.

CENELEC/CISPR Statement with Respect to Class A Information Technology Equipment

This is a Class A equipment. In a domestic environment this equipment may cause radio interference in which case the user may be required to take adequate measures.

1

Introduction

Overview

The 1.2 GHz GainMaker® Broadband Amplifier Platform includes a variety of RF amplifiers that address the divergent needs of today's broadband networks. All 1.2 GHz GainMaker Line Extenders provide superior two-way performance and reliability combined with a user-friendly layout.

This chapter introduces the 1.2 GHz GainMaker Line Extender and describes its main components, configuration options, and accessories.

Purpose

This guide provides instructions for installing, configuring, setting up, and troubleshooting the 1.2 GHz GainMaker Line Extender.

Who Should Use This Document

This document is intended for authorized service personnel who have experience working with similar equipment. The service personnel should have appropriate background and knowledge to complete the procedures described in this document.

Qualified Personnel



WARNING:

Allow only qualified and skilled personnel to install, operate, maintain, and service this product. Otherwise, personal injury or equipment damage may occur.

Only appropriately qualified and skilled personnel should attempt to install, operate, maintain, and service this product.

Scope

This guide discusses the following topics.

- Description of the 1.2 GHz GainMaker Line Extender
- Installing and configuring the line extender
- Balancing and setup of line extender forward and reverse signal paths
- Troubleshooting the line extender
- Customer support information
- Descriptions of configuration options and accessories

In This Chapter

■ Description.....	3
■ Illustrations.....	7
■ Block Diagrams	9

Document Version

This is the first release of this guide.

Description

The 1.2 GHz GainMaker Line Extender is available in the following amplifier types.

- Manual/Thermal
- Automatic Gain Control (AGC)

The 1.2 GHz GainMaker Line Extender is available in the following reverse path splits.

- 42/54 MHz
- 65/86 MHz
- 85/102 MHz
- 204/258 MHz

Characteristics

1.2 GHz GainMaker Line Extender modules have the following characteristics.

- -20 dB test points, located electrically outside of the diplex filter, provide for testing of forward output signals and reverse input signals without disrupting normal operation
- Housing lids offered with external test point
- Manual/Thermal version includes customer accessible switch for configuration of interstage
- Direct module plug-in to the housing provides superior line extender heat sinking
- Symmetrical housing and modules provide convenient mounting
 - Line extender housings that can be installed facing either toward or away from the street
- AC circuitry provides 15 A of steady state current capability that is able to withstand 25 A of peak current (for a maximum of 2 hours)
- Surge-resistant circuitry provides improved resistance to high voltage transients
- Chromated housing protects outdoor equipment in coastal areas and other corrosive environments
- Input and output reverse pad locations increase flexibility in reverse path design and alignment

- Compatible with existing GainMaker Line Extender back housing
- EQ and attenuator pads have the same footprint as existing products
- Spring loaded seizure on the base housing
- Easy split upgrade with simple plug-in changes

Power Supply

The DC power supply has the following features.

- Located in housing lid for ease of maintenance
- AC and DC test points provided on the power supply
- Power Voltages: 35 to 90 VAC
- Not compatible with previous GainMaker Line Extender power supply

Input and Output Ports

The 1.2 GHz GainMaker Line Extender has one input and one output port.

Configuration

The 1.2 GHz GainMaker Line Extender is pre-configured with the following.

- Diplex Filters
- Frequency split dependent High Pass Filter Trim and Low Pass Filter Trim, Forward Interstage Equalizer and 0dB Reverse Equalizer
- Forward Interstage Pad and 0dB Reverse Input Attenuator Pad
- 6kV crowbar surge protector

Test Points

There are five RF test points on the 1.2 GHz GainMaker Line Extender module.

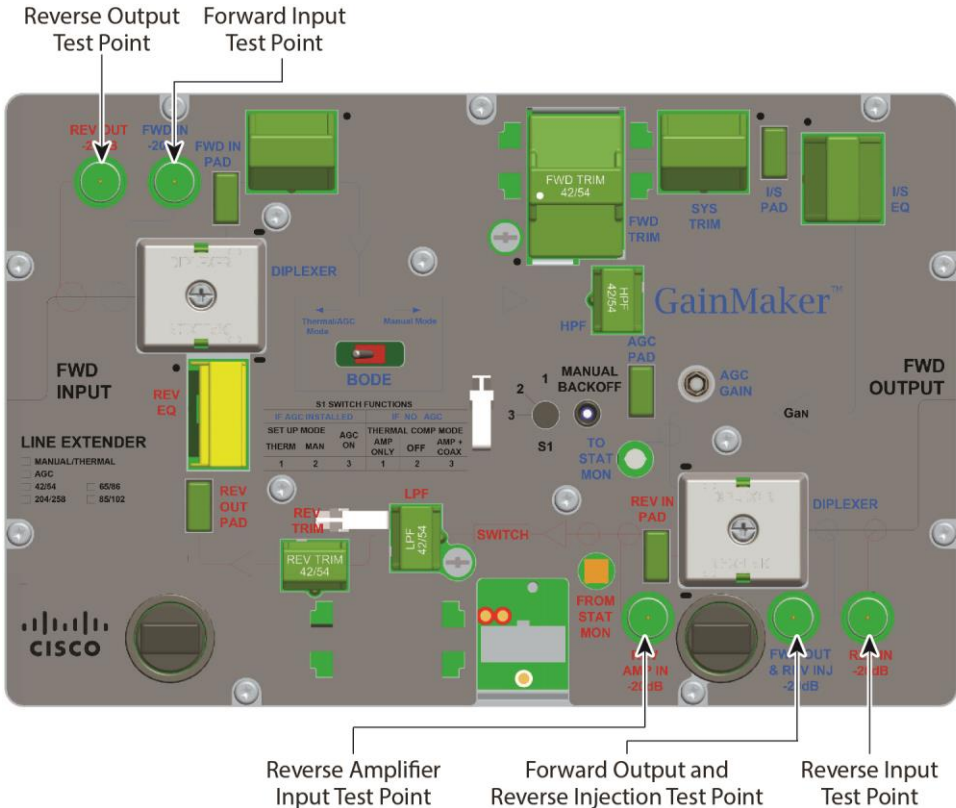

There are three voltage test points on the 1.2 GHz GainMaker Line Extender power supply.

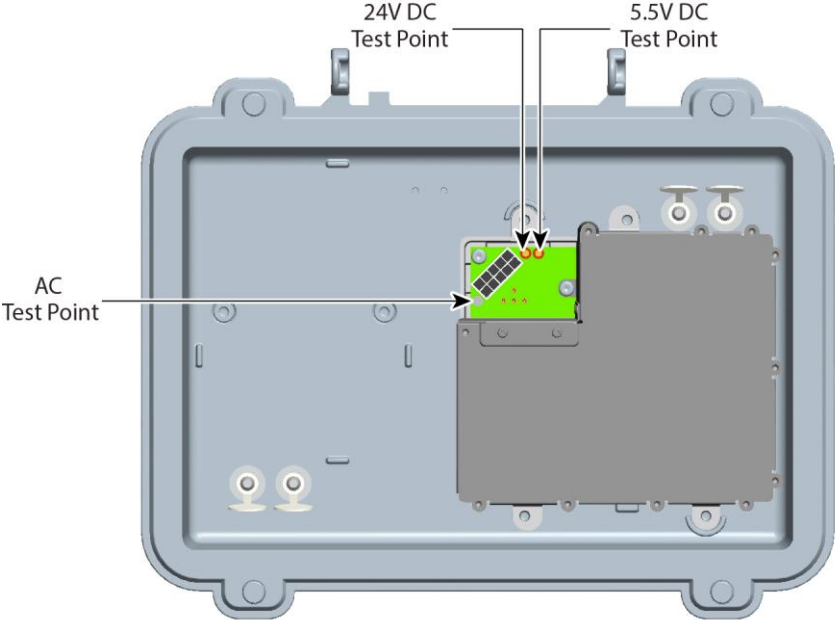

AC Shunt Power Directors

The 1.2 GHz GainMaker Line Extender has two AC shunt power directors that are used to direct AC current to and from the amplifier input and output ports.

Ordering Information

The 1.2 GHz GainMaker System Line Extender is available with several forward/reverse bandwidths and AGC pilot frequencies. There are also several customer selectable accessories which will be ordered separately by customers. These accessories may be ordered to complete the field set up of the line extender (pads, EQs, Signal Directors, etc) or a spare items (power supplies, surge protectors, etc). Please refer to the 1.2 GHz GainMaker Line Extender Data Sheet for a full listing of the Configured Amplifier Stations, RF modules, and accessories that are available.

Note: Please consult with your Account Representative, Customer Service Representative, or System Engineer to determine the best configuration for your particular application.

Illustrations

Line Extender Test Points

The following diagram shows the test points locations for the 1.2 GHz GainMaker Line Extender.

Note: The test point locations are the same for all 1.2 GHz GainMaker Line Extender models.

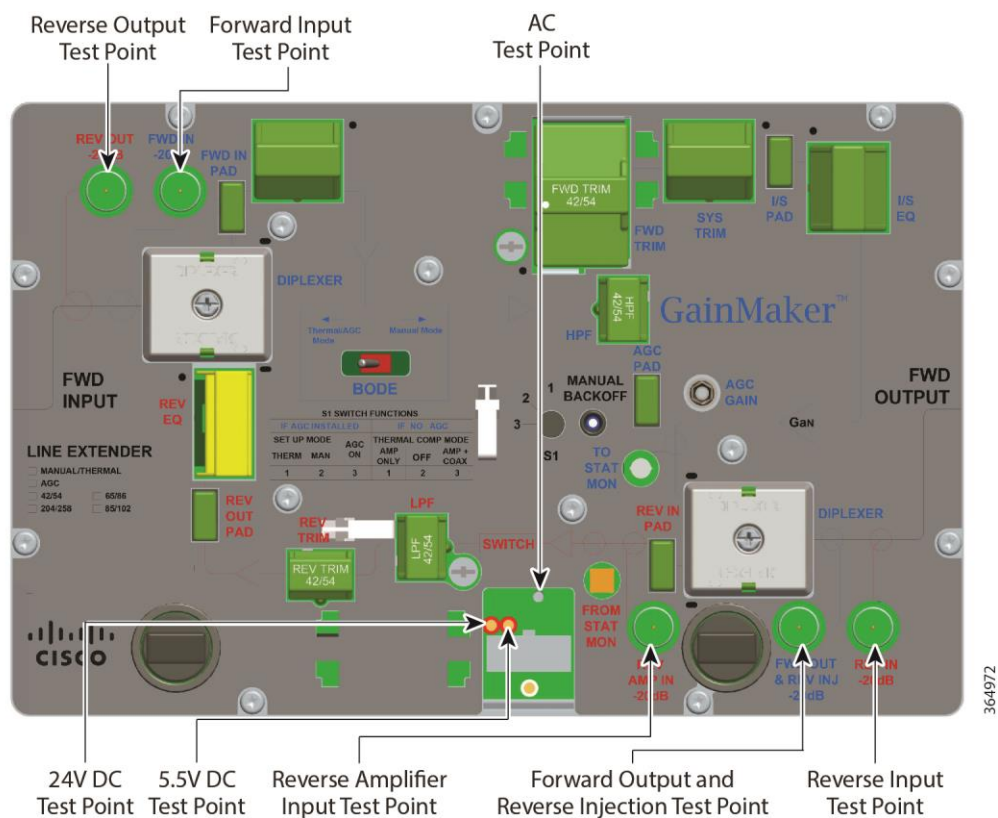

Line Extender Accessories

The following diagram shows the accessory locations for the 1.2 GHz GainMaker Line Extender.

Note: The accessory locations are the same for all 1.2 GHz GainMaker Line Extender models.

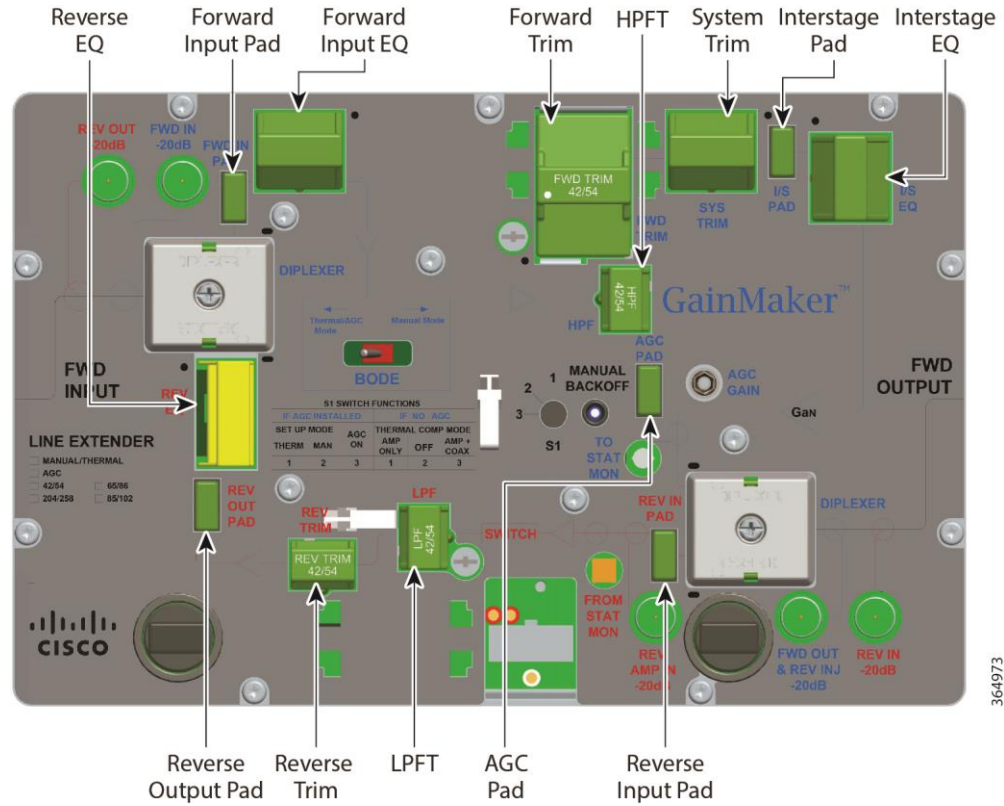

Block Diagrams

The following illustration is a block diagram of the 1.2 GHz GainMaker Line Extender module.

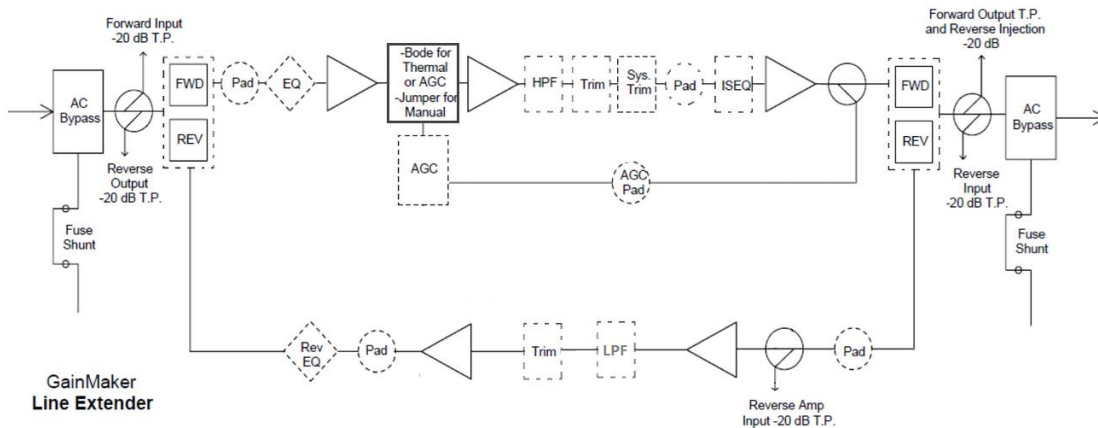

2

Installation and Configuration

Introduction

This chapter provides instructions for installing and configuring the 1.2 GHz GainMaker Line Extender in your cable system.

In This Chapter

■ Before You Begin.....	12
■ Opening the Line Extender Housing.....	15
■ Upgrading Existing Housing Seizures	16
■ Upgrading an Existing Housing Lid.....	18
■ Installing the Power Supply	20
■ Attaching the Coaxial Connectors.....	24
■ Installing the Housing.....	25
■ Installing Accessories	28
■ Installing the Line Extender Module	33
■ Removing the Line Extender Module from the Housing	36
■ Removing and Installing AC Shunt Power Directors.....	38
■ Closing the Line Extender Housing	40

Before You Begin

The procedures in this chapter assume that you have completed the following:

- Prepared the installation site
- Located the coaxial cable, with or without the pin-type coaxial connectors mounted on the cable







Required Tools

Before you start, make sure that you have the following tools:

- 1/2-inch wrench or nut driver
- Phillips-head or T-15 Torx-bit screwdriver
- Heavy-duty wire cutters or snips

Torque Specifications

The following table gives the torque specifications for the module.

Fastener	Torque Specification	Illustration
Housing hinge screw	5 in-lb to 8 in-lb (0.56 Nm to 0.90 Nm)	
Power supply module securing screws	18 in-lb to 20 in-lb (2 Nm to 2.3 Nm)	
Strand clamp mounting bracket bolts	5 ft-lb to 8 ft-lb (6.8 Nm to 10.8 Nm)	
75 ohm terminator	2 ft-lb to 4 ft-lb (2.7 Nm to 5.4 Nm)	(Appearance varies by manufacturer)
Line extender module shoulder screws (slotted head)	6 in-lb to 9 in-lb (0.7 Nm to 1.0 Nm)	
Line extender module shoulder screws (cross head)	18 in-lb to 20 in-lb (2.0 Nm to 2.25 Nm)	
Housing closure bolts	5 ft-lb to 12 ft-lb (6.8 Nm to 16.3 Nm)	

Fastener	Torque Specification	Illustration
Test point port plugs	5 ft-lb to 8 ft-lb (6.8 Nm to 10.8 Nm)	

Module Cover

1.2 GHz GainMaker Line Extender modules have an aluminum cover attached to the chassis with self-tapping screws. Normal field maintenance will not require the removal of this cover.

Module and Housing Compatibility

Housing Lid

The 1.2 GHz GainMaker Line Extender module is compatible with the GainMaker Line Extender housing lid only. The module will not work with Line Extender II or III housing lids.

Housing Base

The 1.2 GHz GainMaker Line Extender module is compatible with the GainMaker Line Extender housing base. The module will also work with Line Extender II or III housing bases. Additionally, the 1.2 GHz GainMaker Line Extender housing base is marked with a green label to indicate that it contains 15 A capable spring loaded seizures. Both 1.0 GHz and 1.2 GHz GainMaker Line Extender will operate in the new 1.2 GHz GainMaker Line Extender housing base.

Important! 1.2 GHz GainMaker Line Extender modules are marked with a blue label to indicate 15-ampere capability. The RF connectors in these modules are also marked with blue. These line extender modules must be used in conjunction with the proper GainMaker Line Extender housings, which is marked with a blue (1.0 GHz housing base) or green (1.2 GHz housing base) label.

Housing Dimensions

The diagram below shows the dimensions, in inches and millimeters, of the 1.2 GHz GainMaker Line Extender housing. Use these measurements to calculate clearance requirements for your installation.

Chapter 2 Installation and Configuration

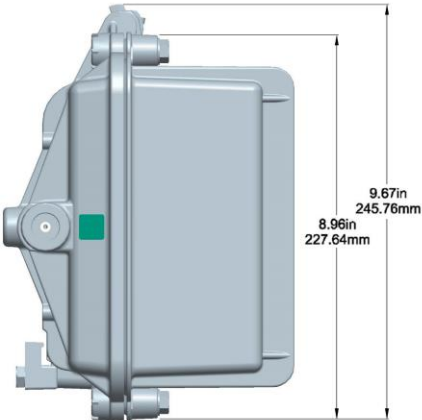
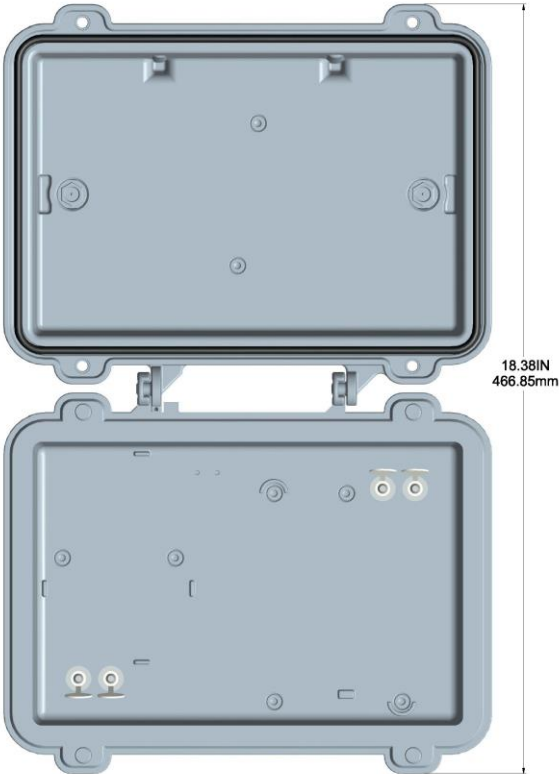
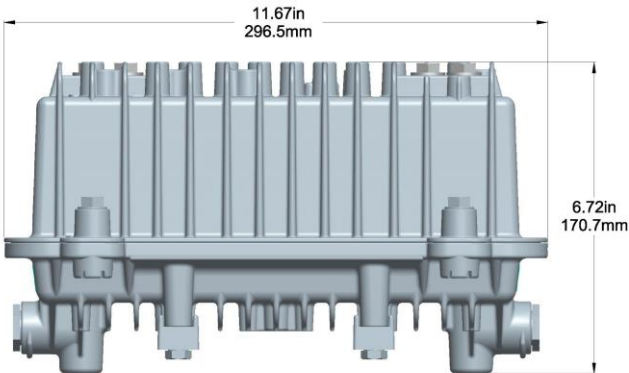

Opening the Line Extender Housing

To Open the Line Extender Housing

Complete the following steps to open the line extender housing.

Important: Before unscrewing the housing bolts, make sure the removable locking screw in the hinge is in place and secure. The locking screw prevents separation of the lid from the base.

- 1 Unscrew the ½-inch housing closure bolts on the housing lid until they are loose.

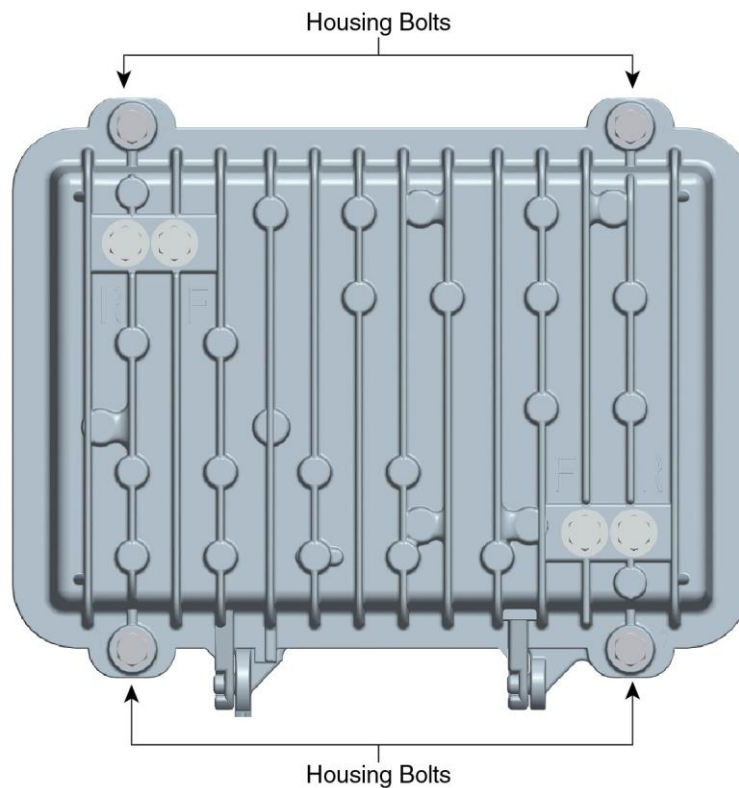

- 2 Open the housing.

Note: The closure bolts will remain attached to the housing.

Upgrading Existing Housing Seizures

The GainMaker Line Extender modules have a higher current-carrying capacity than some earlier Line Extender products. If you are replacing an earlier Line Extender (LE II, or LE III) with a GainMaker Line Extender, you will need to upgrade the housing base to handle the higher current demands.

The 15 A housings have silver-plated 0.063 in. diameter pins in the seizures. The plastic material in the seizures and anvils are glass-filled in order to handle the higher AC currents, as well as higher temperatures.

The 15 A line extender modules have a newly designed RF connector that accepts 0.063 in. diameter pins rated for higher-current applications.

Note: The RF connectors, seizures, and anvils are coded blue for ease of identification.

To Install the New Housing Seizures

Complete the following steps to upgrade a line extender housing to 15 A current capacity.

Important: The power shunts must be removed before installing the unit into a powered housing. With shunts removed, it reduces the power surge to the components and F-connectors.



CAUTION:

RF connectors and housing seizure assemblies can be damaged if AC shunt power directors are not removed from the amplifier before installing or removing the amplifier module from the housing.

- 1 If an amplifier module is installed in the housing, you must remove it before continuing. Refer to *Removing the Amplifier Module from the Housing* (on page 36).
- 2 Using a seizure wrench, part number 143190, remove the seizures from the housing. See the diagram below.

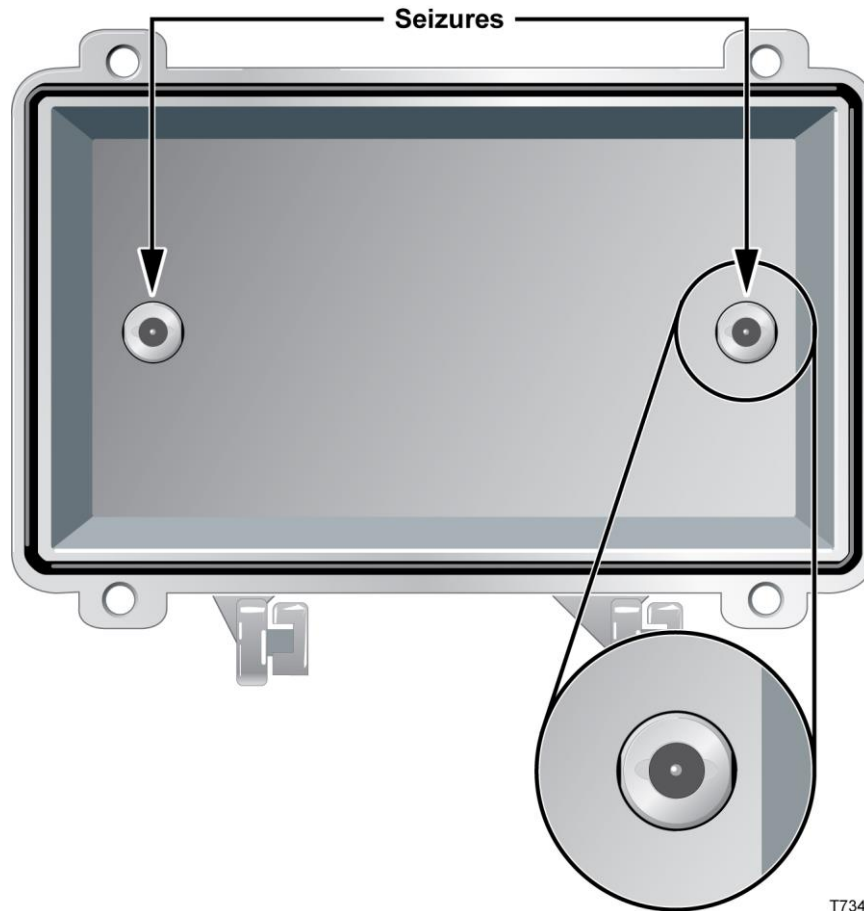

T7345

- 3 Using a ½ in. nut driver, install the new seizure screws from the upgrade kit in the housing.
- 4 Do one of the following as appropriate:
 - If the coaxial cable is connected to the housing, tighten each seizure screw from 2 ft-lb to 5 ft-lb (2.7 Nm to 6.8 Nm).
 - If the coaxial cable is not connected to the housing, proceed to *To Connect the Coaxial Cable Pin Connector to the Node Housing* (on page 24).
- 5 Place the blue stickers on the outside of the housing between the ports to indicate that the upgrade has been completed.

Upgrading an Existing Housing Lid

The GainMaker Line Extender has a new style housing lid that allows easier access to the line extender power supply. If you are replacing an earlier line extender (LE II or LE III) with a GainMaker Line Extender, you will have to replace the existing housing lid with a newer housing lid to accommodate the power supply for the line extender.

To Install the New Housing Lid

Complete the following steps to upgrade a line extender housing with the newest housing lid.



CAUTION:

RF connectors and housing seizure assemblies can be damaged if AC shunt power directors are not removed from the amplifier before installing or removing the amplifier module from the housing.



WARNING:

Before starting this procedure in an aerial or strand mounted application, be sure to clear the area below the housing of all people, and if possible, property.



CAUTION:

In an aerial or strand mounted application, you will need to take steps to ensure that the housing lid does not fall to the ground. See the following recommended procedure.

- 1 Use a torque wrench to loosen the housing closure bolts on the housing lid.

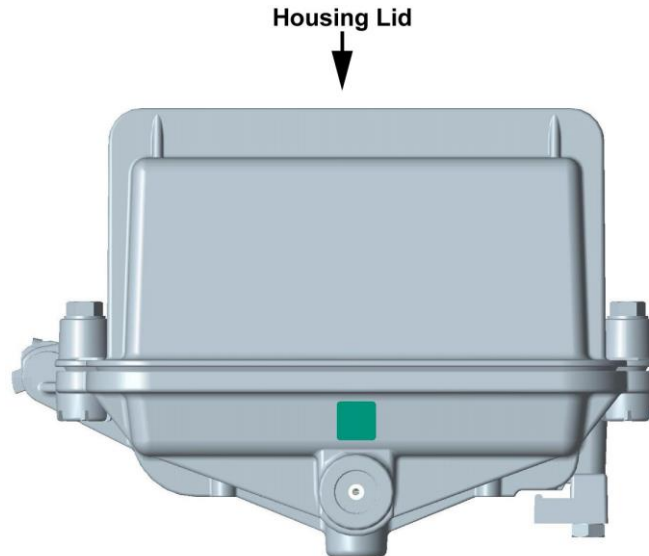

- 2 Firmly grasp the housing lid and open it carefully.
- 3 Using a screwdriver, remove the hinge screw from the housing hinge. The housing lid will now swivel completely open, allowing it to be removed from the housing base.

Important: Place the old housing lid in a safe place until it can be disposed of properly.



WARNING:

It is possible for the housing lid to separate from the housing base and fall, possibly causing injury or damage to persons or property below.

Hinge Screw

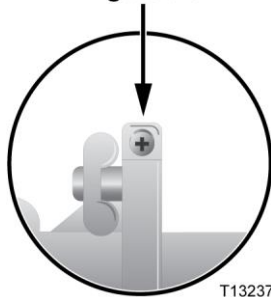

- 4 Firmly grasp the new GainMaker housing lid and place it onto the housing bottom, swiveling it into place on the housing hinge.



WARNING:

It is possible for the housing lid to separate from the housing base and fall, possibly causing injury or damage to persons or property below.

- 5 Using a screwdriver, replace the hinge screw in the housing hinge. Tighten the hinge screw from 5 in-lb to 8 in-lb (0.56 Nm to 0.90 Nm).

Installing the Power Supply

Important: The AC shunt power directors must be removed before installing the unit. Removal of the AC shunt power directors reduces the power surge to the components and F-connectors.



CAUTION:

RF connectors and housing seizure assemblies can be damaged if AC shunt power directors are not removed from the amplifier before installing or removing the amplifier module from the housing.

To Install the Power Supply Module

Complete the following steps to install the power supply module.

- 1 Start with the housing lid open. The power supply is installed in the housing lid.
- 2 Install the power supply module in the power supply cavity.

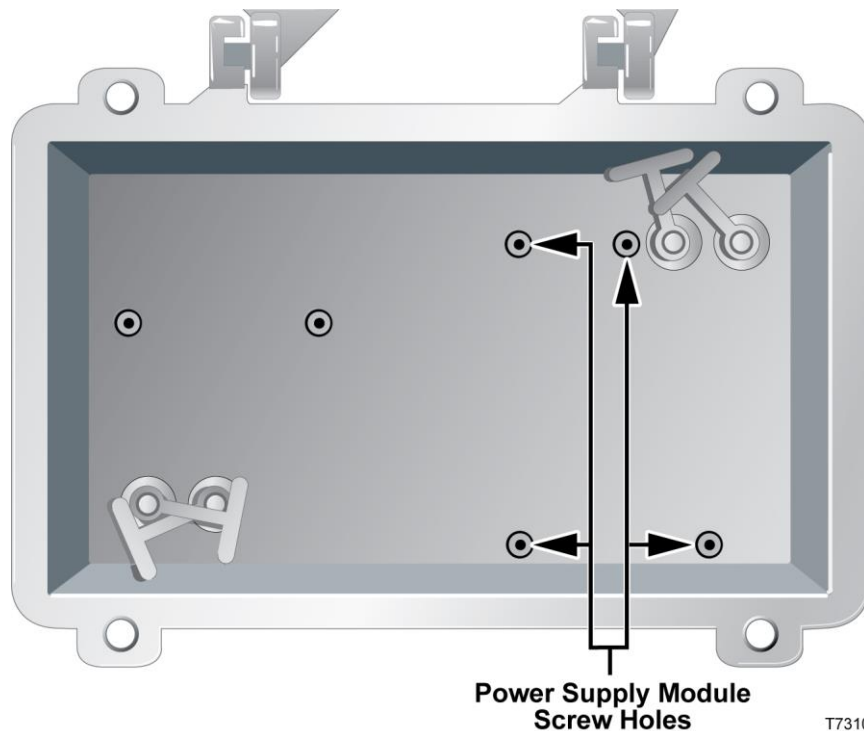

T7310

Note:

- There is only one correct way to install the power supply module. Use the metal tabs as a guide to position the power supply module correctly inside the power supply cavity.
- Be sure that the plastic retaining tabs that secure the test point plugs to the housing lid are not pinched between the power supply and the interior of the

housing lid. This will make it difficult to open the test point plug.

- 3 Tighten the four module screws on the power supply module to 18 in-lb to 20 in-lb (2.0 Nm to 2.3 Nm).

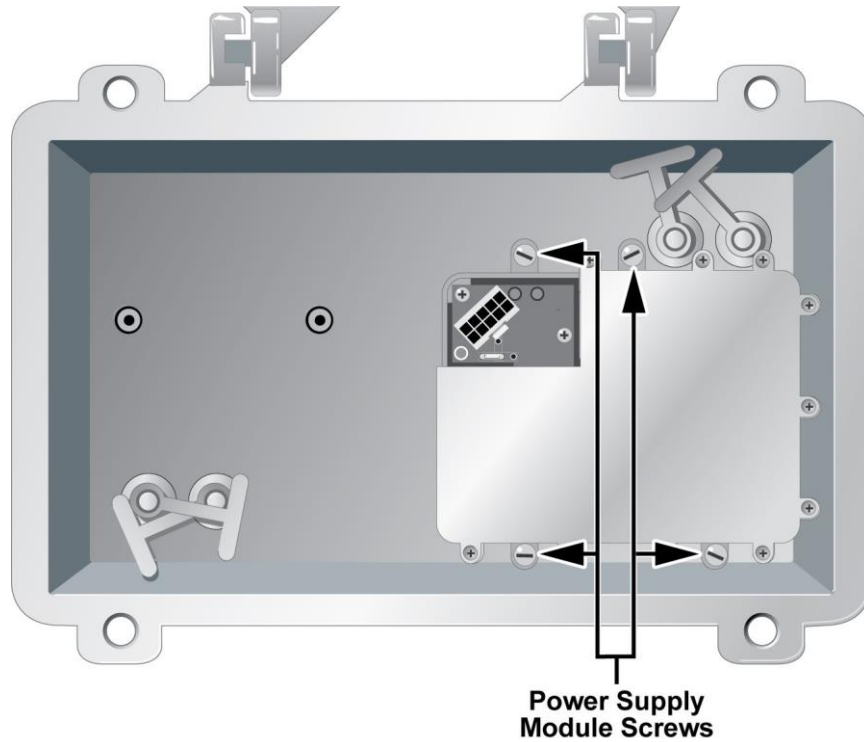

- 4 Attach the 10-pin keyed connector of the power cable and harness to the power supply module.

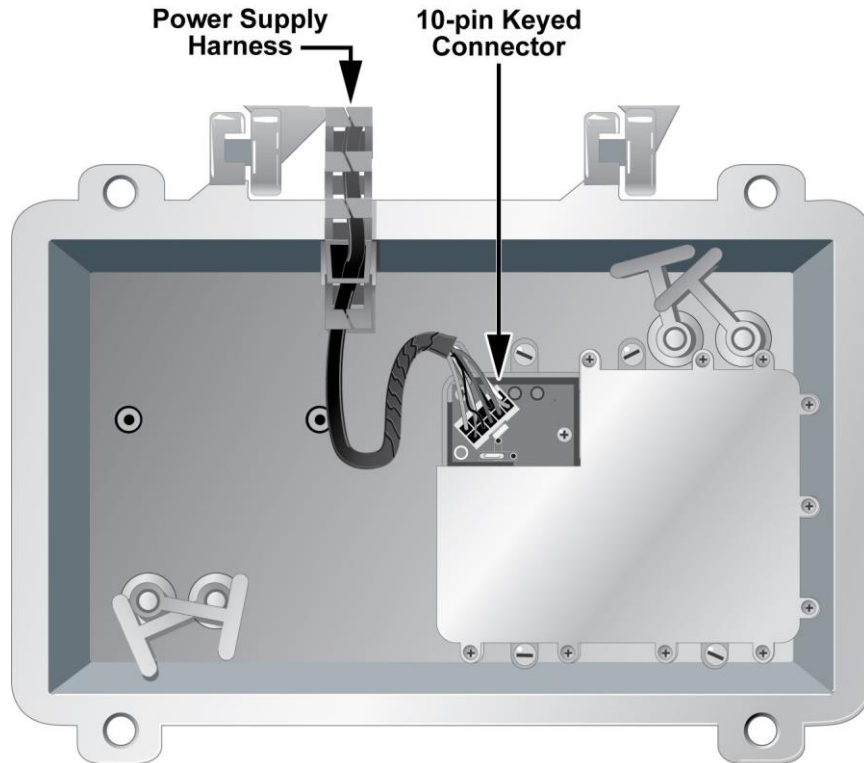

Note: The 10-pin keyed connector can be connected one way only. Be sure that the connector is installed securely to the power supply board.

- 5 Proceed to *Attaching the Coaxial Connectors* (on page 24).

To Set the AC Undervoltage Lockout Selector

Set the AC undervoltage lockout selector for your powering application as specified by your system engineering guidelines.

Undervoltage Lockout Setting	Application
30 V Lockout	60 VAC System
40 V Lockout	90 VAC System
50 V Lockout	90 VAC System

Complete the following steps to set the AC undervoltage lockout selector:

- 1 Locate the AC undervoltage lockout selector on the power supply in the housing lid.

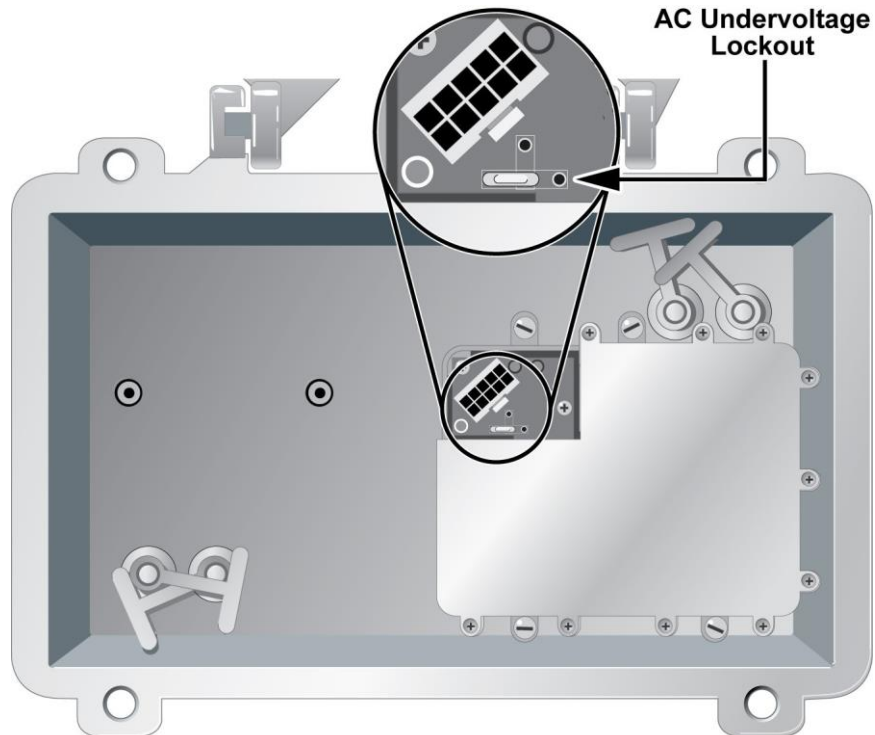

- 2 Set the AC undervoltage lockout selector for your powering application as illustrated in the following diagram.

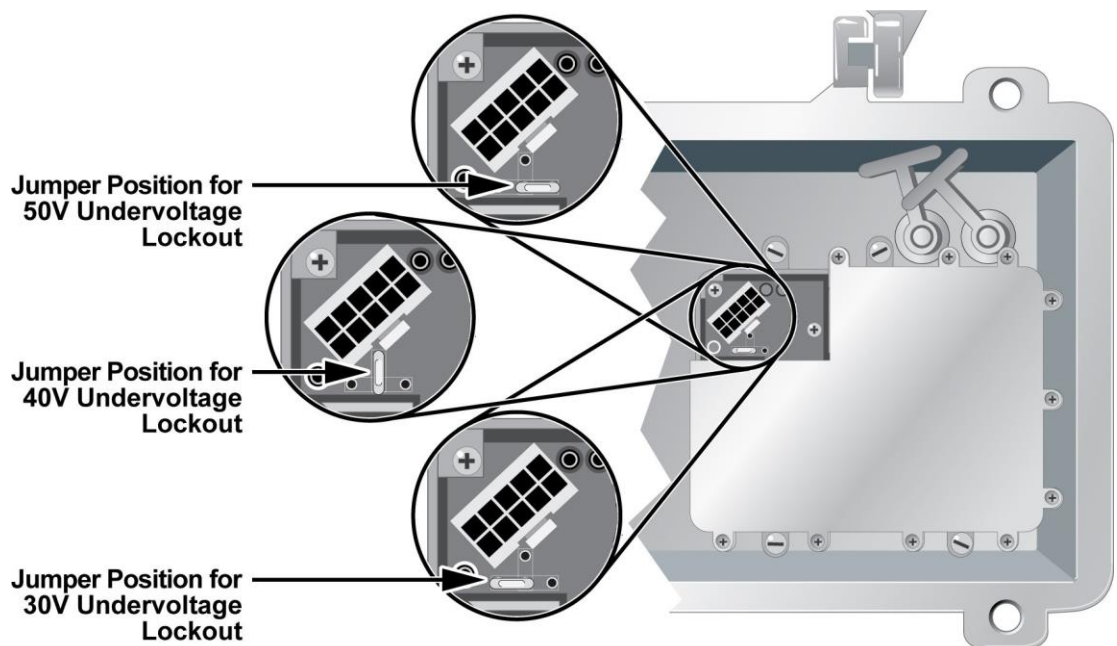

Note: The AC undervoltage lockout selector positions are also noted on the power supply.

- 3 Proceed to *Attaching the Coaxial Connectors* (on page 24).

Attaching the Coaxial Connectors

To Trim the Center Conductor

The 1.2 GHz GainMaker Line Extender requires pin-type connectors for all RF connections.

Before you begin, confirm the following:

- The coaxial cables are cut to the proper length and core-stripped to connector manufacturer specifications.
- The coaxial cable connector center pins are trimmed to 1.25 inches (31.75 mm) from the shoulder of the connector.

To Connect the Coaxial Cable Pin Connector to the Line Extender Housing

Complete the following steps to connect the coaxial cable pin connector to the 1.2 GHz GainMaker Line Extender housing:

- 1 Begin this procedure with the line extender housing open. Refer to *To Open the Line Extender Housing* (on page 15).
- 2 If the coaxial cable connector center pin extends more than the length specified in *To Trim the Center Conductor* (on page 24), trim the pin with heavy-duty wire cutters.
- 3 Insert the appropriate coaxial connector into the housing at the desired housing port. Tighten the connector nut according to manufacturer specifications.
- 4 Tighten the seizure screw from 2 ft-lb to 5 ft-lb (2.7 Nm to 6.8 Nm).
- 5 Repeat steps 2 through 4 for the other RF port.
- 6 Proceed to *Installing the Housing* (on page 25).

Installing the Housing

The following procedures detail how to install the 1.2 GHz GainMaker Line Extender housing on a strand (aerial) or in a pedestal.

To Install the Housing on a Strand (Aerial)

Complete the following steps to install the housing on a strand (aerial). The housing does not need to be opened for strand installation.

Important: The minimum strand diameter should be 5/16 inch.



CAUTION:

Be aware of the size and weight of the housing while strand mounting. Ensure that the strand can safely support the weight of the housing.

- 1 Loosen the strand clamp bolts.
- 2 Lift the housing into proper position on the strand.
- 3 Slip the strand clamps over the strand and finger-tighten the clamp bolts. This allows additional movement of the housing as needed.
- 4 Move the housing as needed to install the coaxial cable and connectors. See the diagrams below for examples.

Signal Flow from Left to Right

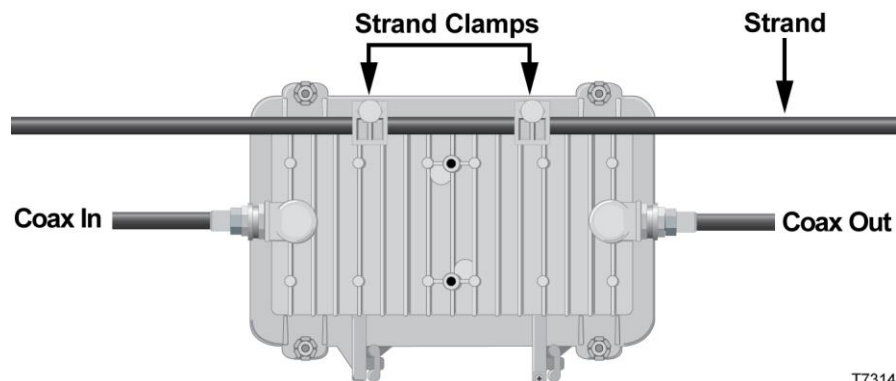

T7314

Signal Flow from Right to Left

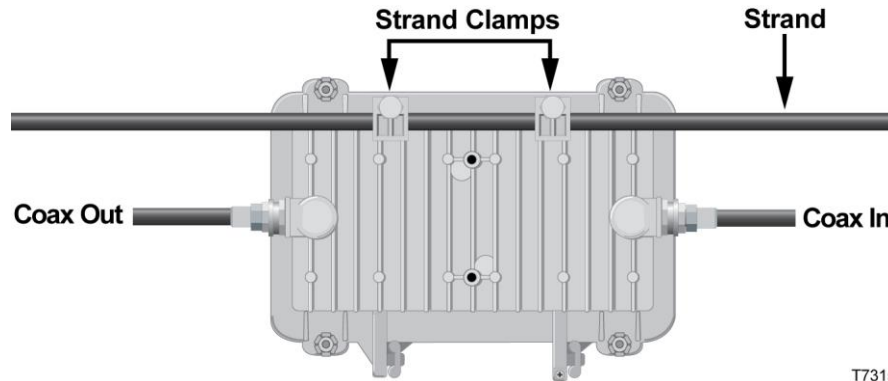

Note: **Coax In** may be switched with the **Coax Out** if you reverse the line extender module and feed the signal from right to left.

- 5 Using a 1/2-inch torque wrench, tighten the strand clamp bolts from 5 ft-lb to 8 ft-lb (6.8 Nm to 10.8 Nm). Make sure there is good mechanical contact between the strand and the housing.

Note: A slight tilt of the face of the housing is normal. Cable tension will cause the housing to hang more closely to vertical.

- 6 Connect the coaxial cable to the pin connector according to connector manufacturer specifications.
- 7 Proceed to *Installing Accessories* (on page 28).

To Install the Housing in a Pedestal

Complete the following steps to install the line extender in a pedestal.

- 1 Remove the cover of the pedestal.
- 2 Remove the self-tapping bolts from the strand clamps and set the bolts and strand clamps aside.
- 3 Position the housing in the pedestal frame as shown in the following illustration. Line up the self-tapping bolt holes on the bottom of the housing with the mounting holes on the bracket.

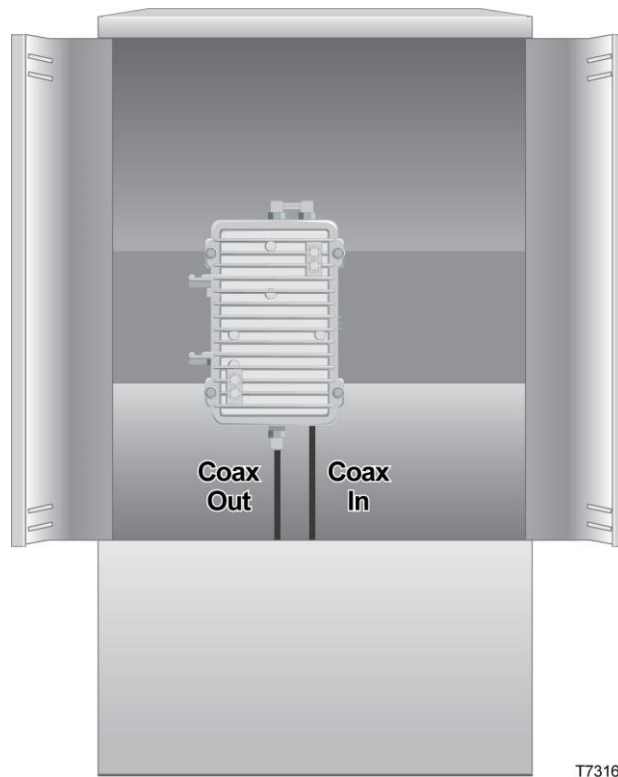

Note: The housing mounts to the bracket provided by the pedestal manufacturer.

- 4 Secure the housing to the bracket by using the bolts that you removed in step 2. Use the strand clamps as spacers if necessary. Torque the bolts from 8 ft-lb to 10 ft-lb (10.8 Nm to 13.6 Nm).
- 5 Connect the coaxial cable to the pin connector according to connector manufacturer specifications.
- 6 Proceed to *Installing Accessories* (on page 28).

Installing Accessories

The following section provides instructions for installing accessories into the 1.2 GHz GainMaker Line Extender.

To Install Attenuator Pads

Complete the following steps to install the attenuator pads in the line extender.

Note: For best results, follow this installation procedure exactly.

- 1 Begin this procedure with the housing open. Refer to *To Open the Line Extender Housing* (on page 15).

Note: These accessories can be installed without removing the cover.

- 2 Install the pad(s) specified by the design print in the appropriate pad slot(s). For a list of available accessory pad values and part numbers, see datasheet.

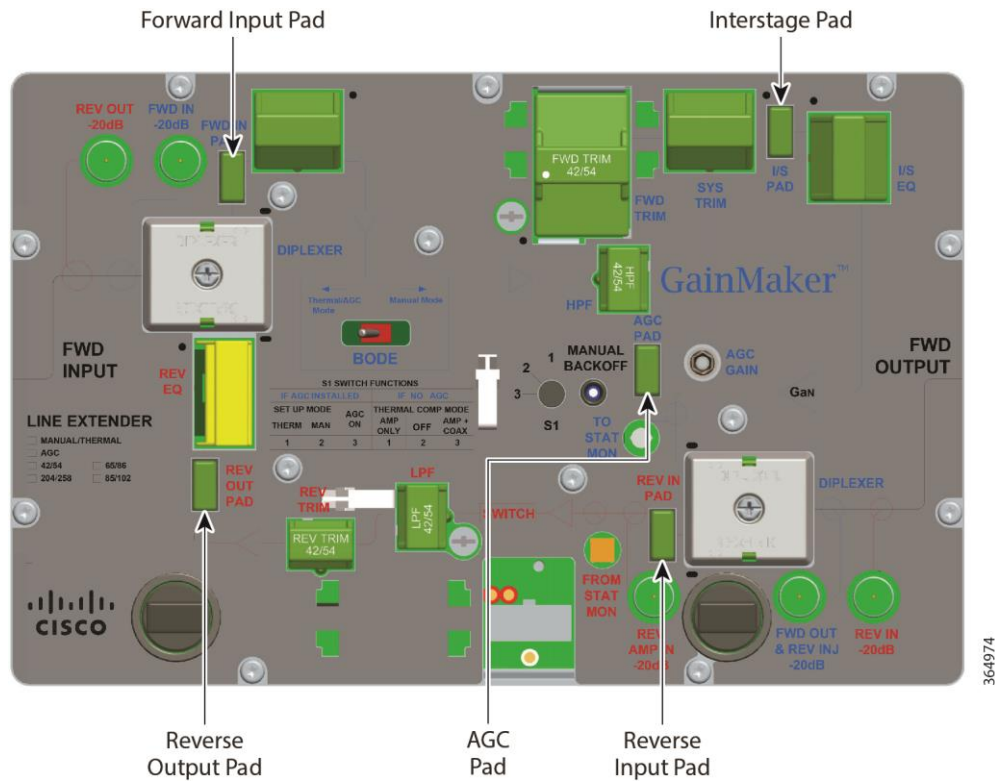

Notes:

- Be sure that all the pins on the attenuator pad bottom align with the pin holes in the attenuator pad slot, allowing the attenuator pad to install flat against the line extender module.
- The locations for attenuator pads are approximately the same for all

GainMaker Line Extender. The illustration above shows a typical example.

- The interstage pad is installed at the factory to set the operational gain of the station. Do not change this pad in the field unless required by system design.
- 3 Install other options or accessories as desired, or proceed to *Installing the Line Extender Module* (on page 33).

To Install Equalizers

Complete the following steps to install the equalizers in the line extender.

Note: For best results, follow this installation procedure exactly.

- 1 Begin this procedure with the housing open. Refer to *To Open the Line Extender Housing* (on page 15).

Note: These accessories can be installed without removing the line extender module cover.

- 2 Install the forward input equalizer specified by the design print in the forward input equalizer slot. Or, install the correct inverse equalizer specified by the design print for your system in the forward input equalizer slot. For a list of available accessory pad values and part numbers, see datasheet.

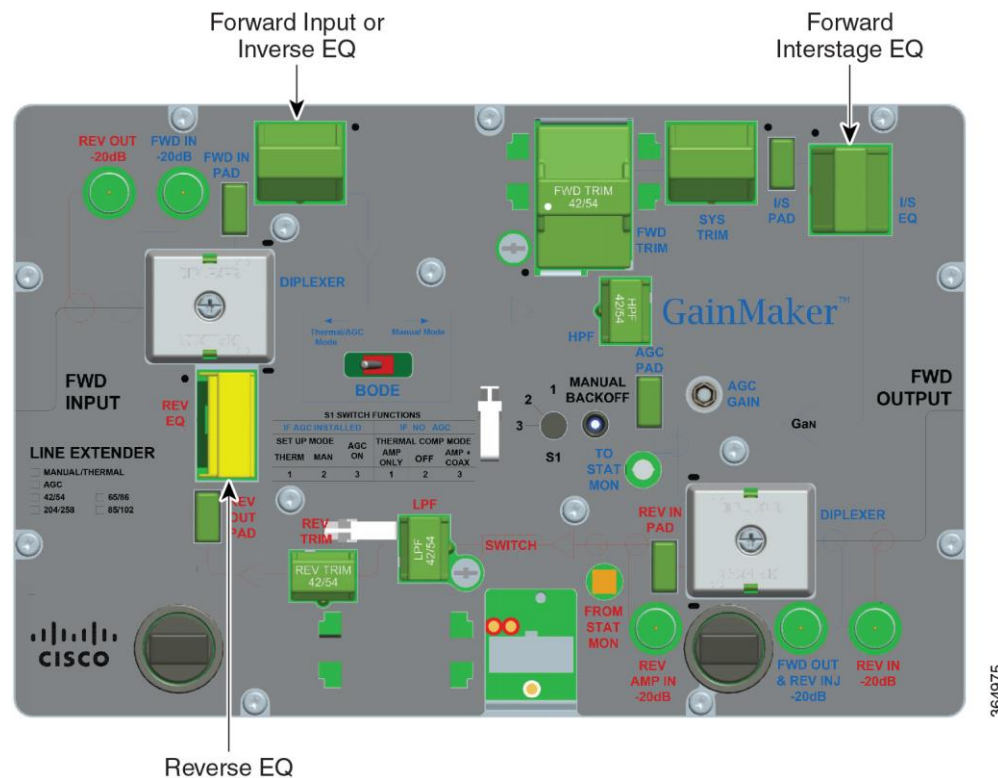

Note:

- Be sure that all the pins on the forward input equalizer or inverse equalizer

bottom align with the pin holes in the equalizer slot, allowing the equalizer to install flat against the line extender module.

- The same inverse equalizer is used for either 870 MHz, 1 GHz and 1.2GHz.
 - The locations for equalizers are approximately the same for all GainMaker Line Extender. The illustration above shows a typical example.
 - The forward interstage equalizer is installed at the factory, and should not be changed in the field. While it is a 1.2 GHz equalizer, it is appropriate for use in both 1.2 GHz, 1GHz and 870 MHz system applications.
 - The plug-in interstage equalizer and an on-board interstage equalizer combine to produce the total internal tilt for the station. The plug-in interstage equalizer value is different from one type of line extender to another by design, in order to achieve optimum performance.
- 3 Install the reverse equalizer specified by the design print in the reverse equalizer slot. For the exact location of the reverse equalizer, refer to the accompanying illustration. For a list of available reverse equalizers, see datasheet.
 - 4 Install other options or accessories as desired, or proceed to *Installing the Line Extender Module* (on page 33).

To Install the Crowbar Surge Protector

Complete the following steps to install the crowbar surge protector in the line extender.

- 1 Begin this procedure with the housing open. Refer to *To Open the Line Extender Housing* (on page 15).
- 2 Remove the line extender cover by loosening the line extender cover screws.

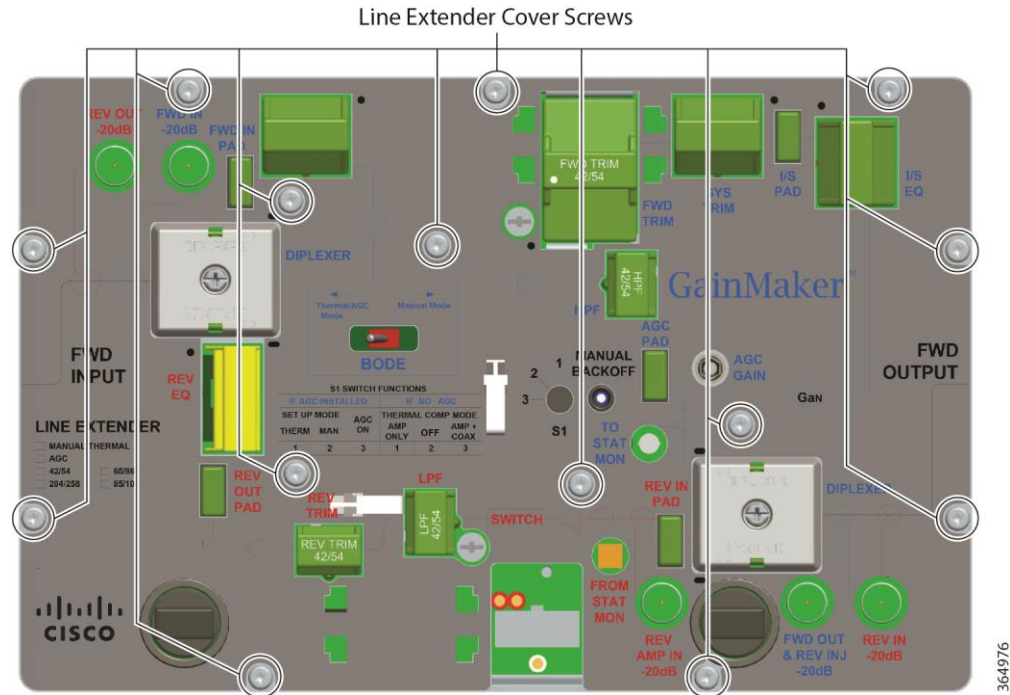

- 3 Install the crowbar surge protector in the surge protector slot. Refer to the illustration below.

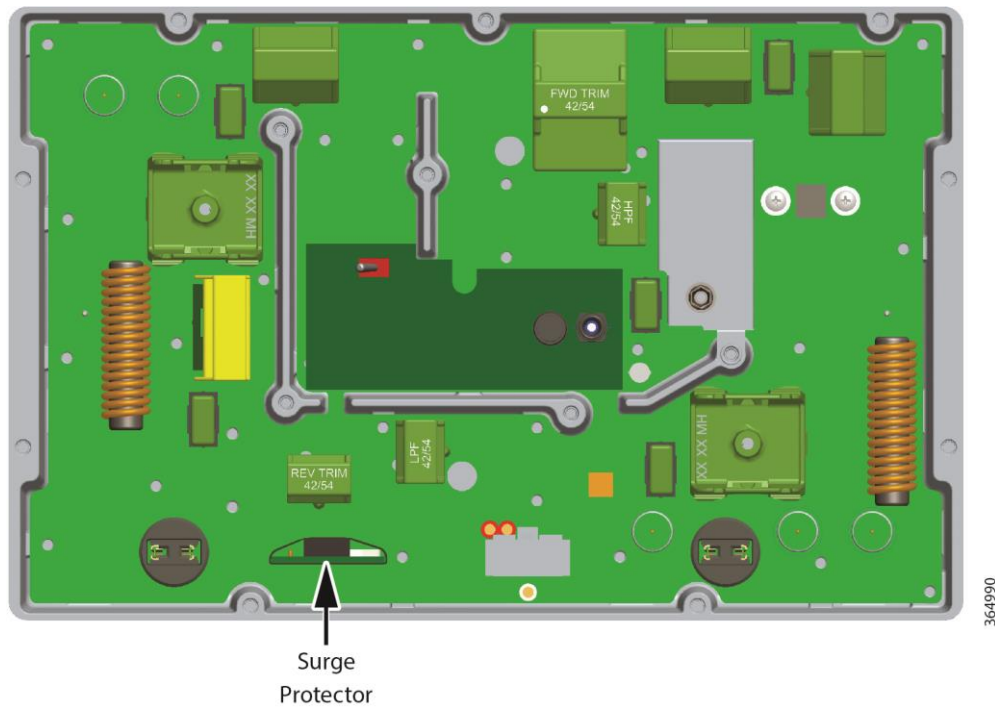

Note:

- Make sure that all pins on the crowbar surge protector bottom align with the pin holes in the surge protector slot, allowing the surge protector to install flat against the line extender module.

- Make sure that the components face the outside of the station (see diagram for proper positioning). Heat shrink tubing has been added to prevent shorting.
- 4 Replace the line extender cover and tighten the line extender cover screws from 10 in-lb to 12 in-lb (1.12 Nm to 1.35 Nm).
Important: Install the line extender module cover properly, or RF signal degradation may result.
 - 5 Install other options or accessories as desired, or proceed to *Installing the Line Extender Module* (on page 33).

Installing the Line Extender Module

The line extender module plugs into the strand-mounted or pedestal-mounted (bottom) of the housing via RF connectors on the bottom side of the module.

Line extender housings and line extender modules are designed so that you can orient the module conveniently for maintenance. Because the input and main output ports are located diagonally across from each other, the line extender module is reversible. This allows you to orient all line extender housings to open either to the road side or to the field side. The line extender is then installed in the appropriate position, either right side up or upside down.

To Install the Line Extender Module

Complete the following steps to install the line extender module.

- 1 Perform the following if you are working with a line extender where AC is present.



CAUTION:

RF connectors and housing seizure assemblies can be damaged if AC shunt power directors are not removed from the line extender before installing or removing the line extender module from the housing.

- Install the AC shunt power directors in the line extender after you install the line extender module in the housing.
 - Remove the AC shunt power directors from the line extender before you remove the line extender module from the housing.
- 2 Orient the line extender module so the **Input** and **Main** output ports (the locations of which are stamped on the module cover) are in the proper corners for your installation.
 - 3 Line up the RF connectors on the line extender module and the housing, and then push the line extender module into the housing.
 - 4 Secure the line extender module to the housing by tightening the four line extender module retainer screws. Tighten slotted head screws to 6 in-lb to 9 in-lb (0.7 Nm to 1.0 Nm), or cross head screws to 18 in-lb to 20 in-lb (2.0 Nm to 2.25 Nm). See the following illustration for the location of the retainer screws.

- Depending on the orientation of the line extender module in the housing, your power harness routing should resemble either the previous or the next illustration. Use the routing method best suited for your installation.
- Be sure that the power harness locking tabs are fully seated under the line extender cover.

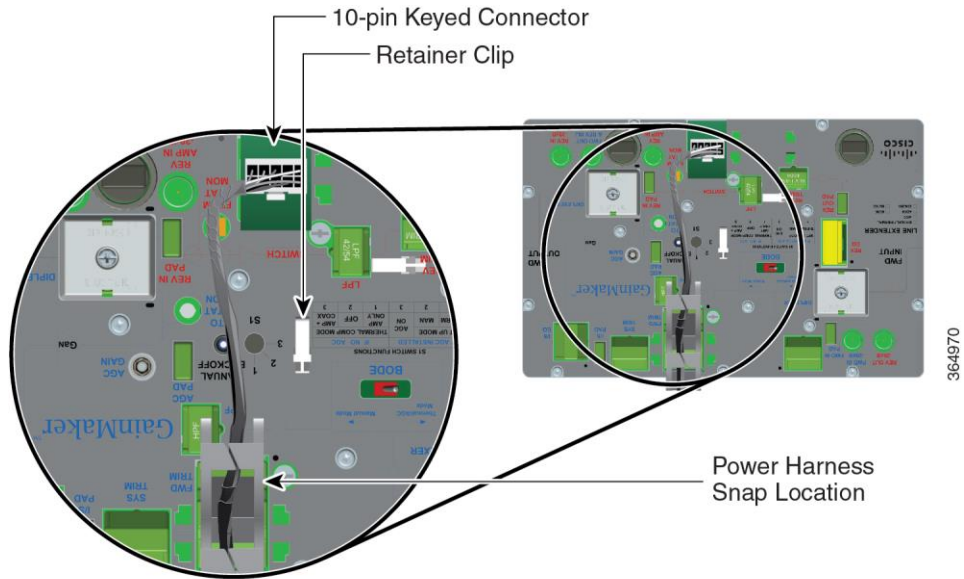

8 Proceed to *Removing and Installing AC Shunt Power Directors* (on page 38).

Removing the Line Extender Module from the Housing

To Remove the Line Extender Module

Complete the following steps to remove the line extender module.

- 1 Open the housing. Refer to *To Open the Line extender Housing* (on page 15).
- 2 If you are working with an line extender in which AC is present, remove the AC shunt power directors from the line extender before removing the line extender module from the housing.



CAUTION:

RF connectors and housing seizure assemblies can be damaged if AC shunt power directors are not removed from the line extender before installing or removing the line extender module from the housing.

- 3 Unplug the 10-pin keyed connector of the power cable harness from the line extender module.

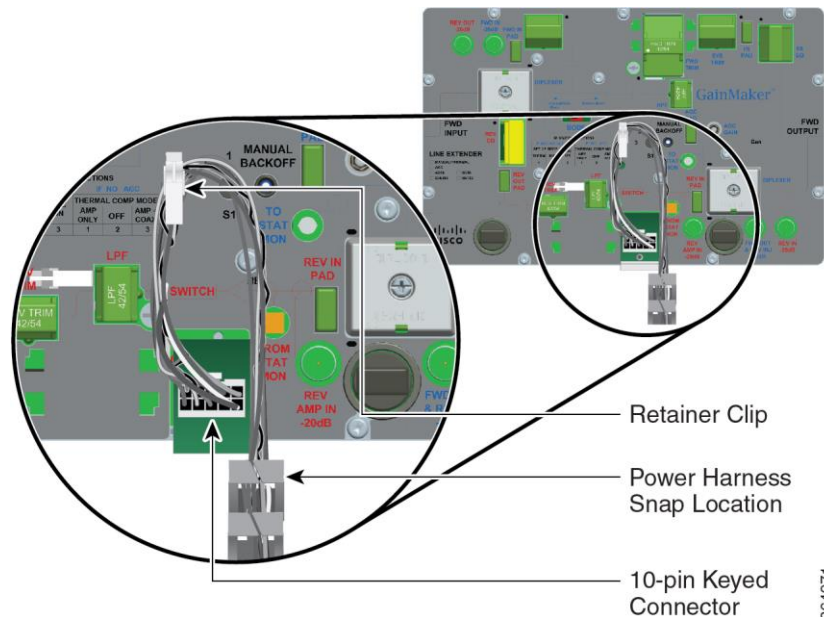

- 4 Remove the power cable harness from the white plastic retainer clips.
- 5 Unsnap the cable guide from the holes in the line extender module cover.
Note: The cable can remain plugged into the power supply module.
- 6 Using a flat-blade screwdriver, loosen the two module retainer screws.

Removing the Line Extender Module from the Housing

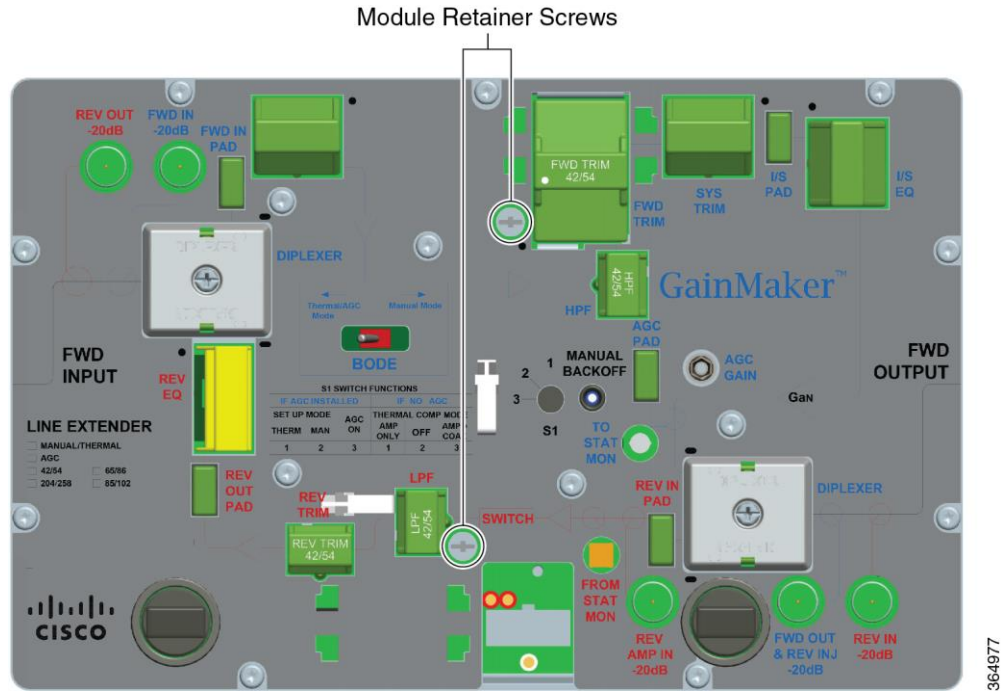

- 7 Remove the line extender module from its housing and place the line extender module on a secure surface.



WARNING:

Avoid personal injury and damage to the line extender module. Make sure that you place the line extender module on a secure surface.

Removing and Installing AC Shunt Power Directors

The line extenders draw AC power from the coaxial cable. This AC power comes from an external AC power supply.



WARNING:

When AC is applied from RF ports to units downstream, the downstream equipment shall also be located in a restricted access location (access restricted to service personnel).

Power can come from the input or output ports, and each line extender can pass or block AC power flow on any port without affecting RF continuity. However, at least one port must pass AC power to bring power into the line extender.

To set the power direction, install AC shunt power directors for the ports through which you wish to pass AC.

Note: A red AC shunt power director is included with the unit. The red shunt is used to activate the port that supplies power. The red shunt should be removed before installing or removing the line extender module from the housing.



CAUTION:

RF connectors and housing seizure assemblies can be damaged if AC shunt power directors are not removed from the line extender before installing or removing the line extender module from the housing.

To Remove and Install AC Shunt Power Directors

Complete the following steps to remove and install AC shunt power directors.

- 1 Open the housing. Refer to *To Open the Line Extender Housing* (on page 15).
- 2 To remove a power director, pull it straight out from the line extender module.

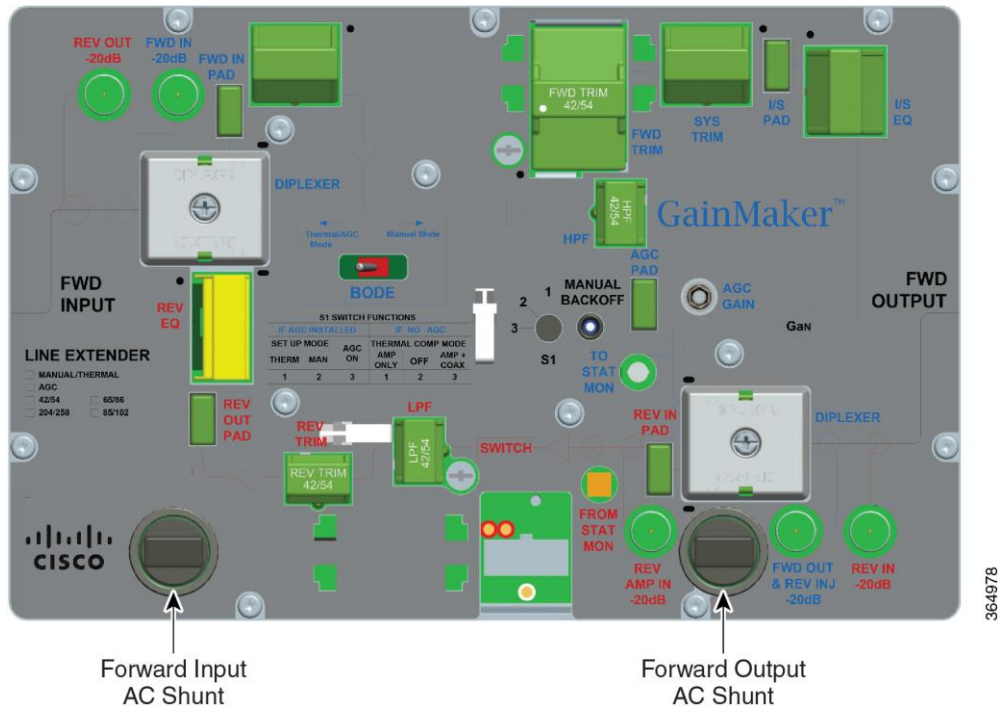

- 3 To install a power director, refer to the systems design print to determine AC power routing and install the AC shunt power directors in the required locations.
- 4 Close the housing. Refer to *To Close the Line Extender Housing* (on page 40).

Closing the Line Extender Housing

To Close the Line Extender Housing

Complete the following steps to close the line extender housing.



CAUTION:

Avoid moisture damage and RF leakage! Follow the procedure exactly as shown below to ensure a proper seal.

- 1 Inspect the housing gasket and all mating surfaces. Wipe off any excess dirt and debris.
- 2 Close the housing and finger-tighten all closure bolts.
- 3 Use a torque wrench with a ½-inch socket to tighten each closure bolt from 5 ft-lb to 12 ft-lb (6.8 Nm to 16.3 Nm) each.
- 4 The tightening sequence is shown in the following **Torquing Sequence** section. Follow the numbered sequence to tighten the closure bolts.

Torquing Sequence

The following diagram shows the proper torquing sequence for the housing closure bolts.

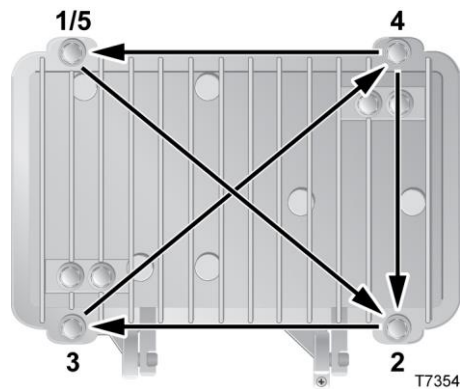

3

Balancing and Setup

Introduction

This chapter provides instructions for selecting and implementing the correct balancing methods for the 1.2 GHz GainMaker Line Extender in your cable system. Balancing sets the operating levels of the station to ensure proper performance.

Important: Use the information in this chapter to identify the equipment needed for balancing and to determine the correct forward path balancing method for your system installation.

In This Chapter

- Preparing for Forward Path Balancing 42
- Balancing the Forward Path 47
- Balancing the Reverse Path 77

Preparing for Forward Path Balancing

Before you begin balancing, it is important to review and understand the following information. This information will show you which balancing process is appropriate for your line extender.

Before balancing, make sure that you have configured the line extender according to the specifications in your design print and that the line extender has warmed up for approximately one hour.

The table below shows the items needed for balancing.

You need a ...	To ...
copy of the design print	determine expected input and output signal levels.
torque wrench with 1/2-inch socket	open and close the line extender housing.
spectrum analyzer or signal analysis meter capable of working with frequencies up to the highest design frequency	determine absolute and relative signal levels.
test point adapter or F-81 female-to-female adapter	access the test points.
length of 75 ohm coaxial cable with F-connectors on each end	connect the test point adapter to the test equipment.
voltmeter	test the power supply AC and DC voltages.
reverse sweep receiver	test signals using a reverse sweep transmitter.
1/8-inch flat blade screwdriver	adjust switch S1, AGC Manual Backoff, and AGC Gain Control

Understanding BODE Switch Function

The BODE Switch is used to set the interstage control of the Line Extender. This switch can be set for either Thermal control or Manual control of the Line Extender. The BODE is always present in the Line Extender and can be engaged for either Thermal or AGC operation of the product. The BODE circuit is by-passed when this switch is in the Manual Mode.

Understanding Switch S1 Functions

Switch S1 is a multifunction, three-position switch. Switch S1 functions are

determined by whether or not an AGC is installed in the station.

- When an AGC is installed in the station, it is an AGC station. In an AGC station, switch S1 provides two setup modes and one operational mode.
- When there is no AGC installed in the station, it is a thermal station. In a thermal station, switch S1 provides two operational modes.

Switch S1 Positions for AGC Stations

The mode you decide to use to balance an AGC station determines the position in which you place switch S1.

- Position 1 - Selects thermal setup mode
- Position 2 - Selects manual setup mode
- Position 3 - Selects AGC operational mode

Note: AGC operational mode is used only after the station has been initially balanced in either thermal or manual setup mode.

Bode Network

The Bode Network, or Bode, is an interstage variable attenuation and slope network whose loss characteristics are driven by DC control voltage.

The position of switch S1 sets the DC control voltage driving the Bode according to the setup mode or operational mode required for the station.

Refer to the following table for more information on choosing the correct switch position for your application.

Note: Consult your system technical supervisor or manager for more information about which choice of setup mode to use, as this may be dictated by your system or corporate engineering policy.

Switch S1 Position Information for AGC Stations

Position 1 Thermal Setup Mode	Position 2 Manual Setup Mode	Position 3 AGC Operational Mode
<p>A thermistor (thermal) driven circuit on the line extender sets the DC control voltage that drives the Bode.</p> <p>This circuit detects the line extender's internal temperature and generates the proper level of DC control voltage, setting the proper loss characteristics of the Bode with respect to the current outdoor temperature.</p> <p>Note: This is the same as the "Thermal" toggle switch setting on most prior AGCs.</p>	<p>The Manual Backoff potentiometer sets the DC control voltage that drives the Bode.</p> <p>Manually adjusting the Manual Backoff potentiometer sets the proper loss characteristics of the Bode with respect to the current outdoor temperature.</p> <p>Manual adjustment is done by monitoring the line extender RF output level and adjusting the potentiometer to reduce the gain "x" dB from the full gain (minimum loss) of the potentiometer setting.</p> <p>The value of "x" (gain reduction) is dependent upon outside temperature and is determined by consulting the Manual Backoff Chart.</p> <p>Note: This is the same as the "Manual" toggle switch setting on some prior AGCs.</p>	<p>The AGC detector circuit monitors the AGC pilot carrier level at the input to the AGC module. The detected AGC pilot carrier level variations cause a proportional variation of the DC control voltage that drives the Bode.</p> <p>Important: The switch must be left in this position after initial balancing in order for the AGC to function with the Bode properly.</p> <p>The AGC and Bode combination thus cause offsetting gain and slope variations to occur as needed, holding the actual line extender output stable.</p> <p>Note: This is the same as the "Auto" toggle switch setting on all prior AGCs.</p>

Note: AGC operational mode is used only after the station has been initially balanced in either thermal or manual setup mode.

Switch S1 Positions for Manual Stations

The manual version of the 1.2 GHz GainMaker Line Extender does not have a Bode network installed. Therefore, switch S1 has no function in the manual version of the product.

Switch S1 Positions for Thermal Stations

The mode of thermal compensation you select for a thermal station determines the position in which you place switch S1.

- Position 1 - Selects line extender only compensation mode
- Position 2 - Not used
- Position 3 - Selects line extender and coax compensation mode

Bode Network

The Bode Network, or Bode, is an interstage variable attenuation and slope network

whose loss characteristics are driven by DC control voltage.

The position of switch S1 sets the DC control voltage driving the Bode according to the setup mode or operational mode required for the station.

Refer to the following table for more information on choosing the correct switch position for your application.

Note: Consult your system technical supervisor or manager for more information about which choice of setup mode to use as this may be dictated by your system or corporate engineering policy.

Switch S1 Position Information for Thermal Configured Stations

Position 1 Line extender Only	Position 2 NOT USED	Position 3 Line Extender and Coax
<p>A thermistor (thermal) driven circuit on the line extender sets the DC control voltage that drives the Bode.</p> <p>This circuit detects the line extender's internal temperature and generates the proper level of DC control voltage, setting the proper loss characteristics of the Bode with respect to the current outdoor temperature.</p> <p>Note: This switch position is meant to compensate for the temperature related level variations of the line extender only. This switch position is normally selected when underground cable precedes the station, since such cable is subject to little temperature variation.</p>	<p>Important! Do not select this position. This position is reserved for stations with an AGC installed.</p> <p>While adjustments to the Manual Backoff potentiometer will affect line extender gain with S1 in this position, once S1 is set to position 1 or 3, the manual potentiometer setting will not affect proper thermal line extender operation.</p> <p>Leaving the switch in this position disables the thermistor (thermal) driven circuit and enables the backoff potentiometer on the line extender. This sets the DC control voltage that drives the Bode to a constant setting, regardless of the current outdoor temperature.</p> <p>Note: This is a factory setting used to verify proper station gain with a given amount of manual gain backoff.</p>	<p>A thermistor (thermal) driven circuit on the line extender sets the DC control voltage that drives the Bode.</p> <p>This circuit detects the line extender's internal temperature and generates the proper level of DC control voltage, setting the proper loss characteristics of the bode with respect to the temperature.</p> <p>Note: This switch position is meant to compensate for the temperature related level variations of both the line extender and the coaxial cable preceding the station.</p> <p>This switch position is normally selected when overhead cable precedes the station, since such cable is subject to temperature variation.</p>

Note: Switch S1 in Position 2, and the backoff potentiometer, are used in AGC stations only.

To Verify the Input Signal Level

Complete the following steps to test the input signal level.

Important: You cannot balance the line extender without the proper input signals.

- 1 Connect the test equipment to the forward input test point shown in the illustration below.

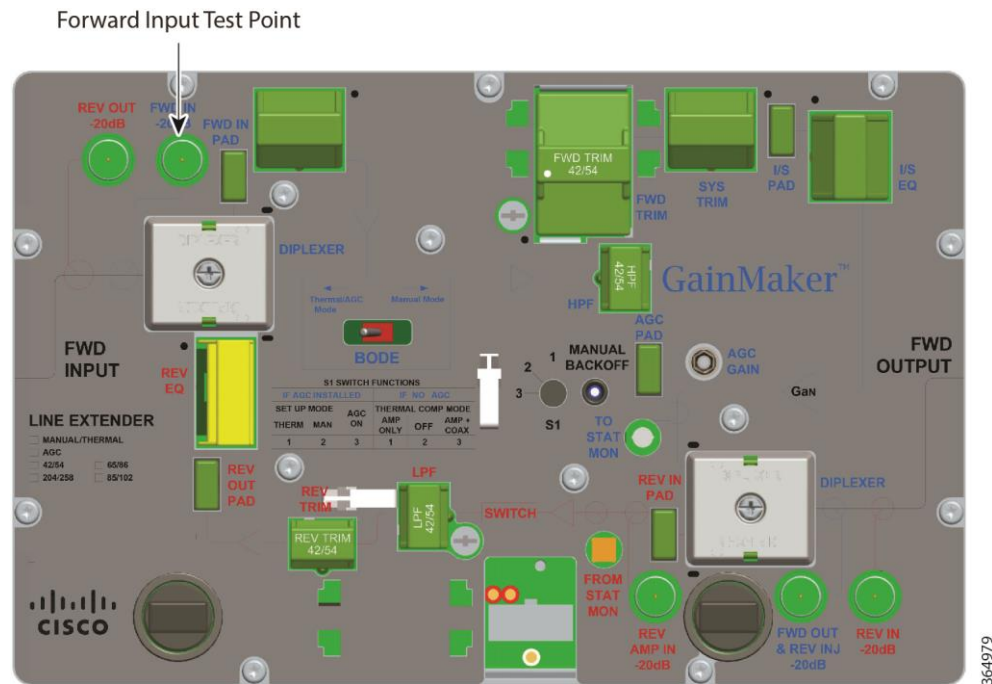

- 2 Measure the signal level at the following frequencies:
 - The lowest frequency specified in the system design
 - The highest frequency specified in the system design
- 3 Compare the measured levels to the design input levels on the system design print.

Note: Add 20 dB to the measured levels to find the true levels. The test point attenuates input signals by 20 dB.
- 4 Are measured levels within the desired limits?
 - If **yes**, proceed to step 5.
 - If **no**, or if no signals are present, find the problem before proceeding. You cannot balance the line extender without the proper input signals.
- 5 Remove the test point adapter from the forward input test point, leaving other equipment connectors intact.

Balancing the Forward Path

Be sure to use the correct procedure for forward path balancing. Refer to *To Select the Forward Path Balancing Procedure* (on page 47) for help in identifying the procedure that best fits your system installation and line extender type.

Before you begin, also make sure that the line extender module is configured according to the specifications in the design print, and that the line extender has warmed up for approximately one hour.

To Set the Bode Switch Mode

You can set the bode mode using the BODE Switch.

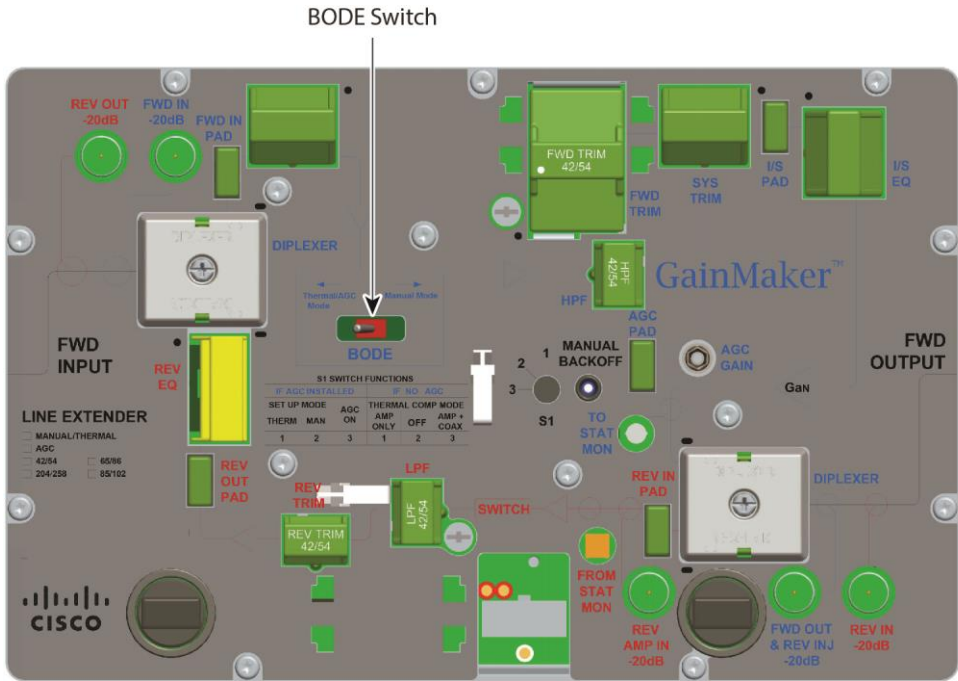

Refer to the following table to direct you to set the proper bode mode.

Bode Mode	Description	Note
Thermal / AGC mode	Bode functions are enabled.	You can use all the forward path balancing procedures except for <i>Forward Path Balancing for Manual Stations</i> (on page 73)

Bode Mode	Description	Note
Manual mode	Bode circuit is by-passed, the bode functions are disabled.	You can only use the forward path balancing procedure in <i>Forward Path Balancing for Manual Stations</i> (on page 73)

To Select the Forward Path Balancing Procedure

Refer to the following table to direct you to the proper starting point to balance your line extender using your preferred method.

If you have ...	and you use ...	go to ...
a line extender configured with AGC	manual mode for balancing	<i>Forward Path Balancing for AGC Stations Using Manual Setup Mode</i> (on page 48)
a line extender configured with AGC	thermal setup mode for balancing	<i>Forward Path Balancing for AGC Stations Using Thermal Setup Mode</i> (on page 58)
a thermal line extender (no AGC)	line extender only compensation mode for balancing	<i>Forward Path Balancing for Thermal Stations Using Line Extender Only Compensation Mode</i> (on page 66)
a thermal line extender (no AGC)	line extender and coax compensation mode for balancing	<i>Forward Path Balancing for Thermal Stations Using Line Extender and Coax Compensation Mode</i> (on page 69)
a manual line extender (no AGC)	N/A	<i>Forward Path Balancing for Manual Stations</i> (on page 73)
an line extender configured with AGC	a trim network for balancing	<i>Forward Path Balancing Using Trim Networks</i> (on page 75)

Forward Path Balancing for AGC Stations Using Manual Setup Mode

Before you begin, make sure that you have configured the line extender module according to the specifications in the design print, and that the line extender has warmed up for approximately one hour.

To Set the Manual Backoff Level

You must adjust the manual backoff level.

Complete the following steps to set the manual backoff level.

- 1 Connect an RF meter or spectrum analyzer to the forward main output test point.
- 2 Set switch S1 to position number 2.

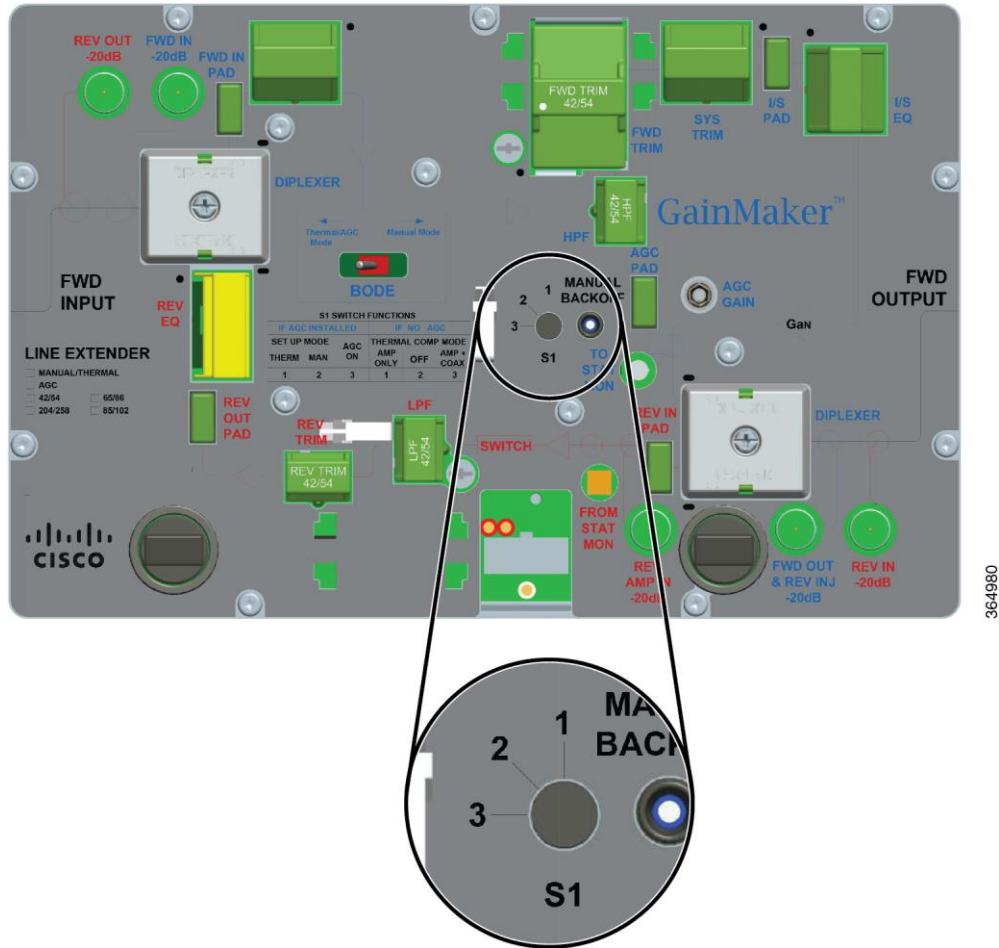

- 3 Turn the MANUAL BACKOFF potentiometer fully counterclockwise for maximum gain.

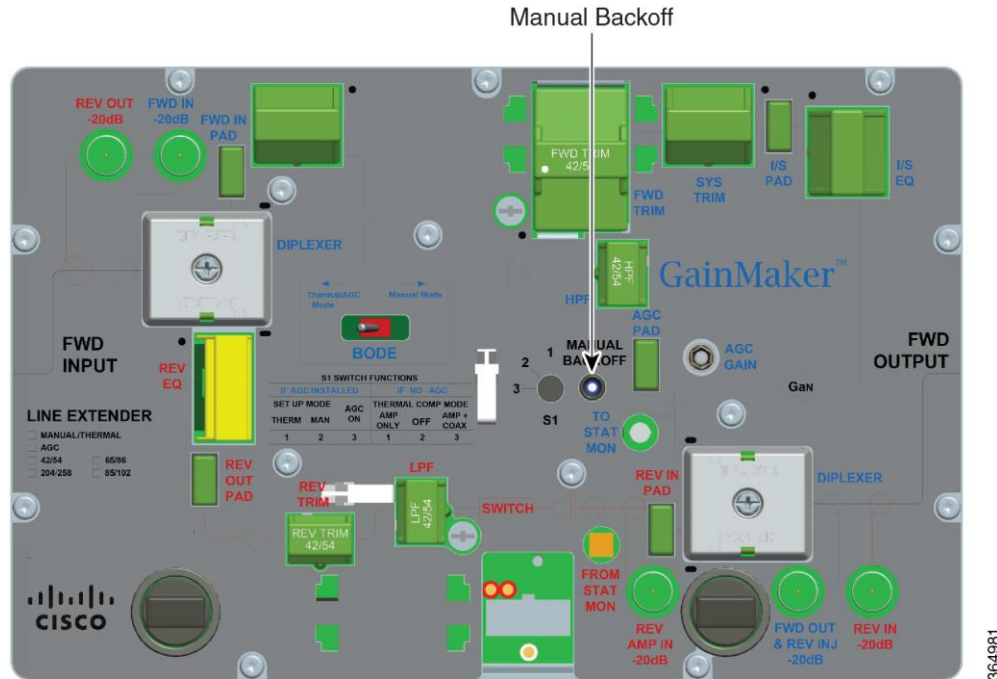

- 4 Determine the outside temperature at the line extender location.
- 5 Refer to the Manual Backoff Chart to find the proper manual backoff level for the current temperature and reference frequency.
- 6 Turn the MANUAL BACKOFF potentiometer clockwise to reduce the output level by the amount specified in the Manual Backoff Chart.
Note: After making this adjustment, do not adjust the MANUAL BACKOFF potentiometer again.
- 7 Proceed to the next section, **To Determine the Output Tilt.**

Manual Backoff Chart

The following table displays the manual backoff level for selected frequencies and various temperatures.

Temperature		445.25 MHz Backoff level (dB)	547.25 MHz Backoff level (dB)	870 MHz Backoff level (dB)	1 GHz Backoff level (dB)	1.2 GHz Backoff level (dB)
60°C	140°F	0.00	0.00	0.00	0.00	0.00
55°C	131°F	0.26	0.26	0.37	0.41	0.43
50°C	122°F	0.55	0.56	0.80	0.85	0.93
45°C	113°F	0.86	0.91	1.27	1.36	1.51
40°C	104°F	1.17	1.25	1.75	1.87	2.08
35°C	95°F	1.49	1.59	2.22	2.38	2.67
30°C	86°F	1.81	1.93	2.69	2.90	3.26

Temperature		445.25 MHz Backoff level (dB)	547.25 MHz Backoff level (dB)	870 MHz Backoff level (dB)	1 GHz Backoff level (dB)	1.2 GHz Backoff level (dB)
25°C	77°F	2.11	2.27	3.15	3.41	3.86
20°C	68°F	2.42	2.61	3.61	3.92	4.46
15°C	59°F	2.70	2.93	4.05	4.41	5.01
10°C	50°F	2.98	3.25	4.48	4.91	5.56
5°C	41°F	3.29	3.60	4.97	5.45	6.18
0°C	32°F	3.60	3.95	5.46	5.99	6.80
-5°C	23°F	3.91	4.29	5.93	6.50	7.43
-10°C	14°F	4.21	4.63	6.40	7.02	8.05
-15°C	5°F	4.52	4.99	6.88	7.56	8.66
-20°C	-4°F	4.83	5.34	7.36	8.10	9.28
-25°C	-13°F	5.14	5.70	7.84	8.64	9.90
-30°C	-22°F	5.46	6.05	8.31	9.18	10.51
-35°C	-31°F	5.77	6.40	8.77	9.69	11.09
-40°C	-40°F	6.08	6.76	9.22	10.20	11.67

To Determine the Output Tilt

Complete the following steps to determine the output tilt of the line extender.

- 1 Connect the test point adapter to the forward main output test point.

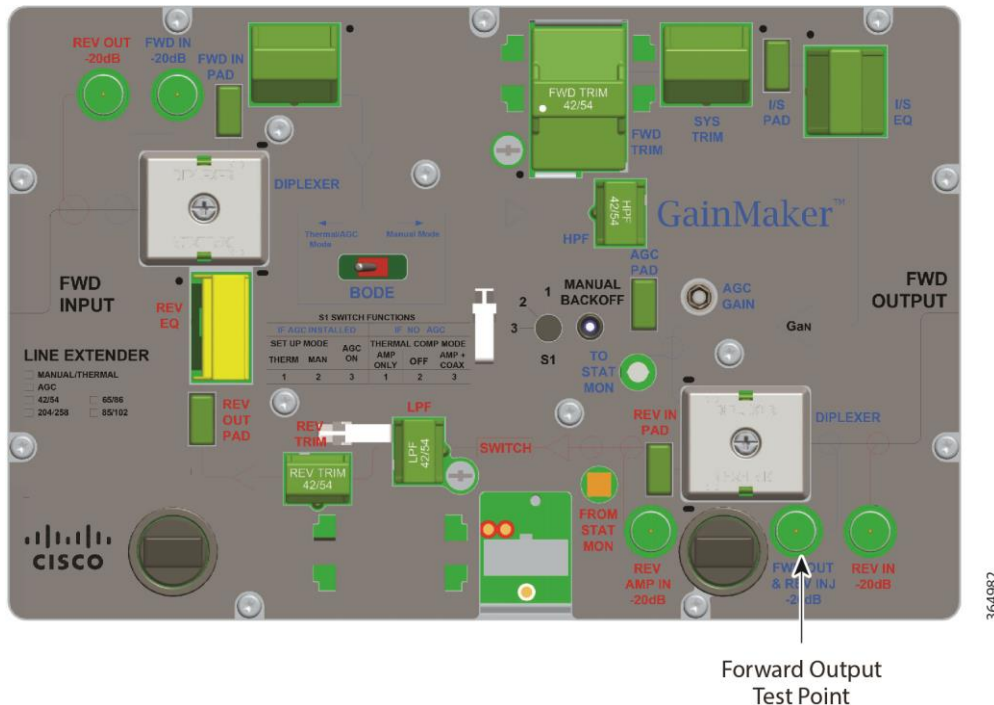

- 2 Consult the design print to find the proper output tilt.
- 3 Measure the output signal levels at the frequencies you used in *To Verify the Input Signal Level* (on page 45).
- 4 To determine the actual output tilt, calculate the difference (in dB) between the levels of the lowest and highest specified frequencies.
- 5 Proceed to the next section, **To Set the Output Tilt**.

To Set the Output Tilt

Equalizers (EQs) are available in 1.5 dB (equivalent) increments. A 1.5 dB change in value changes the difference between low and high frequencies by approximately 1 dB generally, or 1.2 dB for AGC stations in manual setup mode.

- Increasing the equalizer value reduces the level at lower frequencies, relative to the level at 870 MHz/1 GHz/1.2 GHz.
- Decreasing the equalizer value increases the level at lower frequencies, relative to the level at 870 MHz/1 GHz/1.2 GHz.

Complete the following steps to select the proper forward input equalizer value.

- 1 Compare the calculated output tilt in step 4 of **To Determine the Output Tilt**

with the design tilt (on the design print).

- 2 Is the output tilt within ± 0.5 dB of the design tilt?
 - If the output tilt is within ± 0.5 dB of the design tilt, proceed to the next section, **To Set the Output Level**.
 - If the output tilt is more than design tilt, replace the forward input EQ with a lower value.
 - If the output tilt is less than design tilt, replace the forward input EQ with a higher value.
- 3 Measure the output tilt again, and then return to step 1.

To Set the Output Level

After setting the tilt, complete the following steps to select the proper pad values for the line extender. The output level of the line extender is set by selecting the proper pad value.

- 1 Connect the test probe to the forward main output test point.
- 2 Measure the output level at the highest design frequency, and compare this level with the design level (on the design print).
- 3 Is the measured output level within ± 0.5 dB of the design level?
 - If the output level is within ± 0.5 dB of the design output level, proceed to step 5.
 - If the output level is more than the design output level, replace the forward input pad with a higher value pad.
 - If the output level is less than the design level, replace the forward input pad with a lower value pad.
- 4 Repeat steps 2 and 3 until the output level is correct.
- 5 Proceed to the next section, **To Set Up Automatic Gain Control**.

To Set Up Automatic Gain Control

This section provides procedures and tables for configuring and aligning the AGC in the 1.2 GHz GainMaker Line Extender. AGC attenuator values are required to select the proper AGC attenuator value based upon actual AGC pilot carrier output level. See **To Select the AGC Pad Value**.

Note:

- Output levels are measured at the pilot frequency.
- The standard single-pilot AGC makes line extender output adjustments based on the level of the pilot frequency carrier. Activate the pilot carrier with its final unscrambled video source before beginning balance and alignment.

The following diagram shows the location of the AGC related switch, controls, and AGC pad.

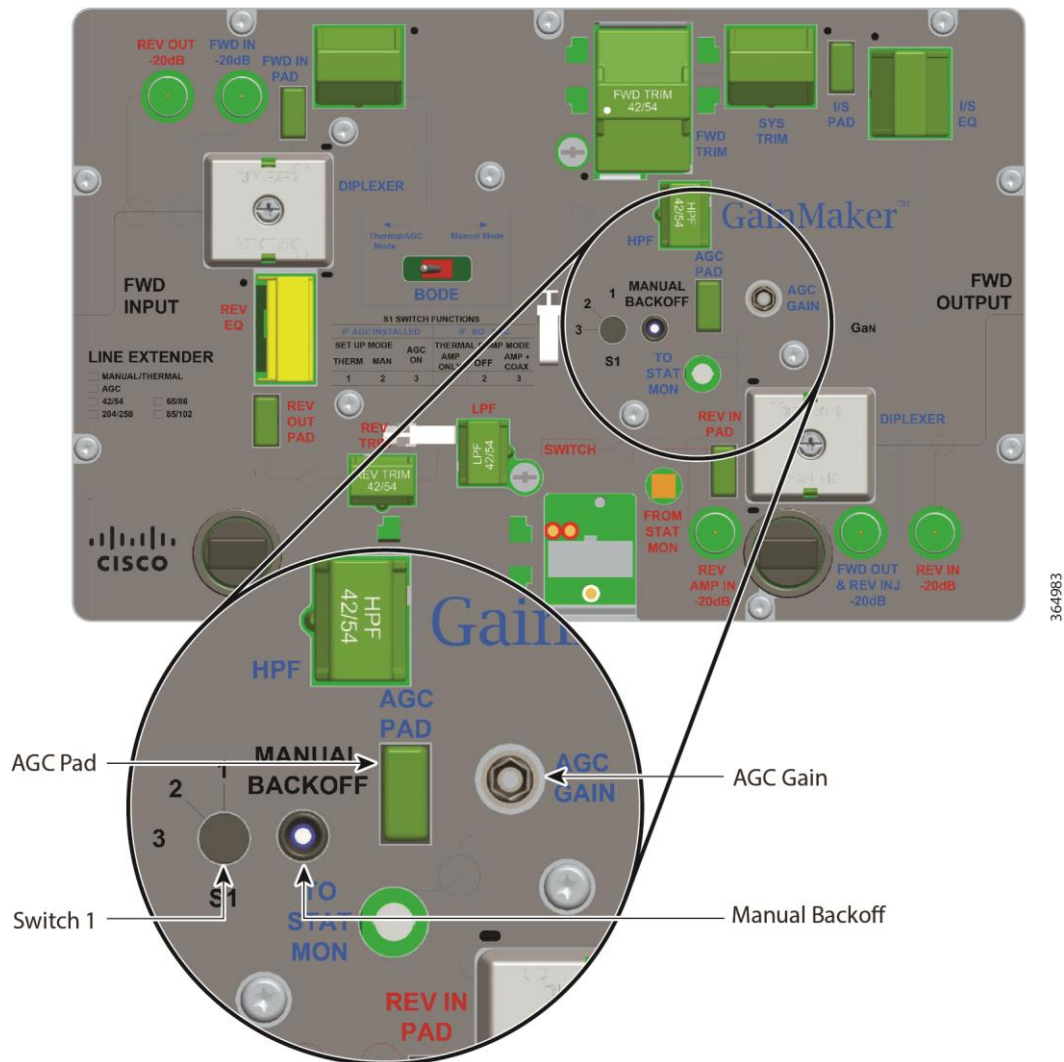

To Select the AGC Pad Value

Use the following formula to determine the correct AGC pad value.

- $\text{AGC pad value} = \text{RF output level at pilot frequency (output port)} - 25 \text{ dB}$

To Align the AGC Module

Complete the following steps to align the AGC module.

- 1 Make sure that switch S1 is set to position 2.

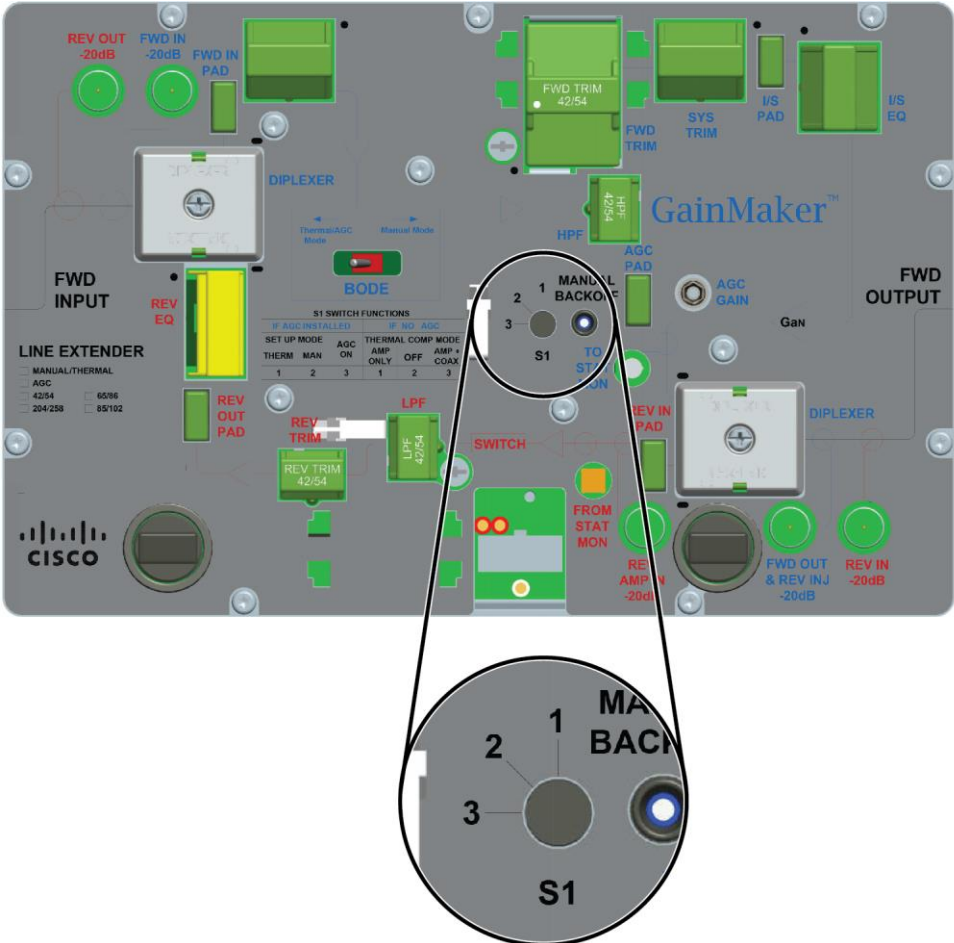

364984

- 2 Insert the test probe into the -20 dB forward main output test point on the line extender.

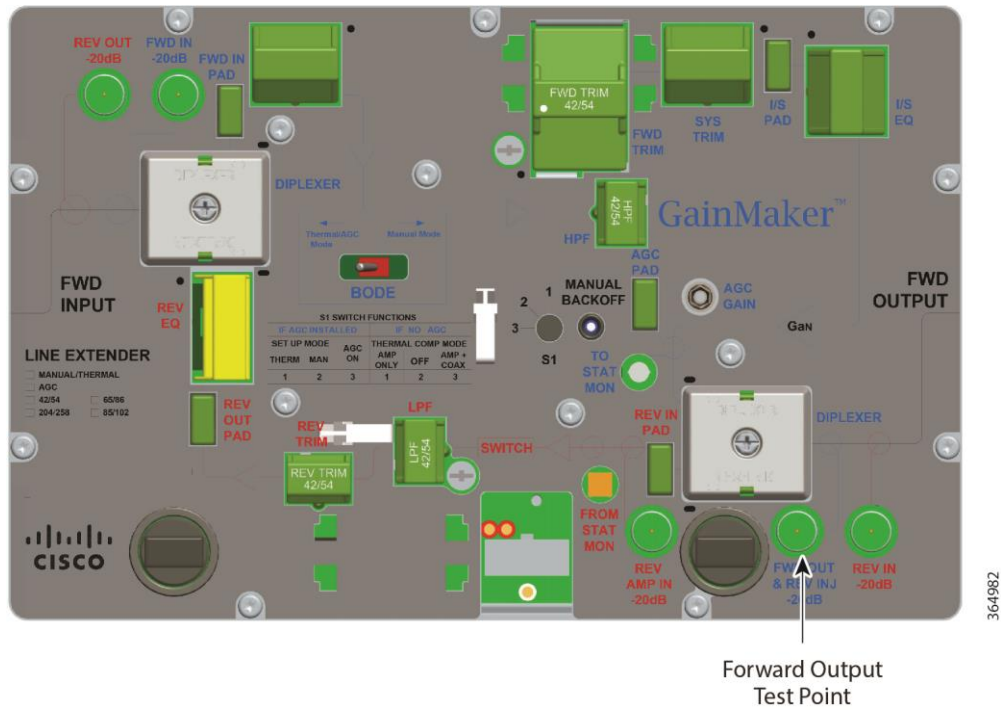

- 3 Measure and note the RF output level at the AGC pilot frequency.
Note: Remember to add 20 dB to compensate for the test point loss.
- 4 Set switch S1 to position 3 for AGC operation.

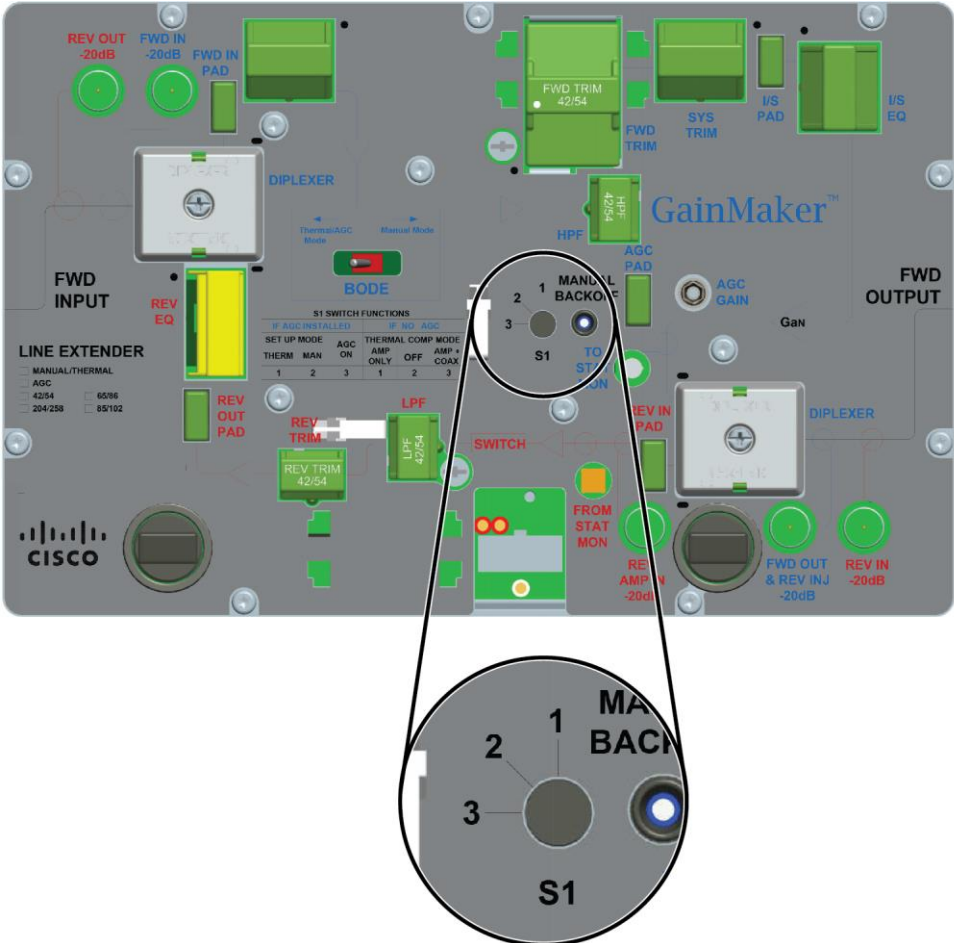

- 5 Adjust the AGC gain control potentiometer to match the level you measured in step 3.

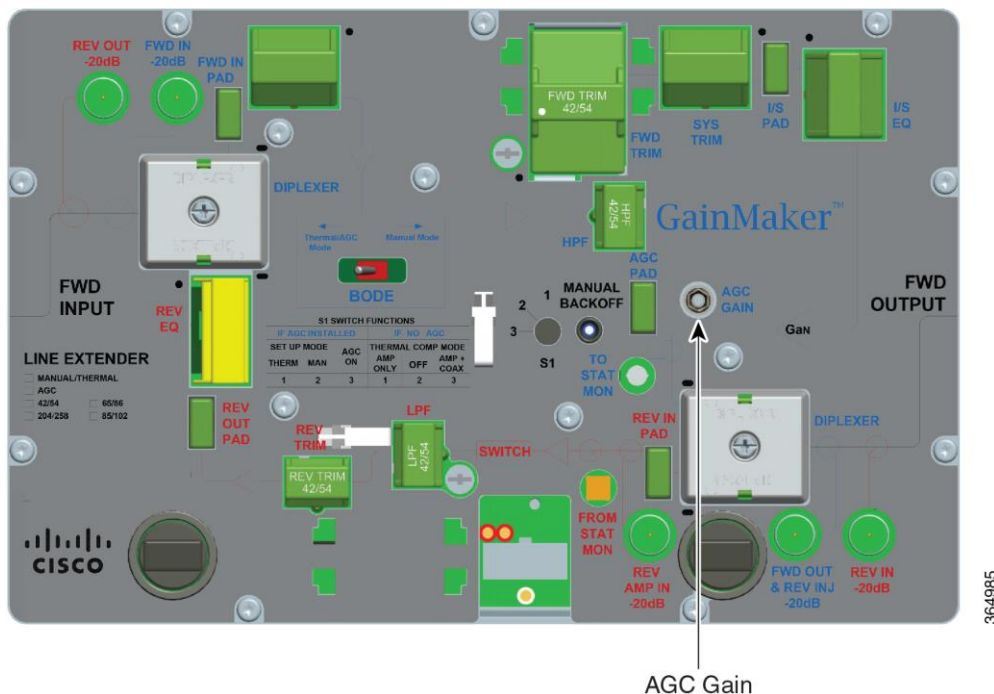

- 6 Move switch S1 back and forth between position 2 and position 3.
Important: Let the line extender module settle before reading signal levels. The signal level should not vary when you switch between positions 2 and 3. If the signal level does vary, repeat steps 4 through 6 as needed until the signal level does not vary between switch positions 2 and 3.
- 7 Set switch S1 to position 3 for AGC operation mode.
- 8 Proceed to *Balancing the Reverse Path* (on page 77).

Forward Path Balancing for AGC Stations Using Thermal Setup Mode

Before you begin, make sure that you have configured the line extender module according to the specifications in the design print, and that the line extender has warmed up for approximately one hour.

To Set Switch S1 for Thermal Setup Mode

You must set switch S1 to position number 1 to use thermal setup mode.

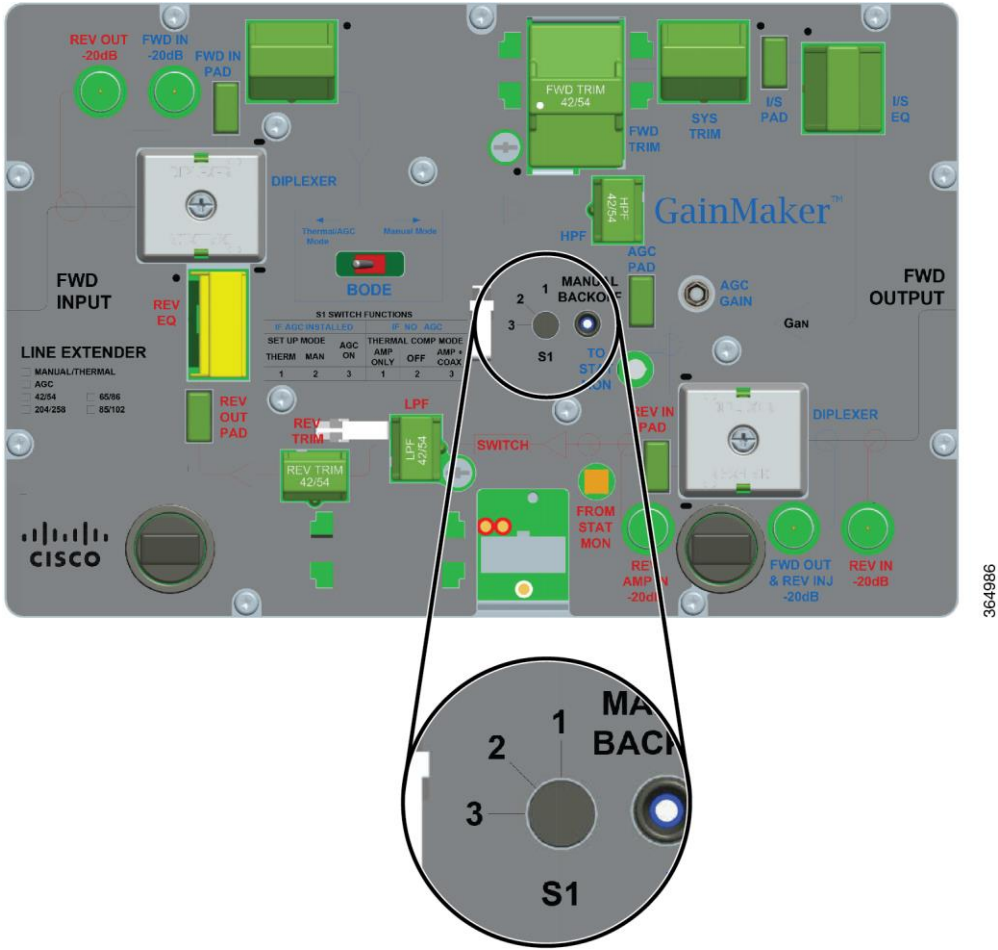

364986

To Determine the Output Tilt

Complete the following steps to determine the output tilt of the line extender.

- 1 Connect the test point adapter to the forward main output test point.

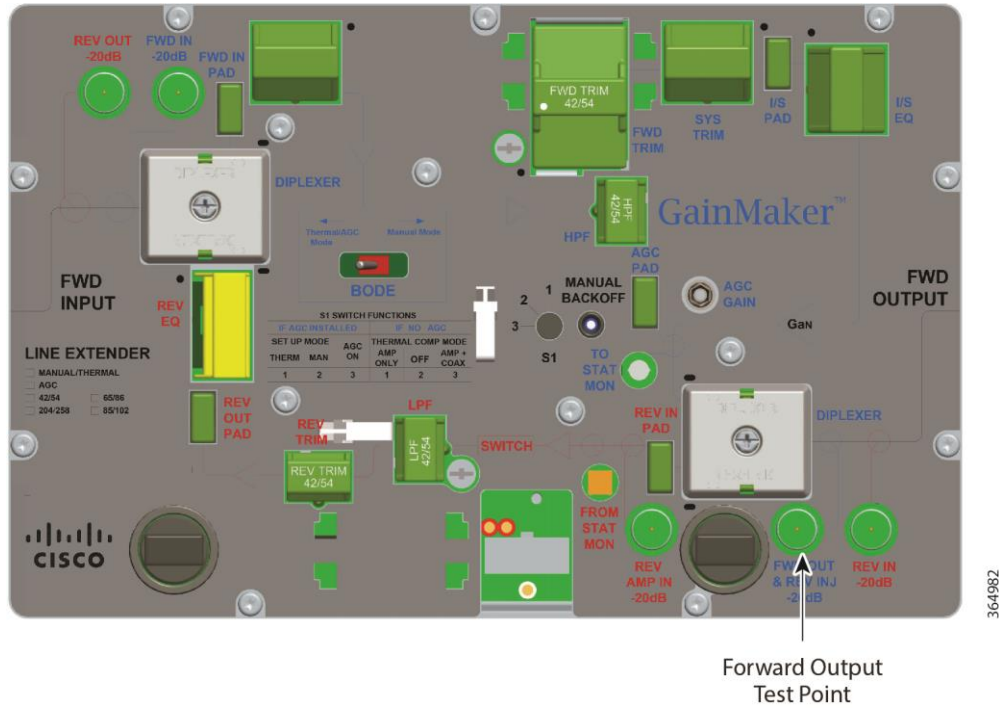

- 2 Consult the design print to find the proper output tilt.
- 3 Measure the output signal levels at the frequencies you used in *To Verify the Input Signal Level* (on page 45).
- 4 To determine the actual output tilt, calculate the difference (in dB) between the levels of the lowest and highest specified frequencies.
- 5 Proceed to the next section, **To Set the Output Tilt**.

To Set the Output Tilt

Equalizers (EQs) are available in 1.5 dB (equivalent) increments. A 1.5 dB change in value changes the difference between low and high frequencies by approximately 1 dB generally, or 1.2 dB for AGC stations in manual setup mode.

- Increasing the equalizer value reduces the level at lower frequencies, relative to the level at 870 MHz/1 GHz/1.2 GHz.
- Decreasing the equalizer value increases the level at lower frequencies, relative to the level at 870 MHz/1 GHz/1.2 GHz.

Complete the following steps to select the proper forward input equalizer value.

- 1 Compare the calculated output tilt in step 4 of **To Determine the Output Tilt** with the design tilt (on the design print).
- 2 Is the output tilt within ± 0.5 dB of the design tilt?
 - If the output tilt is within ± 0.5 dB of the design tilt, proceed to the next section, **To Set the Output Level**.

- If the output tilt is more than design tilt, replace the forward input EQ with a lower value.
 - If the output tilt is less than design tilt, replace the forward input EQ with a higher value.
- 3 Measure the output tilt again, and then return to step 1.

To Set the Output Level

After setting the tilt, complete the following steps to select the proper pad values for the line extender. The output level of the line extender is set by selecting the proper pad value.

- 1 Connect the test probe to the forward main output test point.
- 2 Measure the output level at the highest design frequency, and compare this level with the design level (on the design print).
- 3 Is the measured output level within ± 0.5 dB of the design level?
 - If the output level is within ± 0.5 dB of the design output level, proceed to step 5.
 - If the output level is more than the design output level, replace the forward input pad with a higher value pad.
 - If the output level is less than the design level, replace the forward input pad with a lower value pad.
- 4 Repeat steps 2 and 3 until the output level is correct.
- 5 Proceed to the next section, **To Set Up Automatic Gain Control**.

To Set Up Automatic Gain Control

This section provides procedures and tables for configuring and aligning the AGC in the 1.2 GHz GainMaker Line Extender. AGC attenuator values are required to select the proper AGC attenuator value based upon actual AGC pilot carrier output level. See **To Select the AGC Pad Value**.

Note:

- Output levels are measured at the pilot frequency.
- The standard single-pilot AGC makes line extender output adjustments based on the level of the pilot frequency carrier. Activate the pilot carrier with its final unscrambled video source before beginning balance and alignment.

The following diagram shows the location of the AGC related switch, controls, and AGC pad.

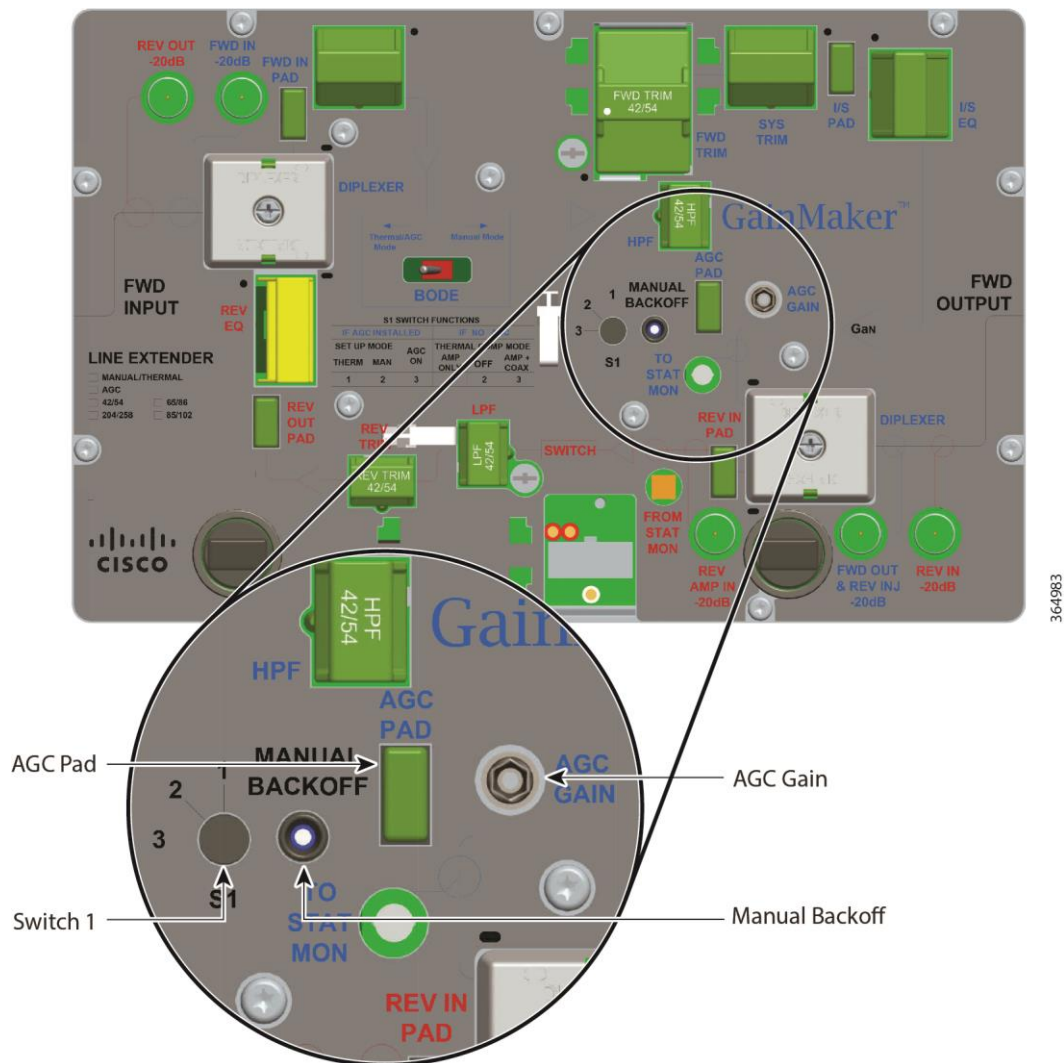

To Select the AGC Pad Value

Use the following formula to determine the correct AGC pad value.

- $\text{AGC pad value} = \text{RF output level at pilot frequency (output port)} - 25 \text{ dB}$

To Align the AGC Module

Complete the following steps to align the AGC module.

- 1 Make sure that switch S1 is set to position 1.

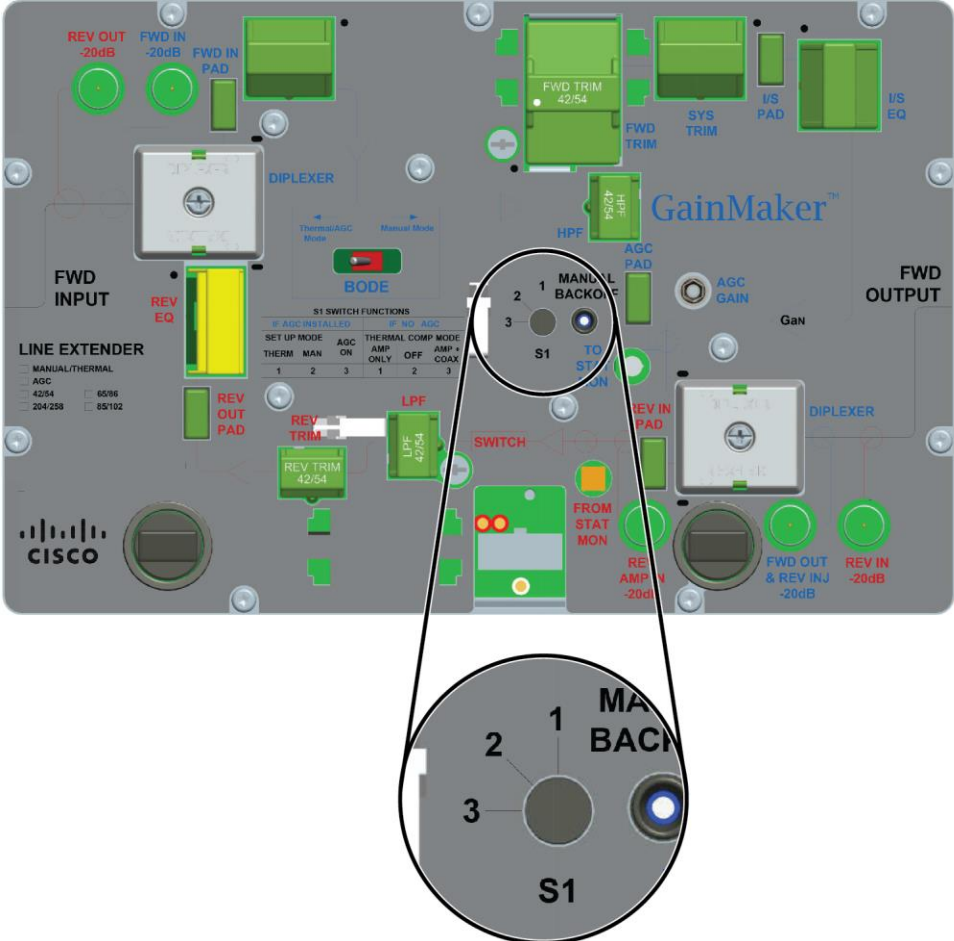

364986

- 2 Insert the test probe into the -20 dB forward main output test point on the line extender.

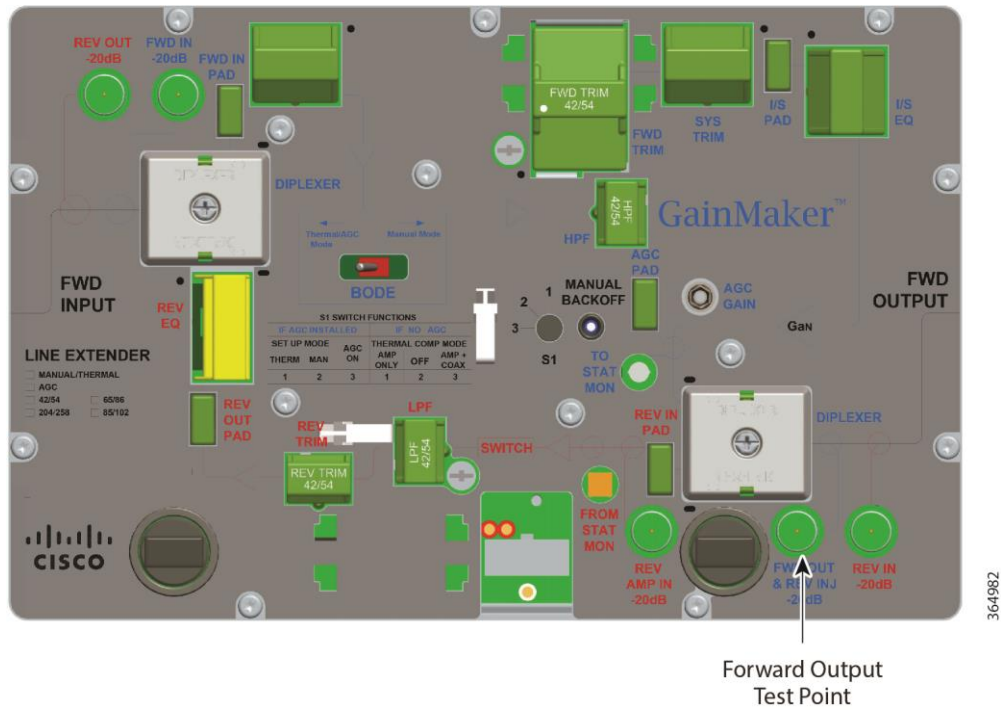

- 3 Measure and note the RF output level at the AGC pilot frequency.
Note: Remember to add 20 dB to compensate for the test point loss.
- 4 Set switch S1 to position 3 for AGC operation.

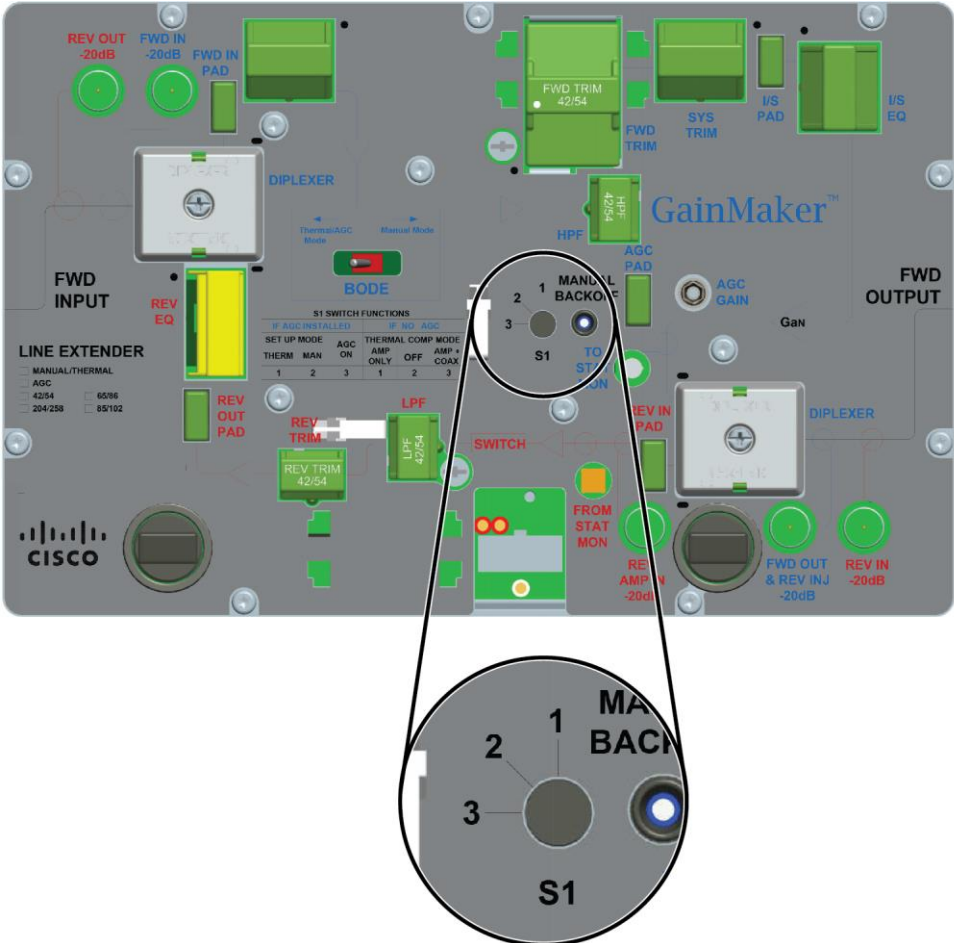

- 5 Adjust the AGC gain control potentiometer to match the level you measured in step 3.

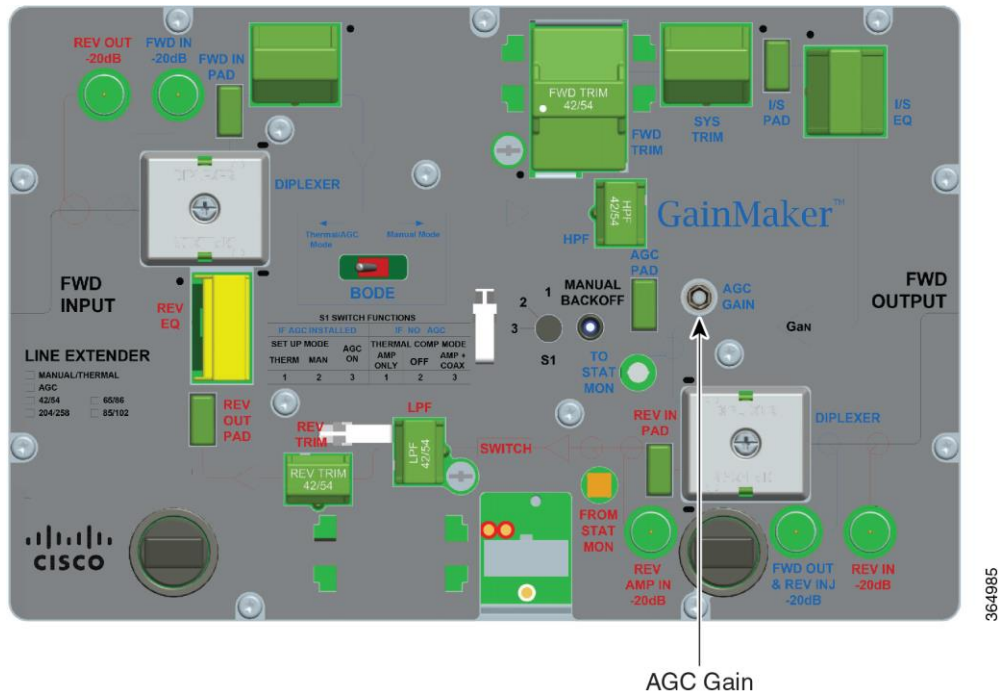

- 6 Move switch S1 back and forth between position 1 and position 3.

Important: Let the line extender module settle before reading signal levels.

The signal level should not vary when you switch between positions 1 and 3. If the signal level does vary, repeat steps 4 through 6 as needed until the signal level does not vary between switch positions 1 and 3.

- 7 Set switch S1 to position 3 for AGC operation mode.
- 8 Proceed to *Balancing the Reverse Path* (on page 77).

Forward Path Balancing for Thermal Stations Using Line Extender Only Compensation Mode

Before you begin, make sure that you have configured the line extender module according to the specifications in the design print, and that the line extender has warmed up for approximately one hour.

To Set Switch S1 for Line Extender Only Compensation Mode

You must set switch S1 to position number 1 to use line extender only compensation mode.

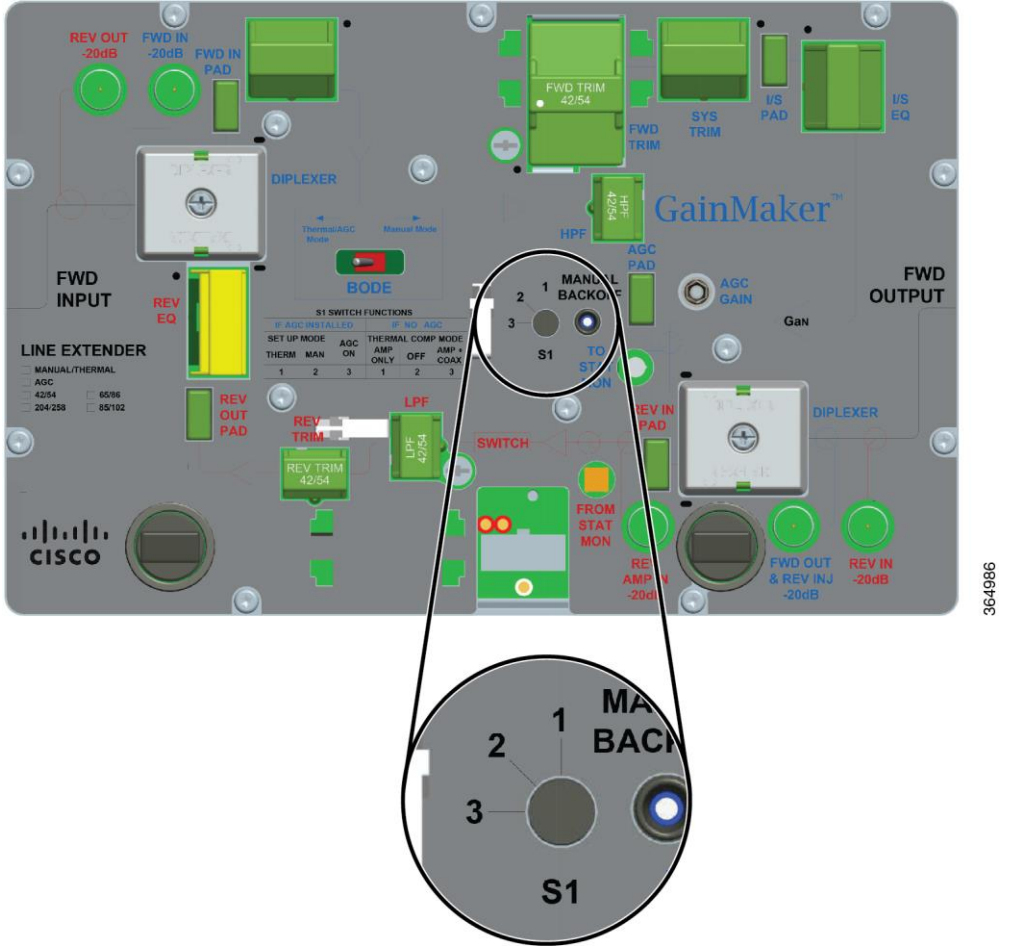

To Determine the Output Tilt

Complete the following steps to determine the output tilt of the line extender.

- 1 Connect the test point adapter to the forward main output test point.

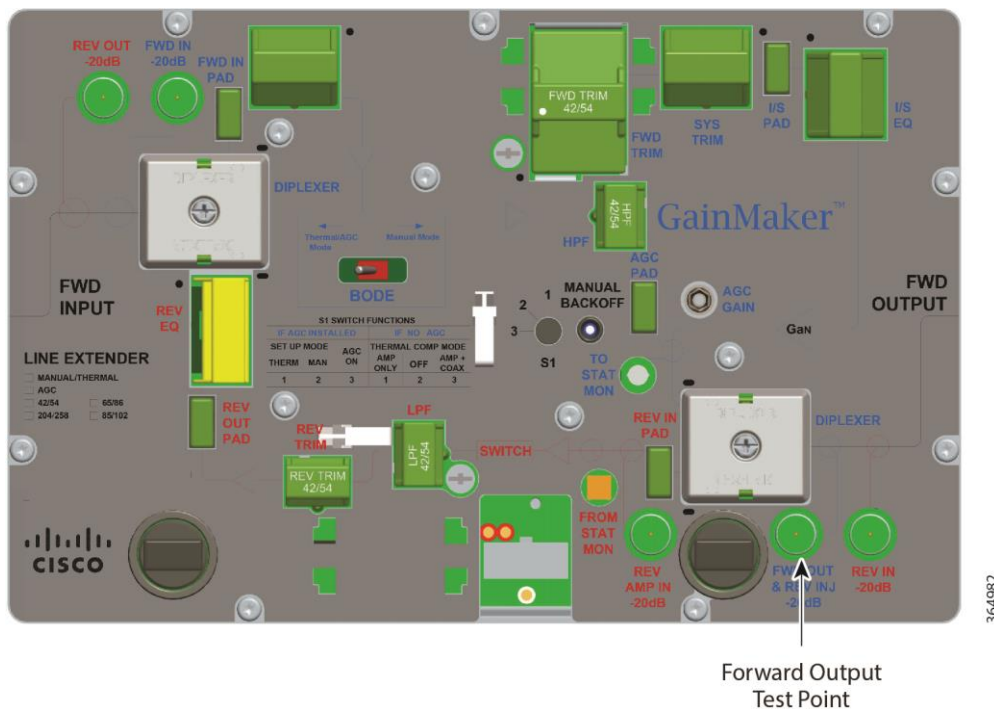

- 2 Consult the design print to find the proper output tilt.
- 3 Measure the output signal levels at the frequencies you used in *To Verify the Input Signal Level* (on page 45).
- 4 To determine the actual output tilt, calculate the difference (in dB) between the levels of the lowest and highest specified frequencies.
- 5 Proceed to the next section, **To Set the Output Tilt**.

To Set the Output Tilt

Equalizers (EQs) are available in 1.5 dB (equivalent) increments. A 1.5 dB change in value changes the difference between low and high frequencies by approximately 1 dB generally, or 1.2 dB for AGC stations in manual setup mode.

- Increasing the equalizer value reduces the level at lower frequencies, relative to the level at 870 MHz/1 GHz/1.2 GHz.
- Decreasing the equalizer value increases the level at lower frequencies, relative to the level at 870 MHz/1 GHz/1.2 GHz.

Complete the following steps to select the proper forward input equalizer value.

- 1 Compare the calculated output tilt in step 4 of **To Determine the Output Tilt** with the design tilt (on the design print).
- 2 Is the output tilt within ± 0.5 dB of the design tilt?
 - If the output tilt is within ± 0.5 dB of the design tilt, proceed to the next section, **To Set the Output Level**.

- If the output tilt is more than design tilt, replace the forward input EQ with a lower value.
 - If the output tilt is less than design tilt, replace the forward input EQ with a higher value.
- 3 Measure the output tilt again, and then return to step 1.

To Set the Output Level

After setting the tilt, complete the following steps to select the proper pad values for the line extender. The output level of the line extender is set by selecting the proper pad value.

- 1 Connect the test probe to the forward main output test point.
- 2 Measure the output level at the highest design frequency, and compare this level with the design level (on the design print).
- 3 Is the measured output level within ± 0.5 dB of the design level?
 - If the output level is within ± 0.5 dB of the design output level, proceed to step 5.
 - If the output level is more than the design output level, replace the forward input pad with a higher value pad.
 - If the output level is less than the design level, replace the forward input pad with a lower value pad.
- 4 Repeat steps 2 and 3 until the output level is correct.
- 5 Proceed to *Balancing the Reverse Path* (on page 77).

Forward Path Balancing for Thermal Stations Using Line Extender and Coax Compensation Mode

Before you begin, make sure that you have configured the line extender module according to the specifications in the design print, and that the line extender has warmed up for approximately one hour.

Note: If it is necessary to balance a thermal station using line extender and coax compensation mode immediately after module installation (with little or no warm-up period), the output level should be set 1 dB lower than specified by the design print. This reduction in output level will be offset by an increase in internal line extender gain as the thermal circuit in the line extender warms up.

To Set Switch S1 for Line Extender and Coax Compensation Mode

You must set switch S1 to position number 3 to use line extender and coax compensation mode.

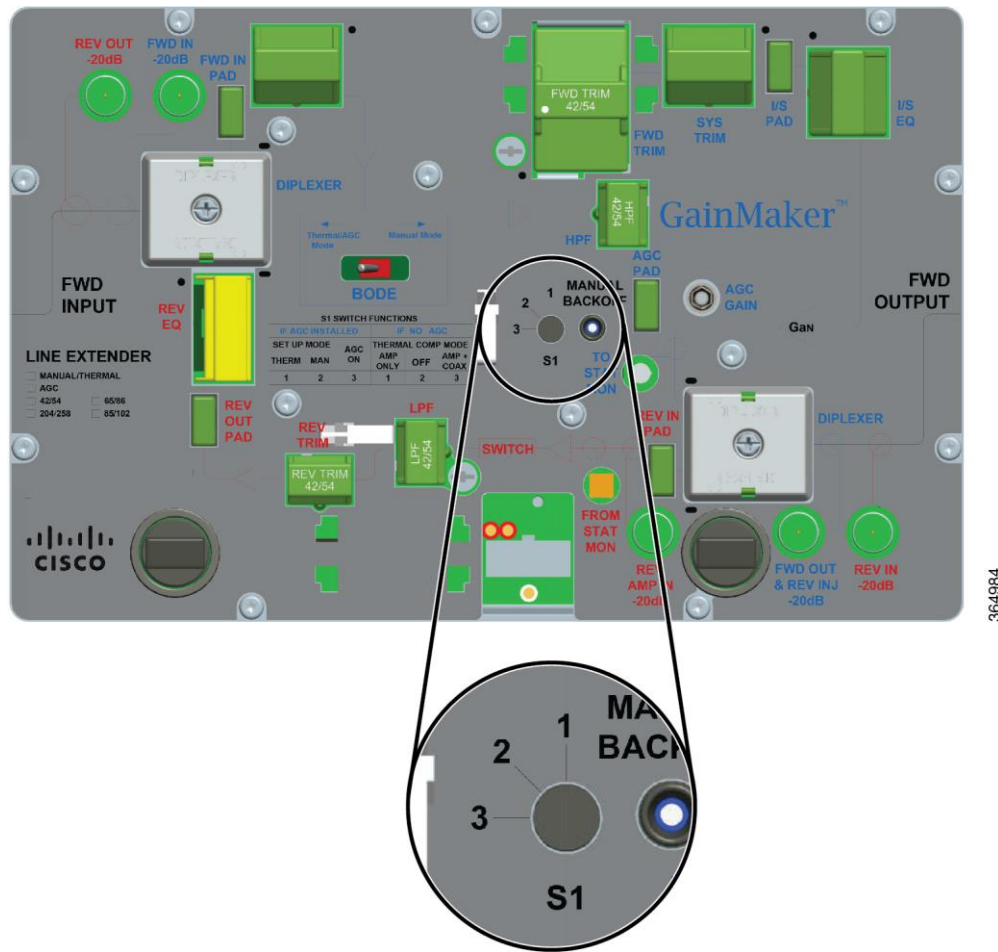

To Determine the Output Tilt

Complete the following steps to determine the output tilt of the line extender.

- 1 Connect the test point adapter to the forward main output test point.

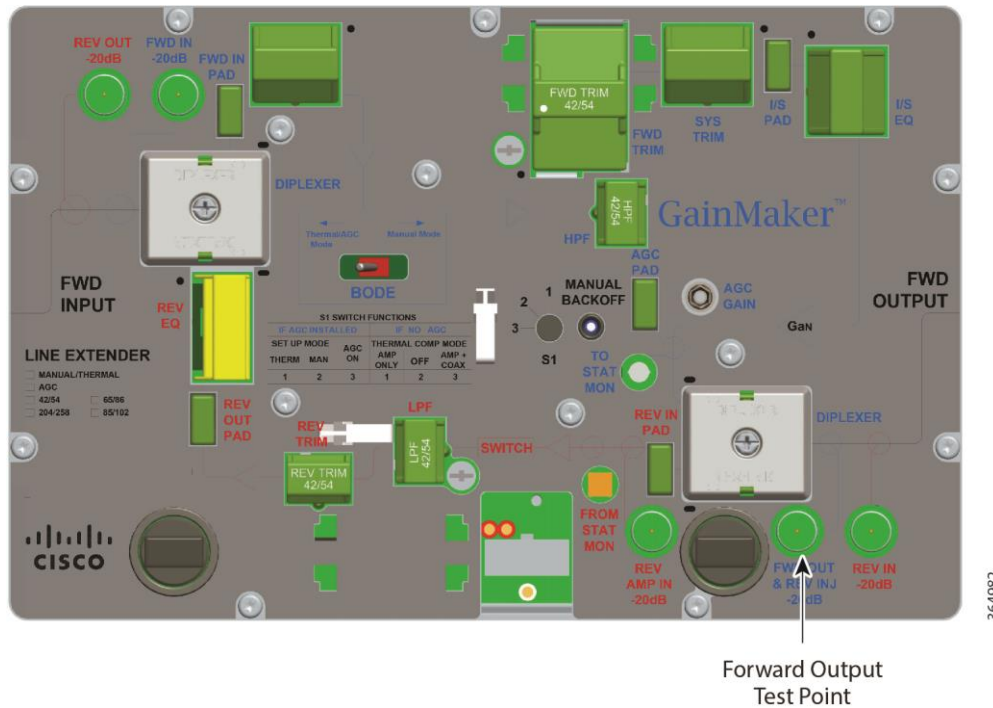

- 2 Consult the design print to find the proper output tilt.
- 3 Measure the output signal levels at the frequencies you used in *To Verify the Input Signal Level* (on page 45).
- 4 To determine the actual output tilt, calculate the difference (in dB) between the levels of the lowest and highest specified frequencies.
- 5 Proceed to the next section, **To Set the Output Tilt**.

To Set the Output Tilt

Equalizers (EQs) are available in 1.5 dB (equivalent) increments. A 1.5 dB change in value changes the difference between low and high frequencies by approximately 1 dB generally, or 1.2 dB for AGC stations in manual setup mode.

- Increasing the equalizer value reduces the level at lower frequencies, relative to the level at 870 MHz/1 GHz/1.2 GHz.
- Decreasing the equalizer value increases the level at lower frequencies, relative to the level at 870 MHz/1 GHz/1.2 GHz.

Complete the following steps to select the proper forward input equalizer value.

- 1 Compare the calculated output tilt in step 4 of **To Determine the Output Tilt** with the design tilt (on the design print).
- 2 Is the output tilt within ± 0.5 dB of the design tilt?
 - If the output tilt is within ± 0.5 dB of the design tilt, proceed to the next section, **To Set the Output Level**.

- If the output tilt is more than design tilt, replace the forward input EQ with a lower value.
 - If the output tilt is less than design tilt, replace the forward input EQ with a higher value.
- 3 Measure the output tilt again, and then return to step 1.

To Set the Output Level

After setting the tilt, complete the following steps to select the proper pad values for the line extender. The output level of the line extender is set by selecting the proper pad value.

Note: If you are setting the output level of a line extender that has not warmed up for approximately one hour, skip to the **To Set the Output Level for a Cold Amplifier** procedure below.

To Set the Output Level for a Warm Line Extender

- 1 Connect the test probe to the forward output test point.
- 2 Measure the output level at the highest design frequency, and compare this level with the design level (on the design print).
- 3 Is the measured output level within ± 0.5 dB of the design level?
 - If the output level is within ± 0.5 dB of the design output level, proceed to *Balancing the Reverse Path* (on page 77).
 - If the output level is more than the design output level, replace the forward input pad with a higher value pad.
 - If the output level is less than the design output level, replace the forward input pad with a lower value pad.

To Set the Output Level for a Cold Line Extender

After setting the tilt, complete the following steps to select the proper pad values for the line extender. The output level of the line extender is set by selecting the proper pad value.

Note: Using this procedure will result in a more accurate output level setting when balancing a line extender using line extender and coax compensation mode if the line extender has had little or no warm-up period.

Important: For the most accurate output level setting, allow the line extender to warm up for approximately one hour and use the **To Set the Output Level for a Warm Amplifier** procedure above.

- 1 Connect the test probe to the forward output test point.

- 2 Measure the output level at the highest design frequency, and compare this level with the design level (on the design print), *minus 1 dB*.

The station output level must be 1 dB lower than the output level specified by the design print. This reduction in output level will be offset by an increase in internal line extender gain as the thermal circuit in the line extender warms up.

- 3 Is the measured output level within ± 0.5 dB of the design level *minus 1 dB*?
 - If the output level is within ± 0.5 dB of the design output level *minus 1 dB*, proceed to step 5.
 - If the output level is more than the design output level *minus 1 dB*, replace the forward input pad with a higher value pad.
 - If the output level is less than the design level *minus 1 dB*, replace the forward input pad with a lower value pad.
- 4 Repeat steps 2 and 3 until the output level is correct.
- 5 Proceed to *Balancing the Reverse Path* (on page 77).

Forward Path Balancing for Manual Stations

Before you begin, make sure that you have configured the line extender module according to the specifications in the design print, and that the line extender has warmed up for approximately one hour.

No Switch 1 Setting for Manual Stations

A manual station is a station that has no Bode network installed. Therefore, there is no interstage level correction, and Switch 1 has no effect on station operation.

To Determine the Output Tilt

Complete the following steps to determine the output tilt of the line extender.

- 1 Connect the test point adapter to the forward main output test point.

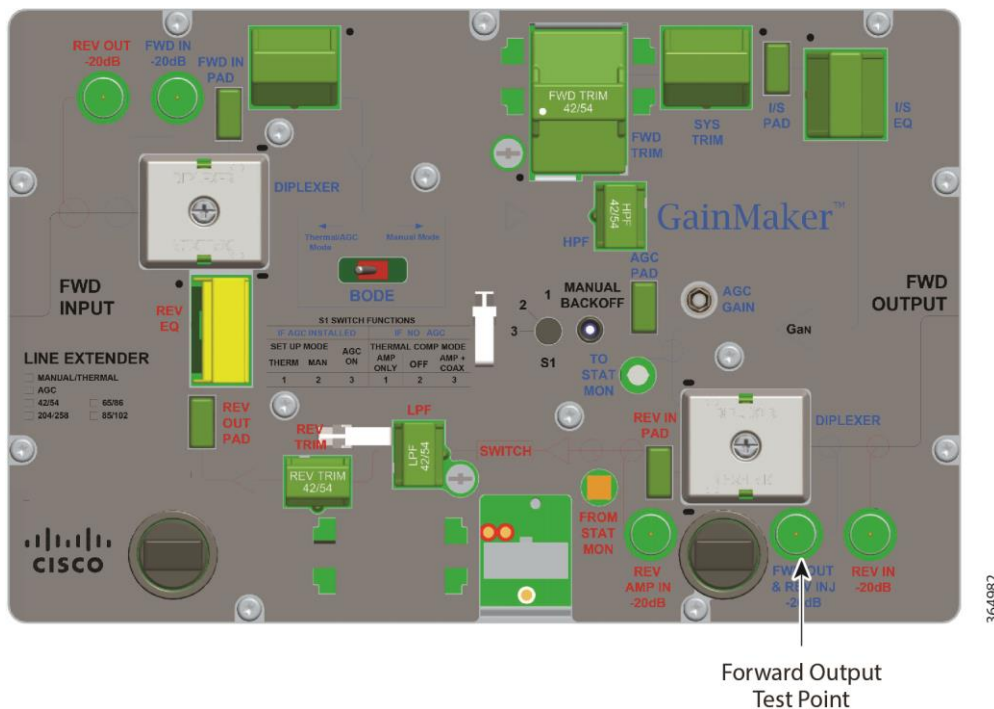

- 2 Consult the design print to find the proper output tilt.
- 3 Measure the output signal levels at the frequencies you used in *To Verify the Input Signal Level* (on page 45).
- 4 To determine the actual output tilt, calculate the difference (in dB) between the levels of the lowest and highest specified frequencies.
- 5 Proceed to the next section, **To Set the Output Tilt**.

To Set the Output Tilt

Equalizers (EQs) are available in 1.5 dB (equivalent) increments. A 1.5 dB change in value changes the difference between low and high frequencies by approximately 1 dB generally, or 1.2 dB for AGC stations in manual setup mode.

- Increasing the equalizer value reduces the level at lower frequencies, relative to the level at 870 MHz/1 GHz/1.2 GHz.
- Decreasing the equalizer value increases the level at lower frequencies, relative to the level at 870 MHz/1 GHz/1.2 GHz.

Complete the following steps to select the proper forward input equalizer value.

- 1 Compare the calculated output tilt in step 4 of **To Determine the Output Tilt** with the design tilt (on the design print).
- 2 Is the output tilt within ± 0.5 dB of the design tilt?
 - If the output tilt is within ± 0.5 dB of the design tilt, proceed to the next section, **To Set the Output Level**.

- If the output tilt is more than design tilt, replace the forward input EQ with a lower value.
 - If the output tilt is less than design tilt, replace the forward input EQ with a higher value.
- 3 Measure the output tilt again, and then return to step 1.

To Set the Output Level

After setting the tilt, complete the following steps to select the proper pad values for the line extender. The output level of the line extender is set by selecting the proper pad value.

- 1 Connect the test probe to the forward main output test point.
- 2 Measure the output level at the highest design frequency, and compare this level with the design level (on the design print).
- 3 Is the measured output level within ± 0.5 dB of the design level?
 - If the output level is within ± 0.5 dB of the design output level, proceed to step 5.
 - If the output level is more than the design output level, replace the forward input pad with a higher value pad.
 - If the output level is less than the design level, replace the forward input pad with a lower value pad.
- 4 Repeat steps 2 and 3 until the output level is correct.
- 5 Proceed to *Balancing the Reverse Path* (on page 77).

Forward Path Balancing Using Trim Networks

This section describes the procedure to follow when installing a trim network.

A trim network allows you to adjust line extender frequency response to make it as uniform as possible across the entire output spectrum. The trim network can be adjusted within limits to cover a wide range of individual requirements. Type and use factor are determined by evaluating actual system frequency response.

Refer to the frequency response plots in *System Amplifier and Line Extender including GainMaker® Products Trim Networks Installation Instructions*.

To Install a Trim Network

Complete the following steps to install a trim network.

- 1 Open the line extender housing. Refer to *To Open the Line extender Housing* (on page 15).

- 2 Switch the AGC to **THERMAL**.
- 3 Record the RF output levels.

Note: The trim network location is labeled **SYS TRIM** on the module cover. Refer to the following illustration.

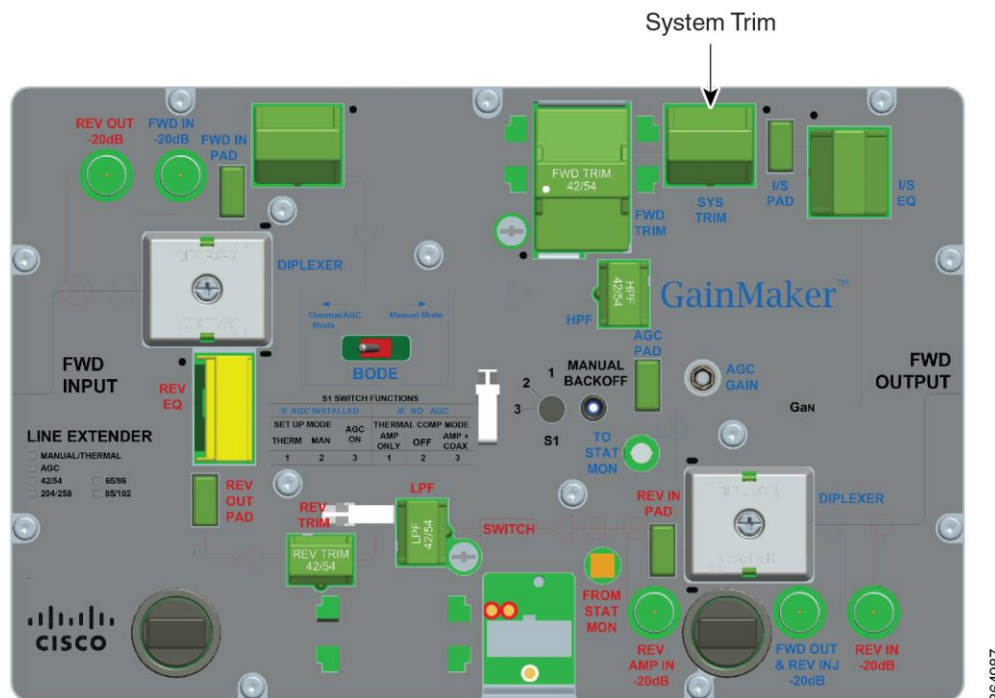

- 4 Remove the jumper from the system trim location.
- 5 Install the trim network into the system trim slot.

Note:

- Be sure that all pins on the system trim bottom align with the pin holes in the system trim slot, so the system trim installs flat against the line extender module.
 - Make sure the components face the outside of the station. See the preceding diagram for proper positioning.
- 6 After tuning the trim network for proper response, measure the RF output level.
 - 7 Change the interstage pad or input pad to obtain the same RF output level as noted in step 3.
 - 8 Switch the AGC module to **AUTO**.
 - 9 Reset the AGC for proper output levels.
 - 10 Close the line extender housing. Refer to *To Close the Line Extender Housing* (on page 40).

Balancing the Reverse Path

This section covers reverse RF amplifier cascade balancing. Balancing refers to the process of individually aligning reverse amplifier gain and tilt characteristics to achieve reverse amplifier cascades that have optimum, repeatable transmission characteristics.

There are a variety of test equipment combinations that enable proper balancing of the reverse path. Regardless of the type of equipment used, the balancing process is fundamentally the same.

About Reverse Path Balancing

Balancing should be completed in the following order.

- 1 Balance the reverse fiber link, i.e., the path from the line extender reverse optical transmitter to the headend or hub reverse optical receiver.
- 2 Balance the individual reverse amplifier cascades that combine at the node. Start with the line extender closest to the node, and work from that point outward towards the first reverse amplifier in each upstream cascade.

Injection of Test Signal(s)

During the balancing process, a reverse RF test signal or signals of known amplitude are injected into the reverse RF input path of the line extender prior to the reverse amplification circuit. The injected signals are amplified and routed out the station reverse RF output port in the upstream direction. The injected test signals pass through any previously balanced line extender in the reverse cascade, as well as the reverse fiber link, and arrive at the node reverse optical receiver, which typically is located in the headend or hub.

Monitoring and Adjusting Received Amplitude and Tilt

The amplitude and tilt associated with the received signals are monitored at the headend or hub at an RF test point on the output of the reverse optical receiver associated with the particular node. The received amplitude and tilt of the test signals are compared to the desired (reference value) amplitude and tilt. Any deviations from reference value amplitude or tilt are then minimized by altering the (dB) value of the output pad or equalizer in the line extender being balanced. This process is completed for each line extender in the reverse cascade, working outward from the node.

Methods of Generating and Monitoring Test Signals

The reverse RF test signals to be injected into the reverse path of the line extender being balanced may be generated by the following.

- Multiple CW signal (tone) generator
- Reverse sweep transmitter

The amplitude and tilt of the received test signals at the output of the reverse optical receiver in the headend or hub may be measured and monitored using the following.

- Spectrum analyzer (when using a CW generator for test signals)
- Signal level meter (when using a CW generator for test signals)
- Reverse sweep receiver (when using a reverse sweep transmitter for test signal)

Communicating Test Results

The variance in relative amplitude and tilt of the received signal from desired (reference) may be relayed to the field technician via the following.

- Radio, by a second technician in the headend or hub who is monitoring a spectrum analyzer or signal level meter
- A dedicated forward TV channel whose associated modulator has its video input being generated by a video camera focused on the spectrum analyzer display
- An associated forward data carrier (if using a particular type of reverse sweep system)

If a portable reverse sweep generator with built-in forward data receiver is used to generate the reverse test signals, only one technician is required to perform the balancing. This type of system is becoming increasingly popular due to its ease of use.

In this case, the sweep system includes a combination reverse sweep receiver and forward data transmitter, which is located in the headend or hub. The frequency response characteristics of the received sweep signal, including relative amplitude and tilt, are converted by the headend sweep receiver to a data format and transmitted in the forward RF path as a data carrier by combining it into the forward headend combiner.

The portable sweep generator or data receiver that is injecting the test signals into the reverse path in the field is simultaneously receiving the incoming data carrier via the forward RF path, and converting it back to a sweep display which represents what is being received by the headend unit.

While one technician in the field can monitor the received amplitude and determine whether it deviates from reference or not, any variation in amplitude required at the output of the receiver in the headend would typically be accomplished by a second technician in the headend, who is in communication with the technician in the field.

Note: When using a reverse sweep system such as this, be sure to consult the manufacturer's guide to determine proper headend combining and to ensure proper telemetry levels.

To Prepare the Line Extender for Reverse Path Balancing

Complete the following steps for initial reverse path balancing.

- 1 Balance all of the reverse amplifiers off a given reverse input port for the node being worked on. The reverse amplifiers should be balanced sequentially from the node outward.

Note: Make sure the reverse fiber link has been properly balanced before proceeding.

- 2 Ensure that the design value reverse output equalizer and reverse pads are installed in the appropriate reverse slots in the line extender. Refer to the following diagram.

Note: Record the pad values for each input port for later use.

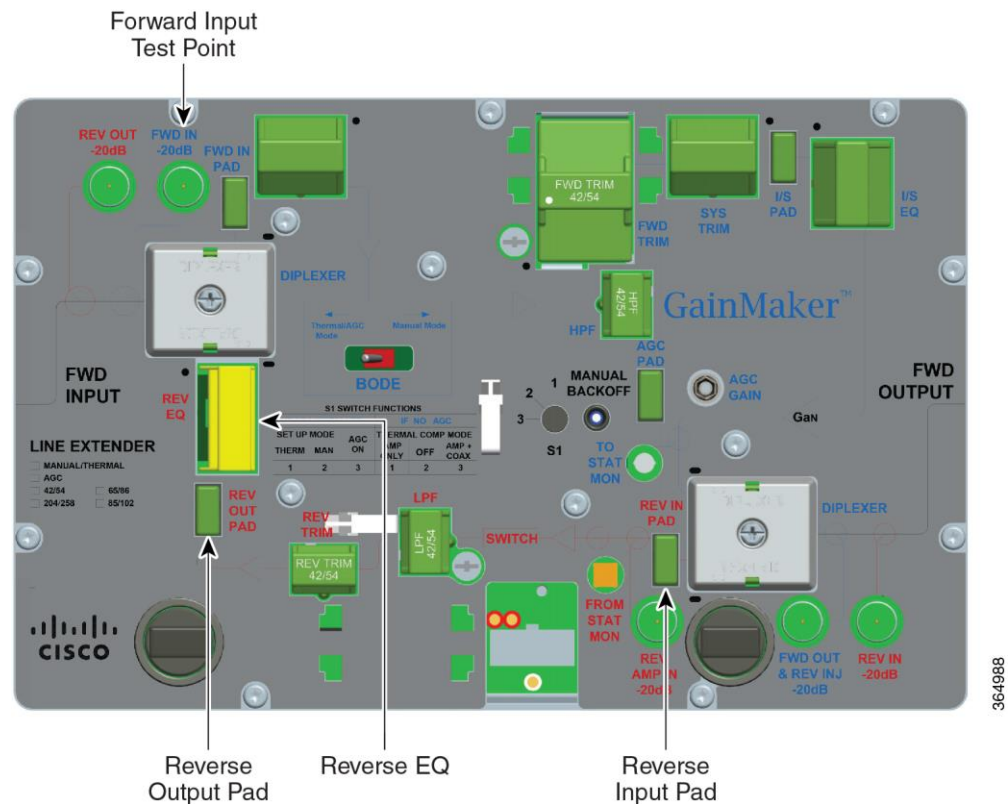

3 Proceed to *To Calculate the Proper RF Signal Level* (on page 80).

To Calculate the Proper RF Signal Level

In order to calculate the correct RF signal level to inject, you must know the following.

- Design Reverse Port Input Level from the design print
- Total Injection Insertion Loss (20 dB)

To calculate the correct signal level to inject, add the total injection insertion loss to the design port input level.

Example

- Design line extender reverse port input level = 19 dBmV
- Total injection insertion loss = 20 dB

The design line extender reverse port input level plus injection insertion loss equals correct RF signal level to inject.

In the example shown above, $19 \text{ dBmV} + 20 \text{ dB} = 39 \text{ dBmV}$. Therefore, you would set the signal generator output for + 39 dBmV.

Important:

- When using a CW signal generator, inject at least two carriers, one at the low end and one at the high end of the reverse bandpass. In a reverse system with a 5 MHz to 40 MHz bandpass, the low frequency carrier should be in the 5 MHz to 10 MHz range and the high frequency carrier should be in the 35 MHz to 40 MHz range.
- The amplitude of the signal generator output can be set higher or lower than the level specified by the calculation above, but the difference between the actual output level and the level calculated above must be known. If the generator output is x dB higher (or lower) than the level calculated, then the reference (desired) level received at the headend or hub should also be x dB higher (or lower) than the original headend reference level.
- The station reverse input pad values are selected during the reverse system design and are based on the need to minimize variations in return path losses for the various reverse inputs. Do not permanently alter the values of the reverse input pads without consulting a system designer.
- In the GainMaker Line Extender, the reverse input comes after the reverse injection point in the reverse path. Temporarily replacing the design value reverse input pad on the port being balanced with a 0 dB pad allows the reverse injection level and the receive levels at the monitoring end to remain constant

from line extender to line extender and from port to port.

An alternative to this method is to expect a receive level that is x dB lower than normal, where x is the value of the reverse input pad on the port being balanced, which you noted earlier in the reverse path balancing procedure.

Insert the appropriate signal amplitude into the reverse injection point. Refer to the following illustration.

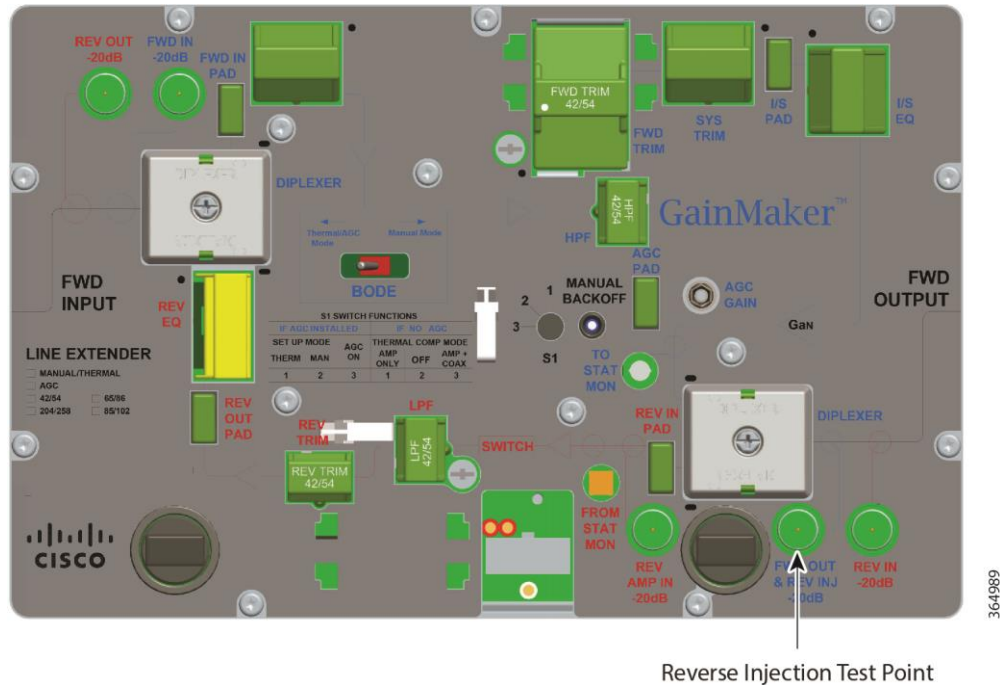

Proceed to *To Complete Reverse Path Balancing* (on page 81).

To Complete Reverse Path Balancing

Complete the following steps to finish the line extender setup.

- 1 Monitor the tilt of the signals being received at the headend or hub reverse optical receiver RF output test point.

Note:

- The tilt is the difference in signal level between the highest and lowest frequencies in the reverse passband, or between the highest and lowest frequency CW test signals.
- Most systems prefer to have minimal reverse tilt (flat levels) at the headend.
- To minimize tilt, change the value of the line extender reverse output equalizer.

- 2 Monitor the amplitude (level) of the signals being received at the headend or hub

reverse optical receiver RF output test point.

- a Compare the received level to the reference level desired.
 - b If using a sweep system that is x dB below standard CW carrier levels, be sure to consider that the receive level should also be x dB below the CW reference level.
 - c To adjust the receive level to make it match the desired reference level, alter the value of the line extender reverse output pad. Each 1 dB increase in pad value should result in a corresponding 1 dB decrease in receive level, and each 1 dB decrease in pad value should give a 1 dB increase in receive level.
- 3 Once the proper receive level and tilt of the test signals have been achieved, properly close the line extender housing and repeat the process at the next reverse amplifier in the downstream cascade.

Important:

- Reinstall design print value reverse input pads for any port whose input pad may have been temporarily replaced with a 0 dB value pad for reverse path balancing purposes.
- Work outward from the node, and outward from each external split in the coaxial plant, until all line extenders in the cascade have been balanced.
- Repeat the process for all of the reverse amplifier cascades off any remaining active node ports until all reverse amplifiers feeding into the node have been balanced.

4

Troubleshooting

Introduction

The 1.2 GHz GainMaker Line Extender is configured with modules that support different functions. This modular design approach provides the following benefits:

- The housing design has the flexibility to accept a variety of modules.
- The modules contain few user serviceable parts. This provides ease of troubleshooting and minimal downtime during repairs.

This chapter describes the steps you may take to troubleshoot the 1.2 GHz GainMaker Line Extender.

In This Chapter

- Equipment..... 84
- No AC Power 85
- No DC Power 87
- No Forward RF Signal..... 89
- Low or Degraded Forward RF Signal..... 90
- No Reverse RF Signal 92
- Low or Degraded Reverse RF Signal 93

Equipment

The following equipment may be necessary to perform some troubleshooting procedures.

- CLETOP or OPTIPOP ferrule cleaner (CLETOP Type A for SC, Type B for LC)
- Compressed air (also called “canned air”)
- Lint-free wipes moistened with optical-grade (99%) isopropyl alcohol
- Bulkhead swabs for LC or SC type connectors (choose appropriate type)
- Optical connector scope
- Optical power meter to measure light levels
- Proper fiber connector for optical power meter to make optical connections
- Digital voltmeter to measure voltages
- Spectrum analyzer or a field strength meter to measure RF levels
- Test point probe, to access test points

No AC Power

AC power can be measured at the line extender seizure screws, AC shunt power directors, power supply harness, and AC test points.

The following diagram illustrates the AC test point locations for the 1.2 GHz GainMaker Line Extender.

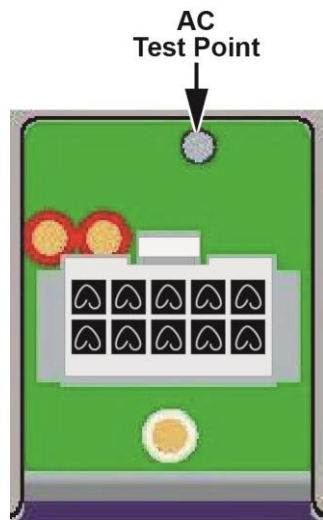
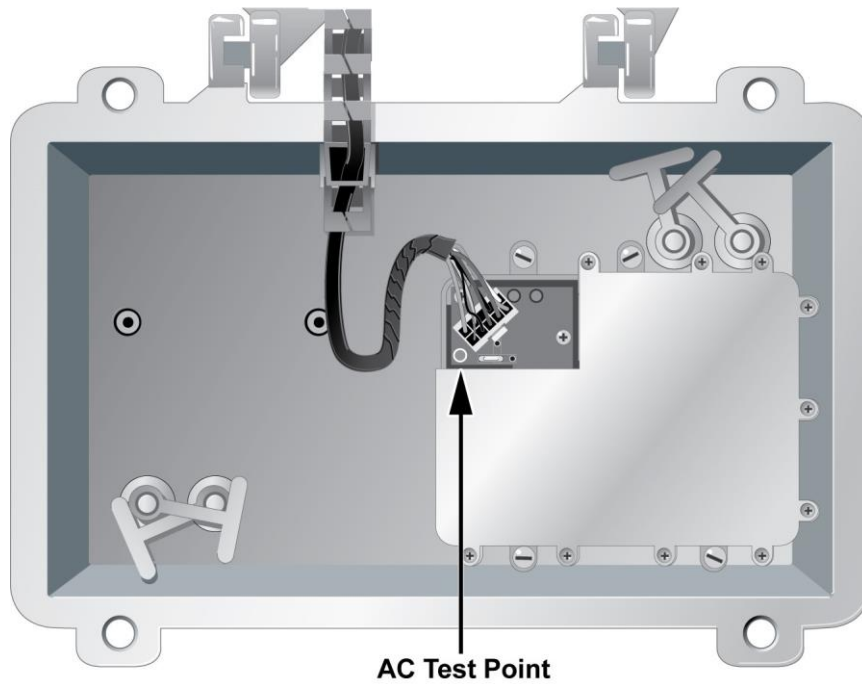

No AC Power Troubleshooting Table

Before you begin troubleshooting for no AC power, verify that there is proper AC power input coming into the line extender and that the AC voltage lockout threshold is set to your system's power requirements.

Possible cause	Solution
No AC at the housing seizure.	<ul style="list-style-type: none"> ■ Check the AC source. ■ Check the AC shunt power director configuration at the line extender feeding AC to this line extender. ■ Make sure that the housing seizure is properly tightened.
AC at the housing seizure but not at the AC shunt power director.	<ul style="list-style-type: none"> ■ Check and/or replace the AC shunt power director. ■ Check and/or replace the line extender module.
AC at the line extender test point but not at the power supply test point.	<ul style="list-style-type: none"> ■ Check and/or replace the power supply wiring harness. ■ Check and/or replace the power supply.

No DC Power

DC power can be measured at the DC power supply test points and power wiring harness.

The following diagram illustrates the DC test point locations for the 1.2 GHz GainMaker Line Extender.

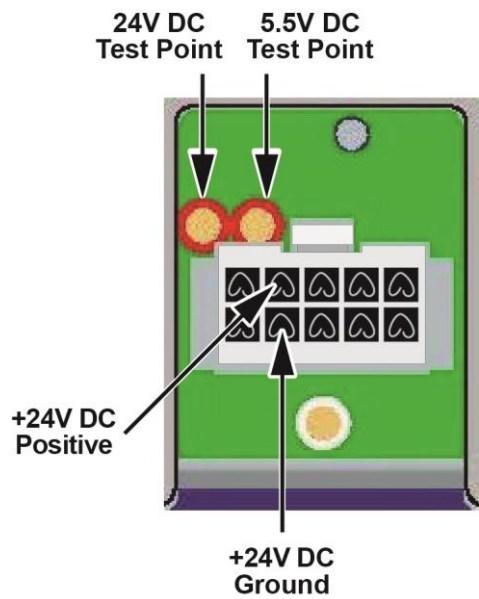
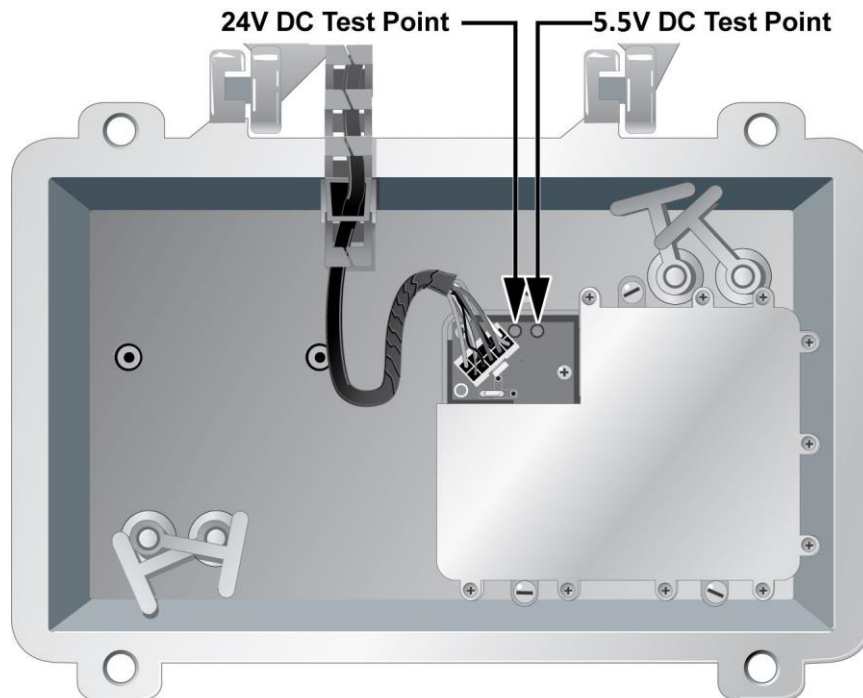

No DC Power Troubleshooting Table

Before you begin troubleshooting for no DC power, verify that there is proper AC power input coming into the DC power supply and that the AC voltage lockout threshold is set to your system's powering requirements.

Possible cause	Solution
No DC power at the power supply.	■ Check and/or replace the power supply.
DC at the power supply but not at the line extender module.	■ Check and/or replace the power wiring harness and/or the line extender module. ■ Check and/or replace the power supply.

No Forward RF Signal

The forward RF signal can be measured at the line extender module forward input and forward output test points.

No Forward RF Signal Troubleshooting Table

Before you begin troubleshooting for no forward RF signal, verify that the line extender is receiving the proper forward RF input signal from the upstream equipment.

Important: You cannot balance the line extender without the proper forward RF input signal.

Possible cause	Solution
No forward RF signal at the forward input test point.	<ul style="list-style-type: none"> ■ Verify that the line extender is receiving the proper forward RF input signal from the upstream equipment. <p>Important: You cannot balance the line extender without the proper forward RF input signal.</p>
There is forward RF signal at the forward input test point, but no signal at one or all of the forward output test points.	<ul style="list-style-type: none"> ■ Verify that the line extender module is receiving the proper AC and DC voltages. Refer to <i>No AC Power</i> (on page 85) and <i>No DC Power</i> (on page 87). ■ Verify that all the proper accessories, pads, EQs, and signal directors (if applicable) are firmly installed in the correct locations. ■ Verify that the factory installed accessories are firmly installed in the correct locations. <p>Note: Verifying factory installations involves removing the line extender module cover. Reinstall the line extender module cover properly or RF signal degradation may result.</p> <ul style="list-style-type: none"> ■ Replace the line extender module.

Low or Degraded Forward RF Signal

The forward RF signal can be measured at the line extender module forward input and forward output test points.

Low or Degraded Forward RF Signal Troubleshooting Table

Before you begin troubleshooting for a low or degraded forward RF signal, verify that the line extender is receiving the proper forward RF input signal from the upstream equipment.

Important: You cannot balance the line extender without the proper forward RF input signal.

Make sure you have configured the line extender module according to the specifications in the design print, and that the line extender has warmed up for approximately one hour.

Make sure you are using the proper tilt reference when setting levels. An 870 MHz, 1 GHz or 1.2 GHz design balanced at 550 MHz requires a corrected tilt reference to compensate for the difference in carrier levels between 550 MHz and 870 MHz, 1 GHz or 1.2 GHz. The tilt reference at 550 MHz is lower than the tilt reference at 870 MHz, 1 GHz or 1.2 GHz. Refer to the tilt charts in *Technical Information* (on page 97) for more information.

Important: If the line extender cover was ever removed, make sure it was properly reinstalled. Improperly reinstalling the line extender module cover may result in RF signal degradation.

Possible cause	Solution
Low or degraded forward RF signal at the forward input test point.	<ul style="list-style-type: none"> ■ Verify that the line extender is receiving the proper forward RF input signal from the upstream equipment. <p>Important: You cannot balance the line extender without the proper forward RF input signal.</p>

Possible cause	Solution
There is a proper forward RF signal at the forward input test point, but a low or degraded signal at one or all of the forward output test points.	<ul style="list-style-type: none">■ Verify that the line extender module is receiving the proper DC voltages. Refer to <i>No DC Power</i> (on page 87).■ Verify that switch S1 is in the proper position for your line extender module configuration. Refer to <i>Balancing and Setup</i> (on page 41) for more information.■ Verify that all the proper accessories, pads, EQs, and signal directors (if applicable) are firmly installed in the correct locations.■ Verify that the factory installed accessories are firmly installed in the correct locations. Note: Verifying factory installations involves removing the line extender module cover. Reinstall the line extender module cover properly or RF signal degradation may result.■ Replace the line extender module.

No Reverse RF Signal

The reverse RF signal can be measured at the line extender module reverse input and reverse output test points.

No Reverse RF Signal Troubleshooting Table

Before you begin troubleshooting for no reverse RF signal, verify that the line extender is receiving the proper reverse RF input signals from the downstream line extender at the line extender reverse input test point.

Important: You cannot balance the line extender without the proper reverse RF input signals.

Possible cause	Solution
No reverse RF signal at the reverse input test point.	<ul style="list-style-type: none"> ■ Verify that the line extender is receiving the proper reverse RF input signals from the downstream line extender. <p>Important: You cannot balance the line extender without the proper reverse RF input signals.</p>
There is a proper reverse RF signal at the reverse input test point, but no signal at the reverse output test point.	<ul style="list-style-type: none"> ■ Verify that the line extender module is receiving the proper AC and DC voltages. Refer to <i>No AC Power</i> (on page 85) and <i>No DC Power</i> (on page 87). ■ Verify that the line extender module is receiving the proper forward RF signal. Refer to <i>No Forward RF Signal</i> (on page 89). ■ Verify that all the proper accessories, pads, and EQs are firmly installed in the correct locations. ■ Verify that the factory installed accessories are firmly installed in the correct locations. ■ Verify that the reverse switch (if applicable) or its jumpers are properly and firmly installed. <p>Note: Verifying factory installations involves removing the line extender module cover. Reinstall the line extender module cover properly or RF signal degradation may result.</p> <ul style="list-style-type: none"> ■ Replace the line extender module.

Low or Degraded Reverse RF Signal

The reverse RF signal can be measured at the line extender module reverse input and reverse output test points.

Low or Degraded Reverse RF Signal Troubleshooting Table

Before you begin troubleshooting for a low or degraded reverse RF signal, verify that the line extender is receiving the proper reverse RF input signals from the downstream line extender at the line extender reverse input test point.

Important! You cannot balance the line extender without the proper reverse RF input signals.

Make sure you have configured the line extender module according to the specifications in the design print, and that the line extender has warmed up for approximately one hour.

Make sure you are using the proper total tilt reference when setting receive levels. Refer to the reverse equalizer charts in *Technical Information* (on page 97) for more information.

Important! If the line extender cover was ever removed, make sure it was properly reinstalled. Improperly reinstalling the line extender module cover may result in RF signal degradation.

Possible cause	Solution
Low or degraded reverse RF signal at the reverse input test point.	<ul style="list-style-type: none"> ■ Verify that the line extender is receiving the proper reverse RF input signals from the downstream line extender. <p>Important! You cannot balance the line extender without the proper reverse RF input signals.</p>

Possible cause	Solution
<p>There are proper reverse RF signals at the reverse input test point, but a low or degraded signal at the reverse output test point.</p>	<ul style="list-style-type: none"> ■ Verify that the line extender module is receiving the proper DC voltages. Refer to <i>No DC Power</i> (on page 87). ■ Measure the main reverse input test point and the reverse output test point. Subtract the reverse amplifier gain and add the pad values and EQ insertion loss to verify proper reverse amplifier gain. ■ Verify that all the proper accessories, pads, EQs, and signal directors (if applicable) are firmly installed in the correct locations. ■ Verify that the factory installed accessories are firmly installed in the correct locations. ■ Verify that the reverse switch and its jumpers are properly and firmly installed. <p>Note: Verifying factory installations involves removing the line extender module cover. Reinstall the line extender module cover properly or RF signal degradation may result.</p>
<p>Reverse RF signal still low or degraded.</p>	<ul style="list-style-type: none"> ■ Use a spectrum analyzer to look at the reverse RF input signal spectral quality at each reverse input test point and compare it to the reverse RF output signal spectral quality. <ul style="list-style-type: none"> – If degradation is generated in the reverse amplifier, replace the reverse amplifier. – If degradation is generated by the downstream line extender reverse RF signal, troubleshoot the line extender feeding this station. ■ Replace the line extender module.

5

Customer Support Information

If You Have Questions

If you have technical questions, call Cisco Services for assistance. Follow the menu options to speak with a service engineer.

Access your company's extranet site to view or order additional technical publications. For accessing instructions, contact the representative who handles your account. Check your extranet site often as the information is updated frequently.

A

Technical Information

In This Appendix

- “Linear” Tilt Charts 98
- Forward Cable Equalizer Charts 101
- Reverse Cable Equalizer Charts..... 104

Introduction

This appendix contains tilt, forward and reverse equalizer charts and pad values.

“Linear” Tilt Charts

Line Extender Output “Linear” Tilt Chart for 1.2 GHz

The following chart can be used to determine the operating level at a particular frequency considering the operating linear tilt.

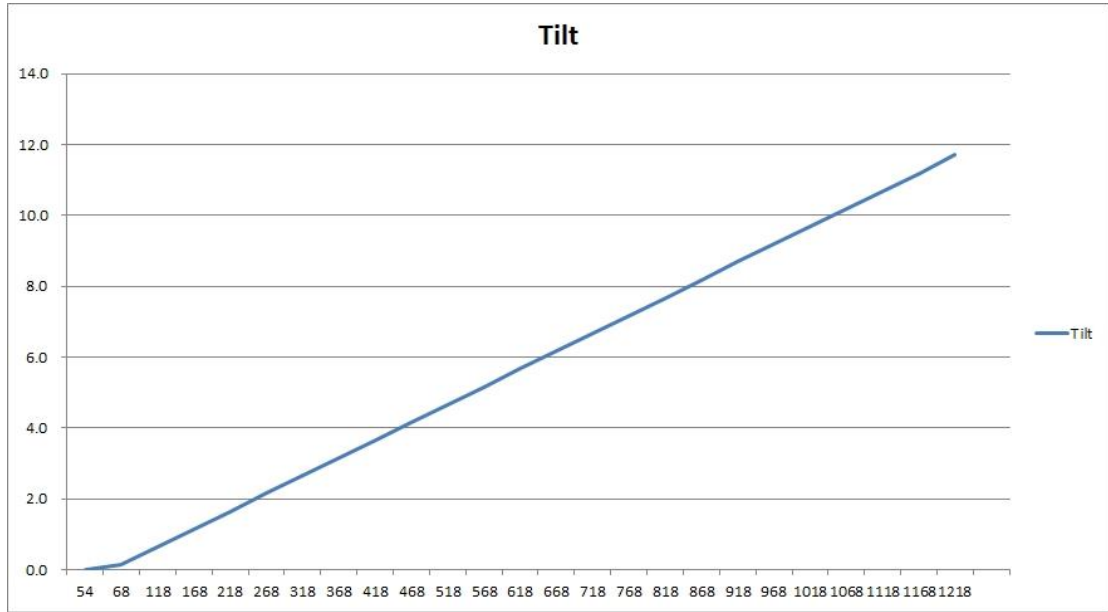

Line Extender Output “Linear” Tilt Chart for 1 GHz

The following chart can be used to determine the operating level at a particular frequency considering the operating linear tilt.

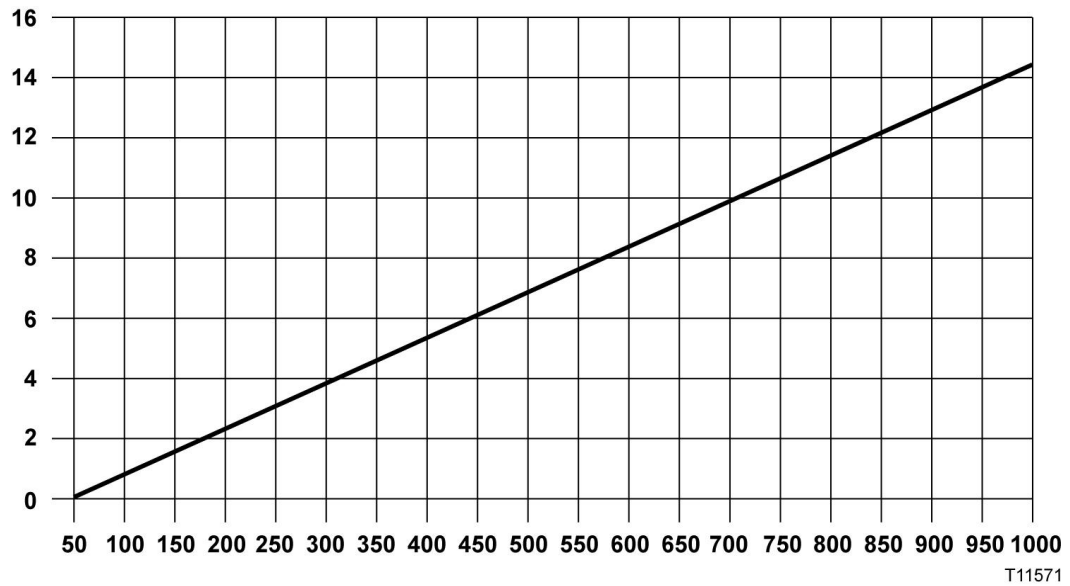

Example: If the line extender’s 1 GHz output level is 49.0 dBmV with a linear operating tilt of 14.5 dB (from 50 to 1 GHz), the corresponding output level at 750 MHz would be 45.1 dBmV. This was found by taking the difference in tilt between 1 GHz and 750 MHz ($14.5 - 10.6 = 3.9$ dB). Then subtract the difference in tilt from the operating level ($49.0 - 3.9 = 45.1$ dBmV).

Line Extender Output “Linear” Tilt Chart for 870 MHz

The following chart can be used to determine the operating level at a particular frequency considering the operating linear tilt.

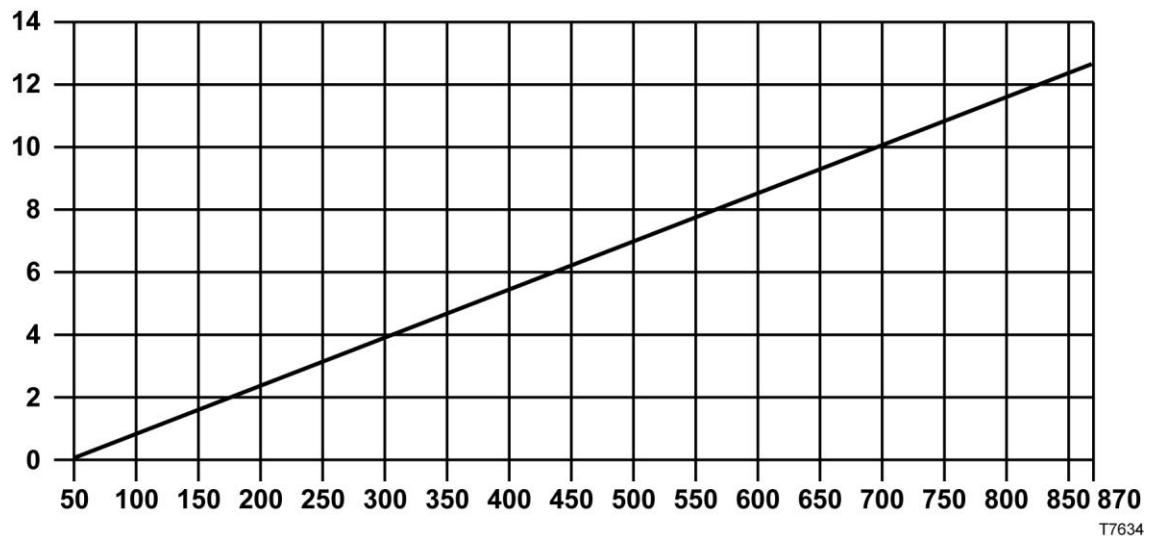

Example: If the line extender’s 870 MHz output level is 47.5 dBmV with a linear operating tilt of 12.5 dB (from 50 to 870 MHz), the corresponding output level at 650

Appendix A
Technical Information

MHz would be 44 dBmV. This was found by taking the difference in tilt between 870 and 650 MHz ($12.5 - 9 = 3.5$ dB). Then subtract the difference in tilt from the operating level ($47.5 - 3.5 = 44$ dBmV).

Forward Cable Equalizer Charts

1.2 GHz Forward Cable Equalizer Loss Chart

The following chart shows the 1.2 GHz forward cable equalizer loss.

EQ Value (dB)	Insertion Loss at (MHz)										Total Tilt (52-1218 MHz)
	1218	1100	1002	870	750	650	600	86	70	52	
1.5	1.0	1.1	1.2	1.3	1.4	1.4	1.5	2.1	2.2	2.2	1.2
3.0	1.0	1.2	1.3	1.5	1.7	1.9	2.0	3.3	3.4	3.5	2.5
4.5	1.0	1.3	1.5	1.8	2.1	2.4	2.5	4.4	4.6	4.7	3.7
6.0	1.0	1.3	1.6	2.1	2.5	2.8	3.0	5.6	5.7	5.9	4.9
7.5	1.0	1.4	1.8	2.3	2.8	3.2	3.5	6.7	6.9	7.2	6.2
9.0	1.0	1.5	2.0	2.6	3.2	3.7	4.0	7.9	8.1	8.4	7.4
10.5	1.0	1.6	2.1	2.9	3.6	4.2	4.5	9.0	9.3	9.6	8.6
12.0	1.0	1.7	2.3	3.1	3.9	4.6	5.0	10.2	10.5	10.8	9.8
13.5	1.0	1.8	2.4	3.4	4.3	5.1	5.5	11.3	11.7	12.1	11.1
15.0	1.0	1.9	2.6	3.6	4.6	5.5	6.0	12.5	12.9	13.3	12.3
16.5	1.0	1.9	2.8	3.9	5.0	6.0	6.5	13.7	14.0	14.5	13.5
18.0	1.0	2.0	2.9	4.2	5.4	6.4	7.0	14.8	15.2	15.8	14.8
19.5	1.0	2.1	3.1	4.4	5.7	6.9	7.5	16.0	16.4	17.0	16.0
21.0	1.0	2.2	3.2	4.7	6.1	7.3	8.0	17.1	17.6	18.2	17.2
22.5	1.5	2.8	3.9	5.5	7.0	8.3	9.0	18.8	19.3	20.0	18.5
24.0	1.5	2.9	4.1	5.7	7.3	8.8	9.5	19.9	20.5	21.2	19.7
25.5	1.5	3.0	4.2	6.0	7.7	9.2	10.0	21.1	21.7	22.4	20.9
27.0	1.5	3.0	4.4	6.3	8.1	9.7	10.5	22.2	22.8	23.6	22.1
28.5	1.5	3.1	4.5	6.5	8.4	10.1	11.0	23.4	24.0	24.9	23.4
30.0	1.5	3.2	4.7	6.8	8.8	10.6	11.5	24.5	25.2	26.1	24.6

1 GHz Forward Cable Equalizer Loss Chart

The following chart shows the 1 GHz forward cable equalizer loss.

EQ Value (dB)	Insertion Loss at (MHz)									Total Tilt (52-1000 MHz)
	1000	870	750	650	600	550	86	70	52	
1.5	1.0	1.1	1.2	1.3	1.4	1.4	2.1	2.2	2.2	1.2
3.0	1.0	1.2	1.5	1.7	1.8	1.9	3.2	3.3	3.4	2.4
4.5	1.0	1.4	1.7	2.0	2.1	2.3	4.3	4.4	4.6	3.6
6.0	1.0	1.5	1.9	2.3	2.5	2.7	5.4	5.6	5.8	4.8
7.5	1.0	1.6	2.1	2.6	2.9	3.2	6.5	6.7	7.0	6.0
9.0	1.0	1.7	2.4	3.0	3.3	3.6	7.7	7.9	8.2	7.2
10.5	1.0	1.8	2.6	3.3	3.7	4.0	8.8	9.0	9.4	8.4
12.0	1.0	1.9	2.8	3.6	4.0	4.5	9.9	10.2	10.6	9.6
13.5	1.0	2.0	3.1	3.9	4.4	4.9	11.0	11.3	11.8	10.8
15.0	1.0	2.2	3.3	4.3	4.8	5.3	12.1	12.5	13.0	12.0
16.5	1.0	2.3	3.5	4.6	5.2	5.8	13.2	13.6	14.2	13.2
18.0	1.0	2.4	3.7	4.9	5.5	6.2	14.3	14.8	15.4	14.4
19.5	1.0	2.5	4.0	5.3	5.9	6.6	15.4	15.9	16.6	15.6
21.0	1.0	2.6	4.2	5.6	6.3	7.1	16.5	17.1	17.8	16.8
22.5	1.5	3.2	4.9	6.4	7.2	8.0	18.1	18.7	19.5	18.0
24.0	1.5	3.4	5.2	6.7	7.6	8.4	19.2	19.9	20.7	19.2
25.5	1.5	3.5	5.4	7.1	7.9	8.8	20.3	21.0	21.9	20.4
27.0	1.5	3.6	5.6	7.4	8.4	9.3	21.5	22.2	23.1	21.6
28.5	1.5	3.7	5.8	7.7	8.7	9.7	22.6	23.3	24.3	22.8
30.0	1.5	3.8	6.1	8.0	9.1	10.1	23.7	24.5	25.5	24.0

870 MHz Forward Cable Equalizer Loss Chart

The following table shows the 870 MHz forward cable equalizer loss.

EQ Value (dB)	Insertion Loss at (MHz)									Total Tilt (52-870 MHz)
	870	750	600	550	450	300	216	108	52	
1.5	1.0	1.1	1.3	1.3	1.5	1.7	1.8	2.0	2.2	1.2
3.0	1.0	1.2	1.6	1.7	1.9	2.3	2.6	3.0	3.3	2.3
4.5	1.0	1.4	1.9	2.0	2.4	3.0	3.4	4.1	4.5	3.5
6.0	1.0	1.5	2.1	2.4	2.9	3.7	4.2	5.1	5.7	4.7
7.5	1.0	1.6	2.4	2.7	3.3	4.4	5.0	6.1	6.9	5.9
9.0	1.0	1.7	2.7	3.1	3.8	5.0	5.8	7.1	8.1	7.1
10.5	1.0	1.8	3.0	3.4	4.3	5.7	6.6	8.1	9.2	8.2
12.0	1.0	2.0	3.3	3.7	4.7	6.4	7.5	9.2	10.4	9.4
13.5	1.0	2.1	3.6	4.1	5.2	7.0	8.3	10.2	11.6	10.6
15.0	1.0	2.2	3.8	4.4	5.6	7.7	9.1	11.2	12.8	11.8
16.5	1.0	2.3	4.1	4.8	6.1	8.4	9.9	12.2	13.9	12.9
18.0	1.0	2.5	4.4	5.1	6.6	9.1	10.7	13.3	15.1	14.1
19.5	1.0	2.6	4.7	5.5	7.0	9.7	11.5	14.3	16.3	15.3
21.0	1.0	2.7	5.0	5.8	7.5	10.4	12.3	15.3	17.5	16.5
22.5	1.0	2.8	5.3	6.1	8.0	11.1	13.1	16.3	18.6	17.6
24.0	1.0	2.9	5.6	6.5	8.4	11.7	13.9	17.3	19.8	18.8
25.5	1.0	3.1	5.8	6.8	8.9	12.4	14.7	18.4	21.0	20.0
27.0	1.0	3.2	6.1	7.2	9.4	13.1	15.5	19.4	22.2	21.2

Reverse Cable Equalizer Charts

42 MHz and 40 MHz Reverse Cable Equalizer Loss Chart

The following table shows the 42 MHz reverse cable equalizer loss.

Note: The 42 MHz reverse equalizer also works as a 40 MHz reverse equalizer in systems that use 5-40 MHz reverse amplifiers.

EQ Value	EQ Value	Insertion Loss at (MHz)									Total Tilt (5-42 MHz)	Total Tilt (5-40 MHz)
		42	40	35	30	25	20	15	10	5		
1	1	1.0	1.0	1.1	1.1	1.2	1.3	1.4	1.5	1.7	0.7	0.7
2	2	1.0	1.0	1.1	1.3	1.4	1.6	1.8	2.0	2.3	1.3	1.3
3.1	3	0.9	1.0	1.2	1.4	1.6	1.9	2.2	2.5	3.0	2.1	2.0
4.1	4	0.9	1.0	1.3	1.6	1.9	2.2	2.6	3.0	3.6	2.7	2.6
5.1	5	0.9	1.0	1.3	1.7	2.1	2.5	3.0	3.5	4.3	3.4	3.3
6.1	6	0.9	1.0	1.4	1.8	2.3	2.8	3.4	4.1	4.9	4.0	3.9
7.2	7	0.8	1.0	1.5	2.0	2.5	3.1	3.8	4.6	5.6	4.8	4.6
8.2	8	0.8	1.0	1.5	2.1	2.7	3.4	4.2	5.1	6.2	5.4	5.2
9.2	9	0.8	1.0	1.6	2.2	2.9	3.7	4.6	5.6	6.9	6.1	5.9
10.2	10	0.8	1.0	1.7	2.4	3.2	4.0	5.0	6.1	7.5	6.7	6.5
11.3	11	0.7	1.0	1.7	2.5	3.4	4.3	5.4	6.6	8.2	7.5	7.2
12.3	12	0.7	1.0	1.8	2.7	3.6	4.6	5.8	7.1	8.9	8.2	7.9

55 MHz Reverse Cable Equalizer Loss Chart

The following table shows the 55 MHz reverse cable equalizer loss.

EQ Value	Insertion Loss at (MHz)											Total Tilt
(dB)	55	50	45	40	35	30	25	20	15	10	5	(5-55 MHz)
1	1	1.0	1.1	1.2	1.2	1.3	1.3	1.4	1.5	1.6	1.7	0.7
2	1	1.1	1.2	1.3	1.4	1.5	1.7	1.8	2.0	2.2	2.4	1.4
3	1	1.1	1.3	1.4	1.6	1.8	2.0	2.2	2.4	2.7	3.1	2.1
4	1	1.2	1.4	1.6	1.8	2.1	2.3	2.6	3.0	3.3	3.8	2.8
5	1	1.2	1.5	1.7	2.0	2.3	2.6	3.0	3.4	3.9	4.5	3.5
6	1	1.3	1.6	1.9	2.3	2.6	3.0	3.4	3.9	4.5	5.2	4.2
7	1	1.3	1.7	2.0	2.5	2.9	3.3	3.8	4.4	5.1	5.9	4.9
8	1	1.4	1.8	2.2	2.7	3.2	3.7	4.3	4.9	5.7	6.7	5.7
9	1	1.4	1.9	2.3	2.9	3.4	4.0	4.7	5.4	6.2	7.4	6.4
10	1	1.5	2.0	2.5	3.1	3.7	4.3	5.1	5.9	6.8	8.1	7.1
11	1	1.5	2.1	2.6	3.3	3.9	4.7	5.5	6.4	7.4	8.8	7.8
12	1	1.6	2.2	2.8	3.5	4.2	5.0	5.9	6.9	8.0	9.5	8.5

65 MHz Reverse Cable Equalizer Loss Chart

The following table shows the 65 MHz reverse cable equalizer loss.

EQ Value	Insertion Loss at (MHz)													Total Tilt
(dB)	65	60	55	50	45	40	35	30	25	20	15	10	5	(5-65 MHz)
1	1	1.0	1.1	1.1	1.2	1.2	1.3	1.3	1.4	1.5	1.5	1.6	1.7	0.7
2	1	1.1	1.2	1.2	1.3	1.4	1.5	1.6	1.7	1.9	2.0	2.2	2.5	1.5
3	1	1.1	1.3	1.4	1.5	1.7	1.8	2.0	2.2	2.4	2.6	2.9	3.2	2.2
4	1	1.2	1.4	1.5	1.7	1.9	2.1	2.3	2.6	2.8	3.1	3.5	3.9	2.9
5	1	1.2	1.4	1.6	1.9	2.1	2.4	2.7	3.0	3.3	3.7	4.1	4.7	3.7
6	1	1.3	1.5	1.8	2.0	2.3	2.7	3.0	3.3	3.7	4.2	4.7	5.4	4.4
7	1	1.3	1.6	1.9	2.2	2.5	2.9	3.3	3.6	4.2	4.7	5.3	6.1	5.1
8	1	1.3	1.7	2.0	2.4	2.8	3.2	3.6	4.1	4.7	5.2	5.9	6.9	5.9
9	1	1.4	1.8	2.2	2.6	3.0	3.5	4.0	4.5	5.1	5.8	6.6	7.6	6.6
10	1	1.4	1.8	2.3	2.7	3.2	3.7	4.3	4.9	5.5	6.3	7.2	8.3	7.3
11	1	1.4	1.9	2.4	2.9	3.5	4.0	4.6	5.3	6.0	6.8	7.8	9.0	8.0
12	1	1.5	2.0	2.5	3.1	3.7	4.3	5.0	5.7	6.5	7.4	8.4	9.8	8.8

Glossary

A

ampere. A unit of measure for electrical current.

ac, AC

alternating current. An electric current that reverses its direction at regularly recurring intervals.

AGC

automatic gain control. A process or means by which gain is automatically adjusted in a specified manner as a function of input level or other specified parameters.

CW

continuous wave.

dB

decibel. One tenth of a bel, the number of decibels denoting the ratio of two amounts of power being ten times the common logarithm of this ratio.

dBc

decibels relative to a reference carrier.

dBm

decibels relative to 1 milliwatt.

dBmV

decibels relative to 1 millivolt.

dBW

decibels relative to 1 watt.

dc, DC

direct current. An electric current flowing in one direction only and substantially constant in

Glossary

value.

EMC

electromagnetic compatibility. A measure of equipment tolerance to external electromagnetic fields.

EQ

equalizer.

equalization

The process of compensating for an undesired result. For example, equalizing tilt in a distribution system.

FCC

Federal Communications Commission. Federal organization set up by the Communications Act of 1934 which has authority to regulate all inter-state (but not intra-state) communications originating in the United States (radio, television, wire, satellite, and cable).

ft-lb

foot-pound. A measure of torque defined by the application of one pound of force on a lever at a point on the lever that is one foot from the pivot point.

gain

A measure of the increase in signal level, relative to a reference, in an amplifier. Usually expressed in decibels.

GHz

Gigahertz. A unit of frequency equal to one billion cycles per second.

Hertz

A unit of frequency equal to one cycle per second.

I/O

input/output.

in-lb

inch-pound. A measure of torque defined by the application of one pound of force on a lever at a point on the lever that is one inch from the pivot point.

LE

line extender.

LED

light-emitting diode. An electronic device that lights up when electricity passes through it.

Mbps

megabits per second. A unit of measure representing a rate of one million bits (megabits) per second.

MHz

megahertz. A unit of measure representing one million cycles per second; measures bandwidth.

N-cm

Newton centimeter

Nm

Newton meter. A measure of torque defined by the application of one Newton of force on a lever at a point on the lever that is one meter from the pivot point. (1 Nm = 0.737561 ft-lb)

PWB

printed wiring board.

RF

radio frequency. The frequency in the portion of the electromagnetic spectrum that is above the audio frequencies and below the infrared frequencies, used in radio transmission systems.

RMA

return material authorization. A form used to return products.

RX

receive or receiver.

S/N or SNR

signal-to-noise ratio. The ratio, in decibels, of the maximum peak-to-peak voltage of the video signal, including synchronizing pulse, to the root-mean-square voltage of the noise. Provides

Glossary

a measure and indication of signal quality.

SA

system amplifier.

torque

A force that produces rotation or torsion. Usually expressed in lb-ft (pound-feet) or N-m (Newton-meters). The application of one pound of force on a lever at a point on the lever that is one foot from the pivot point would produce 1 lb-ft of torque.

TX

transmit or transmitter.

V

volt.

V AC

volts alternating current.

V DC

volts direct current.

W

watt. A measure of electrical power required to do work at the rate of one joule per second. In a purely resistive load, 1 Watt = 1 Volt x 1 Amp.

Index

1

1 GHz Forward Cable Equalizer Loss Chart • 101, 102

4

42 MHz and 40 MHz Reverse Cable Equalizer Loss Chart • 104

5

55 MHz Reverse Cable Equalizer Loss Chart • 105

6

65 MHz Reverse Cable Equalizer Loss Chart • 106

8

870 MHz Forward Cable Equalizer Loss Chart • 103

A

A • 107

About Reverse Path Balancing • 76

AC Shunt Power Directors • 6

ac, AC • 107

AGC • 107

Amplifier Module Cover • 13

Amplifier Output • 98, 99

Attaching the Coaxial Connectors • 24

B

Balancing and Setup • 41

Balancing the Forward Path • 47

Balancing the Reverse Path • 76

Before You Begin • 12

Block Diagrams • 9

C

Closing the Node Housing • 40

Configuration • 4

Customer Support Information • 95

CW • 107

D

dB • 107

dBc • 107

dBm • 107

dBmV • 107

dBW • 107

dc, DC • 107

Description • 3

E

EMC • 108

EQ • 108

equalization • 108

Index

Equipment • 84

F

FCC • 108

Forward Cable Equalizer Charts • 101

Forward Path Balancing for AGC Stations Using Manual Setup Mode • 47

Forward Path Balancing for AGC Stations Using Thermal Setup Mode • 57

Forward Path Balancing for Manual Stations • 72

Forward Path Balancing for Thermal Stations Using Amplifier and Coax Compensation Mode • 68

Forward Path Balancing for Thermal Stations Using Amplifier Only Compensation Mode • 65

Forward Path Balancing Using Trim Networks • 74

ft-lb • 108

G

gain • 108

GainMaker Amplifier Ordering Matrix • 6

GainMaker Line Extender Characteristics • 3

GHz • 108

H

Hertz • 108

Housing Dimensions • 13

I

I/O • 108

Illustrations • 7

in-lb • 108

Input and Output Ports • 4

Installation and Configuration • 11

Installing Accessories • 28

Installing the Amplifier Module • 33

Installing the Housing • 25

Installing the Power Supply • 20

Introduction • 1

L

LE • 109

LED • 109

Line Extender Accessories • 8

Line Extender Test Points • 7

Low or Degraded Forward RF Signal • 90

Low or Degraded Forward RF Signal Troubleshooting Table • 90

Low or Degraded Reverse RF Signal • 93

Low or Degraded Reverse RF Signal Troubleshooting Table • 93

M

Manual Backoff Chart • 49

Mbps • 109

MHz • 109

Module and Housing Compatibility • 13

N

N-cm • 109

Nm • 109

No AC Power • 85

No AC Power Troubleshooting Table • 86
 No DC Power • 87
 No DC Power Troubleshooting Table • 88
 No Forward RF Signal • 89
 No Forward RF Signal Troubleshooting Table • 89
 No Reverse RF Signal • 92
 No Reverse RF Signal Troubleshooting Table • 92

O

Opening the Node Housing • 15

P

Power Supply • 4
 Preparing for Forward Path Balancing • 42
 PWB • 109

R

Removing and Installing AC Shunt Power Directors • 38
 Removing the Amplifier Module from the Housing • 36
 Required Tools • 12
 Reverse Cable Equalizer Charts • 104
 Reverse Path Balancing, About • 76
 RF • 109
 RMA • 109
 RX • 109

S

S/N or SNR • 109

SA • 110
 Switch S1 Positions for AGC Stations • 43
 Switch S1 Positions for Manual Stations • 44
 Switch S1 Positions for Thermal Stations • 44

T

Test Points • 4
 To Align the AGC Module • 53, 61
 To Calculate the Proper RF Signal Level • 79
 To Close the Node Housing • 40
 To Complete Reverse Path Balancing • 80
 To Connect the Coaxial Cable Pin Connector to the Node Housing • 24
 To Determine the Output Tilt • 51, 58, 66, 69, 72
 To Install a Trim Network • 74
 To Install Attenuator Pads • 28
 To Install Equalizers • 29
 To Install the Amplifier Module • 33
 To Install the Housing in a Pedestal • 26
 To Install the Housing on a Strand (Aerial) • 25
 To Install the New Housing Lid • 18
 To Install the New Housing Seizures • 16
 To Install the Power Supply Module • 20
 To Install the Surge Protector • 30
 To Open the Node Housing • 15
 To Prepare the Amplifier for Reverse Path Balancing • 78
 To Remove and Install AC Shunt Power Directors • 38
 To Remove the Amplifier Module • 36

Index

To Select the AGC Pad Value • 53, 61

To Select the Forward Path Balancing Procedure
• 47

To Set Switch S1 for Amplifier and Coax
Compensation Mode • 68

To Set Switch S1 for Amplifier Only
Compensation Mode • 65

To Set Switch S1 for Thermal Setup Mode • 57

To Set the AC Undervoltage Lockout Selector •
22

To Set the Manual Backoff Level • 48

To Set the Output Level • 52, 60, 68, 71, 74

To Set the Output Tilt • 51, 59, 67, 70, 73

To Set Up Automatic Gain Control • 52, 60

To Trim the Center Conductor • 24

To Verify the Input Signal Level • 45

torque • 110

Torque Specifications • 12

Torquing Sequence • 40

Troubleshooting • 83

TX • 110

U

Understanding Switch S1 Functions • 42

Upgrading an Existing Housing Lid • 18

Upgrading Existing Housing Seizures • 16

V

V • 110

V AC • 110

V DC • 110

W

W • 110



Americas Headquarters

Cisco Systems, Inc.
170 West Tasman Drive
San Jose, CA 95134-1706
USA

<http://www.cisco.com>
Tel: 408 526-4000
800 553-6387
Fax: 408 527-0883

Cisco and the Cisco logo are trademarks or registered trademarks of Cisco and/or its affiliates in the U.S. and other countries. To view a list of Cisco trademarks, go to this URL:

www.cisco.com/go/trademarks

Third party trademarks mentioned are the property of their respective owners.

The use of the word partner does not imply a partnership relationship between Cisco and any other company. (1110R)

Product and service availability are subject to change without notice.

© 2016 Cisco and/or its affiliates. All rights reserved.

First Published: January 2016