









Cisco RF Gateway 1 Remote Provisioning Utility (RPU) User Guide

For Your Safety

Explanation of Warning and Caution Icons

Avoid personal injury and product damage! Do not proceed beyond any symbol until you fully understand the indicated conditions.

The following warning and caution icons alert you to important information about the safe operation of this product:

-  You may find this symbol in the document that accompanies this product. This symbol indicates important operating or maintenance instructions.
-  You may find this symbol affixed to the product. This symbol indicates a live terminal where a dangerous voltage may be present; the tip of the flash points to the terminal device.
-  You may find this symbol affixed to the product. This symbol indicates a protective ground terminal.
-  You may find this symbol affixed to the product. This symbol indicates a chassis terminal (normally used for equipotential bonding).
-  You may find this symbol affixed to the product. This symbol warns of a potentially hot surface.
-  You may find this symbol affixed to the product and in this document. This symbol indicates an infrared laser that transmits intensity-modulated light and emits invisible laser radiation or an LED that transmits intensity-modulated light.

Important

Please read this entire guide. If this guide provides installation or operation instructions, give particular attention to all safety statements included in this guide.

Notices

Trademark Acknowledgments

Cisco and the Cisco logo are trademarks or registered trademarks of Cisco and/or its affiliates in the U.S. and other countries. To view a list of Cisco trademarks, go to this URL: www.cisco.com/go/trademarks.

Third party trademarks mentioned are the property of their respective owners.

The use of the word partner does not imply a partnership relationship between Cisco and any other company. (1110R)

Publication Disclaimer

Cisco Systems, Inc. assumes no responsibility for errors or omissions that may appear in this publication. We reserve the right to change this publication at any time without notice. This document is not to be construed as conferring by implication, estoppel, or otherwise any license or right under any copyright or patent, whether or not the use of any information in this document employs an invention claimed in any existing or later issued patent.

Copyright

© 2010, 2013 Cisco and/or its affiliates. All rights reserved.

Information in this publication is subject to change without notice. No part of this publication may be reproduced or transmitted in any form, by photocopy, microfilm, xerography, or any other means, or incorporated into any information retrieval system, electronic or mechanical, for any purpose, without the express permission of Cisco Systems, Inc.

Contents

Safe Operation for Software Controlling Optical Transmission Equipment v

Chapter 1 Introduction 1

Features and Benefits.....	2
Primary Benefits.....	2

Chapter 2 Provisioning 3

Before You Begin.....	4
Provisioning Overview	5
Reference Database.....	5
SDV Design File	6

Chapter 3 Installation and General Operation 17

Installing the RPU	18
Initial Provisioning Mode	21
Importing Provisioning Parameters.....	21
Configure RPU Repository Location (Phase 1 Step 1a).....	21
Creating Reference Database (Phase 1 Step 1b).....	22
Importing Reference Database (Phase 1 Step 1c)	23
Importing SDV Design File Spreadsheet (Phase 1 Step 1d).....	24
Creating Databases and Programming the RFGW-1	26
Verifying SDV Design File Spreadsheet Configuration Data (Phase 2 Step 2a)	26
Creating RFGW-1 Configuration Database (Phase 2 Step 2b).....	27
Programming the RFGW-1 with Configuration Database (Phase 2 Step 2c)	28
Verifying RFGW Programming Data (Phase 2 Step 2d)	29
Generating the JSON File (Phase 2 Step 2e)	31
RFGW-1 Bulk Provisioning	34
Set Port Power/Port Control Levels (Step 3a).....	34
Set Combined Channels (Phase 3 Step 3b)	35
Set Channel Mute.....	36
RPU Menu Options.....	38
File Menu	38
View Menu.....	38
Configure Menu	39
Help Menu	41

Contents

Chapter 4 Customer Support Information	43
Glossary	45
Index	49

Safe Operation for Software Controlling Optical Transmission Equipment

If this document discusses software, the software described is used to monitor and/or control ours and other vendors' electrical and optical equipment designed to transmit video, voice, or data signals. Certain safety precautions must be observed when operating equipment of this nature.

For equipment specific safety requirements, refer to the appropriate section of the equipment documentation.

For safe operation of this software, refer to the following warnings.

**WARNING:**

- **Ensure that all optical connections are complete or terminated before using this equipment to remotely control a laser device. An optical or laser device can pose a hazard to remotely located personnel when operated without their knowledge.**
- **Allow only personnel trained in laser safety to operate this software. Otherwise, injuries to personnel may occur.**
- **Restrict access of this software to authorized personnel only.**
- **Install this software in equipment that is located in a restricted access area.**

1

Introduction

Overview

The Cisco RF Gateway 1 (RFGW-1) Remote Provisioning Utility (RPU) is a Windows-based tool designed to simplify initial provisioning of multiple RFGW-1 units in an operator's system.

Purpose

This user guide provides the necessary information to install, operate, maintain, and upgrade the RPU application.

Who Should Use This Document

This document is intended for authorized service personnel who have experience working with the RFGW-1 or similar equipment. The service personnel should have appropriate background and knowledge to complete the procedures described in this document.

Qualified Personnel

Only appropriately qualified and skilled personnel should attempt to install, operate, maintain, and service this product.



WARNING:

Allow only qualified and skilled personnel to install, operate, maintain, and service this product. Otherwise, personal injury or equipment damage may occur.

In This Chapter

- Features and Benefits 2

Features and Benefits

Primary Benefits

The RPU provides the following benefits:

- Enables mass initial provisioning of RFGW-1 databases in SDV deployments. Provisioning of 48 and 96 channel RFGW-1 hardware configurations is supported.
- Enables mass upgrade provisioning of RFGW-1 databases from 48 channels to 96 channels.
- Enables bulk provisioning of run-time port and channel control settings.
- Generates configuration files in JavaScript Object Notation (JSON) format for export.

2

Provisioning

This chapter describes the components for provisioning the RPU.

In This Chapter

- Before You Begin..... 4
- Provisioning Overview 5

Before You Begin

Before you begin, make sure to check the following:

- Your server is running Windows XP or Windows 7.
- Microsoft Office Excel 97 or later must be installed on the server.
- You have the RPU distribution CD or have downloaded the RPU installer.
- You can connect to the Cisco product server.

Provisioning Overview

The RPU merges a common reference database with unique parameters such as IP address, Transport Stream Identifier (TSID), and frequency information from a SDV Design File to generate and distribute configuration files for each RFGW-1. These operations can also be performed on a per-QAM basis by accessing the embedded Web GUI of the RFGW-1.

The following diagram provides an overview of the RPU application.

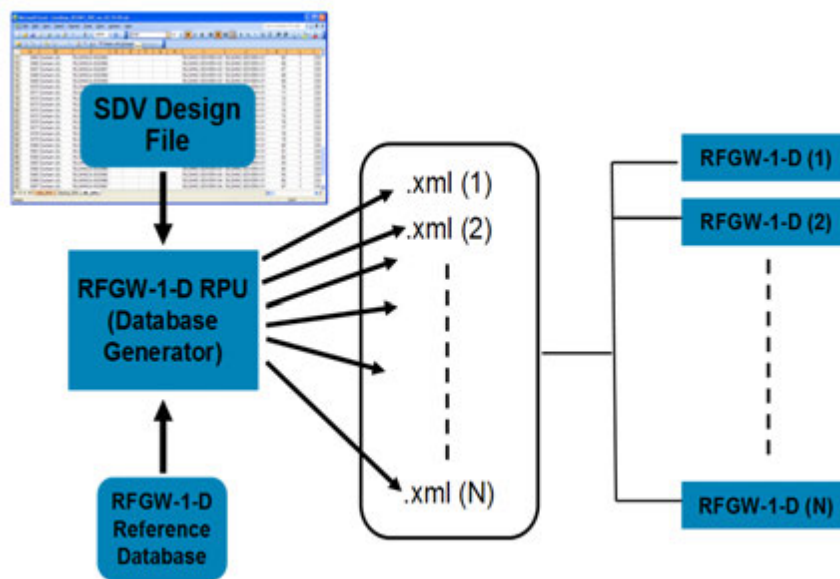

The RFGW-1 provisioning parameters are stored internally in .xml database format. The provisioning parameters are usually manipulated either using the Web GUI or via SNMP sets.

The RPU uses provisioning data configured in an SDV Design File to create the internal .xml RFGW-1 database files. The SDV Design File uses a Microsoft Excel spreadsheet. The RPU accesses the SDV Design File and creates RFGW-1 formatted database files. These database files are then uploaded via FTP to the RFGW-1.

Reference Database

The Reference Database is used by the RPU as a template for all RFGW-1 initial provisioning settings not configured by the RPU. The Reference Database is configured via the Web GUI by the customer on an arbitrarily selected "reference" RFGW-1. The RPU imports the database files from the reference RFGW-1. These database files will then be used by the RPU to create the database files for each RFGW-1 selected.

SDV Design File

SDV Design Files are commonly used by SDV customers to maintain an accounting of configuration parameters and service group associations for the various devices in the network. The SDV Design File was originally conceived to capture legacy SDV Server/GQAM networks in a single common file that could be shared between Cisco network engineering and customers. The SDV Design File now supports USRM and RFGW-1.

SDV Design Files have multiple tabs offering various perspectives of how SDV equipment is arranged hierarchically into headends, hubs, and service groups. Generally, there is a single tab that itemizes all hubs in a network by location name, followed by a series of sheets detailing the QAM/service group associations including frequency, and TSID assignments.

1st Generation SDV Design File

The following worksheet shows a GQAM arrangement in the 1st generation SDV Design File. To capture the striping plan of various physical RF ports, GQAM chassis are organized in columns (vertically), while service groups are organized across rows (horizontally).

Durham (A)										
Service Groups				GQAMs				GbE Switch/Router		
3	SG Name/ID	servicegroup1	1	Name	RLGHNCAGQM001	RLGHNCAGQM002	RLGHNCAGQM003	Device Name	RLGHN	
4	GQAM Comb.	1		IP (Mgt)	172.16.4.120	172.16.4.121	172.16.4.122	Mgt Switch Name	RLGHN	
5	SG DHCTs	305		IP (Video)	12.1.1.2	13.1.1.2	14.1.1.2	Port (Mgt)		
6	Node DHCTs	224	81	RF Out Comb.	1	1	2	1	3	IP (Mgt)
7	Node Name	120	134	Freq 1 TSID 1	699	101	723	201	747	301
8	DHCT/Node	224	81	Freq 2 TSID 2	705	102	729	202	753	302
9				Freq 3 TSID 3	711	103	735	203	759	303
10				Freq 4 TSID 4	717	104	741	204	765	304
11	SG Name/ID	servicegroup2	2	Name	RLGHNCAGQM001	RLGHNCAGQM002	RLGHNCAGQM003	Device Name	RLGHN	
12	GQAM Comb.	2		IP (Mgt)	172.16.4.120	172.16.4.121	172.16.4.122	Mgt Switch Name	RLGHN	
13	SG DHCTs	300		IP (Video)	12.1.1.2	13.1.1.2	14.1.1.2	Port (Mgt)		
14	Node DHCTs	79	221	RF Out Comb.	2	1	2	2	3	IP (Mgt)
15	Node Name	109	135	Freq 1 TSID 1	699	105	723	205	747	305
16	DHCT/Node	79	221	Freq 2 TSID 2	705	106	729	206	753	306
17				Freq 3 TSID 3	711	107	735	207	759	307
18				Freq 4 TSID 4	717	108	741	208	765	308
19	SG Name/ID	servicegroup3	3	Name	RLGHNCAGQM001	RLGHNCAGQM002	RLGHNCAGQM003	Device Name	RLGHN	
20	GQAM Comb.	3		IP (Mgt)	172.16.4.120	172.16.4.121	172.16.4.122	Mgt Switch Name	RLGHN	
21	SG DHCTs	290		IP (Video)	12.1.1.2	13.1.1.2	14.1.1.2	Port (Mgt)		
22	Node DHCTs	81	209	RF Out Comb.	3	1	3	2	3	IP (Mgt)
23	Node Name	127	114A	Freq 1 TSID 1	699	109	723	209	747	309
24	DHCT/Node	81	209	Freq 2 TSID 2	705	110	729	210	753	310
25				Freq 3 TSID 3	711	111	735	211	759	311
26				Freq 4 TSID 4	717	112	741	212	765	312
27	SG Name/ID	servicegroup4	4	Name	RLGHNCAGQM001	RLGHNCAGQM002	RLGHNCAGQM003	Device Name	RLGHN	
28	GQAM Comb.	4		IP (Mgt)	172.16.4.120	172.16.4.121	172.16.4.122	Mgt Switch Name	RLGHN	
29	SG DHCTs	295		IP (Video)	12.1.1.2	13.1.1.2	14.1.1.2	Port (Mgt)		
30	Node DHCTs	201	94	RF Out Comb.	4	1	4	2	4	IP (Mgt)
31	Node Name	102	103B	Freq 1 TSID 1	699	113	723	213	747	313
32	DHCT/Node	201	94	Freq 2 TSID 2	705	114	729	214	753	314
33				Freq 3 TSID 3	711	115	735	215	759	315
34				Freq 4 TSID 4	717	116	741	216	765	316
35	SG Name/ID	RLGHNCA-SG101005	101005	Name	RLGHNCAGQM004	RLGHNCAGQM005	RLGHNCAGQM006	Device Name	RLGHN	
36	GQAM Comb.	5		IP (Mgt)	172.16.4.66	76.59.88.5	76.59.88.6	Mgt Switch Name	RLGHN	
37	SG DHCTs	301		IP (Video)	10.90.149.8441	10.90.149.8445	10.90.149.8449	Port (Mgt)		

2nd Generation SDV Design File

The following sections describe the five tabs of the SDV Design File.

Hub_Info Sheet

The following worksheet shows the Hub_Info sheet.

Hub Name	Hub ID	Hub #	SDV SG	First SG	TSD Block	TSD Start	TSD End	SDV F1	SDV F5	SDV F9	SDV F13	SDV F17	SDV F21	SDV F25	SDV F29
Server String		13000													
Headend	RLGHNC														
Durham (A)	RLGHNCA	1	94	5901											
Durham (B)	RLGHNCB	2	53	5401											
Cary (J)	RLGHNCJ	10	240	6701											
Gartner (K)	RLGHNCK	11	75	5701											
Furqay-Vanna (M)	RLGHNCM	13	27	4901											
Benson (TT)	RLGHNCTT	46	20	4851											
Selma (L)	RLGHNCL	12	18	4801											
Goldboro (N)	RLGHNCN	14	39	5301											
Dudley (O)	RLGHNCO	15	13	4701											
Wilson (P)	RLGHNCP	16	33	5101											
Farmville (EE)	RLGHNCEE	31	5	4351											
Raleigh (G)	RLGHNCG	7	124	6501											
Middlesex (SS)	RLGHNCSS	45	12	4651											
Zebulon (I)	RLGHNCI	9	35	5201											
Fayetteville (R)	FYALNCR	18	192	7551											
Spring Lake (S)	FYALNCS	19	55	7451											
Raeleford (Z)	FYALNCZ	26	6	7101											
Southern Pines (O)	FYALNCX	24	34	7351											
Seven Lakes (BB)	RLGHNCBB	28	4	4251											
Durham (C)	RLGHNCC	3	70	5601											
Creedmore (D)	RLGHNCD	4	8	4601											
Oxford (OO)	RLGHNCOO	50	6	4401											
Louisburg (VV)	RLGHNCVV	48	4	4151											
Bunn (RR)	RLGHNCRR	44	8	4501											
Henderson (ZZ)	RLGHNCZZ	52	18	4751											
Warrenton (WW)	RLGHNCWW	49	2	4001											
E. Fayetteville (T)	FYALNCT	20	21	7151											
Lumberton (V)	FYALNCV	22	25	7251											
Lumber Bridge (W)	FYALNCW	23	5	7001											
Pembroke (CC)	RLGHNCCC	29	4	4201											
Dunn (U)	FYALNCU	21	5	7051											
Raleigh (H)	RLGHNCH	8	98	6101											
Raleigh (Q)	RLGHNCQ	17	33	5001											
Wake Forest (F)	RLGHNCF	6	78	5801											
Chapel Hill (E)	RLGHNCE	5	58	5501											
Pittsboro (QQ)	RLGHNCQQ	43	8	4551											
Hillsborough (Y)	RLGHNCY	25	8	4451											
Apex (PP)	RLGHNCPP	42	5	4301											
Wade (AA)	RLGHNCAA	27	3	4101											
Carthage (DD)	RLGHNCDD	30	2	4051											

RFGW-1 QAMS and System Sheet

The QAMS and System sheet corresponds to the QAMS and System tabs on the RFGW-1 GUI. These tabs are included in the SDV Design File as a common location to facilitate communication and discussion regarding an operator's preferences for the settings in the Reference Database. Either Cisco network engineering or an operator can fill out the parameters in these tabs and share the file with various stakeholders.

Use of these tabs is optional. Currently, neither the RPU nor any other tool reads these parameters from the SDV Design File. They are included only for discussion and accounting purposes.

Chapter 2 Provisioning

The following worksheets show the QAMS and System sheets.

QAMS Sheet

RF Port	Port Control	Spacing* (MHz)	Modulation	Output Level (dBmV)	Symbol Rate* (MS/s)	Combined Channels	
1/1							
1/2							
2/1							
2/2							
3/1							
3/2							
4/1							
4/2							
5/1							
5/2							
6/1							
6/2							
QAM Channel	Mode	Spectrum Inversion	FRBS Stuffing	Application Mode	Interleave Depth (LJ)	PMT Rate (tables/sec)	PAT Rate (tables/sec)
1/1.1							
1/1.2							
1/1.3							
1/1.4							
1/2.1							
1/2.2							
1/2.3							
1/2.4							
2/1.1							
2/1.2							
2/1.3							
2/1.4							
2/2.1							
2/2.2							
2/2.3							
2/2.4							
3/1.1							
3/1.2							
3/1.3							
3/1.4							
3/2.1							

System Sheet

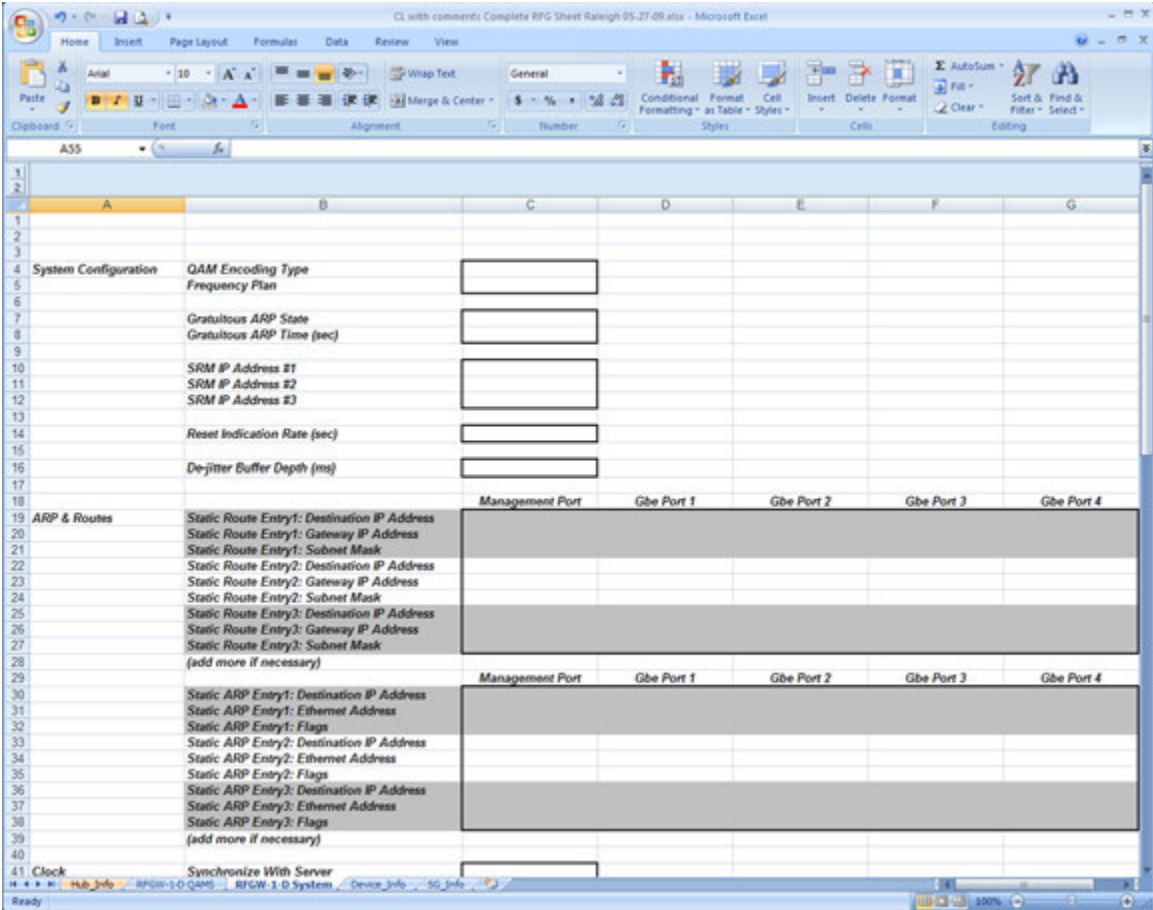

Chapter 2 Provisioning

Device_Info Sheet

The Device_Info sheet is the primary configuration used for RPU data.

The following worksheet shows the Device_Info sheet.

The screenshot shows an Excel spreadsheet titled "Device_Info" with the following structure:

Headend	Hub	Equipment Name	Management				Port 1			Port 2			Port 3		
			IP	Gateway	Mask	MAC	IP	Mask	Virtual IP	IP	Mask	Virtual IP	IP	Mask	Virtual IP
Headend1	Durham (A)	RLGHCARFG0001	172.16.88.90	172.16.88.526	255.255.255.192	172.16.89.85	255.255.255.240	172.16.89.86	N/A	N/A	172.16.89.66	172.16.89.108	255.255.255.240	172.16.90.91	
Headend1	Durham (A)	RLGHCARFG0002	172.16.88.91	172.16.88.526	255.255.255.192	172.16.89.72	255.255.255.240	172.16.89.74	N/A	N/A	172.16.89.74	172.16.89.109	255.255.255.240	172.16.90.91	
Headend1	Durham (A)	RLGHCARFG0003	172.16.88.92	172.16.88.526	255.255.255.192	172.16.89.81	255.255.255.240	172.16.89.82	N/A	N/A	172.16.89.82	172.16.89.107	255.255.255.240	172.16.90.91	
Headend1	Durham (A)	RLGHCARFG0004	172.16.88.93	172.16.88.526	255.255.255.192	172.16.89.69	255.255.255.240	172.16.89.80	N/A	N/A	172.16.89.80	172.16.89.105	255.255.255.240	172.16.90.91	
Headend1	Durham (A)	RLGHCARFG0005	172.16.88.94	172.16.88.526	255.255.255.192	172.16.89.87	255.255.255.240	172.16.89.88	N/A	N/A	172.16.89.88	172.16.89.103	255.255.255.240	172.16.90.91	
Headend1	Durham (A)	RLGHCARFG0006	172.16.88.95	172.16.88.526	255.255.255.192	172.16.89.95	255.255.255.240	172.16.89.96	N/A	N/A	172.16.89.96	172.16.89.101	255.255.255.240	172.16.90.91	
Headend1	Durham (A)	RLGHCARFG0007	172.16.88.96	172.16.88.526	255.255.255.192	172.16.89.93	255.255.255.240	172.16.89.94	N/A	N/A	172.16.89.94	172.16.89.104	255.255.255.240	172.16.90.91	
Headend1	Durham (A)	RLGHCARFG0008	172.16.88.97	172.16.88.526	255.255.255.192	172.16.89.121	255.255.255.240	172.16.89.122	N/A	N/A	172.16.89.122	172.16.89.107	255.255.255.240	172.16.90.91	
Headend1	Durham (A)	RLGHCARFG0009	172.16.88.98	172.16.88.526	255.255.255.192	172.16.89.129	255.255.255.240	172.16.89.130	N/A	N/A	172.16.89.130	172.16.89.105	255.255.255.240	172.16.90.91	
Headend1	Durham (A)	RLGHCARFG0010	172.16.88.99	172.16.88.526	255.255.255.192	172.16.89.117	255.255.255.240	172.16.89.118	N/A	N/A	172.16.89.118	172.16.89.103	255.255.255.240	172.16.90.91	
Headend1	Durham (A)	RLGHCARFG0011	172.16.88.100	172.16.88.526	255.255.255.192	172.16.89.148	255.255.255.240	172.16.89.149	N/A	N/A	172.16.89.149	172.16.89.101	255.255.255.240	172.16.90.91	
Headend1	Durham (A)	RLGHCARFG0012	172.16.88.101	172.16.88.526	255.255.255.192	172.16.89.163	255.255.255.240	172.16.89.164	N/A	N/A	172.16.89.164	172.16.89.129	255.255.255.240	172.16.90.91	
Headend1	Durham (A)	RLGHCARFG0013	172.16.88.102	172.16.88.526	255.255.255.192	172.16.89.161	255.255.255.240	172.16.89.162	N/A	N/A	172.16.89.162	172.16.89.127	255.255.255.240	172.16.90.91	
Headend1	Durham (A)	RLGHCARFG0014	172.16.88.103	172.16.88.526	255.255.255.192	172.16.89.169	255.255.255.240	172.16.89.170	N/A	N/A	172.16.89.170	172.16.89.125	255.255.255.240	172.16.90.91	
Headend1	Durham (A)	RLGHCARFG0015	172.16.88.104	172.16.88.526	255.255.255.192	172.16.89.177	255.255.255.240	172.16.89.178	N/A	N/A	172.16.89.178	172.16.89.123	255.255.255.240	172.16.90.91	
Headend1	Durham (A)	RLGHCARFG0016	172.16.88.105	172.16.88.526	255.255.255.192	172.16.89.185	255.255.255.240	172.16.89.186	N/A	N/A	172.16.89.186	172.16.89.121	255.255.255.240	172.16.90.91	
Headend1	Durham (A)	RLGHCARFG0017	172.16.88.106	172.16.88.526	255.255.255.192	172.16.89.200	255.255.255.240	172.16.89.204	N/A	N/A	172.16.89.204	172.16.89.119	255.255.255.240	172.16.90.91	
Headend1	Durham (A)	RLGHCARFG0018	172.16.88.107	172.16.88.526	255.255.255.192	172.16.89.201	255.255.255.240	172.16.89.202	N/A	N/A	172.16.89.202	172.16.89.117	255.255.255.240	172.16.90.91	
Headend1	Durham (A)	RLGHCARFG0019	172.16.88.108	172.16.88.526	255.255.255.192	172.16.89.209	255.255.255.240	172.16.89.210	N/A	N/A	172.16.89.210	172.16.89.115	255.255.255.240	172.16.90.91	
Headend1	Durham (A)	RLGHCARFG0020	172.16.88.109	172.16.88.526	255.255.255.192	172.16.89.217	255.255.255.240	172.16.89.218	N/A	N/A	172.16.89.218	172.16.89.113	255.255.255.240	172.16.90.91	

The RPU data is divided into two major sections:

- Identification and IP Configuration
- Port and Channel Frequency and TSID Configuration

The following parameters are included in Identification and IP Configuration:

- Headend - Name of the Headend the RFGW-1 is configured with on the network.
- Hub - Name of the installation location.
- Equipment Name - Name of the RFGW-1 configured for the equipment name database field.
- Management IP, Gateway, Mask, MAC - IP configuration parameters for the management port.
- Port IP, Mask, Virtual IP - GbE input port IP configuration parameters.

Note: If the value for any of the Virtual IP address fields is set to **independent**, the database field GbE Data Port Mode will be set to **Four Port Independent**.

- QAM Type - Identifies the type of QAM device. GQAM and RFGW-1 are the only supported types.

Note: The RPU will not create databases or configure GQAM type devices. GQAM configuration data will be used in the Data Integrity Tests, and the GQAM data will be displayed in the RPU data display dialogs.

- Max QAM - Identifies the number of QAM channels for the entire device. 48 or 96 are the supported values.

The following parameters are included in Port and Channel Frequency and TSID Configuration:

- SG ID - Service Group ID to which this port is assigned.
Note: This SGID must be configured in the SG_Info sheet.
- Primary USRM - Name of the Primary USRM (SDV Server) to which this port is configured.
- Backup USRM - Name of the Primary USRM (SDV Server) to which this port is configured.
- Freq 1 - The base frequency assigned to channel 1.
Note: This frequency must be a standard frequency.
- TSID 1 to 4 - The TSID assignments for TSID settings for channels 1 to 4.
- Freq 5 - The base frequency assigned to channel 1.
Note: This frequency must be a standard frequency.
- TSID 5 to 8 - The TSID assignments for TSID settings for channels 5 to 8.

Chapter 2 Provisioning

SG_Info Sheet

The SG_Info sheet is used to configure SDB Service Group information. The following parameters must be configured for use by the RPU:

- SGID
- SG Name
- Primary SDV Server

The other parameters are used for other system configuration purposes. The RPU requires that any service group listed on the Device_Info sheet be defined in the SG_Info sheet.

The following worksheet shows the SG_Info sheet.

SG Name	SG #	Node	Tuners	DHCTs	Parent	Primary SDV Server	Backup SDV Server	Combiner	Hub Sequence	MC Multicast IP	Physical ID	Admin State
RLGHNCA-SG5901						RLGHNC-SDVSRV-01	RLGHNC-SDVSRV-51	1	1	232.132.201.1	RLGHNCAGQM001-51.1	Disable Unmute
RLGHNCA-SG5902						RLGHNC-SDVSRV-01	RLGHNC-SDVSRV-51	2	1	232.132.201.2	RLGHNCAGQM001-52.1	Disable Unmute
RLGHNCA-SG5903						RLGHNC-SDVSRV-01	RLGHNC-SDVSRV-51	3	1	232.132.201.3	RLGHNCAGQM001-201.1	Disable Unmute
RLGHNCA-SG5904						RLGHNC-SDVSRV-01	RLGHNC-SDVSRV-51	4	1	232.132.201.4	RLGHNCAGQM001-202.1	Disable Unmute
RLGHNCA-SG5905						RLGHNC-SDVSRV-01	RLGHNC-SDVSRV-51	5	1	232.132.201.5	RLGHNCAGQM001-301.1	Disable Unmute
RLGHNCA-SG5906						RLGHNC-SDVSRV-01	RLGHNC-SDVSRV-51	6	1	232.132.201.6	RLGHNCAGQM001-302.1	Disable Unmute
RLGHNCA-SG5907						RLGHNC-SDVSRV-01	RLGHNC-SDVSRV-51	7	1	232.132.201.7	RLGHNCAGQM001-401.1	Disable Unmute
RLGHNCA-SG5908						RLGHNC-SDVSRV-01	RLGHNC-SDVSRV-51	8	1	232.132.201.8	RLGHNCAGQM001-402.1	Disable Unmute
RLGHNCA-SG5909						RLGHNC-SDVSRV-01	RLGHNC-SDVSRV-51	9	1	232.132.201.9	RLGHNCAGQM001-501.1	Disable Unmute
RLGHNCA-SG5910						RLGHNC-SDVSRV-01	RLGHNC-SDVSRV-51	10	1	232.132.201.10	RLGHNCAGQM001-502.1	Disable Unmute
RLGHNCA-SG5911						RLGHNC-SDVSRV-01	RLGHNC-SDVSRV-51	11	1	232.132.201.11	RLGHNCAGQM001-601.1	Disable Unmute
RLGHNCA-SG5912						RLGHNC-SDVSRV-01	RLGHNC-SDVSRV-51	12	1	232.132.201.12	RLGHNCAGQM001-602.1	Disable Unmute
RLGHNCA-SG5913						RLGHNC-SDVSRV-01	RLGHNC-SDVSRV-51	13	1	232.132.201.13		
RLGHNCA-SG5914						RLGHNC-SDVSRV-01	RLGHNC-SDVSRV-51	14	1	232.132.201.14		
RLGHNCA-SG5915						RLGHNC-SDVSRV-01	RLGHNC-SDVSRV-51	15	1	232.132.201.15		
RLGHNCA-SG5916						RLGHNC-SDVSRV-01	RLGHNC-SDVSRV-51	16	1	232.132.201.16		
RLGHNCA-SG5917						RLGHNC-SDVSRV-01	RLGHNC-SDVSRV-51	17	1	232.132.201.17		
RLGHNCA-SG5918						RLGHNC-SDVSRV-01	RLGHNC-SDVSRV-51	18	1	232.132.201.18		
RLGHNCA-SG5919						RLGHNC-SDVSRV-01	RLGHNC-SDVSRV-51	19	1	232.132.201.19		
RLGHNCA-SG5920						RLGHNC-SDVSRV-01	RLGHNC-SDVSRV-51	20	1	232.132.201.20		
RLGHNCA-SG5921						RLGHNC-SDVSRV-01	RLGHNC-SDVSRV-51	21	1	232.132.201.21		
RLGHNCA-SG5922						RLGHNC-SDVSRV-01	RLGHNC-SDVSRV-51	22	1	232.132.201.22		
RLGHNCA-SG5923						RLGHNC-SDVSRV-01	RLGHNC-SDVSRV-51	23	1	232.132.201.23		
RLGHNCA-SG5924						RLGHNC-SDVSRV-01	RLGHNC-SDVSRV-51	24	1	232.132.201.24		
RLGHNCA-SG5925						RLGHNC-SDVSRV-01	RLGHNC-SDVSRV-51	25	1	232.132.201.25		
RLGHNCA-SG5926						RLGHNC-SDVSRV-01	RLGHNC-SDVSRV-51	26	1	232.132.201.26		
RLGHNCA-SG5927						RLGHNC-SDVSRV-01	RLGHNC-SDVSRV-51	27	1	232.132.201.27		
RLGHNCA-SG5928						RLGHNC-SDVSRV-01	RLGHNC-SDVSRV-51	28	1	232.132.201.28		
RLGHNCA-SG5929						RLGHNC-SDVSRV-02	RLGHNC-SDVSRV-51	29	1	232.132.201.29		
RLGHNCA-SG5930						RLGHNC-SDVSRV-02	RLGHNC-SDVSRV-51	30	1	232.132.201.30		
RLGHNCA-SG5931						RLGHNC-SDVSRV-02	RLGHNC-SDVSRV-51	31	1	232.132.201.31		
RLGHNCA-SG5932						RLGHNC-SDVSRV-02	RLGHNC-SDVSRV-51	32	1	232.132.201.32		
RLGHNCA-SG5933						RLGHNC-SDVSRV-02	RLGHNC-SDVSRV-51	33	1	232.132.201.33		
RLGHNCA-SG5934						RLGHNC-SDVSRV-02	RLGHNC-SDVSRV-51	34	1	232.132.201.34		
RLGHNCA-SG5935						RLGHNC-SDVSRV-02	RLGHNC-SDVSRV-51	35	1	232.132.201.35		
RLGHNCA-SG5936						RLGHNC-SDVSRV-02	RLGHNC-SDVSRV-51	36	1	232.132.201.36		
RLGHNCA-SG5937						RLGHNC-SDVSRV-02	RLGHNC-SDVSRV-51	37	1	232.132.201.37		
RLGHNCA-SG5938						RLGHNC-SDVSRV-02	RLGHNC-SDVSRV-51	38	1	232.132.201.38		

3rd Generation SDV Design File

The 3rd generation SDV design file contains all of the information provided in the 2nd generation design file plus a new D6_Info sheet. The 3rd generation design file also replicates QAM details for each RFGW-1 in the RFGW-1 QAMS sheet.

Note:

- In the 2nd generation design file, RFGW-1 QAMS sheet is used for reference only; these fields are not manipulated.
- If the latest version of RPU1 is imported with a 2nd generation design file, it will display the message shown below and disable the controls for JSON file export as described in *Generating the JSON File (Phase 2 Step 2e)* (on page 31).

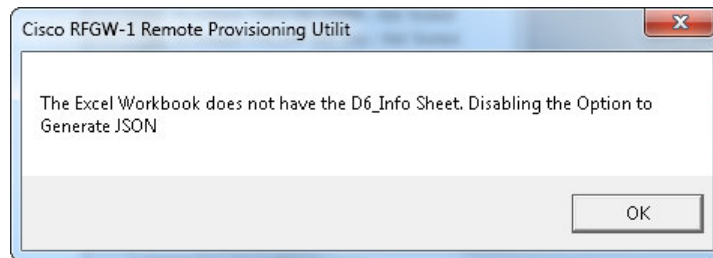
**RFGW-1 QAMs Sheet**

The fields on this sheet are the same as those in the corresponding sheet in the 2nd generation design file, but with the addition of fields used to generate a JSON file that can be exported via HTTP POST method.

All fields that are color-coded green are mandatory, and each RFGW-1 should have an entry in these fields. All other fields can be ignored.

The QAM details for each RFGW-1 are divided into two groups. One group contains RFGW-1 RF Port details, and the other contains RFGW-1 channel details.

The Port group includes the following parameters:

- RF Port – Port ID of RFGW-1.
- Port Control – Possible values are On or Off.
- Spacing – Defaults to 6 MHZ for all channels.
- Modulation – Possible values are QAM64 or QAM256.
- Output Level – Power level in dBmV of the QAM channel.
- Symbol Rate – Symbol rate of the QAM channel.
- Combined Carrier – Number of channels going out from the port. Possible values are None, Single, Dual, Triple, or Quad.

The Channel group includes the following parameters:

- QAM Channel – Channel ID of RFGW-1.
- ON ID – ON ID assigned for each channel in the RFGW-1.
- Mode – Possible values are Normal, Mute, or CW.

Chapter 2 Provisioning

- Spectrum Inversion – Possible values are Normal or Swap.
- PRBS Stuffing – Possible values are On or Off.
- Application Mode – Mode in which the RFGW-1s QAM channel should act. Possible values are VoD Only, Broadcast Only, SDV Only, or Shared.
- Interleave Depth – Interleave Depth of a given QAM channel.
- PMT Rate – Rate at which the PMT table should be generated in the output TS.
- PAT Rate – Rate at which the PAT table should be generated in the TS.
- QAM Status – Required field; possible values are OPERATIONAL, OFFLINE, or QUIESE.

The following worksheet shows the RFGW-1 QAMS sheet.

QAM Channel	QAM ID	Mode	Spectrum Inversion	PRBS Stuffing	Application Mode	Interleave Depth (k)	PMT Rate	PAT Rate	QAM Status	QAM ID	Mode	Spectrum Inversion	PRBS Stuffing	Application Mode	Interleave Depth (k)	PMT Rate	PAT Rate	QAM Status	QAM ID	Mode	Spectrum Inversion	
19.1					VoD Only	11.2611			OPERATIONAL					VoD Only	11.2611			OPERATIONAL				
19.2					VoD Only	11.2612			OPERATIONAL					VoD Only	11.2612			OPERATIONAL				
19.3					VoD Only	11.2613			OPERATIONAL					VoD Only	11.2613			OPERATIONAL				
19.4					VoD Only	11.2614			OPERATIONAL					VoD Only	11.2614			OPERATIONAL				
19.5					VoD Only	11.2615			OPERATIONAL					VoD Only	11.2615			OPERATIONAL				
19.6					VoD Only	11.2616			OPERATIONAL					VoD Only	11.2616			OPERATIONAL				
19.7					VoD Only	11.2617			OPERATIONAL					VoD Only	11.2617			OPERATIONAL				
19.8					VoD Only	11.2618			OPERATIONAL					VoD Only	11.2618			OPERATIONAL				
19.9					VoD Only	11.2619			OPERATIONAL					VoD Only	11.2619			OPERATIONAL				
19.10					VoD Only	11.2620			OPERATIONAL					VoD Only	11.2620			OPERATIONAL				
19.11					VoD Only	11.2621			OPERATIONAL					VoD Only	11.2621			OPERATIONAL				
19.12					VoD Only	11.2622			OPERATIONAL					VoD Only	11.2622			OPERATIONAL				
19.13					VoD Only	11.2623			OPERATIONAL					VoD Only	11.2623			OPERATIONAL				
19.14					VoD Only	11.2624			OPERATIONAL					VoD Only	11.2624			OPERATIONAL				
19.15					VoD Only	11.2625			OPERATIONAL					VoD Only	11.2625			OPERATIONAL				
19.16					VoD Only	11.2626			OPERATIONAL					VoD Only	11.2626			OPERATIONAL				
19.17					VoD Only	11.2627			OPERATIONAL					VoD Only	11.2627			OPERATIONAL				
19.18					VoD Only	11.2628			OPERATIONAL					VoD Only	11.2628			OPERATIONAL				
19.19					VoD Only	11.2629			OPERATIONAL					VoD Only	11.2629			OPERATIONAL				
19.20					VoD Only	11.2630			OPERATIONAL					VoD Only	11.2630			OPERATIONAL				
19.21					VoD Only	11.2631			OPERATIONAL					VoD Only	11.2631			OPERATIONAL				
19.22					VoD Only	11.2632			OPERATIONAL					VoD Only	11.2632			OPERATIONAL				
19.23					VoD Only	11.2633			OPERATIONAL					VoD Only	11.2633			OPERATIONAL				
19.24					VoD Only	11.2634			OPERATIONAL					VoD Only	11.2634			OPERATIONAL				
19.25					VoD Only	11.2635			OPERATIONAL					VoD Only	11.2635			OPERATIONAL				
19.26					VoD Only	11.2636			OPERATIONAL					VoD Only	11.2636			OPERATIONAL				
19.27					VoD Only	11.2637			OPERATIONAL					VoD Only	11.2637			OPERATIONAL				
19.28					VoD Only	11.2638			OPERATIONAL					VoD Only	11.2638			OPERATIONAL				
19.29					VoD Only	11.2639			OPERATIONAL					VoD Only	11.2639			OPERATIONAL				
19.30					VoD Only	11.2640			OPERATIONAL					VoD Only	11.2640			OPERATIONAL				

D6_Info Sheet

This sheet contains the details of the edge device.

The Channel group includes the following parameters:

- Equipment Name – Name of the edge device; should match the Equipment Name value in the Device_Info sheet.
- Controller Name and Controller Id – User-configurable entry for the controller.
- Model Name – Name of the model configured via the GQI model; should be UniQAM.
- Streaming Zone – Streaming zone assigned to the QAM.
- Annex – ITU mode in which the QAM is working.

Provisioning Overview

- Device Status – Operational status of the entire edge device. Possible values are OPERATIONAL, OFFLINE, or QUIESE.
- Name (of Port) – Name assigned to the port of the edge device.
- MAC Address (of port) – MAC address of the port of the edge device.
- Bandwidth (of port) – Bandwidth of the port in kbps.
- Status (of port) – Operational status of the port. Possible values are OPERATIONAL, OFFLINE, or QUIESE.

The following worksheet shows the D6_Info sheet.

Controller							Edge Input									
Equipment Name	Name	ID	Model Name	Networking Name	Address	Device Status	Port 1				Port 2					
							Name	MAC Address	Bandwidth (kbps)	Status	Name	Bandwidth (kbps)	MAC Address	Status	MAC	
CHRGAM_01	Controller 1	101	UNIGM6	1010101	172.16.1.1	OPERATIONAL	Purple	00:50:40:11:30:0E	1000000	OPERATIONAL	Purple	1000000	00:50:40:11:30:0E	OPERATIONAL	Purple	00:50:40:11:30:0E
CHRGAM_02	Controller 2	102	UNIGM6	1010102	172.16.1.2	OPERATIONAL	Purple	00:50:40:11:30:0E	1000000	OPERATIONAL	Purple	1000000	00:50:40:11:30:0E	OPERATIONAL	Purple	00:50:40:11:30:0E
CHRGAM_04	Controller 3	103	UNIGM6	1010103	172.16.1.3	OPERATIONAL	Purple	00:50:40:11:30:0E	1000000	OPERATIONAL	Purple	1000000	00:50:40:11:30:0E	OPERATIONAL	Purple	00:50:40:11:30:0E
CHRGAM_05	Controller 4	104	UNIGM6	1010104	172.16.1.4	OPERATIONAL	Purple	00:50:40:11:30:0E	1000000	OPERATIONAL	Purple	1000000	00:50:40:11:30:0E	OPERATIONAL	Purple	00:50:40:11:30:0E
CHRGAM_10	Controller 5	105	UNIGM6	1010105	172.16.1.5	OPERATIONAL	Purple	00:50:40:11:30:0E	1000000	OPERATIONAL	Purple	1000000	00:50:40:11:30:0E	OPERATIONAL	Purple	00:50:40:11:30:0E
CHRGAM_06	Controller 6	106	UNIGM6	1010106	172.16.1.6	OPERATIONAL	Purple	00:50:40:11:30:0E	1000000	OPERATIONAL	Purple	1000000	00:50:40:11:30:0E	OPERATIONAL	Purple	00:50:40:11:30:0E
CHRGAM_07	Controller 7	107	UNIGM6	1010107	172.16.1.7	OPERATIONAL	Purple	00:50:40:11:30:0E	1000000	OPERATIONAL	Purple	1000000	00:50:40:11:30:0E	OPERATIONAL	Purple	00:50:40:11:30:0E
CHRGAM_08	Controller 8	108	UNIGM6	1010108	172.16.1.8	OPERATIONAL	Purple	00:50:40:11:30:0E	1000000	OPERATIONAL	Purple	1000000	00:50:40:11:30:0E	OPERATIONAL	Purple	00:50:40:11:30:0E
CHRGAM_09	Controller 9	109	UNIGM6	1010109	172.16.1.9	OPERATIONAL	Purple	00:50:40:11:30:0E	1000000	OPERATIONAL	Purple	1000000	00:50:40:11:30:0E	OPERATIONAL	Purple	00:50:40:11:30:0E
CHRGAM_11	Controller 10	110	UNIGM6	1010110	172.16.1.10	OPERATIONAL	Purple	00:50:40:11:30:0E	1000000	OPERATIONAL	Purple	1000000	00:50:40:11:30:0E	OPERATIONAL	Purple	00:50:40:11:30:0E
CHRGAM_13	Controller 11	111	UNIGM6	1010111	172.16.1.11	OPERATIONAL	Purple	00:50:40:11:30:0E	1000000	OPERATIONAL	Purple	1000000	00:50:40:11:30:0E	OPERATIONAL	Purple	00:50:40:11:30:0E
CHRGAM_14	Controller 12	112	UNIGM6	1010112	172.16.1.12	OPERATIONAL	Purple	00:50:40:11:30:0E	1000000	OPERATIONAL	Purple	1000000	00:50:40:11:30:0E	OPERATIONAL	Purple	00:50:40:11:30:0E
CHRGAM_15	Controller 13	113	UNIGM6	1010113	172.16.1.13	OPERATIONAL	Purple	00:50:40:11:30:0E	1000000	OPERATIONAL	Purple	1000000	00:50:40:11:30:0E	OPERATIONAL	Purple	00:50:40:11:30:0E

3

Installation and General Operation

This chapter describes how to install and operate the RPU.

In This Chapter

■ Installing the RPU	18
■ Initial Provisioning Mode	21
■ Creating Databases and Programming the RFGW-1	26
■ RFGW-1 Bulk Provisioning	34
■ RPU Menu Options	38

Installing the RPU

Before installing a new version of the Cisco RPU, you must first uninstall any older versions present on the system.

Uninstalling the Old RPU

- 1 On the windows menu, choose **Start > Control Panel**.
- 2 Double-click **Add or Remove Programs**.
The program window is displayed.
- 3 Highlight the Cisco RFGW Remote Provisioning Utility and click **Remove**.
If the RPU uninstall programs asks if you want to remove shared components, click **Remove All**.

Installing the New RPU

- 1 Insert the RPU Installation CD. Contact your RFGW-1 product manager for installation CD.

The following dialog box is displayed.

Note: If the installer warns that your computer has a more recent version of a component being installed, select the option to not install the older component.



- 2 Click **OK**.

The following dialog box is displayed.

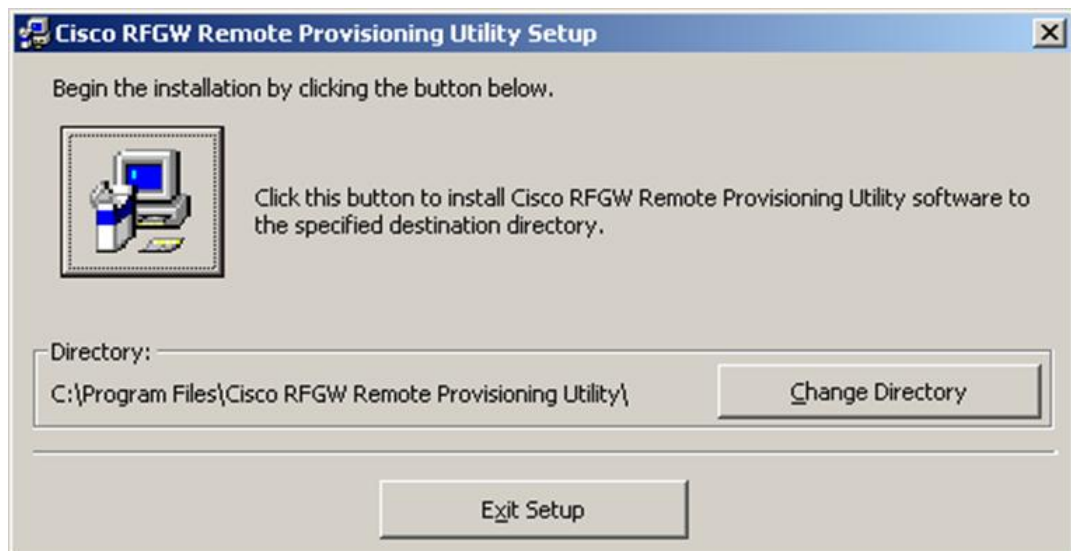

- 3 Click the **Computer** button to start the installation.

The following dialog box is displayed.

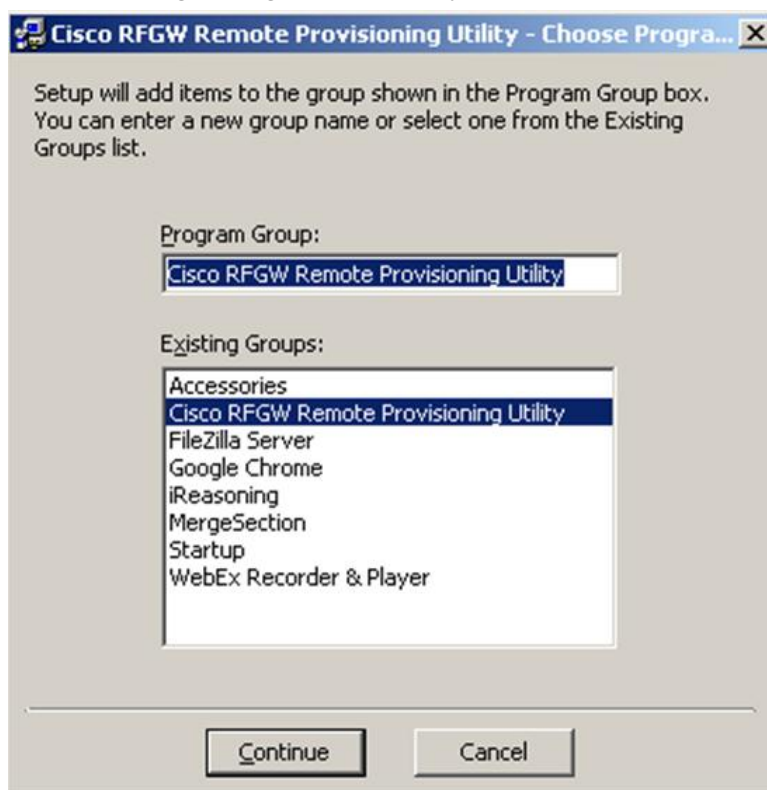

Chapter 3 Installation and General Operation

4 Click **Continue**.

The following dialog box is displayed (depending upon your computer's configuration).

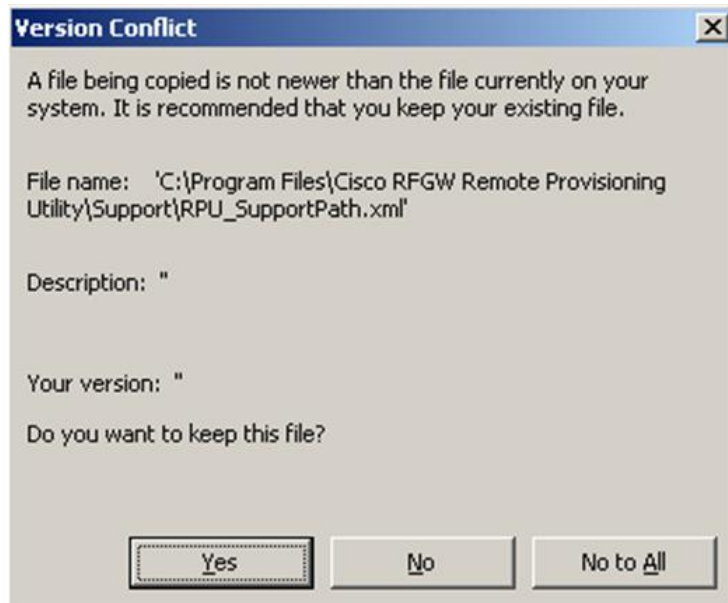

5 Click **Yes**.

The following dialog box is displayed.

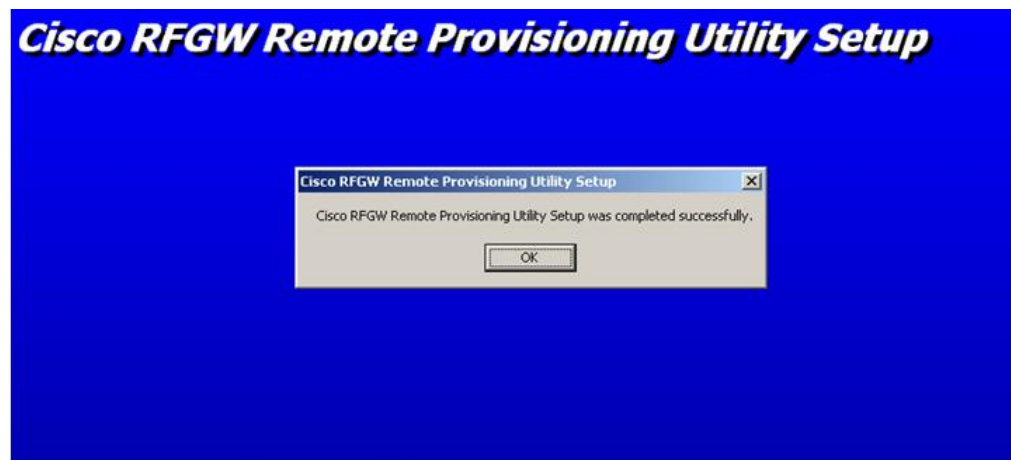

6 Click **OK**.

The installation is complete.

Initial Provisioning Mode

The RPU can perform initial provisioning for both 48 and 96 channel RFGW-1 models. The RPU uses the **MAX QAM** column of the Device_Info tab of the SDV Design File to determine whether the RFGW-1 is intended to be provisioned with 48 or 96 channels of data.

Importing Provisioning Parameters

Before starting the provisioning procedure, you must import the Reference Database and the SDV Design File. Refer to *Importing Reference Database (Phase 1 Step 1c)* (on page 23) and *Importing SDV Design File Spreadsheet (Phase 1 Step 1d)* (on page 24).

Configure RPU Repository Location (Phase 1 Step 1a)

This feature configures the disk file location where the RPU maintains all of the files created and referenced by the RPU. You can locate the RPU repository on a shared network drive if desired.

Configuring the Repository Location

- 1 Click **Set RPU Repository Dir Path** and enter the location of the repository path.

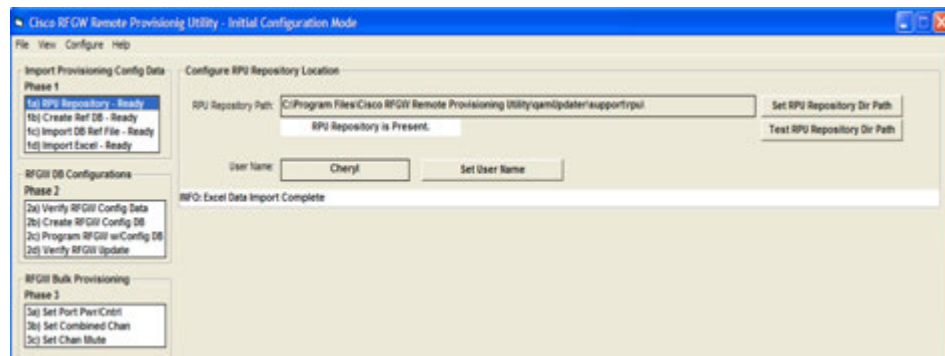

- 2 Click **Test RPU Repository Dir Path**.

This test indicates whether the RPU repository is present and ready for running the RPU.

- 3 Click **Set User Name** and enter desired name in the *User Name* window.

This name is logged in the RPU log file.

Creating Reference Database (Phase 1 Step 1b)

You must create reference databases to capture all desired provisioning parameters that are not included in the SDV Design File spreadsheet. The RPU maintains separate reference databases for 48 and 96 channel RFGW-1 models. You must identify an appropriate RFGW-1 to be used as the reference for each model.

Creating the Reference Database

- 1 Select the **Initial Configuration Mode** option.

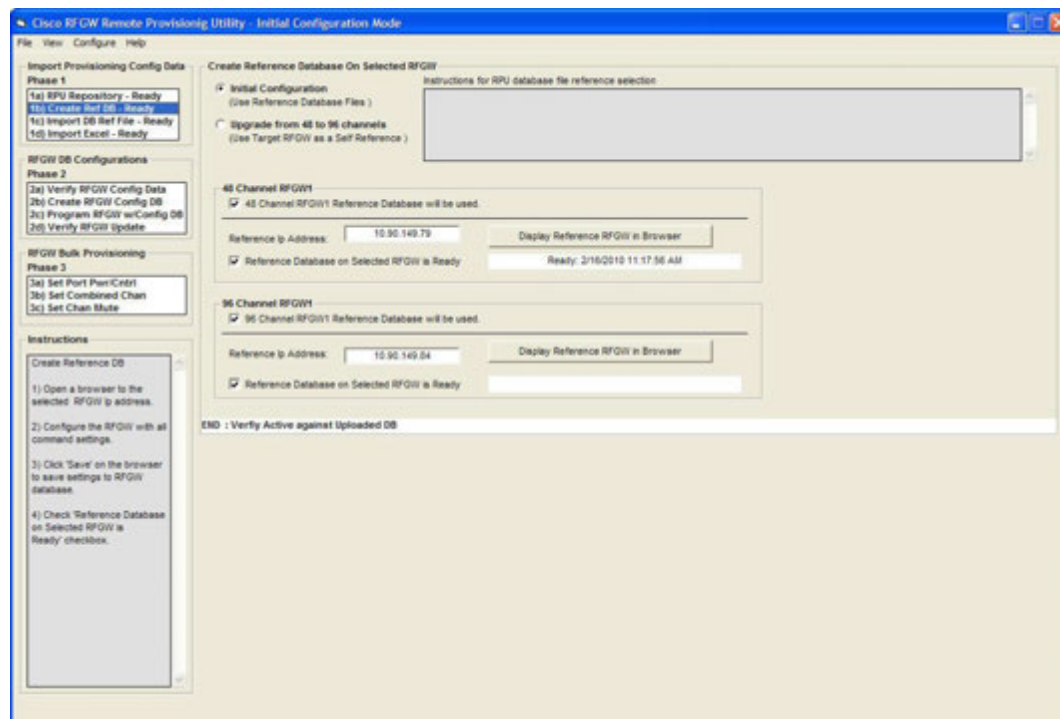

- 2 Select the RFGW-1 to be configured during this session.

Note: In this example, both models are selected. Either one or both of the RFGW-1 units may be referenced in this step.
- 3 Enter the management IP address of the reference unit(s).

Note: The reference unit must be online to complete this step.
- 4 For each unit, click **Display Reference RFGW in Browser**.
The RF Gateway Web GUI is displayed.
- 5 Configure all common and control parameters.

Note: Settings such as IP addresses, frequencies, and TSIDs will be overwritten with information contained in the SDV Design File spreadsheet.
- 6 Click **Apply** after all settings.
- 7 Click **Save**. This saves all reference database settings to the RFGW-1 database files.
- 8 Check the **Reference Database on Selected RFGW is Ready** check box.
The reference database is ready for collection to the RPU repository.

- Repeat as needed for all RFGW-1 units.

Importing Reference Database (Phase 1 Step 1c)

There are two options to choose from when importing the reference database: Copy Local File or Ftp File From RFGW. We recommend the FTP option.

Importing the Reference Database

- From the Import Method drop-down list, choose **Ftp File From RFGW**.

The RPU copies the reference database files from the RF Gateway unit to the RPU repository.

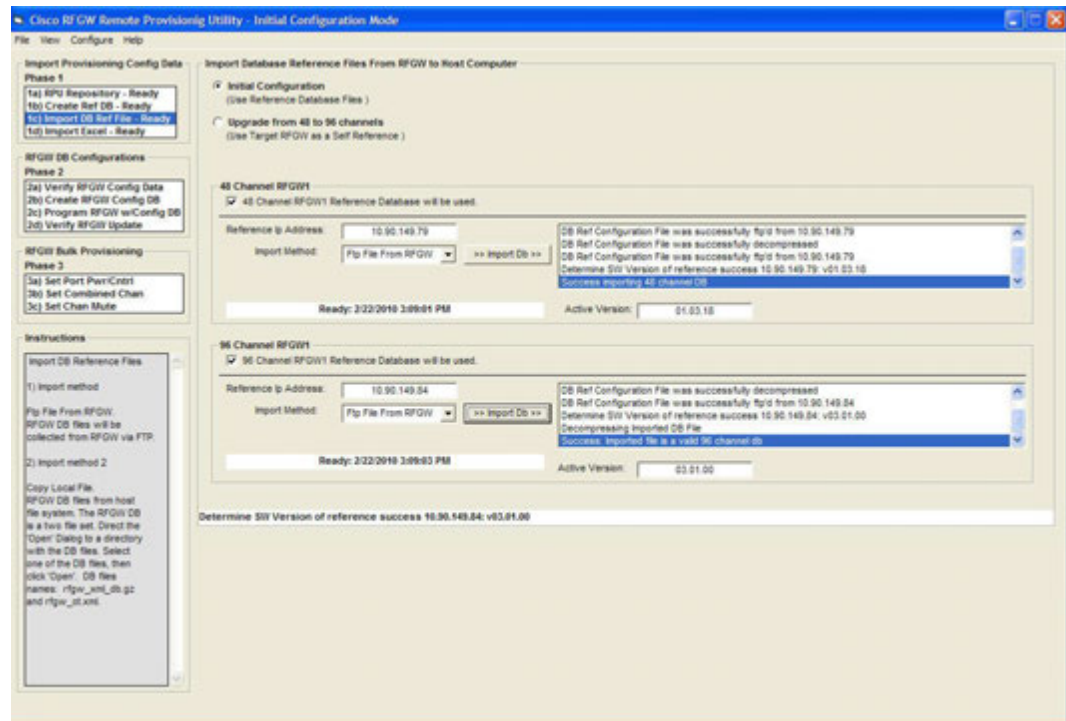

- Click **Import Db**.

The RPU copies the RFGW-1 database files from the RFGW-1 unit and imports them to the RPU file repository. Progress can be seen in the window to the right of the Import Db button.

- Repeat as needed for all RFGW-1 models.

Importing SDV Design File Spreadsheet (Phase 1 Step 1d)

- 1 Click Locate Excel Workbook.

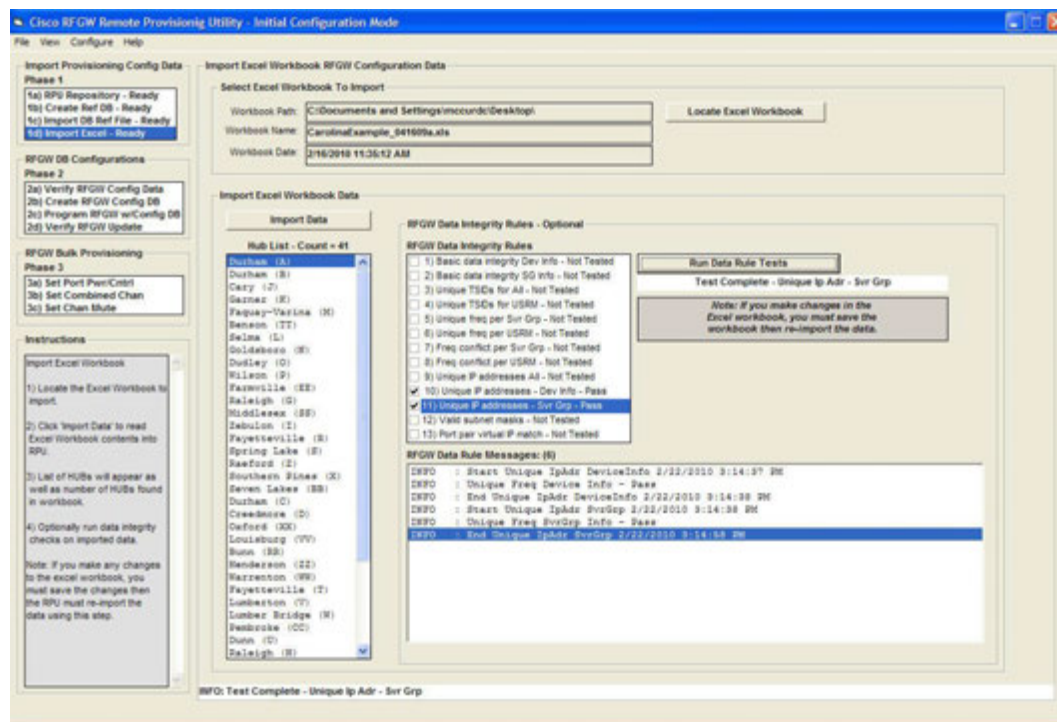

A Windows Open dialog menu opens.

- 2 From the Windows menu, browse to the spreadsheet to import.
- 3 In the RPU worksheet, click **Import Data**.

The RPU extracts all the required data from the spreadsheet and displays the Hub names in the Hub List dialog box.

Note: It may take several minutes to import large files.

- 4 To run any or all of the Data Integrity Tests, click the box next to the test.
- 5 Click **Run Data Rule Tests**.

The results are listed in the RFGW Data Rule Messages list.

Note: You can double-click the log report to create a text log file. The RPU automatically displays the created log file in the default text editor.

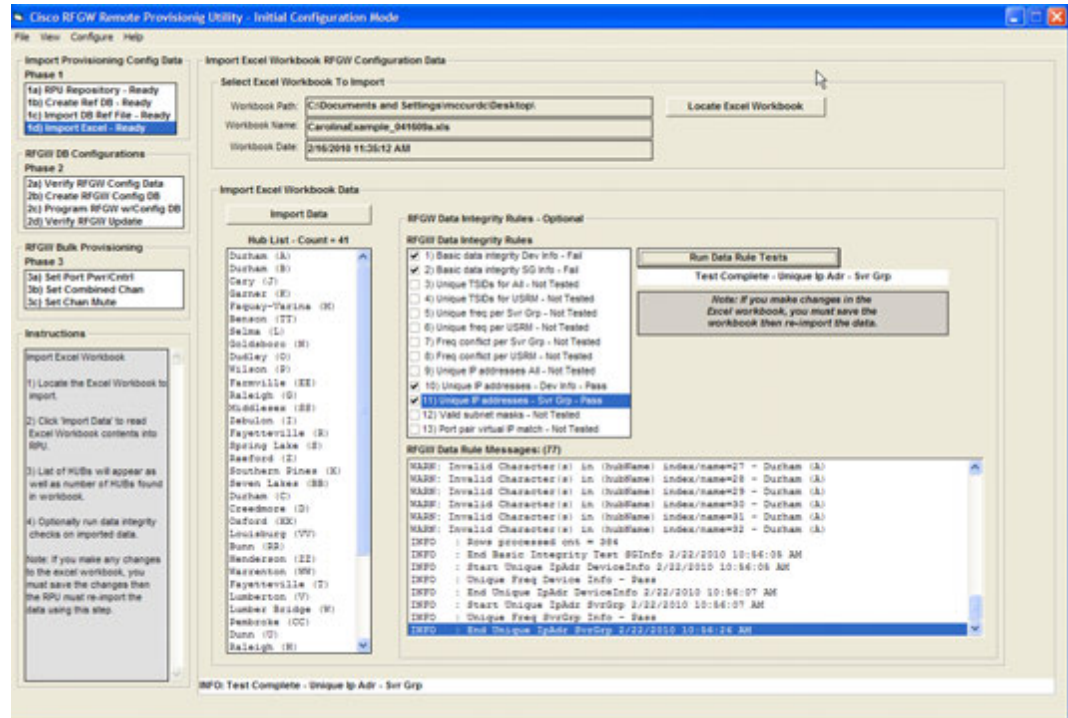

Creating Databases and Programming the RFGW-1

After the provisioning data has been imported, the user is ready to create databases and program the RFGW-1 devices.

Verifying SDV Design File Spreadsheet Configuration Data (Phase 2 Step 2a)

This step allows you to manually verify configuration data imported from the SDV Design File spreadsheet. Make sure to check all imported data for each unit.

Verifying the SDV Design File Spreadsheet Configuration Data

- 1 From the Select Hub list, choose the desired hub.

All RFGW-1s are displayed for this hub.

The screenshot displays the 'Cisco RFGW Remote Provisioning Utility - Initial Configuration Mode' window. It features several panels:

- Import Provisioning Config Data:** Includes options like '1a) RFGW Repository - Ready', '1b) Create Ref DB - Ready', '1c) Import DB Ref File - Ready', and '1d) Import Excel - Ready'.
- RFGW DB Configurations:** Includes '2a) Verify RFGW Config Data', '2b) Create RFGW Config DB', '2c) Program RFGW w/Config DB', and '2d) Verify RFGW Update'.
- RFGW Bulk Provisioning:** Includes '3a) Set Port Param/Conn', '3b) Set Combined Chain', and '3c) Set Chan Mute'.
- Instructions:** Provides a step-by-step guide for verifying RFGW config data.
- Verify RFGW Config Data:** A central panel with 'Select Hub' (set to 'Durham (A)') and 'Select RFGW' (set to 'RLOHNCARF0004 - 10.90.88.94 - SDV Server').
- RFGW Port List: Freq/Teids (48) RFGW(s) (1):** A table listing service group names, QAM names, ports, frequencies, and TSD values for various RFGW units.
- Status of DB Update for 10.90.88.94 - Not Ready:** A detailed view of the selected RFGW unit, showing fields like 'PubName: Durham_A', 'Wgmn IpAddr: 10.90.88.94', 'Wgmn Gateway: 10.90.88.124', 'Wgmn Mask: 255.255.255.192', 'Equipment Type: RFGW', 'Max QAM: 48', 'Ref Dr Mode: File', 'Create/3 State: Not Ready', 'Create Ref DB: Ready 2/22/2010 10:24:48 AM', 'Export Ref DB: Ready 2/16/2010 11:27:56 AM', 'Import Excel: Ready 2/22/2010 10:25:07 AM', 'Data Rules: Not Ready', 'Data Verified By User: Not Ready', 'Config DB Created: Not Ready', 'Program RFGW: Not Ready', and 'Update Verified: Not Verified'.
- RFGW Video IP Info:** A table showing port and virtual IP addresses for ports 1 through 4.
- Buttons:** 'Data OK', 'Data Not OK', and 'RFGW Verify for selected IpAddr: Not Ready'.

Note: You can choose how information is displayed by choosing the following options from the drop-down list:

- RFGW
- Service Group
- SDV Server

- 2 From the **Select RFGW** list, choose one or more units to display and verify.

The RFGW Port List list displays the configuration data for the RF outputs of the unit(s) selected. The RFGW Video IP Info list displays the configuration data for the GbE inputs.

- 3 Once the data has been verified as accurate, click **Data OK**.

Creating RFGW-1 Configuration Database (Phase 2 Step 2b)

- 1 From the **Select HUB** list, choose the desired hub to configure.

All units configured for this hub are displayed in the Select RFGW list.

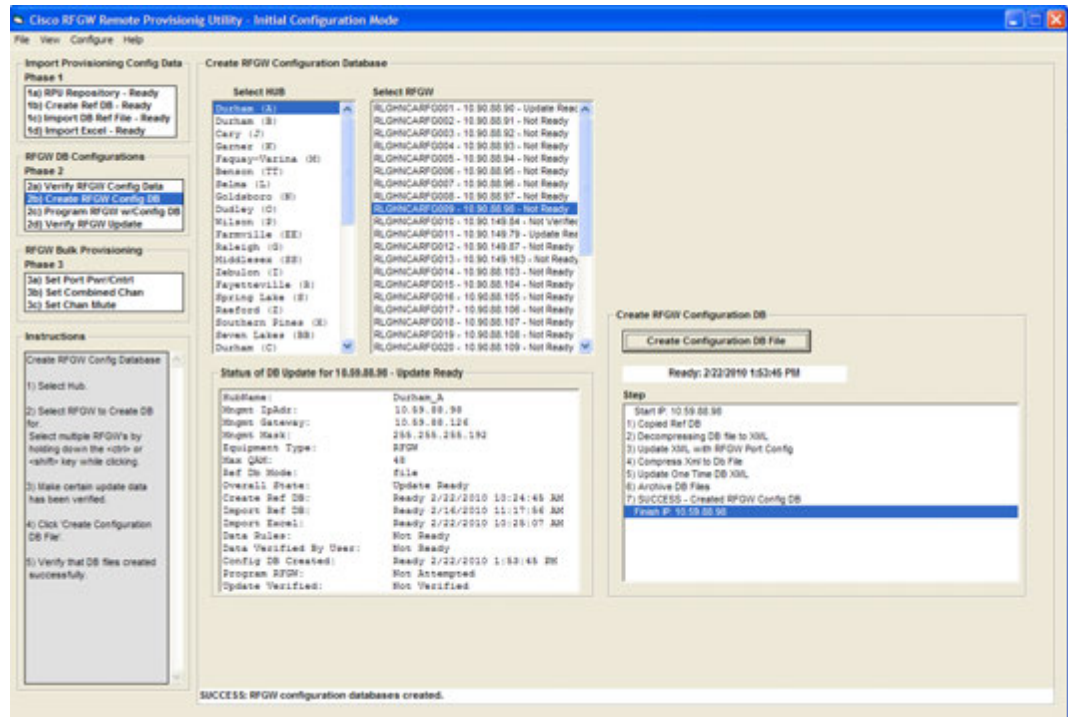

- 2 Highlight the unit(s) for which you want to create a configuration database.

The Status of Db Update list displays the configuration data for all unit(s) selected.

Note: To create databases for more than one unit, hold down the CTRL key and click on an additional list element, or hold down the SHIFT key to select a range of units.

- 3 Click **Create Configuration DB File**.

The configuration database files are created for each unit selected.

Note: If you select a single RFGW, the RPU displays the current status of each step in the database creation, programming, and verification process.

Programming the RFGW-1 with Configuration Database (Phase 2 Step 2c)

Note: There are two options for programming a list of RFGW-1s. These options are configured using the Configure menu.

- 1 Select RFGW Reboot Options and Limits.

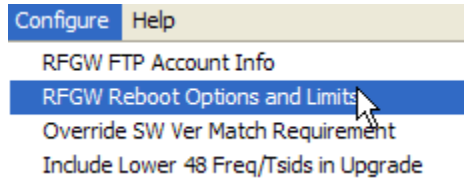

The following options are available:

- Asynchronous – Programs each RFGW-1 and does not wait for the unit to reboot. The unit will be continuously pinged until it responds. The ping status displays the IP addresses and their response status. This is the default mode.
- Synchronous – Programs each RFGW-1 and waits for each unit to reboot.

Note: For multiple units, the preferred selection is likely to be Asynchronous mode.

- 2 From the Hub List list, choose the desired hub.

All units configured for this hub are displayed.

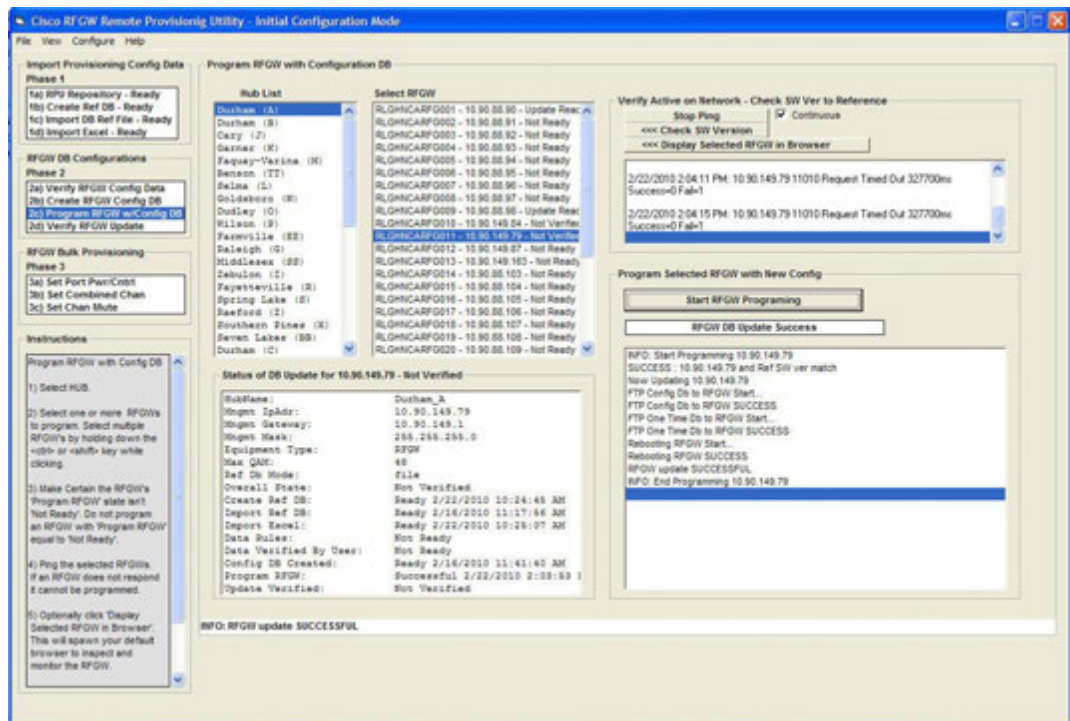

- 3 In the Select RFGW list, highlight the unit(s) to be programmed.

Note: To program more than one unit, hold down the CTRL key and click an additional list element, or hold down the SHIFT key to select a range of units.

4 Click Ping Selected.

The RPU pings each unit selected and displays the results in the status log window.

Note: If an RFGW does not respond to the ping, it will not be able to be programmed.

5 Click Check SW Version.

The RPU collects the software version from each selected RFGW-1.

This software version is compared to the version of the RFGW-1 that provided the Reference Database. If the versions do not match, the RFGW-1 will not be programmed. This check is meant to prevent the user from configuring RFGW-1 units with databases that are incompatible with certain software releases. If the versions do not match, please contact your local Cisco account team for assistance.

Note: There is an option on the Configure menu to override this default action, but this option is not recommended.

6 If desired, click Display Selected RFGW in Browser.

This permits the user to watch the RFGW-1 reboot. If multiple units are selected, only the last unit will be launched in a browser window.

7 Click Start RFGW Programming.

Programming status is displayed in the window.

Verifying RFGW Programming Data (Phase 2 Step 2d)

This step verifies that the configuration data has been correctly programmed into the RFGW-1.

Verifying RFGW Programming Data

- 1 From the Hub List list, choose the desired hub.

All RFGW-1s configured for this hub are displayed.

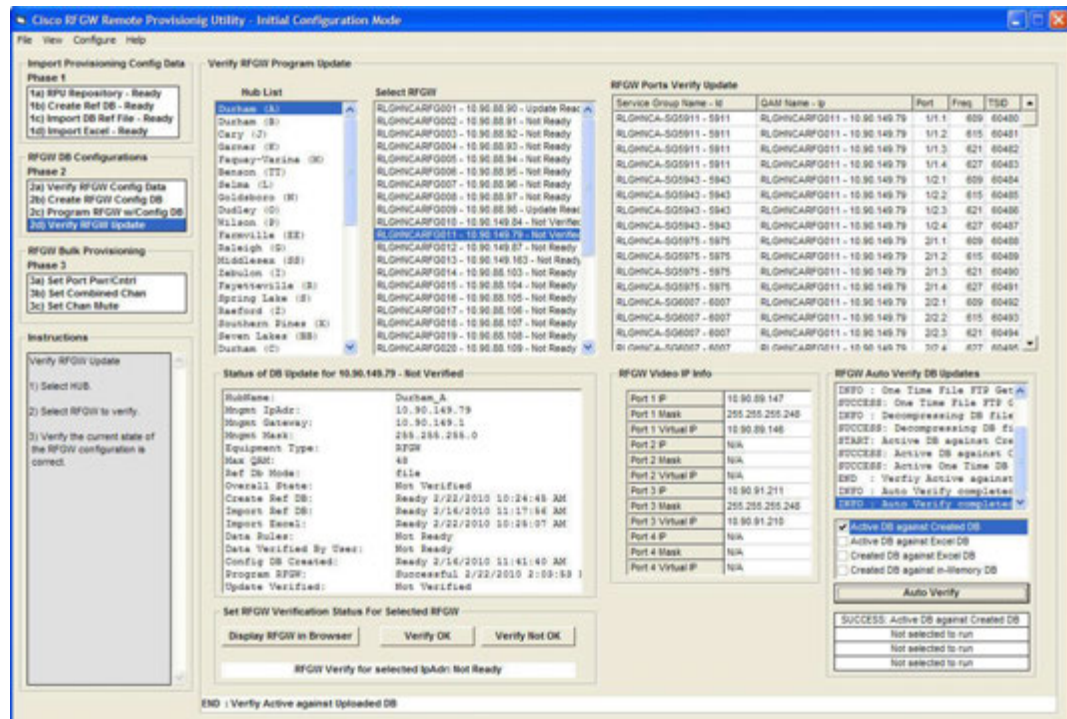

- 2 Select a single unit to verify.
- The selected RFGW-1 configuration is displayed.
- 3 Choose from the following five optional verification techniques.
 - Manual Verify. Displays the RFGW-1 in a browser and uses the GUI interface to compare configuration data displayed for the selected RFGW-1.

Note: You can choose View=>Selected RFGW in Browser from the drop-down menu to display the currently selected RFGW-1.
 - Auto Verify. Active DB against Created DB. This option collects active database files from the RFGW-1 and compares the contents to the database files created by the RPU. This process determines if the RFGW-1 has been modified since the RPU programmed the unit.
 - Auto Verify. Active DB against SDV Design File. This option collects the active database files from the RFGW-1 and compares the contents to the SDV Design File spreadsheet at the time it was last imported into the RPU. This process determines if the RFGW-1 configuration has been modified and does not match the SDV Design File spreadsheet, or if the SDV Design File spreadsheet has been modified and imported without updating the RFGW-1.
 - Auto Verify. Created DB against SDV Design File. This process determines if the SDV Design File spreadsheet has been modified and imported since the creation of the RFGW-1 database.
 - Auto Verify. Created DB against in-Memory DB. This process determines if the in memory RFGW-1 settings have been modified since the RPU created the RFGW-1 database.

4 Click **Auto Verify**.

The status is displayed in a window.

5 If all verification tests passed, click **Verify OK**.

The RFGW status display shows the RFGW-1 as verified.

Generating the JSON File (Phase 2 Step 2e)

This step generates the configurations in JSON format and exports the configuration file to a server using the HTTP POST method.

Note: If the server to which the JSON file is exported does not successfully receive and handle the file, the tool will generate a timeout error.

Generating the JSON File

1 Import the Excel sheet as described in *Importing SDV Design File Spreadsheet (Phase 1 Step 1d)* (on page 24).

Note: If a 2nd generation design file is imported, all controls will be disabled as shown below.

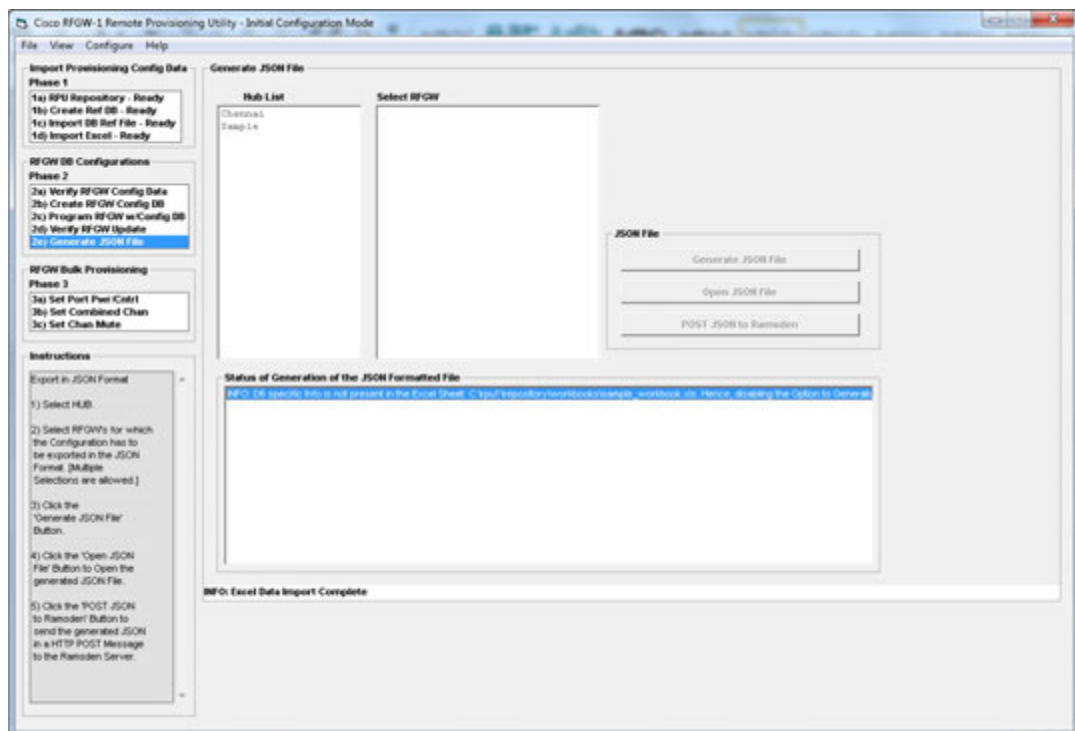

Chapter 3 Installation and General Operation

- 2 Click 2e) **Generate JSON File**. The Generate JSON File screen opens as shown below.

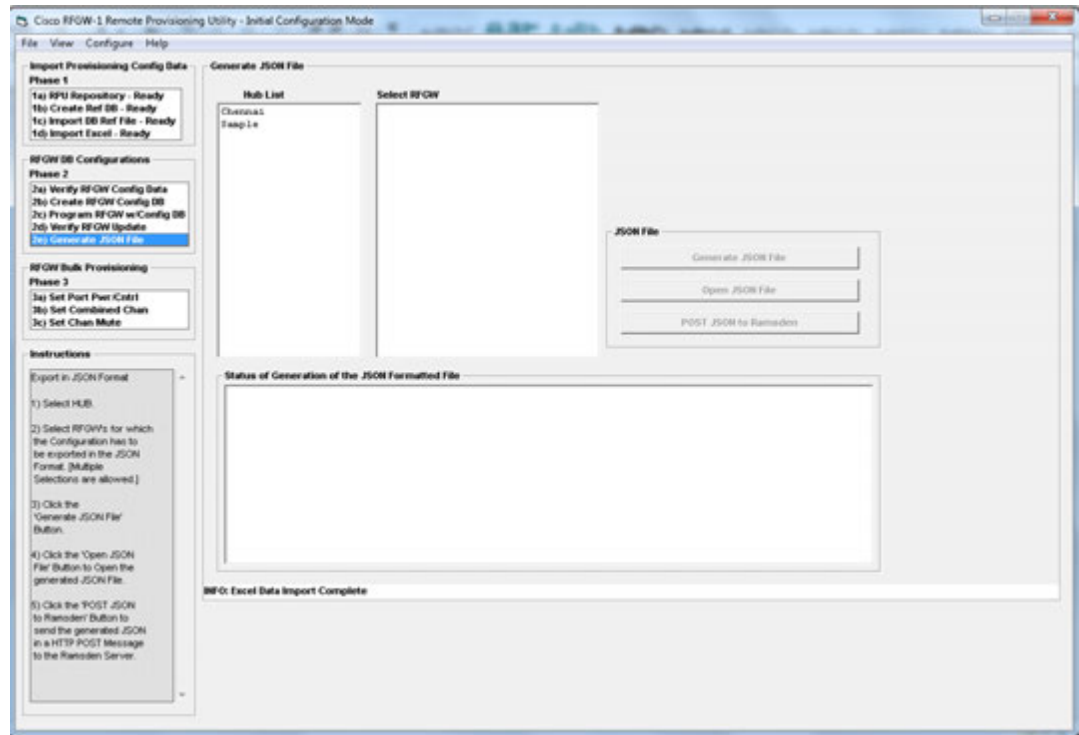

- 3 Choose a hub from the Hub List list.
- 4 Choose one or more RFGW-1s from the Select RFGW list.
- 5 Click **Generate JSON File**.

The tool generates a JSON file containing the QAM configurations of the selected RFGWs. Progress is reported in the status area of the window, as shown below.

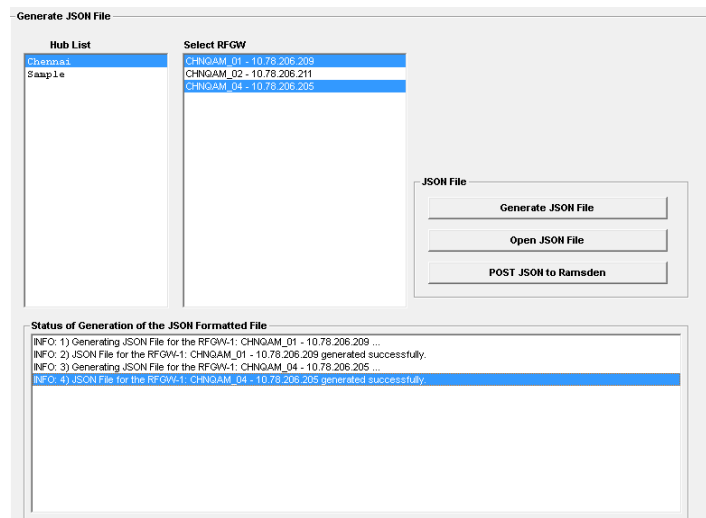

- 6 Click **Open JSON File** to open the generated JSON file and confirm that the file was generated successfully. The file opens in a simple notepad application, as shown below.

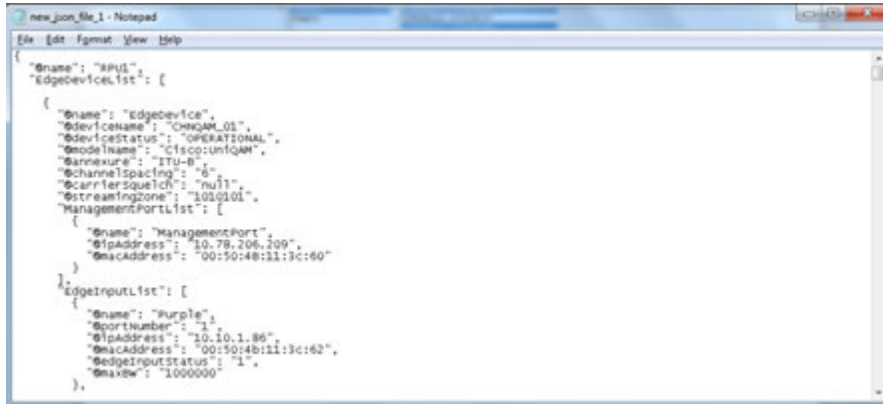

```

{
  "name": "RPU1",
  "edgeDeviceList": [
    {
      "name": "EdgeDevice",
      "deviceName": "CWQAM_01",
      "deviceStatus": "OPERATIONAL",
      "modelName": "Cisco:unfQM",
      "chassis": "ITU-B",
      "channelSpacing": "8",
      "carrierSquelch": "null",
      "streamingzone": "1010101",
      "managementPortList": [
        {
          "name": "ManagementPort",
          "ipAddress": "10.78.206.209",
          "macAddress": "00:50:48:11:3c:60"
        }
      ],
      "edgeInputList": [
        {
          "name": "Purple",
          "portNumber": "1",
          "ipAddress": "10.10.1.86",
          "macAddress": "00:50:48:11:3c:62",
          "edgeInputStatus": "1",
          "maxbw": "1000000"
        }
      ]
    }
  ]
}
    
```

- 7 Click **POST JSON to <servername>** to send the content of file to the server.
- 8 When prompted by the pop-up window, enter the IP address of the server.

Note:

- Before sending the file, RPU1 displays the content of the POST request to be sent.
 - Progress of the export is reported in the status area of the window.
- 9 Monitor the status area of the window and confirm that the export completes successfully.

RFGW-1 Bulk Provisioning

The RPU provides a bulk provisioning feature to configure specific settings on one or more RFGW-1s. This provisioning is accomplished via SNMP and does not require the system to reboot.

Set Port Power/Port Control Levels (Step 3a)

This feature provides a mechanism to bulk provision one or more RFGW-1 RF port power or port control levels.

Setting Port Power or Port Control Levels

- From the Hub List list, choose the desired hub.
All units configured for this hub are displayed.

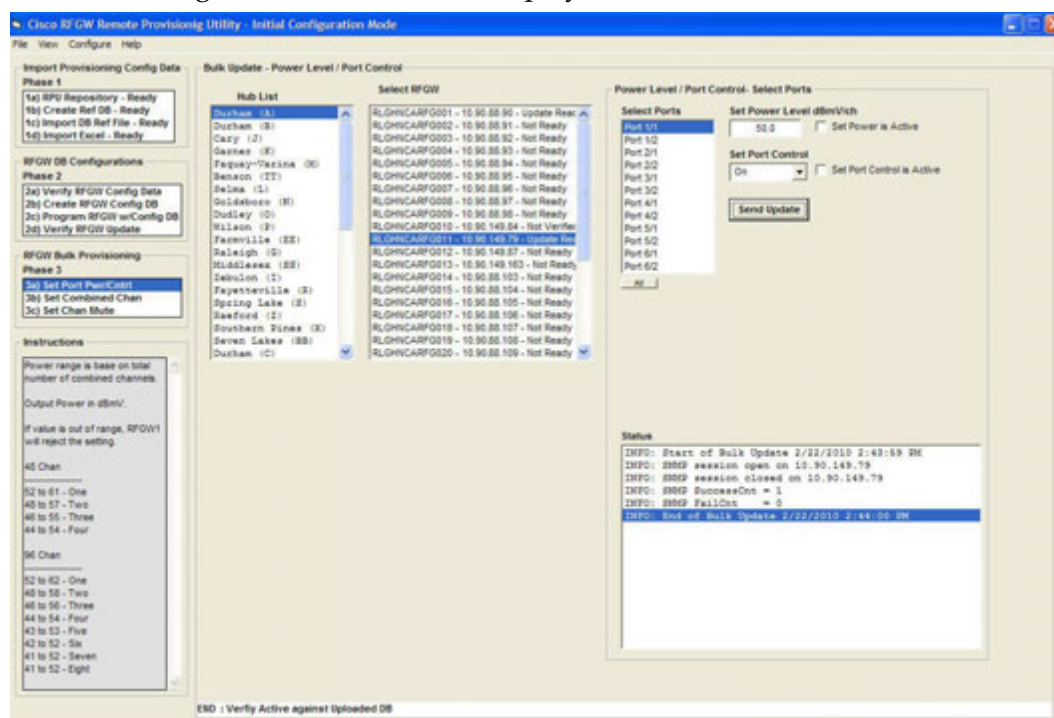

- From the Select RFGW list, choose the unit for which you would like to set power/port control levels.

Note: To display data for more than one unit, hold down the CTRL key and click an additional list element, or hold down the SHIFT key to select a range of units.

- From the Select Ports list, choose the port to configure.

- 4 Do one of the following as appropriate:
 - To set the port power level, enter the port power setting (in dB) in the field, and then check the **Set Power is Active** check box.
 - To set the port control setting, choose **on** or **off** from the drop-down list, and then check the **Set Port Control is Active** check box.
- 5 Click **Send Update**.
The status log displays the results of all SNMP set commands.

Set Combined Channels (Phase 3 Step 3b)

This feature allows the user to bulk provision one or more RFGW-1 RF port combined channels.

Setting Combined Channels

- 1 From the Hub List list, choose the desired hub.
All units configured for this hub are displayed.

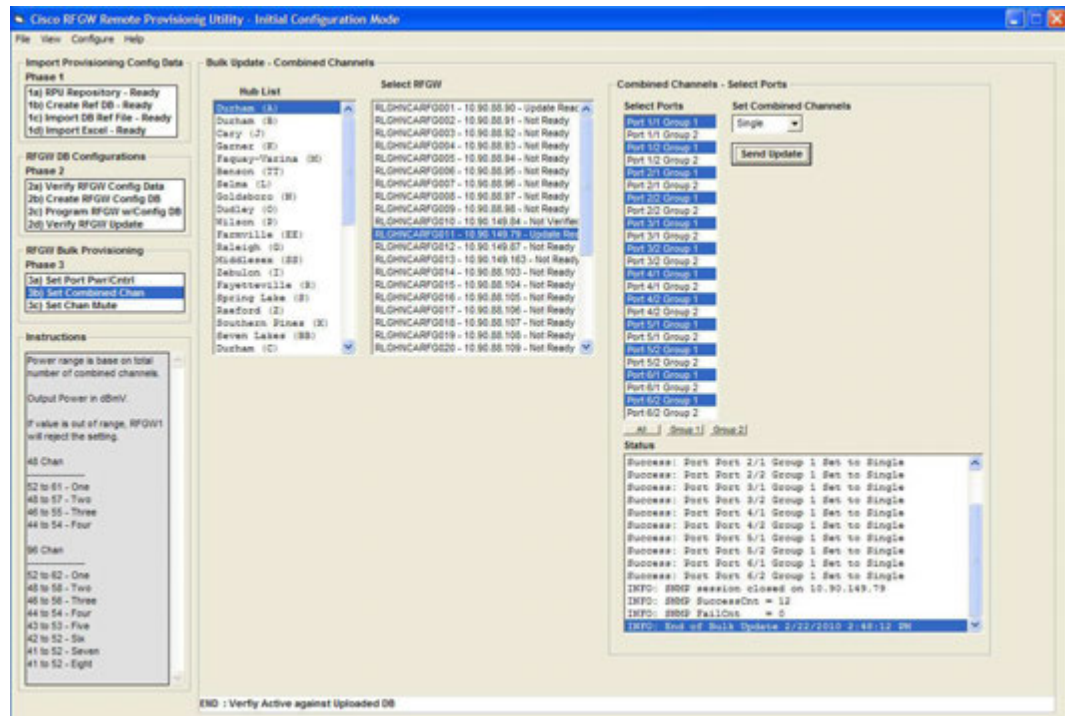

- 2 From the Select RFGW list, choose the unit for which you would like to set combined channels.
Note: To display data for more than one unit, hold down the CTRL key and click an additional list element, or hold down the SHIFT key to select a range of units.

Chapter 3 Installation and General Operation

From the Select Ports list, choose the desired port to configure, or to choose multiple ports, click one of the following options located under the Select Ports list:

- All
- Group 1
- Group 2

1 Click **Send Update**.

The status log displays the results of all SNMP set commands.

Set Channel Mute

This feature allows the user to bulk provision one or more of the RF Gateways port channel mute setting.

Setting Channel Mute

1 From the Hub List list, choose the desired hub.

All units configured for this Hub are displayed.

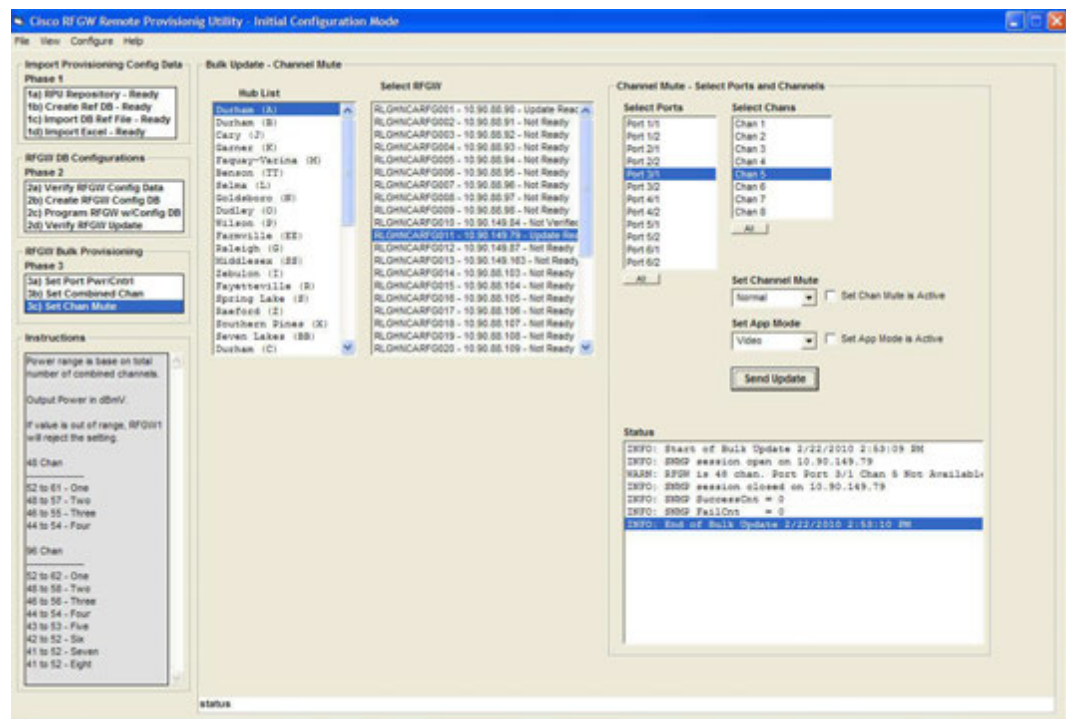

2 From the Select RFGW list, choose the unit for which you would like to set channel mute.

Note: To display data for more than one unit, hold down the CTRL key and click an additional list element, or hold down the SHIFT key to select a range of units.

3 From the Select Ports list, choose the desired port to configure.

4 From the Select Chans list, choose the port channels to configure.

- 5 Choose the channel mute state from the Set Channel Mute drop-down list.
- 6 Check the **Set Channel Mute is Active** check box.
- 7 From the channel application mode from the **Set App Mode** drop-down list.
- 8 Check the **Set App Mode is Active** check box.
- 9 Click **Send Update**.

The status log displays the results of all SNMP set commands.

RPU Menu Options

File Menu

The File Menu allows the user to import and export database files.

- File > Import > Import - Copy DB files
- File > Export > Export - Copy DB Files
- File > Exit

View Menu

The View menu allows the user to perform the following tasks.

- View > Excel Workbook. Opens the workbook configured in the "Import Excel Workbook" path in Step 1.c in Microsoft Excel.
- View > Selected RFGW in Browser. Displays the current RFGW-1 Web GUI in the default browser. If more than one unit is selected, the last one in the list is displayed.
- View > Database Files - Database Files - XML Viewer. The RPU has a built-in XML viewer dialog. The XML information can be navigated via a tree view. If the XML is badly formed, the viewer presents a warning and will not display the XML data.
- Ref 48 Chan DB. Displays the RFGW-1 reference database file configured for the 48 channel RFGW-1 models.
- Ref 48 Chan One Time DB. Displays the RFGW-1 one-time database file configured for the 48 channel RFGW-1 models.
- Ref 96 Chan DB. Displays the RFGW-1 one-time database file configured for the 96 channel RFGW-1 models.
- Ref 96 Chan One Time DB. Displays the RFGW-1 one-time database file configured for the 96 channel RFGW-1 models.
- Selected RFGW DB. Displays the RFGW-1 reference database file configured for the currently selected RFGW-1.
- Selected RFGW One Time DB. Displays the RFGW-1 one-time database file configured for the currently selected RFGW-1 models.
- View > Database Files - Database Files - Text Viewer. Same choices as with the XML Viewer.

Configure Menu

The Configure Menu allows you to configure the following.

- **RFGW FTP Account Information** - The RPU must have the FTP account information to log onto the RFGW-1.

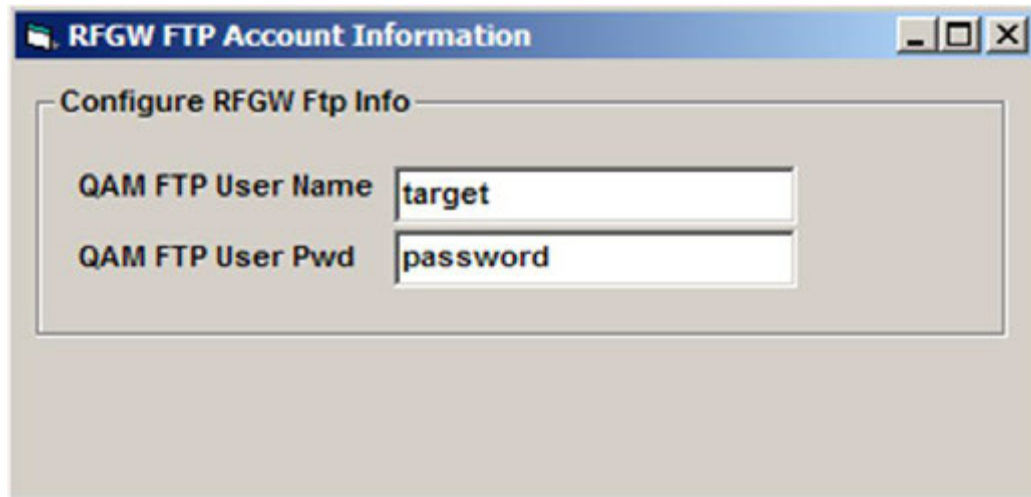

The screenshot shows a window titled "RFGW FTP Account Information". Inside the window, there is a section titled "Configure RFGW Ftp Info". Below this section, there are two text input fields. The first field is labeled "QAM FTP User Name" and contains the text "target". The second field is labeled "QAM FTP User Pwd" and contains the text "password".

- **RFGW Reboot Options and Limits** - The RPU must reboot the RFGW-1 to get the new database files created by the RPU to become the active database files. The following parameters configure the actions and timeouts for reboot.
 - Wait for reboot after uploading DB - Checking this box configures the RPU to wait for an RFGW-1 to completely reboot after the programming action before continuing on to any other RFGW-1s selected to be programmed.
 - Wait Reboot Start Limit (sec). Number of seconds to wait for the RFGW-1 to start the reboot process. If the RFGW-1 has not started the reboot process after the amount of seconds displayed, this is considered a failure.
 - Wait Reboot Done Limit (sec). Number of seconds to wait for the RFGW-1 to complete the reboot process. If the RFGW-1 has not completed the reboot process after the amount of seconds displayed, this is considered a failure.

Chapter 3 Installation and General Operation

- Wait After Reboot Done (sec). Number of seconds to wait after the RFGW-1 reboots before continuing with processing. The RPU uses a ping command to determine if the RFGW-1 rebooted. This extra wait time after the ping has responded allows other RFGW-1 services to become operational.

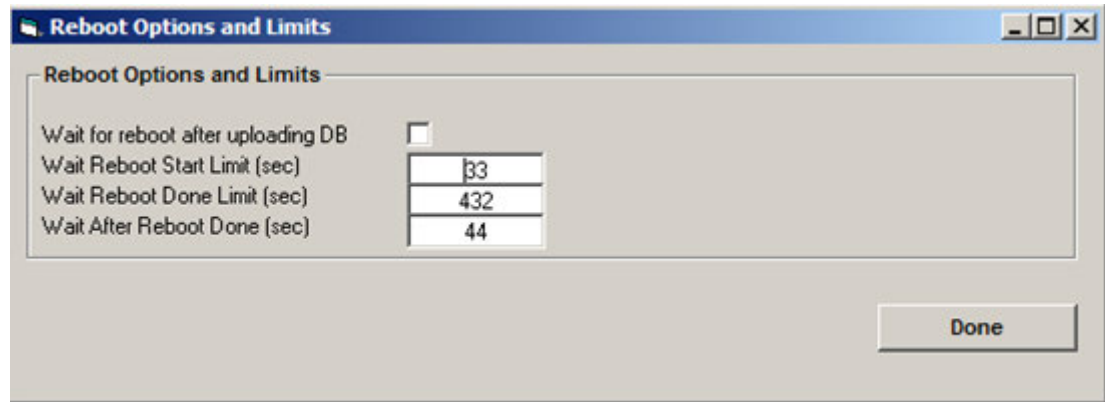

- **Reference SW Version Match Override** - The RPU compares the software versions of the RFGW-1 being programmed and the reference RFGW-1. If the versions do not match, the RPU will not program the RFGW-1 unless the Override Reference SW Match option is selected.

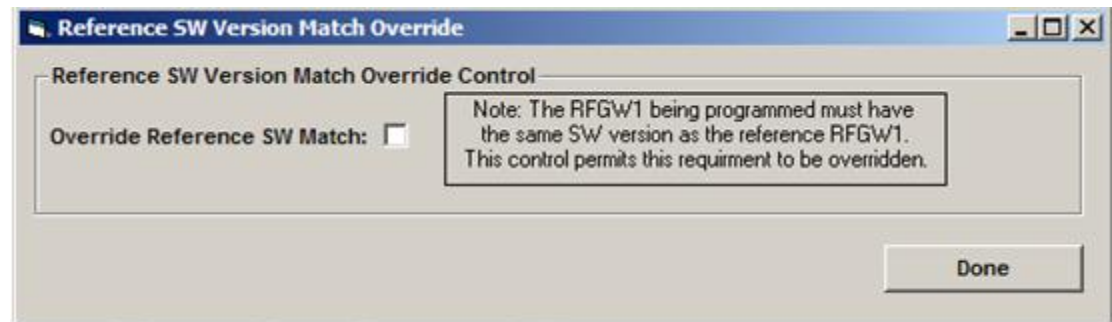

- **Lower 48 Frequencies and TSIDs in Upgrade to 96 Channels** - The default action when in upgrade mode is to only update the upper 48 channels with the Frequency and TSID information configured into the SDV Design File spreadsheet. This option permits the upgrade of the RFGW-1 database files to include the lower 48 Frequency and TSID information as well. This can be useful on a network where a new frequency and/or TSID plan is part of the network upgrade process.

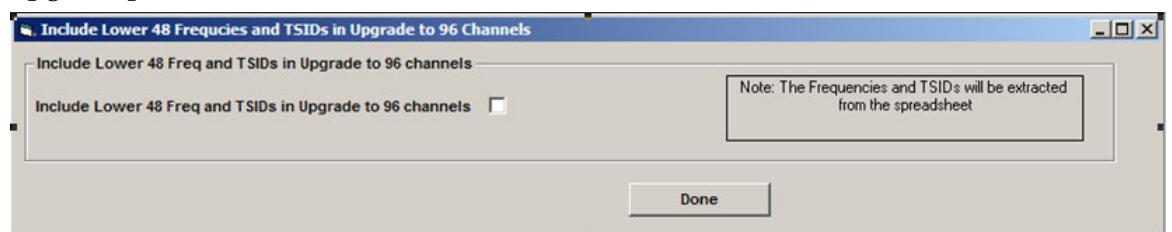

Help Menu

The Help Menu allows the user to view the following tasks.

- Help > Manual. Displays the RPU manual document.
- Help > About. Displays the About dialog that contains the RPU version information.

4

Customer Support Information

Introduction

This chapter contains information on obtaining product support.

Obtaining Product Support

IF...	THEN...
You have general questions about this product	Contact your distributor or sales agent for product information or refer to product data sheets on www.cisco.com .
You have technical questions about this product	Contact the nearest Technical Support center.
You have customer service questions about this product	Contact the nearest Customer Service center.

Glossary

ECM

Entitlement Control Messages.

ECMG

Entitlement Control Message Generator.

EIS

Event Information Scheduler.

EMM

Entitlement Management Messages.

ES

Elementary Stream.

FTP

File Transfer Protocol. Allows users to transfer text and binary files to and from a personal computer, list directories on the foreign host, delete and rename files on the foreign host, and perform wildcard transfers between hosts.

GUI

graphical user interface. A program interface that takes advantage of a computer graphics capabilities to make the program visually easier to use.

HTML

Hypertext Markup Language.

HTTP

Hypertext Transfer Protocol.

Glossary

IP

Internet Protocol. A standard that was originally developed by the United States Department of Defense to support the internetworking of dissimilar computers across a network. IP is perhaps the most important of the protocols on which the Internet is based. It is the standard that describes software that keeps track of the internetwork addresses for different nodes, routes, and outgoing/incoming messages on a network. Some examples of IP applications include email, chat, and Web browsers.

IP address

Internet protocol address. A 32-bit sequence of numbers used for routing IP data. Each IP address identifies a specific component on a specific network. The address contains a network address identifier and a host identifier.

ISO

International Organization for Standardization. An international body that defines global standards for electronic and other industries.

JSON

JavaScript Object Notation. A data interchange format based on a subset of the JavaScript programming language and designed for ease of composition and parsing. JSON is a text format that is language-independent but uses conventions resembling those of C-family languages.

PC

personal computer.

QAM

quadrature amplitude modulation. An amplitude and phase modulation technique for representing digital information and transmitting that data with minimal bandwidth. Both phase and amplitude of carrier waves are altered to represent the binary code. By manipulating two factors, more discrete digital states are possible and therefore larger binary schemes can be represented.

RADIUS

Remote Authentication Dial-In User Service. A networking protocol that provides centralized Authentication, Authorization and Accounting (AAA) management for computers to connect and use a network service.

RF

radio frequency. The frequency in the portion of the electromagnetic spectrum that is above the audio frequencies and below the infrared frequencies, used in radio transmission systems.

RMA

return material authorization. A form used to return products.

RPU

Remote Provisioning Utility.

RU

rack unit. RU is the measuring unit of vertical space in a standard equipment rack. One RU equals 1.75" (44.5 mm).

SCG

Scrambling Control Group.

SCS

Simulcrypt Synchronizer.

Index

B

Before You Begin • 4

C

Configure Menu • 39

Configure RPU Repository Location (Phase 1 Step 1a) • 21

Creating Databases and Programming the RFGW-1 • 26

Creating Reference Database (Phase 1 Step 1b) • 22

Creating RFGW-1 Configuration Database (Phase 2 Step 2b) • 27

customer support information • 43

Customer Support Information • 43

E

ECM • 45

ECMG • 45

EIS • 45

EMM • 45

ES • 45

F

File Menu • 38

FTP • 45

G

Generating the JSON File (Phase 2 Step 2e) • 31

GUI • 45

H

Help Menu • 41

HTML • 45

HTTP • 45

I

Importing Provisioning Parameters • 21

Importing Reference Database (Phase 1 Step 1c) • 23

Importing SDV Design File Spreadsheet (Phase 1 Step 1d) • 24

Initial Provisioning Mode • 21

Installation and General Operation • 17

Installing the RPU • 18

Introduction • 1

IP • 46

IP address • 46

ISO • 46

J

JSON • 46

P

PC • 46

Primary Benefits • 2

Programming the RFGW-1 with Configuration Database (Phase 2 Step 2c) • 28

Provisioning • 3

Provisioning Overview • 5

Q

QAM • 46

R

RADIUS • 46

Reference Database • 5

RF • 46

RFGW-1 Bulk Provisioning • 34

RMA • 47

RPU • 47

RPU Menu Options • 38

RU • 47

S

SCG • 47

Scrambling Introduction • 2

SCS • 47

SDV Design File • 6

Set Channel Mute • 36

Set Combined Channels (Phase 3 Step 3b) • 35

Index

Set Port Power/Port Control Levels (Step 3a) •
34

V

Verifying RFGW Programming Data (Phase 2
Step 2d) • 29

Verifying SDV Design File Spreadsheet
Configuration Data (Phase 2 Step 2a) • 26

View Menu • 38



Americas Headquarters

Cisco Systems, Inc.
170 West Tasman Drive
San Jose, CA 95134-1706
USA

<http://www.cisco.com>

Tel: 408 526-4000

800 553-6387

Fax: 408 527-0883

This document includes various trademarks of Cisco Systems, Inc. Please see the Notices section of this document for a list of the Cisco Systems, Inc. trademarks used in this document.

Product and service availability are subject to change without notice.

© 2010, 2013 Cisco and/or its affiliates. All rights reserved.

October 2013

Part Number OL-30564-01