

Board

Board Pro

Codec EQ

Codec Plus

Codec Pro

Desk, Desk Pro, Desk Mini

Room Bar

Room Kit

Room Kit Mini

Room 55

Room 55 Dual, Room 70

Room 70 G2

Room 70 Panorama

Room Panorama



Administration Guide

for Cisco collaboration devices running RoomOS 11.1

Board

All entries in the table of contents are hyperlinks that take you to the corresponding chapter. To go between the main sections, you can use the buttons in the top menu bar.

Board Pro

Codec EQ

This guide is mainly aimed at administrators working with the setup and configuration of the video conferencing device.

Codec Plus

The guide primarily addresses capabilities and configurations for devices registered to an on-premises service (CUCM, VCS), but most capabilities and configurations also apply to devices that are registered to the Webex cloud service.

Codec Pro

Desk, Desk Pro, Desk Mini

The following devices are covered:

Board series

- Board 55/55S, 70/70S, and 85S
- Board Pro 55 and 75

Desk series

- Desk Mini
- Desk
- Desk Pro

Room series

- Codec EQ
(incl. Room Kit EQ and Room Kit EQ PTZ 4K bundles)
- Codec Plus
(incl. Room Kit Plus, Room Kit Plus PTZ 4K, Room Kit Plus Precision 60, and Room Kit Plus PTZ-12 bundles)
- Codec Pro
(incl. Room Kit Pro, Room Kit Pro PTZ 4K, and Room Kit Pro Precision 60 bundles)
- Room Bar
- Room Kit
- Room Kit Mini
- Room 55
- Room 55 Dual
- Room 70
- Room 70 G2
- Room 70 Panorama
- Room Panorama

Room Bar

Room Kit

Room Kit Mini

Room 55

Room 55 Dual, Room 70

Room 70 G2

Room 70 Panorama

Room Panorama

Table of contents

Introduction..... 5

- RoomOS software and user documentation.....6
- What's new7
- Product features at a glance.....17
- Room Series at a glance.....18
- Desk Series at a glance21
- Board Series at a glance.....22
- How to administer the video conferencing device23
- Touch controllers28

Configuration 29

- User administration30
- Change the device passphrase31
- Restrict the access to the Settings menu.....32
- Device configuration33
- Add a sign in banner34
- Add a welcome banner.....35
- Manage the service certificates of the device36
- Manage the lists of trusted certificate authorities - CAs.....37
- Set up secure audit logging.....41
- Delete CUCM trust lists.....42
- Change the persistency mode.....43
- Set up an SMTP email server44
- Set up ad hoc multipoint conferences.....45
- Set up and use Cisco Proximity.....47
- Adjust the video quality to call rate ratio.....52
- Select a wallpaper bundle as background image.....54
- Add a custom background image for halfwake mode55
- Add a custom background for the Home screen.....56
- Add branding to the screen and touch controller.....57
- Add a virtual background.....59
- Choose a ringtone and set the ringtone volume60
- Manage the Favorites list.....61
- Set up accessibility features.....62
- Set up the low power behavior63
- Provisioning of product specific configurations from CUCM.....64

Board

Board Pro

Codec EQ

Codec Plus

Codec Pro

Desk, Desk Pro, Desk Mini

Room Bar

Room Kit

Room Kit Mini

Room 55

Room 55 Dual, Room 70

Room 70 G2

Room 70 Panorama

Room Panorama

Peripherals	66
Setting up screens and other output devices.....	67
Connecting input sources.....	74
Extend the number of input sources.....	85
Information about displays.....	86
Information about resolutions.....	87
Information about HDMI and USB-C cables.....	88
Set up automatic framing features.....	89
Set up the PresenterTrack feature.....	94
Briefing room setup.....	98
Classroom setup.....	105
Using external microphones with Board Pro.....	114
Test the loudspeaker connections.....	115
Bluetooth® headset.....	118
Connect the touch controller.....	119
Maintenance	128
Installing new software.....	129
Add option keys.....	131
Device status.....	132
Run diagnostics.....	133
Get system log files.....	134
Get call logs.....	136
Create a remote support user.....	137
Backup and restore configurations and custom elements.....	138
CUCM provisioning of custom elements.....	139
TMS provisioning of custom elements.....	140
Revert to the previously used software image.....	141
Factory reset the video conferencing device.....	142
Factory reset Cisco Webex Room Navigator.....	147
Factory reset Touch 10.....	148
Factory reset Cisco Natural Audio Module IV.....	149
Factory reset Table Microphone Pro.....	150
Capture user interface screenshots.....	151
Device settings	152
Overview of the device settings.....	153
App settings.....	161
Audio settings.....	162
Bluetooth settings.....	185
Bookings settings.....	185

BYOD settings.....	186
CallHistory settings.....	187
Cameras settings.....	187
Conference settings.....	199
FacilityService settings.....	206
Files settings.....	207
GPIO settings.....	208
H323 settings.....	208
HttpClient settings.....	211
HttpFeedback settings.....	212
Logging settings.....	213
Macros settings.....	216
Network settings.....	217
NetworkServices settings.....	227
Peripherals settings.....	236
Phonebook settings.....	239
Provisioning settings.....	240
Proximity settings.....	243
RoomAnalytics settings.....	245
RoomCleanup settings.....	247
RoomReset settings.....	248
RoomScheduler settings.....	248
RTP settings.....	249
Security settings.....	250
SerialPort settings.....	254
SIP settings.....	255
Standby settings.....	259
SystemUnit settings.....	263
Time settings.....	264
UserInteraction settings.....	268
UserInterface settings.....	269
UserManagement settings.....	282
Video settings.....	287
VoiceControl settings.....	307
WebEngine settings.....	308
Webex settings.....	310
WebRTC settings.....	312
Zoom settings.....	313
Experimental settings.....	314

Board

Board Pro

Codec EQ

Codec Plus

Codec Pro

Desk, Desk Pro, Desk Mini

Room Bar

Room Kit

Room Kit Mini

Room 55

Room 55 Dual, Room 70

Room 70 G2

Room 70 Panorama

Room Panorama

Physical interfaces	315
Power On/Off and LED behavior.....	316
Connector panel: Codec EQ.....	325
Connector panel: Codec Plus.....	326
Connector panel: Codec Pro and Room Panorama	327
Connector panel: Room Kit.....	328
Connector panel: Room Kit Mini	329
Connector panel: Room Bar.....	330
Connector panel: Room 55.....	331
Connector panel: Room 55 Dual and Room 70	332
Connector panel: Room 70 G2 and Room 70 Panorama	333
Connector panel: Desk Mini.....	334
Connector panel: Desk and Desk Pro.....	335
Connector panel: Board.....	336
Connector panel: Board Pro	337
Connector panel: Room Panorama amplifier.....	338
Room Navigator physical interface	339
Touch 10 physical interface	340
Appendices	341
Call from laptop using the device as a web camera.....	342
Panoramic video	346
Set up remote monitoring	347
Access call information and answer a call while using the device web interface	348
Place a call using the device web interface.....	349
Share content using the device web interface	351
Local layout control.....	352
Control a local camera.....	353
Control a far end camera.....	354
Room analytics.....	355
Customize the video conferencing device's user interface.....	357
Customize the video conferencing device's behavior using macros	359
Show or hide buttons on the user interface	360
Use of a third-party USB input device.....	361
Sending HTTP(S) requests	362
Digital signage.....	363
Web apps.....	364
API-driven web views	365
Input source composition	366
Presentation source composition	368
Access the device's XML files	370
Execute API commands and configurations from the device web interface	371

Advanced customization of audio.....	372
About Ethernet ports.....	377
Mini-jack connector pin-out schemes.....	378
Audio inputs and outputs	379
The GPIO and 3G-SDI connectors	381
API access using the COM port.....	382
Serial interface for maintenance.....	383
The systemtools commands.....	388
Open TCP ports	389
Ephemeral IP ports	390
HTTPFeedback address from TMS.....	391
Link an on-premises registered device to Cisco Webex Edge for Devices	392
Register a device to the Cisco Webex cloud service	393
Supported RFCs	394
Calculating minimum bandwidth	395
User documentation on the Cisco web site.....	396
Cisco contacts	397

Board

Board
Pro

Codec
EQ

Codec
Plus

Codec
Pro

Desk,
Desk Pro,
Desk Mini

Room
Bar

Room Kit

Room Kit
Mini

Room 55

Room 55
Dual,
Room 70

Room 70
G2

Room 70
Panorama

Room
Panorama

Chapter 1

Introduction

Board

Board
ProCodec
EQCodec
PlusCodec
ProDesk,
Desk Pro,
Desk MiniRoom
Bar

Room Kit

Room Kit
Mini

Room 55

Room 55
Dual,
Room 70Room 70
G2Room 70
PanoramaRoom
Panorama

RoomOS software and user documentation

RoomOS is the operating system that powers Cisco collaboration devices, both when the device is registered to an on-premises service (CUCM, VCS) and when it is registered to the Webex cloud service.

How to get software and where to find user documentation depend on where the device is registered.

About the Administration guide

The Administration guide is mainly aimed at administrators working with the setup and configuration of the video conferencing device.

The guide primarily addresses capabilities and configurations for devices registered to an on-premises service (CUCM, VCS), but most capabilities and configurations also apply to devices that are registered to the Webex cloud service.

Project Workplace

We recommend you to explore the Cisco Project Workplace to find inspiration and guidelines when preparing an office or meeting room for video conferencing:

► <https://www.cisco.com/go/projectworkplace>

On-premises registered devices

Software

New versions of RoomOS for on-premises registered devices are released 3-4 times a year. You can download the software from the Cisco web site:

► <https://software.cisco.com/download/home>

Release notes

We recommend reading the software release notes (RoomOS 11) before you upgrade your devices.

► <https://www.cisco.com/c/en/us/support/collaboration-endpoints/desktop-collaboration-experience-dx600-series/products-release-notes-list.html>

► <https://www.cisco.com/c/en/us/support/collaboration-endpoints/spark-room-kit-series/products-release-notes-list.html>

► <https://www.cisco.com/c/en/us/support/collaboration-endpoints/spark-board/products-release-notes-list.html>

Other documentation

We also recommend that you visit the Cisco web site regularly to find the most recent version of this Administrator guide, as well as other documentation for your devices.

► <https://www.cisco.com/go/board-docs> (Board series)

► <https://www.cisco.com/go/desk-docs> (Desk series)

► <https://www.cisco.com/go/room-docs> (Room series)

To find the Administration guides, click *Documentation* and look for *Maintain and Operate > Maintain and Operate Guides*.

Refer to the ► [User documentation on the Cisco web site](#) appendix for more information about guides for this product.

Webex registered devices

Software

New versions of RoomOS for Webex cloud registered devices are released monthly. Software is automatically installed on the devices as set up in Control Hub for your organization.

Release notes

To find what's new in the latest version of the Webex deployment, we recommend you to read *What's new in RoomOS devices* on Webex Help Center.

► <https://help.webex.com/article/6ger7db/>

In this article you also find an overview of previously released features, and some details about features that are planned to be released soon.

Other documentation

For more information about devices that are registered to the Webex cloud service, go to the Webex Help Center:

► <https://help.webex.com>

Note that guides that cover both on-premises and Webex registered devices are on the Cisco web site, as described for *On-premises registered devices*.

Board

Board
ProCodec
EQCodec
PlusCodec
ProDesk,
Desk Pro,
Desk MiniRoom
Bar

Room Kit

Room Kit
Mini

Room 55

Room 55
Dual,
Room 70Room 70
G2Room 70
PanoramaRoom
Panorama

What's new (page 1 of 10)

This chapter provides an overview of new features and improvements, and lists the new, changed, and removed device settings (configurations). For more details, we recommend reading the software release notes (RoomOS 11).

New features and improvements in RoomOS 11.1

New products

- Cisco Codec EQ (and the Room Kit EQ and Room Kit EQ PTZ 4K bundles) are now available, with the new RoomOS 11 user interface.

To unlock the full integrator Audio API and Audio Console application, Codec EQ differs from Codec Pro in that it requires an option key, AVIntegrator.

- Cisco Table Microphone Pro is a multi-directional digital Ethernet microphone (audio over IP). It is now supported by Codec EQ, Codec Pro, and Room 70 G2. As before, it's also supported by Room 70 Panorama and Room Panorama.

RoomOS 11 user interface as default

(All products except Room 70 Panorama and Room Panorama)

The RoomOS 11 user interface has been available as an opt-in experience for on-premises devices since RoomOS 10.19. In this release, RoomOS 11 is the only user interface, and contains the features that were previously available only by toggling on.

AirPlay *(All products except Board 55/70)*

We have added support for AirPlay. When enabled, you can connect your iPhone, iPad or Mac to effortlessly share your screen, collaborate and playback audio and video content.

Join Zoom meetings

(All products)

We have added support for joining a Zoom meeting with One Button To Push (OBTP), or by tapping a Zoom button and entering the meeting number and passphrase.

Whiteboard improvements *(Desk and Board Series)*

Whiteboard functionality has been enhanced with new tools including Shape insertion, an improved Eraser, and a Selection tool. The Shape recognition tool has been expanded to handle more shapes. It's also now possible to name whiteboards and to easily browse and select saved whiteboards.

Persistent camera and microphone access

(All products)

Create a list of web apps where microphone and/or camera access will be allowed by default, rather than having to grant access each time. For example, if you use a specific service for WebRTC calls, add the host to the list to allow microphone and camera access automatically whenever a user starts a WebRTC call.

This default access is granted from the xAPI.

Changed Admin passphrase behavior *(All products)*

Admin passphrase behaviour has been changed. On a new device, calling functionality is disabled until you set a set a passphrase other than the default Admin passphrase.

The default passphrase has not changed.

Board

Board
ProCodec
EQCodec
PlusCodec
ProDesk,
Desk Pro,
Desk MiniRoom
Bar

Room Kit

Room Kit
Mini

Room 55

Room 55
Dual,
Room 70Room 70
G2Room 70
PanoramaRoom
Panorama

What's new (page 2 of 10)

Configuration changes in RoomOS 11.1

New Configurations

Apps WallpaperBundles Halfwakelmage *(All products)*

Audio Input Ethernet [n] Channel [m] Level *(Codec Pro, Room 70 G2, Room 70 Panorama, Room Panorama)*

Audio Input Ethernet [n] Channel [m] Gain *(Codec EQ)*

Audio Input Ethernet [n] Channel [m] Mode *(Codec EQ, Codec Pro, Room 70 G2, Room 70 Panorama, Room Panorama)*

Audio Input Ethernet [n] Channel [m] Pan *(Codec EQ, Codec Pro, Room 70 G2, Room 70 Panorama, Room Panorama)*

Audio Input Ethernet [n] EchoControl Mode *(Codec EQ, Codec Pro, Room 70 G2, Room 70 Panorama, Room Panorama)*

Audio Input Ethernet [n] EchoControl NoiseReduction *(Codec EQ, Codec Pro, Room 70 G2, Room 70 Panorama, Room Panorama)*

Audio Input Ethernet [n] Equalizer ID *(Codec EQ, Codec Pro, Room 70 G2, Room 70 Panorama, Room Panorama)*

Audio Input Ethernet [n] Equalizer Mode *(Codec EQ, Codec Pro, Room 70 G2, Room 70 Panorama, Room Panorama)*

Audio Input Ethernet [n] Mode *(Codec EQ, Codec Pro, Room 70 G2, Room 70 Panorama, Room Panorama)*

Audio Input HDMI [1] Level *(Board)*

Audio Input HDMI [1] Mode *(Board)*

Audio Input HDMI [1] VideoAssociation MuteOnInactiveVideo *(Board, Desk Pro)*

Audio Input USBC [1] VideoAssociation MuteOnInactiveVideo *(Board Pro, Desk, Desk Mini, Desk Pro, Room Bar)*

Audio Input USBMicrophone [1] EchoControl Mode *(Board Pro, Desk, Desk Mini, Desk Pro, Room 55, Room Bar, Room Kit, Room Kit Mini)*

Audio Panning Mode *(Board 55S/75S/85S, Board Pro, Desk, Desk Mini, Desk Pro, Room 55, Room 55 Dual, Room 70, Room 70 G2, Room Bar, Room Panorama, Room 70 Panorama)*

BYOD USBCXapi *(Desk, Desk Mini, Desk Pro)*

CallHistory Recents DisplayName *(All products)*

Cameras Camera [n] IrCutFilter Mode *(Board Pro, Codec EQ, Codec Plus, Codec Pro, Room 55 Dual, Room 70, Room 70 G2, Room Panorama, Room 70 Panorama)*

Cameras Camera [n] IrCutFilter Threshold *(Board Pro, Codec EQ, Codec Plus, Codec Pro, Room 55 Dual, Room 70, Room 70 G2, Room Panorama, Room 70 Panorama)*

Cameras PresenterTrack CameraPosition Pan *(Board Pro)*

Cameras PresenterTrack CameraPosition Tilt *(Board Pro)*

Cameras PresenterTrack CameraPosition Zoom *(Board Pro)*

Cameras PresenterTrack Connector *(Board Pro)*

Cameras PresenterTrack Enabled *(Board Pro)*

Cameras PresenterTrack TriggerZone *(Board Pro)*

Cameras SpeakerTrack DefaultBehavior *(All products)*

Conference CapsetFilter *(All products)*

Conference MaxMultisiteReceiveRate *(All products)*

[Changed path from Conference MaxTotalReceiveCallRate](#)

Conference MaxMultisiteTransmitRate *(All products)*

[Changed path from Conference MaxTotalTransmitCallRate](#)

Conference PeopleFocus OnCall Mode *(All products)*

Macros Diagnostics JavascriptErrors *(All products)*

Macros QuickJSEngine *(All products)*

UserInterface CustomWallpaperOverlay *(All products)*

[Changed path from UserInterface WallpaperOverlay](#)

UserInterface Features Call JoinZoom *(All products)*

UserInterface HomeScreen Dashboard *(All products)*

[Changed path from Apps Homescreen Dashboard](#)

UserInterface RoomScheduler AmbientTemperature Show *(All products)*

UserInterface RoomScheduler PeopleCount Current *(All products)*

UserInterface RoomScheduler StatusWhenInUse *(All products)*

Video Input AirPlay Beacon *(All products except Board 55/70)*

Video Input AirPlay DiscoveryInstructions NetworkName *(All products except Board 55/70)*

Video Input AirPlay DiscoveryInstructions ShowNetworkInfo *(All products except Board 55/70)*

Video Input AirPlay Mode *(All products except Board 55/70)*

Video Input AirPlay Password *(All products except Board 55/70)*

Video Input AirPlay SecurityMode *(All products except Board 55/70)*

Board

Board
ProCodec
EQCodec
PlusCodec
ProDesk,
Desk Pro,
Desk MiniRoom
Bar

Room Kit

Room Kit
Mini

Room 55

Room 55
Dual,
Room 70Room 70
G2Room 70
PanoramaRoom
Panorama

What's new (page 3 of 10)

Video Input Miracast Pin Length *(All products)*

Video Output HDMI Passthrough HdmiUsbConverter Mode *(Codec Plus, Codec Pro, Room 55, Room 70 G2, Room 70 Single, Room Kit)*

Video Output HDMI Passthrough HdmiUsbConverter Name *(Codec Plus, Codec Pro, Room 55, Room 70 G2, Room 70 Single, Room Kit)*

WebRTC InteractionMode *(Board Pro, Desk, Desk Mini)*

Zoom DefaultDomain *(All products)*

Zoom DialStringOptions *(All products)*

Configurations that are removed

Apps Homescreen Dashboard *(All products)*

[Changed path to UserInterface HomeScreen Dashboard](#)

Conference MaxTotalReceiveCallRate *(All products)*

[Changed path to Conference MaxMultisiteReceiveRate](#)

Conference MaxTotalTransmitCallRate *(All products)*

[Changed path to Conference MaxMultisiteTransmitRate](#)

UserInterface Concept Mode *(Board, Board Pro, Codec Pro, Desk Mini, Desk, Desk Pro, Room Bar, Room 55, Room 70 G2, Room Kit, Room Kit Mini)*

UserInterface WallpaperOverlay *(All products)*

[Changed path to UserInterface CustomWallpaperOverlay](#)

Configurations that are modified

Conference FarEndControl Mode *(All products)*

OLD: Default: On

NEW: Default: Auto

OLD: Off/On

NEW: Auto/Off/On

Conference MaxMultisiteReceiveRate *(Board)* ¹

OLD: Default: 10000

NEW: Default: 6000

OLD: Integer (64..10000)

NEW: Integer (64..6000)

Conference MaxMultisiteReceiveRate *(Board Pro)* ¹

OLD: Default: 10000

NEW: Default: 15000

OLD: Integer (64..10000)

NEW: Integer (64..15000)

Conference MaxMultisiteReceiveRate *(Desk, Desk Mini, Room Bar)* ¹

OLD: Default: 6000

NEW: Default: 15000

OLD: Integer (64..6000)

NEW: Integer (64..15000)

Conference MaxMultisiteReceiveRate *(Room 70 Panorama, Room Panorama)* ¹

OLD: Default: 20000

NEW: Default: 15000

OLD: Integer (64..20000)

NEW: Integer (64..15000)

Conference MaxMultisiteTransmitRate *(Board Pro, Desk, Desk Mini, Room Bar)* ²

OLD: Default: 6000

NEW: Default: 15000

OLD: Integer (64..6000)

NEW: Integer (64..15000)

Conference MaxMultisiteTransmitRate *(Room 70 Panorama, Room Panorama)* ²

OLD: Default: 20000

NEW: Default: 15000

OLD: Integer (64..20000)

NEW: Integer (64..15000)

¹ These configurations have also changed path from Conference MaxTotalReceiveCallRate.

² These configurations have also changed path from Conference MaxTotalTransmitCallRate.

Board

Board
ProCodec
EQCodec
PlusCodec
ProDesk,
Desk Pro,
Desk MiniRoom
Bar

Room Kit

Room Kit
Mini

Room 55

Room 55
Dual,
Room 70Room 70
G2Room 70
PanoramaRoom
Panorama

What's new (page 4 of 10)

Conference MaxReceiveCallRate *(Board Pro, Codec Pro, Desk, Desk Mini, Desk Pro, Room 70 G2, Room Bar)*

OLD: Integer (64..6000)

NEW: Integer (64..20000)

Conference MaxTransmitCallRate *(Board, Board Pro, Codec Pro, Desk, Desk Mini, Desk Pro, Room 70 G2, Room Bar)*

OLD: Integer (64..6000)

NEW: Integer (64..20000)

Standby Signage Url *(All products)*

OLD: String (0, 2000)

NEW: String (0, 2048)

Time Zone *(All products)*

Added to valuespace: America/Ciudad_Juarez

UserInterface HomeScreen Peripherals WebApp URL *(All products)*

OLD: String (0, 255)

NEW: String (0, 2048)

UserInterface Kiosk URL *(Board, Board Pro, Desk, Desk Mini, Desk Pro)*

OLD: String (0, 255)

NEW: String (0, 2048)

UserInterface OSD Output *(Board Pro, Codec Plus, Codec Pro, Room 55 Dual, Room 70, Room 70 G2, Room Panorama, Room 70 Panorama)*

OLD: Default: 1

NEW: Default: Auto

Video DefaultLayoutFamily Remote *(Desk Pro)*

OLD: Auto/Equal/Overlay/Prominent/Single

NEW: Auto/Equal/Overlay/Prominent/Prominent_L/Single

Video Input Connector [2] CameraControl Camerald *(Board Pro)*

OLD: Default: 2

NEW: Default: 3

Video Input Connector [3] CameraControl Camerald *(Board Pro)*

OLD: Default: 3

NEW: Default: 2

Video Output Connector [2] HDCPPolicy *(Desk Pro)*

OLD: Off/On

NEW: On

Video Output Connector [2] HDCPPolicy *(Room 55)*

OLD: Default: Off

NEW: Default: On

OLD: Off

NEW: On

Video Selfview OnCall Duration *(All products)*

OLD: Default: 10

NEW: Default: 5

Board

Board
ProCodec
EQCodec
PlusCodec
ProDesk,
Desk Pro,
Desk MiniRoom
Bar

Room Kit

Room Kit
Mini

Room 55

Room 55
Dual,
Room 70Room 70
G2Room 70
PanoramaRoom
Panorama

What's new (page 5 of 10)

New features and improvements in RoomOS 10.19

New product

- Webex Room Bar (with the new RoomOS 11 UI Experience)

Try the new RoomOS 11 UI Experience

*(All products except Codec Plus, Room 55 Dual, Room 70, Room 70 Panorama, Room Panorama)***

With this release you can try out the RoomOS 11 UI Experience on all devices that are registered to an on-premises service. You have to set the *UserInterface Concept Mode* configuration to **Compositor**, for example from the device's web interface.

See this article on Help Center, about RoomOS 11: ► [New User Experience with RoomOS 11 \(https://help.webex.com/n01kj1/\)](https://help.webex.com/n01kj1/).

Wireless sharing with Miracast®

*(All products except Desk Hub)**

A solution for wireless content sharing from Windows computers, without the need for a client. Miracast lets you share your desktop, so you can see the presenter view as you present. This requires a cabled network connection.

Set office hours on device (All products)*

Setting the office hours on a device lets you switch off always-on features like signage, outside of ordinary office hours. You can also prevent the device from waking up just because it detects motion in the room. Administrators can switch the feature on and off, set the hours, and configure standby and wake-up behavior.

Call from laptop

*(Codec Plus, Codec Pro, Room Kit, Room 55, Room 70S, Room 70 G2)**

Now you can use a Room Series device as a web camera (with loudspeaker and microphone) when you call from your laptop. This requires an HDMI-to-USB converter (capturing device), such as Inogeni, in the setup. You can control the camera, adjust the volume, remove background noise, and optimize the audio quality, from the device UI.

Embedded apps

*(Desk Pro, Desk, Desk Mini, Board Series)**

Seamlessly interact with web apps inside a Webex meeting, without worrying about logging in or switching context to another tool.

With embedded app support, participants on a Webex device can see and interact with apps opened in a call. After the app has been initiated by a participant on Webex App, the device automatically opens and logs you in to the application.

Available for devices in personal mode.

Frames

*(Board Series, Room Kit, Room Kit Mini, Room 55, Room Bar)**

When several people are together in a meeting room, you can change the camera mode to Frames for a better view of everyone. Frames mode crops away unnecessary space around participants and composes a view where the people appear closer together, evenly sized and at the same eye level, in up to four frames.

People presence

*(Desk Pro, Desk, Desk Mini, Desk Hub)**

Now you can find out availability of the person from the device itself in all three lists: Directory, Favorites, and Recents. People presence shows availability across Webex App and the users' Webex devices and phones. You can set Do Not Disturb or a custom status from your device.

Available for devices in personal mode linked to Webex Edge for Devices.

Hotdesking with a QR code

*(Desk Pro, Desk, Desk Mini, Desk Hub)**

Sign into any Desk Series device configured for hot-desking by scanning a QR code using a mobile phone.

Available for devices linked to Webex Edge for Devices.

Immersive share

*(Desk Pro, Desk, Desk Mini)**

Devices can consume and correctly render receiver-side immersive share sent from clients.

When immersive share is initiated from a Webex App, this is now also visible on Webex devices linked to Webex Edge for Devices.

* This feature requires the RoomOS 11 UI Experience, which currently is default only on Board Pro, Desk Hub, Desk Mini, and Room Bar. To try it out on other products, you must explicitly set the *UserInterface Concept Mode* configuration to **Compositor**.

** Board Pro, Desk Hub, Desk Mini, and Room Bar have the RoomOS 11 UI Experience by default. It can't be changed.

Board

Board
ProCodec
EQCodec
PlusCodec
ProDesk,
Desk Pro,
Desk MiniRoom
Bar

Room Kit

Room Kit
Mini

Room 55

Room 55
Dual,
Room 70Room 70
G2Room 70
PanoramaRoom
Panorama

What's new (page 6 of 10)

Configuration changes in RoomOS 10.19

New Configurations

Audio Input ARC [2] Mode *(Codec Plus)*

Audio Microphones HdmiPassthrough MuteButton *(Codec Plus, Codec Pro, Room Kit, Room 55, Room 70 Single, Room 70 G2)*

Audio Microphones UsbPassthrough MuteButton *(Board Pro, Desk Mini, Desk, Desk Pro, Room Bar)*

Audio Output Ethernet [1] Mode *(Codec Pro, Room 70 G2)*

BYOD QRCodePairing *(Desk Hub, Desk Mini, Desk, Desk Pro)*

Cameras SpeakerTrack Frames Mode *(Board, Board Pro, Codec Plus, Codec Pro, Room Bar, Room Kit, Room Kit Mini, Room 55, Room 55 Dual, Room 70, Room 70 G2, Room 70 Panorama, Room Panorama)*

Conference EmbeddedApp NotificationsOnly *(Board, Board Pro, Desk Mini, Desk, Desk Pro)*

Peripherals Pairing CiscoTouchPanels RemotePairing *(Desk Mini, Desk, Desk Pro)*

SystemUnit BroadcastName *(All products)*

Time OfficeHours Enabled *(All products)*

Time OfficeHours OutsideOfficeHours Standby AutoWakeup *(All products)*

Time OfficeHours OutsideOfficeHours Standby Delay *(All products)*

Time OfficeHours WorkDay End *(All products)*

Time OfficeHours WorkDay Start *(All products)*

Time OfficeHours WorkWeek Friday *(All products)*

Time OfficeHours WorkWeek Monday *(All products)*

Time OfficeHours WorkWeek Saturday *(All products)*

Time OfficeHours WorkWeek Sunday *(All products)*

Time OfficeHours WorkWeek Thursday *(All products)*

Time OfficeHours WorkWeek Tuesday *(All products)*

Time OfficeHours WorkWeek Wednesday *(All products)*

UserInterface Bookings Visibility TentativeMeetings *(All products)*

UserInterface Concept Mode *((All products except Codec Plus, Room 55 Dual, Room 70, Room 70 Panorama, Room Panorama))*

UserInterface Features Call HdmiPassthrough *(Codec Plus, Codec Pro, Room Kit, Room 55, Room 70 Single, Room 70 G2)*

UserInterface Features Call LayoutControls *(All products)*

UserInterface Features Call ParticipantList *(All products)*

UserInterface Features Call SelfviewControls *(All products)*

UserInterface Features Call Webcam *(Board Pro, Room Bar, Room Kit Mini)*

UserInterface Help Tips *(Codec Plus, Codec Pro, Room Bar, Room Kit, Room Kit Mini, Room 55, Room 55 Dual, Room 70, Room 70 G2, Room 70 Panorama, Room Panorama)*

UserInterface MuteWarning *(All products)*

Video Input Miracast Mode *(All except Desk Hub)*

Video Output Connector [n] HDCPPolicy *(Board Pro, Codec Plus, Codec Pro, Desk Hub, Desk Pro, Room Bar, Room Kit, Room Kit Mini, Room 55, Room 55 Dual, Room 70, Room 70 G2, Room 70 Panorama, Room Panorama)*

Video Output HDMI Passthrough Allowed *(Codec Plus, Codec Pro, Room Kit, Room 55, Room 70 Single, Room 70 G2)*

Video Output HDMI Passthrough AutoDisconnect Delay *(Codec Plus, Codec Pro, Room Kit, Room 55, Room 70 Single, Room 70 G2)*

Video Output HDMI Passthrough AutoDisconnect Enabled *(Codec Plus, Codec Pro, Room Kit, Room 55, Room 70 Single, Room 70 G2)*

Video Output HDMI Passthrough OutputConnector *(Codec Plus, Codec Pro, Room Kit, Room 55, Room 70 Single, Room 70 G2)*

Configurations that are removed

None.

Configurations that are modified

Audio Microphones NoiseRemoval Mode *(All products)*

OLD: Default: Manual

NEW: Default: Enabled

Audio Microphones UsbPassthrough MuteButton *(Room Kit Mini)*

OLD: Default: Inactive

NEW: Default: Active

Board

Board Pro

Codec EQ

Codec Plus

Codec Pro

Desk, Desk Pro, Desk Mini

Room Bar

Room Kit

Room Kit Mini

Room 55

Room 55 Dual, Room 70

Room 70 G2

Room 70 Panorama

Room Panorama

What's new (page 7 of 10)

Audio USB Mode *(Board Pro, Desk Hub, Desk Mini, Desk, Desk Pro, Room Bar, Room Kit, Room Kit Mini, Room 55)*

Added to valuespace: AdditionalSpeaker

Time Zone *(All products)*

Added to valuespace: Europe/Kyiv

UserInteraction RaiseHand CMS *(All products)*

OLD: Default: False

NEW: Default: True

UserInterface Language *(All products)*

Added to valuespace: Ukrainian

Video Input Connector [2, 3] Visibility *(Desk, Desk Pro)*

OLD: Default: IfSignal

NEW: Default: Always

Video Input Connector [2] Visibility *(Desk Mini)*

OLD: Default: IfSignal

NEW: Default: Always

Board

Board
ProCodec
EQCodec
PlusCodec
ProDesk,
Desk Pro,
Desk MiniRoom
Bar

Room Kit

Room Kit
Mini

Room 55

Room 55
Dual,
Room 70Room 70
G2Room 70
PanoramaRoom
Panorama

What's new (page 8 of 10)

New features and improvements in RoomOS 10.15

Kiosk Mode (Board Pro, Desk Mini) *

Kiosk mode allows you to replace the home screen of the device with a custom web application that you host and maintain yourself. This way you can transform the device into a virtual reception or help-desk. The rest of the user interface is locked, to ensure that the device can only be used for the intended purpose.

Open Microsoft OneDrive whiteboards

(Board Pro, Desk Mini) *

You can store and open your Microsoft OneDrive whiteboards directly from the Files button on your device.

Persistent web apps on Room Navigator

(Room Navigator)

Running a third-party web application on a Room Navigator lets you integrate your company's custom solution for managing room bookings and communicating workplace guidelines and information. The app that you select displays on the Room Navigator's entire screen, replacing the RoomOS user interface.

Persistent web apps are only available on Room Navigators that are paired to the device over the network.

T3 alarm detection on Webex devices (All products)

Using macros and third-party integrations, the device can recognize the audio signal of an external T3 fire alarm and trigger a status change in the xAPI. This feature supports T3 alarms only, which is the industry-standard alarm pattern in the United States.

It is not guaranteed that your device will detect an alarm. You should not rely on this feature to raise awareness of an alarm and it does not replace any other safety and security measures and documentation.

People focus layout option (Board Pro, Desk Mini) *

People focus is a layout option that can be applied in any layout family. People focus optimizes screen real estate by removing unnecessary background.

Closed caption real-time translation (All products)

Users can select a language to see incoming closed captions translated to.

Closed captions and real-time translation are available when the Webex assistant is enabled. Devices that are registered to an on-premises service must be linked to Webex Edge for Devices.

Hotdesking (Desk Mini, Desk Hub) *

Only Desk series devices support hotdesking. It allows you to sign in and book a shared device, and thereby get the benefits as if it was your personal device.

If the device is registered to an on-premises service, it must be linked to Webex Edge for Devices to support hotdesking.

Pairing via USB-C cable

(Desk Pro, Desk, Desk Mini, Desk Hub)

Users can pair their Desk series devices using a USB-C cable as an alternative to ultrasound pairing.

If the device is registered to an on-premises service, it must be linked to Webex Edge for Devices to support this feature.

USB forwarding (Desk Hub)

If you want to connect peripherals for a computer, for example a USB keyboard and mouse, to Desk Hub's USB-A port or the left (seen from the rear) USB-C port, you can enable these ports for USB-forwarding. This may be convenient in a hot desking environment. The user automatically gets access to the peripherals when connecting his computer to the Desk Hub.

Changes to the Video Input Connector [n] Quality configuration (All products)

In this software release we have changed the behavior of *Sharpness* and added *Auto*:

- The new value, *Auto*, behaves the same way as *Sharpness* used to behave in earlier releases. As a starting point *Auto* leads to the highest possible resolution. If motion is detected the encoding will automatically change to give the highest possible frame rate.
- If you select *Sharpness*, the stream will get the highest possible resolution and no automatic changes will occur.
- The default value has changed to *Auto* on those connectors that had *Sharpness* as default before.

If you have been using the default values you should not notice any change. However, if you explicitly have set this configuration to *Sharpness* the auto-behavior will be lost.

* Some features requires the RoomOS 11 UI Experience, which currently is used only on Board Pro, Desk Hub, and Desk Mini. You can toggle on the RoomOS 11 UI Experience on Board, Desk, Desk Pro, and Desk Limited Edition if the device is registered to the Webex cloud or linked to Webex Edge for devices with cloud managed software upgrades; it's not available in an on-premises only deployment.

Board

Board
ProCodec
EQCodec
PlusCodec
ProDesk,
Desk Pro,
Desk MiniRoom
Bar

Room Kit

Room Kit
Mini

Room 55

Room 55
Dual,
Room 70Room 70
G2Room 70
PanoramaRoom
Panorama

What's new (page 9 of 10)

Configuration changes in RoomOS 10.15

New Configurations

Audio Microphones PhantomPower *(Room 55 Dual, Room 70)*

Audio Output Ethernet [1] Mode *(Room 70 Panorama)*

BYOD USBForwarding USBA Enabled *(Desk Hub)*

BYOD USBForwarding USBC Enabled *(Desk Hub)*

Cameras Camera Brightness Mode *(Desk Hub)*

Cameras Camera [n] AssignedSerialNumber *(Board Pro)*

Files Services OneDrive TemporaryPersonalSignIn *(All products except Desk Hub)*

Logging Debug Bluetooth *(All products)*

NetworkServices SNMP CommunityName *(Board Pro, Desk, Desk Hub, Desk Mini)*

NetworkServices SNMP Mode *(Board Pro, Desk, Desk Hub, Desk Mini)*

NetworkServices SNMP SystemContact *(Board Pro, Desk, Desk Hub, Desk Mini)*

NetworkServices SNMP SystemLocation *(Board Pro, Desk, Desk Hub, Desk Mini)*

NetworkServices Wifi Settings A_MPDU *(All products)*

Renamed from NetworkServices WifiCloud A_MPDU

NetworkServices Wifi Settings FrequencyBand *(All products)*

Peripherals Pairing CiscoTouchPanels HttpProxy *(Board, Board Pro, Codec Plus, Codec Pro, Room 55, Room 55 Dual, Room 70, Room 70 G2, Room Kit, Room Kit Mini, Room Panorama, Room 70 Panorama)*

PhoneCradle WirelessCharging Mode *(Desk Hub)*

RoomAnalytics T3AlarmDetection Mode *(All products)*

RoomAnalytics T3AlarmDetection Timeout *(All products)*

Security Xapi WebSocket ApiKey Allowed *(All products except Desk Hub)*

Standby WakeupAtMeetingStart *(All products)*

USBC EthernetForwarding Mode *(Desk Hub)*

UserInterface Features Files Start *(Board, Board Pro, Desk, Desk Mini, Desk Pro, Desk Limited Edition)*

UserInterface HomeScreen Peripherals WebApp URL *(All products except Desk Hub)*

UserInterface Kiosk Mode *(Board, Board Pro, Desk, Desk Mini, Desk Pro, Desk Limited Edition)*

UserInterface Kiosk URL *(Board, Board Pro, Desk, Desk Mini, Desk Pro, Desk Limited Edition)*

WebEngine Features Xapi Peripherals AllowedHosts Hosts *(All products except Desk Hub)*

Webex Hotdesking DefaultBookingEndTime *(Desk, Desk Hub, Desk Mini, Desk Pro, Desk Limited Edition)*

WebRTC Provider MicrosoftTeams CompatibilityMode *(Board, Codec Plus, Codec Pro, Desk Pro, Desk Limited Edition, Room 55, Room 55 Dual, Room 70, Room 70 G2, Room Kit, Room Kit Mini, Room Panorama, Room 70 Panorama)*

Configurations that are removed

Cameras Camera [1..7] MotorMoveDetection *(Codec Pro)*

Cameras PresenterTrack CameraPosition Pan *(Room Panorama, Room 70 Panorama)*

Cameras PresenterTrack CameraPosition Tilt *(Room Panorama, Room 70 Panorama)*

Cameras PresenterTrack CameraPosition Zoom *(Room Panorama, Room 70 Panorama)*

Cameras PresenterTrack Connector *(Room Panorama, Room 70 Panorama)*

Cameras PresenterTrack Enabled *(Room Panorama, Room 70 Panorama)*

Cameras PresenterTrack PresenterDetectedStatus *(Room Panorama, Room 70 Panorama)*

Cameras PresenterTrack TriggerZone *(Room Panorama, Room 70 Panorama)*

NetworkServices WifiCloud A_MPDU *(All products)*

Renamed to NetworkServices Wifi Settings A_MPDU

Configurations that are modified

Audio Input HDMI [n] Level *(Board Pro, Codec Plus, Codec Pro, Desk, Desk Pro, Desk Limited Edition, Room 55, Room 55 Dual, Room 70, Room 70 G2, Room Kit, Room Kit Mini, Room Panorama, Room 70 Panorama)*

OLD: Default: -10

NEW: Default: -5

Audio Input USBC [1] Level *(Board Pro, Desk, Desk Hub, Desk Mini, Desk Pro, Desk Limited Edition)*

OLD: Default: -10

NEW: Default: -5

BYOD NFCPairing *(Desk Hub)*

OLD: Default: Disabled

NEW: Default: Enabled

Board

Board
ProCodec
EQCodec
PlusCodec
ProDesk,
Desk Pro,
Desk MiniRoom
Bar

Room Kit

Room Kit
Mini

Room 55

Room 55
Dual,
Room 70Room 70
G2Room 70
PanoramaRoom
Panorama

What's new (page 10 of 10)

Video Input Connector [n] OptimalDefinition Threshold60fps *(All products)*

OLD: 1024_576/1280_720/1920_1080/512_288/768_448/Never

NEW: 1024_576/1280_720/1920_1080/512_288/768_432/Never

Video Input Connector [1] CameraControl Mode *(Desk Hub)*

OLD: Off/On

NEW: Off

Video Input Connector [2] CameraControl Mode *(Desk Hub)*

OLD: Default: Off

NEW: Default: On

OLD: Off

NEW: Off/On

Video Input Connector [2] PreferredResolution *(Board Pro)*

OLD: Default: 3840_2160_30

NEW: Default: 3840_2160_60

OLD: 1920_1080_60/2560_1440_60/3840_2160_30

NEW: 1920_1080_60/2560_1440_60/3840_2160_30/3840_2160_60

Video Input Connector [1] PresentationSelection *(Desk Hub)*

OLD: Default: OnConnect

NEW: Default: Desktop

Video Input Connector [1..2] Quality *(Desk Hub)*

Video Input Connector [1..3] Quality *(Codec Plus, Room 55 Dual, Room 70)*

Video Input Connector [2..2] Quality *(Board, Room Kit, Room Kit Mini)*

Video Input Connector [2..3] Quality *(Board Pro, Desk, Desk Mini, Desk Pro, Desk Limited Edition, Room 55)*

Video Input Connector [1..6] Quality *(Codec Pro, Room 70 G2, Room Panorama, Room 70 Panorama)*

OLD: Motion/Sharpness

NEW: Auto/Motion/Sharpness

Video Input Connector [1] Quality *(Board, Desk Hub, Desk Mini, Room Kit, Room Kit Mini)*

Video Input Connector [1, 3] Quality *(Board Pro, Codec Plus, Desk, Desk Pro, Desk Limited Edition, Room 55,*

Room 55 Dual, Room 70)

Video Input Connector [3..5] Quality *(Codec Pro, Room 70 G2, Room Panorama, Room 70 Panorama)*

OLD: Default: Sharpness

NEW: Default: Auto

Video Output Connector [2] Resolution *(Desk Hub)*

OLD: 1920_1080_50/1920_1080_60/1920_1200_50/1920_1200_60/2560_1440_60/38

40_2160_30/3840_2160_60/Auto

NEW: Auto

Board

Board
ProCodec
EQCodec
PlusCodec
ProDesk,
Desk Pro,
Desk MiniRoom
Bar

Room Kit

Room Kit
Mini

Room 55

Room 55
Dual,
Room 70Room 70
G2Room 70
PanoramaRoom
Panorama

Product features at a glance

Combining an unmatched video and audio experience with sophisticated design, every device in the Cisco Webex Room, Desk and Board portfolio creates a powerful collaboration solution. Rich in functionality and easily scalable, there is a Webex device for every room – from huddle spaces to boardrooms – and for personal desktops, too.

Some of the features you can expect across the Cisco Webex device portfolio include:

- Smart meetings: camera best overview, automatic framing and speaker tracking, noise reduction, join meetings easily with OBTP, Wi-Fi support, easy control with a touch controller or the Webex app.
- Smart presentations: single, dual or triple screens, wired or wireless 4k content-sharing, support for dual content sources.
- Smart rooms: automatic wakeup, people count, environmental and peripheral controls.
- Flexible registration: built for both cloud and on-premises deployment. And, you can use *Webex Edge for Devices* to link your on-premises registered devices to the Webex cloud service, and gain access to select cloud features.

The following pages contain additional details about each product, including information about features that vary from device to device.

Board

Board Pro

Codec EQ

Codec Plus

Codec Pro

Desk, Desk Pro, Desk Mini

Room Bar

Room Kit

Room Kit Mini

Room 55

Room 55 Dual, Room 70

Room 70 G2

Room 70 Panorama

Room Panorama

Room Series at a glance (page 1 of 3)

Room Bar

Cisco Room Bar is a compact yet powerful video collaboration device. It combines a wide (120-degree) field-of-view camera, noise cancelling microphones, dual stereo speakers, and a codec in a single device.

The Room Bar is easy to mount, either on walls or screens. It integrates well with flat panel screens through HDMI CEC. The internal microphone array is optimized for use in huddle spaces and small meeting rooms with up to 5 people seated within 3 meters from the device. In mid-sized meeting rooms with more than 5 people, you can add an external microphone to ensure the best audio experience.

When connected to a computer, the Room Bar can be used as an advanced USB camera for your laptop meeting clients.



Room Bar mounted on top of a standard flat-panel display

Room Kit, Room Kit Mini

Cisco Room Kit includes camera, codec, speakers, and microphones combined in a single device. Easy to mount, it integrates well with flat panel screens through HDMI CEC. Room Kit is designed for meeting rooms with up to seven people.

On a slightly smaller scale, **Cisco Room Kit Mini** includes the same equipment and is well-suited to huddle spaces with two to five people, because of its wide 120-degree field of view. When connected to a computer, Room Kit Mini can be used as a USB camera. Room Kit Mini is also available in a bundle with Samsung Flip, thus combining the Room Kit Mini's video conferencing capabilities with the Samsung Flip's whiteboarding and content functions.



Room Kit mounted on top of a standard flat-panel display

Codec EQ, Codec Plus, Codec Pro

The Cisco codecs are powerful collaboration solutions that integrates well with external displays through HDMI and CEC. Cisco offers Room Kit bundles combining a codec with the Cisco Quad Camera, Precision 60 camera¹, PTZ 4K camera, or PTZ-12 camera², and a Cisco touch controller user interface.

Cisco Codec EQ integrates with up to three screens, 3 analog or 8 digital directional microphones. Just like Codec Pro, it works well for large conference rooms, boardrooms, training rooms, and auditoriums. With the AV integrator package (option key), the full integrator audio API is unlocked.

Cisco Codec Pro integrates with up to three screens, 8 analog or 4 digital directional microphones. It works well also for large conference rooms, boardrooms, training rooms, and auditoriums. The codec is built with AV integrators in mind.

Cisco Codec Plus integrates with up to two displays and 3 analog microphones. It works well for medium to large-sized meeting rooms.

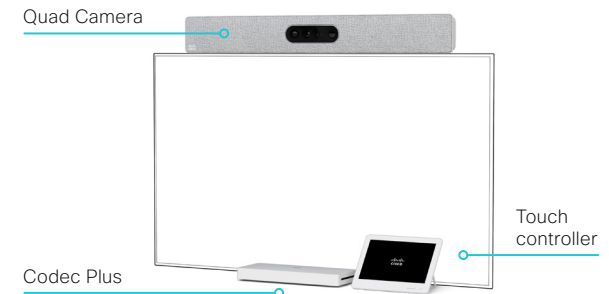

¹ Only Codec Pro and Codec Plus.

² Only Codec Plus.

Board

Board Pro

Codec EQ

Codec Plus

Codec Pro

Desk, Desk Pro, DeskMini

Room Bar

Room Kit

Room Kit Mini

Room 55

Room 55 Dual, Room 70

Room 70 G2

Room 70 Panorama

Room Panorama

Room Series at a glance (page 2 of 3)

Room 55

Cisco Room 55 includes camera, codec, screen, speakers, and microphones - all integrated in a single device. You can choose to mount the single 55" screen on a floor stand, wheeled base, or on the wall. Perfectly designed for small to medium-sized meeting rooms, Room 55 transforms your work spaces into video collaboration hubs.



Room 55 on a floor stand

Room 70 G2, Room 70, Room 55 Dual

Cisco Room 70 G2 is based on the Codec Pro and comprises a quad-camera, and 70" LED single or dual 4K screen(s) with integrated speakers and microphones*. The single screen setup delivers a people-focused experience, while dual screens create compelling people- and people/content-focused experiences.

With similar functionality, **Cisco Room 70** is based on the Codec Plus.

Easily scalable, and offering speaker-tracking and auto-framing capabilities, Room 70/G2 Single or Dual is an ideal all-in-one solution for large meeting rooms seating up to 14 people.

Like the Room 70 Dual only with smaller screens, **Cisco Room 55 Dual** is based on the Codec Plus, and includes a quad camera, and two 55" 4K screens with integrated speakers and microphones*. Room 55 Dual is best suited to medium or large rooms for up to 12 people.

There are three mounting kit options for each of these products: a free-standing floor stand, a wall-secured floor stand, and a wall mount kit.



Room 70 Single G2 / Room 70 Single on a floor stand



Room 70 Dual G2 / Room 70 Dual on a floor stand

* Integrated microphones for speaker tracking only.

Board

Board Pro

Codec EQ

Codec Plus

Codec Pro

Desk, Desk Pro, DeskMini

Room Bar

Room Kit

Room Kit Mini

Room 55

Room 55 Dual, Room 70

Room 70 G2

Room 70 Panorama

Room Panorama

Room Series at a glance (page 3 of 3)

Room Panorama, Room 70 Panorama

Built for the modern C-suite, **Cisco Room Panorama** transforms large meeting spaces and brings teams from around the world, face-to-face.

An all-in-one solution with the Codec Pro and Quad Camera at its core, Room Panorama features two 82-inch 8K video screens and a 65-inch 4K screen for content presentation. The camera provides panorama video, speaker-tracking, and auto-framing capabilities. The specially made integrated loudspeaker system consists of twelve main loudspeakers and four separate bass loudspeakers, driven by a sixteen channel amplifier. You won't miss a word with an integrated microphone array for accurate speaker tracking, and support for up to eight external microphones.

Cisco Room 70 Panorama is a high-end collaboration system, easily scalable for medium to large conference rooms and spaces. Based on the Cisco Room 70 Dual G2, Room 70 Panorama includes a powerful codec, a quad-camera, two 70-inch LED screens, and a 55-inch or 65-inch 4K screen for content presentation. Integrated loudspeakers and microphones ensure accurate speaker-tracking, and the system supports up to eight external microphones. The camera offers panorama video, speaker-tracking, and auto-framing capabilities. There are three mounting kit options: a free-standing floor stand, a wall-secured floor stand, and a wall mount kit.



Room Panorama



Room 70 Panorama,
wall mounted with 65-inch content screen above



Room 70 Panorama,
floor stand with 55-inch content screen below

Board

Board Pro

Codec EQ

Codec Plus

Codec Pro

Desk, Desk Pro, Desk Mini

Room Bar

Room Kit

Room Kit Mini

Room 55

Room 55 Dual, Room 70

Room 70 G2

Room 70 Panorama

Room Panorama

Desk Series at a glance

The **Cisco Desk Pro**, **Cisco Desk**, and **Cisco Desk Mini** devices are designed for personal desk-based collaboration, in an office or focus room that accommodates one or two people. Featuring a high resolution touchscreen, a camera* with wide angle view, and an advanced audio system, the Desk Series provides an exceptional video experience as powerful as Cisco's Room Series but designed for the desktop.

With a USB-C connection for touch-redirect, easy content sharing, and screen extension, a Desk Series device becomes your all-in-one primary monitor and collaboration device.



Desk Pro: shown from the front and side



Desk Mini

Board

Board Pro

Codec EQ

Codec Plus

Codec Pro

Desk, Desk Pro, Desk Mini

Room Bar

Room Kit

Room Kit Mini

Room 55

Room 55 Dual, Room 70

Room 70 G2

Room 70 Panorama

Room Panorama

Board Series at a glance

Cisco Board and **Cisco Board Pro** are all-in-one devices with 4K camera, built-in microphones and speakers, and a high-resolution 4K touchscreen.

The devices combines premium visual collaboration, video conferencing, and co-creation. They help teams to collaborate in a variety of physical meeting spaces and connect with remote members by joining video meetings, digital whiteboarding, presenting and sharing content.

Board Pro

There are three mounting options available for Board Pro: floor stand, wheel base, or wall mounted.

Board Pro is available in two different screen sizes and is designed for small to large sized meeting spaces:

- **Board Pro 55** with a 55" LED screen.
- **Board Pro 75** with a 75" LED screen.



Board Pro on a wheel base



Board Pro on a floor stand

Board

There are three mounting options available for Board: floor stand, wall stand, or wall mounted.

Board is available in three different screen sizes:

- **Board 55 and 55S** with a 55" LED screen. Designed for huddle spaces for up to five people.
- **Board 70 and 70S** with a 70" LED screen. Designed for meeting rooms for up to eight people.
- **Board 85S** with a 85" LED screen. Designed for larger collaboration spaces such as auditoriums, training spaces, and classrooms.

The second generation of Board is referred to as the *S Series*, representing some minor optimizations to the hardware platform.



Board Pro, wall mounted

Board

Board Pro

Codec EQ

Codec Plus

Codec Pro

Desk, Desk Pro, Desk Mini

Room Bar

Room Kit

Room Kit Mini

Room 55

Room 55 Dual, Room 70

Room 70 G2

Room 70 Panorama

Room Panorama

How to administer the video conferencing device (page 1 of 5)

In general, we recommend you to use the device web interface to administer and maintain the device, as described in this administrator guide.

Alternatively, you can access the API of the device by other methods:

- HTTP/HTTPS (also used by the device web interface)
- WebSocket
- SSH
- Serial connection

If you want more information about the different access methods, and how to use the API, refer to the *API guide* for the device.

Tip

If the configuration or status is available in the API, the web interface setting or status translates into an API configuration or status as follows:

Set *X > Y > Z* to **Value** (web)
is the same as
`xConfiguration X Y Z: Value` (API)

Check *X > Y > Z* status (web)
is the same as
`xStatus X Y Z` (API)

For example:

Set *SystemUnit > Name* to **MySystem**
is the same as
`xConfiguration SystemUnit Name: MySystem`

Check *SystemUnit > Software > Version* status
is the same as
`xStatus SystemUnit Software Version`

More settings and statuses are available in the device web interface than in the API.

Access method	Notes	How to enable/disable the methods
HTTP/HTTPS	<ul style="list-style-type: none"> • Used by the device web interface • Non-secure (HTTP) or secure (HTTPS) communication • HTTPS: <i>Enabled</i> by default • HTTP: <i>Enabled</i> by default only for devices that have been upgraded to CE9.4 (or later) from an earlier software version, provided that the device has not been factory reset after the upgrade 	<p>NetworkServices > HTTP > Mode</p> <p>Restart the device for changes to take effect</p>
WebSocket	<ul style="list-style-type: none"> • Tied to HTTP, so that also HTTP or HTTPS must be enabled before you can use WebSocket • Encrypted (wss) or unencrypted (ws) communication • <i>Disabled</i> by default 	<p>NetworkServices > HTTP > Mode</p> <p>NetworkServices > WebSocket</p> <p>Restart the device for changes to take effect</p>
SSH	<ul style="list-style-type: none"> • Secure TCP/IP connection • <i>Enabled</i> by default 	<p>NetworkServices > SSH > Mode</p> <p>You do not need to restart the device. It may take some time for changes to take effect</p>
Serial connection	<ul style="list-style-type: none"> • Connect to the device with a cable. IP-address, DNS, or a network is not required • <i>Enabled</i> by default • We recommend using the default baud rate, because the device may return much feedback (SerialPort > BaudRate) • For security reasons, you are asked to sign in by default (SerialPort > LoginRequired)* 	<p>SerialPort > Mode</p> <p>Restart the device for changes to take effect</p>

* *For Board:* The *SerialPort > LoginRequired* setting is on only available on Board 55S, 70S, and 85S. You always have to sign in on Board 55 and 70.



If all access methods are disabled (set to **Off**), you can no longer configure the device. You are not able to re-enable (set to **On**) any of the access methods, and you must factory reset the device to recover.

Board

Board Pro

Codec EQ

Codec Plus

Codec Pro

Desk, Desk Pro, Desk Mini

Room Bar

Room Kit

Room Kit Mini

Room 55

Room 55 Dual, Room 70

Room 70 G2

Room 70 Panorama

Room Panorama

How to administer the video conferencing device (page 2 of 5)

The device web interface

The device web interface is the administration portal for the device. You can connect from a computer and administer the device remotely. It provides full configuration access and offers tools and mechanisms for maintenance.

Note: The device web interface requires that HTTP or HTTPS is enabled (refer to the [NetworkServices > HTTP > Mode](#) setting).

We recommend that you use the latest release of one of the major web browsers. ¹

Connect to the device

Open a web browser and enter the IP address of the device in the address bar.

How to find the IP address

1. Swipe in from the right or tap the controls icon  in the upper, right corner to open the control panel. Then select [Device settings](#). ²
2. Select [About this room device](#).

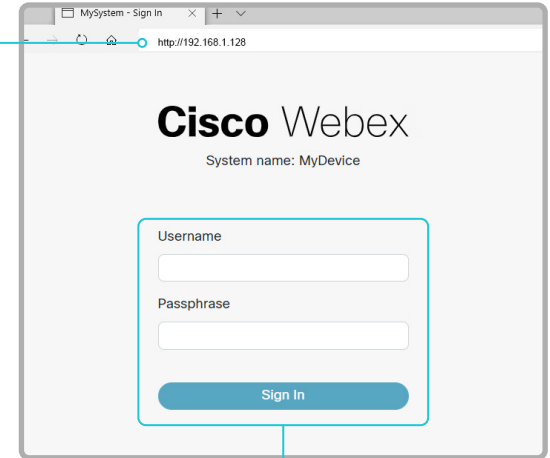

Sign in

Enter user name and passphrase for the device and click [Sign In](#).

-  The device is delivered with a default user named *admin* with no passphrase. Leave the [Passphrase](#) field blank if a passphrase is not set yet.

It is mandatory to set a password for the *admin* user.

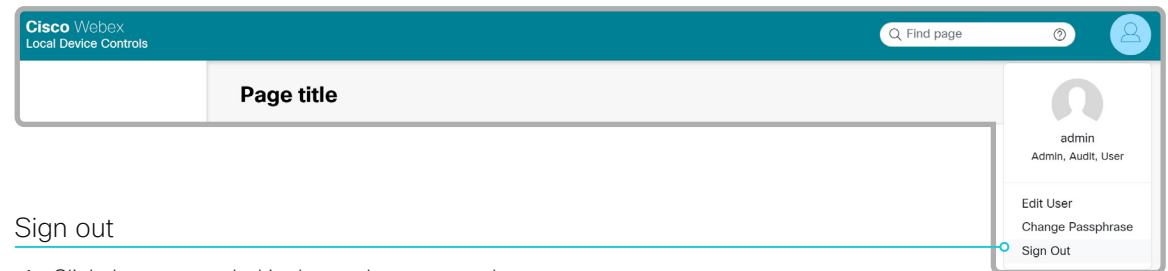

Sign out

1. Click the user symbol in the top bar to open the menu.
2. Click [Sign Out](#).

¹ Internet Explorer is not supported.

² For Room 70 Panorama and Room Panorama: Select the device name or address at the top of the user interface. Then select [Settings](#).

How to administer the video conferencing device (page 3 of 5)

How the device web interface is organized

Select pages or topics from the menu at the left side. There is a search field in the top bar to help you find the page you are searching for.

Which pages are present depends on:

- Device type and service registration (Webex, Cisco UCM, VCS, Webex Edge for Devices)
- Connected peripherals and setup
- Roles and access rights of the user that is signed in

This means that some of the menu entries shown in the illustration below may not be present on your device.

Read more about user administration, user roles and access rights in the ► [User administration](#) chapter.

Device name and type

Main menu

Click an item to open a page.

Cards

The information on a page, tab, or sub-tab, may be further grouped in cards.

Page title

Tab 1

Tab 2

Tab 3

Tabs

On some pages the information is organized in tabs. There may also be sub-tabs.

The selected tab is highlighted.

The user menu

Click the symbol to show who is signed in. You can also edit the user settings, change your password, and sign out.

Search field

Use this field to search for a page. Suggestions for relevant pages appear when you start typing. When you click on one of them, the corresponding page opens.

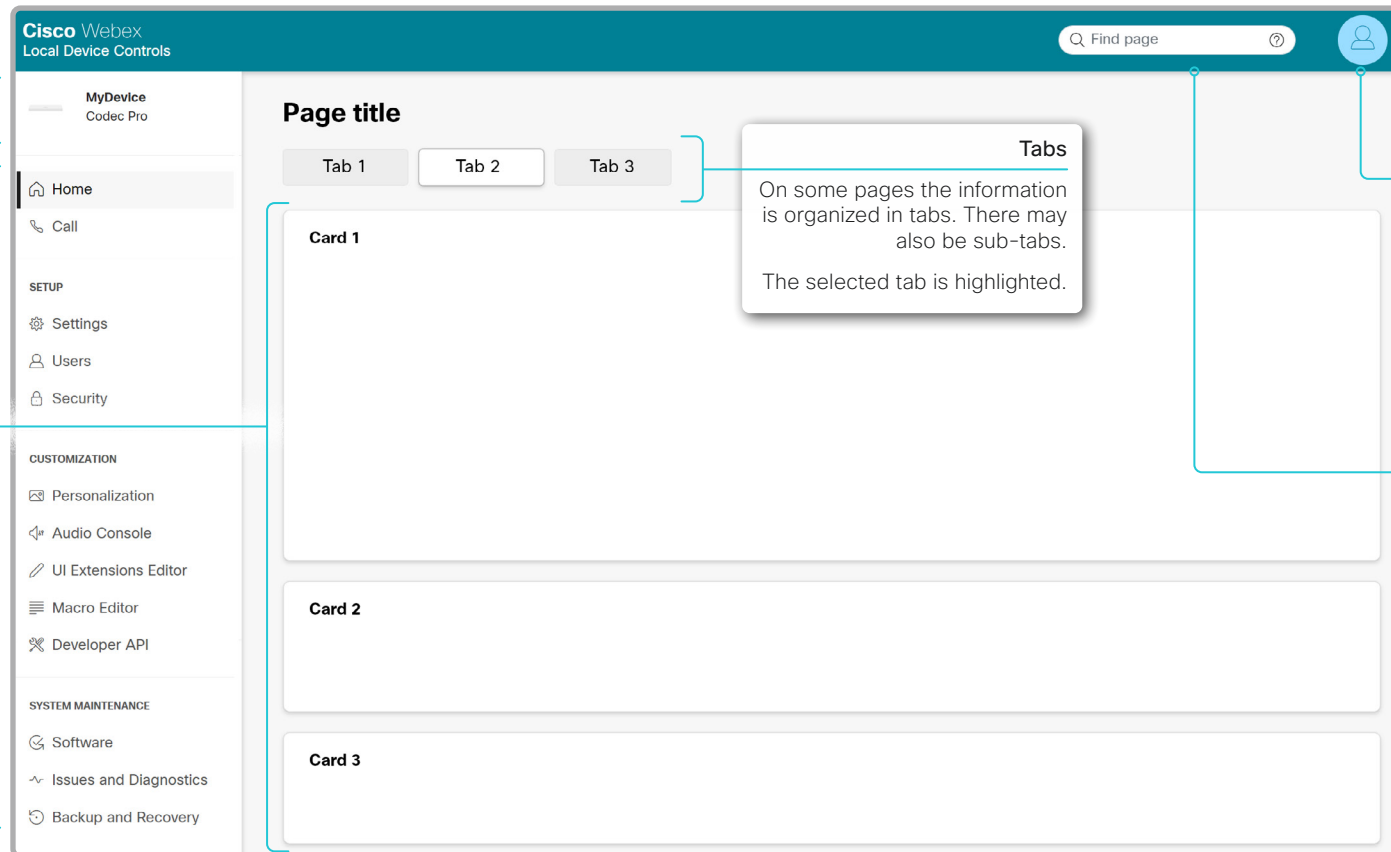

Board

Board Pro

Codec EQ

Codec Plus

Codec Pro

Desk, Desk Pro, Desk Mini

Room Bar

Room Kit

Room Kit Mini

Room 55

Room 55 Dual, Room 70

Room 70 G2

Room 70 Panorama

Room Panorama

D15503.01

RoomOS 11.1

02-2023

How to administer the video conferencing device (page 4 of 5)

The main menu of the device web interface

- Board
- Board Pro
- Codec EQ
- Codec Plus
- Codec Pro
- Desk, Desk Pro, Desk Mini
- Room Bar
- Room Kit
- Room Kit Mini
- Room 55
- Room 55 Dual, Room 70
- Room 70 G2
- Room 70 Panorama
- Room Panorama

Opens a page where you can set up a call from the device. You can change the camera position, mute the microphones, adjust the volume, change layouts, and check the call details.

Opens a page where you can add, edit, or delete users, or change a users passphrase. You can also create a remote support user from this page.

Opens a page where you can upload and view certificates that are required to communicate with different services and backends. You can also create a sign-in banner, and choose which system components to reset automatically when restarting the device.

Opens the UI Extensions Editor, which allows you to create custom UI panels and action buttons.

Opens a page where you can view the device's XML files, and execute commands and configurations.

Opens a page where you can look at active diagnostics messages, download logs, and create screenshots of the user interface and on-screen messages and indicators.

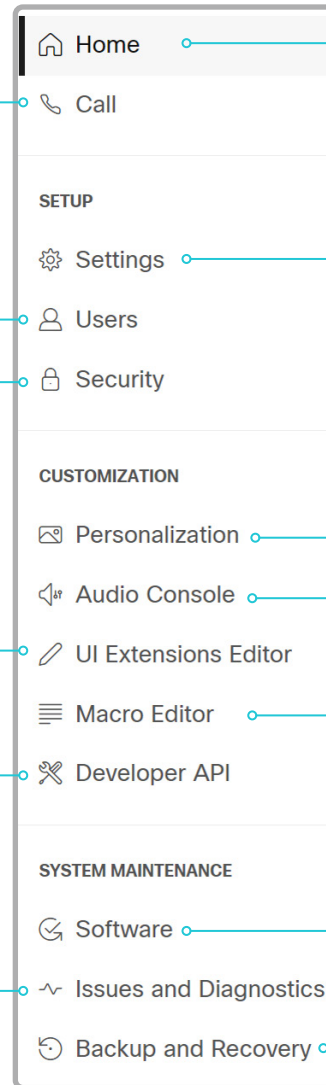

Lists general information such as IP address, MAC address, serial number, active network interface, software version, SIP address, issues, registration status, utilization and environment data, and more.

Opens a page with access to:

- Device configurations and statuses.
- Predefined room type templates. *(Only for Codec EQ, Codec Plus, Codec Pro, Room 55 Dual, Room 70, and Room 70 G2)*
- Details about cameras, screens, microphones, and other inputs, outputs, and peripherals.
- Setting up and enabling presenter tracking if you have a camera that supports the feature. *(Only for Codec Plus, Codec Pro, Room 55 Dual, Room 70, and Room 70 G2)*
- Setting up an SMTP server so that you can send whiteboards and annotations via email. *(Only for Desk, Desk Mini, Desk Pro, Board, Board Pro, and Room Kit Mini with Samsung Flip)*

Opens a page where you can personalize the device by adding branding elements or other background images, selecting a ringtone, and creating a local contacts list (favorites).

Opens the Audio Console, which provides a graphical interface that allows advanced customization of audio features. *(Only for Codec EQ with AVIntegrator option, Codec Pro, Room 70 G2, Room Panorama, and Room 70 Panorama)*

Opens the Macro Editor, which allows you to create snippets of code (macros) that automates or customizes the behavior of your device.

Opens a page where you can install new software* and option keys. You can also change the product key; only change the product key if you are directed to do so by a Cisco technical support representative.

Opens a page where you can backup and restore information on your device, such as branding elements, favorites list, UI extensions, macros, the sign in banner, and configurations. You can also swap to the previous software image, factory reset, restart, or shut down the device.

* Not available for cloud registered devices.

Board

Board
ProCodec
EQCodec
PlusCodec
ProDesk,
Desk Pro,
Desk MiniRoom
Bar

Room Kit

Room Kit
Mini

Room 55

Room 55
Dual,
Room 70Room 70
G2Room 70
PanoramaRoom
Panorama

How to administer the video conferencing device (page 5 of 5)

Settings and device information on the user interface

You have access to device information, and some basic configurations and device tests on the device's user interface.

Device-critical settings and functions, such as network settings, service activation, and factory reset, may be protected by a passphrase, refer to the ► [Restrict the access to the Settings menu](#) chapter.

Some of the settings and tests are also part of the *Setup assistant* that is launched when the device is powered up for the first time.

Access Settings

1. Swipe in from the right or tap the controls icon  in the upper, right corner to open the control panel. Then select [Device settings](#).*

A padlock symbol  indicates that a setting is protected (locked down).

2. Select the setting you want to change, or the test you want to run.

If a setting is locked down, an authentication window pops up, and you have to sign in with ADMIN credentials to proceed. If the device is registered to the Webex cloud, the settings must be unlocked from Control Hub.

For Board and Board Pro

If you have connected a touch controller to the board, the two devices operate independently in this context. If you unlock the settings by signing in on one of them, it has no effect on the other.

* For Room 70 Panorama and Room Panorama: Select the device name or address at the top of the user interface. Then select [Settings](#).

Board

Board
ProCodec
EQCodec
PlusCodec
ProDesk,
Desk Pro,
Desk MiniRoom
Bar

Room Kit

Room Kit
Mini

Room 55

Room 55
Dual,
Room 70Room 70
G2Room 70
PanoramaRoom
Panorama

Touch controllers

Controlling a video conferencing device

Touch controllers are Cisco interface units that are used to control the video conferencing devices.

At present there are three such interface units available, all referred to interchangeably as 'touch controllers':

- Cisco Room Navigator
- Cisco Touch 10
- Cisco TelePresence Touch 10

Touch controllers provide instant access to meetings, content, contacts, directories, and more. You can customize the user interface with custom buttons and panels, as described in the Customization Guide. The Room Navigator also offers environmental sensors for monitoring things like air quality and temperature.

Touch controllers can be connected directly to a device, or remotely paired to the device via the network (LAN).

See the ► [Connect the touch controller](#) chapter about how to connect a touch controller to the video conferencing device.

Video conferencing device compatibility

Room Navigator is supported by:

- Codec EQ, Codec Plus, and Codec Pro
- Room Series
- Board 55S, 70S, 85S
- Board Pro

Touch 10 and TelePresence Touch 10 are supported by:

- Codec Plus and Codec Pro
- Room Kit, Room Kit Mini, Room 55, Room 55 Dual, Room 70, Room 70 G2, Room 70 Panorama, and Room Panorama
- Board 55S, 70S, and 85S
- Board 55 and 70

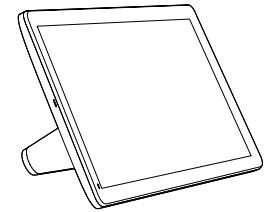

Cisco Room Navigator
(launched early 2021)

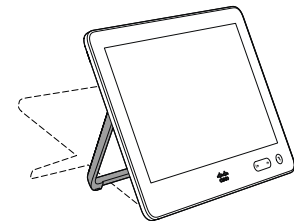

Cisco Touch 10
(second version, launched late 2017)

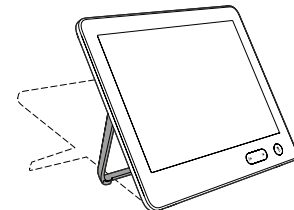

Cisco TelePresence Touch 10
(first version)

Board

Board
Pro

Codec
EQ

Codec
Plus

Codec
Pro

Desk,
Desk Pro,
Desk Mini

Room
Bar

Room Kit

Room Kit
Mini

Room 55

Room 55
Dual,
Room 70

Room 70
G2

Room 70
Panorama

Room
Panorama

Chapter 2

Configuration

Board

Board
ProCodec
EQCodec
PlusCodec
ProDesk,
Desk Pro,
Desk MiniRoom
Bar

Room Kit

Room Kit
Mini

Room 55

Room 55
Dual,
Room 70Room 70
G2Room 70
PanoramaRoom
Panorama

User administration

You must sign in to the device with a local user, for example to access the device web interface or command line interfaces. You can assign different roles to users, to determine what they should have access to.

The default user account

The device comes with a default administrator user account with full access rights. The user name is *admin*, and initially, no passphrase is set.



It is mandatory to set a passphrase for the *admin* user.

On a new or factory reset device, the calling functionality is disabled until you set a passphrase.

Read how to set the passphrase in the ► [Change the device passphrase](#) chapter.

Create a new user account

1. Sign in to the device web interface and go to [Users](#).
2. Click [Create User](#).
3. Fill in the *Username*, *New passphrase* and *Confirm passphrase* input fields.

As a default, users have to change the passphrase when they sign in for the first time.

Fill in the *Client Certificate DN* (Distinguished Name) field only if you use client certificates for authentication.

4. Check the appropriate *Roles* check boxes.
If you assign the ADMIN role to a user, enter your own passphrase in the *Your passphrase* input field for verification.
5. Set the *Status* to **Active** to activate the user.
6. Click [Create User](#).
Use the [Back](#) button to leave without making any changes.

Edit an existing user account

If you make changes to a user that holds the Admin role, you must always enter your own passphrase in the *Your passphrase* input field for verification.

Change the user privileges

1. Sign in to the device web interface and go to [Users](#).
2. Click the appropriate user in the list.
3. Choose user roles, set the status to **Active** or **Inactive**, and decide if the user has to change the passphrase on the next sign in.
Fill in the Client Certificate DN (Distinguished Name) field only if you use certificate login on HTTPS.
4. Click [Save User](#).
Use the [Back](#) button to leave without making any changes.

Change the passphrase

1. Sign in to the device web interface and go to [Users](#).
2. Click the appropriate user in the list.
3. Find the *Passphrase* card and enter the new passphrase in the appropriate input fields.
4. Click [Set New Passphrase](#) to save the change.
Use the [Back](#) button to leave without making any changes.

Delete the user account

1. Sign in to the device web interface and go to [Users](#).
2. Click the appropriate user in the list.
3. Find the *Delete* card, click [Delete User](#) and confirm when prompted.

User roles

A user account may hold one or a combination of *user roles*. A user account with full access rights, like the default *admin* user, should possess the ADMIN, USER and AUDIT roles.

These are the *user roles*:

ADMIN: A user with this role can create new users, change most settings, make calls, and search the contact lists. The user cannot upload audit certificates and change the security audit settings.

USER: A user with this role can make calls and search the contact lists. The user can modify a few settings, for example adjust the ringtone volume and set the time and date format.

AUDIT: A user with this role can change the security audit settings and upload audit certificates.

ROOMCONTROL: A user with this role can create customized UI panels (for example in-room controls). The user has access to the UI Extensions editor and corresponding development tools.

INTEGRATOR: A user with this role has access to settings, commands and status that are required to set up advanced AV scenarios, and to integrate our devices with 3rd party equipment. Such a user can also create customized UI panels.

Board

Board Pro

Codec EQ

Codec Plus

Codec Pro

Desk, Desk Pro, Desk Mini

Room Bar

Room Kit

Room Kit Mini

Room 55

Room 55 Dual, Room 70

Room 70 G2

Room 70 Panorama

Room Panorama

Change the device passphrase

You must sign in to the device with a local user, for example to access the device web interface or command line interfaces.

The default user account

The device comes with a default administrator user account with full access rights. The user name is *admin*, and initially, no passphrase is set.



It is mandatory to set a passphrase for the default *admin* user in order to restrict access to device configuration.

On a new or factory reset device, the calling functionality is disabled until you set a set a passphrase.

A security risk warning, saying that the system passphrase is not set and calling is disabled, is shown on screen until a passphrase is set for the *admin* user.

Other user accounts

You can create many user accounts for the device.

Read more about how to create and manage user accounts in the ► [User administration](#) chapter.

Passphrase policy

When signing in to the device as a local user, the password must follow the rules set by the [UserManagement > PasswordPolicy](#) settings. These are rules such as minimum length, minimum number of upper case and lower case letters, minimum number of digits and special characters, how long before a password expires, and how soon a password can be reused.

A new password rule will not apply to existing passwords but will take effect on the next password change.

Change your passphrase

1. Sign in to the device web interface, and click the user symbol in the top bar to open the menu.
2. Click [Change Passphrase](#).
3. Enter new and current passphrases in the appropriate input fields, and click [Set New Passphrase](#).



If the passphrase currently is not set, leave the [Current passphrase](#) field blank.

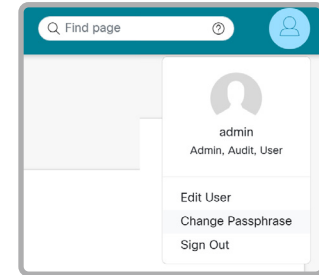

Change another user's passphrase

If you have administrator access rights, you can change the password of any user.

1. Sign in to the device web interface and go to [Users](#).
2. Click the appropriate user in the list.
3. Enter the new passphrase in the *New passphrase* and *Confirm passphrase* input fields.
If the user holds the Admin role, you must enter your own passphrase in the *Your passphrase* input field for verification.
4. Click [Set New Passphrase](#) to save the change.
Use the [Back](#) button to leave without making any changes.

Board

Board Pro

Codec EQ

Codec Plus

Codec Pro

Desk, Desk Pro, Desk Mini

Room Bar

Room Kit

Room Kit Mini

Room 55

Room 55 Dual, Room 70

Room 70 G2

Room 70 Panorama

Room Panorama

Restrict the access to the Settings menu

By default, any user has access to the Settings menu on the user interface.

We recommend that you restrict the access to prevent unauthorized users from changing the configuration of the device.

For Board and Board Pro

If you are using a touch controller with the board, you have access to the Settings menu both on the board itself and on the touch controller. In this context, the board and the touch controller operate independently. If you unlock the settings by signing in on one of them, it has no effect on the other.

Lock down the Settings menu

1. Sign in to the device web interface, go to [Settings](#), and select [Configurations](#).
2. Go to [UserInterface > SettingsMenu > Mode](#), and select **Locked**.
3. Click [Save](#) for the change to take effect.

Now a user has to sign in with ADMIN credentials to get access to the device-critical settings on the user interface.

Unlock the Settings menu

1. Sign in to the device web interface, go to [Settings](#), and select [Configurations](#).
2. Go to [UserInterface > SettingsMenu > Mode](#), and select **Unlocked**.
3. Click [Save](#) for the change to take effect.

Now all users have access to the complete Settings menu on the user interface.

The Settings menu on the user interface

If the menu is locked down, you must sign in to access the device-critical settings.

- Swipe in from the right or tap the controls icon  in the upper, right corner to open the control panel. Then select [Device settings](#).*

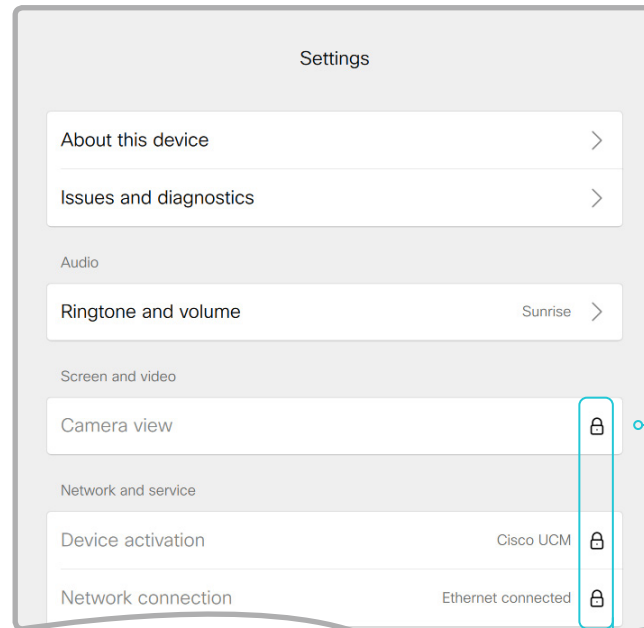

Locked down settings

Locked down settings are marked with a padlock.

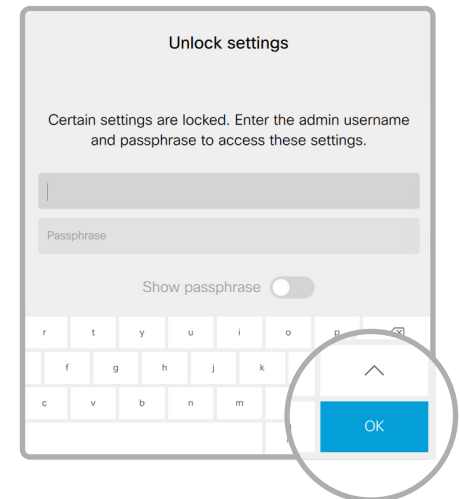

Unlock settings

If you click on the padlock, you are asked to sign in with an ADMIN user. Once signed in, you can access all settings until you close the Settings menu.

If the device is registered to the Webex cloud, the settings must be unlocked from Control Hub.

* For Room 70 Panorama and Room Panorama: Select the device name or address at the top of the user interface. Then select [Settings](#).

- Board
- Board Pro
- Codec EQ
- Codec Plus
- Codec Pro
- Desk, Desk Pro, Desk Mini
- Room Bar
- Room Kit
- Room Kit Mini
- Room 55
- Room 55 Dual, Room 70
- Room 70 G2
- Room 70 Panorama
- Room Panorama

Device configuration

Sign in to the device web interface, go to [Settings](#), and select [Configurations](#).

Find a device setting

Search for settings

Enter as many letters as needed in the search field. All settings that contain these letters are shown in the right pane. Settings that have these letters in their value space are also shown.

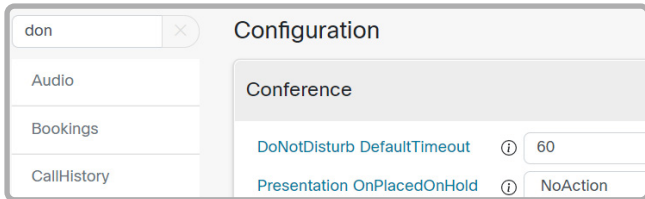

Select a category and navigate to settings

The device settings are grouped in categories. Choose a category in the left pane to show the associated settings.

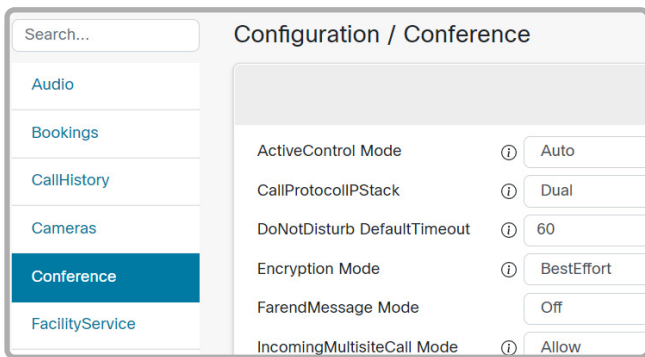

Change a device setting

Check the value space

A settings's value space is specified either by text following the input field or in a drop-down list that opens when you click the arrow.

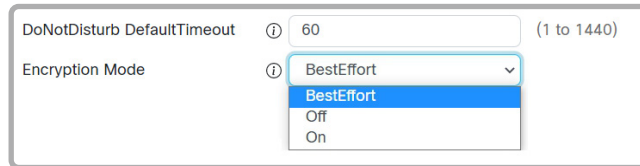

Change a value

1. Choose the preferred value from the drop-down list, or enter new text in the input field.
2. Click [Save](#) for the change to take effect.

Use the [Revert](#) buttons if you don't want to make any changes.

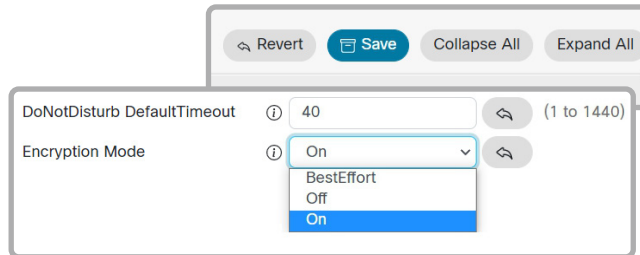

Categories with unsaved changes are marked with an edit symbol .

About device settings

All device settings can be changed from the device web interface.

Each device setting is described in the [► Device settings](#) chapter.

Different settings may require different user credentials. In order to be sure that an administrator is able to change all device settings, an administrator user must possess all user roles.

You can read more about user administration and user roles in the [► User administration](#) chapter.

Board

Board Pro

Codec EQ

Codec Plus

Codec Pro

Desk, Desk Pro, Desk Mini

Room Bar

Room Kit

Room Kit Mini

Room 55

Room 55 Dual, Room 70

Room 70 G2

Room 70 Panorama

Room Panorama

Add a sign in banner

Sign in to the device web interface, go to *Security*, and select *Sign-in Banner*.

Add a sign in banner

1. Enter the message that you want to present to the user when he signs in.
2. Click *Save* to activate the banner.

Delete a sign in banner

- Click *Clear* to remove a sign in banner.

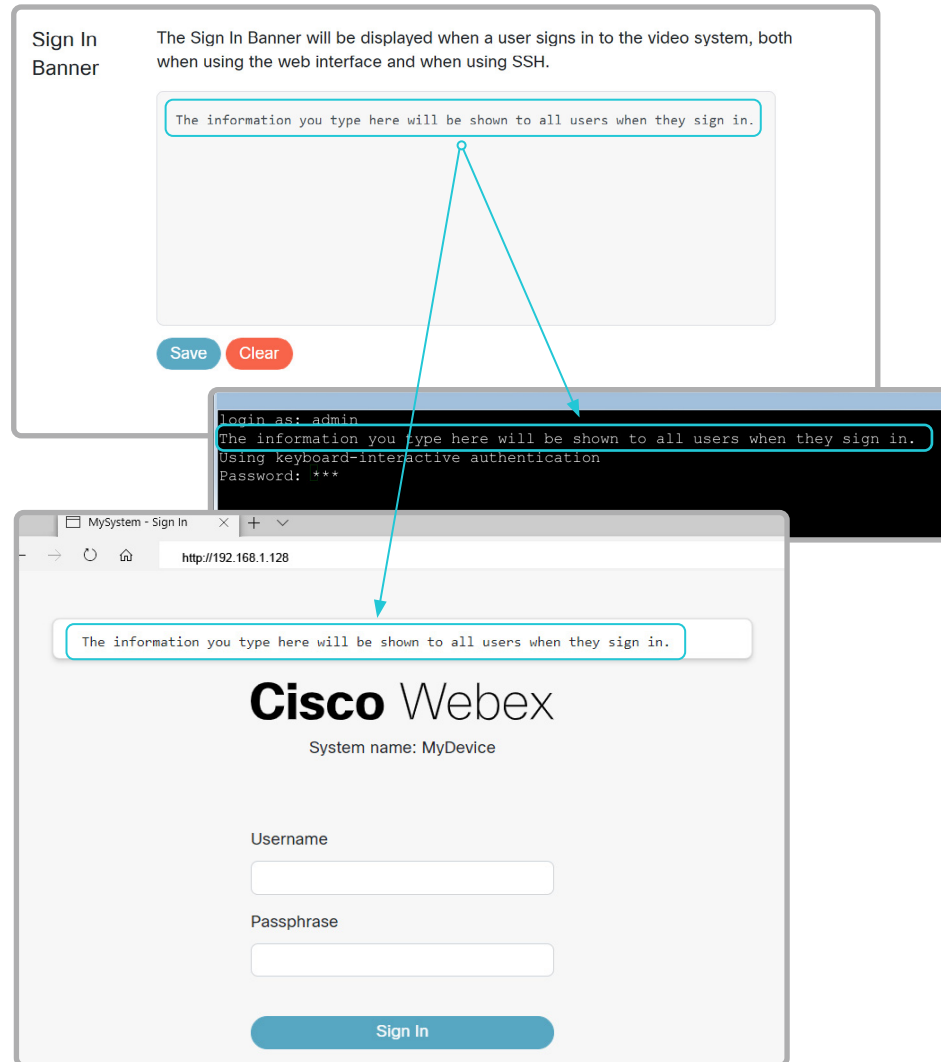

About sign in banner

If a device administrator wants to provide initial information to all users, he can create a sign in banner. The message is shown when the user signs in to the device web interface or the command line interface.

The maximum size is: 4kByte

Welcome banner versus sign in banner

Sign in banner:

- The banner is shown *before* the user signs in to the device web interface or the command line interface.

Welcome banner:

- The banner is shown *after* the user has signed in to the device web interface or the command line interface.

Board

Board Pro

Codec EQ

Codec Plus

Codec Pro

Desk, Desk Pro, Desk Mini

Room Bar

Room Kit

Room Kit Mini

Room 55

Room 55 Dual, Room 70

Room 70 G2

Room 70 Panorama

Room Panorama

Add a welcome banner

Adding a Welcome banner is only available using API commands; we don't provide a dedicated user interface for it.

API commands

```
xCommand SystemUnit WelcomeBanner Set
```

This is a multiline command. Anything you input after you issue the command, is input to the command (including line breaks). Finish the input with a separate line containing just a period ending with a line break.

There are also a few more welcome banner commands, refer to the API-guide for more details.

```
xCommand SystemUnit WelcomeBanner Clear
```

```
xCommand SystemUnit WelcomeBanner Get
```

Example

```
xCommand SystemUnit WelcomeBanner Set <enter>
```

```
This is a welcome banner. <enter>
```

```
A welcome banner may have multiple lines. <enter>
```

```
. <enter>
```

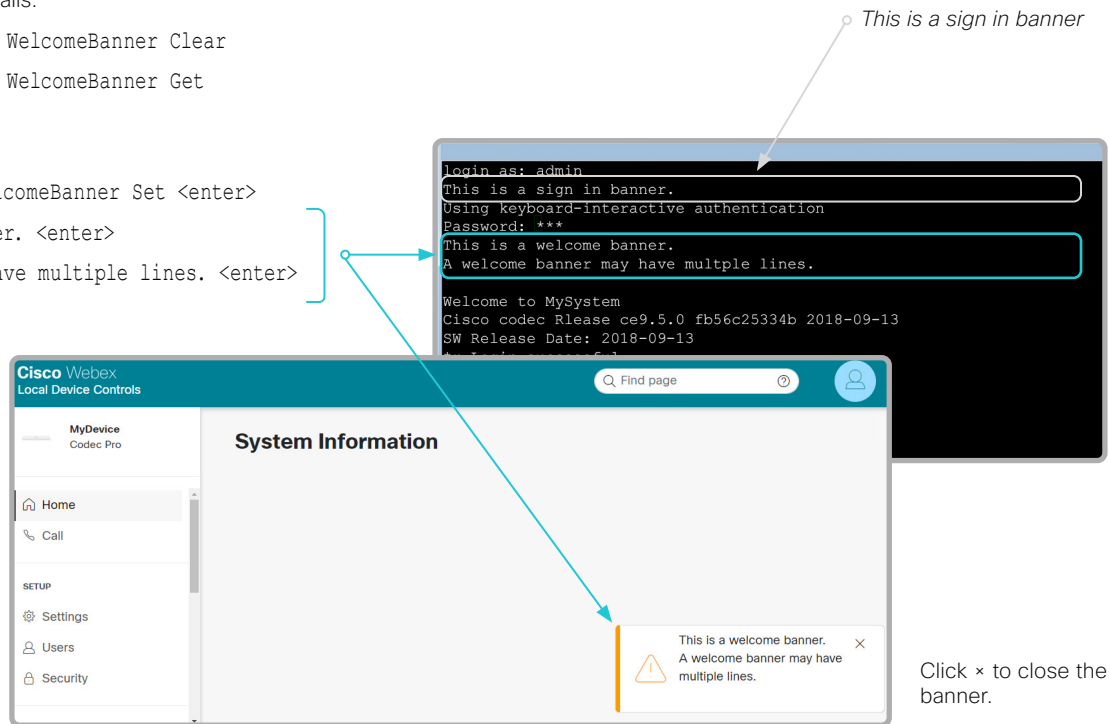

About welcome banner

You can set up a welcome banner that users see after they sign in to the device web interface or command line interface. The banner can have multiple lines.

The banner can for example contain information you need in order to get started, or things you must be aware of when setting up the device.

The maximum size is: 4 kByte

Welcome banner versus sign in banner

Sign in banner:

- The banner is shown *before* the user signs in to the device web interface or the command line interface.

Welcome banner:

- The banner is shown *after* the user has signed in to the device web interface or the command line interface.

Board

Board Pro

Codec EQ

Codec Plus

Codec Pro

Desk, Desk Pro, Desk Mini

Room Bar

Room Kit

Room Kit Mini

Room 55

Room 55 Dual, Room 70

Room 70 G2

Room 70 Panorama

Room Panorama

Manage the service certificates of the device

Sign in to the device web interface and go to [Security](#). Select [Certificates](#), and open the [Services](#) sub-tab.

You need the following files:

- Certificate (file format: .PEM)
- Private key, either as a separate file or included in the same file as the certificate (file format: .PEM format)
- Passphrase (required only if the private key is encrypted)

The certificate and the private key will be stored in the same file on the device.

Add a certificate

1. Browse to find the Certificate file and Private key file (optional) on your computer.
2. Fill in the [Passphrase](#) if required.
3. Click [Upload](#) to store the certificate on the device.
Only certificates with a validity period of up to 10 years are accepted.

Add Certificate Use the form below to add new certificates.

This system supports PEM formatted certificate files (.pem). The certificate file may contain the certificate and a RSA or DSA encrypted private key with or without a passphrase. Optionally the private key file may be supplied separately.

Certificate No file chosen
 Private key (optional) No file chosen
 Passphrase (optional)

Existing Certificates

Certificate	Issuer	802.1X	Audit	HTTPS	HttpClient	SIP	Pairing	Actions
Certificate_A	Certificatelssuer_A	<input type="checkbox"/>	<input type="checkbox"/>	<input checked="" type="checkbox"/>	<input type="checkbox"/>	<input type="checkbox"/>	<input type="checkbox"/>	Delete View Certificate
Certificate_B	Certificatelssuer_B	<input checked="" type="checkbox"/>	<input type="checkbox"/>	<input type="checkbox"/>	<input type="checkbox"/>	<input checked="" type="checkbox"/>	<input type="checkbox"/>	Delete View Certificate

Enable or disable, view or delete a certificate

Use the toggle buttons to enable or disable a certificate for the different services.

Use the corresponding button to view or delete a certificate.

About the service certificates of the device

Certificate validation may be required when using TLS (Transport Layer Security).

A server or client may require that the device presents a valid certificate to them before communication can be set up.

The device's certificates are text files that verify the authenticity of the device. These certificates may be issued by a certificate authority (CA).

Certificates are used for the following services: HTTPS server, HTTP client, SIP, IEEE 802.1X and audit logging.

You can store many certificates on the device, but only one certificate can be enabled for each service at a time.

If authentication fails, the connection will not be established.

The certificates and certificate issuers in the illustration are examples. Your device has other certificates.

Board

Board
ProCodec
EQCodec
PlusCodec
ProDesk,
Desk Pro,
Desk MiniRoom
Bar

Room Kit

Room Kit
Mini

Room 55

Room 55
Dual,
Room 70Room 70
G2Room 70
PanoramaRoom
Panorama

Manage the lists of trusted certificate authorities – CAs (page 1 of 4)

Certificate validation may be required when using TLS (Transport Layer Security).

You can configure the device to demand that a server or client presents its certificate before communication is set up. The device uses the certificate to verify the authenticity of the server or client. If authentication fails, the connection will not be established.

The certificate (text file) must be signed by a trusted Certificate Authority (CA). Lists of certificates from trusted CAs reside on the device.

The CA certificate lists

You can check and maintain the lists of trusted CAs from the device web interface:

- Sign in to the device web interface, go to [Security](#), and select [Certificates](#). There is one tab for each CA list.

These are the CA lists:

- **Preinstalled:** Pre-installed CA certificates that are used to validate the certificates of external servers, such as HTTPS, SMTP (*only Board, Board Pro, Desk, Desk Mini, Desk Pro, and Room Kit Mini with Samsung Flip*), and syslog, that the device communicates with.
- **Collaboration Edge:** Pre-installed CA certificates that are used to validate the certificates of servers contacted over the Internet when the device is provisioned by Cisco Unified Communications Manager (CUCM) via Expressway (also known as MRA).
- **Custom:** CA certificates that you have uploaded to the device yourself. The list must include all CAs that are needed in order to verify certificates for both logging and other connections, if those certificates are not already included in the pre-installed lists.

Board

Board Pro

Codec EQ

Codec Plus

Codec Pro

Desk, Desk Pro, Desk Mini

Room Bar

Room Kit

Room Kit Mini

Room 55

Room 55 Dual, Room 70

Room 70 G2

Room 70 Panorama

Room Panorama

Manage the lists of trusted certificate authorities - CAs (page 2 of 4)

Manage pre-installed CA certificates for external servers

Sign in to the device web interface and go to [Security](#). Select [Certificates](#), and open the [Preinstalled](#) sub-tab.

Preinstalled Certificates The Certificate Authorities listed below are used to validate the certificates of external servers that the video system communicates with:

- HTTP servers hosting content used by the web views, the `HttpClient` xAPI, Macros, etc.
- SMTP mail servers (on video systems with touch screens)

Certificate Details

Certificate	Issuer	Details	Enabled
Certificate_01	Issuer_1	View	<input checked="" type="checkbox"/>
Certificate_02	Issuer_2	View	<input checked="" type="checkbox"/>
Certificate_03	Issuer_3	View	<input checked="" type="checkbox"/>
Certificate_04	Issuer_4	View	<input checked="" type="checkbox"/>

View, enable or disable certificates

Use the [View](#) button to see certificate details.

Use the toggle button to enable or disable a certificate.

The certificates and certificate issuers in the illustration are examples. Your device has other certificates.



As an alternative to using the pre-installed certificates, you can append the certificates you need to the custom certificate list manually.

Refer to the [Upload a CA certificate to the device](#) chapter how to update the list of trusted CA certificates.

Pre-installed CA certificates

A list of commonly used CA certificates is pre-installed on the device. The device uses this list when validating certificates from external servers that it communicates with:

- HTTP servers that host content used by the HttpClient API or macros
- Provisioning servers
- Phone book servers
- Syslog servers (for external logging)
- SMTP mail servers (*only Board, Board Pro, Desk, Desk Mini, Desk Pro, and Room Kit Mini with Samsung Flip*)
- Servers and services used by the Cisco Webex cloud

Factory resetting the device does not delete the list of pre-installed certificates.

Board

Board Pro

Codec EQ

Codec Plus

Codec Pro

Desk, Desk Pro, Desk Mini

Room Bar

Room Kit

Room Kit Mini

Room 55

Room 55 Dual, Room 70

Room 70 G2

Room 70 Panorama

Room Panorama

Manage the lists of trusted certificate authorities - CAs (page 3 of 4)

Manage pre-installed CA certificates for CUCM via Expressway provisioning

Sign in to the device web interface and go to [Security](#). Select [Certificates](#), and open the [Collaboration Edge](#) sub-tab.

Collaboration Edge Certificates This CA list is used for Cisco UCM via Expressway (Edge) provisioning only.
[Configure provisioning now.](#)

These certificates are used to validate the servers contacted over the Internet when the endpoint uses Cisco UCM via Expressway provisioning.

You can either enable or disable all Edge certificates on the device by clicking the "Enable All"/"Disable All" button below, or toggle individual certificates on and off in the table.

[Disable All](#)

Certificate Details

Certificate	Issuer	Details	Enabled
Certificate_01	Issuer_1	View	<input checked="" type="checkbox"/>
Certificate_02	Issuer_2	View	<input checked="" type="checkbox"/>
Certificate_03	Issuer_3	View	<input checked="" type="checkbox"/>
Certificate_04	Issuer_4	View	<input checked="" type="checkbox"/>

View, enable or disable certificates

Use the [View](#) button to see certificate details.

Use the toggle button to enable or disable a certificate.

The certificates and certificate issuers in the illustration are examples. Your device has other certificates.



As an alternative to using the pre-installed certificates, you can append the certificates you need to the custom certificate list manually.

Refer to the [Upload a CA certificate to the device](#) chapter how to update the list of trusted CA certificates.

Pre-installed CA certificates for CUCM via Expressway

The pre-installed CA certificates in this list are only used when the device is provisioned by Cisco Unified Communications Manager (CUCM) via Expressway.

Only Cisco Expressway infrastructure certificates are checked against this list.

If the validation of the Cisco Expressway infrastructure certificate fails, the device will not be provisioned and registered.

Factory resetting the device does not delete the list of pre-installed certificates.

- Board
- Board Pro
- Codec EQ
- Codec Plus
- Codec Pro
- Desk, Desk Pro, Desk Mini
- Room Bar
- Room Kit
- Room Kit Mini
- Room 55
- Room 55 Dual, Room 70
- Room 70 G2
- Room 70 Panorama
- Room Panorama

Manage the lists of trusted certificate authorities - CAs (page 4 of 4)

Upload a CA certificate to the device

Sign in to the device web interface and go to [Security](#). Select [Certificates](#), and open the [Custom](#) sub-tab.

You need the following file:

- CA certificate list (file format: .PEM).

Upload a list of CA certificates

1. Browse to find the file containing the CA certificates on your computer (file format: .PEM).

2. Click [Upload](#) to store the new CA certificates on the device.

The button appears when you have chosen a file.

Add Certificate Authority Use the form below to add new certificate authorities.

This system supports PEM formatted files (.pem) with one or more CA certificates within the file.

No file chosen

Existing Certificate Authorities

Certificate	Issuer	Details	Enabled
Certificate_A	CertificateIssuer_A	<input type="button" value="View"/>	<input checked="" type="checkbox"/>

The certificates and certificate issuers in the illustration are examples. Your device has other certificates.

View, enable or disable certificates

Use the [View](#) button to see certificate details.

Use the toggle button to enable or disable a certificate.



Previously stored certificates are not deleted automatically.

The entries in a new file with CA certificates are appended to the existing list.

About the custom list of trusted CA certificates

This list contains the CA certificates that you have uploaded to the device yourself. They can be used to validate client and server certificates for both logging and other connections.

They can be used for:

- HTTP servers that host content used by the HttpClient API or macros
- Provisioning servers
- Phone book servers
- SIP servers
- Syslog servers (for external logging)
- SMTP mail servers (*only Board, Board Pro, Desk, Desk Mini, and Desk Pro*)
- Cisco Expressway infrastructure
- Servers and services used by the Cisco Webex cloud

Board

Board
ProCodec
EQCodec
PlusCodec
ProDesk,
Desk Pro,
Desk MiniRoom
Bar

Room Kit

Room Kit
Mini

Room 55

Room 55
Dual,
Room 70Room 70
G2Room 70
PanoramaRoom
Panorama

Set up secure audit logging

Sign in to the device web interface, go to [Settings](#), and select [Configurations](#).

1. Find the [Security > Audit > Server](#) settings, and enter the [Address](#) of the audit server.

If you set [PortAssignment](#) to **Manual**, you must also enter a [Port](#) number for the audit server.
2. Set [Security > Audit > Logging > Mode](#) to **ExternalSecure**.
3. Click [Save](#) for the change to take effect.



The certificate authority (CA) that verifies the certificate of the audit server must be in the device's list of trusted certificate authorities. Otherwise, logs will not be sent to the external server.

Refer to the ► [Upload a CA certificate to the device](#) chapter how to update the list.

Configuration / Security

Revert Save Collapse All Expand All

Fips Mode ⓘ Off

Audit

Logging Mode ⓘ ExternalSecure

OnError Action ⓘ ExternalSecure

Server

Address ⓘ (0 to 255 characters)

Port ⓘ 514 (0 to 65535)

PortAssignment ⓘ Auto

About secure audit logging

When audit logging is enabled, all sign in activity and configuration changes on the device are recorded.

Use the [Security > Audit > Logging > Mode](#) setting to enable audit logging. Audit logging is disabled by default.

In ExternalSecure audit logging mode the device sends encrypted audit logs to an external audit server (syslog server), which identity must be verified by a signed certificate.

The signature of the audit server is verified using the list of pre-installed CA certificates or the custom CA list.

If the audit server authentication fails, no audit logs are sent to the external server.

Board

Board
ProCodec
EQCodec
PlusCodec
ProDesk,
Desk Pro,
Desk MiniRoom
Bar

Room Kit

Room Kit
Mini

Room 55

Room 55
Dual,
Room 70Room 70
G2Room 70
PanoramaRoom
Panorama

Delete CUCM trust lists

This chapter is only relevant for devices that are registered to a Cisco Unified Communications Manager (CUCM).

Sign in to the device web interface and go to [Security](#). Select [Certificates](#), and open the [Unified CM](#) sub-tab.

Delete the CUCM trust lists

Click [Delete CTL/ITL](#) to remove the trust lists.



As a general rule, you should not delete old CTL (Certificate Trust List) and ITL (Initial Trust List) files.

In these cases, you must still delete them:

- When you change the CUCM IP address.
- When you move the endpoint between CUCM clusters.
- When you need to re-generate or change the CUCM certificate.

Overview of trust list fingerprints and certificates

The trust lists' fingerprints and an overview of the certificates in the lists are displayed on the web page.

This information may be useful for troubleshooting.

Board

Board
ProCodec
EQCodec
PlusCodec
ProDesk,
Desk Pro,
Desk MiniRoom
Bar

Room Kit

Room Kit
Mini

Room 55

Room 55
Dual,
Room 70Room 70
G2Room 70
PanoramaRoom
Panorama

Change the persistency mode

Sign in to the device web interface, go to [Security](#), and select [Persistency Settings](#).

Check the persistency status

The active radio buttons show the current persistency status of the device.

Alternatively, you can navigate to [Settings](#), select [Statuses](#), and check the [Security > Persistency](#) status.

Change the persistency settings

All persistency settings are set to **Persistent** by default. You only have to change these settings if you want to make them **Non-persistent**.

1. Click the radio buttons to set the persistency for configurations, call history, internal logging, local phonebook (local directory and favorites) and IP connectivity (DHCP) information.
2. Click [Apply](#).

The device restarts automatically. After the restart, the behavior changes according to the new persistency settings.



Logs, configurations, and other data that was stored before you switched to Non-persistent mode, are NOT cleared or deleted.

Persistency mode

Configurations, call history, internal logs, local phonebook (local directory and favorites list), and IP connectivity information are stored by default. Because all persistency settings are set to **Persistent**, a device restart does not delete this information.

Generally, we recommend you NOT to change the persistency settings. Only change to **Non-persistent** mode if you have to prevent users from being able to see or traceback to any logged information from the previous session

In Non-persistent mode, the following information is lost or cleared each time the device restarts:

- Device configuration changes
- Information about placed and received calls (call history)
- Internal log files
- Changes to the local contacts or favorites list
- All IP related information (DHCP) from the last session



Information that was stored before changing to Non-persistent mode is not automatically cleared or deleted. You must factory reset the device to delete such information.

There is more information about performing a factory reset in the [► Factory reset the video conferencing device](#) chapter.

Board

Board
ProCodec
EQCodec
PlusCodec
ProDesk,
Desk Pro,
Desk MiniRoom
Bar

Room Kit

Room Kit
Mini

Room 55

Room
55 Dual,
Room 70Room 70
G2Room 70
PanoramaRoom
Panorama

Set up an SMTP email server

By setting up an SMTP server connection, the users of the video conferencing device can share their whiteboards and annotations via email with people inside or outside your organization.

It is possible to set up the server manually, but we strongly recommend you to use the setup wizard. Then you can test the connection while setting it up, and you get guidance how to upload server certificates if needed.

Limitation for Room Kit Mini

This feature is not available for Room Kit Mini in general, only when Room Kit Mini is used with Samsung Flip (Webex on Flip).

Enable sharing via email

1. Sign in to the device web interface, go to [Settings](#), and select [Configurations](#).
2. Go to [NetworkServices > SMTP > Mode](#). Sharing via email is only allowed if Mode is **On**.

Use the wizard to set up the server Recommended

1. Sign in to the device web interface, go to [Settings](#), and select [Send Whiteboard to Email](#).
2. Click [Start Wizard](#) and enter the server address, encryption method, and port number.
3. Click [Test Connection...](#)

If everything is fine, click [OK](#) to continue the wizard.

If certificates are missing, click [Reconfigure](#) and follow the wizard instructions to upload the required certificates to the device.

4. Enter the email address from where to send whiteboards or annotations.
5. Fill in the username and password fields if the SMTP server requires authentication and the encryption method is TLS or STARTTLS.
6. Select [Verify and Save](#) to finish the server setup wizard.

Provided that [NetworkServices > SMTP > Mode](#) is **On**, the device is now ready to send whiteboards and annotations by email.

If you choose [Manual Configuration](#) instead of starting the wizard, fill in the same fields as described above and select [Verify and Save](#).

Set up the server from the configurations page

1. Sign in to the device web interface, go to [Settings](#), and select [Configurations](#).
2. Go to [NetworkServices > SMTP](#) and set the [Server, Security](#) (encryption method), [Port](#), [From](#), [Username](#), and [Password](#) settings.
3. If required, upload CA certificates to the device as described in the [Upload a CA certificate to the device](#) chapter.

Encryption methods and certificates

You must choose an encryption method that the email server supports.

Both the TLS and STARTTLS encryption methods require a server certificate. The device doesn't allow connections where the certificate of the SMTP server cannot be validated. Ignoring the certificate check is not an option.

Most often the server certificate can be validated using the CA list that is *pre-installed* on the device. If not, you have to upload the required certificates to the device yourself. Certificates that you upload yourself are added to the list of *Custom* certificates.

Read more about CA lists in the [Manage the lists of trusted certificate authorities - CAs](#) chapter.

Board

Board Pro

Codec EQ

Codec Plus

Codec Pro

Desk, Desk Pro, Desk Mini

Room Bar

Room Kit

Room Kit Mini

Room 55

Room 55 Dual, Room 70

Room 70 G2

Room 70 Panorama

Room Panorama

Set up ad hoc multipoint conferences (page 1 of 2)

Note: This chapter applies only to regular SIP calls. It does not apply to Webex meetings if your device is linked to Webex Edge for Devices and has the Webex optimized experience enabled.

There are several ways to expand a point-to-point video call (a call involving only two parties) into a multipoint conference with more participants.

Centralized conference infrastructure

Most solutions are based on a centralized conference infrastructure, i.e. an MCU (multipoint control unit) ¹.

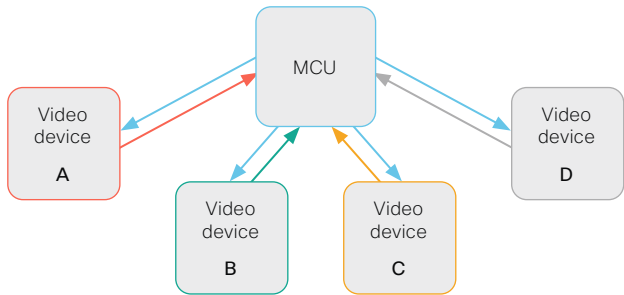

In this setup video devices A, B, C and D participates in a 4-party conference. The MCU receives media streams from all the devices, processes the streams, and sends all media to the other participants.

Local conference resources - MultiSite

In a MultiSite scenario, one of the video devices has MCU functionality.

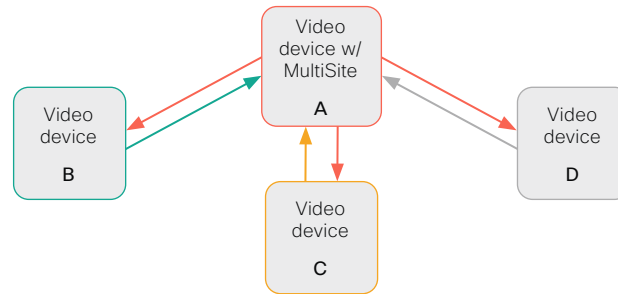

In this setup video devices A, B, C and D participates in a 4-party conference. Device A uses its MultiSite functionality and acts as an MCU. It receives media streams from all the devices, processes the streams, and sends all media to the other participants.

MultiSite is not part of the standard product delivery; you must buy an upgrade option to get the *MultiSite option key* installed on the device.

The maximum number of participants supported by MultiSite depends on the product:

- Four participants, yourself included (*Board, Codec Plus, Room Kit, Room Kit Mini, Room 55, Room 55 Dual, and Room 70*)
- Five participants, yourself included (*Other products*)

Multipoint configuration

Use the *Conference > Multipoint > Mode* setting to decide how to handle multipoint conferences. This setting takes the following values:

- Auto
- CUCMMediaResourceGroupList
- MultiSite
- Off

The table on the next page explains the different conferencing options.

¹ MCU - multipoint control unit, also called video-conferencing gateway or bridge.

Board

Board Pro

Codec EQ

Codec Plus

Codec Pro

Desk, Desk Pro, Desk Mini

Room Bar

Room Kit

Room Kit Mini

Room 55

Room 55 Dual, Room 70

Room 70 G2

Room 70 Panorama

Room Panorama

Set up ad hoc multipoint conferences (page 2 of 2)

Conference Multipoint Mode setting	MultiSite option key	Remote device type ²	Add participant behavior
Off	N/A	MCU	<ul style="list-style-type: none"> • If the MCU supports <i>Add Participant</i>, there is an <i>Add</i> button in the UI and you can call the next participant directly. The new participant is added to the conference as soon as he accepts the call. • If the MCU does not support <i>Add Participant</i>, there is no <i>Add</i> button in the UI.
		Video device	<ul style="list-style-type: none"> • Plus one audio ³ • You can add one extra participant on audio-only. • You cannot add more participants on video.
CUCM-MediaResource-GroupList	N/A	Video device	<ul style="list-style-type: none"> • Available only to CUCM registered devices, and the <i>SIP > Type</i> setting must be Cisco. • The conference is put on hold while calling a new participant. When the new participant accepts the call you can merge the new call with the conference. • Only the participant who added the first new participant to the conference can add more participants.
MultiSite ⁴	Yes	N/A	<ul style="list-style-type: none"> • Local MultiSite ⁵ • There is an <i>Add</i> button in the UI, and you can call the next participant directly. • You can keep adding participants until you reach the maximum number for the device.
	No	N/A	<ul style="list-style-type: none"> • Plus one audio ³ • You can add one extra participant on audio-only. • You cannot add more participants on video.
Auto	Yes	MCU	<ul style="list-style-type: none"> • If the MCU supports <i>Add Participant</i>, there is an <i>Add</i> button in the UI and you can call the next participant directly. The new participant is added to the conference as soon as he accepts the call. • If the MCU does not support <i>Add Participant</i>, there is no <i>Add</i> button in the UI.
		Video device	<ul style="list-style-type: none"> • Local MultiSite without cascading ⁵ • There is an <i>Add</i> button in the UI, and you can call the next participant directly. • You can keep adding participants until you reach the maximum number for the device. • Only the MultiSite host (which is now acting as an MCU) can add participants. This prevents cascaded conferences.
	No	MCU	<ul style="list-style-type: none"> • If the MCU supports <i>Add Participant</i>, there is an <i>Add</i> button in the UI and you can call the next participant directly. The new participant is added to the conference as soon as he accepts the call. • If the MCU does not support <i>Add Participant</i>, there is no <i>Add</i> button in the UI.
		Video device	<ul style="list-style-type: none"> • Plus one audio ³ • You can add one extra participant on audio-only. • You cannot add more participants on video.

² The remote device type is shown in the *Call [n] > DeviceType* status.

³ Supported by the following products: Board, Codec Plus, Codec Pro, Desk Pro, Room Kit, Room Kit Mini, Room 55, Room 55 Dual, Room 70, and Room 70 G2.

⁴ MultiSite is disabled automatically in a conference that is using multi stream. This means that you cannot add any new participants to the conference using the Add button in the UI (neither video nor audio-only participants).

⁵ We recommend setting *Conference > Multipoint > Mode* to **Auto** rather than to **MultiSite** in order to avoid cascaded conferences.

Board

Board Pro

Codec EQ

Codec Plus

Codec Pro

Desk, Desk Pro, Desk Mini

Room Bar

Room Kit

Room Kit Mini

Room 55

Room 55 Dual, Room 70

Room 70 G2

Room 70 Panorama

Room Panorama

Set up and use Cisco Proximity (page 1 of 5)

Cisco Proximity allows users to share content wirelessly, place calls, and control video conferencing devices from their laptop, when they are close to a video conferencing device.

When Cisco Proximity is enabled, the video conferencing device transmits ultrasound pairing messages. These messages are received by nearby devices with the Cisco Proximity client, which can then pair automatically with the video conferencing device.

Cisco recommends deploying the Webex app for wireless sharing, device control, and easy meeting join. But where that's not possible, Cisco Proximity provides a lightweight and device-centric alternative without infrastructure dependencies.

This guide is about Cisco Proximity for video conferencing devices registered on-premises. If your on-premises device is linked to Webex Edge for Devices, you should refer to ► [Webex Help Center \(https://help.webex.com/n1v31g9/\)](https://help.webex.com/n1v31g9/) for information about Cisco Proximity for cloud-pairing.



Number of Proximity connections

The maximum number of simultaneous Proximity connections is:

- 30

The client warns new users if the maximum number of connections has been reached.

Proximity services

Place calls and control the video conferencing device:

- Dial, mute, adjust volume, hang up
- Available on laptops (OS X and Windows)

Wireless share from a laptop:

- Share content without connecting a presentation cable
- Available on laptops (OS X and Windows)

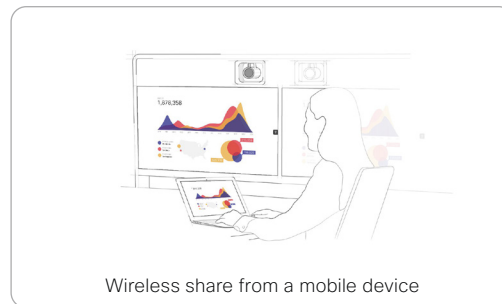
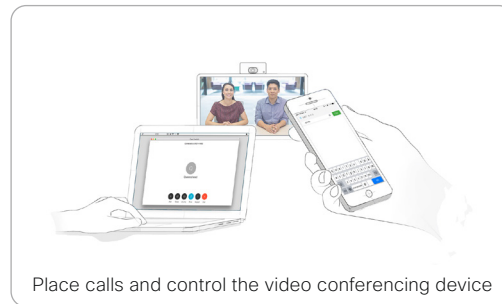

Install a Cisco Proximity client

Where to find the client

You can download the Cisco Proximity client for laptops (Windows and OS X) free of charge from ► <https://proximity.cisco.com>

End-user license agreement

Read the end-user license agreement carefully, ► https://www.cisco.com/c/en/us/td/docs/general/warranty/English/EU1KEN_.html

Supported operating systems

- Mac OS X 10.9 and above
 - Windows 7 and above
- The tile based interface introduced with Windows 8 is not supported.

Board

Board
ProCodec
EQCodec
PlusCodec
ProDesk,
Desk Pro,
Desk MiniRoom
Bar

Room Kit

Room Kit
Mini

Room 55

Room 55
Dual,
Room 70Room 70
G2Room 70
PanoramaRoom
Panorama

Set up and use Cisco Proximity (page 2 of 5)

Ultrasound emission

Cisco video conferencing devices emit ultrasound pairing messages as part of the Proximity feature.

Most people are exposed to ultrasound more or less daily in many environments, including industry, commercial applications and home appliances.

Even if airborne ultrasound may cause subjective effects for some individuals, it is very unlikely that any effects will occur for levels below 75 dB.

Room 70, Room 70 G2, Room Panorama, Room 70 Panorama, Room 55, Room 55 Dual, Room Bar, Room Kit, Room Kit Mini, Room Kit EQ¹, Room Kit Plus¹, and Room Kit Pro¹:

- The ultrasound sound pressure level is below 75 dB at a distance of 50 cm or more from the loudspeaker.

Desk, Desk Mini, and Desk Pro:

- The ultrasound sound pressure level is below 75 dB at a distance of 20 cm or more from the loudspeaker.

Board and Board Pro:

- The ultrasound sound pressure level is below 75 dB at a distance of 20 cm or more from the screen.

For Board 55 and 70 (not *S Series*) the level can be slightly higher right below the screen due to downward-facing loudspeakers.

Codec EQ, Codec Plus, and Codec Pro:

- We cannot foresee the ultrasound sound pressure level on these video conferencing devices, because they emit ultrasound on third-party loudspeakers.

The volume control on the loudspeaker itself, and the [Audio > Ultrasound > MaxVolume](#) setting affect the ultrasound sound pressure level; the volume control on the remote control or touch controller does not have any effect.

How to turn off ultrasound

The devices rely on ultrasound for these features:

- Proximity pairing
- Motion detection

If you turn off ultrasound for a feature, you cannot use that feature.

To turn off ultrasound emission for proximity pairing, you must set the following:

- [Proximity > Mode](#): **Off**
- [Audio > Ultrasound > Ru1Protocol](#): **Off**²
- [Audio > Ultrasound > RzssProtocol](#): **Off**²

To turn off ultrasound emission for motion detection, you must set the following:

- [RoomAnalytics > PeoplePresenceDetector](#): **Off**
- [Standby > WakeupOnMotionDetection > Mode](#): **Off**

To fully turn off ultrasound emission all the settings above must be set to Off.

¹ This applies if using **only** the Quad Camera's internal loudspeakers. If using external third-party loudspeakers, refer to the information for Codec EQ, Codec Plus, and Codec Pro.

² Alternatively, you can set [Audio > Ultrasound > MaxVolume](#): **0**.

Board

Board
ProCodec
EQCodec
PlusCodec
ProDesk,
Desk Pro,
Desk MiniRoom
Bar

Room Kit

Room Kit
Mini

Room 55

Room 55
Dual,
Room 70Room 70
G2Room 70
PanoramaRoom
Panorama

Set up and use Cisco Proximity (page 3 of 5)

Headsets

Headsets or headphones can be connected to several output types, depending on the product.

NOTE: You should never connect a headset to an output that emits ultrasound.

Dedicated headset outputs (*analog*), mini-jack

Desk Pro:

- The device doesn't emit ultrasound on dedicated headset outputs. Hence, you can always connect a headset.

Audio line outputs (*analog*), mini-jack or Euroblock

Codec EQ, Codec Plus, and Codec Pro:

- The device emits ultrasound on audio line outputs, and we will not be able to control the sound pressure level from a connected headset.
- We strongly recommend you to switch off ultrasound emission* if you connect a headset to an analog line output.

Board, Room Kit, Room 55, Room 55 Dual, Room 70, Room 70 G2, Room 70 Panorama, and Room Panorama:

- The device doesn't emit ultrasound on the audio line outputs.

USB outputs

Board Pro, Desk series, Room Bar, Room Kit, Room Kit Mini, and Room 55:

- The device doesn't emit ultrasound on the USB outputs. Hence, you can always connect a headset.

Codec EQ, Codec Plus, and Codec Pro:

- Per default, the device emits ultrasound on the USB outputs. These outputs are mainly intended for USB audio interfaces.
- If you connect a headset - directly or via a USB audio interface - we strongly recommend you to switch off the ultrasound emission*, or otherwise take care to configure the audio system to not emit ultrasound on these outputs.

Room 55 Dual, Room 70, Room 70 G2, Room 70 Panorama, Room Panorama:

- The device doesn't emit ultrasound on the USB outputs.

Board:

- There is no audio on the USB output.

* As a side effect, you *cannot* use the Proximity or Motion detection features.

Board

Board
ProCodec
EQCodec
PlusCodec
ProDesk,
Desk Pro,
Desk MiniRoom
Bar

Room Kit

Room Kit
Mini

Room 55

Room 55
Dual,
Room 70Room 70
G2Room 70
PanoramaRoom
Panorama

Set up and use Cisco Proximity (page 4 of 5)

Enable Proximity services

1. Sign in to the device web interface, go to [Settings](#), and select [Configurations](#).

2. Go to [Proximity > Mode](#) to switch Proximity **On**.

When Proximity is On, the video conferencing device transmits ultrasound pairing messages.

The ultrasound pairing messages are received by nearby devices with Proximity clients, and triggers the authentication and authorization of the device.

Whether Proximity is On or Off by default depends on the product.

3. Enable the services you want to allow. *Wireless share from a desktop client* is enabled by default.

In order to fully utilise the Proximity functionality, we recommend that you enable both services.

Place calls and control the video conferencing device:

- Go to [Proximity > Services > CallControl](#) and choose **Enabled**.

Wireless share from a desktop client:

- Go to [Proximity > Services > ContentShare > FromClients](#) and choose **Enabled**.

Default behavior

Codec EQ, Codec Plus, and Codec Pro:

- The Proximity feature is switched **Off** by default, because the use of third-party speakers may need additional testing for Proximity to work as expected. In rare cases the ultrasound may cause audio artifacts. If so, consider to decrease the maximum ultrasound volume with the [Audio > Ultrasound > MaxVolume](#) setting.

Desk, Desk Mini, and Desk Pro:

- The Proximity feature is switched **Off** by default, because the Desk products are often deployed in open offices with several devices close to each other. In such environments, pairing could be unstable. In general, Proximity should be switched **On** only on one device per room.

Other products:

- The Proximity feature is switched **On** by default.

Recommendation

In general, Cisco recommends - for the best user experience - that Proximity always is switched **On**.

However, for the products where Proximity is switched **Off** by default, it is important that you verify that Proximity is suitable in your environment and setup before you switch it on.

In order to get full access to Proximity, the Proximity services ([Proximity > Services > ...](#)) must be **Enabled** as well.

Board

Board
ProCodec
EQCodec
PlusCodec
ProDesk,
Desk Pro,
Desk MiniRoom
Bar

Room Kit

Room Kit
Mini

Room 55

Room 55
Dual,
Room 70Room 70
G2Room 70
PanoramaRoom
Panorama

Set up and use Cisco Proximity (page 5 of 5)

Room considerations

Room acoustics

- Rooms with hard surfaces may cause challenges due to severe audio reflections. Acoustical treatment of meeting rooms is always highly recommended for the best meeting experience as well as Proximity performance.
- Cisco recommends only one video conferencing device with Proximity enabled in a room. Otherwise, interference is likely to occur, which may lead to problems with device discovery and session maintenance.

About privacy

In the Cisco Privacy statement and the Cisco Proximity Supplement you find information about data collection in the clients and privacy concerns that needs to be considered when deploying this feature in the organization. Refer to:

► <https://www.cisco.com/web/siteassets/legal/privacy.html>

Basic troubleshooting

Cannot detect devices with Webex clients

- Check if the video conferencing device is in standby mode. Ultrasound is not transmitted if the speakers (for example a TV in standby mode) are turned off. *(only Codec EQ, Codec Plus and Codec Pro)*
- Check the speaker volume. The volume control on a speaker itself (not the volume controlled with the remote control or touch controller) affects the ultrasound volume. If the volume is too low, the listening devices cannot detect the ultrasound pairing messages. *(only Codec EQ, Codec Plus and Codec Pro)*
- Some Windows laptops are not able to record sound in the ultrasound frequency range (20kHz-22kHz). This can be due to frequency limitations with the sound card, sound driver or the internal microphone of the particular device. Refer to the Support forum for more information.
- Check *Device settings > Issues and diagnostics* on the user interface (control panel), or *Issues and Diagnostics* on the device web interface. If there are no ultrasound related issues listed ("Unable to verify the ultrasound signal"), ultrasound pairing messages are emitted by the video conferencing device as they should. Refer to the Proximity *Support forum* for further assistance with the client detection issues.

Audio artifacts

- If you can hear audio artifacts, like humming or clipping noise, decrease the maximum ultrasound volume (*Audio > Ultrasound > MaxVolume*).

Cannot share content from a laptop

- For content sharing to work, the video conferencing device and the laptop must be on the same network. For this reason Proximity sharing might fail if your video conferencing device is connected to your company network via Expressway, and your laptop is connected via VPN (VPN client dependent).

Additional resources

Cisco Proximity site:

► <https://proximity.cisco.com>

Support forum:

► <https://www.cisco.com/go/proximity-support>

Board

Board
ProCodec
EQCodec
PlusCodec
ProDesk,
Desk Pro,
Desk MiniRoom
Bar

Room Kit

Room Kit
Mini

Room 55

Room 55
Dual,
Room 70Room 70
G2Room 70
PanoramaRoom
Panorama

Adjust the video quality to call rate ratio (page 1 of 2)

Video input quality settings

When encoding and transmitting video there is a trade-off between high resolution and high frame rate.

Use the *Video > Input > Connector n > Quality* setting to decide whether to give priority to high frame rate (**Motion**) or high resolution (**Sharpness**).

The tables on the next page are for the main video channel, hence with *Quality* is set to **Motion**.

Optimal definition profile

The optimal definition profile should reflect the lighting conditions in the video conferencing room and the quality of the camera (video input source). The better the lighting conditions and the better the quality of the camera, the higher the optimal definition profile should be used.

Generally, the Medium profile is recommended. However, if the lighting conditions are very good, we recommend that you test the endpoint on the various Optimal Definition Profile settings before deciding on a profile. The High profile may be set in order to increase the resolution for a given call rate.

Some typical resolutions used for different optimal definition profiles, call rates and transmit frame rates are shown in the tables on the next page. The resolution and frame rate must be supported by both the calling and called devices.

Threshold for sending video at 60 fps

Use the *Video > Input > Connector n > OptimalDefinition > Threshold60fps* setting to decide when to allow sending video at 60 fps.

For all resolutions lower than this threshold, the maximum transmitted frame rate will be 30 fps; for higher resolutions, 60 fps is possible if the available bandwidth is adequate.

Allowing video at 60 fps

(Applies to: Room Kit, Room Kit Mini, and Room 55)

As default, the camera outputs 30 frames per second (fps). This allows for good quality both in close-ups and overview pictures for normal bandwidths and lighting conditions. If the conditions are better, a 60 fps output from the camera may give a better overall quality.

Use the *Cameras > Camera > Framerate* setting to set the camera output framerate.

Sign in to the device web interface, go to *Settings*, and select *Configurations*.

1. *Applies to all products and connectors except Connector 1 (integrated camera) of Board, Board Pro, Desk, Desk Mini, Desk Pro, Room Bar, Room Kit, Room Kit Mini, and Room 55.*
Go to *Video > Input > Connector n > Quality* and choose whether to give priority to high frame rate or high resolution.
2. Go to *Video > Input > Connector n > OptimalDefinition > Profile* and choose the preferred optimal definition profile.
3. Go to *Video > Input > Connector n > OptimalDefinition > Threshold60fps* to set the threshold below which the maximum transmitted frame rate will be 30 fps.
4. *Applies to Room Kit, Room Kit Mini, and Room 55.*
Go to *Cameras > Camera > Framerate* and choose whether or not to allow video at 60 fps.

Board

Board Pro

Codec EQ

Codec Plus

Codec Pro

Desk, Desk Pro, Desk Mini

Room Bar

Room Kit

Room Kit Mini

Room 55

Room 55 Dual, Room 70

Room 70 G2

Room 70 Panorama

Room Panorama

Adjust the video quality to call rate ratio (page 2 of 2)

Products that support H.264:

- All products *

H.264: Resolutions and frame rate [w×h@fps] obtained for different optimal definition profiles and call rates						
Call rate [kbps]	maximum 30fps and maximum 128kbps audio bit rate			maximum 60fps and maximum 128kbps audio bit rate		
	Normal	Medium	High	Normal	Medium	High
128	320×180@30	320×180@30	512×288@30	320×180@30	512×288@20	512×288@30
256	512×288@30	640×360@30	768×448@30	512×288@30	640×360@30	512×288@60
384	640×360@30	768×448@30	768×448@30	640×360@30	512×288@60	640×360@30
512	768×448@30	1024×576@30	1024×576@30	512×288@60	640×360@60	768×448@60
768	1024×576@30	1280×720@30	1280×720@30	640×360@60	768×448@60	1024×576@60
1152	1280×720@30	1280×720@30	1280×720@30	768×448@60	1024×576@60	1280×720@60
1472	1280×720@30	1280×720@30	1920×1080@30	1024×576@60	1024×576@60	1280×720@60
1920	1280×720@30	1920×1080@30	1920×1080@30	1024×576@60	1280×720@60	1280×720@60
2560	1920×1080@30	1920×1080@30	1920×1080@30	1280×720@60	1280×720@60	1920×1080@60
3072	1920×1080@30	1920×1080@30	1920×1080@30	1280×720@60	1280×720@60	1920×1080@60
4000	1920×1080@30	1920×1080@30	1920×1080@30	1280×720@60	1920×1080@60	1920×1080@60
6000	1920×1080@30	1920×1080@30	1920×1080@30	1920×1080@60	1920×1080@60	1920×1080@60

Products that support H.265:

- Board Pro
- Codec EQ
- Codec Pro
- Codec Plus
- Room Kit
- Room 55
- Room 55 Dual
- Room 70
- Room 70 G2
- Room 70 Panorama *
- Room Panorama *

H.265: Resolutions and frame rate [w×h@fps] obtained for different optimal definition profiles and call rates						
Call rate [kbps]	maximum 30fps and maximum 128kbps audio bit rate			maximum 60fps and maximum 128kbps audio bit rate		
	Normal	Medium	High	Normal	Medium	High
128	512×288@30	512×288@30	640×360@30	512×288@30	512×288@30	512×288@60
256	640×360@30	768×448@30	768×448@30	640×360@30	512×288@60	640×360@60
384	768×448@30	1024×576@30	1280×720@30	640×360@60	768×448@60	768×448@60
512	1024×576@30	1280×720@30	1280×720@30	640×360@60	768×448@60	1024×576@60
768	1280×720@30	1280×720@30	1920×1080@30	768×448@60	1024×576@60	1280×720@60
1152	1280×720@30	1920×1080@30	1920×1080@30	1024×576@60	1280×720@60	1280×720@60
1472	1280×720@30	1920×1080@30	1920×1080@30	1280×720@60	1280×720@60	1280×720@60
1920	1920×1080@30	1920×1080@30	1920×1080@30	1280×720@60	1280×720@60	1920×1080@60
2560	1920×1080@30	1920×1080@30	1920×1080@30	1280×720@60	1920×1080@60	1920×1080@60
3072	1920×1080@30	1920×1080@30	1920×1080@30	1920×1080@60	1920×1080@60	1920×1080@60
4000	1920×1080@30	1920×1080@30	1920×1080@30	1920×1080@60	1920×1080@60	1920×1080@60
6000	1920×1080@30	1920×1080@30	1920×1080@30	1920×1080@60	1920×1080@60	1920×1080@60

* For Room Panorama and Room 70 Panorama the data applies in non-panoramic mode.

Board

Board
ProCodec
EQCodec
PlusCodec
ProDesk,
Desk Pro,
Desk MiniRoom
Bar

Room Kit

Room Kit
Mini

Room 55

Room 55
Dual,
Room 70Room 70
G2Room 70
PanoramaRoom
Panorama

Select a wallpaper bundle as background image

You can choose between a set of pre-installed wallpaper bundles for the device. The wallpaper bundle is shown when the system is in the awake state. You cannot upload your own custom bundles.

A wallpaper bundle may include wallpapers for several setup types. Some bundles are prepared for multi-screen setups, by providing an image that spans several screens; and some bundles include a wallpaper for the touch controller.

Examples of setup types are:

- *single*: Single-screen background image
- *dual*: Background image spanning two screens (side-by-side)
- *dualAbove*: Background image spanning two screens (one screen above the other)
- *triple*: Background image spanning three screens (side-by-side)
- *tripleAbove/tripleBelow*: Background image spanning three screens, designed for Room Panorama and Room 70 Panorama, where the third screen is either above or below the two main screens
- *controller*: Background image for the touch controller



You must use the *UserInterface WallpaperBundle* API commands if you want to apply a wallpaper bundle or change to a different bundle. You cannot do this from the touch controller or the device web interface.

Using Wallpaper bundles requires that *UserInterface > Wallpaper* is set to **Auto**.

Check which wallpaper bundles you can choose from

```
xCommand UserInterface WallpaperBundle List
```

Both the name and setup types of the bundle are returned.

Change to another wallpaper bundle:

You must choose a bundle that offers the setup type that match your screen setup.*

```
xCommand UserInterface WallpaperBundle Set  
Name: "Name"
```

Remove the wallpaper bundle and return to the default background appearance.

```
xCommand UserInterface WallpaperBundle Clear
```

* Exception: The "beige", "blue", "carbon", and "forestgreen" bundles are reserved for the limited edition color Desk and Desk Mini devices.

- Board
- Board Pro
- Codec EQ
- Codec Plus
- Codec Pro
- Desk, Desk Pro, Desk Mini
- Room Bar
- Room Kit
- Room Kit Mini
- Room 55
- Room 55 Dual, Room 70
- Room 70 G2
- Room 70 Panorama
- Room Panorama

Add a custom background image for halfwake mode

Sign in to the device web interface, go to [Personalization](#), and select [Wallpaper and Halfwake](#).

You can apply a custom background image that will show on both the main screen(s) and the touch controller when the device is in halfwake mode.

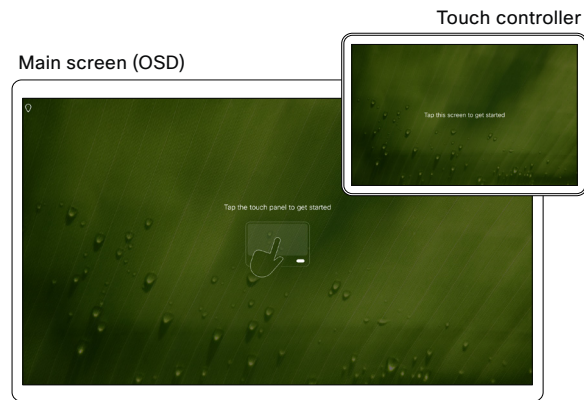

Upload or replace a halfwake image

Click [Upload image](#) or [Replace image](#) and browse to find the image file.

Supported file formats:

- JPEG, PNG

Recommended size:

- 1920 × 1080 pixel (*Desk, Desk Mini*)
- 3840 × 2160 pixel (*other products*)

The custom halfwake background is automatically saved on the device, and activated once uploaded.

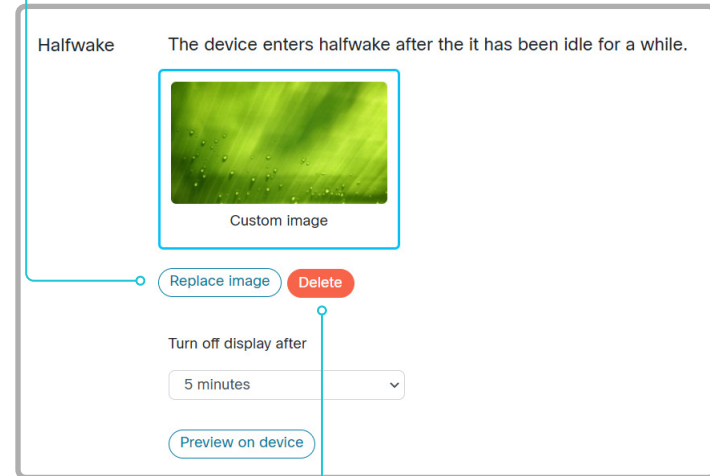
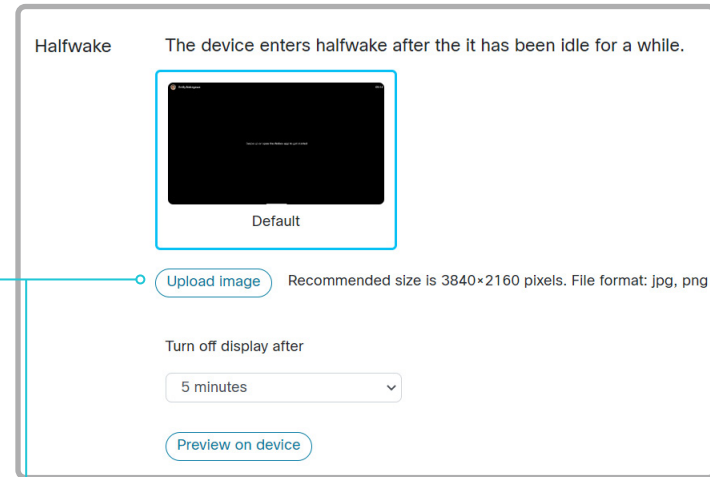

Delete the halfwake image

Delete removes the image from the device. You must upload it anew if you want use it again.

- Board
- Board Pro
- Codec EQ
- Codec Plus
- Codec Pro
- Desk, Desk Pro, Desk Mini
- Room Bar
- Room Kit
- Room Kit Mini
- Room 55
- Room 55 Dual, Room 70
- Room 70 G2
- Room 70 Panorama
- Room Panorama

Add a custom background for the Home screen

Sign in to the device web interface, go to [Personalization](#), and select [Wallpaper and Halfwake](#).

You can apply a custom background (also known as a wallpaper) for the Home screen. The custom background will show only on the main screen(s); the touch controller has the default background.

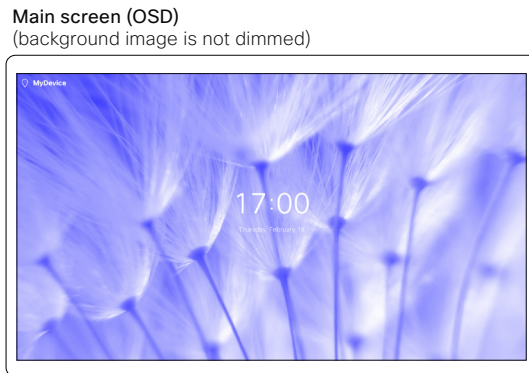
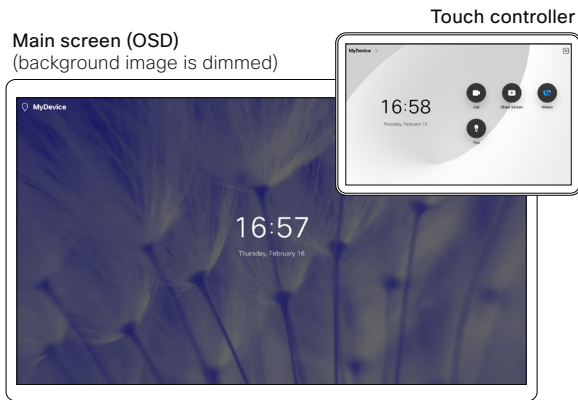

Upload or replace the Home screen wallpaper

Click [Upload image](#) or [Replace image](#) and browse to find the image file.

Supported file formats:

- JPEG, PNG

Recommended size:

- 1920 × 1080 pixel (*Desk, Desk Mini*)
- 3840 × 2160 pixel (*other products*)

The custom wallpaper is automatically saved on the device, and activated once uploaded.

Choose a wallpaper

Click the wallpaper you want to use. Choose between the preinstalled background images and the custom wallpaper.

Dim the background image

We recommend you to dim the background image to increase the contrast between the background and the text.

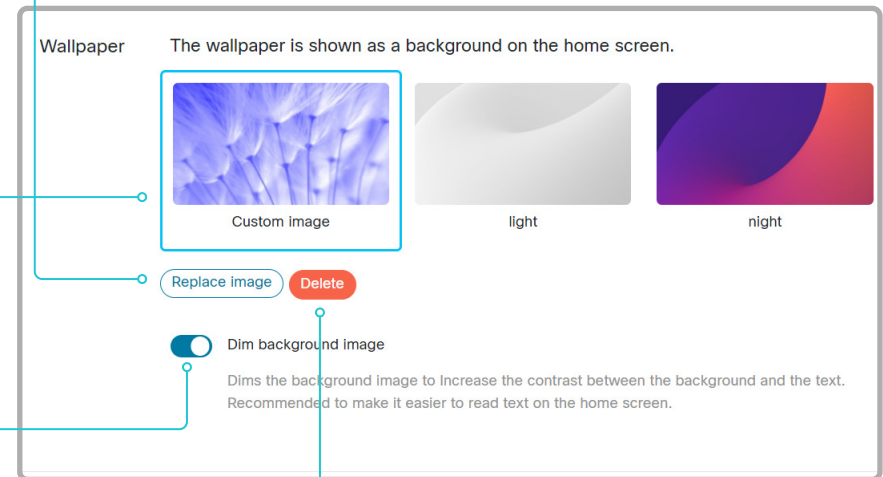
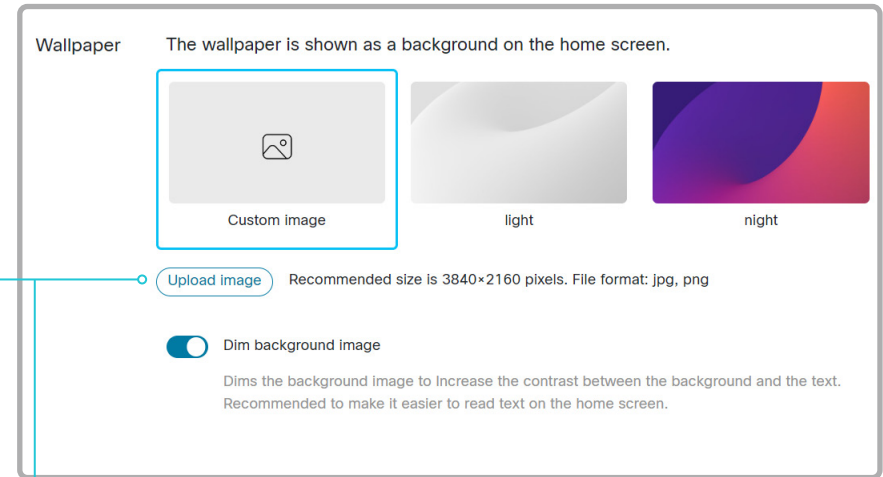

Delete the custom wallpaper

Delete removes the image from the device. You must upload it anew if you want use it again.

- Board
- Board Pro
- Codec EQ
- Codec Plus
- Codec Pro
- Desk, Desk Pro, Desk Mini
- Room Bar
- Room Kit
- Room Kit Mini
- Room 55
- Room 55 Dual, Room 70
- Room 70 G2
- Room 70 Panorama
- Room Panorama

Add branding to the screen and touch controller (page 1 of 2)

Sign in to the device web interface, go to [Personalization](#), and select [Branding](#).

You can add a company logo and custom text that will show on the Home screen (awake mode) and when the device is in halfwake mode.

Branding on the Home screen

In the awake state the logo and custom text shows only on the main screen; the logo is lower right, the custom text is lower left. These branding elements has no effect on the touch controller.

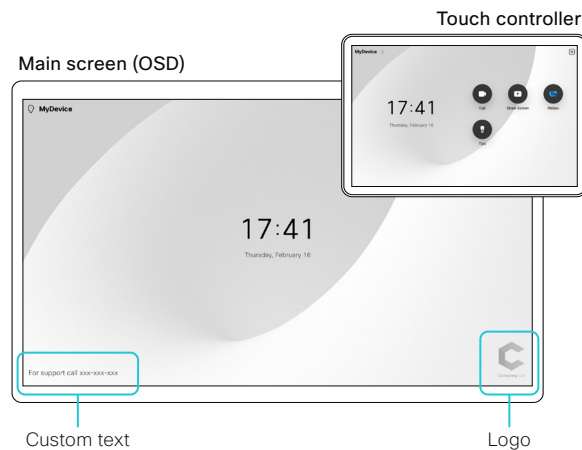

Upload a Home screen logo

Click [Upload image](#) or [Replace image](#) and browse to find the image file.

Supported file format: PNG

Recommended size: 272 × 272 pixel

The logo is automatically saved on the device, and activated once uploaded.

Brand Logo

Halfwake logo
Shows brand logo in halfwake

[Upload image](#) Recommended size is 272×272 pixels. File format: png

Home screen logo
Show brand logo on home screen

[Upload image](#) Recommended size is 272×272 pixels. File format: png

Custom Text
Custom text displays in the bottom left corner of the main screen.
Example: A help desk number your end users can call for assistance.

[Apply](#)

Add custom text

Enter text in the input field and click [Apply](#).

Home screen logo
Show brand logo on home screen

[Replace image](#) [Delete](#)

Apply transparency to this logo
Allows logos to be blended in with the background image. Only recommended for monochrome logos.

Delete the halfwake image

[Delete](#) removes the logo from the device. You must upload it anew if you want use it again.

Apply transparency to the logo on the Home screen

You can apply transparency to the logo to better blend in with the Home screen background. We recommend it only for monochrome logos.

Board

Board Pro

Codec EQ

Codec Plus

Codec Pro

Desk, Desk Pro, Desk Mini

Room Bar

Room Kit

Room Kit Mini

Room 55

Room 55 Dual, Room 70

Room 70 G2

Room 70 Panorama

Room Panorama

Add branding to the screen and touch controller (page 2 of 2)

Branding in halfwake mode

In the halfwake mode the logo shows lower right on both the main screen and the touch controller. The custom text applied to the Home screen doesn't show in halfwake mode.

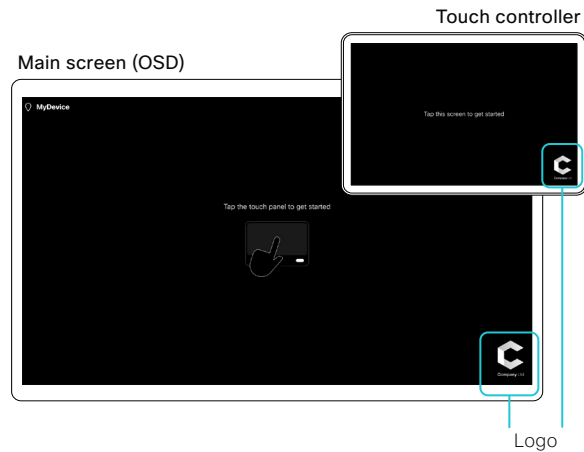

Instructions how to start using the device

Use the [UserInterface > OSD > HalfwakeMessage](#) setting if you want to customize or remove the message at the center of the screen (only on screen, not on touch controller). This is the message that informs the user how to start using the device.

In general, we recommend that you keep the standard message. Change the message only if you have to adapt it to a different scenario, for example if you have a third-party user interface.

Upload a logo for halfwake mode

Click [Upload image](#) or [Replace image](#) and browse to find the image file.

- Supported file format: PNG
- Recommended size: 272 × 272 pixel

We recommend a light logo, so that it blends well with the dark halfwake background image.

The logo is automatically saved on the device, and activated once uploaded.

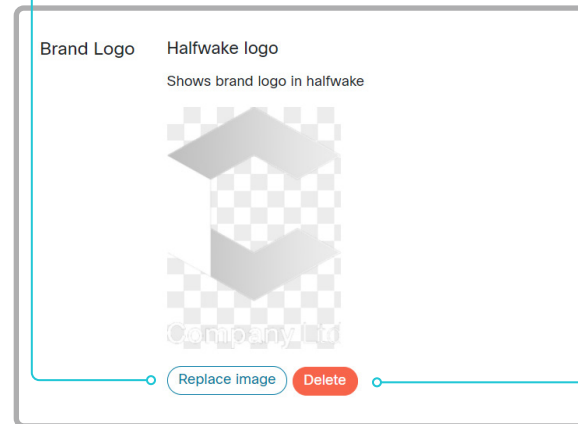
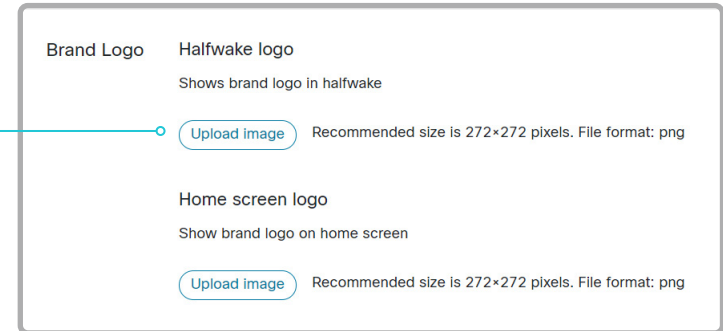

Delete the halfwake image

Delete removes the logo from the device. You must upload it anew if you want use it again.

Board

Board Pro

Codec EQ

Codec Plus

Codec Pro

Desk, Desk Pro, Desk Mini

Room Bar

Room Kit

Room Kit Mini

Room 55

Room 55 Dual, Room 70

Room 70 G2

Room 70 Panorama

Room Panorama

Add a virtual background

Sign in to the device web interface, go to [Personalization](#), and select [Virtual Backgrounds](#).

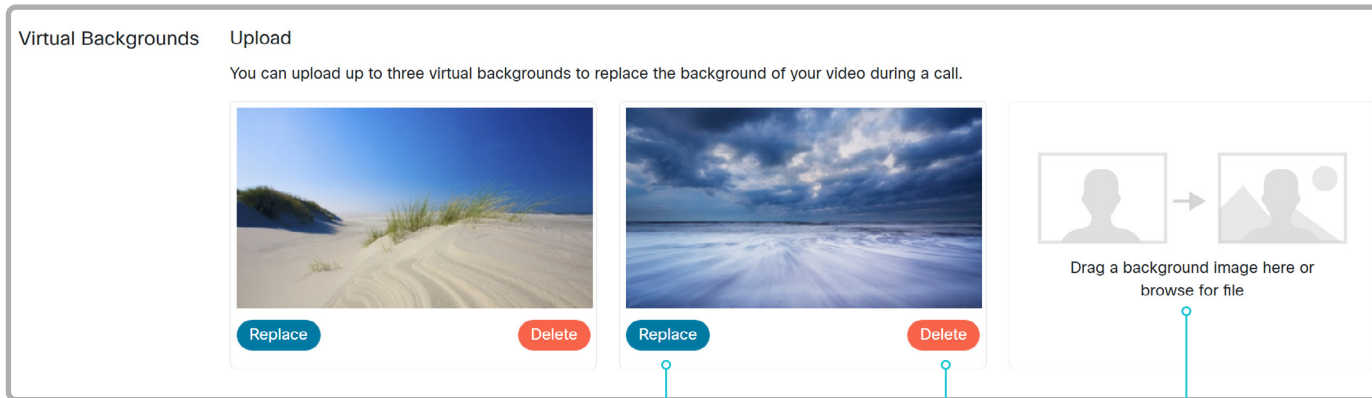

Replace the background image

[Replace](#) allows you to replace the virtual background with a new file.

Delete the background image

[Delete](#) fully removes the virtual background from the device.

You have to upload it again if you want use it again.

Upload a background image

Browse to select a new virtual background or select the file from your file system and drag it into the device web interface.

Supported file formats: BMP, GIF (no animation), JPEG, PNG

Maximum file size*: 8MB

* The image file must be slightly smaller, since this maximum number includes Base64 encoding overhead.

About virtual backgrounds

If you want to use a custom image as the background while you are in a call, you may upload and use up to three *virtual backgrounds*.

Virtual backgrounds can be selected from the user interface. Tap the **selfview** or open the control panel and select **Background** to find the background options. See the user guide for more details.

Board

Board Pro

Codec EQ

Codec Plus

Codec Pro

Desk, Desk Pro, Desk Mini

Room Bar

Room Kit

Room Kit Mini

Room 55

Room 55 Dual, Room 70

Room 70 G2

Room 70 Panorama

Room Panorama

Choose a ringtone and set the ringtone volume

Sign in to the device web interface, go to [Personalization](#), and select [Ringtones](#).

Change the ringtone

1. Choose a ringtone from the drop-down list.
2. Click [Save](#) to make it the active ringtone.

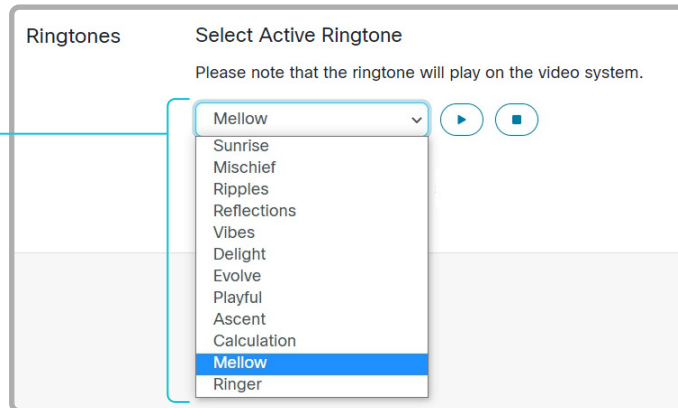

Set the ringtone volume

Use the slide bar to adjust the ringtone volume.

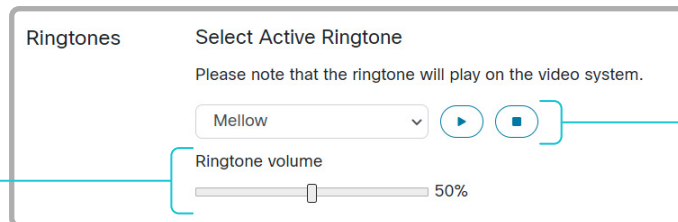

Play back the ringtone

Click the play button (▶) to play back the ringtone.

Use the stop button (■) to end the playback.

About ringtones

A set of ringtones is installed on the device. Use the device web interface to choose a ringtone, and set the ringtone volume.

You can play back the chosen ringtone from the device web interface. Note that the ringtone will be played back on the device itself, and not on the computer running the web interface.

Board

Board
ProCodec
EQCodec
PlusCodec
ProDesk,
Desk Pro,
Desk MiniRoom
Bar

Room Kit

Room Kit
Mini

Room 55

Room 55
Dual,
Room 70Room 70
G2Room 70
PanoramaRoom
Panorama

Manage the Favorites list

Sign in to the device web interface, go to [Personalization](#), and select [Contacts](#).

Import or export contacts from file

Click [Export](#) to save the local contacts in a file; and click [Import](#) to bring in contacts from a file.

The current local contacts are discarded when you import new contacts from a file.

Add or edit a contact

1. Click [Add Contact](#) to make a new local contact, or click a contact's name followed by [Edit Contact](#).

2. Fill in or update the form that pops up.

Choose a folder in the folder drop down list in order to store the contact in a sub-folder.

Click [Add Contact Method](#) and fill in the new input fields if you want to store more than one contact method for the contact (for example video address, telephone and mobile number).

3. Click [Save](#) to store the local contact.

Delete a contact

1. Click a contacts name followed by [Edit Contact](#).
2. Click [Delete](#) to remove the local contact. Confirm your choice in the dialog that pops up.

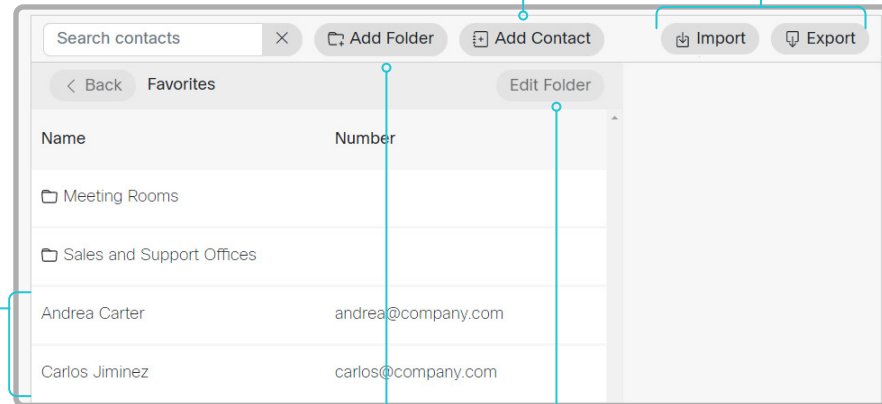

Add or edit a sub-folder

1. Click [Add Folder](#) to make a new sub-folder, or click one of the listed sub-folders followed by [Edit Folder](#) to change an existing sub-folder.
2. Fill in or update the form that pops up.
3. Click [Save](#) to create or update the folder.

Delete a sub-folder

1. Click a folder's name followed by [Edit Folder](#).
2. Click [Delete](#) to remove the folder and all its contacts and sub-folders. Confirm your choice in the dialog that pops up.

Manage Favorites using the device's user interface

Add a contact to the Favorites list

1. Select [Call](#) on the home screen.
2. Select the contact you want to add.
3. Tap the star symbol next to the [Call](#) button on the contact card. Then the color of the star symbol changes from black to white.

The contact you add will be placed in the top folder. You cannot select or create a sub-folder.

Remove a contact from the Favorites list

1. Select [Call](#) on the home screen.
2. Select the [Favorites](#) tab.
3. Select the contact you want to remove.
4. Tap the star symbol next to the [Call](#) button on the contact card. Then the color of the star symbol changes from white to black.

Board

Board
Pro

Codec
EQ

Codec
Plus

Codec
Pro

Desk,
Desk Pro,
Desk Mini

Room
Bar

Room Kit

Room Kit
Mini

Room 55

Room 55
Dual,
Room 70

Room 70
G2

Room 70
Panorama

Room
Panorama

Set up accessibility features

Flashing screen for incoming calls

To make it easier for the hearing impaired users to notice when someone is calling, the screen can be setup to flash on incoming calls.

1. Sign in to the device web interface, go to *Settings*, and select *Configurations*.
2. Go to *UserInterface > Accessibility > IncomingCallNotification* and select **AmplifiedVisuals**.
3. Click *Save*.

Board

Board Pro

Codec EQ

Codec Plus

Codec Pro

Desk, Desk Pro, Desk Mini

Room Bar

Room Kit

Room Kit Mini

Room 55

Room 55 Dual, Room 70

Room 70 G2

Room 70 Panorama

Room Panorama

Set up the low power behavior

By default, a device will enter display off mode after *y* minutes. The default delay depends on the product.

You can set the preferred delay or switch off this mode with these settings:

- *Standby Control*: Off/On
- *Standby Delay*: Integer (1..480)

The device will not enter display off mode automatically if the *Standby Control* is **Off**. If the *Standby Control* is **On**, the device will enter display off mode when the *Standby Delay* has timed out.

Note that the *Standby Delay* also includes the halfwake period.

By default, a device will enter networked standby 2 minutes after it enters display off mode. *

You can set the preferred delay or switch off the automatic transition to networked standby with these settings:

- *Standby Level Networked Mode*: Off/On
- *Standby Level Networked Delay*: Integer (0..1440)

The device will not enter networked standby level if the *Standby Level Networked Control* is **Off**. If the *Standby Level Networked Control* is **On**, the device will enter networked standby when the *Standby Level Networked Delay* has timed out.

If the delay is set to 0, the device will go directly to networked standby, skipping the display off stage.

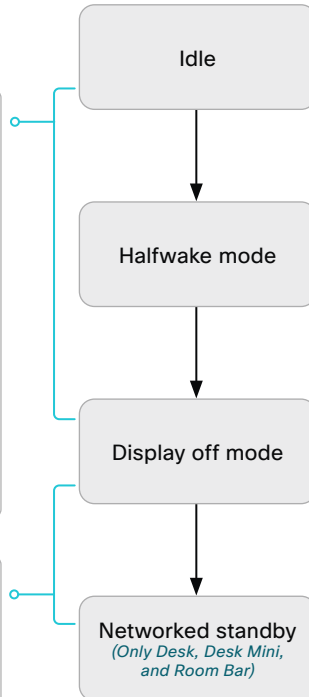

By default, a device will enter halfwake mode after 2 minutes (not configurable) when there is no activity, no active web apps or sessions. Halfwake mode will be displayed for *x* minutes, where $x = \text{Standby Delay} - 2$.

Example: *Standby Delay*: 5

The halfwake screen will be displayed for 3 minutes, and then the device will go into display off mode.

In order to skip the halfwake stage, use this setting:

- *Standby Halfwake Mode*: **Manual**

Halfwake mode

The halfwake mode is a stage between idle and display off mode. A device remains in halfwake mode until activity is detected or until it goes into display off mode.

The halfwake mode may show a darkened screen with text or it may be configured to show branding information, including web pages or digital signage.

Low power modes

There are several low power modes, each providing different power consumption profiles.

Display off mode

This is the first low power stage. The display is turned off.

Networked standby

(Only Desk, Desk Mini, and Room Bar)

This is the second low power stage, which reduces power consumption further than the display off mode.

In addition to turning off the display, we will clock down the CPU/GPU and power down some modules on lower level.

The device is still accessible through the network, and it will wake up when receiving a call.

* The device will stay in Display off mode and not enter Networked standby if presence of people are detected, or if audio is streamed to the device via Bluetooth.

Board

Board
ProCodec
EQCodec
PlusCodec
ProDesk,
Desk Pro,
Desk MiniRoom
Bar

Room Kit

Room Kit
Mini

Room 55

Room 55
Dual,
Room 70Room 70
G2Room 70
PanoramaRoom
Panorama

Provisioning of product specific configurations from CUCM (page 1 of 2)

This chapter describes how to provision settings or parameters to a device (endpoint) using the method that was introduced in Cisco UCM Release 12.5(1)SU1.

Prior to Cisco UCM release 12.5(1)SU1, only a limited set of product-specific configurations were pushed from UCM to the device. The administrator had to rely on Cisco TMS or the device web interface to configure all the other settings.

From CUCM release 12.5(1)SU1 more settings or parameters can be provisioned from CUCM. The list of settings matches what users see on their device (public xConfigurations), with the exception of Network, Provisioning, SIP and H.323 settings.

For more information about CUCM refer to the *Video Endpoints Management* chapter of the [Feature Configuration Guide for Cisco Unified Communications Manager, Release 12.5\(1\)SU1](#).

Configuration control modes

Based on the deployment needs, administrators can configure various configuration control modes in the CUCM administration interface. You can decide whether you want to control the configuration settings from CUCM, the device, or both of them together.

These are the various configuration control modes:

- **Unified CM and Endpoint** (default): Use this mode if you want the CUCM and the device to operate as the multi-master source for provisioning device data. CUCM reads the xConfiguration data automatically from the device, and any updates made locally on the device is synchronised with the CUCM server instantly.
- **Unified CM:** CUCM operates as the centralized master source for provisioning device data. CUCM ignores any changes that are done locally on the device, and therefore such changes will be overridden the next time CUCM applies a new configuration to the device.
- **Endpoint:** The endpoint operates as the centralized master source of configuration data. In this mode, the endpoint ignores any configuration data from the CUCM and doesn't synchronize back the changes done locally.

This mode is typically used when an integrator is installing the devices and wants to control the configuration locally from the device.

Pull configurations from the device on-demand

Administrators can use the [Pull xConfig. from Device](#) option in CUCM to pull configuration changes from the devices on-demand at any time.

This option is enabled only if the device is registered.

Supported CE software versions

Any device that supports CE9.8 or higher can use this new provisioning layout in CUCM.

If the device has a software version prior to CE9.8, you will be able to view the complete set of parameters in the CUCM user interface; but you can only configure the subset that is marked with a "#". The "#" is to the right of each parameter value.

The full set of parameters functions only if you upgrade the device to CE9.8 or higher.

Board

Board Pro

Codec EQ

Codec Plus

Codec Pro

Desk, Desk Pro, Desk Mini

Room Bar

Room Kit

Room Kit Mini

Room 55

Room 55 Dual, Room 70

Room 70 G2

Room 70 Panorama

Room Panorama

Provisioning of product specific configurations from CUCM (page 2 of 2)

Set up provisioning from CUCM

1. Sign in to CUCM, navigate to *Device > Phone*, and find your device.
2. Find the *Product Specific Configuration Layout* section (see illustration).
3. Click the *Miscellaneous* category and find the *Configuration Control Mode* setting. Choose your preferred mode: Unified CM, Endpoint, or Unified CM and Endpoint (see the description on the previous page).
4. Click the *Pull xConfig. from Device* button if you want to load the current configuration from the device.
5. Select a category and set a value for the configurations you want to change.
6. Finally, click *Save* and *Apply Config*, just like you do in earlier CUCM versions.

Product Specific Configuration Layout

Parameter Value Pull xConfig. from device

Note: Endpoints running software versions earlier than CE 9.8 only support provisioning a limited set of parameters from Cisco Unified CM. These parameters are indicated below with the # symbol.

Category	Parameter	Value	Notes
DefaultCall	Protocol*	Sip	#
	Rate	6000	
	DoNotDisturb DefaultTimeout	60	
	EncryptedIx Mode*	Auto	
	Encryption Mode*	BestEffort	
	FarEndMessage Mode*	Off	
	MaxReceiveCallRate	6000	
	MaxTotalReceiveCallRate	6000	
	MaxTotalTransmitCallRate	#	
	MaxTransmitCallRate	6000	
	MicUnmuteOnDisconnect Mode*	On	#
	Multipoint Mode*	MultiSite	#
MultiStream Mode*	Auto		
FarEndControl	Mode*	On	#
	SignalCapability*	On	#

Pull configurations from the device on-demand

Click this button to pull any data configuration from the device on-demand.

Settings marked with a hash, #

Settings that also were available in Cisco UCM releases prior to 12.5(1) SU1.

Settings or parameters

The settings that belong to the selected category.

Categories

The device settings are grouped in categories. These are the same categories that you find in the device web interface. They also correspond to the API command path.

Miscellaneous is an exception to this rule. In this category you find settings that only can be set by CUCM. They don't correspond to a local setting on the device.

Board

Board
Pro

Codec
EQ

Codec
Plus

Codec
Pro

Desk,
Desk Pro,
Desk Mini

Room
Bar

Room Kit

Room Kit
Mini

Room 55

Room 55
Dual,
Room 70

Room 70
G2

Room 70
Panorama

Room
Panorama

Chapter 3

Peripherals

Board

Board Pro

Codec EQ

Codec Plus

Codec Pro

Desk, Desk Pro, Desk Mini

Room Bar

Room Kit

Room Kit Mini

Room 55

Room 55 Dual, Room 70

Room 70 G2

Room 70 Panorama

Room Panorama

Setting up screens and other output devices (page 1 of 7)

The *number of video outputs* depends on the product. Typically, the outputs are used for screens or other types of displays. Codec Pro and Room 70 G2 also support connecting a recorder.

The integrated devices has one or more *internal screens* in addition to connectors that are available for *external screens*. The kits and codecs have connectors only for *external screens*.

The device distributes the layout (people and content) on all available monitors. Refer to the article [▶ Webex Rooms | Video Stream Layouts \(https://help.webex.com/zp1dhab/\)](https://help.webex.com/zp1dhab/) on Webex Help Center for information about how layouts appear depending on your device and the number of screens in your setup.

Logical connectors

A logical output is assigned to each output connector, and also to internal screens that are not connected to a physical connector on the connector panel of the device.

The logical outputs are added in parentheses in the table below: Connector 1, Connector 2, etc.

These are the names that are used in the configuration and status paths, and also in API commands.

4K resolution

Note that you need Premium HDMI cables to support high resolutions and frame rates.

USB-C cables must support USB 3.1 Gen 1 / USB 3.2 Gen 1x1 (DisplayPort Alternate Mode).

Audio support

Note that audio is not supported on all outputs.

Product	Number of video outputs	In use for internal screens	Available for external screens and other output devices		
			Connectors	Maximum resolution	Audio support
Board	1	Internal (Connector 1)	None		
Board Pro	1	Internal (Connector 1)	None		
Codec EQ	3	None	HDMI 1 (Connector 1) HDMI 2 (Connector 2) HDMI 3 (Connector 3)	3840 × 2160 at 60 fps	If the connected camera has loudspeakers (Quad Camera) there is no audio on the HDMI outputs. If all connectors are set to Auto and no Quad Camera is connected, the device will try HDMI 1, then HDMI 2, and finally HDMI 3 and play the audio on the first available screen. See full description of the Audio Output HDMI [n] Mode in the Device Settings section.
Codec Plus	2	None	HDMI 1 (Connector 1) HDMI 2 (Connector 2)	3840 × 2160 at 60 fps	If the connected camera has loudspeakers (Quad Camera) there is no audio on the HDMI outputs. Otherwise there is audio on HDMI 1.
Codec Pro	3	None	HDMI 1 (Connector 1) HDMI 2 (Connector 2) HDMI 3 (Connector 3)	3840 × 2160 at 60 fps	If the connected camera has loudspeakers (Quad Camera) there is no audio on the HDMI outputs. If all connectors are set to Auto and no Quad Camera is connected, the device will try HDMI 1, then HDMI 2, and finally HDMI 3 and play the audio on the first available screen. See full description of the Audio Output HDMI [n] Mode in the Device Settings section.
Desk	1	Internal (Connector 1)	None		

Board

Board Pro

Codec EQ

Codec Plus

Codec Pro

Desk, Desk Pro, Desk Mini

Room Bar

Room Kit

Room Kit Mini

Room 55

Room 55 Dual, Room 70

Room 70 G2

Room 70 Panorama

Room Panorama

Setting up screens and other output devices (page 2 of 7)

Product	Number of video outputs	In use for internal screens	Available for external screens and other output devices		
			Connectors	Maximum resolution	Audio support
Desk Mini	1	Internal (Connector 1)	None		
Desk Pro	1	Internal (Connector 1)	None		
Room Bar	2	None	HDMI 1 (Connector 1) HDMI 2 (Connector 2)	3840 × 2160 at 60 fps	No audio on the HDMI outputs.
Room Kit	2	None	HDMI 1 (Connector 1) HDMI 2 (Connector 2)	3840 × 2160 at 60 fps	No audio on the HDMI outputs.
Room Kit Mini	1	None	HDMI (Connector 1)	3840 × 2160 at 60 fps	No audio on the HDMI output.
Room 55	2	Internal (Connector 1)	HDMI (Connector 2)	3840 × 2160 at 60 fps	No audio on the HDMI output.
Room 55 Dual / Room 70 Dual	2	HDMI 1 (Connector 1) HDMI 2 (Connector 2)	None		Audio only on the integrated screens.
Room 70 Single	2	HDMI 1 (Connector 1)	HDMI 2 (Connector 2)		Audio only on the integrated screens. If required, an external speaker can be connected to the audio line output connector.
Room 70 Dual G2	3	HDMI 1 (Connector 1) HDMI 2 (Connector 2)	HDMI 3 (Connector 3)		As default, audio only on the integrated screens.
Room 70 Single G2	3	HDMI 1 (Connector 1)	HDMI 2 (Connector 2) HDMI 3 (Connector 3)		As default, audio only on the integrated screen.
Room 70 Panorama	3	HDMI 1 (Connector 1) HDMI 2 (Connector 2) HDMI 3 (Connector 3)	None		
Room Panorama	3	HDMI 1 (Connector 1) HDMI 2 (Connector 2) HDMI 3 (Connector 3)	None		

* The internal screen is the user interface. It is not used for video or content.

Board

Board
ProCodec
EQCodec
PlusCodec
ProDesk,
Desk Pro,
DeskMiniRoom
Bar

Room Kit

Room Kit
Mini

Room 55

Room 55
Dual,
Room 70Room 70
G2Room 70
PanoramaRoom
Panorama

Setting up screens and other output devices (page 3 of 7)

Automatic setup

(Not relevant for devices with only one video output; and not relevant for Room 70 Panorama and Room Panorama which have a pre-defined behavior of all screens)

By default the number of screens is auto-detected, and the role of each screen - whether it is intended to be the first, second, or third screen - is automatically set according to the physical connections.

Sign in to the device web interface, go to [Settings](#), and select [Configurations](#), to find the settings referred below.

Examples

If the total number of screens are three, the following settings will be assumed when set to **Auto**:

- [Video > Monitors](#): **Triple**
- [Video > Output > Connector 1 > MonitorRole](#): **First**
- [Video > Output > Connector 2 > MonitorRole](#): **Second**
- [Video > Output > Connector 3 > MonitorRole](#): **Third**

If the total number of screens are two, the following settings will be assumed when set to **Auto**:

- [Video > Monitors](#): **Dual**
- [Video > Output > Connector 1 > MonitorRole](#): **First**¹
- [Video > Output > Connector 2 > MonitorRole](#): **Second**¹

When do you need manual setup

You can override the default behavior by setting one or more settings manually. You need manual setup when you want to:

- Dedicate a screen to only show presentations
- Use one of the outputs for a recorder ([available for Codec Pro and Room 70 G2](#))
- Replicate the same layout on more than one screen
- Show the on-screen messages and indicators (OSD) on another screen than the video output with the lowest number ([not available for Room 55](#))
- Set the resolution manually, e.g. if the device fails to detect the native resolution and refresh rate of a screen

¹ Room 55 doesn't have explicit MonitorRole settings. The internal screen (Connector 1) always assumes the monitor role **First**, and an external screen connected to the HDMI output (Connector 2) always assumes the monitor role **Second**.

Board

Board
ProCodec
EQCodec
PlusCodec
ProDesk,
Desk Pro,
DeskMiniRoom
Bar

Room Kit

Room Kit
Mini

Room 55

Room 55
Dual,
Room 70Room 70
G2Room 70
PanoramaRoom
Panorama

Setting up screens and other output devices (page 4 of 7)

Manual setup

(Not relevant for devices with only one video output; and not relevant for Room 70 Panorama and Room Panorama which have a pre-defined behavior of all screens)

The automatic setup works well for common scenarios with one or multiple screens. For more complex scenarios, you may need manual configuration.

Sign in to the device web interface, go to [Settings](#), and select [Configurations](#), to find the settings referred below

Set a role for each screen

Define a role for each screen with the [Video > Output > Connector n > MonitorRole](#) setting. ¹

The monitor role decides which layout (people and content) will appear on the screen that is connected to this output.

Screens with the same monitor role get the same layout; screens with different monitor roles get different layouts.

You must choose monitor roles that match your screen setup.

Set the number of screens

Set the number of screens with *different* layouts in your setup with the [Video > Monitors](#) setting.

Most often the number of different layouts are the same as the number of physical screens, but not always. If exactly the same layout shall be repeated on more than one screen, the number of different layouts is less.

When set to **Auto**, the device automatically detects if a screen is connected to a connector, and thereby also determines the number of screens in the setup.

The other options allow you to fix a single, dual, or triple screen setup; and to reserve one screen for content.

Choose on which screen to display messages and indicators

Define on which screen to display the messages and indicators on-screen with the [UserInterface > OSD > Output](#) setting. ²

When set to **Auto**, the device determines which screen to use based on the number of the connector.

Set the screen resolution and refresh rate

The device reads the native resolution of a screen and outputs this if possible. Typically, this gives the best possible picture on the screen.

If auto-detection of resolution and refresh rate fails, you must set the resolution manually with the [Video > Output > Connector n > Resolution](#) setting.

Examples

Two screens in total, and the second screen is dedicated to only show presentations:

- [Video > Monitors: DualPresentationOnly](#)
- [Video > Output > Connector 1 > MonitorRole: Auto](#) ¹
- [Video > Output > Connector 2 > MonitorRole: Auto](#)
- [UserInterface > OSD > Output: 1 or Auto](#) ^{2,3}

Three screens in total⁴, and the third screen is dedicated to only show presentations:

- [Video > Monitors: TriplePresentationOnly](#)
- [Video > Output > Connector 1 > MonitorRole: Auto](#)
- [Video > Output > Connector 2 > MonitorRole: Auto](#)
- [Video > Output > Connector 3 > MonitorRole: Auto](#)
- [UserInterface > OSD > Output: 1](#)

Two screens in total, and a recording device⁴ is attached to Connector 3 (HDMI). OSD is on the screen on Connector 2:

- [Video > Monitors: Auto](#)
- [Video > Output > Connector 1 > MonitorRole: Auto](#)
- [Video > Output > Connector 2 > MonitorRole: Auto](#)
- [Video > Output > Connector 3 > MonitorRole: Recorder](#)
- [UserInterface > OSD > Output: 2](#)

¹ Room 55 doesn't have explicit MonitorRole settings. The internal screen (Connector 1) always assumes the monitor role **First**, and an external screen connected to the HDMI output (Connector 2) always assumes the monitor role **Second**.

² Room 55 doesn't have the OSD Output setting. OSD is always displayed on the internal screen.

³ Set to **1** for Codec Pro and Room 70 G2; **Auto** for other devices.

⁴ Codec EQ, Codec Pro, and Room 70 G2 support three outputs, but only Codec Pro and Room 70 G2 support a recording device.

Board

Board Pro

Codec EQ

Codec Plus

Codec Pro

Desk, Desk Pro, Desk Mini

Room Bar

Room Kit

Room Kit Mini

Room 55

Room 55 Dual, Room 70

Room 70 G2

Room 70 Panorama

Room Panorama

Setting up screens and other output devices (page 5 of 7)

Output connectors

 Always switch off power when you connect and disconnect screens and peripherals.

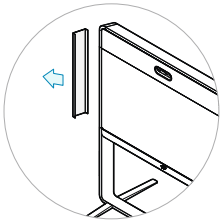

Remove the left side cover to get access to the connector panel and power switch for these devices. The cover is fastened with magnets.

Room 70 Single

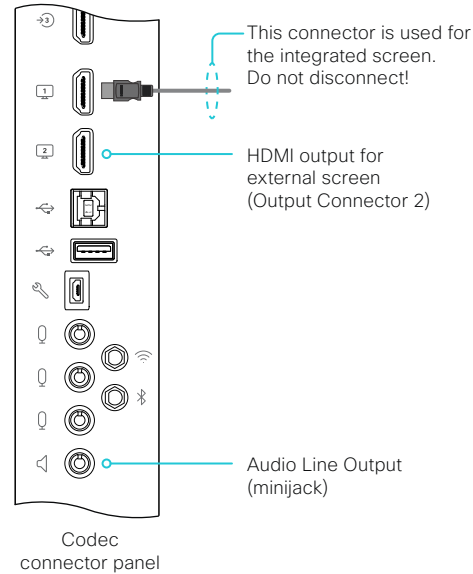

Room 55 Dual and Room 70 Dual

Both HDMI outputs (Output Connector 1 and 2) is used for the integrated screens. Do not disconnect!

Room 70 Dual G2

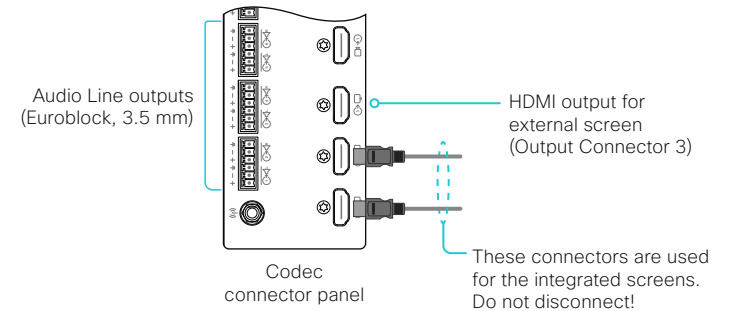

Room 70 Single G2

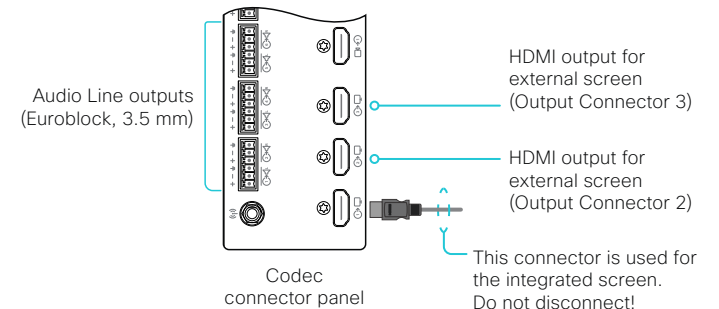

 Do not disconnect the integrated screens for Room 55 Dual, Room 70 and Room 70 G2.

The integrated screen connections make use of multichannel audio, which drives the speaker system of the devices. Inserting third party equipment is likely to break the audio chain, causing the device to fail from an audio perspective.

Board

Board Pro

Codec EQ

Codec Plus

Codec Pro

Desk, Desk Pro, Desk Mini

Room Bar

Room Kit

Room Kit Mini

Room 55

Room 55 Dual, Room 70

Room 70 G2

Room 70 Panorama

Room Panorama

D15503.01
RoomOS 11.1
02-2023



Setting up screens and other output devices (page 6 of 7)

Output connectors

Always switch off power when you connect and disconnect screens and peripherals.

Room Bar

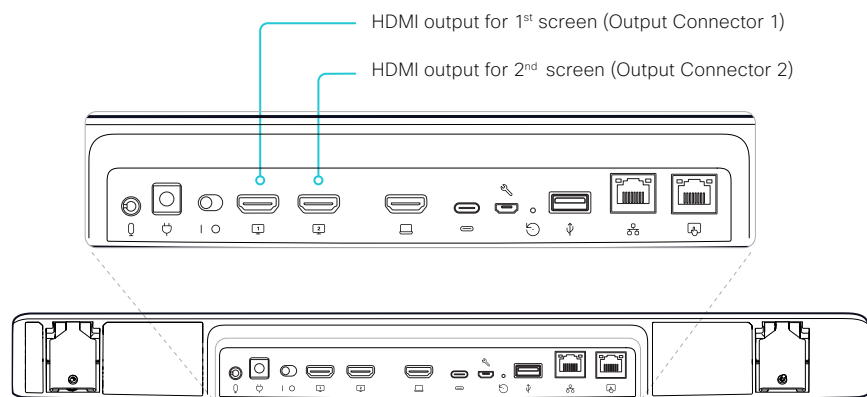

Room Kit

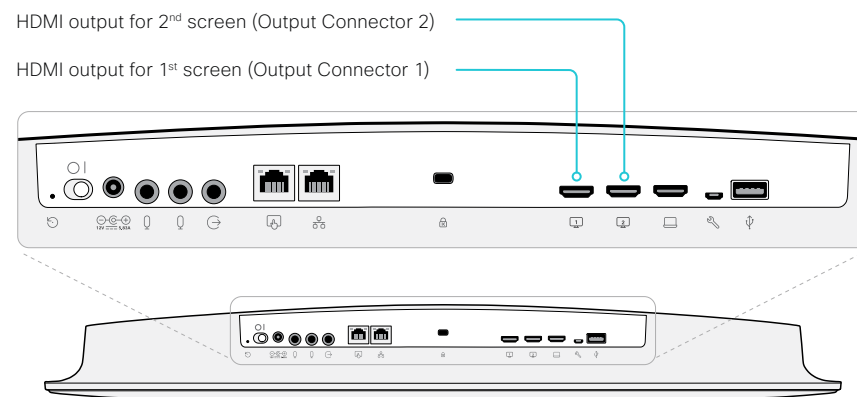

Room Kit Mini

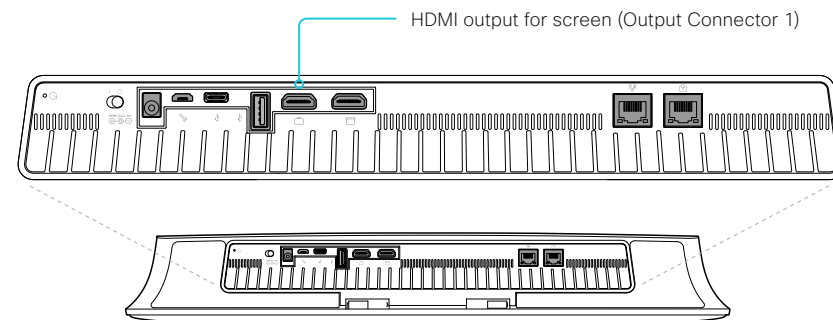

Board

Board Pro

Codec EQ

Codec Plus

Codec Pro

Desk, Desk Pro, DeskMini

Room Bar

Room Kit

Room Kit Mini

Room 55

Room 55 Dual, Room 70

Room 70 G2

Room 70 Panorama

Room Panorama

Setting up screens and other output devices (page 7 of 7)

Output connectors

 Always switch off power when you connect and disconnect screens and peripherals.

Codec EQ

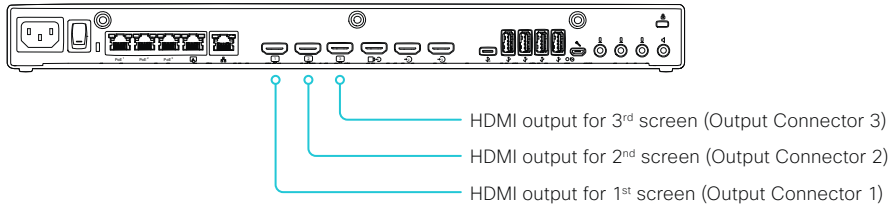

Codec Pro

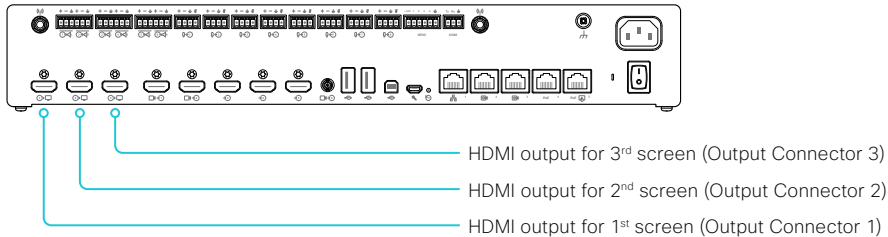

Codec Plus

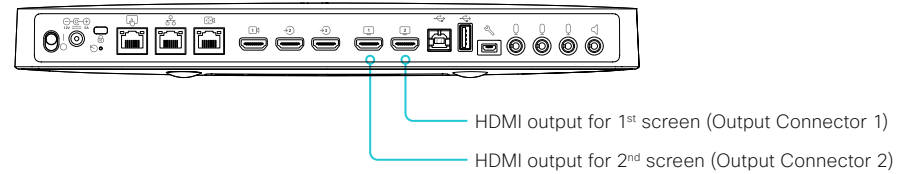

Room 55

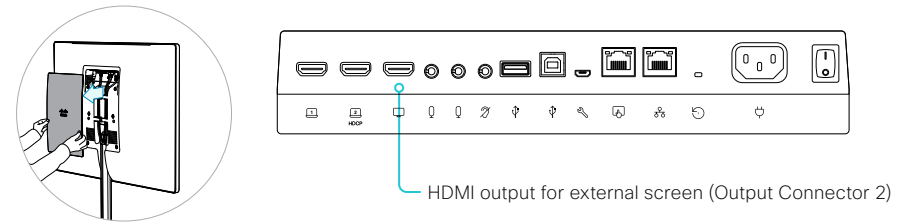

Remove the rear cover to get access to the connector panel and power switch.

Board

Board
ProCodec
EQCodec
PlusCodec
ProDesk,
Desk Pro,
Desk MiniRoom
Bar

Room Kit

Room Kit
Mini

Room 55

Room 55
Dual,
Room 70Room 70
G2Room 70
PanoramaRoom
Panorama

Connecting input sources (page 1 of 11)

Sign in to the device web interface, go to [Settings](#), and select [Configurations](#), to find the settings referred in this chapter.

The *number of video inputs* depends on the product. Typically, the video inputs are used for cameras and computers, and other content sources, but you can also connect other types of video and content sources.

When you connect a computer or content source to an input, you can share content locally or with conference participants.

The integrated devices has *internal cameras* in addition to connectors that are available for *external* content sources. The kits and codecs have connectors only for *external* cameras and other content sources.

Logical connectors

A logical input is assigned to each input connector, and also to internal cameras that are not connected to a physical connector on the connector panel of the device.

The logical inputs are added in parentheses in the table on the next pages: Connector 1, Connector 2, etc.

These are the names that are used in the configuration and status paths, and also in API commands.

About video and content quality

When encoding and transmitting video there is a trade-off between high resolution and high frame rate. For some video sources it is more important to transmit a high frame rate than high resolution and vice versa.

Use the [Video > Input > Connector n > Quality](#) setting to optimize quality with respect to motion (high frame rate) or sharpness (high resolution).

Typically, you should choose **Motion** for regular video inputs and when there is a lot of motion in the picture. Choose **Auto** or **Sharpness** when you want the highest quality of detailed images and graphics.



If a Quad Camera, SpeakerTrack 60 camera, or Precision 60 camera is detected by the device this setting is automatically set to **Motion**. If a user changes this setting manually, it will be set back to **Motion** after a restart or a camera reconnect.

When set to **Auto**, the device will continuously analyze the incoming video stream. As a starting point Auto leads to the highest possible resolution (sharpness). If motion is detected the encoding will automatically change to give the highest possible frame rate (motion).

The default value is **Motion** for connectors that are most often used for cameras, and **Auto** for connectors that are most often used for presentation sources. Refer to the table.

Set type and name for an input source

We recommend that you set type and name for an input source:

- [Video > Input > Connector n > InputSourceType](#)
- [Video > Input > Connector n > Name](#)

These settings determine the names and icons that are shown on the user interfaces. Intuitive names and icons make source selection easier.

Product	Quality default setting
Board	Connector 2: Auto
Board Pro	Connector 2, 3: Auto
Codec EQ	Connector 1, 2: Motion Connector 3, 4: Auto
Codec Plus	Connector 1: Motion Connector 2, 3: Auto
Codec Pro	Connector 1, 2: Motion Connector 3, 4, 5: Auto Connector 6: Motion
Desk / Desk Pro	Connector 2, 3: Auto
Desk Mini	Connector 2: Auto
Room Bar	Connector 2, 3: Auto
Room Kit / Room Kit Mini	Connector 2: Auto
Room 55	Connector 2, 3: Auto
Room 55 Dual / Room 70	Connector 1: Motion Connector 2, 3: Auto
Room 70 G2	Connector 1, 2: Motion Connector 3, 4, 5: Auto Connector 6: Motion
Room Panorama / Room 70 Panorama	Connector 1, 2: Motion Connector 3, 4, 5: Auto Connector 6: Motion

Board

Board
ProCodec
EQCodec
PlusCodec
ProDesk,
Desk Pro,
Desk MiniRoom
Bar

Room Kit

Room Kit
Mini

Room 55

Room 55
Dual,
Room 70Room 70
G2Room 70
PanoramaRoom
Panorama

Connecting input sources (page 2 of 11)

HDCP support

(Applies to: Board Pro, Codec EQ, Codec Plus, Codec Pro, Room 55, Room 55 Dual, Room 70, Room 70 G2, Room 70 Panorama, and Room Panorama)

You can configure one of the input connectors to support HDCP (High-bandwidth Digital Content Protection), which means that the device is authorized to display HDCP protected content.

 This only applies to specific connectors, refer to the table below.

Use this setting to enable HDCP on this input:

- [Video > Input > Connector n > HDCP > Mode](#)

When this setting is **On**, the content from the source that is connected to the specified connector can only be played locally; you cannot share it with other conference participants while in a call. This applies whether the content is HDCP protected or not.

Connecting the Quad Camera

(Applies to: Codec EQ, Codec Plus, and Codec Pro)

Always use Connector 1 when you connect the Quad Camera to the device. This is required for correct playback of audio through the loudspeakers in the camera.

For details about connecting cameras, refer to the installation guides for the Room Series products online.

Connecting a computer or other content source

You can connect one or more content sources, for example computers, to a device in order to share content locally or with conference participants. The number of external input sources and the maximum resolution they support is in the table below.

Note that you need a High Speed HDMI 1.4b cable to support the higher resolutions and frame rates.

USB-C cables must support USB 3.1 Gen 1 / USB 3.2 Gen 1x1 (DisplayPort Alternate Mode).

External analog microphones on devices that also have a built-in microphone

(Applies to: Board Pro, Room Bar, Room Kit, and Room 55)

These devices support one or two external microphones in addition to their built-in microphone. We recommend the Cisco Table Microphone or the Cisco TelePresence Ceiling Microphone.

Note that Microphone 1 is the integrated microphone.

For Board Pro, refer to the [Using external microphones with Board Pro](#) chapter for more information.

Board

Board Pro

Codec EQ

Codec Plus

Codec Pro

Desk, Desk Pro, Desk Mini

Room Bar

Room Kit

Room Kit Mini

Room 55

Room 55 Dual, Room 70

Room 70 G2

Room 70 Panorama

Room Panorama

Connecting input sources (page 3 of 11)

Input connector overview

Product	Number of video inputs	Reserved for internal camera	External input sources	Maximum resolution	HDCP support	Comments
Board	2	Internal (Connector 1)	HDMI 2 (Connector 2)	Connector 2: 3840 × 2160 at 30 fps or 1080p at 60 fps	Not available	
Board Pro	4	Internal (Connector 1)	USB-C (Connector 2) HDMI (Connector 3)	Connector 2: 3840 × 2160 at 60 fps Connector 3: 3840 × 2160 at 30 fps	HDMI (Connector 3)	<p>USB-C:</p> <ul style="list-style-type: none"> For content sharing, screen extension (external screen for computer), and touch forwarding capabilities on supported operating systems. The USB-C also allows the use of camera, microphone, and speakers with any software client (USB-camera mode); as well as, providing laptop charging (60W maximum). <p>HDMI:</p> <ul style="list-style-type: none"> For content sharing and screen extension (external screen for computer).
Codec EQ	4	N/A	HDMI 1 (Connector 1) HDMI 2 (Connector 2) HDMI 3 (Connector 3) USB-C (Connector 4)	Connector 1: 1920 × 1080 at 60 fps Connector 2: 3840 × 2160 at 30 fps Connector 3: 3840 × 2160 at 30 fps Connector 4: 3840 × 2160 at 30 fps	HDMI 3 (Connector 3)	<p>Quad Camera:</p> <ul style="list-style-type: none"> Always use Connector 1 <p>Camera Control:</p> <ul style="list-style-type: none"> Through one of the auxiliary Ethernet ports If you run out of Ethernet ports, you can connect an Ethernet switch to allow for camera control on all cameras. <p>HDMI:</p> <ul style="list-style-type: none"> For content sharing. <p>USB-C:</p> <ul style="list-style-type: none"> For content sharing. The USB-C also allows the use of camera, microphone, and speakers with any software client (USB-camera mode / USB-C passthrough).

- Board
- Board Pro
- Codec EQ
- Codec Plus
- Codec Pro
- Desk, Desk Pro, Desk Mini
- Room Bar
- Room Kit
- Room Kit Mini
- Room 55
- Room 55 Dual, Room 70
- Room 70 G2
- Room 70 Panorama
- Room Panorama

Connecting input sources (page 4 of 11)

Product	Number of video inputs	Reserved for internal camera	External input sources	Maximum resolution	HDCP support	Comments
Codec Plus	3	N/A	HDMI 1 (Connector 1) HDMI 2 (Connector 2) HDMI 3 (Connector 3)		HDMI 2 (Connector 2)	<p>Quad Camera:</p> <ul style="list-style-type: none"> Always use Connector 1 <p>SpeakerTrack 60:</p> <ul style="list-style-type: none"> Use Connector 1 and Connector 2 <p>Camera Control:</p> <ul style="list-style-type: none"> Through the auxiliary Ethernet port If you connect more than one camera you can connect an Ethernet switch to allow for camera control on all cameras.
Codec Pro	6	N/A	HDMI 1 (Connector 1) HDMI 2 (Connector 2) HDMI 3 (Connector 3) HDMI 4 (Connector 4) HDMI 5 (Connector 5) SDI (Connector 6)	Connector 1: 1080p60 Connector 2: 1080p60 Connector 3: 4Kp30 Connector 4: 4Kp30 Connector 5: 4Kp30	HDMI 5 (Connector 5)	<p>Quad Camera:</p> <ul style="list-style-type: none"> Always use Connector 1 <p>SpeakerTrack 60:</p> <ul style="list-style-type: none"> Use Connector 1 and Connector 2 <p>Camera Control:</p> <ul style="list-style-type: none"> Through the auxiliary Ethernet ports If you have more cameras than available auxiliary Ethernet ports you need an Ethernet switch to allow for camera control of all cameras.
Desk Pro	3	Internal (Connector 1)	USB-C (Connector 2) HDMI (Connector 3)	Connector 2: 3840 × 2160 at 60fps Connector 3: 3840 × 2160 at 60fps	Not available	<p>USB-C:</p> <ul style="list-style-type: none"> For content sharing, screen extension (external screen for computer), and touch forwarding capabilities on supported operating systems. The USB-C also allows the use of camera, microphone, and speakers with any software client (USB-camera mode / USB-C passthrough); as well as, providing laptop charging (60W maximum). <p>HDMI:</p> <ul style="list-style-type: none"> For content sharing and screen extension (external screen for computer).

Board

Board Pro

Codec EQ

Codec Plus

Codec Pro

Desk, Desk Pro, Desk Mini

Room Bar

Room Kit

Room Kit Mini

Room 55

Room 55 Dual, Room 70

Room 70 G2

Room 70 Panorama

Room Panorama

Connecting input sources (page 5 of 11)

Product	Number of video inputs	Reserved for internal camera	External input sources	Maximum resolution	HDCP support	Comments
Desk	3	Internal (Connector 1)	USB-C (Connector 2) HDMI (Connector 3)	Connector 2: 1920 × 1080 at 60fps Connector 3: 1920 × 1080 at 60fps	Not available	<p>USB-C:</p> <ul style="list-style-type: none"> For content sharing, screen extension (external screen for computer), and touch forwarding capabilities on supported operating systems The USB-C also allows the use of camera, microphone, and speakers with any software client (USB-camera mode / USB-C passthrough). <p>HDMI:</p> <ul style="list-style-type: none"> For screen extension and content sharing.
Desk Mini	2	Internal (Connector 1)	USB-C (Connector 2)	Connector 2: 1920 × 1080 at 60fps	Not available	<p>For content sharing, screen extension (external screen for computer), and touch forwarding capabilities on supported operating systems.</p> <p>The USB-C also allows the use of camera, microphone, and speakers with any software client (USB-camera mode / USB-C passthrough).</p>
Room Bar	3	Internal (Connector 1)	USB-C (Connector 2) HDMI (Connector 3)	Connector 2: 3840 × 2160 at 30fps or 1920 × 1080 at 60fps Connector 3: 3840 × 2160 at 30fps or 1920 × 1080 at 60fps	Not available	<p>USB-C:</p> <ul style="list-style-type: none"> For content sharing and screen extension (external screen for computer). The USB-C also allows the use of camera, microphone, and speakers with any software client (USB-camera mode / USB-C passthrough). <p>HDMI:</p> <ul style="list-style-type: none"> For screen extension and content sharing.
Room Kit	2	Internal (Connector 1)	HDMI 2 (Connector 2)	Connector 2: 3840 × 2160 at 30fps	Not available	
Room Kit Mini	2	Internal (Connector 1)	HDMI 2 (Connector 2)	Connector 2: 3840 × 2160 at 30fps	Not available	
Room 55	3	Internal (Connector 1)	HDMI 1 (Connector 2) HDMI 2 (Connector 3)	Connector 2: 3840 × 2160 at 30fps Connector 3: 3840 × 2160 at 30fps	HDMI 2 (Connector 3)	

Board

Board Pro

Codec EQ

Codec Plus

Codec Pro

Desk, Desk Pro, Desk Mini

Room Bar

Room Kit

Room Kit Mini

Room 55

Room 55 Dual, Room 70

Room 70 G2

Room 70 Panorama

Room Panorama

Connecting input sources (page 6 of 11)

Product	Number of video inputs	Reserved for internal camera	External input sources	Maximum resolution	HDCP support	Comments
Room 55 Dual / Room 70	3	HDMI 1 (Connector 1)	HDMI 2 (Connector 2) HDMI 3 (Connector 3)		HDMI 2 (Connector 2)	Camera Control: Through the auxiliary Ethernet port If you connect extra cameras you need an Ethernet switch to allow for camera control on all cameras.
Room 70 G2	6	HDMI 1 (Connector 1)	HDMI 2 (Connector 2) HDMI 3 (Connector 3) HDMI 4 (Connector 4) HDMI 5 (Connector 5) SDI (Connector 6)	Connector 1: 1080p60 Connector 2: 1080p60 Connector 3: 4Kp30 Connector 4: 4Kp30 Connector 5: 4Kp30	HDMI 5 (Connector 5)	Camera Control: Through the auxiliary Ethernet ports If you have more cameras than available auxiliary Ethernet ports you need an Ethernet switch to allow for camera control of all cameras.
Room 70 Panorama	6	HDMI 1 (Connector 1) HDMI 2 (Connector 2)	HDMI 3 (Connector 3) HDMI 4 (Connector 4) HDMI 5 (Connector 5) SDI (Connector 6)	Connector 1: 1080p60 Connector 2: 1080p60 Connector 3: 4Kp30 Connector 4: 4Kp30 Connector 5: 4Kp30	HDMI 5 (Connector 5)	Camera control is through Ethernet port 2.
Room Panorama	6	HDMI 1 (Connector 1) HDMI 2 (Connector 2)	HDMI 3 (Connector 3) HDMI 4 (Connector 4) HDMI 5 (Connector 5) SDI (Connector 6)	Connector 1: 1080p60 Connector 2: 1080p60 Connector 3: 4Kp30 Connector 4: 4Kp30 Connector 5: 4Kp30	HDMI 5 (Connector 5)	Camera control is through Ethernet port 2.

Board

Board Pro

Codec EQ

Codec Plus

Codec Pro

Desk, Desk Pro, DeskMini

Room Bar

Room Kit

Room Kit Mini

Room 55

Room 55 Dual, Room 70

Room 70 G2

Room 70 Panorama

Room Panorama

Connecting input sources (page 7 of 11)

Input connectors

 Always switch off power when you connect and disconnect peripherals.

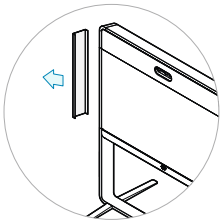

Remove the left side cover to get access to the connector panel and power switch for these devices. The cover is fastened with magnets.

Room 55 Dual and Room 70

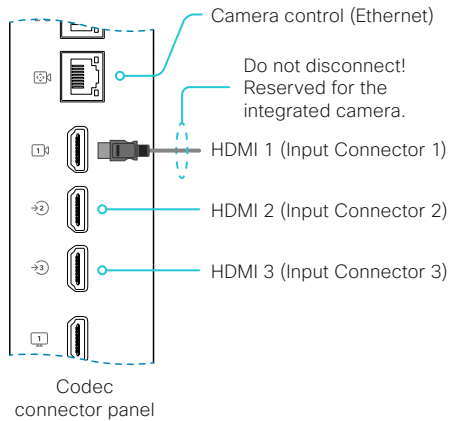

Room 70 G2

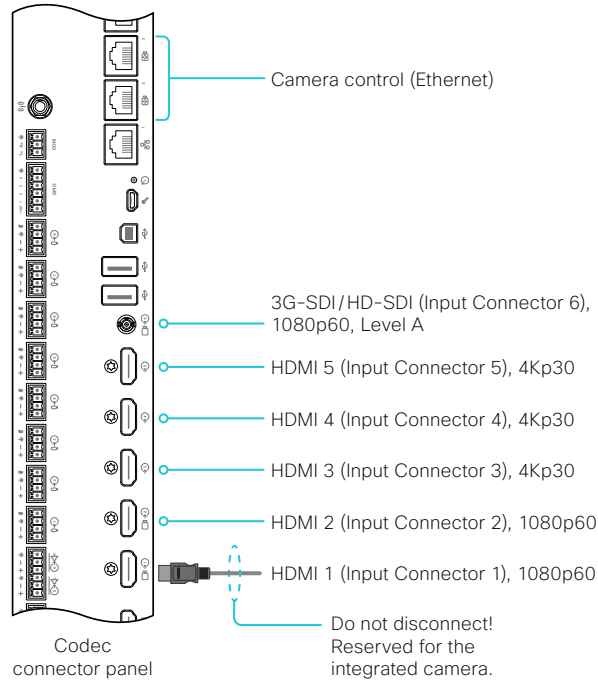

Room 70 Panorama

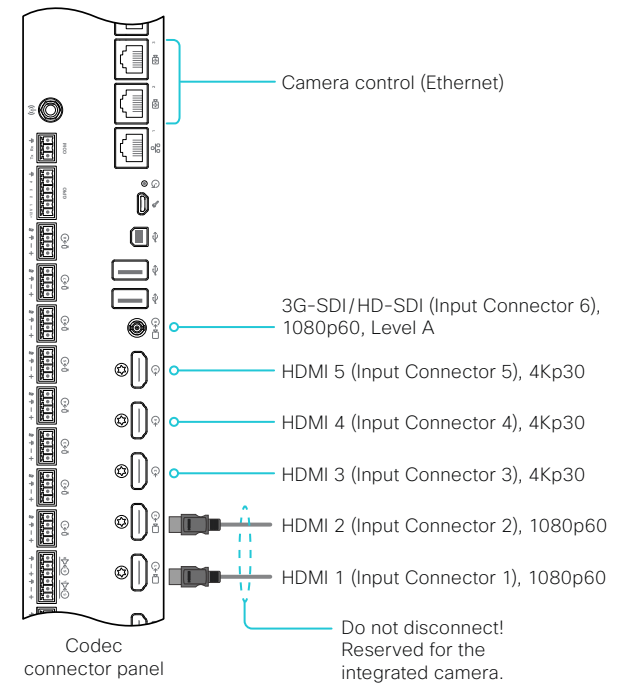

Board

Board Pro

Codec EQ

Codec Plus

Codec Pro

Desk, Desk Pro, Desk Mini

Room Bar

Room Kit

Room Kit Mini

Room 55

Room 55 Dual, Room 70

Room 70 G2

Room 70 Panorama

Room Panorama

Connecting input sources (page 8 of 11)

Input connectors

 Always switch off power when you connect and disconnect peripherals.

Codec EQ

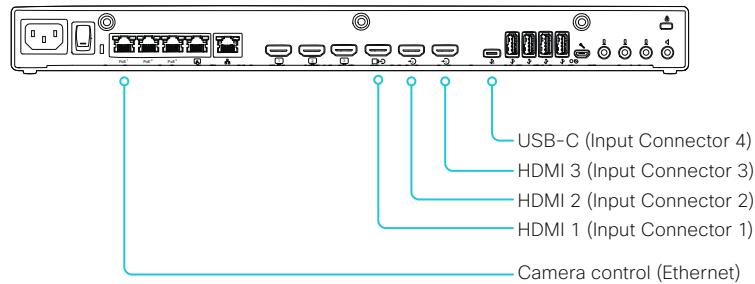

Codec Plus

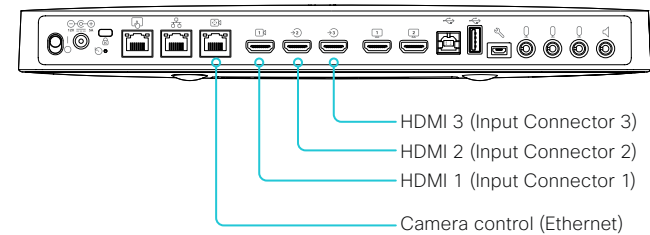

Codec Pro and Room Panorama

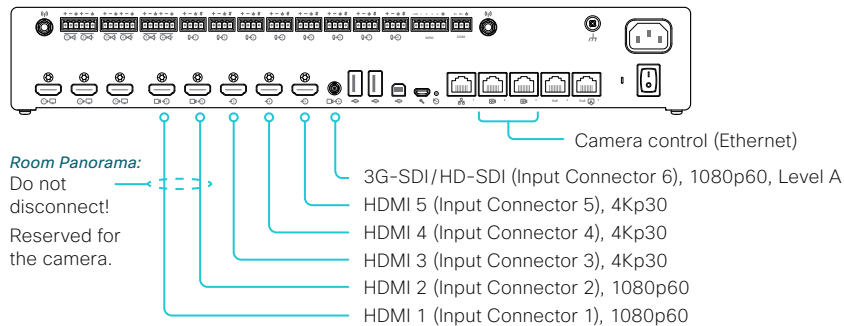

Room 55

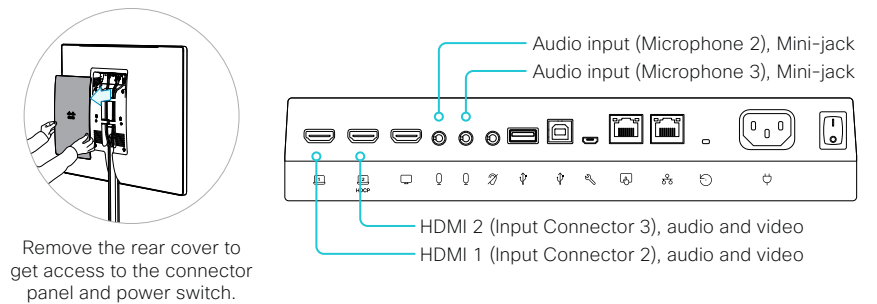

Board

Board Pro

Codec EQ

Codec Plus

Codec Pro

Desk, Desk Pro, Desk Mini

Room Bar

Room Kit

Room Kit Mini

Room 55

Room 55 Dual, Room 70

Room 70 G2

Room 70 Panorama

Room Panorama

Connecting input sources (page 9 of 11)

Input connectors

 Always switch off power when you connect and disconnect peripherals.

Room Bar

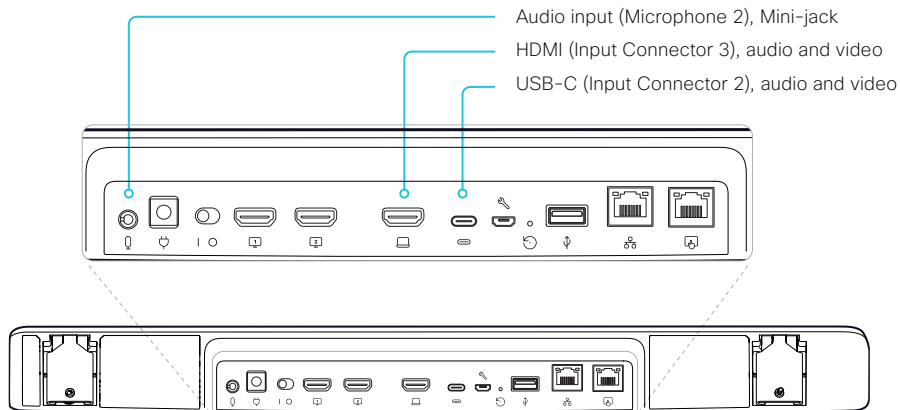

Room Kit

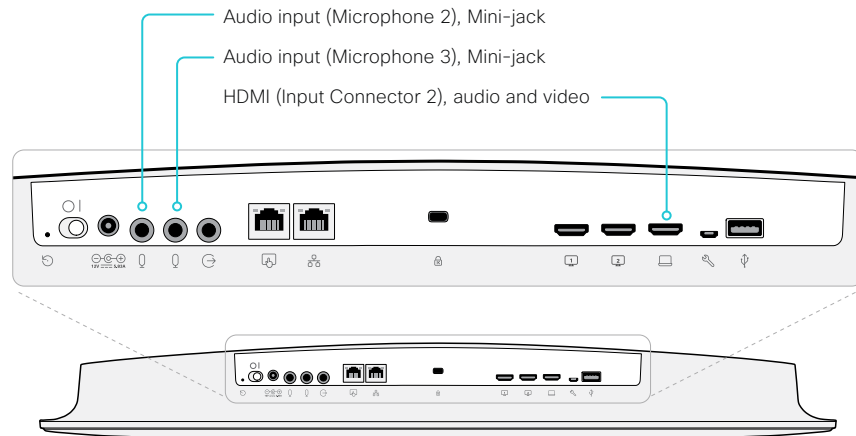

Room Kit Mini

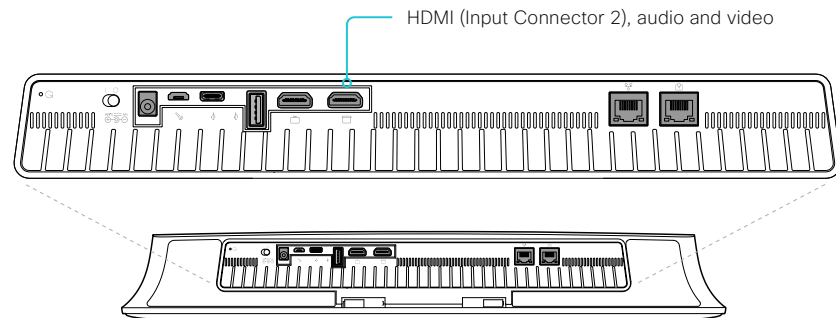

Board

Board Pro

Codec EQ

Codec Plus

Codec Pro

Desk, Desk Pro, Desk Mini

Room Bar

Room Kit

Room Kit Mini

Room 55

Room 55 Dual, Room 70

Room 70 G2

Room 70 Panorama

Room Panorama

Connecting input sources (page 10 of 11)

Input connectors

 Always switch off when you connect and disconnect peripherals.

Desk and Desk Pro

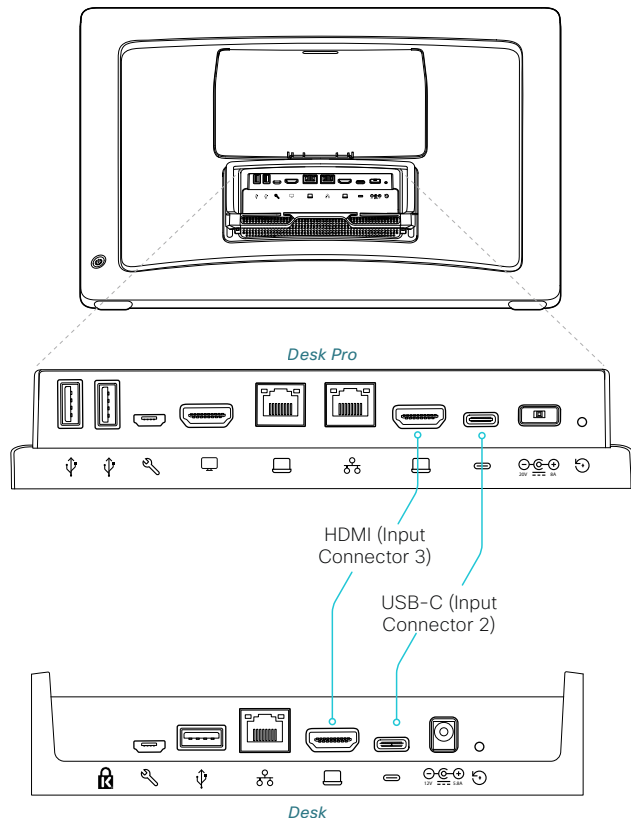

Desk Mini

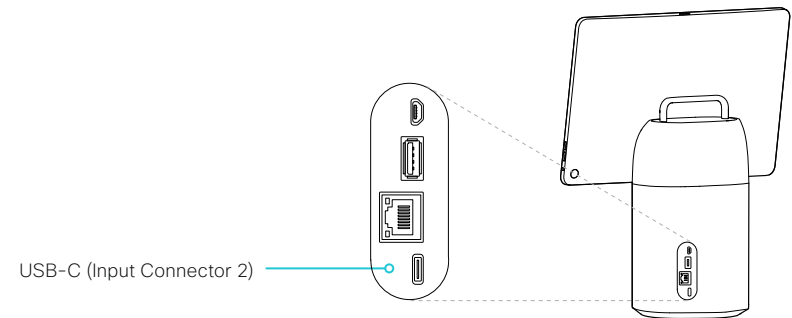

Board

Board Pro

Codec EQ

Codec Plus

Codec Pro

Desk, Desk Pro, Desk Mini

Room Bar

Room Kit

Room Kit Mini

Room 55

Room 55 Dual, Room 70

Room 70 G2

Room 70 Panorama

Room Panorama

Connecting input sources (page 11 of 11)

Input connectors

 Always switch off when you connect and disconnect peripherals.

Board

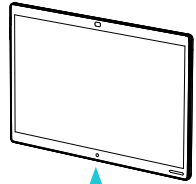

The connector panel is at the bottom

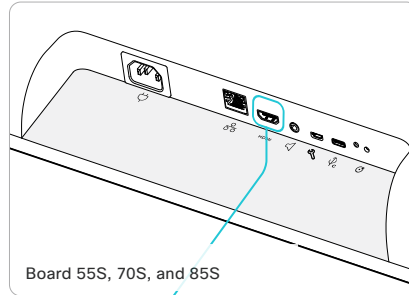

Board 55S, 70S, and 85S

HDMI (Input Connector 2), audio and video

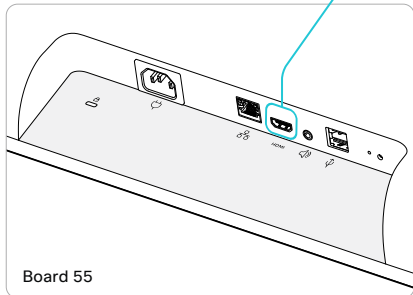

Board 55

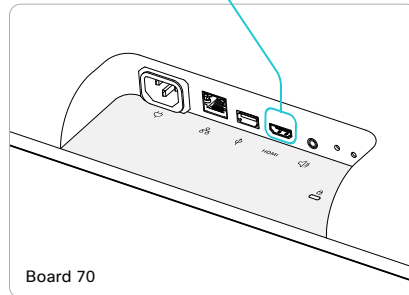

Board 70

Board Pro

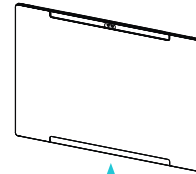

The connector panel is at the bottom

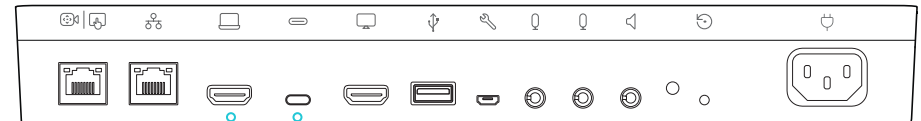

Audio input (Microphone 3), Mini-jack

Audio input (Microphone 2), Mini-jack

USB-C (Input Connector 2), audio and video

HDMI (Input Connector 3), audio and video

- Board
- Board Pro
- Codec EQ
- Codec Plus
- Codec Pro
- Desk, Desk Pro, Desk Mini
- Room Bar
- Room Kit
- Room Kit Mini
- Room 55
- Room 55 Dual, Room 70
- Room 70 G2
- Room 70 Panorama
- Room Panorama

Extend the number of input sources

You can customize our touch user interfaces to include input sources that are connected to a third-party external video switch.

The sources will appear and behave as any other video source that is connected directly to the video conferencing device.

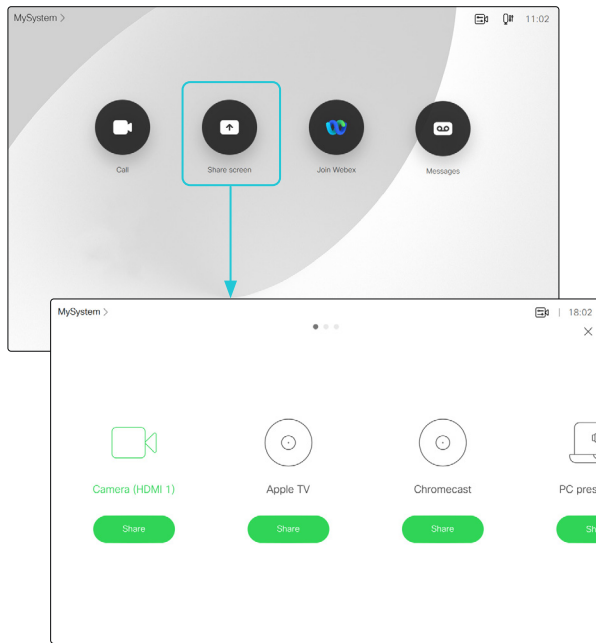

User interface with multiple external input sources (example)

Consult the *Customization guide* for full details about how to extend the user interface, and how to use the device's API to set it up. Go to:

► <https://www.cisco.com/go/in-room-control-docs>

Architecture

You need a Cisco video conferencing device with a touch interface, a third-party control system, for example Lightware, Crestron, or AMX, and a third-party video switch. It is the control system, not the video conferencing device, that controls the video switch.

When you program the control system you must use the video conferencing device's API (events and commands)* in order to connect with the video switch and the controls on the touch interface. This way you can synchronize what is shown and done on the user interface with the actual state of the input sources.

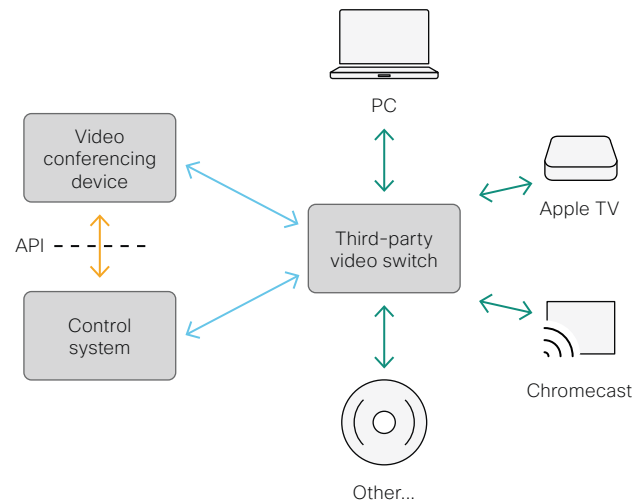

* You need a user that holds the ROOMCONTROL, INTEGRATOR, or ADMIN user roles in order to access the API commands that you need when programming the control system.

Board

Board
ProCodec
EQCodec
PlusDesk,
Desk Pro,
Desk MiniDesk,
Desk Pro,
Desk MiniRoom
Bar

Room Kit

Room Kit
Mini

Room 55

Room 55
Dual,
Room 70Room 70
G2Room 70
PanoramaRoom
Panorama

Information about displays

Display recommendations

As a technology leader in video conferencing, Webex has created a certification program to further ensure premium meeting experiences with third party displays.

Webex Certifications are done using rigorous analysis and test specifications. These define a standard point of reference for performance that faithfully reproduces the engineering intent.

The Webex Rooms devices are designed to optimize picture quality, minimize the camera-to-screen delay, implement robust standby handling, and implement other measures for an optimal experience.

Webex Rooms certified or compatible displays

We recommend using Webex Rooms certified or compatible displays. Compatibility is verified, and they give the best experience when connected to a Webex device.

You can find information about the certification program and a list of supported third-party displays here:

► <https://cs.co/certifiedvendors>

Other displays

If not using a certified display, it is important that you configure the display is to give the best possible experience.

In the default display configuration, the delay through most displays is often very high (>100 ms). This can be detrimental to real-time communication quality.

The following display settings may reduce the delay:

- Activate *Game* mode, *PC* mode, or similar modes that are designed to reduce the response time and normally also the delay.
- Deactivate motion smoothing, such as *Motion Flow*, *Natural Motion*, or any other video processing that introduces delay.
- Deactivate advanced audio processing, such as *Virtual Surround* effects and *Dynamic Compression*, which will cause malfunctions in acoustic echo cancellation.

In order to achieve automatic input switching and standby control, the Consumer Electronics Control (CEC) function of the display may need to be enabled manually.

This function is then utilized as follows:

- The active video input on a display may be changed by the user through the manufacturer's user interface. Therefore, when a call is placed, the video conferencing device queries the active video input source and switches this source back to itself, if necessary.
- If the video conferencing device goes into standby without being the active input source, the display will not be set to standby.

Board

Board
ProCodec
EQCodec
PlusCodec
ProDesk,
Desk Pro,
Desk MiniRoom
Bar

Room Kit

Room Kit
Mini

Room 55

Room 55
Dual,
Room 70Room 70
G2Room 70
PanoramaRoom
Panorama

Information about resolutions

Connecting a computer

It is the connected computer, or other input source, that finally decides which resolution to send to the video device.

The video device signals which resolutions it supports, and also its preferred resolution. The default preferred resolution depends on the video device. Also, different connectors on the same device may support and prefer different resolutions.

You can change the default preferred resolution as follows:

1. Sign in to the device web interface, go to [Settings](#), and select [Configurations](#).
2. Go to [Video > Input > Connector n > PreferredResolution](#), and adjust the value.
3. Click [Save](#).

If an error occurs when you connect a computer, a message will show on the screen or touch controller.

Connecting an external display

(Applies to: All products except Board, Board Pro, Desk, Desk Mini, Desk Pro, Room 70 Panorama, and Room Panorama)

When you start the device for the first time, the setup assistant starts automatically. This is where you test the external display and adjust the settings. Follow the on-screen instructions.

If you need to adjust the settings for the external display at a later stage, sign in to the device web interface, go to [Settings](#), and select [Configurations](#). Go to [Video > Output > Connector n > Resolution](#), and adjust the screen resolution. Set the resolution according to what your display supports.

If your screen is black or flickering, you can set the resolution to a lower setting. If there still are problems, check that the cable is connected to a port on your display that supports Ultra HD. Check also that the Ultra HD settings are set to On on your display.

Cisco provides lists of Webex Room certified and compatible displays. Refer to the [Information about displays](#) chapter.

Checklist

For guaranteed operation, use cables from Cisco, or other certified cables. Refer to the [Information about HDMI and USB-C cables](#) chapter.

Check that the video conferencing device's connectors (input and/or output) are configured correctly.

Check that the connected external device has support for 4K and that it is configured correctly.

The need for high quality cables increases with 4K usage:

- 4kp30 uses about twice the data rate of 1080p60
- 4kp60 uses about four times the data rate of 1080p60

Board

Board
ProCodec
EQCodec
PlusCodec
ProDesk,
Desk Pro,
Desk MiniRoom
Bar

Room Kit

Room Kit
Mini

Room 55

Room 55
Dual,
Room 70Room 70
G2Room 70
PanoramaRoom
Panorama

Information about HDMI and USB-C cables

You need HDMI or USB-C cables for:

- Presentation sources
- External cameras (*not supported by Board, Desk, Desk Mini, and Desk Pro*)
- External displays (*not supported by Board, Board Pro, Desk, Desk Mini, and Desk Pro*)

Some devices have HDMI inputs/outputs, some have USB-C inputs/outputs, and some have a combination of HDMI and USB-C inputs/outputs. Refer to the ► [Physical interfaces](#) chapter to find details of each device's connector panel.



For guaranteed operation we recommend that you order cables from Cisco^{1,2}, or use certified cables.

HDMI cables for presentation sources

A presentation source can be a PC/laptop, document camera, media player, whiteboard, or other device.

The resolution formats larger than 1920×1080@60fps require use of high speed HDMI cables. For guaranteed operation, use a HDMI cable from Cisco, or use a cable that complies with the high speed HDMI 1.4b Category 2 specification.

We recommend that you order the HDMI presentation cable from Cisco (HDMI 1.4b Category 2).

HDMI cables for external cameras and displays

The resolution formats larger than 1920×1200@60fps require use of high speed HDMI cables. For guaranteed operation, use HDMI cables that are pre-qualified from Cisco³ for use at 3840×2160@60fps, or use a cable that has passed the Premium HDMI Cable Certification Programme.

USB-C cables

In general, you need USB-C cables that support USB 3.1 Gen 1 / USB 3.2 Gen 1x1:

- Length up to 2 meters for passive cables ²
- Power delivery 3A or 5A (60W or 100W) ⁴
- Support for DisplayPort Alternate Mode

More information

HDMI

You can find more information about HDMI cables at ► <http://www.hdmi.org>

Connecting input sources and displays to the video devices

You will find more details about how to connect displays, cameras, and computers to the different video devices in these sections:

- [Connecting input sources](#)
- [Setting up screens and other output devices](#)

¹ Our 4K multihead cables (CAB-HDMI-MUL4K-9M and CAB-HDMI-MUL4K-2M) support up to 4Kp30 resolutions, and are compatible with devices in the Board and Room series. The cables have connectors HDMI type A ↔ USB-C, Mini display port, and HDMI type A.

Our 1080p multihead cable (CAB-HDMI-MULT-9M) is not compatible with these devices.

² Our 9 m *active*, optical USB-C cable (CAB-USBC-AC-9M) complies with USB 3.1 Gen 1 / USB 3.2 Gen 1x1 and provides charging (60W). The cable can be used with all our devices that have USB-C connectors except Desk and Desk Pro (the exception is due to the physical size of the connector).

³ Our 8 m *active* HDMI cable (CAB-PRES-2HDMI-GR) is only for presentation sources. Don't use it for a camera that requires ARC (Quad Camera).

⁴ Required only for inputs that offer power charging over USB-C.

Board

Board Pro

Codec EQ

Codec Plus

Codec Pro

Desk, Desk Pro, Desk Mini

Room Bar

Room Kit

Room Kit Mini

Room 55

Room 55 Dual, Room 70

Room 70 G2

Room 70 Panorama

Room Panorama

Set up automatic framing features (page 1 of 5)

The device's automatic framing capabilities depend on the camera. The major framing features are:

- Best overview - the smallest frame that still covers all people in the room
- Speaker tracking - zoom in on the active speaker (closeup) or a group of people close to the speaker (group framing)
- Frames - composition of closeups of all individuals, excess background removed

	Best overview	Closeup and group framing	Frames
Board Pro Board	x	x	x
Desk Pro Desk Desk Mini	x		
Codec EQ ¹ Codec Plus ² Codec Pro ²	x	x	x
Room Bar	x		x
Room Kit Mini	x		x
Room Kit Room 55	x	x	x
Room 55 Dual Room 70 Room 70 G2	x	x	x
Room 70 Panorama ³ Room Panorama ³	x	x	

Best overview

Head detection⁴ and automatic camera framing are used to assess the situation and compose the *best overview* containing **all** the people in the room. If people are moving around in the room or additional participants enter the room, the system will adapt and automatically adjust to include all persons in the frame.

Limit the maximum view (room overview)

Not supported by the SpeakerTrack 60 camera, Desk, Desk Mini, Desk Pro, or the Room Panorama / Room 70 Panorama in panoramic video scenarios.

By default, the maximum view for best overview / speaker tracking (room overview) is the fully zoomed-out camera view.

The user can define a less zoomed-out view as maximum from the user interface.

Closeup and group framing

Not supported by Desk, Desk Mini, Desk Pro, Room Bar, or Room Kit Mini.

When closeup is enabled (*Cameras > SpeakerTrack > Closeup*), audio tracking is used to locate the active speaker in a room.

Once the active speaker is located, the device decides whether to focus and zoom in solely on the active speaker (closeup) or to create frames that include, not only the active speaker, but also the participants in close proximity to him/her (group framing). Other participants will be excluded from the frame.

If you want to ensure that everyone in the room is always in the camera frame, turn off the closeup functionality.

For cameras and devices that support group framing, finding a good group framing is prioritized over making a closeup of only the active speaker. This has the positive effect of reducing the total number of switches and thereby creating a more natural user experience. For example, if another person within the frame starts to speak, the camera will most likely not need to reframe.

Also, depending on the maximum zoom factor of the camera and the distance at which the speaker is located away from the camera, it might not be possible to create a framing for the speaker alone.

¹ Requires Quad Camera (Room Kit EQ).

² Requires Quad Camera (Room Kit Plus / Room Kit Pro) or SpeakerTrack 60 camera.

³ In panoramic video scenarios, the 2-camera panoramic view cannot be switched off. In all other scenarios, the automatic framing features works and can be configured as described in this chapter.

⁴ Exception: The SpeakerTrack 60 camera is using a face detection algorithm instead of a head detection algorithm. Therefore speaker tracking / best overview doesn't work well when people are wearing masks.

Board

Board Pro

Codec EQ

Codec Plus

Codec Pro

Desk, Desk Pro, Desk Mini

Room Bar

Room Kit

Room Kit Mini

Room 55

Room 55 Dual, Room 70

Room 70 G2

Room 70 Panorama

Room Panorama

Set up automatic framing features (page 2 of 5)

Frames

When Frames is enabled (*Cameras > SpeakerTrack > Frames > Mode*), the camera will zoom and show people individually or in smaller groups. These individual and group frames are further composed into one outgoing video stream. In this stream excess background is removed, the people are shown closer to each other, uniform in size, and at the same eye level.

The camera supports up to four frames. All the image processing is done on the sender side, so the receiving device doesn't have to support Frames.

Frames mode depends on the speaker tracking technology; hence the *Cameras > SpeakerTrack > Mode* must be set to **Auto** for Frames to work.



Video stream *without* Frames enabled



Video stream *with* Frames enabled

Board

Board
ProCodec
EQCodec
PlusCodec
ProDesk,
Desk Pro,
DeskMiniRoom
Bar

Room Kit

Room Kit
Mini

Room 55

Room
55 Dual,
Room 70Room 70
G2Room 70
PanoramaRoom
Panorama

Set up automatic framing features (page 3 of 5)

Camera specifics

Cisco Quad Camera

(an option for Codec EQ, Codec Plus, and Codec Pro)

- The camera supports best overview, closeup and group framing, and frames.
- Finding a good group framing is prioritized over making a closeup of only the active speaker.
- The camera has a lower maximum zoom factor than the SpeakerTrack 60 camera and therefore cannot zoom in so closely on speakers far away from the camera.
- The maximum zoom level that can be saved on a preset camera position is 95%. Any zoom level beyond this maximum will be saved at 95%.
- Certain room conditions such as lighting and acoustics, can significantly impact the Quad camera's ability to detect every person present. Speaker tracking functionality works best under optimal room conditions in combination with a seating area that is a maximum of 8 m/26 ft deep and up to 5 m/16 ft wide, in relation to the camera's position. Sub-optimal room conditions or a camera distance greater than 8 m/26 ft will cause performance to degrade.
- Participants seated outside the horizontal field of view (83°) will not be detected.

Cisco TelePresence SpeakerTrack 60 Camera

(an option for Codec Plus and Codec Pro)

- The dual camera assembly consists of two cameras that support best overview and closeup.
- Group framing is not supported. When a change of speaker is detected, the video conferencing device will switch automatically between the two cameras to always show the optimal camera frame.
- SpeakerTrack 60 works best when the room's seating area is a maximum of 9 m/30 ft deep and 5 m/16 ft wide, in relation to the camera's position.
- Participants seated outside the horizontal field of view (80°) will not be detected. Room conditions such as lighting, also impact the camera's ability to detect people.

Board

Board
ProCodec
EQCodec
PlusCodec
ProDesk,
Desk Pro,
Desk MiniRoom
Bar

Room Kit

Room Kit
Mini

Room 55

Room 55
Dual,
Room 70Room 70
G2Room 70
PanoramaRoom
Panorama

Set up automatic framing features (page 4 of 5)

Sign in to the device web interface, go to [Settings](#), and select [Configurations](#), to find the settings referred.

Configure the automatic framing features

Best overview / Speaker tracking

[Cameras > SpeakerTrack > Mode](#)

Enable or disable Best overview / Speaker tracking.

Auto: Best overview / Speaker tracking is enabled by default. Users can switch the mode on or off instantly from the camera control panel in the user interface.

Off: Best overview / Speaker tracking is switched off and it is not possible to switch it on from the user interface.

Closeup and group framing

Not supported by Desk, Desk Mini, Desk Pro, Room Bar, and Room Kit Mini.

[Cameras > SpeakerTrack > Closeup](#)

This setting only applies when the [Cameras > SpeakerTrack > Mode](#) is set to **Auto**.

Turn on/off the closeup and group framing feature.

Auto: The behavior depends on the device type. **Board** and **Board Pro** will strive to keep everyone in the room in the camera frame at all times. The other devices will zoom in either solely on the active speaker or the active speaker and the participants in close proximity to him/her (group frame).

Off: The device will keep everyone in the room in the camera frame at all times.

On: The device will zoom in either solely on the active speaker or the active speaker and the participants in close proximity to him/her (group frame).

Frames

Not supported by Desk, Desk Mini, Desk Pro, Room 70 Panorama, and Room Panorama.

[Cameras > SpeakerTrack > Frames > Mode](#)

This setting only applies when the [Cameras > SpeakerTrack > Mode](#) is set to **Auto**.

Turn on/off support for the Frames camera mode (removal of excess background).

Auto: The user can switch Frames on and off using the camera controls on the device's user interface.

Off: Frames are not available.

Board

Board
ProCodec
EQCodec
PlusCodec
ProDesk,
Desk Pro,
DeskMiniRoom
Bar

Room Kit

Room Kit
Mini

Room 55

Room
55 Dual,
Room 70Room 70
G2Room 70
PanoramaRoom
Panorama

Set up automatic framing features (page 5 of 5)

Tracking mode

Applies to Codec Plus and Codec Pro, when these devices are using a SpeakerTrack 60 camera.

The tracking mode defines how fast the camera view will switch to a new speaker when the tracking algorithm detects a change.

[Cameras > SpeakerTrack > TrackingMode](#)

Auto: This is the default setting.

Conservative: The device reacts slower to detected changes and delays switching the camera view.

Speaker track connector detection

Applies to Codec Plus and Codec Pro, when these devices are using a SpeakerTrack 60 camera.

In most cases the device detects automatically which inputs the left and right camera of the Speaker Track 60 are connected to. You should only set the connector detection mode to Manual if that's not the case.

[Cameras > SpeakerTrack > ConnectorDetection > Mode](#)

Auto: The device will automatically detect the video input.

Manual: Manually configure the video input for each individual camera. You should choose manual configuration in situations where the video conferencing device does not receive Extended Display Identification Data (EDID) information from the cameras.

If the connector detection mode is set to Manual, you must specify which video input connectors the left and right cameras are connected to.

[Cameras > SpeakerTrack > ConnectorDetection > CameraRight](#)

[Cameras > SpeakerTrack > ConnectorDetection > CameraLeft](#)

Set the number of the video input connectors that the left and right camera of the SpeakerTrack 60 are connected to.

Settings that are overridden by the speaker track functionality

Applies to Codec Plus and Codec Pro, when these devices are using a SpeakerTrack 60 camera.

These settings are changed automatically when speaker tracking is on:

- [Video > Input > Connector n > Quality](#)

These settings are always forced to **Motion** for the connectors where the dual cameras are connected. If both settings are already set to **Motion**, there is no change.

- [Video > Input > Connector n > OptimalDefinition > Threshold60fps](#)

These settings will stay untouched if they are already equal for the connectors where the dual cameras are connected. If they are not equal, the lowest threshold among the two is preferred.

- [Video > Input > Connector n > OptimalDefinition > Profile](#)

These settings will stay untouched if they are already equal for the connectors where the dual cameras are connected. If they are not equal, the preferred setting is the first value in the list, (**Normal, Medium, High**) that one of the two settings has.

The settings above are restored to their previous values when speaker tracking is turned off. This is regardless of whether you have used the user interface or the [Cameras > SpeakerTrack > Mode](#) setting to turn off speaker tracking.

Board

Board Pro

Codec EQ

Codec Plus

Codec Pro

Desk, Desk Pro, Desk Mini

Room Bar

Room Kit

Room Kit Mini

Room 55

Room 55 Dual, Room 70

Room 70 G2

Room 70 Panorama

Room Panorama

Set up the PresenterTrack feature (page 1 of 4)

The PresenterTrack feature enables the camera to follow a presenter that is moving about on stage. The tracking stops when the presenter leaves the stage.

The following cameras and video conferencing devices support PresenterTrack:

- Board Pro and Codec EQ with PTZ 4K or Precision 60 camera *
- Codec Plus and Codec Pro with PTZ 4K, Precision 60, or SpeakerTrack 60 camera
- Room 55 Dual, Room 70, and Room 70 G2 with PTZ 4K or Precision 60 as external camera

Capabilities and limitations

- Once set up, the user can activate and deactivate PresenterTrack from the camera panel on the touch controller.
- The camera uses digital pan, tilt, and zoom, so it doesn't move physically while tracking the presenter.
- PresenterTrack supports the tracking of one or more persons on stage. If they stand too far apart to fit within a zoomed view, the camera zooms out to show the full stage.
- You can use PresenterTrack as a standalone feature, or as part of the Briefing Room and Classroom scenarios.
- You can set up the device to use one of the cameras in a SpeakerTrack 60 camera assembly for PresenterTrack.
- You cannot use PresenterTrack and SpeakerTrack simultaneously.
 - When you activate PresenterTrack, SpeakerTrack is disabled automatically.
 - When you activate SpeakerTrack, PresenterTrack is disabled automatically.

There is one exception to this: In the Briefing Room and Classroom scenarios both features are active simultaneously in the Q&A mode (when someone in the local audience asks a question, while the device is in *Local Presenter* mode).

Considerations before placing the camera

When you set up PresenterTrack, you must define a stage area and a trigger zone. Consider the location and use of these areas when placing the camera that is tracking the presenter on stage.

We recommend you to be in the same room as the video conferencing device and camera while setting up PresenterTrack.

Stage area

The stage area is the zoomed-out overview image.

- Make it large enough so that the presenter can move about on stage. The tracking stops when the presenter leaves the stage area.
- Allow the audience or meeting participants to move naturally in the room without triggering the tracking.

Trigger zone

Presenter tracking doesn't start before the camera detects a face in the trigger zone.

- Choose a location where the presenter naturally enters the stage, for example by a presenter table or podium.
- Make it large enough for the camera to detect the face of the presenter.
- To avoid a false face detection, make sure that the background of the trigger zone is neutral. Avoid having the trigger zone in front of a screen.

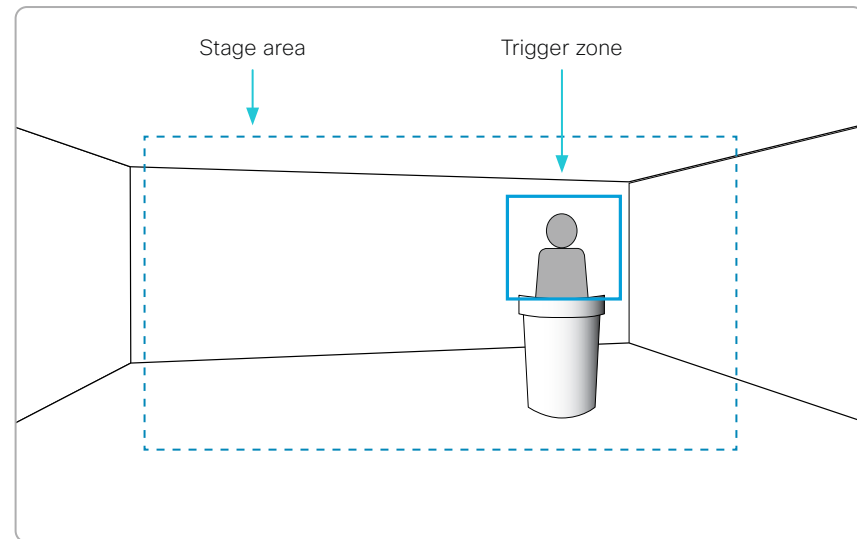

* There are no PresenterTrack configuration pages on the device's web interface in this software release. You must set up PresenterTrack using the device settings or API commands.

Board

Board Pro

Codec EQ

Codec Plus

Codec Pro

Desk, Desk Pro, Desk Mini

Room Bar

Room Kit

Room Kit Mini

Room 55

Room 55 Dual, Room 70

Room 70 G2

Room 70 Panorama

Room Panorama

Set up the PresenterTrack feature (page 2 of 4)

Set up and test PresenterTrack

We recommend you to be in the same room as the video conferencing device and camera while setting up PresenterTrack.

1. Sign in to the device web interface and go to [Settings](#). Select [Audio and Video](#), and open the [PresenterTrack](#) sub-tab.
2. Toggle on [Enable PresenterTrack](#) and click [Configure](#) to open the configuration page.

Opening this page deactivates standby and presenter tracking, enables the self-view in full screen, and shows the trigger zone rectangle on the screen of the device.



Don't leave this web page without clicking [Done](#), otherwise the trigger zone rectangle stays visible on the screen of the device.

Alternatively, you can remove the rectangle by opening the control panel on the device's user interface, tap [Camera](#), and select a new camera mode or preset.

3. On the device's user interface, open the control panel and select [Camera](#) followed by [Manual](#). Choose the correct camera from the drop down list (if your device has more than one camera) and use the camera controls (zoom, pan, tilt) on the touch controller to define the stage area.

You see a notification if the camera does not support the PresenterTrack feature.

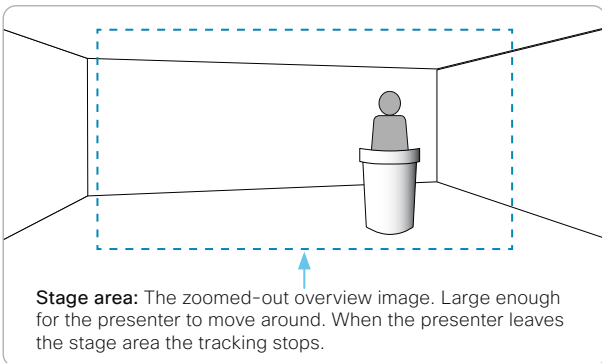

4. A blue dashed rectangle, which represents the trigger zone, is shown on the device web interface. Move and resize the rectangle while watching the screen of the device. You see the same rectangle overlaying the camera self-view. Place the rectangle where you want the trigger zone to be.

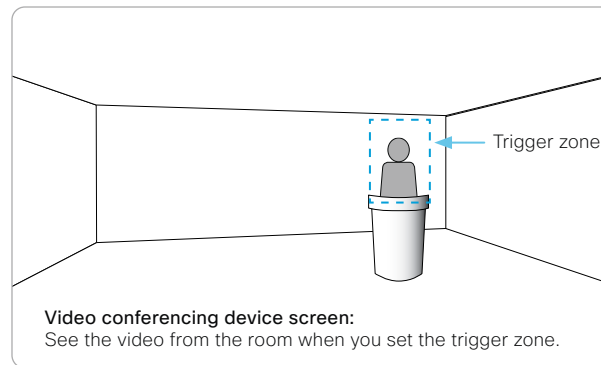
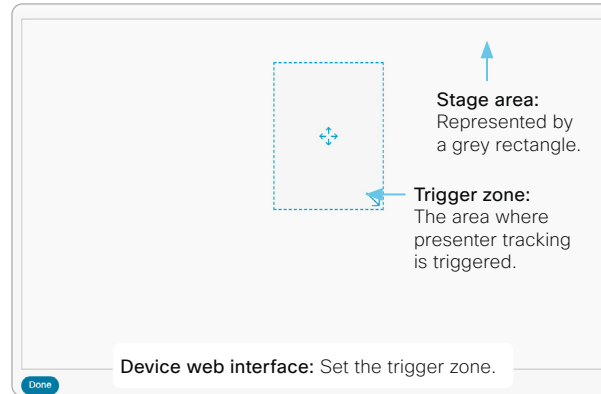

If you want to set up a more advanced polygonal trigger zone, see the sidebar.

5. Click [Done](#).

Set up a polygonal trigger zone

You can set up only rectangular trigger zones from the [PresenterTrack](#) web page.

If you want to define a more advanced polygonal trigger zone, you must go to [Settings](#), select [Configurations](#), and find the [Cameras > PresenterTrack > TriggerZone](#) setting.

The value of this setting is a string that contains the coordinate pairs of all the vertices of the polygon.

Example:

Define the following trigger zone, which has 12 vertices. Such a trigger zone may be convenient if there is a screen, which you want to avoid, behind the presenter.

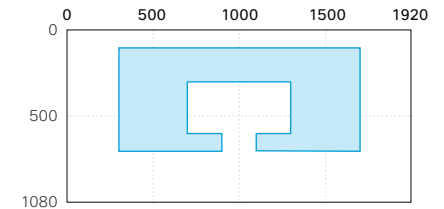

The coordinates of the vertices are:

(300,100)	(1100,600)	(700,600)
(1700,100)	(1300,600)	(900,600)
(1700,700)	(1300,300)	(900,700)
(1100,700)	(700,300)	(300,700)

The corresponding setting value is:

[Cameras > PresenterTrack > TriggerZone](#):
300,100,1700,100,1700,700,1100,700,
1100,600,1300,600,1300,300,700,300,
700,600,900,600,900,700,300,700

Board

Board Pro

Codec EQ

Codec Plus

Codec Pro

Desk, Desk Pro, Desk Mini

Room Bar

Room Kit

Room Kit Mini

Room 55

Room 55 Dual, Room 70

Room 70 G2

Room 70 Panorama

Room Panorama

Set up the PresenterTrack feature (page 3 of 4)

- On the device's user interface, open the control panel and select *Camera* followed by *Presenter*.
This activates presenter tracking.
- Position yourself in the trigger zone and see that the camera zooms in on you.

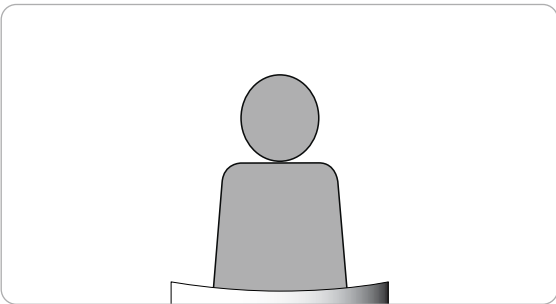
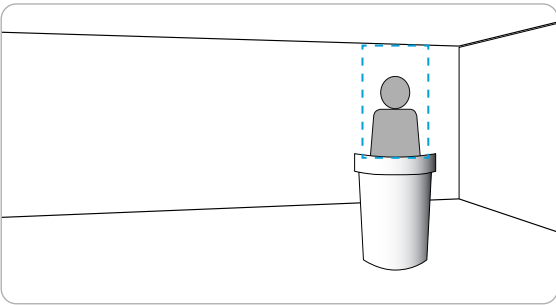

- Walk about on the stage and check that the camera follows you.

- Check that presenter tracking stops when you leave the stage.

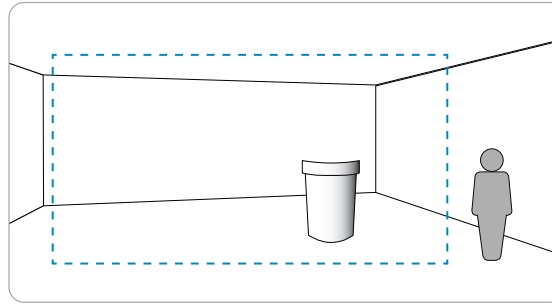

If something fails, go back to step 3, 4 and 5 to adjust the size and location of the stage area and the trigger zone.

For more troubleshooting help, you can switch on PresenterTrack *Diagnostics Mode*, as described on the next page.

Temporarily activate or deactivate PresenterTrack

During a meeting, you can use the touch controller to temporarily activate or deactivate presenter tracking.

- On the device's user interface, open the control panel and select *Camera*.
- Select *Presenter* in the list of camera modes and presets to activate presenter tracking.

Select something other than *Presenter* in the list of camera modes and presets to deactivate presenter tracking.

If presenter tracking has been deactivated, the presenter must enter the trigger zone again in order for tracking to start.

Set up the PresenterTrack feature (page 4 of 4)

Diagnostics mode

The PresenterTrack diagnostics mode may be a helpful tool when troubleshooting an issue. In order to set the device in diagnostics mode, you have to use the xAPI of the device.

Sign in to the xAPI and run the following command:

- `xCommand Cameras PresenterTrack Set Mode: Diagnostic`

In this mode, you see the stage area (the zoomed-out overview image) on the screen, and an overlay with the following indicators::

- RED frame: The trigger zone.
- YELLOW frame: The zoomed-in view of the presenter.
- GREEN frame: A face that is detected and tracked.
- GREEN or RED blinking filled frame: Face detections. Green color indicates a high confidence, red color indicates a low confidence.
- BLUE: A face is detected but the face is not tracked.

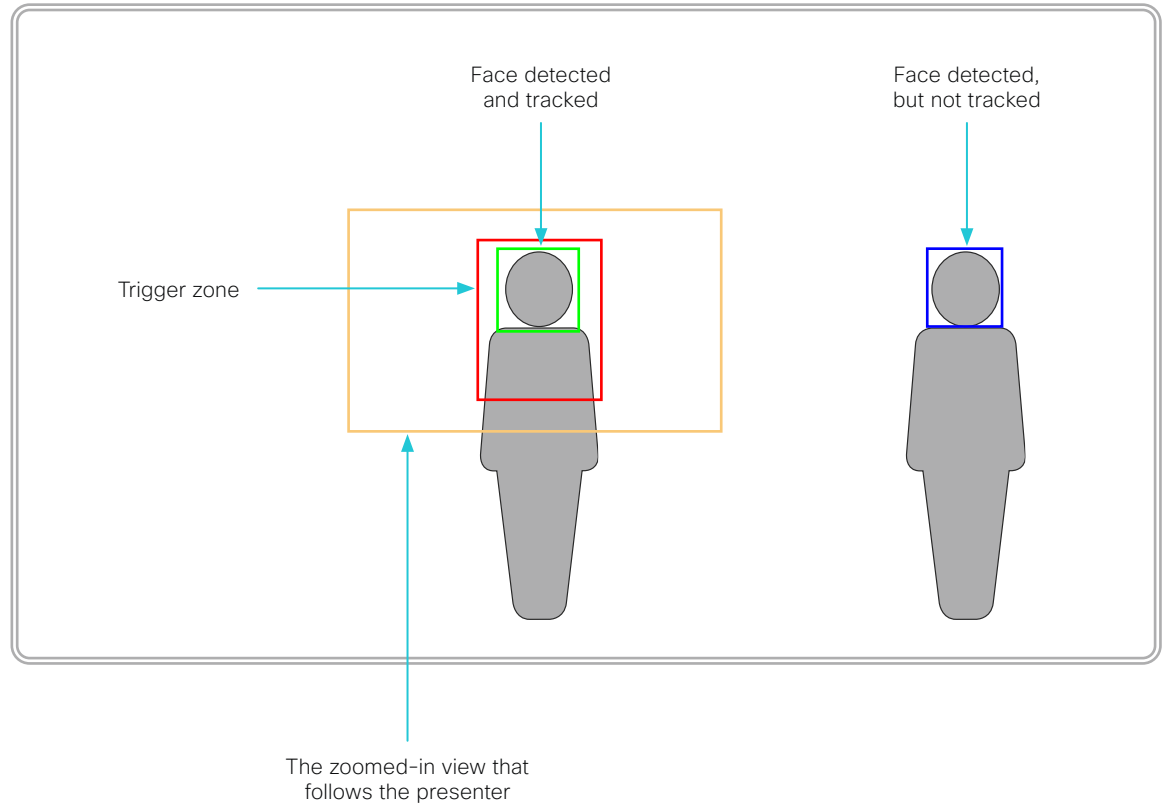

- Board
- Board Pro
- Codec EQ
- Codec Plus
- Codec Pro
- Desk, Desk Pro, DeskMini
- Room Bar
- Room Kit
- Room Kit Mini
- Room 55
- Room 55 Dual, Room 70
- Room 70 G2
- Room 70 Panorama
- Room Panorama

Board

Board
ProCodec
EQCodec
PlusCodec
ProDesk,
Desk Pro,
DeskMiniRoom
Bar

Room Kit

Room Kit
Mini

Room 55

Room
55 Dual,
Room 70Room 70
G2Room 70
PanoramaRoom
Panorama

Briefing room setup (page 1 of 7)

The *Briefing room* setup makes it easy to set up, manage, and use a room to deliver training and education sessions to groups of people.

The *Briefing room* setup has the following predefined room modes that accommodate different scenarios::

- *Local Presenter* (the presenter is in the room)
- *Remote Presenter* (the presenter is calling in)
- *Discussions* (for discussions between different sites, and with a local presenter in the room)

The *Briefing room* setup is available as a room type template. When you set up a room using a template, a set of configurations is pushed automatically to the device. It is important that the room is set up correctly, and that the cameras and screens are connected exactly as specified. Otherwise the configurations will not match the room.

Required equipment

- One of the following devices:
 - Codec Pro
 - Room 70 G2
- Three displays (Presentation display, Remote presenter display, and Remote audience display)
- Two cameras (Audience camera and Presenter camera)
- Microphones
- Speakers
- Touch controller



Briefing room setup *

Classroom versus Briefing Room setup

The *Classroom* setup is more flexible than the *Briefing room* setup in the number of screens and how the layout is distributed on the screens. Also, more products support *Classroom*.

Classroom

- Supported products: Codec EQ, Codec Plus, Codec Pro, Room 55 Dual, Room 70, and Room 70 G2
- You can use any number of screens that the device supports, typically two or three. Use the video monitor settings to configure the distribution of layouts on the screens, if the default behavior does not fulfill your requirements.

Briefing room

- Supported products: Codec Pro and Room 70 G2
- The setup requires three screens, and the layouts on the screens are preconfigured (and fixed) to match that particular scenario.

* The illustration shows a codec with Speaker Track 60 camera as audience camera. The same principle applies also to the supported integrated devices, and other supported codec and camera combinations.

Board

Board Pro

Codec EQ

Codec Plus

Codec Pro

Desk, Desk Pro, DeskMini

Room Bar

Room Kit

Room Kit Mini

Room 55

Room 55 Dual, Room 70

Room 70 G2

Room 70 Panorama

Room Panorama

Briefing room setup (page 2 of 7)

Room modes*

Local Presenter mode



The presenter is in the room. This mode also covers the case when someone in the local audience asks a question (Q&A).

If automatic switching is enabled (default), the device switches to this mode when the *Presenter camera* detects a presenter in the room.

Remote Presenter mode



The presenter is calling in.

If automatic switching is enabled (default), the device switches to this mode when the *Presenter camera* doesn't detect a presenter in the room.

Discussion mode



For discussions between different sites. A local presenter is in the room.

Always use the touch controller to activate this mode.

	Local Presenter mode	Remote Presenter mode	Discussion mode
Video sent to the far end	Sends video from the <i>Presenter camera</i> Q&A: Sends split-screen video from the <i>Presenter camera</i> and the person asking the question (<i>Audience camera</i>)	Sends video from the <i>Audience camera</i>	Sends video from the <i>Audience camera</i>
Remote presenter display	Shows the presentation	Shows the presenter that is calling in, and other remote sites (you can decide the layout locally)	Shows the remote sites that are part of the discussion (you can decide the layout locally)
Presentation display	Shows the presentation	Shows the presentation	Shows the presentation
Remote audience display	Shows the remote participants that are calling in from different sites	Shows the presentation	Shows the presentation

If there is no presentation, nothing will be shown on the corresponding screens (gray).

* The illustrations show a codec with Speaker Track 60 camera as audience camera. The same principle applies also to the supported integrated devices, and other supported codec and camera combinations.

Board

Board Pro

Codec EQ

Codec Plus

Codec Pro

Desk, Desk Pro, Desk Mini

Room Bar

Room Kit

Room Kit Mini

Room 55

Room 55 Dual, Room 70

Room 70 G2

Room 70 Panorama

Room Panorama

Briefing room setup (page 3 of 7)

Room arrangement examples

These illustrations show examples of how to arrange screens, cameras and microphones, and where to place people for the best experience.

Recommendation

- **Remote presenter display:** 1st screen, placed at front. For integrated devices, this is its (left) screen.
- **Presentation display:** 2nd screen, placed at front. For integrated devices with two screens, this is its right screen.
- **Remote audience display:** 3rd screen, placed on the side or at the back, so that the local presenter can see the remote audience.
- **Audience camera:** Use the integrated camera for video conferencing devices that have that. For other devices, we recommend the Quad Camera or SpeakerTrack 60 camera. We recommend a camera with speaker tracking, but it is also possible to use a camera without speaker tracking capabilities.
- **Presenter camera:** PTZ 4K or Precision 60 camera with presenter tracking enabled.
- **Microphones:** We recommend the Cisco Ceiling Microphone for good coverage of the room. Also other microphone solutions can be used.
- **Speakers:** Use the integrated speakers for video conferencing devices that have that. For other devices, we recommend good quality stereo speakers placed next to the *Presentation display* at the front of the room.

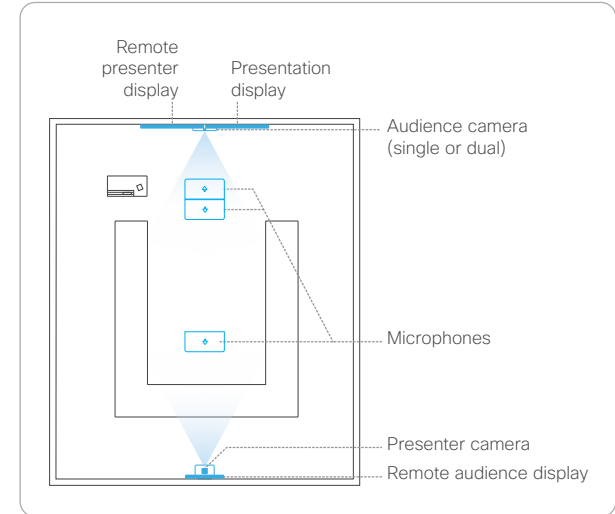
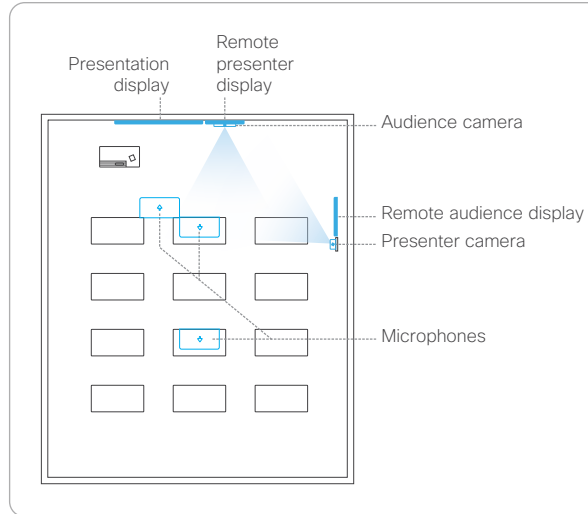

Board

Board Pro

Codec EQ

Codec Plus

Codec Pro

Desk, Desk Pro, Desk Mini

Room Bar

Room Kit

Room Kit Mini

Room 55

Room 55 Dual, Room 70

Room 70 G2

Room 70 Panorama

Room Panorama

Briefing room setup (page 4 of 7)

Codec Pro: Connect cables



Connect the cameras to the device as shown in the illustrations. Following the illustration ensures that the configurations that are automatically pushed to the device when selecting the *Briefing* room type template, match your actual setup.

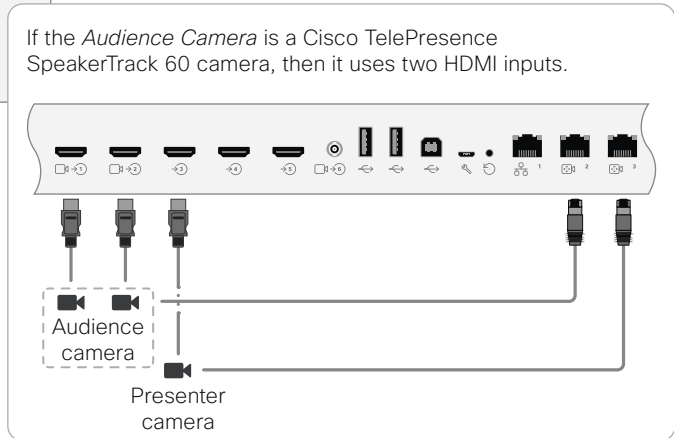
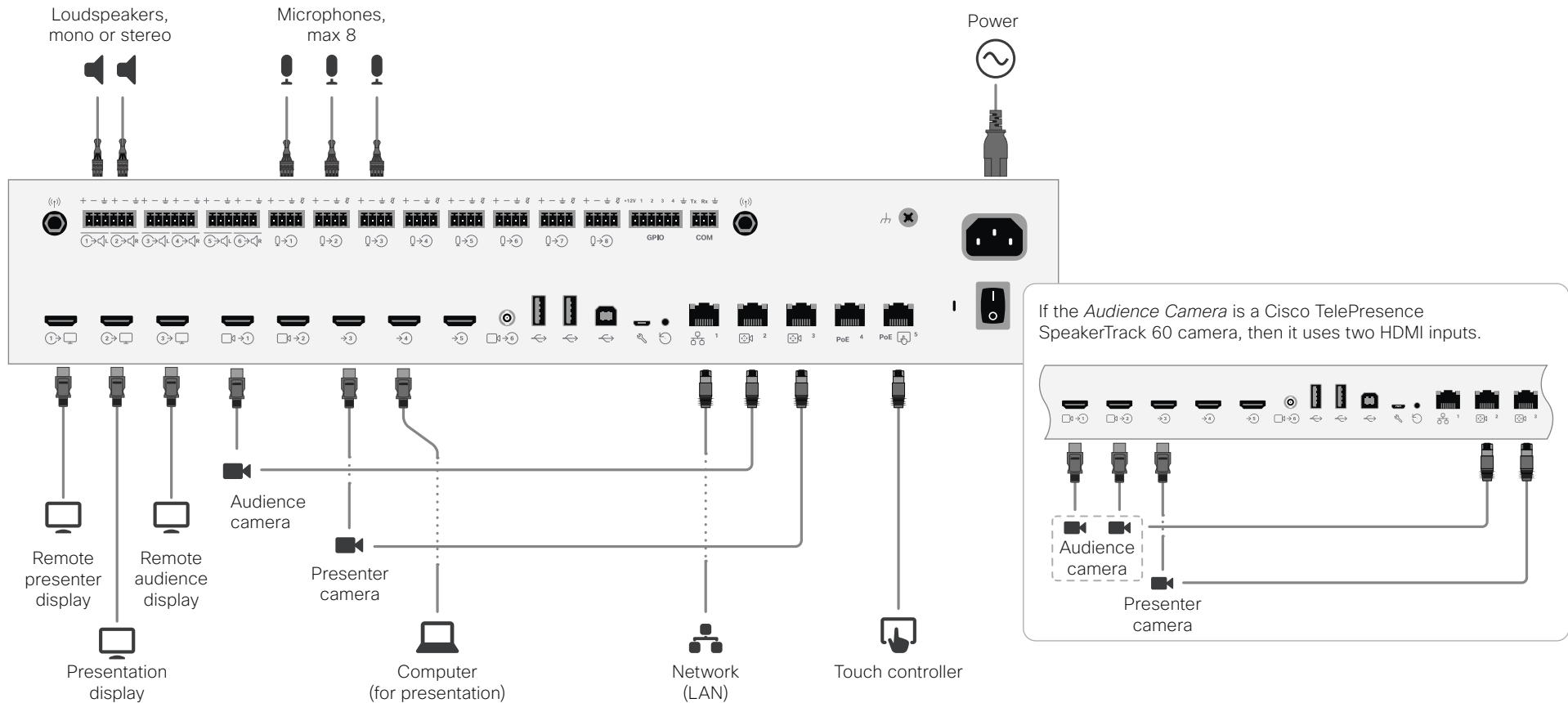

Board

Board Pro

Codec EQ

Codec Plus

Codec Pro

Desk, Desk Pro, DeskMini

Room Bar

Room Kit

Room Kit Mini

Room 55

Room 55 Dual, Room 70

Room 70 G2

Room 70 Panorama

Room Panorama

Briefing room setup (page 5 of 7)

Room 70 G2: Connect cables

 Connect the cameras to the device as shown in the illustration. Following the illustration ensures that the configurations that are automatically pushed to the device when selecting the *Briefing* room type template, match your actual setup.

Keep all preconnected cables, including the cables for the integrated camera and screens, as delivered from the factory. **You only have to connect the external screens and cameras.**

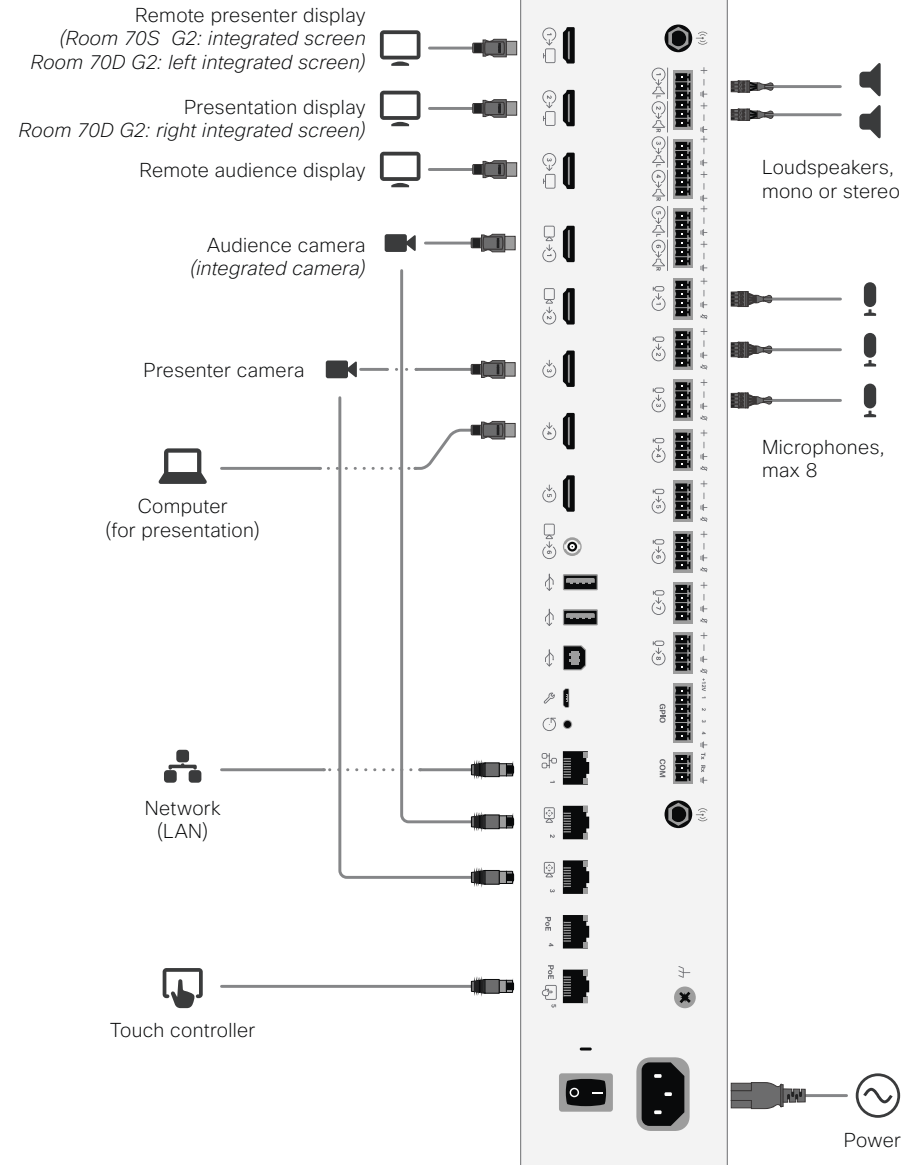

Board

Board
ProCodec
EQCodec
PlusCodec
ProDesk,
Desk Pro,
Desk MiniRoom
Bar

Room Kit

Room Kit
Mini

Room 55

Room
55 Dual,
Room 70Room 70
G2Room 70
PanoramaRoom
Panorama

Briefing room setup (page 6 of 7)

Configure the device

We recommend you to be in the same room when setting up the Briefing room. Otherwise you are not able to set up PresenterTrack properly.

1. Connect cameras and screens as described on the previous page.
2. Use the touch controller to stop sharing the video from the *Presenter camera*. It is important that video from the *Presenter camera* is not displayed on any screen while setting up Briefing room.
3. Sign in to the device web interface, go to [Settings](#), and select [Configurations](#).
4. Go to [Video > Input > Connector 3](#), and set the following:
 - **InputSourceType:** camera
 - **PresentationSelection:** Manual
 - **Quality:** Motion
 - **Visibility:** Never
 - **CameraControl Mode:** On
 Click [Save](#) for the changes to take effect.
5. Set up PresenterTrack for the *Presenter camera*, see the [► Set up the PresenterTrack feature](#) chapter. This feature enables the camera to follow a presenter that is moving about on stage.
6. Go to [Settings](#), and select [Configurations](#). Find [Cameras > PresenterTrack > PresenterDetectedStatus](#) and choose whether to enable (default) or disable automatic switching between *Local Presenter* and *Remote Presenter* modes. Click [Save](#) for the changes to take effect.
7. Go to [Settings](#), and select [Room Types](#). Click the [Briefing](#) thumbnail to push the corresponding configuration to the device.

Switching between room modes

Switching between room modes (*Local Presenter*, *Remote Presenter*, *Discussions*), which implies that camera input sources, and remote and local screen layouts, are changed, can be done in two ways:

- Automatically, based on who is speaking and whether a local presenter is present on stage.

Automatic switching is only between the *Local Presenter* and *Remote Presenter* modes. The room mode doesn't change automatically if the current mode is *Discussion*.

Automatic switching is supported only when the PresenterTrack feature enabled ([Cameras > PresenterTrack > Enabled](#) set to **True**).

- Manually, using the buttons on the touch controller.

Automatic switching implies:

- The device switches to the *Local Presenter* mode when a person is detected in the PresenterTrack trigger zone.
- The device switches to the *Remote Presenter* mode when the local presenter, who is tracked, leaves the stage.
- If someone in the local audience asks a question when the device is in *Local Presenter* mode, the device sends split-screen video showing both the presenter and the person asking the question. This requires a SpeakerTrack 60 or Quad Camera as *Audience camera*, and that speaker tracking is switched on.

Switch between room modes manually

While in a conference, you can switch to another mode using the touch controller.

1. Tap [Briefing Room](#) on the touch controller.
2. Tap the mode you want to change to: *Local Presenter*, *Remote Presenter*, or *Discussion*. The current mode is highlighted.



Board

Board
Pro

Codec
EQ

Codec
Plus

Codec
Pro

Desk,
Desk Pro,
Desk Mini

Room
Bar

Room Kit

Room Kit
Mini

Room 55

Room
55 Dual,
Room 70

Room 70
G2

Room 70
Panorama

Room
Panorama

Briefing room setup (page 7 of 7)

Limitations

Not supported functionality when using *Briefing Room*:

- MultiSite (embedded multipoint switch)
- Content sharing to Proximity clients
- Directional audio
- Active control (selection of layouts from CMS)

Board

Board
ProCodec
EQCodec
PlusCodec
ProDesk,
Desk Pro,
Desk MiniRoom
Bar

Room Kit

Room Kit
Mini

Room 55

Room 55
Dual,
Room 70Room 70
G2Room 70
PanoramaRoom
Panorama

Classroom setup (page 1 of 9)

The *Classroom* setup makes it easy to set up, manage, and use a room to deliver training and education sessions to groups of people.

The *Classroom* setup is available as a room type template. When you set up a room using a template, a set of configurations is pushed automatically to the device. It is important that the room is set up correctly, and that the cameras are connected exactly as specified. Otherwise the configurations will not match the room.

Required equipment

- One of the following devices:
 - Codec EQ
 - Codec Plus
 - Codec Pro
 - Room 55 Dual
 - Room 70
 - Room 70 G2
- One or more screens (configurable)
- Two cameras (Audience camera and Presenter camera)
- Microphones
- Speakers
- Touch controller

Limitations

Not supported functionality when using Classroom:

- MultiSite (embedded multipoint switch)
- Content sharing to Proximity clients
- Directional audio
- Active control (selection of layouts from CMS)

Room modes

The *Classroom* setup has the following predefined room modes that accommodate different scenarios: Local Presenter, Remote Presenter, and Discussion.

Local Presenter mode

- The presenter is in the room. This mode also covers the case when someone in the local audience asks a question (Q&A).
- If automatic switching is enabled (default), the device switches to this mode when the *Presenter camera* detects a presenter in the room.
- Sends video from the *Presenter camera* to the far end. In the Q&A case: Sends split-screen video from the *Presenter camera* and the person asking the question (*Audience camera*) to the far end.

Remote Presenter mode

- The presenter is calling in.
- If automatic switching is enabled (default), the device switches to this mode when the *Presenter camera* doesn't detect a presenter in the room.
- Sends video from the *Audience camera* to the far end.

Discussion mode

- For discussions between different sites. A local presenter is in the room.
- Always use the touch controller to activate this mode.
- Sends video from the *Audience camera* to the far end.

Classroom versus Briefing Room setup

The *Classroom* setup is more flexible than the *Briefing room* setup in the number of screens and how the layout is distributed on the screens. Also, more products support *Classroom*.

Classroom

- Supported products: Codec EQ, Codec Plus, Codec Pro, Room 55 Dual, Room 70, and Room 70 G2
- You can use any number of screens that the device supports, typically two or three. Use the video monitor settings to configure the distribution of layouts on the screens, if the default behavior does not fulfill your requirements.

Briefing room

- Supported products: Codec Pro and Room 70 G2
- The setup requires three screens, and the layouts on the screens are preconfigured (and fixed) to match that particular scenario.

Board

Board Pro

Codec EQ

Codec Plus

Codec Pro

Desk, Desk Pro, Desk Mini

Room Bar

Room Kit

Room Kit Mini

Room 55

Room 55 Dual, Room 70

Room 70 G2

Room 70 Panorama

Room Panorama

Classroom setup (page 2 of 9)

Room arrangement examples

These illustrations show examples of how to arrange screens, cameras and microphones, and where to place people for the best experience.

Recommendation

Audience camera:

- Use the integrated camera for video conferencing devices that have that. For other devices, we recommend the Quad Camera or SpeakerTrack 60 camera. We recommend a camera with speaker tracking, but it is also possible to use a camera without speaker tracking capabilities.

Presenter camera:

- PTZ 4K or Precision 60 camera with presenter tracking enabled.

Microphones:

- We recommend the Cisco Ceiling Microphone for good coverage of the room. Also other microphone solutions can be used.

Speakers:

- Use the integrated speakers for video conferencing devices that have that. For other devices, we recommend good quality stereo speakers placed next to the main screen at the front of the room.

Screens:

- You can use one or more screens (the maximum number of screens depends on your type of device).
- For most setups, we recommend that you use two screens or more. Place the main screen at the front of the room. Place a second screen on the side or at the back, so that the local presenter can see the remote audience.

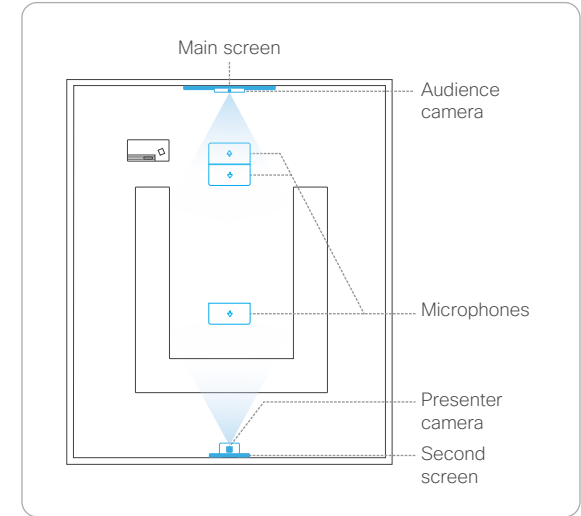
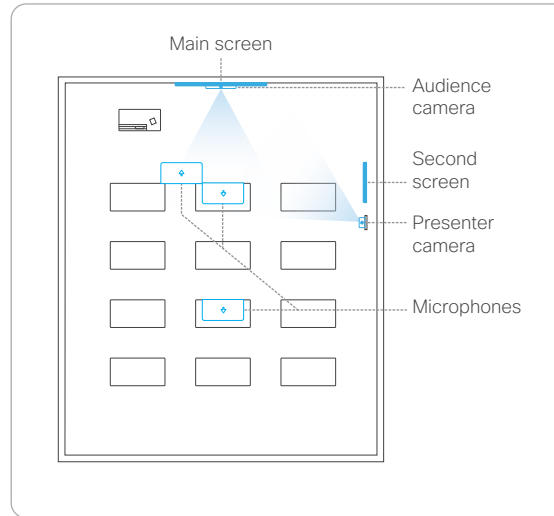

Board

Board Pro

Codec EQ

Codec Plus

Codec Pro

Desk, Desk Pro, Desk Mini

Room Bar

Room Kit

Room Kit Mini

Room 55

Room 55 Dual, Room 70

Room 70 G2

Room 70 Panorama

Room Panorama

Classroom setup (page 3 of 9)

Codec EQ: Connect cables



Connect the cameras to the device as shown in the illustration. Following the illustration ensures that the configurations that are automatically pushed to the device when selecting the *Classroom* room type template, match your actual setup.

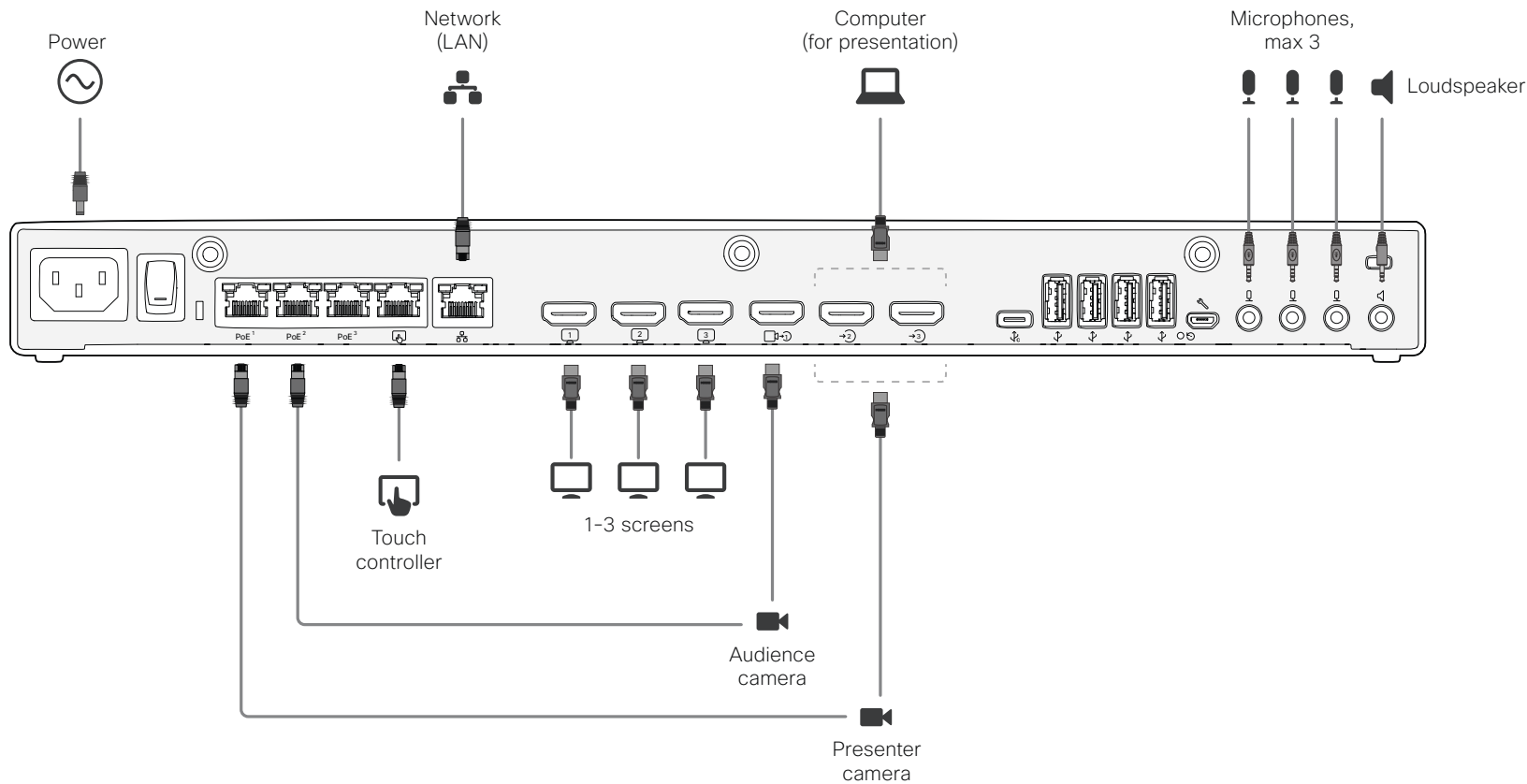

- Board
- Board Pro
- Codec EQ
- Codec Plus
- Codec Pro
- Desk, Desk Pro, DeskMini
- Room Bar
- Room Kit
- Room Kit Mini
- Room 55
- Room 55 Dual, Room 70
- Room 70 G2
- Room 70 Panorama
- Room Panorama

Classroom setup (page 4 of 9)

Codec Plus: Connect cables

! Connect the cameras to the device as shown in the illustration. Following the illustration ensures that the configurations that are automatically pushed to the device when selecting the *Classroom* room type template, match your actual setup.

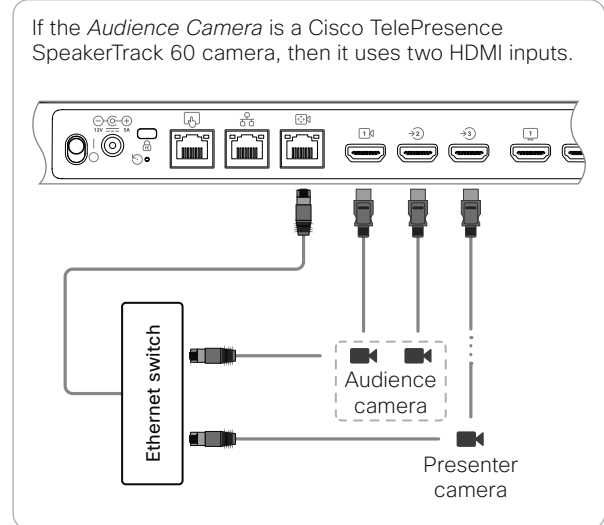
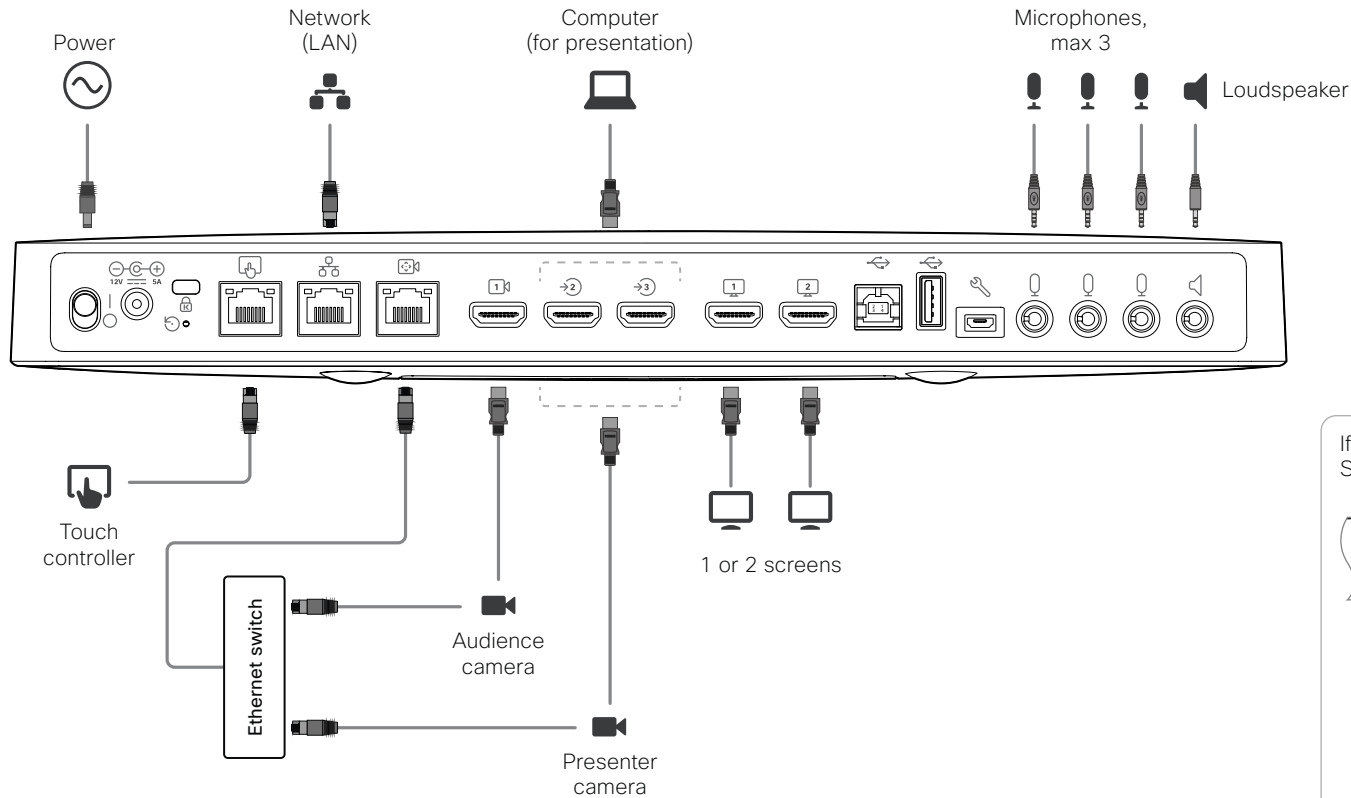

Board

Board Pro

Codec EQ

Codec Plus

Codec Pro

Desk, Desk Pro, Desk Mini

Room Bar

Room Kit

Room Kit Mini

Room 55

Room 55 Dual, Room 70

Room 70 G2

Room 70 Panorama

Room Panorama

Classroom setup (page 5 of 9)

Codec Pro: Connect cables

 Connect the cameras to the device as shown in the illustration. Following the illustration ensures that the configurations that are automatically pushed to the device when selecting the *Classroom* room type template, match your actual setup.

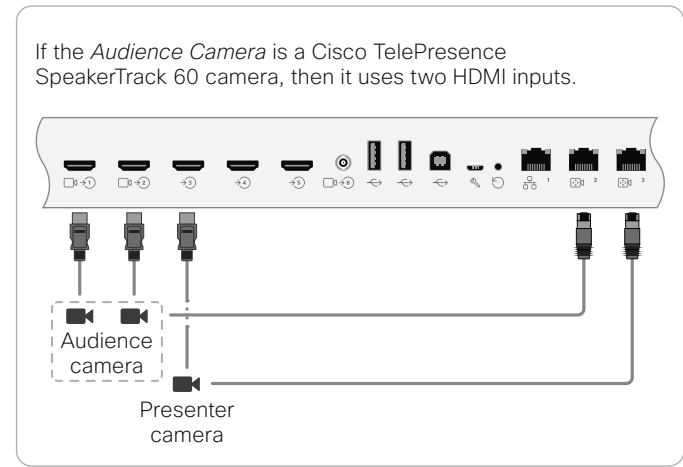
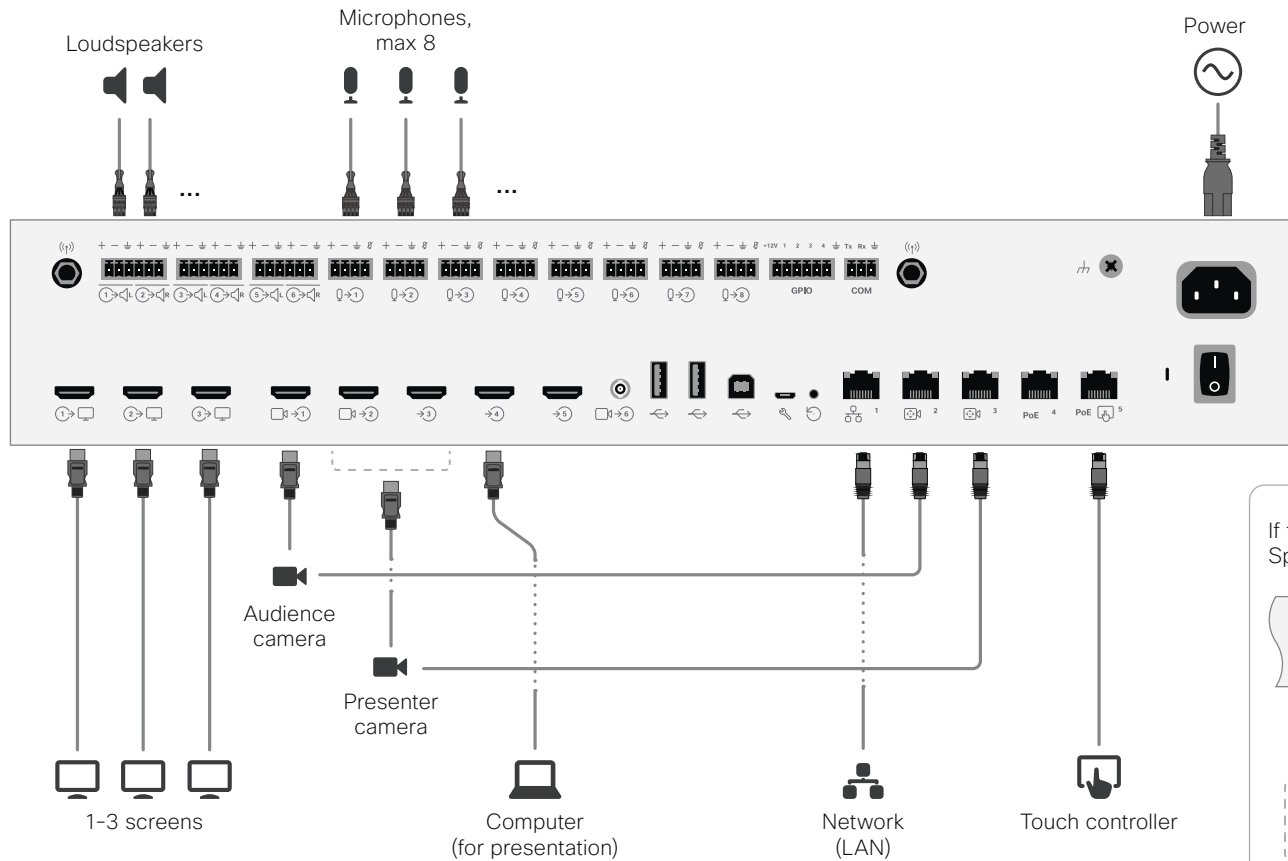

Board

Board Pro

Codec EQ

Codec Plus

Codec Pro

Desk, Desk Pro, Desk Mini

Room Bar

Room Kit

Room Kit Mini

Room 55

Room 55 Dual, Room 70

Room 70 G2

Room 70 Panorama

Room Panorama

Classroom setup (page 6 of 9)

Room 55 Dual and Room 70: Connect cables

 Connect the cameras to the device as shown in the illustration. Following the illustration ensures that the configurations that are automatically pushed to the device when selecting the *Classroom* room type template, match your actual setup.

Keep all preconnected cables, including the cables for the integrated camera and screens, as delivered from the factory. **You only have to connect the external screens and cameras.**

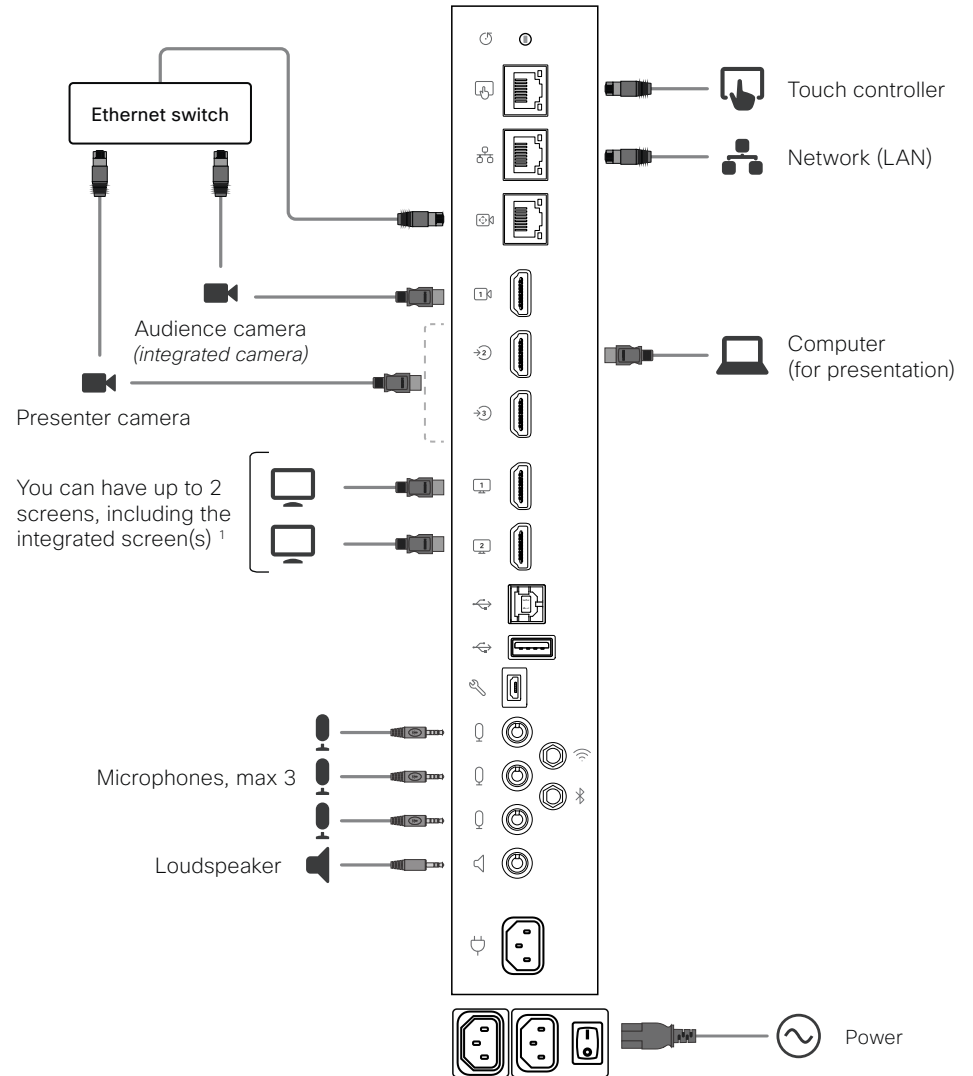

¹ Room 55 Dual and Room 70 Dual: HDMI outputs 1 and 2 are for the integrated screens of the device. External screens are not supported. Room 70 Single: HDMI output 1 is for the integrated screen of the device. An external screen may be connected to HDMI output 2.

Board

Board Pro

Codec EQ

Codec Plus

Codec Pro

Desk, Desk Pro, DeskMini

Room Bar

Room Kit

Room Kit Mini

Room 55

Room 55 Dual, Room 70

Room 70 G2

Room 70 Panorama

Room Panorama

Classroom setup (page 7 of 9)

Room 70 G2: Connect cables

 Connect the cameras to the device as shown in the illustration. Following the illustration ensures that the configurations that are automatically pushed to the device when selecting the *Classroom* room type template, match your actual setup.

Keep all preconnected cables, including the cables for the integrated camera and screens, as delivered from the factory. **You only have to connect the external screens and cameras.**

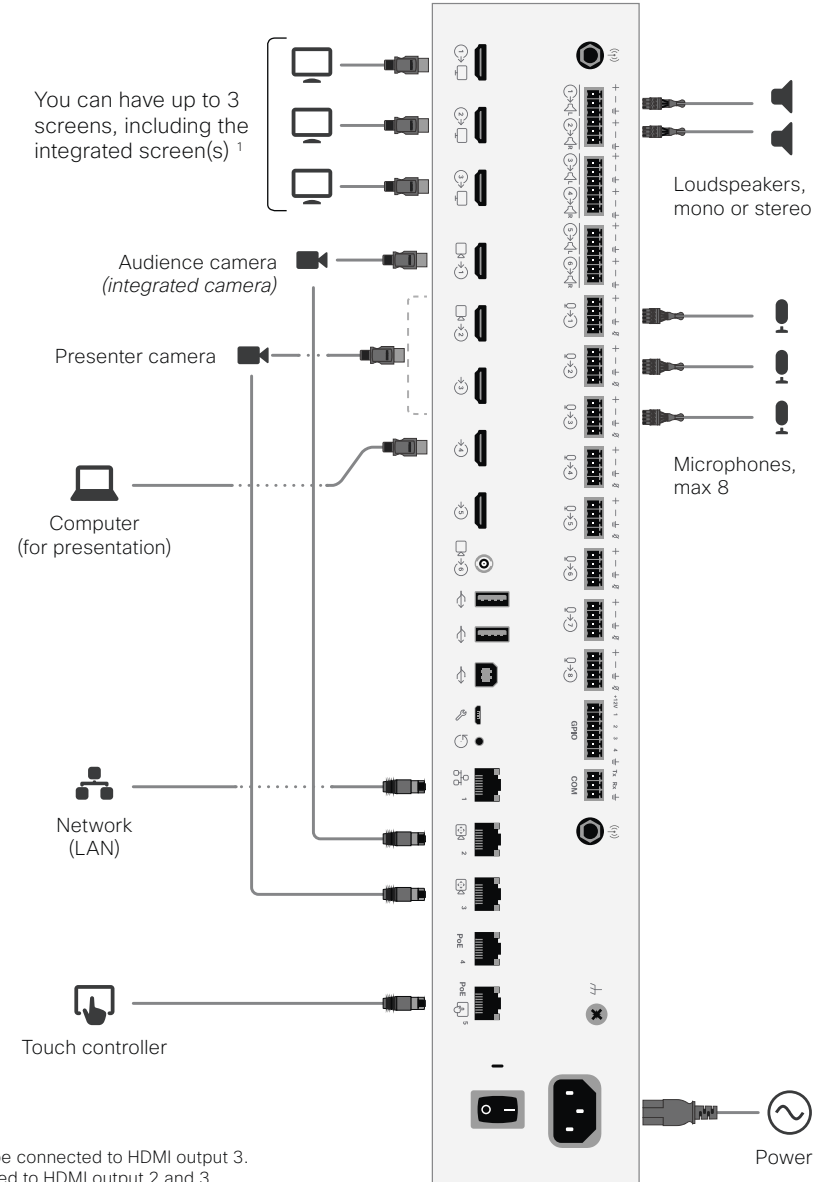

¹ Room 70 Dual G2: HDMI outputs 1 and 2 are for the integrated screens of the device. An external screen may be connected to HDMI output 3. Room 70 Single G2: HDMI output 1 is for the integrated screen of the device. External screens may be connected to HDMI output 2 and 3.

Board

Board
ProCodec
EQCodec
PlusCodec
ProDesk,
Desk Pro,
DeskMiniRoom
Bar

Room Kit

Room Kit
Mini

Room 55

Room 55
Dual,
Room 70Room 70
G2Room 70
PanoramaRoom
Panorama

Classroom setup (page 8 of 9)

Configure the device

We recommend you to be in the same room when setting up the Classroom. Otherwise you are not able to set up PresenterTrack properly.

1. Connect cameras and screens as described on the previous pages.
2. Use the touch controller to stop sharing the video from the *Presenter camera*. It is important that video from the *Presenter camera* is not displayed on any screen while setting up Classroom.
3. Sign in to the device web interface, go to [Settings](#), and select [Configurations](#).
4. Go to [Video > Input > Connector n](#), and set the following (*n* is the number of the Connector where the *Presenter Camera* is connected):
 - [InputSourceType](#): **camera**
 - [PresentationSelection](#): **Manual**
 - [Quality](#): **Motion**
 - [Visibility](#): **Never**
 - [CameraControl Mode](#): **On**Click [Save](#) for the changes to take effect.
5. Set up PresenterTrack for the *Presenter camera*, see the [► Set up the PresenterTrack feature](#) chapter.

This feature enables the camera to follow a presenter that is moving about on stage.
6. Go to [Settings](#), and select [Configurations](#). Find [Cameras > PresenterTrack > PresenterDetectedStatus](#) and choose whether to enable (default) or disable automatic switching between *Local Presenter* and *Remote Presenter* modes.

Click [Save](#) for the changes to take effect.

Read more about switching between modes on the next page.
7. If the default screen and layout behavior does not suit your setup, you must configure the screens and layouts using the following settings:
 - [Video > Monitors](#): Defines the number of different layouts in your room setup.
 - [Video > Output > Connector n > MonitorRole](#): Defines which layout each screen gets. Screens with different monitor roles get different layouts.Refer to the [► Setting up screens and other output devices](#) chapter for more details.
8. Go to [Settings](#), and select [Room Types](#). Click the [Classroom](#) thumbnail to push the corresponding configuration to the device.

Board

Board
ProCodec
EQCodec
PlusCodec
ProDesk,
Desk Pro,
DeskMiniRoom
Bar

Room Kit

Room Kit
Mini

Room 55

Room 55
Dual,
Room 70Room 70
G2Room 70
PanoramaRoom
Panorama

Classroom setup (page 9 of 9)

Switching between room modes

Switching between room modes (*Local Presenter*, *Remote Presenter*, *Discussions*), which implies that camera input sources, and remote and local screen layouts, are changed, can be done in two ways:

- Automatically, based on who is speaking and whether a local presenter is present on stage.

Automatic switching is only between the *Local Presenter* and *Remote Presenter* modes. The room mode doesn't change automatically if the current mode is *Discussion*.

Automatic switching is supported only when the PresenterTrack feature enabled ([Cameras > PresenterTrack > Enabled](#) set to **True**).

- Manually, using the buttons on the touch controller.

Automatic switching implies:

- The device switches to the *Local Presenter* mode when a person is detected in the PresenterTrack trigger zone.
- The device switches to the *Remote Presenter* mode when the local presenter, who is tracked, leaves the stage.
- If someone in the local audience asks a question when the device is in *Local Presenter* mode, the device sends split-screen video showing both the presenter and the person asking the question. This behavior requires a SpeakerTrack 60 or Quad Camera as *Audience camera*, and that speaker tracking is switched on.

Switch between room modes manually

While in a conference, you can switch to another mode using the touch controller.

- Tap *Classroom* on the touch controller.
- Tap the mode you want to change to: *Local Presenter*, *Remote Presenter*, or *Discussion*. The current mode is highlighted.



Board

Board
ProCodec
EQCodec
PlusCodec
ProDesk,
Desk Pro,
DeskMiniRoom
Bar

Room Kit

Room Kit
Mini

Room 55

Room
55 Dual,
Room 70Room 70
G2Room 70
PanoramaRoom
Panorama

Using external microphones with Board Pro

Board Pro has an internal microphone array that is optimized for distances up to 4 m (13 ft). This is sufficient in most small and mid-sized meeting rooms and collaboration spaces. In larger rooms, we recommend to extend audio pickup by adding external table or ceiling microphones to ensure the best audio experience.

Please note that room acoustics and background noise level also impact the speech pickup distance and quality in the meeting space. Consult Cisco Project Workplace for guidance on best practices:

► <https://projectworkplace.cisco.com>

Internal microphone array

Board Pro's internal microphone array consists of two major parts:

1. A near talker sector, covering up to about 1.5 m from the board. This picks up audio from people standing by the board, drawing or presenting.
2. Three beams that together cover about the same 120° sector as the wide camera lens. They pick up audio from people in the room, up to about 4 m from the board.

External microphones

If the room requires a pickup range beyond 4 m from the board, we recommend you to add external microphones.

Board Pro supports up to two analog microphones (mini-jack). Digital USB microphones are also supported.

When connecting an analog microphone to the board, the internal microphone array's three beams are automatically disabled. The near talker zone is activated when someone is inside this zone; hence it picks up audio from people standing by the board.

If connecting a USB microphone, all internal microphones and all external analog microphones are disabled.

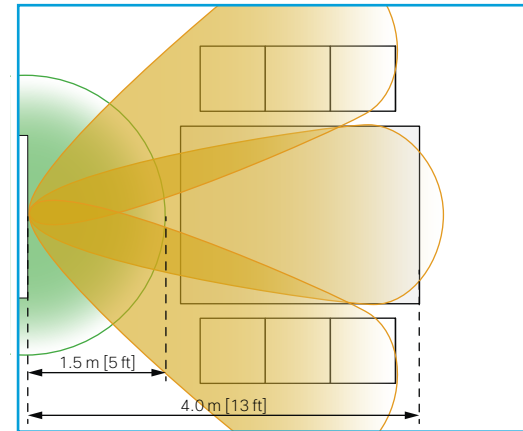

The internal microphone array with a near talker zone (green) and three beams (yellow).

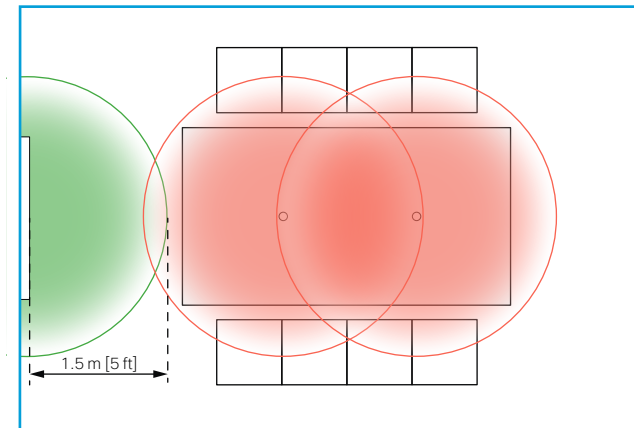

Two external microphones (red) and the internal microphone array's near talker zone (green).

Board

Board
ProCodec
EQCodec
PlusCodec
ProDesk,
Desk Pro,
DeskMiniRoom
Bar

Room Kit

Room Kit
Mini

Room 55

Room 55
Dual,
Room 70Room 70
G2Room 70
PanoramaRoom
Panorama

Test the loudspeaker connections (page 1 of 3)

It is crucial for the conferencing experience that the device's loudspeakers are correctly connected to the codec.

Correct cabling ensures that sound meant to be coming from the right loudspeakers actually comes from the right speakers, and the sound meant to be coming from the left loudspeakers comes from the left speakers. If the speaker cables are incorrectly connected this will not happen.

You must be in the same room as the video conferencing device when you test the loudspeaker connections. If the speaker test reveals any issues, you must reconnect the cables.

Room 55 Dual, Room 70, Room 70 G2, and Room 70 Panorama

We have provided a speaker check tool that you can run to verify that the loudspeakers are correctly connected. The speaker in the camera module is also included in the test.

Sign in to the device web interface and go to [Developer API](#).

Run the loudspeaker check

1. Enter the following command in the *Execute Commands and Configurations* text area:^{*}

```
xCommand Audio SpeakerCheck
  MeasurementLength: <number of
seconds>
  Volume: <test-signal volume>
```

If you leave out the `MeasurementLength` and `Volume` parameters, the test signal is emitted for 1 second from each speaker, and the volume is 1.
2. Click [Execute](#).
The speaker check will now run, and a test signal will be emitted from each speaker, in sequence from left to right.
3. Listen for the test signals.
If one or more speakers do not make a sound, or the sequence is not strictly from left to right, you have to reconnect the loudspeaker cables and run the speaker check again.

In the field below you can enter API commands (xCommand and xConfiguration) directly.

Example command:

```
xCommand Dial Number: "person@example.com" Protocol: Sip
```

```
xCommand Audio SpeakerCheck
```

Execute

^{*} Syntax and semantics are explained in the API guide for the device.

Board

Board Pro

Codec EQ

Codec Plus

Codec Pro

Desk, Desk Pro, DeskMini

Room Bar

Room Kit

Room Kit Mini

Room 55

Room 55 Dual, Room 70

Room 70 G2

Room 70 Panorama

Room Panorama

Test the loudspeaker connections (page 2 of 3)

How to reconnect cables

Check the *Installation Guide* for the product for all details.

1. Remove the device's upper textile grille. It snaps to magnets.
2. Unscrew the screw that fastens the loudspeaker (Torx T20). Then, release the speaker gently from its peg.
3. Disconnect the cable that is connected incorrectly, and connect the correct cable.

The cables are marked with a number. Check the illustrations to see which cable should be connected to which loudspeaker.

Room 55 Dual

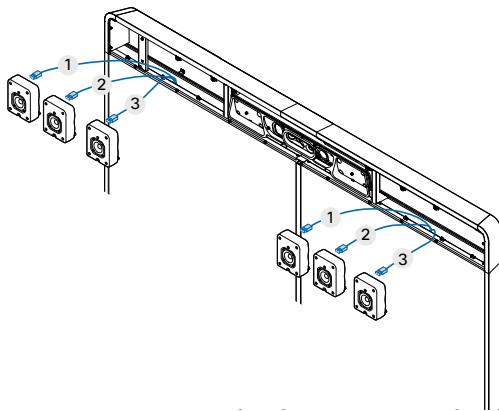

Room 70 Single and Room 70 Single G2

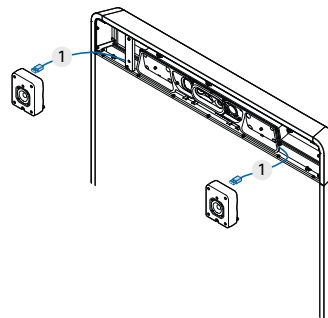

Room 70 Dual, Room 70 Dual G2, Room 70 Panorama

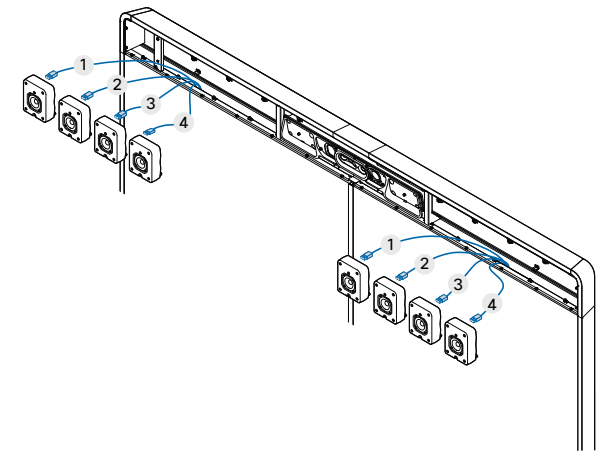

Board

Board Pro

Codec EQ

Codec Plus

Codec Pro

Desk, Desk Pro, DeskMini

Room Bar

Room Kit

Room Kit Mini

Room 55

Room 55 Dual, Room 70

Room 70 G2

Room 70 Panorama

Room Panorama

Test the loudspeaker connections (page 3 of 3)

Room Panorama

The loudspeaker test is included in the Room Panorama setup assistant. This is described in the Getting Started guide for the product.

You can also start the test manually from the touch controller.

When you perform the loudspeaker test, a sound plays from each loudspeaker in sequence.

1. Tap [Settings](#) > [Issues and diagnostics](#) > [Manual speaker check](#) > [Play Sound](#) to start the test.

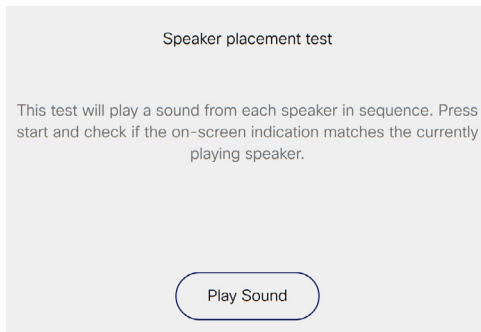

2. Tap [Next](#) to listen to the next loudspeaker, or [Previous](#) to go back and listen to the previous loudspeaker again.

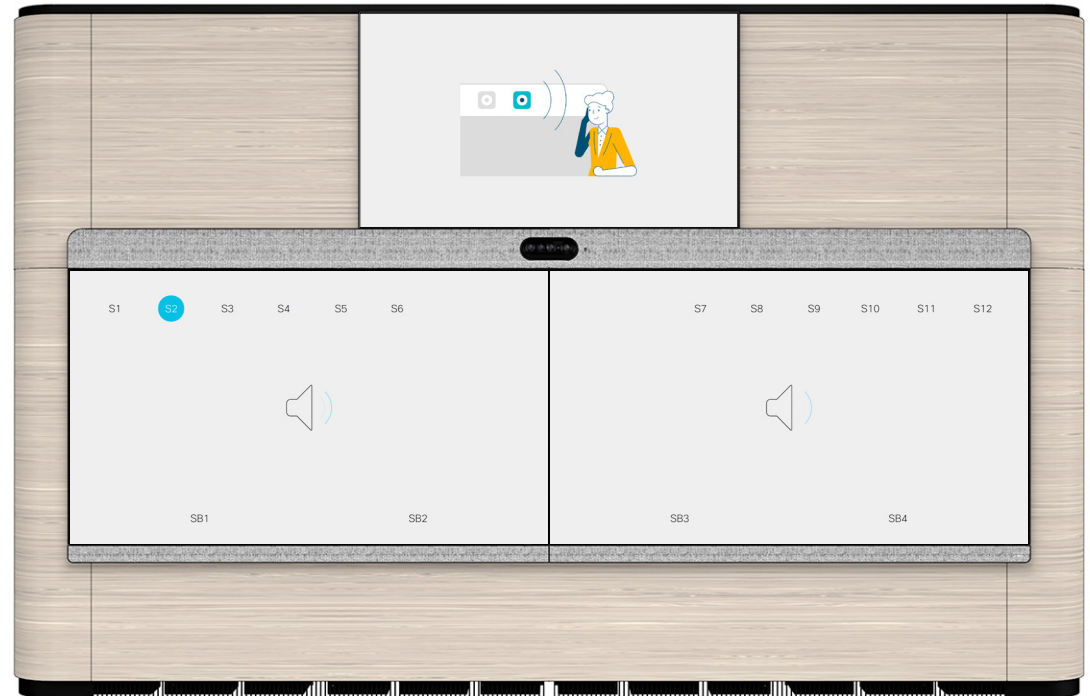

While running the test the graphics on the screens show a number close to the position of each loudspeaker. The number close to the loudspeaker that is supposed to play is marked with blue color.

- **S1-S12:** The loudspeakers above the screens (behind the speaker grille)
- **SB1-SB4:** The subwoofers below the screens (behind the cosmetic panels)

If the loudspeakers and subwoofers are connected correctly, you will hear that the sound is played from the speaker in the position that is marked with blue.

If the loudspeakers play out of order, or a loudspeaker doesn't play at all, you must check the cabling. Read the Getting Started guide to find how to fix the problem.

Board

Board
ProCodec
EQCodec
PlusCodec
ProDesk,
Desk Pro,
Desk MiniRoom
Bar

Room Kit

Room Kit
Mini

Room 55

Room
55 Dual,
Room 70Room 70
G2Room 70
PanoramaRoom
Panorama

Bluetooth® headset

The following Bluetooth profiles are supported:

- HFP (Hands-Free Profile)
- A2DP (Advanced Audio Distribution Profile)
- The headset must support both HFP and A2DP or HFP-only. Headsets with A2DP-only is not supported.

A Bluetooth headset is supported directly with the embedded Bluetooth radio or using a USB Bluetooth dongle. Multiple headsets can be paired to the video conferencing device, but only one can be connected at a time.

The range is up to 10m (30ft). If you move outside the range when in a call, the audio will switch to the speakers on the video conferencing device.

Most headsets have built in volume controls. When in a call, the volume of the headset and video conferencing device is synchronized. When not in a call, the volume buttons on the headset and video conferencing device operates independently.

Supported Bluetooth features:

- Answer an incoming call
- Hold and Resume a call
- Reject an incoming call
- Hang up a call
- Volume up and down
- Some headsets have mute control. When using a Cisco headset the mute controls on the headset and video conferencing device are synchronised. For other headsets, mute control on the headset operates independently from the mute control on the video conferencing device.

USB Bluetooth dongle





- When using a USB Bluetooth dongle the headset is detected as a USB headset.
- There will be no synchronization of headset volume and video conferencing device volume when using a dongle.
- We have tested Cisco 700 USB Adapter, Jabra Link 360, Jabra Link 370, Plantronics BT300 and Plantronics BT600; though others might work as well.

Pairing a Bluetooth headset

1. Activate Bluetooth pairing on the headset. Refer to the instruction manual for the headset if in doubt.
2. Swipe in from the right or tap the controls icon  in the upper, right corner to open the control panel. Then select *Device settings*.
3. Select *Bluetooth*. If Bluetooth is disabled, turn it on.
4. The video conferencing device will scan for Bluetooth devices. Upon successful discovery the Bluetooth headset should be displayed in the device list.
5. Select the device and pairing begins. It may take a few seconds for the pairing to complete.
6. If the pairing is successful the video conferencing device will now list the headset as connected. The pairing is now completed.

Switch between devices

You can switch between the built-in speakers on the video conferencing device and the audio devices that are connected via analog, Bluetooth or USB:

-  Built in audio (speakers)
-  Headset/Headphones (analog)
-  Headset USB
-  Handset
-  Bluetooth device

How to choose which audio device to use from the user interface:

1. Swipe in from the right or tap the controls icon  in the upper, right corner to open the control panel.

2. Select an audio device from the corresponding drop down menu. (*Board Pro, Desk, Desk Pro, and Desk Mini*)

Tap *Audio* and select an audio device from the corresponding drop down menu. (*Room Bar and Room Navigator*)

Board

Board
ProCodec
EQCodec
PlusCodec
ProDesk,
Desk Pro,
Desk MiniRoom
Bar

Room Kit

Room Kit
Mini

Room 55

Room 55
Dual,
Room 70Room 70
G2Room 70
PanoramaRoom
Panorama

Connect the touch controller (page 1 of 9)

Depending on the type of video conferencing device, the touch controller* can be connected in the following ways:

- Directly to the video conferencing device *(not supported by Board)*
- Paired to the device via the network (LAN). This is referred to as remote pairing.

Connecting the touch controller directly to the video conferencing device

Applies to: All products except Board

Room Panorama: The Room Panorama installation has an Ethernet switch that is mounted under the table, or close to the table. Connect the touch controller to this switch, and not directly to the codec.

Room Panorama supports up to two touch controllers.

Other products: Connect the touch controller to the video conferencing device's dedicated touch controller port (RJ45) as illustrated on the next pages.

Note that the Room Kit doesn't provide Power over Ethernet (PoE), so you need a mid-span PoE injector to power the touch controller.

Touch controller setup

The touch controller is powered over Ethernet (PoE). Once connected, the setup procedure begins. Follow the instructions on screen.

If the touch controller needs software upgrade, new software will be downloaded from the video conferencing device and installed on the unit automatically as part of the setup procedure. The touch controller restarts after the upgrade.

You can then complete the setup by following the instructions on the touch controller.

* Supported touch controllers: Room Navigator (shown in illustrations) and Touch 10. See the ► [Touch controllers](#) chapter to find which device supports which type of controller.

Connect the touch controller (page 2 of 9)

Connecting the touch controller directly to the video conferencing device

Codec Plus

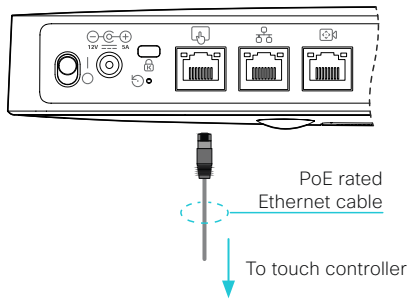

Room 55 Dual and Room 70

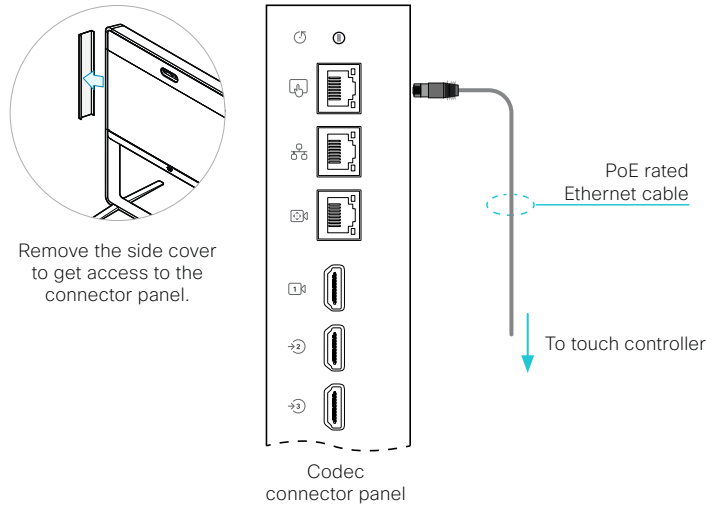

Codec Pro

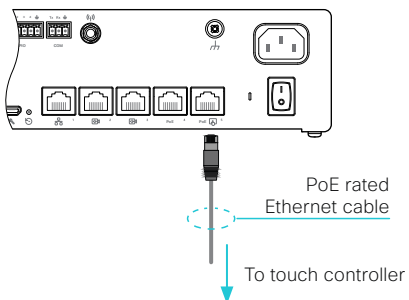

Room 70 G2 and Room 70 Panorama

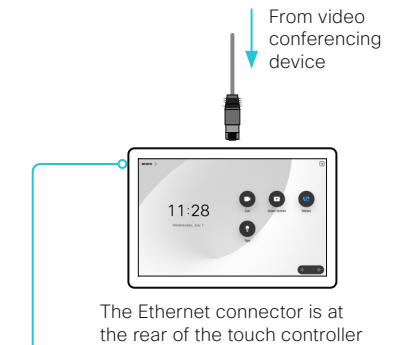
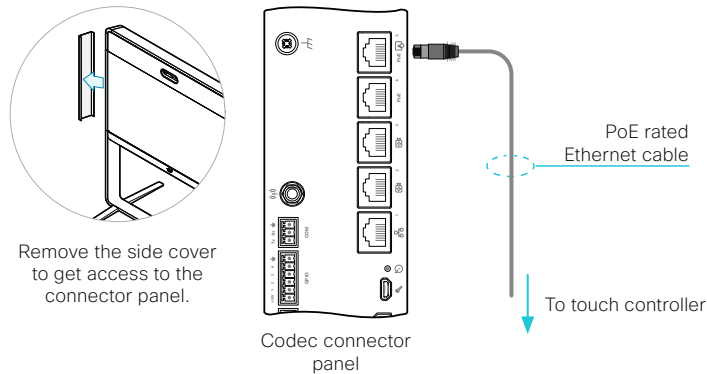

Contact information

The video conferencing device's name or address is displayed in the upper left corner when the touch controller is successfully connected to the device.

Board

Board Pro

Codec EQ

Codec Plus

Codec Pro

Desk, Desk Pro, Desk Mini

Room Bar

Room Kit

Room Kit Mini

Room 55

Room 55 Dual, Room 70

Room 70 G2

Room 70 Panorama

Room Panorama

D15503.01

RoomOS

11.1

02-2023



Board

Board Pro

Codec EQ

Codec Plus

Codec Pro

Desk, Desk Pro, Desk Mini

Room Bar

Room Kit

Room Kit Mini

Room 55

Room 55 Dual, Room 70

Room 70 G2

Room 70 Panorama

Room Panorama

Connect the touch controller (page 3 of 9)

Connecting the touch controller directly to the video conferencing device

Codec EQ

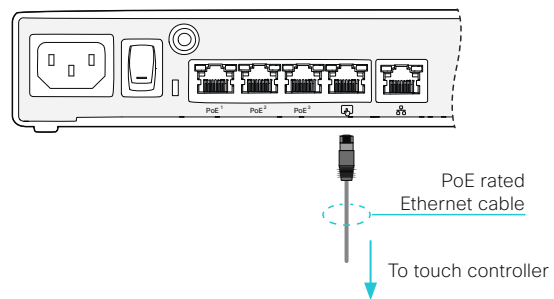

Room Kit Mini

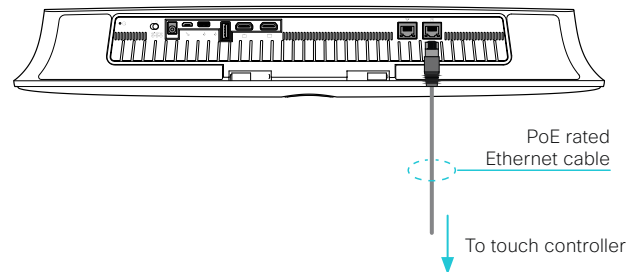

Room Kit

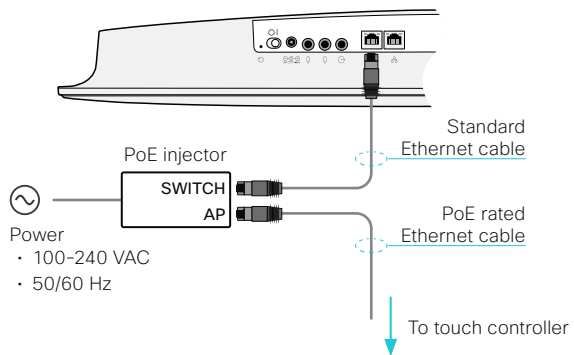

Room Bar

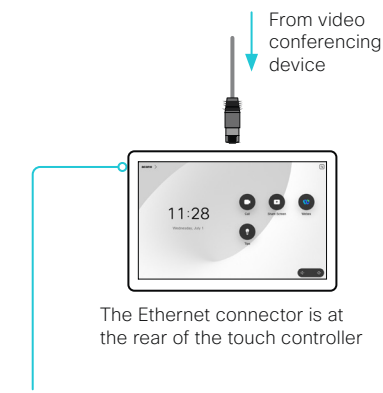
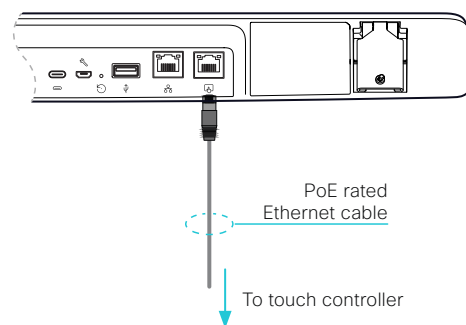

Contact information

The video conferencing device's name or address is displayed in the upper left corner when the touch controller is successfully connected to the device.

Board

Board Pro

Codec EQ

Codec Plus

Codec Pro

Desk, Desk Pro, Desk Mini

Room Bar

Room Kit

Room Kit Mini

Room 55

Room 55 Dual, Room 70

Room 70 G2

Room 70 Panorama

Room Panorama

Connect the touch controller (page 4 of 9)

Connecting the touch controller directly to the video conferencing device

Room 55

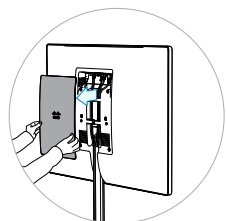

Remove the rear cover to get access to the connector panel and power switch.

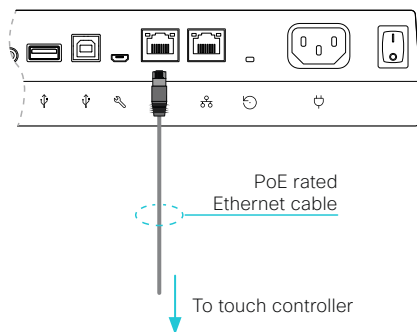

Room Panorama

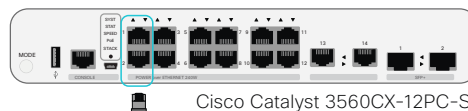

Board Pro

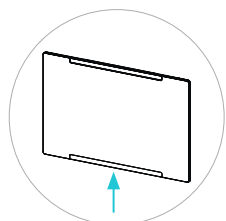

The connector panel is at the bottom.

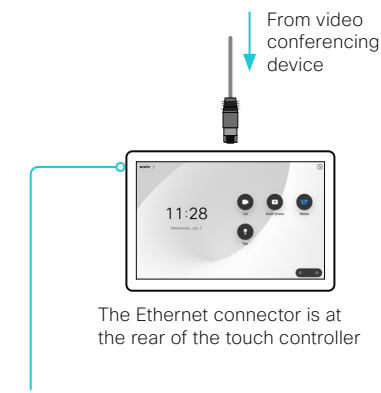
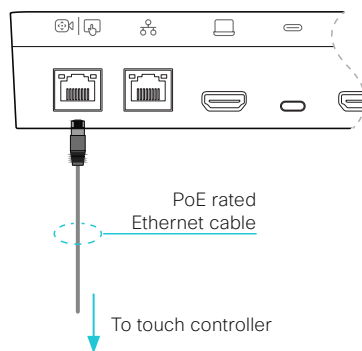

Contact information

The video conferencing device's name or address is displayed in the upper left corner when the touch controller is successfully connected to the device.

Board

Board
ProCodec
EQCodec
PlusCodec
ProDesk,
Desk Pro,
DeskMiniRoom
Bar

Room Kit

Room Kit
Mini

Room 55

Room 55
Dual,
Room 70Room 70
G2Room 70
PanoramaRoom
Panorama

Connect the touch controller (page 5 of 9)

Connecting the touch controller to the video conferencing device via the network (LAN)

Connect the touch controller and the video conferencing device to network wall sockets or to a network switch, as illustrated on the next pages.

Touch controller setup

Once the touch controller is connected to power, the setup procedure begins. Follow the instructions on screen.

When the *Select a room device* screen appears, select the video device that you want to connect to.

- A list of devices signalling that they are available for pairing will show up on the screen. Tap the name of the device you want to pair with.

Note that the following must be fulfilled for a device to show up in the list:

- The device and touch controller must be on the same subnet.
- The device must have been restarted within the last 10 minutes. If the device does not appear in the list, try restarting it.
- If the device does not appear in the list of available devices, enter its IP address or hostname in the input field. Tap *Connect*.

If the touch controller needs software upgrade, new software will be downloaded from the device and installed on the unit automatically as part of the setup procedure. The touch controller restarts after the upgrade.

When the *Pair to device* screen appears, select how to pair from these options:

- Username/Passphrase - Sign-in with username and passphrase. Tap the right arrow to proceed.

A user with the USER role is sufficient; you do not need the ADMIN role to perform this task.

Read more about how to create a user account and assign a role to it in the ► [User administration](#) chapter.

- PIN pairing - Generate the PIN through the xAPI.

To initiate PIN pairing and create a PIN:

```
xCommand Peripherals Pairing PinPairing Start
```

You can specify the following parameters:

- *Duration* - How long the pairing process will be active (minutes).
- *PinVisibleOnScreen* - Whether the PIN will be visible on the main screen connected to the video device. If this is false, the administrator must provide the PIN to the person at the touch controller screen.
- *Retries* - How many invalid attempts will be allowed before a new PIN must be generated.

- Board
- Board Pro
- Codec EQ
- Codec Plus
- Codec Pro
- Desk, Desk Pro, Desk Mini
- Room Bar
- Room Kit
- Room Kit Mini
- Room 55
- Room 55 Dual, Room 70
- Room 70 G2
- Room 70 Panorama
- Room Panorama

Connect the touch controller (page 6 of 9)

Connecting the touch controller to the video conferencing device via the network (LAN)

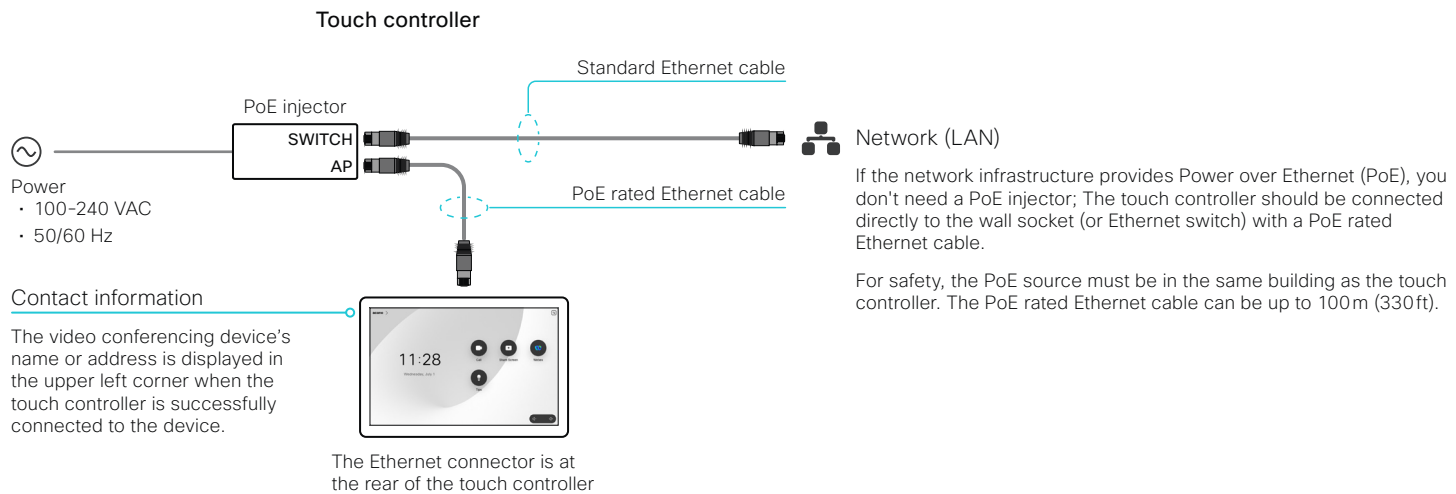

Board

Board Pro

Codec EQ

Codec Plus

Codec Pro

Desk, Desk Pro, Desk Mini

Room Bar

Room Kit

Room Kit Mini

Room 55

Room 55 Dual, Room 70

Room 70 G2

Room 70 Panorama

Room Panorama

Connect the touch controller (page 7 of 9)

Connecting the touch controller to the video conferencing device via the network (LAN)

Codec Plus

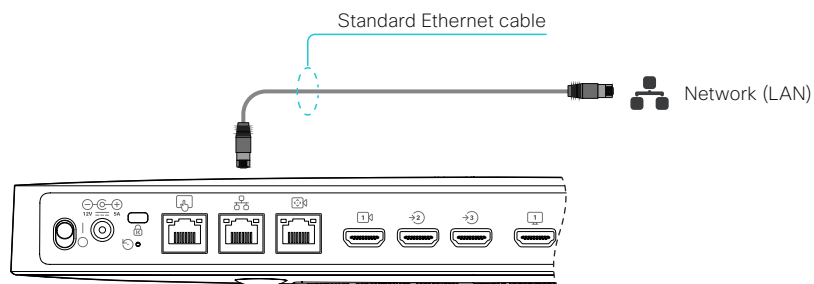

Room 55 Dual and Room 70

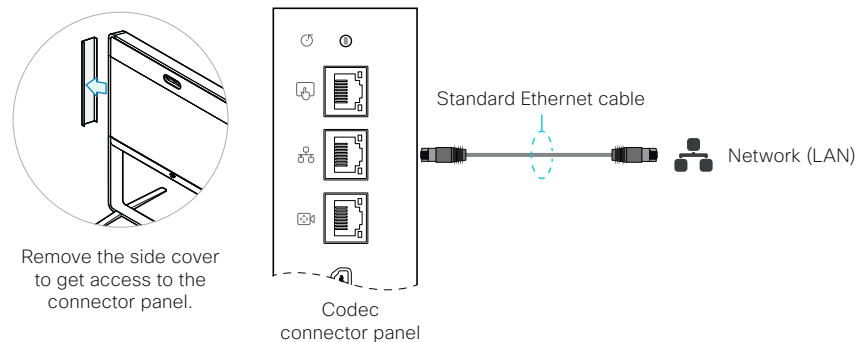

Codec Pro and Room Panorama

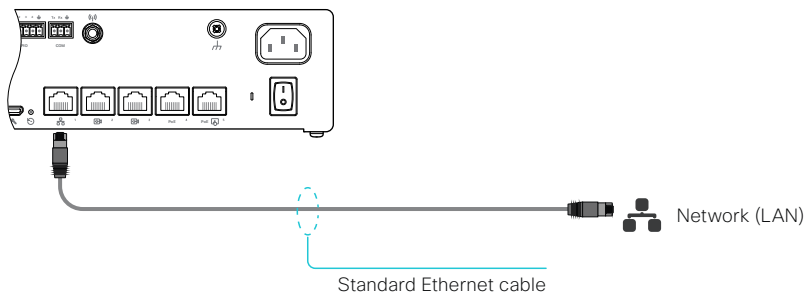

Room 70 G2 and Room 70 Panorama

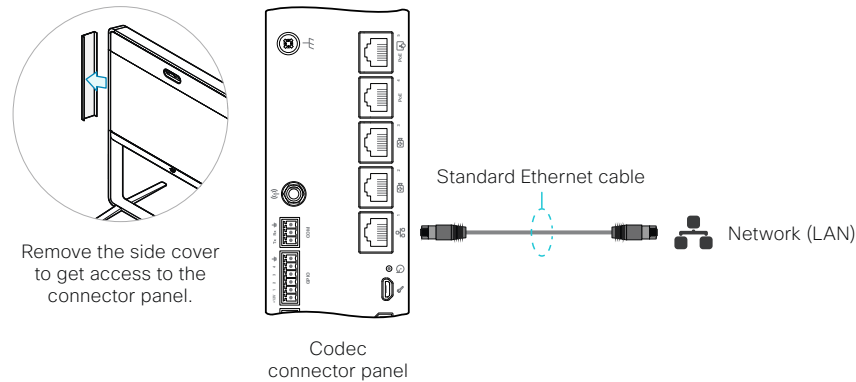

- Board
- Board Pro
- Codec EQ**
- Codec Plus
- Codec Pro
- Desk, Desk Pro, Desk Mini
- Room Bar**
- Room Kit
- Room Kit Mini**
- Room 55
- Room 55 Dual, Room 70
- Room 70 G2
- Room 70 Panorama
- Room Panorama

Connect the touch controller (page 8 of 9)

Connecting the touch controller to the video conferencing device via the network (LAN)

Codec EQ

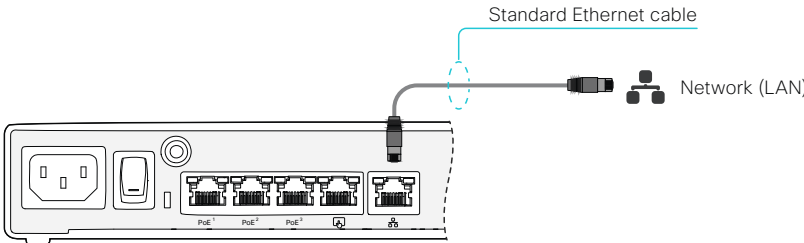

Room Kit Mini

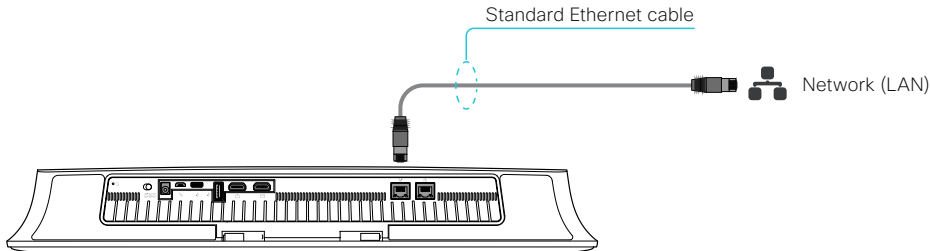

Room Kit

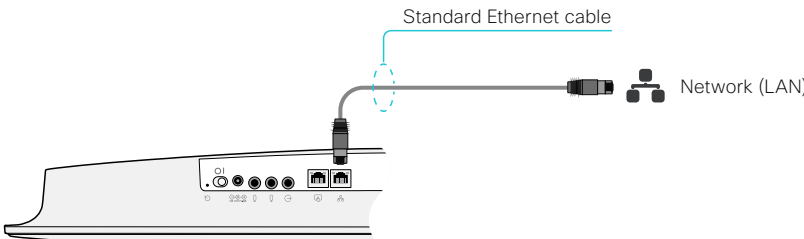

Room Bar

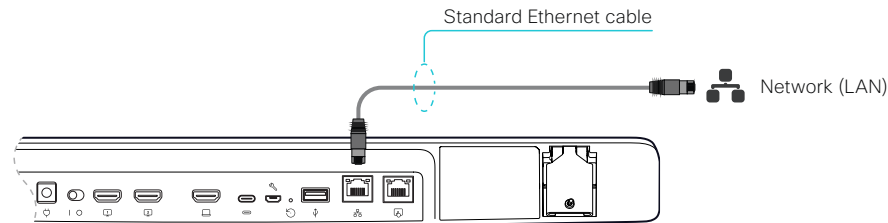

Board

Board Pro

Codec EQ

Codec Plus

Codec Pro

Desk, Desk Pro, DeskMini

Room Bar

Room Kit

Room Kit Mini

Room 55

Room 55 Dual, Room 70

Room 70 G2

Room 70 Panorama

Room Panorama

Connect the touch controller (page 9 of 9)

Connecting the touch controller to the video conferencing device via the network (LAN)

Room 55

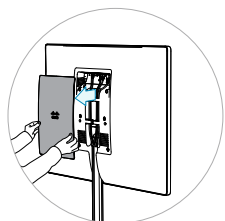

Remove the rear cover to get access to the connector panel and power switch.

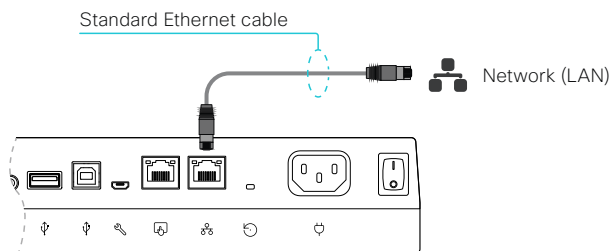

Board

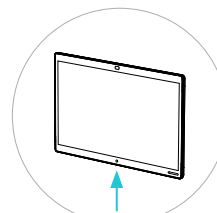

The connector panel is at the bottom, rear side.

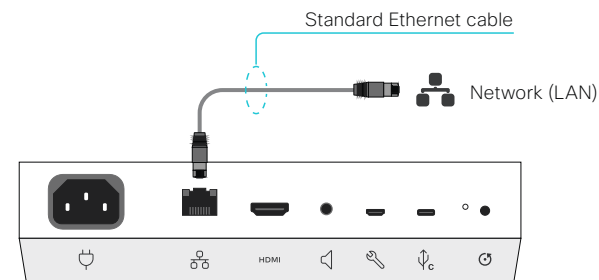

Board Pro

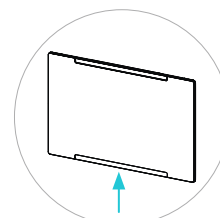

The connector panel is at the bottom.

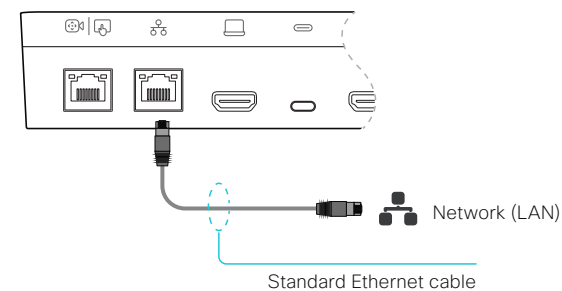

Board

Board
Pro

Codec
EQ

Codec
Plus

Codec
Pro

Desk,
Desk Pro,
Desk Mini

Room
Bar

Room Kit

Room Kit
Mini

Room 55

Room 55
Dual,
Room 70

Room 70
G2

Room 70
Panorama

Room
Panorama

Chapter 4

Maintenance

Board

Board
ProCodec
EQCodec
PlusCodec
ProDesk,
Desk Pro,
Desk MiniRoom
Bar

Room Kit

Room Kit
Mini

Room 55

Room 55
Dual,
Room 70Room 70
G2Room 70
PanoramaRoom
Panorama

Installing new software (page 1 of 2)

Download new software

Each software version has a unique file name. Go to the Cisco Download Software web page, and select your product:

► <https://software.cisco.com/download/home>

The format of the file name is: *

- "cmterm-s53200ce11_x_y_z.k4.cop.sha512"
(for Board, Codec Plus, Room Kit, Room Kit Mini, Room 55, Room 55 Dual, and Room 70)
- "cmterm-s53300ce11_x_y_z.k4.cop.sha512"
(for Board Pro, Desk Pro, Desk, Desk Mini, Codec EQ, Codec Pro, Room Bar, Room 70 G2, Room 70 Panorama, and Room Panorama)

where "x" is the minor release number, "y" is the patch number and "z" is the build number.

Software upgrade and downgrade

Carefully read the software release notes (link in side bar) to find software upgrade and downgrade requirements. This applies both when installing software using Cisco UCM, TMS, the device web interface, or other.

When upgrading or downgrading, any settings not appearing in the version you are installing will be deleted. If you later try to go back to the previous software version, those removed settings will be assigned default values.

Cloud-managed software upgrade

If your device is linked to Webex Edge for Devices, you can choose to upgrade the software from the Webex cloud service. Then the device is upgraded automatically as soon as a new RoomOS software version is available from the cloud.

Find more details about *Cloud-managed software upgrade for Webex Edge for Devices* in the ► [Webex Edge for Devices \(https://help.webex.com/cy2l2z/\)](https://help.webex.com/cy2l2z/) article on Webex Help Center.

About PKG files and COP files

The software images for the video device and the peripherals are in separate PKG files.

Therefore, you must use the COP file when upgrading these devices. The COP file contains the required PKG files for the video device and the peripherals, and a *loads* file that lists the content of the COP file.

Software release notes

For a complete overview of the news and changes in this release, we recommend reading the Software Release Notes (RoomOS 11). It's one set of release notes that covers all products. Go to one of these pages:

- <https://www.cisco.com/c/en/us/support/collaboration-endpoints/desktop-collaboration-experience-dx600-series/products-release-notes-list.html>
- <https://www.cisco.com/c/en/us/support/collaboration-endpoints/spark-room-kit-series/products-release-notes-list.html>
- <https://www.cisco.com/c/en/us/support/collaboration-endpoints/spark-board/products-release-notes-list.html>

Board

Board Pro

Codec EQ

Codec Plus

Codec Pro

Desk, Desk Pro, Desk Mini

Room Bar

Room Kit

Room Kit Mini

Room 55

Room 55 Dual, Room 70

Room 70 G2

Room 70 Panorama

Room Panorama

Installing new software (page 2 of 2)

If you want to install software from the device web interface, sign in the interface, go to [Software](#), and select [Software Upgrade](#).

Install new software

Download the appropriate software package and store it on your computer. This is a .cop.sgn file. Don't change the file name.

1. Click [Choose File](#) and find the .cop.sgn file that contains the new software.
The software version will be detected and shown.
2. Click [Install](#) to start the installation process.

The complete installation normally take no longer than 15 minutes. You can follow the progress on the web page. The device restarts automatically after the installation.

You must sign in anew in order to continue working with the device web interface after the restart.

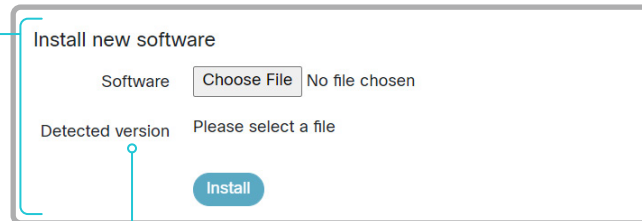

Check new software version

When you have selected a file, the software version is shown here

- Board
- Board Pro
- Codec EQ
- Codec Plus
- Codec Pro
- Desk, Desk Pro, Desk Mini
- Room Bar
- Room Kit
- Room Kit Mini
- Room 55
- Room 55 Dual, Room 70
- Room 70 G2
- Room 70 Panorama
- Room Panorama

Add option keys

Sign in to the device web interface, go to [Software](#), and select [Option Keys](#).

You see a list of all option keys, also the ones that are not installed on your device.

Contact your Cisco representative for information about how to get option keys for the uninstalled options.

Type	Description	Key	Status	
RemoteMonitoring	Enables snapshots of local and remote video sources in the web interface	Active	
DeveloperPreview	Enables previewing new APIs and features		Not installed	

Uninstall an option key

Click the delete button to uninstall an option key.

The device's serial number

You need the device's serial number when ordering an option key.

Add an option key

1. Enter an *Option key* in the text input field.
2. Click *Apply* to add the option key.

If you want to add more than one option key, repeat these steps for all keys.

Add key

Serial number

Option key

Contact your Cisco representative to obtain option keys. You need to provide the serial number to get option keys.

[Apply](#)

About option keys

Your device may or may not have one or more software options installed. In order to activate the optional functionality the corresponding *option key* must be present on the device.

Each device has unique option keys.

Option keys are not deleted when performing a software upgrade or factory reset, so they need to be added only once.

Board

Board Pro

Codec EQ

Codec Plus

Codec Pro

Desk, Desk Pro, Desk Mini

Room Bar

Room Kit

Room Kit Mini

Room 55

Room 55 Dual, Room 70

Room 70 G2

Room 70 Panorama

Room Panorama

Device status

Device information overview

Sign in to the device web interface and select [Home](#).

This is the *System Information* page, which shows general information such as IP address, MAC address, serial number, active network interface, software version, SIP address, issues, registration status, utilization and environment data, and more.

Detailed device status

Sign in to the device web interface, go to [Settings](#), and select [Statuses](#), in order to find more detailed status information*.

Search for a status entry

Enter as many letters as needed in the search field. All entries that contain these letters are shown in the right pane. Entries that have these letters in their value space are also shown.

The screenshot shows a search interface with 'vol' entered in the search field. The left sidebar lists categories: Audio, Bookings, Cameras, Capabilities, and Conference. The right pane displays the 'Audio' category with the following status entries:

Ultrasound Volume	60
Volume	70
VolumeKeyStepSize	10
VolumeMute	Off

Select a category and navigate to the correct status

The device status is grouped in categories. Choose a category in the left pane to show the related status to the right.

The screenshot shows the 'Status / Conference' page. The left sidebar has 'Conference' selected. The right pane displays the following status entries:

ActiveSpeaker CallId	0
DoNotDisturb	Inactive
Line 1 Mode	Shared
Multipoint Mode	MultiSite
Muter Mode	User
SelectedCallProtocol	SIP

* The status shown in the illustration serve as an example. The status of your device may be different.

Board

Board Pro

Codec EQ

Codec Plus

Codec Pro

Desk, Desk Pro, Desk Mini

Room Bar

Room Kit

Room Kit Mini

Room 55

Room 55 Dual, Room 70

Room 70 G2

Room 70 Panorama

Room Panorama

Run diagnostics

Sign in to the device web interface, go to [Issues and Diagnostics](#), and select [Issues](#).

A list of active issues* are shown. Errors and critical issues are clearly marked in red color; warnings are yellow.

Run diagnostics

Click [Rerun](#) to ensure that the list is up to date.

Leave standby mode

Click [System Wakeup](#) to wake up a device that is in standby mode.

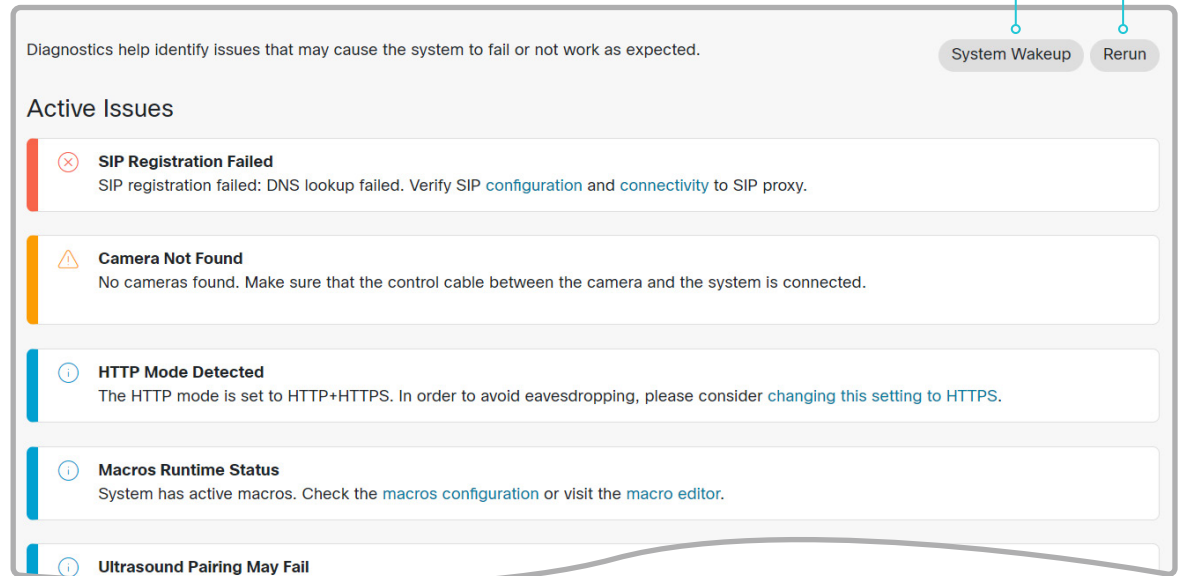

* The issues shown in the illustration serve as examples. Your device will show other information.

Board

Board
ProCodec
EQCodec
PlusCodec
ProDesk,
Desk Pro,
Desk MiniRoom
Bar

Room Kit

Room Kit
Mini

Room 55

Room 55
Dual,
Room 70Room 70
G2Room 70
PanoramaRoom
Panorama

Get system log files (page 1 of 2)

The system log files are Cisco specific debug files which may be requested by the Cisco support organization if you need technical support.

Current logs and historical logs

The *current log files* are time stamped event log files.

All current log files are archived in a time stamped *historical log file* each time the device restarts. If the maximum number of historical log files is reached, the oldest one will be overwritten.

Extended logging mode

Extended logging mode may be switched on to help diagnose network issues and problems during call setup. While in this mode more information is stored in the log files. Network traffic may also be captured in this mode.

Extended logging uses more of the device's resources, and may cause the device to under-perform. Only use extended logging mode when you are troubleshooting an issue.

Extended logging lasts for 3 or 10 minutes, depending on whether full capture of network traffic is included or not.

Personal identifiable information (PII) in logs

You can choose whether to include PII in the logs or not. In some cases PII is replaced by a *Removed for privacy* note rather than the full entry being removed.

Set up logs from the user interface

You have a few options to set up logs from the device's user interface.

1. Swipe in from the right or tap the controls icon  in the upper, right corner to open the control panel. Then select *Device settings*. *
2. Open *Issues and diagnostics* and find these toggle buttons:
 - *Extended logging*: If toggled on, a full capture of network traffic will be included in the logs. PII information will also be included.
 - *PII logging*: If toggled on, PII will be included in the logs, even if Extended logging is not turned on.

Sending logs to the Webex cloud

If your device is registered to the Webex cloud service or linked to Webex Edge for Devices, you can also upload the logs to the cloud.

1. Swipe in from the right or tap the controls icon  in the upper, right corner to open the control panel. Then select *Device settings*. *
2. Open *Issues and diagnostics* and tap *Send logs*.

* For Room 70 Panorama and Room Panorama: Select the device name or address at the top of the user interface. Then select *Settings*.

Board

Board Pro

Codec EQ

Codec Plus

Codec Pro

Desk, Desk Pro, Desk Mini

Room Bar

Room Kit

Room Kit Mini

Room 55

Room 55 Dual, Room 70

Room 70 G2

Room 70 Panorama

Room Panorama

Get system log files (page 2 of 2)

Set up and download logs from the device web interface

Sign in to the device web interface, go to [Issues and Diagnostics](#), and select [System Logs](#).

Download all log files

Find the *System Logs* card, and click [Download logs...](#)

Choose whether to download *Full logs* or *Anonymized logs*.

Follow the instructions to save the file.

Personal identifiable information (PII) are replaced by a *Removed for privacy* note in the anonymized logs. Attaching anonymized logs to support cases may increase the time needed to resolve your issue.

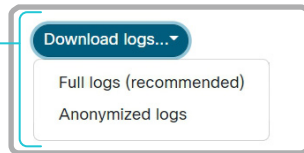

Start extended logging

Find the *Extended Logging* card, and click [Start](#).

Extended logging lasts for 3 or 10 minutes, depending on whether full capture of network traffic is included or not.

Click [Stop](#) if you want to stop the extended logging before it times out.

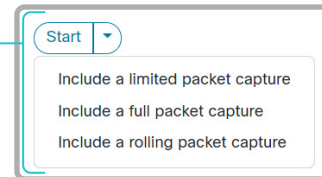

As default, the network traffic is not captured. Use the drop down menu if you want to include partial or full capture of network traffic. A rolling, full capture mode is also available.

Download all log files (legacy format) **Not recommended**

Find the *System Logs* card, and click [Download logs in legacy format...](#)

Choose whether to include the full call history (non-anonymous caller/callee), an anonymized call history, or no call history at all, in the log files.

Follow the instructions to save the file.

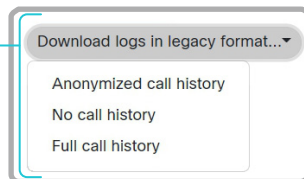

Open or save a log file

Click a *current log file* to open the log file in the web browser; right click to save the file on the computer.

Click a *historical log file* and follow the instructions to save the file on your computer.

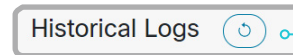
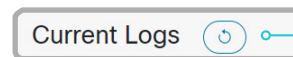

Refresh a log file list

Click the refresh button for *Current logs* or *Historical logs* to update the corresponding lists.

Log file format

We introduced a new log file format for on-premises registered devices in CE9.15. The new format aligns with the format used for cloud registered devices.

We recommend you to download logs using the newer file format, rather than using the legacy format.

Board

Board
ProCodec
EQCodec
PlusCodec
ProDesk,
Desk Pro,
Desk MiniRoom
Bar

Room Kit

Room Kit
Mini

Room 55

Room 55
Dual,
Room 70Room 70
G2Room 70
PanoramaRoom
Panorama

Get call logs

Sign in to the device web interface, go to *Issues and Diagnostics*, and select *Call Logs*. From the list that appears, select a call to see its details.

The details include information about the remote number, direction of the originating call, protocol, call rate, encryption type, and duration; as well as, information relating to the disconnection of a call.

The **Disconnect cause type** field is used to describe why the call was disconnected. There are many possible values, and these can be changed downstream. Some examples include: OtherLocal, LocalDisconnect, UnknownRemoteSite, LocalBusy, LocalReject, InsufficientSecurity, OtherRemote, RemoteDisconnect, RemoteBusy, RemoteRejected, RemoteNoAnswer, CallForwarded, and NetworkRejected.

The **disconnection cause** field can provide additional information as a supplement to the **disconnect cause type**.

The **disconnect cause code** is defined by SIP and Q.850.

Occurrence type provides further information relating to whether the call was placed, received, missed, rejected, if the remote end never answered the call, or if the call answered on another device.

The **Is acknowledged** field shows whether or not a missed call has been acknowledged by a user.

- Board
- Board Pro
- Codec EQ
- Codec Plus
- Codec Pro
- Desk, Desk Pro, Desk Mini
- Room Bar
- Room Kit
- Room Kit Mini
- Room 55
- Room 55 Dual, Room 70
- Room 70 G2
- Room 70 Panorama
- Room Panorama

Create a remote support user

Sign in to the device web interface and, go to [Users](#).

 The remote support user should only be enabled for troubleshooting reasons when instructed by Cisco TAC.

Create remote support user

1. Find the *Remote Support User* card, and click [Create User](#).
2. Open a case with Cisco TAC.
3. Copy the text in the *Token* field and send it to Cisco TAC.
4. Cisco TAC will generate a *password*.

The remote support user is valid for seven days, or until it is deleted.

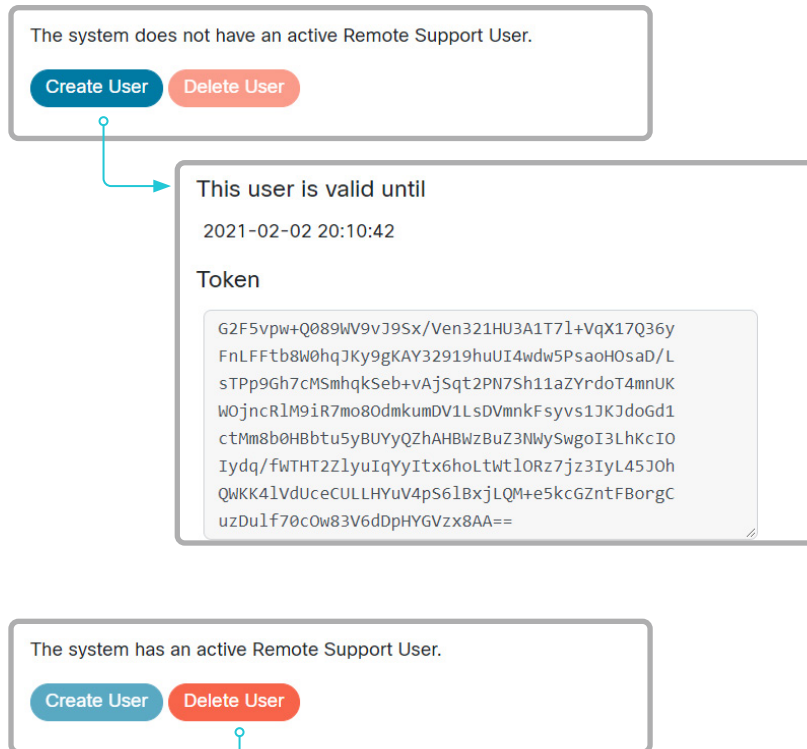

Delete remote support user

Click [Delete User](#).

About the remote support user

In cases where you need to diagnose problems on the device you can create a remote support user.

The remote support user is granted read access to the device and has access to a limited set of commands that can aid troubleshooting.

You will need assistance from Cisco Technical Assistance Center (TAC) to acquire the password for the remote support user.

Board

Board
ProCodec
EQCodec
PlusCodec
ProDesk,
Desk Pro,
Desk MiniRoom
Bar

Room Kit

Room Kit
Mini

Room 55

Room 55
Dual,
Room 70Room 70
G2Room 70
PanoramaRoom
Panorama

Backup and restore configurations and custom elements

Sign in to the device web interface and go to [Backup and Recovery](#).

You can include custom elements as well as configurations in a backup file (zip-format). You can choose which of the following elements to include in the bundle:

- Branding images
- Macros
- Favorites
- Sign-in banner
- UI extensions
- Configurations/settings (all or a sub-set)

The backup file can either be restored manually from the device web interface, or you can generalize the backup bundle so that it can be provisioned across multiple devices, for example using Cisco UCM or TMS (see the **next** chapters).

Create a backup file

1. Select [Backup](#).
2. Select the elements you want to include in the backup file.
3. Select which settings - if any - you want to include in the backup file. Note the following:
 - As default, all settings are included in the backup file.
 - You can remove one or more settings manually by deleting them from the list on the web page.
 - If you want to remove all settings that are specific to one device, click [Remove system-specific configurations](#).

This is useful if you are going to restore the backup bundle on other devices.
4. Click [Download](#) to store the elements in a zip-file on your computer.

Restore a backup file

1. Select [Restore](#).
2. Click [Choose File](#) and find the backup file you want to restore. All settings and elements in the backup file will be applied.
3. Click [Upload](#) to apply the backup.

Some settings may require that you restart the device before they take effect.

Additional information

Restoring macros

If a backup file that contains macros is restored on a device the following applies:

- The macro runtime is started or restarted.
- The macros are automatically activated (started).

Restoring branding images

If a backup bundle contains branding images, the *UserInterface Wallpaper* setting is automatically set to **Auto**.

This means that the branding images will automatically be displayed.

The backup file

The backup file is a zip-file that contains several files. It is important that the files are at the top level within the zip-file, and not include in a folder.

Board

Board
ProCodec
EQCodec
PlusCodec
ProDesk,
Desk Pro,
Desk MiniRoom
Bar

Room Kit

Room Kit
Mini

Room 55

Room 55
Dual,
Room 70Room 70
G2Room 70
PanoramaRoom
Panorama

CUCM provisioning of custom elements

A backup file, as described in the ► [Backup and restore configurations and custom elements](#) chapter, can be used as a *customization template* for multiple devices.

The customization template (backup file) may be hosted on either:

- the CUCM TFTP file service, or
- a custom web server that can be reached by the devices on HTTP or HTTPS.

When a device get information from CUCM (Cisco Unified Communications Manager) about the name and location of a customization template, the device will contact the server, download the file, and restore the custom elements.



Configurations will not be restored on the device, even if they are part of the backup file that you use as a customization template.

Upload a customization template to the TFTP file server

1. Sign in to *Cisco Unified OS Administration*.
2. Navigate to *Software Upgrades > TFTP File Management*.
3. Click *Upload File*. Enter the name and path of the customization template in the input field.
4. Click *Upload File*.

Add customization provisioning information for each device

1. Sign in to *Cisco Unified CM Administration*.
2. Navigate to *Device > Phone*.
3. Fill in the **Customization Provisioning** fields in the product specific configuration section of the relevant devices:
 - *Customization File*: The customization template file name (for example: backup.zip) *
 - *Customization Hash Type*: **SHA512**
 - *Customization Hash*: The SHA512 checksum for the customization template.If these fields are not present, you must install a newer Device Package on CUCM.
4. Click *Save* and *Apply Config* to push the configuration to the devices.

SHA512 checksum

Tip! You can find the SHA512 checksum of a file by restoring it to a device using its web interface.

1. Sign in to the device web interface, go to *Backup and Recovery*, and select *Restore*.
2. Click *Choose File* and find the file you want to calculate the checksum for.

Then you can see the SHA512 checksum at the bottom of the page.

CUCM documentation

► <https://www.cisco.com/c/en/us/support/unified-communications/unified-communications-manager-callmanager/tsd-products-support-series-home.html>

* If not using the TFTP Service, you must enter the complete URI for the customization template: <hostname>:<portnumber>/<path-and-filename>

For example:

- <http://host:6970/backup.zip>, or
- <https://host:6971/backup.zip>

Board

Board
ProCodec
EQCodec
PlusCodec
ProDesk,
Desk Pro,
Desk MiniRoom
Bar

Room Kit

Room Kit
Mini

Room 55

Room 55
Dual,
Room 70Room 70
G2Room 70
PanoramaRoom
Panorama

TMS provisioning of custom elements

A backup file, as described in the ► [Backup and restore configurations and custom elements](#) chapter, can be used as a *customization template* for multiple devices.

The backup file must be hosted on a custom web server that can be reached by the devices on HTTP or HTTPS.

When a device get information from TMS (TelePresence Management Suite) about the name and location of the backup file, the device will contact the server, download the file, and restore the custom elements.

Create and apply a configuration template

1. Create a configurations template.
2. Add a custom command containing the following XML string in the configuration template:

```
<Command>
  <Provisioning>
    <Service>
      <Fetch>
        <URL>web-server-address</URL>
        <Checksum>checksum</Checksum>
        <Origin>origin</Origin>
      </Fetch>
    </Service>
  </Provisioning>
</Command>
```

where

web-server-address: The URI to the backup file (for example, `http://host/backup.zip`).

checksum: The SHA512 checksum of the backup file.

origin: **Provisioning** *

3. Select the devices you want to push the configuration template to, and click [Set on systems](#).

Read the ► [Cisco TMS administrator guide](#) for details how to create TMS configurations templates and make custom commands.

SHA512 checksum

Tip! You can find the SHA512 checksum of a file by restoring it to a device using its web interface.

1. Sign in to the device web interface, go to [Backup and Recovery](#), and select [Restore](#).
2. Click [Choose File](#) and find the file you want to calculate the checksum for.

Then you can see the SHA512 checksum at the bottom of the page.

* If not setting this parameter to **Provisioning**, also configurations that are part of the backup file will be pushed to the device. If the backup file contains configurations that are specific to one device, for example static IP addresses, device name, and contact information, you may end up with devices that you cannot reach.

Board

Board
ProCodec
EQCodec
PlusCodec
ProDesk,
Desk Pro,
Desk MiniRoom
Bar

Room Kit

Room Kit
Mini

Room 55

Room 55
Dual,
Room 70Room 70
G2Room 70
PanoramaRoom
Panorama

Revert to the previously used software image

Sign in to the device web interface, go to [Backup and Recovery](#), and select [System Recovery](#).

We recommend you to back up the log files, configurations, and custom elements of the device before you swap to the previously used software image.

Back up log files

1. Go to [Issues and Diagnostics](#) and select [System Logs](#).
2. Click [Download logs](#) and follow the instructions to save the log files on your computer.

Back up configurations and custom elements

1. Go to [Backup and Recovery](#) and select [Backup](#).
2. Click [Download](#) and follow the instructions to save the backup bundle on your computer.

Revert to the previously used software image

Only administrators, or people in contact with Cisco technical support, should perform this procedure.

1. Select [System Recovery](#).
2. Find the [Software Recovery Swap](#) card and click [Swap software](#).
3. Click [Confirm](#) to continue, or [Cancel](#) if you have changed your mind.

Wait while the device resets. The device restarts automatically when finished. This procedure may take a few minutes.

About the previously used software image

If there is a severe problem with the device, switching to the previously used software image may help solving the problem.

If the device has not been factory reset since the last software upgrade, the previously used software image still resides on the device. You do not have to download the software again.

Board

Board
ProCodec
EQCodec
PlusCodec
ProDesk,
Desk Pro,
Desk MiniRoom
Bar

Room Kit

Room Kit
Mini

Room 55

Room 55
Dual,
Room 70Room 70
G2Room 70
PanoramaRoom
Panorama

Factory reset the video conferencing device (page 1 of 5)

If there is a severe problem with the device, the last resort may be to reset it to its default factory settings.



It is not possible to undo a factory reset.

Always consider reverting to the previously used software image before performing a factory reset. In many situations, this will recover the device. Read about software swapping in the [► Revert to the previously used software image](#) chapter.

We recommend that you use the device web interface or user interface to factory reset the device. If these interfaces are not available, you can use the reset button through the pinhole.

A factory reset implies:

- Call logs are deleted.
- Passphrases are reset to default.
- All device parameters are reset to default values.
- All files that have been uploaded to the device are deleted. This includes, but is not limited to, custom wallpaper, branding elements, certificates, and favorites lists.
- The previous (inactive) software image is deleted.
- Option keys are not affected.

The device restarts automatically after the factory reset. It is using the same software image as it used before the reset.

We recommend that you back up the log files, configurations, and custom elements of the device before performing a factory reset; otherwise this data will be lost.

Factory reset using the web interface

We recommend that you back up the log files and configuration of the device before you continue with the factory reset.

Sign in to the device web interface, go to [Backup and Recovery](#), and select [System Recovery](#).

1. Find the [Factory Reset](#) card, and read the provided information carefully.
2. Click [Reset to Factory Defaults](#).
3. Click [Factory Reset](#) to confirm your choice, or [Cancel](#) if you have changed your mind.
4. Wait while the device reverts to the default factory settings. When finished, the device restarts automatically. This may take a few minutes.

When the device has been successfully reset to factory settings, the [Setup assistant](#) starts with the [Welcome](#) screen.

Back up log files

1. Go to [Issues and Diagnostics](#) and select [System Logs](#).
2. Click [Download logs](#) and follow the instructions to save the log files on your computer.

Back up configurations and custom elements

1. Go to [Backup and Recovery](#) and select [Backup](#).
2. Click [Download](#) and follow the instructions to save the backup bundle on your computer.

Factory reset from the user interface

We recommend that you back up the log files and configuration of the device before you continue with the factory reset.

1. Swipe in from the right or tap the controls icon  in the upper, right corner to open the control panel. Then select [Device settings](#). *
2. Select [Factory reset](#).
3. Select [Reset](#) to confirm your choice, or [Cancel](#) if you have changed your mind.
4. Wait while the device reverts to the default factory settings. When finished, the device restarts automatically. This may take a few minutes.

When the device has been successfully reset to factory settings, the [Setup assistant](#) starts with the [Welcome](#) screen.

* For Room 70 Panorama and Room Panorama: Select the device name or address at the top of the user interface. Then select [Settings](#).

Board

Board Pro

Codec EQ

Codec Plus

Codec Pro

Desk, Desk Pro, Desk Mini

Room Bar

Room Kit

Room Kit Mini

Room 55

Room 55 Dual, Room 70

Room 70 G2

Room 70 Panorama

Room Panorama

Factory reset the video conferencing device (page 2 of 5)

Factory reset using the reset button through the pinhole

We recommend that you back up the log files and configuration of the device before you continue with the factory reset.

1. Insert a paper clip (or similar) into the pinhole. Press and hold the recessed reset button until the screen turns black (approximately 10 seconds). Then, release the button.
2. Wait while the device reverts to the default factory settings. When finished, the device restarts automatically. This may take a few minutes.

When the device has been successfully reset to factory settings, the Setup assistant starts with the *Welcome* screen.

i See the illustrations to find the recessed reset button for the different products.

The button can be quite difficult to use. You should feel the button go down when pushed.

Room 55 Dual and Room 70

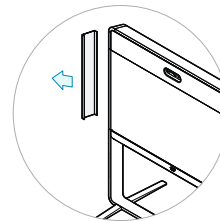

Remove the left side cover of the device to get access to the codec connector panel. The cover snaps to magnets.

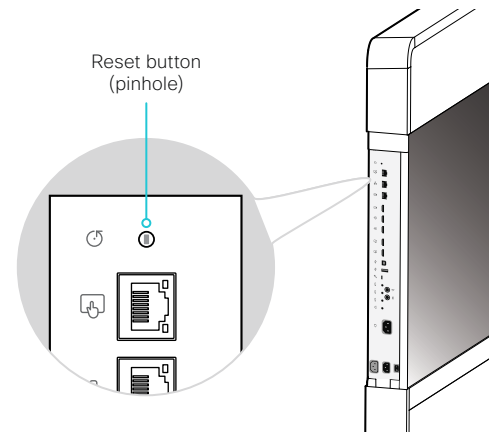

Room 70 G2 and Room 70 Panorama

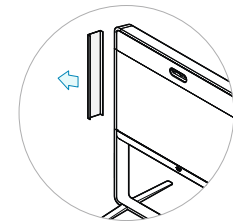

Remove the left side cover of the device to get access to the codec connector panel. The cover snaps to magnets.

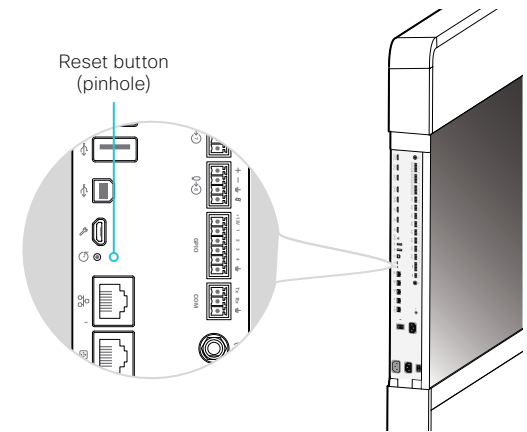

Board

Board Pro

Codec EQ

Codec Plus

Codec Pro

Desk, Desk Pro, DeskMini

Room Bar

Room Kit

Room Kit Mini

Room 55

Room 55 Dual, Room 70

Room 70 G2

Room 70 Panorama

Room Panorama

Factory reset the video conferencing device (page 3 of 5)

Codec EQ

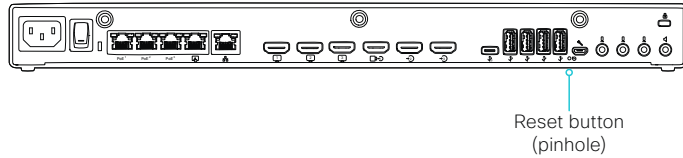

Codec Plus

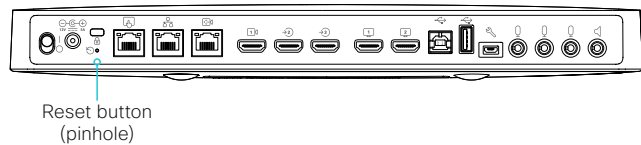

Codec Pro and Room Panorama

For Room Panorama:

- Use the handle at the bottom of the deco grille, and pull down the left screen to get access to the codec.

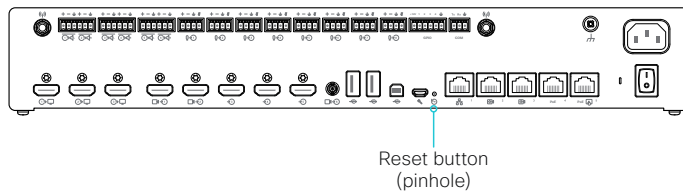

Room 55

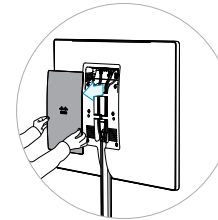

Remove the rear cover to get access to the connector panel.

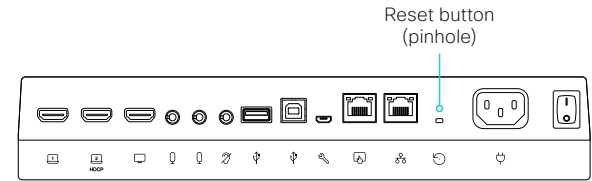

Board

Board Pro

Codec EQ

Codec Plus

Codec Pro

Desk, Desk Pro, DeskMini

Room Bar

Room Kit

Room Kit Mini

Room 55

Room 55 Dual, Room 70

Room 70 G2

Room 70 Panorama

Room Panorama

Factory reset the video conferencing device (page 4 of 5)

Room Bar

Tilt the unit forward to get access to the connector panel.

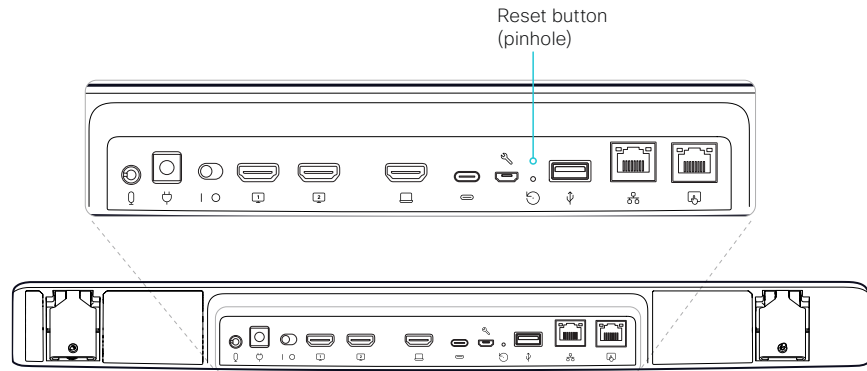

Room Kit

Tilt the unit forward to get access to the connector panel.

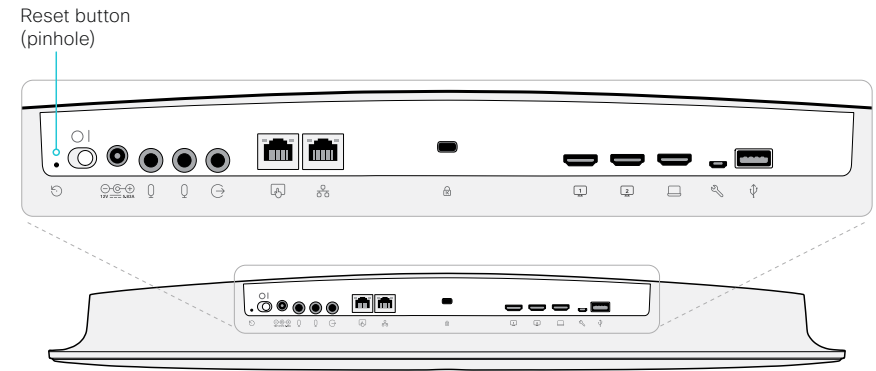

Room Kit Mini

Tilt the unit forward to get access to the connector panel.

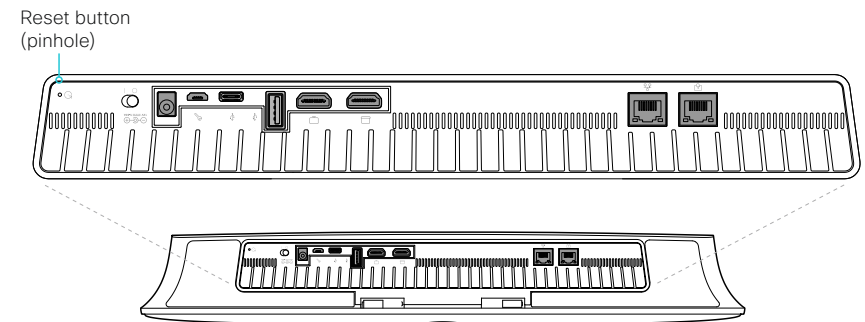

Board

Board Pro

Codec EQ

Codec Plus

Codec Pro

Desk, Desk Pro, Desk Mini

Room Bar

Room Kit

Room Kit Mini

Room 55

Room 55 Dual, Room 70

Room 70 G2

Room 70 Panorama

Room Panorama

Factory reset the video conferencing device (page 5 of 5)

Desk and Desk Pro

Flip the cover on the back of the device to get access to the connector panel.

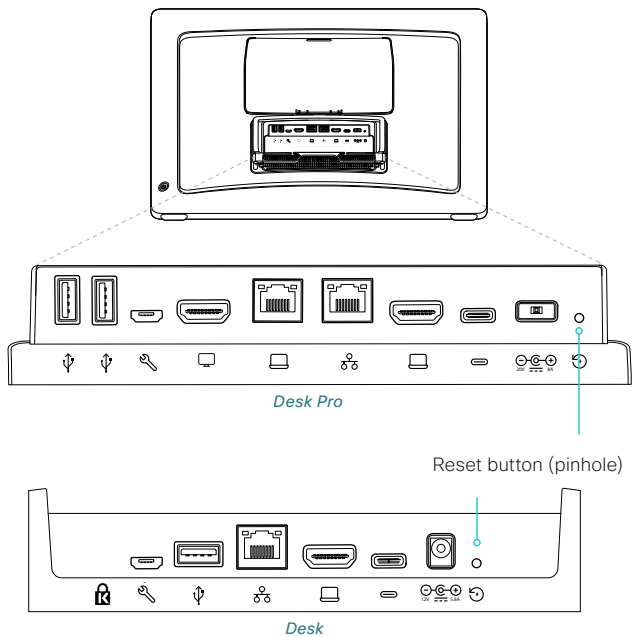

Desk Mini

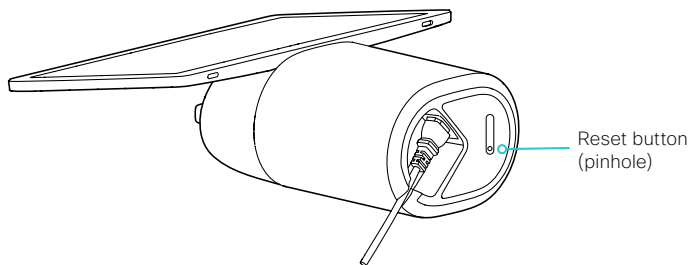

Board

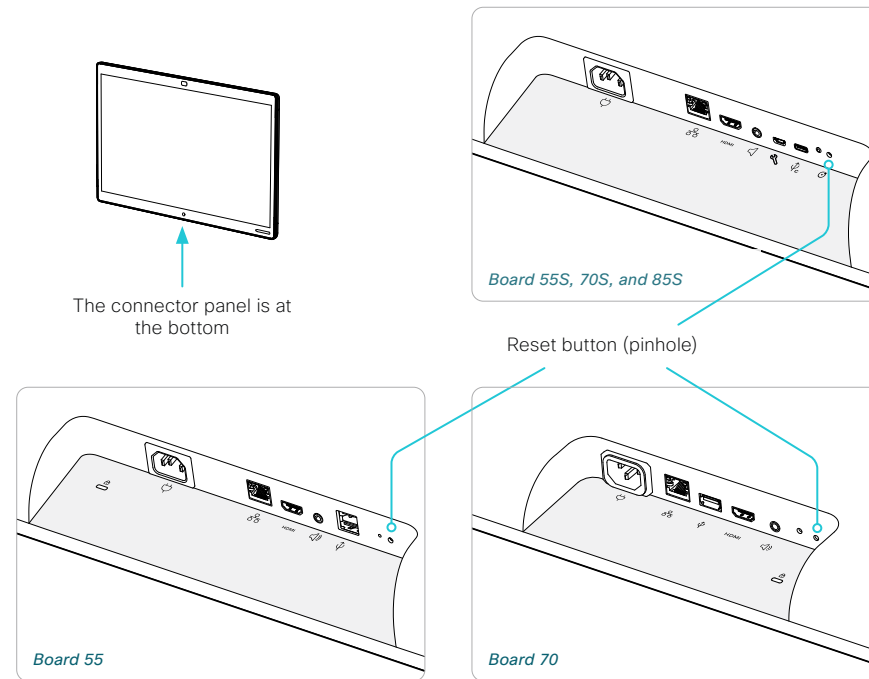

Board Pro

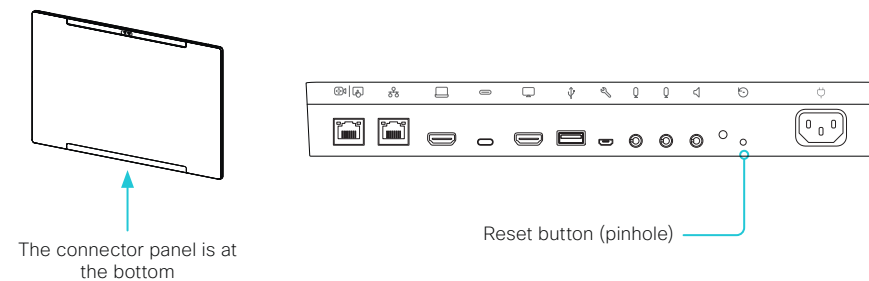

Board

Board Pro

Codec EQ

Codec Plus

Codec Pro

Desk, Desk Pro, Desk Mini

Room Bar

Room Kit

Room Kit Mini

Room 55

Room 55 Dual, Room 70

Room 70 G2

Room 70 Panorama

Room Panorama

Factory reset Cisco Webex Room Navigator

In an error situation it may be required to factory reset the touch controller to recover connectivity.

When factory resetting the touch controller the pairing information is lost, and the touch controller itself (not the video conferencing device) is reverted to factory defaults.



It is not possible to undo a factory reset.

1. Remove the foot to find the reset button (pinhole) on the connector panel.
2. Use a paper clip (or similar) to press and hold the recessed reset button until the screen turns black (approximately 10 seconds). Then release the button.
3. Wait while the Room Navigator reverts to the default factory settings. When finished, the Room Navigator restarts automatically. This may take a few minutes.

If the Room Navigator is directly connected to the video conferencing device, it receives a new configuration automatically from the device.

If the Room Navigator is connected via LAN, it must be paired to the video conferencing device anew. When successfully paired it receives a new configuration automatically from the device.

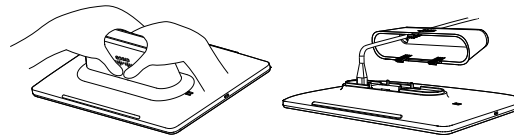

Press firmly and pivot to remove the table stand.

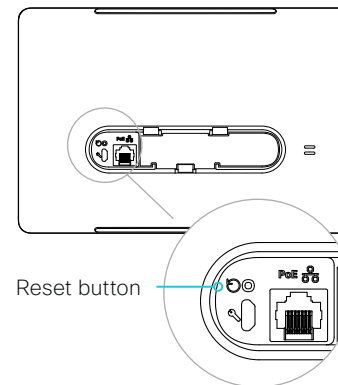

Board

Board Pro

Codec EQ

Codec Plus

Codec Pro

Desk, Desk Pro, Desk Mini

Room Bar

Room Kit

Room Kit Mini

Room 55

Room 55 Dual, Room 70

Room 70 G2

Room 70 Panorama

Room Panorama

Factory reset Touch 10

In an error situation it may be required to factory reset the touch controller to recover connectivity.

Cisco Touch 10

1. Open the small cover at the rear to find the reset button.
2. Press and hold the reset button until the mute button at the front starts blinking (approximately 5 seconds). Then release the button.

Touch 10 automatically reverts to the default factory settings and restarts.

If Touch 10 is directly connected to the video conferencing device, it receives a new configuration automatically from the device.

If Touch 10 is connected via LAN, it must be paired to the video conferencing device anew. When successfully paired it receives a new configuration automatically from the device.

When factory resetting the touch controller the pairing information is lost, and the touch controller itself (not the video conferencing device) is reverted to factory defaults.



It is not possible to undo a factory reset.

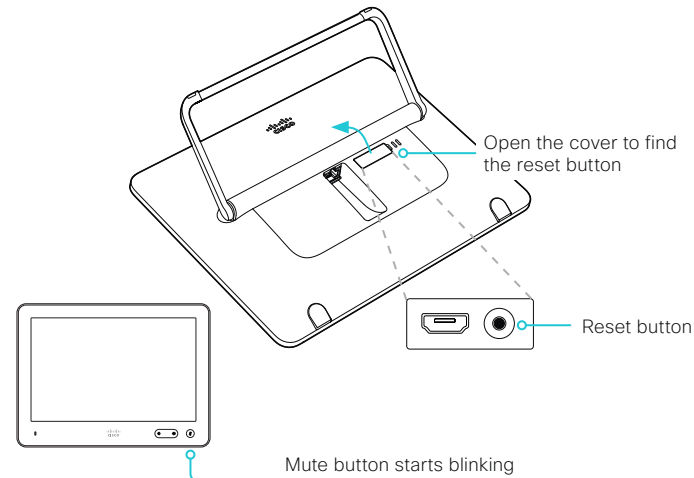

Cisco TelePresence Touch 10

1. Locate the *Mute* and *Volume down* buttons.
2. Press and hold the *Mute* button until it starts blinking (red and green). It takes approximately 10 seconds.
3. Press the *Volume down* button twice.

Touch 10 automatically reverts to the default factory settings and restarts.

If Touch 10 is directly connected to the video conferencing device, it receives a new configuration automatically from the device.

If Touch 10 is connected via LAN, it must be paired to the video conferencing device anew. When successfully paired it receives a new configuration automatically from the device.

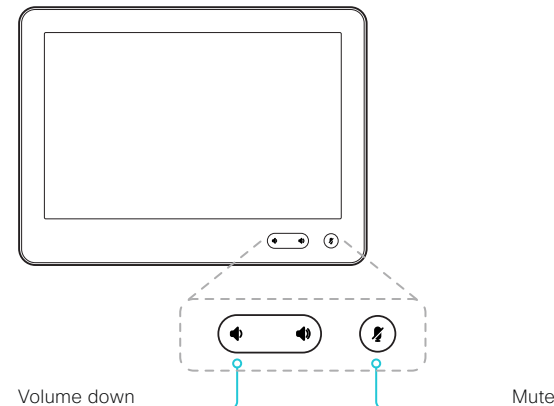

Two Touch 10 versions

There are two versions of the Touch 10. They look almost the same and has the same functionality.

- *Cisco TelePresence Touch 10*: This is the first version. It has no logo on front.
- *Cisco Touch 10*: This version was launched late 2017. It is identified by the logo on front, and fewer connectors at the back.

Board

Board Pro

Codec EQ

Codec Plus

Codec Pro

Desk, Desk Pro, Desk Mini

Room Bar

Room Kit

Room Kit Mini

Room 55

Room 55 Dual, Room 70

Room 70 G2

Room 70 Panorama

Room Panorama

Factory reset Cisco Natural Audio Module IV

In an error situation it may be required to factory reset the amplifier.

 It is not possible to undo a factory reset.

We recommend that you back up the log files and configuration of the device before you continue with the factory reset.

1. Insert a paper clip (or similar) into the pinhole. Press and hold the recessed reset button until the screen turns black (approximately 10 seconds). Then, release the button.
2. Wait while the device reverts to the default factory settings. When finished, the device restarts automatically. This may take a few minutes.

When the device has been successfully reset to factory settings, the Setup assistant starts with the *Welcome* screen.

 The button can be quite difficult to use. You should feel the button move when pressed.

Amplifier: Cisco Natural Audio Module IV

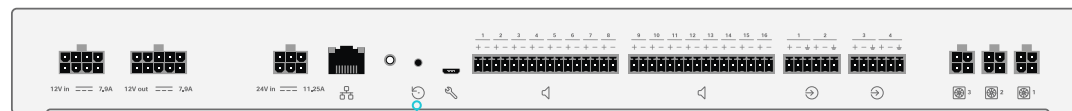

Reset button (pinhole)

Board

Board
ProCodec
EQCodec
PlusCodec
ProDesk,
Desk Pro,
DeskMiniRoom
Bar

Room Kit

Room Kit
Mini

Room 55

Room
55 Dual,
Room 70Room 70
G2Room 70
PanoramaRoom
Panorama

Factory reset Table Microphone Pro

Note: The same as Cisco Microphone Array.

In an error situation it may be required to factory reset the microphone.



It is not possible to undo a factory reset.

We recommend that you back up the log files and configuration of the device before you continue with the factory reset.

1. Insert a paper clip (or similar) into the pinhole. Press and hold the recessed reset button until the screen turns black (approximately 10 seconds). Then, release the button.
2. Wait while the device reverts to the default factory settings. When finished, the device restarts automatically. This may take a few minutes.

When the device has been successfully reset to factory settings, the Setup assistant starts with the *Welcome* screen.



The button can be quite difficult to use. You should feel the button move when pressed.

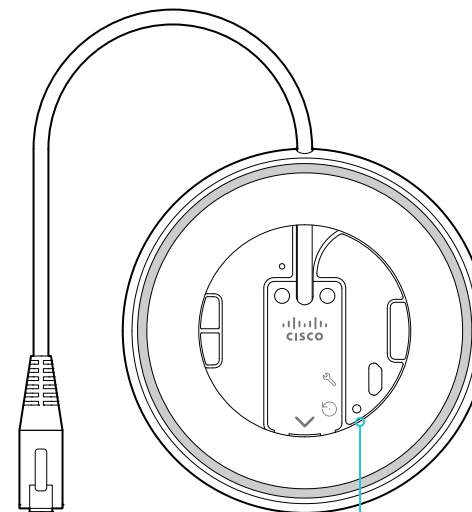

Reset button (pinhole)

- Board
- Board Pro
- Codec EQ
- Codec Plus
- Codec Pro
- Desk, Desk Pro, Desk Mini
- Room Bar
- Room Kit
- Room Kit Mini
- Room 55
- Room 55 Dual, Room 70
- Room 70 G2
- Room 70 Panorama
- Room Panorama

Capture user interface screenshots

Sign in to the device web interface, go to [Issues and Diagnostics](#), and select [User Interface Screenshots](#).

Capture a screenshot

Click [Touch Panel Screenshot](#) to capture a screenshot of the touch controller, or click [OSD screenshot](#) to capture a screenshot of the main screen (on screen display).

The screenshot appears below the *Current Screenshots* card. It may take up to 30 seconds before the screenshot is ready.

All captured screenshots are listed in the *Current Screenshots* card. Click the screenshot ID to display the image.

Wake up the device

Use these buttons to wake up the device from standby.

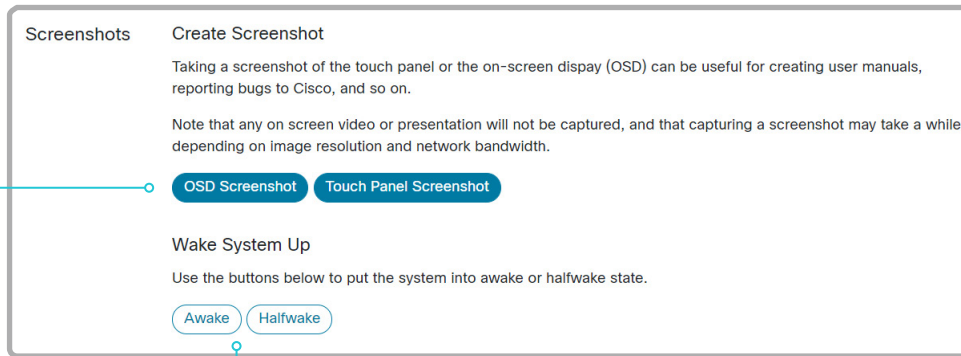

Current Screenshots			
Screenshot ID	Type	Annotation	
Web_2020-10-07 T12:55:55.648Z	Touchpanel		✕
Web_2020-10-07 T12:58:04.744Z	OSD		✕
Remove All			

Delete screenshots

If you want to delete all screenshots, click [Remove All](#).

To delete just one screenshot, click the button for that screenshot.

About user interface screenshots

You can capture screenshots both of a touch controller that is connected to a video conferencing device, and of the main screen with menus, indicators and messages (also known as *on-screen display* or *OSD*).

For Desk, Desk Mini, and Desk Pro:

- Only OSD screenshots are available.

Board

Board
Pro

Codec
EQ

Codec
Plus

Codec
Pro

Desk,
Desk Pro,
Desk Mini

Room
Bar

Room Kit

Room Kit
Mini

Room 55

Room 55
Dual,
Room 70

Room 70
G2

Room 70
Panorama

Room
Panorama

Chapter 5

Device settings

Board

Board Pro

Codec EQ

Codec Plus

Codec Pro

Desk, Desk Pro, Desk Mini

Room Bar

Room Kit

Room Kit Mini

Room 55

Room 55 Dual, Room 70

Room 70 G2

Room 70 Panorama

Room Panorama

Overview of the device settings

In the following pages you find a complete list of the device settings. They can be configured from the device web interface.

Open a web browser, enter the IP address of the device, and sign in. Go to [Settings](#), and select [Configurations](#).



How to find the IP address

1. Swipe in from the right or tap the controls icon  in the upper, right corner to open the control panel. Then select [Device settings](#). *
2. Select [About this room device](#).

App settings	161
Apps WallpaperBundles HalfwakelImage	161
Audio settings	162
Audio DefaultVolume.....	162
Audio Input ARC [n] Mode.....	162
Audio Input Ethernet [n] Channel [1..8] Gain.....	163
Audio Input Ethernet [n] Channel [1..8] Level.....	163
Audio Input Ethernet [n] Channel [1..8] Mode.....	163
Audio Input Ethernet [n] Channel [1..8] Pan.....	163
Audio Input Ethernet [n] EchoControl Mode.....	164
Audio Input Ethernet [n] EchoControl NoiseReduction.....	164
Audio Input Ethernet [n] Equalizer ID	164
Audio Input Ethernet [n] Equalizer Mode	164
Audio Input Ethernet [n] Mode.....	165
Audio Input HDMI [n] Gain	165
Audio Input HDMI [n] Level	165
Audio Input HDMI [n] Mode	165
Audio Input HDMI [n] VideoAssociation MuteOnInactiveVideo	166
Audio Input MicrophoneMode	170
Audio Input Microphone [n] Channel.....	166
Audio Input Microphone [n] EchoControl Dereverberation	167
Audio Input Microphone [n] EchoControl Mode	166
Audio Input Microphone [n] EchoControl NoiseReduction.....	167
Audio Input Microphone [n] Equalizer ID	167
Audio Input Microphone [n] Equalizer Mode	168
Audio Input Microphone [n] Gain.....	169
Audio Input Microphone [n] Level.....	168
Audio Input Microphone [n] Mode.....	169
Audio Input Microphone [n] MuteOverride	169
Audio Input Microphone [n] PhantomPower.....	169
Audio Input Microphone [n] VideoAssociation MuteOnInactiveVideo	170
Audio Input Microphone [n] VideoAssociation VideoInputSource	170
Audio Input USBC [n] Gain	171
Audio Input USBC [n] Level	170
Audio Input USBC [n] Mode	171
Audio Input USBC [n] VideoAssociation MuteOnInactiveVideo	171
Audio Input USBInterface [n] EchoControl Mode	171
Audio Input USBInterface [n] Gain.....	172
Audio Input USBInterface [n] Level	172
Audio Input USBInterface [n] Mode.....	172

* For Room 70 Panorama and Room Panorama: Select the device name or address at the top of the user interface. Then select [Settings](#).

Board

Board Pro

Codec EQ

Codec Plus

Codec Pro

Desk, Desk Pro, Desk Mini

Room Bar

Room Kit

Room Kit Mini

Room 55

Room 55 Dual, Room 70

Room 70 G2

Room 70 Panorama

Room Panorama

Audio Input USBMicrophone [n] EchoControl Mode 172

Audio Input USBMicrophone [n] Level 173

Audio Input WebView [n] Mode 173

Audio Microphones AGC 173

Audio Microphones HdmiPassthrough MuteButton 173

Audio Microphones Mute Enabled 174

Audio Microphones NoiseRemoval Mode 174

Audio Microphones PhantomPower 174

Audio Microphones UsbPassthrough MuteButton 174

Audio Output ARC [n] Delay DelayMs 175

Audio Output ARC [n] Delay Mode 175

Audio Output ARC [n] Mode 175

Audio Output ConnectorSetup 176

Audio Output Ethernet [n] Mode 176

Audio Output HDMI [n] Delay DelayMs 177

Audio Output HDMI [n] Delay Mode 177

Audio Output HDMI [n] Gain 177

Audio Output HDMI [n] Level 177

Audio Output HDMI [n] Mode 178

Audio Output InternalSpeaker Mode 178

Audio Output Line [n] Channel 178

Audio Output Line [n] Delay DelayMs 179

Audio Output Line [n] Delay Mode 179

Audio Output Line [n] Equalizer ID 179

Audio Output Line [n] Equalizer Mode 179

Audio Output Line [n] Gain 180

Audio Output Line [n] Level 180

Audio Output Line [n] Mode 180

Audio Output Line [n] OutputType 181

Audio Output USBInterface [n] Mode 181

Audio Panning HeadsetAnalog BinauralProcessing 182

Audio Panning HeadsetAnalog Mode 182

Audio Panning HeadsetUSB BinauralProcessing 182

Audio Panning HeadsetUSB Mode 182

Audio Panning Mode 181

Audio Placement 182

Audio SoundsAndAlerts RingTone 183

Audio SoundsAndAlerts RingVolume 183

Audio Ultrasound MaxVolume 183

Audio Ultrasound Mode 183

Audio Ultrasound Ru1Protocol 183

Audio Ultrasound RzssProtocol 184

Audio USB Mode 184

Bluetooth settings 185

Bluetooth Allowed 185

Bluetooth Enabled 185

Bookings settings 185

Bookings ProtocolPriority 185

BYOD settings 186

BYOD HidForwarding Enabled 186

BYOD QRCodePairing 186

BYOD TouchForwarding Enabled 186

BYOD USBCXapi 186

CallHistory settings 187

CallHistory Mode 187

CallHistory Recents DisplayName 187

Cameras settings 187

Cameras Background Enabled 187

Cameras Background UserImagesAllowed 187

Cameras Camera ExposureCompensation Level 190

Cameras Camera Framerate 194

Cameras Camera [n] AssignedSerialNumber 188

Cameras Camera [n] Backlight DefaultMode 188

Cameras Camera [n] Brightness Algorithm 189

Cameras Camera [n] Brightness DefaultLevel 189

Cameras Camera [n] Brightness Mode 189

Cameras Camera [n] Flip 191

Cameras Camera [n] Focus Mode 191

Cameras Camera [n] Gamma Level 192

Cameras Camera [n] Gamma Mode 192

Cameras Camera [n] IrCutFilter Mode 190

Cameras Camera [n] IrCutFilter Threshold 190

Cameras Camera [n] Mirror 193

Cameras Camera [n] Whitebalance Level 193

Cameras Camera [n] Whitebalance Mode 193

Cameras PowerLine Frequency 194

Cameras PresenterTrack CameraPosition Pan 194

Cameras PresenterTrack CameraPosition Tilt 194

Cameras PresenterTrack CameraPosition Zoom 194

Cameras PresenterTrack Connector 195

Board

Board Pro

Codec EQ

Codec Plus

Codec Pro

Desk, Desk Pro, Desk Mini

Room Bar

Room Kit

Room Kit Mini

Room 55

Room 55 Dual, Room 70

Room 70 G2

Room 70 Panorama

Room Panorama

Cameras PresenterTrack Enabled.....	195
Cameras PresenterTrack PresenterDetectedStatus	195
Cameras PresenterTrack TriggerZone	195
Cameras SpeakerTrack Closeup.....	197
Cameras SpeakerTrack ConnectorDetection CameraLeft.....	198
Cameras SpeakerTrack ConnectorDetection CameraRight.....	198
Cameras SpeakerTrack ConnectorDetection Mode	198
Cameras SpeakerTrack DefaultBehavior.....	196
Cameras SpeakerTrack Frames Mode.....	196
Cameras SpeakerTrack Mode.....	197
Cameras SpeakerTrack TrackingMode	197
Cameras SpeakerTrack Whiteboard Mode	198
Conference settings	199
Conference ActiveControl Mode	199
Conference AutoAnswer Delay.....	199
Conference AutoAnswer Mode	199
Conference AutoAnswer Mute	199
Conference CallProtocolIPStack.....	199
Conference CapsetFilter	200
Conference DefaultCall Protocol	200
Conference DefaultCall Rate.....	200
Conference DefaultCall Webex Rate	200
Conference DoNotDisturb DefaultTimeout	201
Conference EmbeddedApp NotificationsOnly.....	201
Conference Encryption Mode.....	201
Conference EndToEndEncryption Identity PreferredDomain.....	201
Conference EndToEndEncryption Mode.....	202
Conference FarEndControl Mode.....	202
Conference FarEndControl SignalCapability.....	202
Conference FarendMessage Mode	202
Conference IncomingMultisiteCall Mode	205
Conference JoinLeaveNotifications	202
Conference MaxMultisiteReceiveRate	203
Conference MaxMultisiteTransmitRate	204
Conference MaxReceiveCallRate	203
Conference MaxTransmitCallRate.....	203
Conference MicUnmuteOnDisconnect Mode.....	204
Conference Multipoint Mode	204
Conference MultiStream Mode.....	205
Conference PeopleFocus OnCall Mode	205

Conference Presentation OnPlacedOnHold	205
Conference Presentation RelayQuality	206
FacilityService settings	206
FacilityService Service [n] CallType	206
FacilityService Service [n] Name	206
FacilityService Service [n] Number.....	207
FacilityService Service [n] Type	207
Files settings.....	207
Files Services OneDrive TemporaryPersonalSignIn	207
GPIO settings.....	208
GPIO Pin [n] Mode.....	208
H323 settings.....	208
H323 Authentication LoginName	208
H323 Authentication Mode	208
H323 Authentication Password	209
H323 CallSetup Mode.....	209
H323 Encryption AES256Support	209
H323 Encryption KeySize.....	209
H323 Gatekeeper Address	209
H323 H323Alias E164	210
H323 H323Alias ID.....	210
H323 NAT Address	211
H323 NAT Mode	210
H323 PortAllocation.....	211
HttpClient settings	211
HttpClient AllowHTTP	211
HttpClient AllowInsecureHTTPS	212
HttpClient Mode.....	211
HttpClient UseHttpProxy.....	212
HttpFeedback settings.....	212
HttpFeedback TlsVerify.....	212
HttpFeedback UseHttpProxy	213
Logging settings	213
Logging CloudUpload Mode.....	213
Logging Debug Bluetooth	213
Logging Debug Wifi	214
Logging External Mode.....	214
Logging External Protocol.....	214

Board

Board Pro

Codec EQ

Codec Plus

Codec Pro

Desk, Desk Pro, Desk Mini

Room Bar

Room Kit

Room Kit Mini

Room 55

Room 55 Dual, Room 70

Room 70 G2

Room 70 Panorama

Room Panorama

Logging External Server Address	214
Logging External Server Port	214
Logging External TlsVerify	215
Logging Internal Mode	215
Logging Mode	215
Macros settings	216
Macros AutoStart	216
Macros Diagnostics JavascriptErrors	216
Macros Mode	216
Macros QuickJSEngine	216
Macros UnresponsiveTimeout	216
Macros XAPI Transport	217
Network settings	217
Network [n] DNS DNSSEC Mode	217
Network [n] DNS Domain Name	217
Network [n] DNS Server [m] Address	218
Network [n] IEEE8021X AnonymouIdentity	219
Network [n] IEEE8021X Eap Md5	219
Network [n] IEEE8021X Eap Peap	220
Network [n] IEEE8021X Eap Tls	220
Network [n] IEEE8021X Eap Ttls	220
Network [n] IEEE8021X Identity	219
Network [n] IEEE8021X Mode	218
Network [n] IEEE8021X Password	219
Network [n] IEEE8021X TlsVerify	218
Network [n] IEEE8021X UseClientCertificate	218
Network [n] IPStack	220
Network [n] IPv4 Address	221
Network [n] IPv4 Assignment	221
Network [n] IPv4 Gateway	221
Network [n] IPv4 InterfacelIdentifier	221
Network [n] IPv4 SubnetMask	222
Network [n] IPv6 Address	222
Network [n] IPv6 Assignment	222
Network [n] IPv6 DHCPOptions	223
Network [n] IPv6 Gateway	222
Network [n] IPv6 InterfacelIdentifier	223
Network [n] MTU	223
Network [n] QoS Diffserv Audio	224
Network [n] QoS Diffserv Data	224

Network [n] QoS Diffserv ICMPv6	225
Network [n] QoS Diffserv NTP	225
Network [n] QoS Diffserv Signalling	224
Network [n] QoS Diffserv Video	224
Network [n] QoS Mode	223
Network [n] RemoteAccess Allow	225
Network [n] Speed	225
Network [n] TrafficControl Mode	226
Network [n] VLAN Voice Mode	226
Network [n] VLAN Voice VlanId	226
NetworkServices settings	227
NetworkServices CDP Mode	227
NetworkServices H323 Mode	227
NetworkServices HTTP Mode	227
NetworkServices HTTP Proxy LoginName	227
NetworkServices HTTP Proxy Mode	228
NetworkServices HTTP Proxy PACUrl	228
NetworkServices HTTP Proxy Password	228
NetworkServices HTTP Proxy Url	228
NetworkServices HTTPS OCSP Mode	228
NetworkServices HTTPS OCSP URL	229
NetworkServices HTTPS Server MinimumTLSVersion	229
NetworkServices HTTPS StrictTransportSecurity	229
NetworkServices HTTPS VerifyClientCertificate	229
NetworkServices NTP Mode	229
NetworkServices NTP Server [n] Address	230
NetworkServices NTP Server [n] Key	230
NetworkServices NTP Server [n] KeyAlgorithm	230
NetworkServices NTP Server [n] KeyId	230
NetworkServices SIP Mode	231
NetworkServices SMTP From	232
NetworkServices SMTP Mode	231
NetworkServices SMTP Password	232
NetworkServices SMTP Port	231
NetworkServices SMTP Security	232
NetworkServices SMTP Server	231
NetworkServices SMTP Username	232
NetworkServices SNMP CommunityName	232
NetworkServices SNMP Mode	233
NetworkServices SNMP SystemContact	233
NetworkServices SNMP SystemLocation	233

Board

Board Pro

Codec EQ

Codec Plus

Codec Pro

Desk, Desk Pro, Desk Mini

Room Bar

Room Kit

Room Kit Mini

Room 55

Room 55 Dual, Room 70

Room 70 G2

Room 70 Panorama

Room Panorama

NetworkServices SSH AllowPublicKey	234
NetworkServices SSH HostKeyAlgorithm.....	233
NetworkServices SSH Mode	233
NetworkServices UPnP Mode	234
NetworkServices UPnP Timeout	234
NetworkServices Websocket	234
NetworkServices WelcomeText.....	234
NetworkServices Wifi Allowed	235
NetworkServices Wifi Enabled	235
NetworkServices Wifi Settings A_MPDU	235
NetworkServices Wifi Settings FrequencyBand.....	235
NetworkServices XMLAPI Mode	236
Peripherals settings	236
Peripherals ActivePen Enabled.....	236
Peripherals InputDevice Mode.....	236
Peripherals Pairing CiscoTouchPanels EmcResilience	237
Peripherals Pairing CiscoTouchPanels HttpProxy.....	237
Peripherals Pairing CiscoTouchPanels RemotePairing	237
Peripherals Profile Cameras	237
Peripherals Profile Cameras	238
Peripherals Profile ControlSystems	238
Peripherals Profile NetworkSwitches.....	238
Peripherals Profile TouchPanels	238
Phonebook settings	239
Phonebook Server [n] ID	239
Phonebook Server [n] Pagination.....	239
Phonebook Server [n] TlsVerify.....	239
Phonebook Server [n] Type.....	240
Phonebook Server [n] URL.....	240
Provisioning settings.....	240
Provisioning Connectivity.....	240
Provisioning CUCM CallManagementRecords CallDiagnostics.....	240
Provisioning ExternalManager Address	241
Provisioning ExternalManager AlternateAddress.....	241
Provisioning ExternalManager Domain	241
Provisioning ExternalManager Path	241
Provisioning ExternalManager Protocol	241
Provisioning LoginName	242
Provisioning Mode	242
Provisioning Password.....	242

Provisioning TlsVerify	242
Provisioning WebexEdge	243
Proximity settings	243
Proximity AlternatePort Enabled	243
Proximity Mode	244
Proximity Services CallControl	244
Proximity Services ContentShare FromClients.....	244
Proximity Services ContentShare ToClients.....	244
RoomAnalytics settings	245
RoomAnalytics AmbientNoiseEstimation Interval	245
RoomAnalytics AmbientNoiseEstimation Mode.....	245
RoomAnalytics PeopleCountOutOfCall	245
RoomAnalytics PeoplePresenceDetector.....	245
RoomAnalytics ReverberationTime Interval	246
RoomAnalytics ReverberationTime Mode.....	246
RoomAnalytics T3AlarmDetection Mode.....	246
RoomAnalytics T3AlarmDetection Timeout.....	246
RoomCleanup settings.....	247
RoomCleanup AutoRun ContentType TemporaryAccounts	247
RoomCleanup AutoRun ContentType WebData.....	247
RoomCleanup AutoRun ContentType Whiteboards	247
RoomCleanup AutoRun HourOfDay	247
RoomReset settings.....	248
RoomReset Control.....	248
RoomScheduler settings.....	248
RoomScheduler BookingTimeout	248
RoomScheduler Enabled	248
RTP settings.....	249
RTP Ports Range Start.....	249
RTP Ports Range Stop	249
RTP Video Ports Range Start.....	249
RTP Video Ports Range Stop	250
Security settings	250
Security Audit Logging Mode	250
Security Audit OnError Action.....	251
Security Audit Server Address	251
Security Audit Server Port	251
Security Audit Server PortAssignment.....	251

Board

Board Pro

Codec EQ

Codec Plus

Codec Pro

Desk, Desk Pro, Desk Mini

Room Bar

Room Kit

Room Kit Mini

Room 55

Room 55 Dual, Room 70

Room 70 G2

Room 70 Panorama

Room Panorama

Security Fips Mode	252
Security Session FailedLoginsLockoutTime	252
Security Session InactivityTimeout	252
Security Session MaxFailedLogins	252
Security Session MaxSessionsPerUser	252
Security Session MaxTotalSessions	253
Security Session ShowLastLogon	253
Security Xapi WebSocket ApiKey Allowed	253
SerialPort settings	254
SerialPort BaudRate	254
SerialPort LoginRequired	254
SerialPort Mode	254
SIP settings	255
SIP ANAT	255
SIP Authentication Password	255
SIP Authentication UserName	255
SIP DefaultTransport	255
SIP DisplayName	255
SIP Ice DefaultCandidate	256
SIP Ice Mode	256
SIP Line	256
SIP ListenPort	256
SIP Mailbox	257
SIP MinimumTLSVersion	257
SIP PreferredIPSignaling	257
SIP Proxy [n] Address	257
SIP TlsVerify	257
SIP Turn Password	258
SIP Turn Server	258
SIP Turn UserName	258
SIP Type	258
SIP URI	258
Standby settings	259
Standby BootAction	259
Standby Control	259
Standby Delay	259
Standby Halfwake Mode	260
Standby Level Networked Delay	259
Standby Level Networked Mode	260
Standby Signage Audio	260

Standby Signage InteractionMode	260
Standby Signage Mode	261
Standby Signage RefreshInterval	261
Standby Signage Url	261
Standby StandbyAction	261
Standby WakeupAction	262
Standby WakeupAtMeetingStart	262
Standby WakeupOnMotionDetection	262
SystemUnit settings	263
SystemUnit BroadcastName	263
SystemUnit CrashReporting Advanced	263
SystemUnit CrashReporting Mode	263
SystemUnit CrashReporting URL	263
SystemUnit CustomDeviceld	264
SystemUnit Name	263
Time settings	264
Time DateFormat	264
Time OfficeHours Enabled	266
Time OfficeHours OutsideOfficeHours Standby AutoWakeup	266
Time OfficeHours OutsideOfficeHours Standby Delay	266
Time OfficeHours WorkDay End	267
Time OfficeHours WorkDay Start	267
Time OfficeHours WorkWeek Friday	268
Time OfficeHours WorkWeek Monday	267
Time OfficeHours WorkWeek Saturday	268
Time OfficeHours WorkWeek Sunday	268
Time OfficeHours WorkWeek Thursday	267
Time OfficeHours WorkWeek Tuesday	267
Time OfficeHours WorkWeek Wednesday	267
Time TimeFormat	264
Time Zone	265
UserInteraction settings	268
UserInteraction RaiseHand CMS	268
UserInterface settings	269
UserInterface Accessibility IncomingCallNotification	269
UserInterface Assistant Mode	269
UserInterface Assistant ProactiveMeetingJoin	269
UserInterface Bookings Visibility TentativeMeetings	269
UserInterface Bookings Visibility Title	270
UserInterface Branding AwakeBranding Colors	270

Board

Board Pro

Codec EQ

Codec Plus

Codec Pro

Desk, Desk Pro, Desk Mini

Room Bar

Room Kit

Room Kit Mini

Room 55

Room 55 Dual, Room 70

Room 70 G2

Room 70 Panorama

Room Panorama

UserInterface ContactInfo Type	270
UserInterface CustomMessage	270
UserInterface CustomWallpaperOverlay	271
UserInterface Diagnostics Notifications	271
UserInterface Features Call End	271
UserInterface Features Call HdmiPassthrough	271
UserInterface Features Call JoinGoogleMeet	271
UserInterface Features Call JoinWebex	272
UserInterface Features Call JoinZoom	272
UserInterface Features Call Keypad	272
UserInterface Features Call LayoutControls	272
UserInterface Features Call MidCallControls	272
UserInterface Features Call MusicMode	273
UserInterface Features Call ParticipantList	273
UserInterface Features Call SelfviewControls	273
UserInterface Features Call Start	273
UserInterface Features Call VideoMute	273
UserInterface Features Call Webcam	273
UserInterface Features Files Start	274
UserInterface Features HideAll	274
UserInterface Features Share Start	274
UserInterface Features Whiteboard Start	274
UserInterface Help Tips	275
UserInterface HomeScreen Dashboard	275
UserInterface HomeScreen Peripherals WebApp URL	275
UserInterface KeyTones Mode	275
UserInterface Kiosk Mode	276
UserInterface Kiosk URL	276
UserInterface Language	276
UserInterface LedControl Mode	276
UserInterface MuteWarning	277
UserInterface NameAndSiteLabels Mode	277
UserInterface OSD EncryptionIndicator	277
UserInterface OSD HalfwakeMessage	277
UserInterface OSD Mode	278
UserInterface OSD Output	278
UserInterface Phonebook DefaultSearchFilter	279
UserInterface Phonebook Mode	279
UserInterface Proximity Notifications	279
UserInterface RoomScheduler AmbientTemperature Show	279
UserInterface RoomScheduler PeopleCount Current	280

UserInterface RoomScheduler StatusWhenInUse	280
UserInterface Security Mode	280
UserInterface SettingsMenu Mode	280
UserInterface SettingsMenu Visibility	281
UserInterface SoundEffects Mode	281
UserInterface Theme Name	281
UserInterface UsbPromotion	281
UserInterface Wallpaper	281
UserInterface WebcamOnlyMode	281
UserInterface Whiteboard ActivityIndicators	282
UserInterface Whiteboard DefaultTheme	282

UserManagement settings 282

UserManagement LDAP Admin Filter	282
UserManagement LDAP Admin Group	282
UserManagement LDAP Attribute	283
UserManagement LDAP BaseDN	283
UserManagement LDAP Encryption	283
UserManagement LDAP MinimumTLSVersion	283
UserManagement LDAP Mode	284
UserManagement LDAP Server Address	284
UserManagement LDAP Server Port	284
UserManagement LDAP VerifyServerCertificate	284
UserManagement PasswordPolicy Complexity MinimumDigits	285
UserManagement PasswordPolicy Complexity MinimumLength	285
UserManagement PasswordPolicy Complexity MinimumLowercase	285
UserManagement PasswordPolicy Complexity MinimumSpecial	285
UserManagement PasswordPolicy Complexity MinimumUppercase	286
UserManagement PasswordPolicy MaxLifetime	286
UserManagement PasswordPolicy ReuseLimit	286

Video settings 287

Video ActiveSpeaker DefaultPIPPosition	287
Video DefaultLayoutFamily Local	287
Video DefaultLayoutFamily LocalContent	288
Video DefaultLayoutFamily Remote	288
Video DefaultMainSource	289
Video Input AirPlay Beacon	289
Video Input AirPlay DiscoveryInstructions NetworkName	289
Video Input AirPlay DiscoveryInstructions ShowNetworkInfo	289
Video Input AirPlay Mode	290
Video Input AirPlay Password	290

Board

Board Pro

Codec EQ

Codec Plus

Codec Pro

Desk, Desk Pro, Desk Mini

Room Bar

Room Kit

Room Kit Mini

Room 55

Room 55 Dual, Room 70

Room 70 G2

Room 70 Panorama

Room Panorama

Video Input AirPlay SecurityMode	290
Video Input Connector [n] CameraControl Camerald	290
Video Input Connector [n] CameraControl Mode	291
Video Input Connector [n] CEC Mode	291
Video Input Connector [n] HDCP Mode	292
Video Input Connector [n] InputSourceType	292
Video Input Connector [n] Name	293
Video Input Connector [n] OptimalDefinition Profile	293
Video Input Connector [n] OptimalDefinition Threshold60fps	294
Video Input Connector [n] PreferredResolution	294
Video Input Connector [n] PresentationSelection	295
Video Input Connector [n] Quality	295
Video Input Connector [n] RGBQuantizationRange	296
Video Input Connector [n] Visibility	296
Video Input Miracast Mode	297
Video Input Miracast Pin Length	297
Video Monitors	298
Video Output Connector [n] Brightness	298
Video Output Connector [n] BrightnessMode	298
Video Output Connector [n] CEC Mode	299
Video Output Connector [n] HDCPPolicy	299
Video Output Connector [n] Location HorizontalOffset	300
Video Output Connector [n] Location VerticalOffset	300
Video Output Connector [n] MonitorRole	301
Video Output Connector [n] Resolution	301
Video Output Connector [n] RGBQuantizationRange	302
Video Output Connector [n] Whitebalance Level	304
Video Output HDMI Passthrough Allowed	302
Video Output HDMI Passthrough AutoDisconnect Delay	303
Video Output HDMI Passthrough AutoDisconnect Enabled	303
Video Output HDMI Passthrough HdmiUsbConverter Mode	302
Video Output HDMI Passthrough HdmiUsbConverter Name	303
Video Output HDMI Passthrough OutputConnector	303
Video Output Webcam USBMode	304
Video Presentation DefaultPIPPosition	304
Video Presentation DefaultSource	304
Video Presentation Priority	305
Video Selfview Default FullscreenMode	305
Video Selfview Default Mode	305
Video Selfview Default OnMonitorRole	305
Video Selfview Default PIPPosition	306

Video Selfview OnCall Duration	306
Video Selfview OnCall Mode	306

VoiceControl settings	307
VoiceControl Wakeword Mode	307

WebEngine settings	308
WebEngine Features LocalWebAppManagement	308
WebEngine Features SipUrlHandler	308
WebEngine Features WebGL	308
WebEngine Features Xapi Peripherals AllowedHosts Hosts	308
WebEngine FpsCounter	309
WebEngine MinimumTLSVersion	309
WebEngine Mode	309
WebEngine RemoteDebugging	309
WebEngine UseHttpProxy	309

Webex settings	310
Webex CloudProximity GuestShare	310
Webex CloudProximity Mode	310
Webex CloudUpgrades Mode	310
Webex Hotdesking DefaultBookingEndTime	310
Webex Meetings JoinProtocol	311

WebRTC settings	312
WebRTC EndCallTimeout	312
WebRTC InteractionMode	312
WebRTC Provider MicrosoftTeams CompatibilityMode	312

Zoom settings	313
Zoom DefaultDomain	313
Zoom DialStringOptions	313

Experimental settings	314
------------------------------------	------------

Board

Board
ProCodec
EQCodec
PlusCodec
ProDesk,
Desk Pro,
Desk MiniRoom
Bar

Room Kit

Room Kit
Mini

Room 55

Room 55
Dual,
Room 70Room 70
G2Room 70
PanoramaRoom
Panorama**Software version:**

- RoomOS 11.1.2

Products covered:

- CodecEQ
- CodecPro
- CodecPlus
- Room70G2
- Room70/Room55D
- Room55
- RoomBar
- RoomKit
- RoomKitMini
- RoomPanorama/Room70Panorama
- DeskMini
- Desk
- DeskPro
- Board
- BoardPro

App settings

Apps WallpaperBundles HalfwakeImage

Applies to: All products

Requires user role: ADMIN

In some scenarios, for example when UserInterface Theme Name is set to Night, a colored background will show in halfwake mode. You can turn it off with this setting, to always use a black background.

Default value:

Auto

Value space:

Auto/Off

Auto: The background is colored in halfwake mode in some scenarios.

Off: The background is black in halfwake mode.

Board

Board
ProCodec
EQCodec
PlusCodec
ProDesk,
Desk Pro,
Desk MiniRoom
Bar

Room Kit

Room Kit
Mini

Room 55

Room 55
Dual,
Room 70Room 70
G2Room 70
PanoramaRoom
Panorama

Audio settings

Audio DefaultVolume

Applies to: All products

Requires user role: ADMIN, INTEGRATOR, USER

Define the default volume for the speakers. For all devices except the Desk series, the volume is set to this level when you switch on the device or restart it. Desk devices remember the last audio level set by the user also after a restart.

You can use the controls on the user interface or the Audio Volume commands to change the volume both in call and out of call. The Audio Volume SetToDefault command resets the volume to the default value.

Default value:

50 [[RoomKit](#) [RoomKitMini](#) [RoomBar](#) [CodecEQ](#) [CodecPlus](#) [CodecPro](#) [Room55](#) [Room70/Room55D](#) [Room70G2](#) [RoomPanorama/Room70Panorama](#) [DeskMini](#) [Desk](#) [DeskPro](#)]
70 [[Board](#) [BoardPro](#)]

Value space:

Integer (0..100)

Range: Select a value between 1 and 100. This corresponds to the dB range from -34.5 dB to 15 dB, in steps of 0.5 dB. If set to 0 the audio is switched off.

Audio Input ARC [n] Mode

Applies to: CodecPlus CodecPro Room70G2 RoomPanorama/Room70Panorama

Requires user role: ADMIN, INTEGRATOR

Each HDMI output has an associated audio return channel (ARC). You can use the ARC to send audio from a screen or TV, which is connected to the HDMI output, to the video conferencing device. You can decide for each HDMI output connector (n) separately, whether or not to allow audio transmission.

Default value:

On

Value space:

Off/On

Off: Disable the ARC channel of HDMI output n (audio is not sent to the video conferencing device).

On: Enable the ARC channel of HDMI output n (audio is sent to the video conferencing device).

n: Unique ID that identifies the ARC input.

Range: 1..2 [[CodecPlus](#)]

Range: 1..3 [[CodecPro](#)]

Range: 3..3 for Room 70 Dual G2; 2..3 for Room 70 Single G2 [[Room70G2](#)]

Range: 3..3 [[RoomPanorama/Room70Panorama](#)]

Board

Board
ProCodec
EQCodec
PlusCodec
ProDesk,
Desk Pro,
Desk MiniRoom
Bar

Room Kit

Room Kit
Mini

Room 55

Room 55
Dual,
Room 70Room 70
G2Room 70
PanoramaRoom
Panorama

Audio Input Ethernet [n] Channel [1..8] Level

Applies to: CodecPro Room70G2 RoomPanorama/Room70Panorama

Requires user role: ADMIN, INTEGRATOR

Set the gain for the specified channel of an Ethernet input, e.g. a microphone or audio interface. We allow up to 8 channels per input, and the gain is set separately for each channel.

The gain should be adjusted to suit the output level of the connected audio source. The gain can be tuned in steps of 1 dB. If the gain is set too high, the audio signal will be clipped. If the gain is set too low, the audio signal-to-noise ratio will be degraded; however, this is usually preferable to clipping. Note that unprocessed speech signals typically contain significant level variations, making it very important to allow for sufficient signal headroom.

Default value:

45

Value space:

Integer (0..70)

Range: Select the gain in decibel (dB).

n: Unique ID that identifies the logical Ethernet input.

Range: 1..4 [[CodecPro Room70G2](#)]

Range: 1..6 [[RoomPanorama/Room70Panorama](#)]

Audio Input Ethernet [n] Channel [1..8] Gain

Applies to: CodecEQ

Requires user role: ADMIN, INTEGRATOR

Set the gain for the specified channel of an Ethernet input, e.g. a microphone or audio interface. We allow up to 8 channels per input, and the gain is set separately for each channel.

The gain should be adjusted to suit the output level of the connected audio source. The gain can be tuned in steps of 1 dB. If the gain is set too high, the audio signal will be clipped. If the gain is set too low, the audio signal-to-noise ratio will be degraded; however, this is usually preferable to clipping. Note that unprocessed speech signals typically contain significant level variations, making it very important to allow for sufficient signal headroom.

Default value:

45

Value space:

Integer (0..70)

Range: Select the gain in decibel (dB).

n: Unique ID that identifies the logical Ethernet input.

Range: 1..8

Audio Input Ethernet [n] Channel [1..8] Mode

Applies to: CodecEQ CodecPro Room70G2 RoomPanorama/Room70Panorama

Requires user role: ADMIN, INTEGRATOR

Disable or enable audio on the specified channel of an Ethernet input. We allow up to 8 channels per input, and the mode is set separately for each channel.

Setting Audio Input Ethernet [n] Mode to Off will override the effect of the individual channel mode settings.

Default value:

On

Value space:

Off/On

Off: Disable audio from this channel.

On: Enable audio from this channel.

n: Unique ID that identifies the logical Ethernet input.

Range: 1..4 [[CodecPro Room70G2](#)]

Range: 1..6 [[RoomPanorama/Room70Panorama](#)]

Range: 1..8 [[CodecEQ](#)]

Audio Input Ethernet [n] Channel [1..8] Pan

Applies to: CodecEQ CodecPro Room70G2 RoomPanorama/Room70Panorama

Requires user role: ADMIN, INTEGRATOR

Set which mix channel (left or right) this input channel is mixed to. For a single channel mix this setting has no effect.

Default value:

Mono

Value space:

Left/Right/Mono

Left: Pan to the left mix channel.

Right: Pan to the right mix channel

Mono: Pan equally to both the left and right channel.

n: Unique ID that identifies the logical Ethernet input.

Range: 1..4 [[CodecPro Room70G2](#)]

Range: 1..6 [[RoomPanorama/Room70Panorama](#)]

Range: 1..8 [[CodecEQ](#)]

Board

Board
ProCodec
EQCodec
PlusCodec
ProDesk,
Desk Pro,
Desk MiniRoom
Bar

Room Kit

Room Kit
Mini

Room 55

Room 55
Dual,
Room 70Room 70
G2Room 70
PanoramaRoom
Panorama

Audio Input Ethernet [n] EchoControl Mode

Applies to: CodecEQ CodecPro Room70G2 RoomPanorama/Room70Panorama

Requires user role: ADMIN, INTEGRATOR

The echo canceller continuously adjusts itself to the audio characteristics of the room, and compensates for any changes it detects in the audio environment. If the changes in the audio conditions are significant, the echo canceller may take a second or two to re-adjust.

Default value:

On

Value space:

Off/On

Off: Turn off the echo control. Recommended if echo cancellation is performed by external equipment.

On: Turn on the echo control. Recommended, in general, to prevent the far end from hearing their own audio. Once selected, echo cancellation is active at all times.

n: Unique ID that identifies the logical Ethernet input.

Range: 1..4 [[CodecPro Room70G2](#)]

Range: 1..6 [[RoomPanorama/Room70Panorama](#)]

Range: 1..8 [[CodecEQ](#)]

Audio Input Ethernet [n] EchoControl NoiseReduction

Applies to: CodecEQ CodecPro Room70G2 RoomPanorama/Room70Panorama

Requires user role: ADMIN, INTEGRATOR

The video conferencing device has built-in noise reduction, which reduces stationary background noise, for example noise from air-conditioning systems, cooling fans etc. In addition, a high pass filter (Humfilter) reduces very low frequency noise. Noise reduction requires that Audio Input Ethernet [n] EchoControl Mode is enabled.

Default value:

On

Value space:

Off/On

Off: Turn off the noise reduction.

On: Turn on the noise reduction. Recommended in the presence of low frequency noise.

n: Unique ID that identifies the logical Ethernet input.

Range: 1..4 [[CodecPro Room70G2](#)]

Range: 1..6 [[RoomPanorama/Room70Panorama](#)]

Range: 1..8 [[CodecEQ](#)]

Audio Input Ethernet [n] Equalizer ID

Applies to: CodecEQ CodecPro Room70G2 RoomPanorama/Room70Panorama

Requires user role: ADMIN, INTEGRATOR

Select which equalizer preset to apply to this input. If this input has more than one channel, the processing will apply equally to all of them.

Default value:

1

Value space:

Integer (1..8)

The equalizer preset number.

n: Unique ID that identifies the logical Ethernet input.

Range: 1..4 [[CodecPro Room70G2](#)]

Range: 1..6 [[RoomPanorama/Room70Panorama](#)]

Range: 1..8 [[CodecEQ](#)]

Audio Input Ethernet [n] Equalizer Mode

Applies to: CodecEQ CodecPro Room70G2 RoomPanorama/Room70Panorama

Requires user role: ADMIN, INTEGRATOR

Enable or disable the equalization processing for this input.

Default value:

Off

Value space:

Off/On

Off: Do not apply equalization processing.

On: Apply equalization processing.

n: Unique ID that identifies the logical Ethernet input.

Range: 1..4 [[CodecPro Room70G2](#)]

Range: 1..6 [[RoomPanorama/Room70Panorama](#)]

Range: 1..8 [[CodecEQ](#)]

Board

Board
ProCodec
EQCodec
PlusCodec
ProDesk,
Desk Pro,
Desk MiniRoom
Bar

Room Kit

Room Kit
Mini

Room 55

Room 55
Dual,
Room 70Room 70
G2Room 70
PanoramaRoom
Panorama

Audio Input Ethernet [n] Mode

Applies to: CodecEQ CodecPro Room70G2 RoomPanorama/Room70Panorama

Requires user role: ADMIN, INTEGRATOR

Disable or enable audio from this Ethernet input.

If this input has more than one channel, see also the Audio Input Ethernet [n] Channel [1..8] Mode setting.

Default value:

On

Value space:

Off/On

Off: Disable all audio from this input.

On: Enable audio from active channels.

n: Unique ID that identifies the logical Ethernet input.

Range: 1..4 [CodecPro Room70G2]

Range: 1..6 [RoomPanorama/Room70Panorama]

Range: 1..8 [CodecEQ]

Audio Input HDMI [n] Level

Applies to: RoomKit RoomKitMini RoomBar CodecPlus CodecPro Room55 Room70/Room55D Room70G2 RoomPanorama/Room70Panorama Desk DeskPro Board BoardPro

Requires user role: ADMIN, INTEGRATOR

Set the gain on the HDMI input connector. The gain can be tuned in steps of 1 dB.

Default value:

-5

Value space:

Integer (-24..0)

Range: Select the gain in decibel (dB).

n: Unique ID that identifies the HDMI input.

Range: 2..3 [CodecPlus Room70/Room55D]

Range: 1..5 [CodecPro]

Range: 1..1 [RoomKit RoomKitMini RoomBar Desk DeskPro Board BoardPro]

Range: 1..2 [Room55]

Range: 2..5 [Room70G2 RoomPanorama/Room70Panorama]

Audio Input HDMI [n] Gain

Applies to: CodecEQ

Requires user role: ADMIN, INTEGRATOR

Set the gain on the HDMI input connector. The gain can be tuned in steps of 1 dB.

Default value:

-5

Value space:

Integer (-24..0)

Range: Select the gain in decibel (dB).

n: Unique ID that identifies the HDMI input.

Range: 1..3

Audio Input HDMI [n] Mode

Applies to: RoomKit RoomKitMini RoomBar CodecEQ CodecPlus CodecPro Room55 Room70/Room55D Room70G2 RoomPanorama/Room70Panorama Desk DeskPro Board BoardPro

Requires user role: ADMIN, INTEGRATOR

Define if the audio on the HDMI input connector shall be enabled.

Default value:

On

Value space:

Off/On

Off: Disable audio on the HDMI input.

On: Enable audio on the HDMI input.

n: Unique ID that identifies the HDMI input.

Range: 2..3 [CodecPlus Room70/Room55D]

Range: 1..3 [CodecEQ]

Range: 1..5 [CodecPro]

Range: 1..1 [RoomKit RoomKitMini RoomBar Desk DeskPro Board BoardPro]

Range: 1..2 [Room55]

Range: 2..5 [Room70G2 RoomPanorama/Room70Panorama]

Board

Board
ProCodec
EQCodec
PlusCodec
ProDesk,
Desk Pro,
Desk MiniRoom
Bar

Room Kit

Room Kit
Mini

Room 55

Room 55
Dual,
Room 70Room 70
G2Room 70
PanoramaRoom
Panorama

Audio Input HDMI [n] VideoAssociation MuteOnInactiveVideo

Applies to: RoomKit RoomKitMini RoomBar CodecEQ CodecPlus CodecPro Room55 Room70/Room55D Room70G2 RoomPanorama/Room70Panorama Desk DeskPro Board BoardPro

Requires user role: ADMIN, INTEGRATOR

Use this setting to decide whether to stop the audio playback of a connected presentation source if that presentation source is not currently shown on-screen, or to always playback the audio as long as the presentation source is connected.

Default value:

On [RoomKit RoomKitMini RoomBar CodecPlus Room55 Room70/Room55D Desk DeskPro Board BoardPro]

HDMI [1]: Off HDMI [2,3]: On [CodecEQ]

HDMI [1,2]: Off HDMI [3,4,5]: On [CodecPro]

HDMI [2]: Off HDMI [3,4,5]: On [Room70G2 RoomPanorama/Room70Panorama]

Value space:

Off/On

Off: Audio is played, locally and to far end, as long as a presentation source is connected; you do not have to present the HDMI input source.

On: Audio is played, locally and to far end, only when the connected presentation source is shown on-screen.

n: Unique ID that identifies the HDMI input.

Range: 2..3 [CodecPlus Room70/Room55D]

Range: 1..3 [CodecEQ]

Range: 1..5 [CodecPro]

Range: 1..2 [Room55]

Range: 2..5 [Room70G2 RoomPanorama/Room70Panorama]

Range: 1..1 [RoomKit RoomKitMini RoomBar Desk DeskPro Board BoardPro]

Audio Input Microphone [n] Channel

Applies to: CodecPro Room70G2 RoomPanorama/Room70Panorama

Requires user role: ADMIN, INTEGRATOR

Define whether the signal on the microphone input is a mono signal or part of a multichannel signal.

Default value:

Mono

Value space:

Left/Mono/Right

Left: The microphone input signal is the left channel of a stereo signal.

Mono: The microphone input signal is a mono signal.

Right: The microphone input signal is the right channel of a stereo signal.

n: Unique ID that identifies the microphone input.

Range: 1..8

Audio Input Microphone [n] EchoControl Mode

Applies to: RoomKit RoomBar CodecEQ CodecPlus CodecPro Room55 Room70/Room55D Room70G2 RoomPanorama/Room70Panorama BoardPro

Requires user role: ADMIN, INTEGRATOR

The echo canceller continuously adjusts itself to the audio characteristics of the room, and compensates for any changes it detects in the audio environment. If the changes in the audio conditions are significant, the echo canceller may take a second or two to re-adjust.

Default value:

On

Value space:

Off/On

Off: Turn off the echo control. Recommended if echo cancellation is performed by external equipment.

On: Turn on the echo control. Recommended, in general, to prevent the far end from hearing their own audio. Once selected, echo cancellation is active at all times.

n: Unique ID that identifies the microphone input.

Range: 1..8 [CodecPro Room70G2 RoomPanorama/Room70Panorama]

Range: 1..3 [CodecEQ CodecPlus Room70/Room55D]

Range: 2..3 [RoomKit Room55 BoardPro]

Range: 2..2 [RoomBar]

Board

Board
ProCodec
EQCodec
PlusCodec
ProDesk,
Desk Pro,
Desk MiniRoom
Bar

Room Kit

Room Kit
Mini

Room 55

Room 55
Dual,
Room 70Room 70
G2Room 70
PanoramaRoom
Panorama

Audio Input Microphone [n] EchoControl Dereverberation

Applies to: RoomKit RoomBar CodecEQ CodecPlus CodecPro Room55 Room70/Room55D Room70G2 RoomPanorama/Room70Panorama

Requires user role: ADMIN, INTEGRATOR

The video conferencing device has built-in signal processing to reduce the effect of room reverberation. Dereverberation requires that Audio Input Microphone [n] EchoControl Mode is enabled.

Default value:

Off

Value space:

Off/On

Off: Turn off the dereverberation.

On: Turn on the dereverberation.

n: Unique ID that identifies the microphone input.

Range: 1..8 [*CodecPro Room70G2 RoomPanorama/Room70Panorama*]

Range: 1..3 [*CodecEQ CodecPlus Room70/Room55D*]

Range: 2..3 [*RoomKit Room55*]

Range: 2..2 [*RoomBar*]

Audio Input Microphone [n] EchoControl NoiseReduction

Applies to: RoomKit CodecEQ CodecPlus CodecPro Room55 Room70/Room55D Room70G2 RoomPanorama/Room70Panorama BoardPro

Requires user role: ADMIN, INTEGRATOR

The video conferencing device has built-in noise reduction, which reduces stationary background noise, for example noise from air-conditioning systems, cooling fans etc. In addition, a high pass filter (Humfilter) reduces very low frequency noise. Noise reduction requires that Audio Input Microphone [n] EchoControl Mode is enabled.

Default value:

On

Value space:

Off/On

Off: Turn off the noise reduction.

On: Turn on the noise reduction. Recommended in the presence of low frequency noise.

n: Unique ID that identifies the microphone input.

Range: 1..8 [*CodecPro Room70G2 RoomPanorama/Room70Panorama*]

Range: 1..3 [*CodecEQ CodecPlus Room70/Room55D*]

Range: 2..3 [*RoomKit Room55 BoardPro*]

Range: 2..2 [*RoomBar*]

Audio Input Microphone [n] Equalizer ID

Applies to: CodecEQ CodecPro Room70G2 RoomPanorama/Room70Panorama

Requires user role: ADMIN, INTEGRATOR

Select which equalizer preset to apply to this microphone.

Default value:

1

Value space:

Integer (1..8)

The equalizer preset number.

n: Unique ID that identifies the microphone input.

Range: 1..8 [*CodecPro Room70G2 RoomPanorama/Room70Panorama*]

Range: 1..3 [*CodecEQ*]

Board

Board
ProCodec
EQCodec
PlusCodec
ProDesk,
Desk Pro,
Desk MiniRoom
Bar

Room Kit

Room Kit
Mini

Room 55

Room 55
Dual,
Room 70Room 70
G2Room 70
PanoramaRoom
Panorama

Audio Input Microphone [n] Equalizer Mode

Applies to: CodecEQ CodecPro Room70G2 RoomPanorama/Room70Panorama

Requires user role: ADMIN, INTEGRATOR

Enable or disable the equalizer processing for this microphone input.

Default value:

Off

Value space:

Off/On

Off: Do not apply equalization processing.

On: Apply equalization processing.

n: Unique ID that identifies the microphone input.

Range: 1..8 [*CodecPro Room70G2 RoomPanorama/Room70Panorama*]

Range: 1..3 [*CodecEQ*]

Audio Input Microphone [n] Level

Applies to: RoomKit RoomBar CodecPlus CodecPro Room55 Room70/Room55D Room70G2 RoomPanorama/Room70Panorama BoardPro

Requires user role: ADMIN, INTEGRATOR

Set the gain on the Microphone input connector. The gain should be adjusted to suit the output level of the connected audio source. The gain can be tuned in steps of 1 dB.

If the gain is set too high, the audio signal will be clipped. If the gain is set too low, the audio signal-to-noise ratio will be degraded; however, this is usually preferable to clipping.

Note that unprocessed speech signals typically contain significant level variations, making it very important to allow for sufficient signal headroom.

The maximum input level with 0 dB gain depends on the product: -18 dBu (Room Bar, Room Kit, Codec Plus, Room 55, Room 70, Room 55 Dual), 24 dBu (Codec Pro, Room 70 G2).

Example: If your microphone has a maximum output level of -44 dBu, and it is connected to a Codec Pro, then you should set the gain to 24 dBu - (-44 dBu) = 68 dB.

Default value:

14 [*RoomKit RoomBar CodecPlus Room55 Room70/Room55D BoardPro*]

58 [*CodecPro Room70G2 RoomPanorama/Room70Panorama*]

Value space:

Integer (0..24) [*RoomKit RoomBar CodecPlus Room55 Room70/Room55D BoardPro*]

Integer (0..70) [*CodecPro Room70G2 RoomPanorama/Room70Panorama*]

Range: Select the gain in decibel (dB).

n: Unique ID that identifies the microphone input.

Range: 1..8 [*CodecPro Room70G2 RoomPanorama/Room70Panorama*]

Range: 1..3 [*CodecPlus Room70/Room55D*]

Range: 2..3 [*RoomKit Room55 BoardPro*]

Range: 2..2 [*RoomBar*]

Board

Audio Input Microphone [n] Gain

Applies to: [CodecEQ](#)

Requires user role: ADMIN, INTEGRATOR

Set the gain on the Microphone input connector. The gain should be adjusted to suit the output level of the connected audio source. The gain can be tuned in steps of 1 dB.

If the gain is set too high, the audio signal will be clipped. If the gain is set too low, the audio signal-to-noise ratio will be degraded; however, this is usually preferable to clipping.

Note that unprocessed speech signals typically contain significant level variations, making it very important to allow for sufficient signal headroom.

The maximum input level with 0 dB gain is -18 dBu.

Example: If your microphone has a maximum output level of -40 dBu, then you should set the gain to -18 dBu - (-40 dBu) = 22 dB.

Default value:

20

Value space:

Integer (0..24)

Range: Select the gain in decibel (dB).

n: Unique ID that identifies the microphone input.

Range: 1..3

Board Pro

Codec EQ

Codec Plus

Codec Pro

Desk, Desk Pro, Desk Mini

Room Bar

Room Kit

Room Kit Mini

Room 55

Room 55 Dual, Room 70

Room 70 G2

Room 70 Panorama

Room Panorama

D15503.01

RoomOS 11.1

02-2023



Audio Input Microphone [n] MuteOverride

Applies to: [CodecPro](#) [Room70G2](#) [RoomPanorama/Room70Panorama](#)

Requires user role: ADMIN, INTEGRATOR

This setting is only for the analog microphone inputs on Codec Pro.

Configure the microphone input to override the main mute state of the system (that is, the mute state controlled with the ordinary mute button(s)).

This allows for the microphone input to be unmuted and used as a line input for transmitting presentation sounds, etc. during active video input.

Note that the microphone may still be muted if it is associated with an inactive video input and is set to mute on inactive video input.

As an example, if one needs to present audio from an analog source, some of the microphone inputs need to be repurposed as line inputs.

Without MuteOverride, the sound from these presentation sources will go silent if the presenter mutes the microphone(s) during playback of the presentation.

Default value:

Off

Value space:

Off/On

Off: Do not override the mute setting.

On: Override the mute setting.

n: Unique ID that identifies the microphone input.

Range: 1..8

Audio Input Microphone [n] PhantomPower

Applies to: [CodecPro](#) [Room70G2](#) [RoomPanorama/Room70Panorama](#)

Requires user role: ADMIN, INTEGRATOR

Define whether or not to have phantom power (48 V +/- 1 V) on the microphone input.

Default value:

On

Value space:

Off/On

Off: Disable the phantom power on the microphone input. Use this when connecting to equipment that do not need phantom power, such as external mixers.

On: Enable the phantom power on the microphone input. Use this when connecting directly to microphones that require phantom power, including the Cisco Table Microphone and Cisco Ceiling Microphone.

n: Unique ID that identifies the microphone input.

Range: 1..8

Board

Audio Input Microphone [n] VideoAssociation MuteOnInactiveVideo

Applies to: CodecEQ CodecPro Room70G2 RoomPanorama/Room70Panorama

Requires user role: ADMIN, INTEGRATOR

You can associate a microphone with a video input connector, so that the microphone is automatically muted when there is no video stream or content on that video input. Use the Audio Input Microphone [n] VideoAssociation VideoInputSource setting to choose which video input connector to associate the microphone with.

Default value:

Off

Value space:

Off/On

Off: The microphone mute state is independent of the state of the video inputs.

On: The microphone will be automatically muted when there is no video stream or content on the associated video input.

n: Unique ID that identifies the microphone input.

Range: 1..8 [[CodecPro](#) [Room70G2](#) [RoomPanorama/Room70Panorama](#)]

Range: 1..3 [[CodecEQ](#)]

Board Pro

Codec EQ

Codec Plus

Codec Pro

Desk, Desk Pro, Desk Mini

Room Bar

Room Kit

Room Kit Mini

Room 55

Room 55 Dual, Room 70

Room 70 G2

Room 70 Panorama

Room Panorama

Audio Input Microphone [n] VideoAssociation VideoInputSource

Applies to: CodecEQ CodecPro Room70G2 RoomPanorama/Room70Panorama

Requires user role: ADMIN, INTEGRATOR

Select the video input connector to associate the microphone with.

Default value:

1

Value space:

1/2/3/4/5/6 [[CodecPro](#) [Room70G2](#) [RoomPanorama/Room70Panorama](#)]

1/2/3/4 [[CodecEQ](#)]

The video input connector that the microphone is associated with.

n: Unique ID that identifies the microphone input.

Range: 1..8 [[CodecPro](#) [Room70G2](#) [RoomPanorama/Room70Panorama](#)]

Range: 1..3 [[CodecEQ](#)]

Audio Input MicrophoneMode

Applies to: DeskMini Desk DeskPro

Requires user role: ADMIN, INTEGRATOR

If the microphone mode is Focused, the microphones can be combined to focus sound sensitivity. As a result, the noise in the room is suppressed, and you can be heard better when sitting right in front of the device. The voice of people not sitting right in front of the device will be suppressed.

If the microphone mode is Wide, the device behaves like any other device. The voice of people sitting beside you will be heard, and also more noise from the room.

We recommend that you use Focused mode when you are the only speaker. Use Wide mode when several speakers are in front of the device.

Default value:

Focused

Value space:

Focused/Wide

Focused: Focused sound sensitivity, suppressing sound from sources that are not right in front of the device.

Wide: Default microphone operation with normal sound sensitivity.

Audio Input USBC [n] Level

Applies to: RoomBar DeskMini Desk DeskPro BoardPro

Requires user role: ADMIN, INTEGRATOR

Set the gain on the USB-C input connector. The gain can be tuned in steps of 1 dB.

Default value:

-5

Value space:

Integer (-24..0)

Select the gain in decibel (dB).

n: Unique ID that identifies the USB-C input.

Range: 1..1

Board

Audio Input USBC [n] Gain

Applies to: CodecEQ

Requires user role: ADMIN, INTEGRATOR

Set the gain on the USB-C input connector. The gain can be tuned in steps of 1 dB.

Default value:

-5

Value space:

Integer (-24..0)

Select the gain in decibel (dB).

n: Unique ID that identifies the USB-C input.

Range: 1..1

Board Pro

Codec EQ

Codec Plus

Codec Pro

Desk, Desk Pro, Desk Mini

Room Bar

Audio Input USBC [n] Mode

Applies to: RoomBar CodecEQ DeskMini Desk DeskPro BoardPro

Requires user role: ADMIN, INTEGRATOR

Set the USB-C audio mode.

Default value:

On

Value space:

Off/On

On: Allow audio from the USB-C.

Off: Do not allow any audio from the USB-C.

n: Unique ID that identifies the USB-C input.

Range: 1..1

Room Kit

Room Kit Mini

Room 55

Room 55 Dual, Room 70

Room 70 G2

Room 70 Panorama

Room Panorama

Audio Input USBC [n] VideoAssociation MuteOnInactiveVideo

Applies to: RoomBar CodecEQ DeskMini Desk DeskPro BoardPro

Requires user role: ADMIN

Use this setting to decide whether to stop the audio playback of a connected presentation source if that presentation source is not currently shown on-screen, or to always playback the audio as long as the presentation source is connected.

Default value:

On

Value space:

Off/On

Off: Audio is played, locally and to far end, as long as a presentation source is connected; you do not have to present the USBC input source.

On: Audio is played, locally and to far end, only when the connected presentation source is shown on-screen.

n: Unique ID that identifies the USB-C input.

Range: 1..1

Audio Input USBInterface [n] EchoControl Mode

Applies to: CodecEQ CodecPlus CodecPro Room70/Room55D Room70G2 RoomPanorama/Room70Panorama

Requires user role: ADMIN, INTEGRATOR

The device's echo canceller continuously adjusts itself to the audio characteristics of the room and compensates for any changes it detects in the audio environment. If the changes in the audio conditions are significant, the echo canceller may take a second or two to re-adjust.

If performing echo cancellation in external equipment, directional audio should be switched off using the Audio Panning Mode setting.

Default value:

On

Value space:

Off/On

Off: Turn off echo cancellation in the device. Recommended if echo cancellation is performed by external equipment.

On: Turn on echo cancellation in the device. Recommended, in general, to prevent the far end from hearing their own audio. Once selected, echo cancellation is always active.

n: Unique ID that identifies the USB interface.

Range: 1..1

Board

Audio Input USBInterface [n] Level

Applies to: CodecPlus CodecPro Room70/Room55D Room70G2 RoomPanorama/Room70Panorama

Requires user role: ADMIN, INTEGRATOR

Set the gain on the USB connector to fit the output level of the specific USB device that is connected. The output levels of USB devices may vary.

The gain can be tuned in steps of 1 dB.

Default value:

5

Value space:

Integer (0..24)

Set the gain in decibel (dB).

n: Unique ID that identifies the USB interface.

Range: 1..1

Board Pro

Codec EQ

Codec Plus

Codec Pro

Desk, Desk Pro, Desk Mini

Room Bar

Room Kit

Room Kit Mini

Room 55

Room 55 Dual, Room 70

Room 70 G2

Room 70 Panorama

Room Panorama

Audio Input USBInterface [n] Mode

Applies to: CodecEQ CodecPlus CodecPro Room70/Room55D Room70G2 RoomPanorama/Room70Panorama

Requires user role: ADMIN, INTEGRATOR

Disable or enable audio input on the USB connector.

Default value:

On

Value space:

Off/On

Off: Disable audio input on the USB connector.

On: Enable audio input on the USB connector.

n: Unique ID that identifies the USB interface.

Range: 1..1

Audio Input USBMicrophone [n] EchoControl Mode

Applies to: RoomKit RoomKitMini RoomBar Room55 DeskMini Desk DeskPro BoardPro

Requires user role: ADMIN, INTEGRATOR

The device's echo canceller continuously adjusts itself to the audio characteristics of the room and compensates for any changes it detects in the audio environment. If the changes in the audio conditions are significant, the echo canceller may take a second or two to re-adjust.

The AEC reference signal is always sent from the device to the USB microphone. Whether echo cancellation is performed in the device or in external equipment doesn't matter.

If performing echo cancellation in external equipment, directional audio should be switched off using the Audio Panning Mode setting.

Default value:

On

Value space:

Off/On

Off: Turn off echo cancellation in the device. Recommended if echo cancellation is performed by external equipment.

On: Turn on echo cancellation in the device. Recommended, in general, to prevent the far end from hearing their own audio. Once selected, echo cancellation is always active.

n: Unique ID that identifies the USB microphone.

Range: 1..1

Board

Audio Input USBMicrophone [n] Level

Applies to: RoomKit RoomKitMini RoomBar Room55 DeskMini Desk DeskPro BoardPro

Requires user role: ADMIN, INTEGRATOR

Set the gain on the USB connector to fit the output level of the specific USB microphone that is connected. The output levels of USB microphones may vary.

The gain can be tuned in steps of 1 dB.

Default value:

5

Value space:

Integer (0..24)

Set the gain in decibel (dB).

n: Unique ID that identifies the USB microphone.

Range: 1..1

Board
ProCodec
EQCodec
PlusCodec
ProDesk,
Desk Pro,
Desk MiniRoom
Bar

Audio Input WebView [n] Mode

Applies to: CodecEQ CodecPro Room70G2 RoomPanorama/Room70Panorama

Requires user role: ADMIN, INTEGRATOR

Set whether to allow audio playback from the embedded web browser (WebView).

Default value:

On

Value space:

Off/On

On: Allow audio from the web browser.

Off: Do not allow any audio to be played from the web browser.

n: Unique ID that identifies the WebView input.

Range: 1..1

Room Kit

Room Kit
Mini

Room 55

Room 55
Dual,
Room 70Room 70
G2Room 70
PanoramaRoom
Panorama

Audio Microphones AGC

Applies to: RoomKit CodecEQ CodecPlus

Requires user role: ADMIN, INTEGRATOR

Enable or disable Automatic Gain Control (AGC) on the microphones.

Codec EQ with AVIntegrator option: Not applicable.

Default value:

On

Value space:

Off/On

Off: Disable AGC. Use this when connecting to equipment where AGC is already applied to the microphone signal, like external mixers or DSPs.

On: Enable AGC.

Audio Microphones HdmiPassthrough MuteButton

Applies to: RoomKit CodecPlus CodecPro Room55 Room70/Room55D Room70G2

Requires user role: ADMIN, INTEGRATOR

When using the Call from laptop feature (requires that Video Output HDMI Passthrough Allowed is set to True), people can always mute their audio from the meeting app. Use this setting to configure whether to allow muting from the touch controller and external microphones as well. The meeting app must be set up to use the HDMI-to-USB converter (capturing device) as microphone instead of the laptop microphone.

Be aware that the touch controller / microphones are not synchronized with the meeting app regarding mute. Therefore, the mute indicators in the room and in the meeting app don't always reflect the true mute state.

This setting is not available for Room 55 Dual and Room 70 Dual because they don't have an HDMI output available for the converter.

Default value:

Active

Value space:

Active/Inactive

Active: People can mute using the buttons on the touch controller or microphones.

Inactive: People can't mute from the touch controller or microphones. Physical buttons are disabled, and there is no mute button on the user interface.

Board

Board
ProCodec
EQCodec
PlusCodec
ProDesk,
Desk Pro,
Desk MiniRoom
Bar

Room Kit

Room Kit
Mini

Room 55

Room 55
Dual,
Room 70Room 70
G2Room 70
PanoramaRoom
Panorama

Audio Microphones NoiseRemoval Mode

Applies to: All products

Requires user role: ADMIN, INTEGRATOR

Use this setting to enable or disable the noise removal function on a device, as well as to define the default behavior when the function is enabled. If enabled (Enabled or Manual), there will be buttons on the user interface that allow users to turn background noise removal on and off, and it will also be possible to turn it on and off using API commands.

Default value:

Enabled

Value space:

Disabled/Enabled/Manual

Disabled: The noise removal function is turned off and can't be turned on via the user interface or by sending API commands.

Enabled: You can turn noise removal on and off using buttons on the user interface or by sending API commands. Noise removal is turned on by default. For personal mode devices that are registered to the Webex cloud, the noise removal state is not affected when a call is ended, or you restart the device. If noise removal was turned on, it stays on; if it was turned off, it stays off. For other devices, the noise removal state returns to the default state (on) when a call is ended, or you restart the device.

Manual: You can turn noise removal on and off using buttons on the user interface or by sending API commands. Noise removal is turned off by default. For personal mode devices that are registered to the Webex cloud, the noise removal state is not affected when a call is ended, or you restart the device. If noise removal was turned on, it stays on; if it was turned off, it stays off. For other devices, the noise removal state returns to the default state (off) when a call is ended, or you restart the device.

Audio Microphones Mute Enabled

Applies to: RoomKit RoomKitMini RoomBar CodecEQ CodecPlus CodecPro Room55 Room70/Room55D Room70G2 RoomPanorama/Room70Panorama DeskMini Desk DeskPro BoardPro

Requires user role: ADMIN, INTEGRATOR

Define the microphone mute behavior on the device.

Default value:

True

Value space:

True/InCallOnly

True: Muting of audio is always available. In general, the microphone mute LED will not be lit outside of call, but you can still mute using the API commands.

InCallOnly: Muting of audio is only available when the device is in a call. When Idle, it is not possible to mute the microphone. This is useful when an external telephone service/audio system is connected via the device and is to be available when the device is not in a call. When set to InCallOnly this will prevent the audio-system from being muted by mistake.

Audio Microphones PhantomPower

Applies to: RoomKit CodecEQ CodecPlus Room55 Room70/Room55D BoardPro

Requires user role: ADMIN

Define whether or not to have phantom power (11 V +/- 1 V) on the microphone inputs.

Default value:

On

Value space:

Off/On

Off: Disable the phantom power on the microphone inputs. Use this when connecting to equipment that do not need phantom power, such as external mixers.

On: Enable the phantom power on the microphone inputs. Use this when connecting directly to microphones that require phantom power, including the Cisco Table Microphone and Cisco Ceiling Microphone.

Audio Microphones UsbPassthrough MuteButton

Applies to: RoomKitMini RoomBar CodecEQ DeskMini Desk DeskPro BoardPro

Requires user role: ADMIN, INTEGRATOR

When using the Call from laptop feature (that is, a laptop meeting app is using the device's camera, microphones, or loudspeakers), people can always mute their sound from the meeting app. Use this setting to configure whether to also allow muting from external microphones and the device itself as well. It is of course a prerequisite that people set up their meeting app to use the device's microphones instead of the laptop microphone.

Be aware that the device and microphones are not synchronized with the meeting app regarding mute. Therefore, the mute indicators in the room and in the meeting app don't always reflect the true mute state.

Default value:

Active [RoomKitMini RoomBar CodecEQ BoardPro]

Inactive [DeskMini Desk DeskPro]

Value space:

Active/Inactive

Active: People can mute their audio using the buttons on the device and microphones.

Inactive: People can't mute from the device and microphones. Physical buttons are disabled, and there is no mute button on the user interface.

Board

Board
ProCodec
EQCodec
PlusCodec
ProDesk,
Desk Pro,
Desk MiniRoom
Bar

Room Kit

Room Kit
Mini

Room 55

Room 55
Dual,
Room 70Room 70
G2Room 70
PanoramaRoom
Panorama

Audio Output ARC [n] Delay DelayMs

Applies to: CodecEQ CodecPro Room70G2 RoomPanorama/Room70Panorama

Requires user role: ADMIN, INTEGRATOR

To obtain lip-synchronization, you can configure each ARC output with an extra delay that compensates for delay in other connected devices, for example TVs and external loudspeakers. The delay that you set here is either fixed or relative to the delay measured on or reported by an external monitor, as defined in the Audio Output ARC [n] Delay Mode setting.

Default value:

0

Value space:

Integer (0..290)

The delay in milliseconds.

n: Unique ID that identifies the audio ARC output.

Range: 1..1

Audio Output ARC [n] Delay Mode

Applies to: CodecEQ CodecPro Room70G2 RoomPanorama/Room70Panorama

Requires user role: ADMIN, INTEGRATOR

You may add extra delay to an audio ARC output with the Audio Output ARC [n] Delay DelayMs setting. The extra delay added is either a fixed number of milliseconds, or a number of milliseconds relative to the detected delay on or reported by an external monitor.

Default value:

RelativeToHDMI [CodecEQ CodecPro]

Fixed [Room70G2 RoomPanorama/Room70Panorama]

Value space:

Fixed/RelativeToHDMI

Fixed: Any extra delay (DelayMs) added to the output, will be a fixed number of millisecond.

RelativeToHDMI: Any extra delay (DelayMs) added to the output, will be relative to the detected delay on or reported by an external monitor. The actual delay is detected-delay + DelayMs. The Audio Output Connectors ARC [n] DelayMs status reports the actual delay.

n: Unique ID that identifies the audio ARC output.

Range: 1..1

Audio Output ARC [n] Mode

Applies to: CodecEQ CodecPro Room70G2 RoomPanorama/Room70Panorama

Requires user role: ADMIN, INTEGRATOR

Choose whether or not to enable the audio return channel (ARC) on the HDMI [n] input connector. The ARC output must be enabled if you want audio playback through the Quad Camera.

On Room 70 G2, the Quad Camera is a part of the integrated loudspeaker system. We recommend to leave the ARC output enabled. If you want to disable the complete integrated loudspeaker system, use the Audio Output InternalSpeaker Mode setting.

Default value:

On

Value space:

Off/On

Off: Disable the ARC output on the HDMI input.

On: Enable the ARC output on the HDMI input.

n: Unique ID that identifies the audio ARC output.

Range: 1..1

Board

Board
ProCodec
EQCodec
PlusCodec
ProDesk,
Desk Pro,
Desk MiniRoom
Bar

Room Kit

Room Kit
Mini

Room 55

Room 55
Dual,
Room 70Room 70
G2Room 70
PanoramaRoom
Panorama

Audio Output ConnectorSetup

Applies to: [CodecPro](#) [Room70G2](#) [RoomPanorama/Room70Panorama](#)

Requires user role: ADMIN, INTEGRATOR

You can choose whether to set up the audio inputs and outputs manually, or to let the video conferencing device do it automatically based on the type of camera you have and which screens are connected.

In Auto mode, you cannot add, update, delete or connect audio inputs and outputs manually. Therefore the following API commands do not have any effect: `xCommand Audio Setup *`, `xCommand Audio LocalInput *`, and `xCommand Audio LocalOutput *`.

When going from Manual to Auto mode: The existing Audio setup is cleared (`xCommand Audio Setup Clear`), and the input and output groups are set up according to product defaults. The Audio Output HDMI [n] Mode and Audio Output ARC [1] Mode settings are set to their default value. For Codec Pro automatic delay measurement is enabled.

When going from Auto to Manual mode: The HDMI and ARC output connectors are connected to the default groups. The Audio Output HDMI [n] Mode and Audio Output ARC [1] Mode settings are not changed. For Codec Pro delay measurement is stopped.

Default value:

Auto

Value space:

Auto/Manual

Auto: For Code Pro, the video conferencing device will play audio either through the camera, or through a screen that is connected to one of the HDMI outputs. The video conferencing device chooses to play the audio on the first available device in the following list:

1. A Quad Camera that has camera control connected to one of the camera control connectors of the video conferencing device (Ethernet 2 or 3), and HDMI connected to the camera input of the video conferencing device (HDMI 1 input). Additionally, the Audio Output ARC [1] Mode and Video Input Connector [1] CEC Mode settings must be On. The audio return channel (ARC) on the HDMI 1 input is used to play audio through the camera.
2. A screen that is connected to the HDMI 1 output, provided that the Audio Output HDMI [1] Mode setting is On.
3. A screen that is connected to the HDMI 2 output, provided that the Audio Output HDMI [2] Mode setting is On.
4. A screen that is connected to the HDMI 3 output, provided that the Audio Output HDMI [3] Mode setting is On.

When audio is played out through the Quad Camera, the video conferencing device will measure the delay between a screen and the camera, so that it can synchronize the audio on the camera with the video on screen (lip-synchronization). In order to measure the delay, the video conferencing device sends a signal to the screen, and the screen sends the signal back to the video conferencing device using the audio return channel. The first screen in the list above that supports CEC (Consumer Electronics Control), and has the Video Output Connector [n] CEC Mode set to On, is used for the delay measurements.

When audio is played out through a screen, additional lip-synchronization delay is the responsibility of the screen. The video conferencing device will not add any delay.

For Room 70 G2, the video conferencing device will play audio through its integrated loudspeaker system, provided that Audio Output ARC [1] Mode and Audio Output InternalSpeaker Mode is On, and Audio Output HDMI [n] Mode is On for the integrated screen(s). Automatic delay measurement is not necessary, because the relationship between the integrated loudspeaker system and screen(s) is known.

Manual: You must set up the audio inputs and outputs manually using the Audio Console application or the API (`xCommand Audio LocalInput *`, and `xCommand Audio LocalOutput *`).

For Room 70 G2, external screen(s) may be used for audio output if the connectors are explicitly added using the Audio Console application or the API (`xCommand Audio LocalOutput *`). In that case, the external screens will play a stereo down mix of the audio that is played on the built-in loudspeaker system. Ultrasound signals will not play through external screens or line outputs; only through the integrated loudspeaker system.

Audio Output Ethernet [n] Mode

Applies to: [CodecEQ](#) [CodecPro](#) [Room70G2](#) [RoomPanorama/Room70Panorama](#)

Requires user role: ADMIN, INTEGRATOR

Ethernet [1]: The reference signal, which is required for acoustic echo cancelling (AEC), is sent from the codec to all connected digital microphones (Cisco Table Microphone Pro / Cisco Microphone Array) on this connection. If disabled, AEC will not work.

Ethernet [2]: This connection is only used by Room Panorama. It is used for the audio output from the codec to the DNAM IV amplifier.

We recommend you use the embedded Room Panorama audio system, which requires this setting to be On. If you switch it Off, the Room Panorama loudspeakers will not be used, and you need to connect external loudspeakers to the codec.

Default value:

On

Value space:

Off/On

Off: The Ethernet connection is disabled.

On: The Ethernet connection is enabled.

n: Unique ID that identifies the Ethernet connection.

Range: 1..1 [\[CodecEQ CodecPro Room70G2 \]](#)

Range: 1..2 [\[RoomPanorama/Room70Panorama \]](#)

Board

Audio Output HDMI [n] Delay DelayMs

Applies to: CodecEQ CodecPro

Requires user role: ADMIN, INTEGRATOR

To obtain lip-synchronization, you can configure each HDMI output with an extra delay that compensates for delay in other connected devices, for example TVs and external loudspeakers. The delay that you set here is either fixed or relative to the delay measured on or reported by an external monitor, as defined in the Audio Output HDMI [n] Delay Mode setting.

Default value:

0

Value space:

Integer (0..290)

The delay in milliseconds.

n: Unique ID that identifies the audio line output.

Range: 1..3

Board Pro

Codec EQ

Codec Plus

Codec Pro

Desk, Desk Pro, Desk Mini

Room Bar

Room Kit

Room Kit Mini

Room 55

Room 55 Dual, Room 70

Room 70 G2

Room 70 Panorama

Room Panorama

Audio Output HDMI [n] Delay Mode

Applies to: CodecEQ CodecPro

Requires user role: ADMIN, INTEGRATOR

You may add extra delay to an audio HDMI output with the Audio Output HDMI [n] Delay DelayMs setting. The extra delay added is either a fixed number of milliseconds, or a number of milliseconds relative to the detected delay on or reported by an external monitor.

Default value:

Fixed

Value space:

Fixed/RelativeToHDMI

Fixed: Any extra delay (DelayMs) added to the output, will be a fixed number of millisecond.

RelativeToHDMI: Any extra delay (DelayMs) added to the output, will be relative to the detected delay on or reported by an external monitor. The actual delay is detected-delay + DelayMs. The Audio Output Connectors HDMI [n] DelayMs status reports the actual delay.

n: Unique ID that identifies the audio line output.

Range: 1..3

Audio Output HDMI [n] Level

Applies to: Room70G2 RoomPanorama/Room70Panorama

Requires user role: ADMIN, INTEGRATOR

Set the gain on the HDMI input connector. The gain can be tuned in steps of 1 dB.

Default value:

0

Value space:

Integer (-24..0)

Range: Select the gain in decibel (dB).

n: Unique ID that identifies the HDMI output.

Range: 1..3 [Room70G2]

Range: For Room Panorama: 3..3; For Room 70 Panorama: 1..3 [RoomPanorama/Room70Panorama]

Audio Output HDMI [n] Gain

Applies to: CodecEQ

Requires user role: ADMIN, INTEGRATOR

Set the gain on the HDMI input connector. The gain can be tuned in steps of 1 dB.

Default value:

0

Value space:

Integer (-24..0)

Range: Select the gain in decibel (dB).

n: Unique ID that identifies the HDMI output.

Range: 1..3

Board

Board
ProCodec
EQCodec
PlusCodec
ProDesk,
Desk Pro,
Desk MiniRoom
Bar

Room Kit

Room Kit
Mini

Room 55

Room 55
Dual,
Room 70Room 70
G2Room 70
PanoramaRoom
Panorama

Audio Output HDMI [n] Mode

Applies to: [CodecEQ](#) [CodecPlus](#) [CodecPro](#) [Room70G2](#) [RoomPanorama/Room70Panorama](#)

Requires user role: ADMIN, INTEGRATOR

Define if the audio channel on this HDMI output connector shall be enabled.

Default value:

Room 70 Dual G2: HDMI 1,2: On HDMI 3: Off

Room 70 Single G2: HDMI 1: On HDMI 2,3: Off [[Room70G2](#)]

Room 70 Panorama: HDMI 1,2: On HDMI 3: Off

Room Panorama: Off [[RoomPanorama/Room70Panorama](#)]

On [[CodecEQ](#) [CodecPlus](#) [CodecPro](#)]

Value space:

Off/On

Off: The connector will not be used for audio out.

On: The connector can be used for audio out. For Codec Pro and Room 70 G2 it depends on the Audio Output ConnectorSetup setting.

n: Unique ID that identifies the HDMI output.

Range: 1..1 [[CodecPlus](#)]

Range: 1..3 [[CodecEQ](#) [CodecPro](#) [Room70G2](#)]

Range: For Room Panorama: 3..3; For Room 70 Panorama: 1..3 [[RoomPanorama/Room70Panorama](#)]

Audio Output InternalSpeaker Mode

Applies to: [RoomKit](#) [CodecPlus](#) [Room55](#) [Room70/Room55D](#) [Room70G2](#) [RoomPanorama/Room70Panorama](#) [BoardPro](#)

Requires user role: ADMIN, INTEGRATOR

Define whether or not to use the camera's integrated speakers. Codec Plus must be connected to a Quad Camera for this setting to apply.

For Room 70 G2, the Audio Output HDMI [n] Mode settings for the integrated monitor(s) must be set to On in order to play any audio on the integrated speakers. For Room 70 G2, also the Audio Output ARC 1 Mode setting must be On.

For all products except Codec Plus, you can limit the use of the integrated speakers to play only ultrasound.

Default value:

On

Value space:

Off/On/UltrasoundOnly [[RoomKit](#) [Room55](#) [Room70/Room55D](#) [Room70G2](#) [RoomPanorama/Room70Panorama](#) [BoardPro](#)]

Off/On [[CodecPlus](#)]

Off: Disable the device's integrated speakers.

On: Enable the device's integrated speakers.

UltrasoundOnly: Enable the device's integrated speakers only for ultrasound.

Audio Output Line [n] Channel

Applies to: [CodecPro](#) [Room70G2](#) [RoomPanorama/Room70Panorama](#)

Requires user role: ADMIN, INTEGRATOR

Define whether the Audio Line output is a mono signal or part of a multichannel signal.

Default value:

Line [[1,3,5](#)]: Left Line [2,4,6]: Right [[CodecPro](#) [Room70G2](#)]

Room Panorama: Line [[1,3,5](#)]: Left Line [2,4,6]: Right

Room 70 Panorama: Line [[1,2](#)]: Mono Line [3,5]: Left Line [4,6]: Right [[RoomPanorama/Room70Panorama](#)]

Value space:

Left/Mono/Right

Left: The Audio Line output signal is the left channel of a stereo signal.

Mono: The Audio Line output signal is a mono signal.

Right: The Audio Line output signal is the right channel of a stereo signal.

n: Unique ID that identifies the audio line output.

Range: 1..6

Board

Board
ProCodec
EQCodec
PlusCodec
ProDesk,
Desk Pro,
Desk MiniRoom
Bar

Room Kit

Room Kit
Mini

Room 55

Room 55
Dual,
Room 70Room 70
G2Room 70
PanoramaRoom
Panorama

Audio Output Line [n] Delay DelayMs

Applies to: CodecEQ CodecPro Room70G2 RoomPanorama/Room70Panorama

Requires user role: ADMIN, INTEGRATOR

To obtain lip-synchronization, you can configure each audio line output with an extra delay that compensates for delay in other connected devices, for example TVs and external loudspeakers. The delay that you set here is either fixed or relative to the delay on the HDMI output, as defined in the Audio Output Line [n] Delay Mode setting.

Default value:

0

Value space:

Integer (0..290)

The delay in milliseconds.

n: Unique ID that identifies the audio line output.

Range: 1..6 [*CodecPro Room70G2 RoomPanorama/Room70Panorama*]

Range: 1..1 [*CodecEQ*]

Audio Output Line [n] Delay Mode

Applies to: CodecEQ CodecPro Room70G2 RoomPanorama/Room70Panorama

Requires user role: ADMIN, INTEGRATOR

You may add extra delay to an audio line output with the Audio Output Line [n] Delay DelayMs setting. The extra delay added is either a fixed number of milliseconds, or a number of milliseconds relative to the detected delay on the HDMI output (typically introduced by the connected TV).

Default value:

Fixed [*Room70G2 RoomPanorama/Room70Panorama*]

RelativeToHDMI [*CodecEQ CodecPro*]

Value space:

Fixed/RelativeToHDMI

Fixed: Any extra delay (DelayMs) added to the output, will be a fixed number of millisecond.

RelativeToHDMI: Any extra delay (DelayMs) added to the output, will be relative to the detected delay on the HDMI output. The actual delay is HDMI-delay + DelayMs. The Audio Output Connectors Line [n] DelayMs status reports the actual delay.

n: Unique ID that identifies the audio line output.

Range: 1..6 [*CodecPro Room70G2 RoomPanorama/Room70Panorama*]

Range: 1..1 [*CodecEQ*]

Audio Output Line [n] Equalizer ID

Applies to: CodecPro Room70G2 RoomPanorama/Room70Panorama

Requires user role: ADMIN, INTEGRATOR

Select which equalizer preset to apply to this output.

Default value:

1

Value space:

Integer (1..8)

The equalizer preset number.

n: Unique ID that identifies the audio line output.

Range: 1..6

Audio Output Line [n] Equalizer Mode

Applies to: CodecPro Room70G2 RoomPanorama/Room70Panorama

Requires user role: ADMIN, INTEGRATOR

Enable or disable the equalizer processing for this output.

Default value:

Off

Value space:

Off/On

Off: Do not apply equalization processing.

On: Apply equalization processing.

n: Unique ID that identifies the audio line output.

Range: 1..6

Board

Board
ProCodec
EQCodec
PlusCodec
ProDesk,
Desk Pro,
Desk MiniRoom
Bar

Room Kit

Room Kit
Mini

Room 55

Room 55
Dual,
Room 70Room 70
G2Room 70
PanoramaRoom
Panorama

Audio Output Line [n] Level

Applies to: [CodecPro](#) [Room70/Room55D](#) [Room70G2](#) [RoomPanorama/Room70Panorama](#)

Requires user role: ADMIN, INTEGRATOR

Set the gain on the Line output connector. The gain should be adjusted to fit the audio input level of the connected device. The gain can be tuned in steps of 1 dB.

The maximum output level with 0 dB gain differs depending on the product: 8 dBu (Room 70, Room 55 Dual), 18 dBu (Codec Pro, Room 70 G2).

Example: If the audio device that is connected to a Codec Pro has max input level 10 dBu, then you should set the gain to 10 dBu - 18 dBu = -8 dB.

Default value:

-4 [[CodecPro](#) [Room70G2](#) [RoomPanorama/Room70Panorama](#)]

0 [[Room70/Room55D](#)]

Value space:

Integer (-24..0)

Range: Select the gain in decibel (dB).

n: Unique ID that identifies the audio line output.

Range: 1..6 [[CodecPro](#) [Room70G2](#) [RoomPanorama/Room70Panorama](#)]

Range: 1..1 [[Room70/Room55D](#)]

Audio Output Line [n] Gain

Applies to: [CodecEQ](#)

Requires user role: ADMIN, INTEGRATOR

Set the gain on the Line output connector. The gain should be adjusted to fit the audio input level of the connected device. The gain can be tuned in steps of 1 dB.

The maximum output level with 0 dB gain is 8 dBu.

Example: If the connected audio device has max input level 4 dBu, then you should set the gain to 4 dBu - 8 dBu = -4 dB.

Default value:

0

Value space:

Integer (-24..0)

Range: Select the gain in decibel (dB).

n: Unique ID that identifies the audio line output.

Range: 1..1

Audio Output Line [n] Mode

Applies to: [RoomKit](#) [CodecEQ](#) [CodecPlus](#) [CodecPro](#) [Room55](#) [Room70/Room55D](#) [Room70G2](#) [RoomPanorama/Room70Panorama](#) [BoardPro](#)

Requires user role: ADMIN, INTEGRATOR

Define the mode for the audio line output.

Default value:

On

Value space:

Off/On

Off: Disable the audio line output.

On: Enable the audio line output.

n: Unique ID that identifies the audio line output.

Range: 1..6 [[CodecPro](#) [Room70G2](#) [RoomPanorama/Room70Panorama](#)]

Range: 1..1 [[RoomKit](#) [CodecEQ](#) [CodecPlus](#) [Room55](#) [Room70/Room55D](#) [BoardPro](#)]

Board

Board
ProCodec
EQCodec
PlusCodec
ProDesk,
Desk Pro,
Desk MiniRoom
Bar

Room Kit

Room Kit
Mini

Room 55

Room 55
Dual,
Room 70Room 70
G2Room 70
PanoramaRoom
Panorama

Audio Output Line [n] OutputType

Applies to: RoomKit CodecEQ CodecPlus Room55 Room70/Room55D BoardPro

Requires user role: ADMIN, INTEGRATOR

The output type should be set to match the connected device.

Codec EQ with AVIntegrator option: Not applicable.

Default value:

Loudspeaker [RoomKit CodecEQ CodecPlus Room55 BoardPro]

LineOut [Room70/Room55D]

Value space:

LineOut/Loudspeaker/Microphone/Recorder/Subwoofer [RoomKit]

LineOut/Loudspeaker/Microphone/Recorder [CodecEQ CodecPlus Room55 Room70/Room55D BoardPro]

Loudspeaker: Use Loudspeaker if a loudspeaker is connected to the line output. In this mode, the output level on that connector follows the master volume control and the output signal includes all system sounds (ringtones, Webex assistant, etc.).

Microphone: In this mode, the sound picked up by the connected microphones will be sent to the line output. System sounds and sounds from far-end sources are not included.

Recorder: Use Recorder if a recorder is connected to the line output. In this mode, the output level is fixed and system sounds are not included. The sound from local presentation sources, the local microphones, and any far end sources are included.

Subwoofer: Use Subwoofer if a subwoofer is connected to the line output. In this mode, the bass is sent to line output and the rest of the audio range is played on the internal speaker.

LineOut: Use LineOut for other devices. In this mode, the output level is fixed and system sounds are not included. The sound from local presentation sources and far end sources are included.

n: Unique ID that identifies the audio line output.

Range: 1..1

Audio Output USBInterface [n] Mode

Applies to: CodecEQ CodecPlus CodecPro Room70/Room55D Room70G2 RoomPanorama/Room70Panorama

Requires user role: ADMIN, INTEGRATOR

Disable or enable audio output on the USB connector.

Default value:

On

Value space:

Off/On

Off: Disable audio output on the USB connector.

On: Enable audio output on the USB connector.

n: Unique ID that identifies the USB interface.

Range: 1..1

Audio Panning Mode

Applies to: RoomBar Room55 Room70/Room55D Room70G2 RoomPanorama/Room70Panorama DeskMini Desk DeskPro Board BoardPro

Requires user role: ADMIN

In scenarios where the device knows where in the video stream layout the person speaking is located, the device can playback audio on the loudspeakers closest to that location. You will also get a similar effect when using a headset. This is referred to as directional audio. For example, if the person speaking is placed to the left in the layout, audio will come from the left loudspeaker.

Headsets are further addressed in the Audio Panning HeadsetAnalog (only Desk Pro) and Audio Panning HeadsetUSB (only Board Pro and Desk Series devices) settings.

This setting is not available for the first generation of Board (non S-series).

Default value:

Auto

Value space:

Auto/Off

Auto: Use directional audio when it is available.

Off: Disable directional audio for loudspeakers and headsets.

Board

Audio Panning HeadsetAnalog BinauralProcessing

Applies to: DeskPro

Requires user role: ADMIN

Disable or enable binaural processing of audio for an analog headset. This is the audio processing technique that achieves natural sounding directional audio.

Default value:

True

Value space:

False/True

False: Do not perform binaural processing, but normal panning, with simple volume difference on left and right ear.

True: Perform binaural processing on the audio.

Board
ProCodec
EQCodec
PlusCodec
ProDesk,
Desk Pro,
Desk MiniRoom
Bar

Room Kit

Room Kit
Mini

Room 55

Room 55
Dual,
Room 70Room 70
G2Room 70
PanoramaRoom
Panorama

Audio Panning HeadsetUSB BinauralProcessing

Applies to: DeskMini Desk DeskPro BoardPro

Requires user role: ADMIN

Disable or enable binaural processing of audio for a USB headset. This is the audio processing technique that achieves natural sounding directional audio.

Default value:

False

Value space:

False/True

False: Do not perform binaural processing, but normal panning, with simple volume difference on left and right ear.

True: Perform binaural processing on the audio.

Audio Panning HeadsetUSB Mode

Applies to: DeskMini Desk DeskPro BoardPro

Requires user role: ADMIN

Disable or enable audio panning to provide directional audio for a USB headset.

If directional audio is turned off overall with the Audio Panning Mode setting, you will never get directional audio for the headset even if Audio Panning HeadsetUSB Mode is set to Auto.

Default value:

Auto

Value space:

Auto/Off

Auto: Use directional audio when it is available.

Off: Disable directional audio for USB headsets.

Audio Placement

Applies to: BoardPro

Requires user role: ADMIN

Define the mounting configuration of the system. Based on this setting, the loudspeaker system is configured to optimize sound quality.

Default value:

Freestanding

Value space:

Freestanding/Wallmount

Freestanding: The system is mounted on a floor stand or wheelbase.

Wallmount: The system is mounted on a wall mount.

Board

Audio SoundsAndAlerts RingTone

Applies to: All products

Requires user role: ADMIN, INTEGRATOR, USER

Define which ringtone to use for incoming calls.

Default value:

Sunrise BoardPro

Value space:

Sunrise/Mischief/Ripples/Reflections/Vibes/Delight/Evolve/Playful/Ascent/Calculation/
Mellow/Ringer

Select a ringtone from the list.

Board
ProCodec
EQCodec
PlusCodec
ProDesk,
Desk Pro,
Desk MiniRoom
Bar

Room Kit

Room Kit
Mini

Room 55

Room 55
Dual,
Room 70Room 70
G2Room 70
PanoramaRoom
Panorama

Audio SoundsAndAlerts RingVolume

Applies to: All products

Requires user role: ADMIN, INTEGRATOR, USER

Define the ring volume for incoming calls.

Default value:

50

Value space:

Integer (0..100)

Range: The value goes in steps of 5 from 0 to 100 (from -34.5 dB to 15 dB). Volume 0 = Off.

Audio Ultrasound Mode

Applies to: All products

Requires user role: ADMIN, INTEGRATOR

This setting applies to the Proximity feature. Keep the setting at its default value.

Default value:

Dynamic [RoomKit RoomKitMini RoomBar CodecEQ CodecPlus CodecPro Room55 Room70/Room55D
Room70G2 RoomPanorama/Room70Panorama DeskMini Desk DeskPro BoardPro]

Static [Board]

Value space:

Dynamic/Static

Dynamic: The device adjusts the ultrasound volume dynamically. The volume may vary up to the maximum level as defined in the Audio Ultrasound Volume MaxVolume setting.

Static: Use only if advised by Cisco.

Audio Ultrasound MaxVolume

Applies to: All products

Requires user role: ADMIN, INTEGRATOR

This setting applies to the Proximity feature. Set the maximum volume of the ultrasound pairing messages.

The Audio Ultrasound MaxVolume and Proximity Mode settings only affect ultrasound pairing messages. See the RoomAnalytics PeoplePresenceDetector and Standby WakeupOnMotionDetection settings for information about the use of ultrasound in presence and motion detection.

Default value:

70

Value space:

Integer (0..90) [CodecPlus CodecPro]

Integer (0..70) [RoomKit RoomKitMini RoomBar CodecEQ Room55 Room70/Room55D Room70G2
RoomPanorama/Room70Panorama DeskMini Desk DeskPro Board BoardPro]

Select a value in the specified range. If set to 0, ultrasound pairing messages are not emitted.

Audio Ultrasound Ru1Protocol

Applies to: All products

Requires user role: ADMIN, INTEGRATOR

This setting applies to the Proximity feature. Select if the device should enable Ru1 protocol for ultrasound pairing messages. If both Ru1Protocol and RzssProtocol are disabled, your app will not pair.

Default value:

On

Value space:

Off/On

Off: Disable Ru1 protocol.

On: Enable the Ru1 protocol.

Board

Audio Ultrasound RzssProtocol

Applies to: All products

Requires user role: ADMIN, INTEGRATOR

This setting applies to the Proximity feature. Select if the device should enable Rzss protocol for ultrasound pairing messages. If both Ru1Protocol and RzssProtocol are disabled, your app will not pair.

Default value:

On

Value space:

Off/On

Off: Disable Rzss protocol.

On: Enable Rzss protocol.

Board
ProCodec
EQCodec
PlusCodec
ProDesk,
Desk Pro,
Desk MiniRoom
Bar

Room Kit

Room Kit
Mini

Room 55

Room 55
Dual,
Room 70Room 70
G2Room 70
PanoramaRoom
Panorama

Audio USB Mode

Applies to: RoomKit RoomKitMini RoomBar Room55 DeskMini Desk DeskPro BoardPro

Requires user role: ADMIN, INTEGRATOR

Enable or disable the audio channels on the USB connector.

Default value:

SpeakerAndMicrophone

Value space:

AdditionalSpeaker/Microphone/Off/Speaker/SpeakerAndMicrophone [[RoomKit](#) [Room55](#) [DeskMini](#) [Desk](#) [DeskPro](#) [BoardPro](#)]

AdditionalMicrophone/AdditionalSpeaker/Microphone/Off/Speaker/
SpeakerAndMicrophone [[RoomKitMini](#) [RoomBar](#)]

AdditionalMicrophone: Both the video conferencing device's built-in microphone and an external audio input device (USB microphone) will be used. The USB audio output channel is disabled.

AdditionalSpeaker: Both the video conferencing device's built-in loudspeakers and the USB audio output device will be used. The USB audio input channel is disabled.

A loudspeaker that is connected to USB may have higher latency than the internal loudspeaker of the device. This can cause strange audio artefacts if you use both loudspeakers simultaneously.

A typical use case for AdditionalSpeaker is to support hearing aids/assisted listening devices (ALD) on video devices without an analog audio output. The difference in latency is less likely to cause issues in such set-ups.

Microphone: Only the external USB microphone will be used; other microphones are disabled. The USB audio output channel is also disabled.

Off: No audio will flow over USB but signaling is still enabled. This allows for using a USB device as a mute or volume controller.

Speaker: The USB audio output channel will be connected (speaker). Other speakers are disabled. The USB audio input channel is also disabled.

SpeakerAndMicrophone: Both the input (microphone) and output (speaker) channels of a USB audio device will be connected. Other microphones and speakers are disabled.

Board

Board
ProCodec
EQCodec
PlusCodec
ProDesk,
Desk Pro,
Desk MiniRoom
Bar

Room Kit

Room Kit
Mini

Room 55

Room 55
Dual,
Room 70Room 70
G2Room 70
PanoramaRoom
Panorama

Bluetooth settings

Bluetooth Allowed

Applies to: RoomBar DeskMini Desk DeskPro BoardPro

Requires user role: ADMIN

The device has a built-in Bluetooth® module. As a default, the user can turn it on or off using the user interface. With this setting, the administrator can disable Bluetooth configuration, so that it cannot be set up from the user interface.

Default value:

True

Value space:

False/True

False: Bluetooth is switched off by the administrator, and the user cannot turn it on from the user interface.

True: Bluetooth is allowed. The user can turn it on or off from the user interface.

Bluetooth Enabled

Applies to: RoomBar DeskMini Desk DeskPro BoardPro

Requires user role: ADMIN

Provided that Bluetooth® connections are allowed (see the Bluetooth Allowed setting), you can use this setting to enable and disable Bluetooth. The video conferencing device supports the HFP (Hands-Free Profile) and A2DP (Advanced Audio Distribution Profile) profiles. Headsets that only supports A2DP cannot be used.

Default value:

False

Value space:

False/True

False: Bluetooth is disabled, and no Bluetooth devices can pair with the video conferencing device.

True: Bluetooth is enabled, and you can pair and use a Bluetooth headset.

Bookings settings

Bookings ProtocolPriority

Applies to: All products

Requires user role: ADMIN

Video devices can join Microsoft Teams meetings either using SIP via a Cloud Video Interop (CVI) gateway, which is a service that is provided in the Webex cloud, or by running the Microsoft Teams meeting web app (WebRTC).

Joining Microsoft Teams meetings relies on a calendar service and is available for devices that are registered to an on-premises service and linked to Webex Edge for Devices, and for devices that are registered to the Webex cloud service.

Default value:

Auto

Value space:

Auto/WebRTC

Auto: The device will join the Microsoft Teams meeting via SIP/CVI if there is a CVI address in the meeting invite. Otherwise it will use WebRTC.

WebRTC: The device will always use WebRTC for Microsoft Teams meetings.

Board

Board
ProCodec
EQCodec
PlusCodec
ProDesk,
Desk Pro,
Desk MiniRoom
Bar

Room Kit

Room Kit
Mini

Room 55

Room 55
Dual,
Room 70Room 70
G2Room 70
PanoramaRoom
Panorama

BYOD settings

BYOD HidForwarding Enabled

Applies to: DeskPro

Requires user role: ADMIN, INTEGRATOR

If you use an external mouse or keyboard for your laptop (wired USB or USB dongle), you can connect them to the video conferencing device's USB port instead of directly to the laptop.

Default value:

False

Value space:

False/True

False: You must connect the external mouse or keyboard directly to your laptop.

True: You can connect the external mouse or keyboard for your laptop to the video conferencing device.

BYOD QRCodePairing

Applies to: DeskMini Desk DeskPro

Requires user role: ADMIN

Controls if users can use a QR code to pair their mobile phone and the video conferencing device through the Webex app. When enabled, the user just scans the QR code that is displayed on the device's screen and waits for the pairing process to complete.

This setting applies only to devices that are set up for Hot desking, which implies that they must be in shared mode and registered to the Webex cloud service or linked to Webex Edge for Devices.

Default value:

Enabled

Value space:

Disabled/Enabled

Enabled: There is a QR code on the device's screen, and users can scan it to sign in on the device.

Disabled: There is no QR code on the device. Users must sign in another way (NFC pairing or USB-C).

BYOD TouchForwarding Enabled

Applies to: DeskPro Board

Requires user role: ADMIN, INTEGRATOR

Use this setting to enable or disable the touch redirect feature. Touch redirect enables you to control your laptop from the touch screen of the board or video device. You must connect the laptop to the device with an HDMI cable (wired sharing) and a USB-C cable. You can use either a USB-C to USB-C cable or a USB-C to USB-A cable from the device to the laptop.

This feature is not available on the first generation of boards (Board 55 and 70).

Default value:

True

Value space:

False/True

False: Touch redirect is disabled.

True: Touch redirect is enabled.

BYOD USBCXapi

Applies to: DeskMini Desk DeskPro

Requires user role: ADMIN

This setting determines whether a laptop should automatically pair to the video device when it is connected with a USB-C cable.

Default value:

Enabled

Value space:

Disabled/Enabled

Disabled: The devices will not automatically pair.

Enabled: The devices will pair once connected with a USB-C cable.

Board

Board
ProCodec
EQCodec
PlusCodec
ProDesk,
Desk Pro,
Desk MiniRoom
Bar

Room Kit

Room Kit
Mini

Room 55

Room 55
Dual,
Room 70Room 70
G2Room 70
PanoramaRoom
Panorama

CallHistory settings

CallHistory Mode

Applies to: All products

Requires user role: ADMIN, INTEGRATOR

Specify whether or not information about calls that are placed or received are stored, including missed calls and calls that are not answered (call history). This determines whether or not the calls appear in the Recents list on the user interfaces.

Default value:

On

Value space:

Off/On

Off: New entries are not added to the call history.

On: New entries are stored in the call history list.

CallHistory Recents DisplayName

Applies to: All products

Requires user role: ADMIN

You can choose to hide meeting titles from the Recents list. This list is available when tapping the Call button on the UI, and in the Call page on the device web interface. This setting is neither supported on personal mode devices nor on shared mode devices where hotdesking is enabled.

Default value:

Auto

Value space:

Auto/Hidden

Auto: Keep meeting titles in the Recents list.

Hidden: Don't show meeting titles in the Recents list.

Cameras settings

Cameras Background Enabled

Applies to: DeskMini Desk DeskPro

Requires user role: ADMIN, USER

Enable or disable the Camera Background feature.

The Camera Background feature allows for a virtual background (images or effects) to be shown as the background in the camera view, instead of the real surroundings. This configuration must be enabled to allow the Cameras Background Set command to take effect.

Default value:

True

Value space:

False/True

True: Enable the Camera Background feature.

False: Disable the Camera Background feature.

Cameras Background UserImagesAllowed

Applies to: DeskMini Desk DeskPro

Requires user role: ADMIN

Enable or disable the ability for users to use custom images as virtual background during meetings or calls.

The Cameras Background Enabled setting must also be enabled for this feature to be accessible.

Default value:

False

Value space:

False/True

True: Enable the use of custom images as virtual backgrounds.

False: Disable the use of custom images as virtual backgrounds.

Board

Board
ProCodec
EQCodec
PlusCodec
ProDesk,
Desk Pro,
Desk MiniRoom
Bar

Room Kit

Room Kit
Mini

Room 55

Room 55
Dual,
Room 70Room 70
G2Room 70
PanoramaRoom
Panorama

Cameras Camera [n] AssignedSerialNumber

Applies to: CodecEQ CodecPlus CodecPro Room70/Room55D Room70G2 RoomPanorama/Room70Panorama BoardPro

Requires user role: ADMIN, INTEGRATOR

The camera ID is the number n in Camera [n]. By default, the camera ID is assigned automatically to a camera. If EDID information is not passed on from the camera to the video conferencing device, the camera ID is not persistent after a reboot. This means that a camera may get a new camera ID when the video conferencing device is restarted.

You should use the Cameras Camera AssignedSerialNumber setting to cater for configurations where the video conferencing device does not receive EDID information from multiple cameras. This setting allows you to manually assign a camera ID to a camera by associating the camera ID with the camera's serial number. The setting is persistent until the video conferencing device is factory reset.

A typical situation where the video conferencing device doesn't receive EDID information is when using an HDMI repeater that doesn't pass on such information.

Default value:

""

Value space:

String (0, 20)

The camera's serial number.

n: Unique ID that identifies the camera.

Range: 1..3 [[CodecEQ](#) [CodecPlus](#) [Room70/Room55D](#)]

Range: 1..7 [[CodecPro](#) [Room70G2](#) [RoomPanorama/Room70Panorama](#)]

Range: 2..7 [[BoardPro](#)]

Cameras Camera [n] Backlight DefaultMode

Applies to: CodecEQ CodecPlus CodecPro Room70/Room55D Room70G2 RoomPanorama/Room70Panorama BoardPro

Requires user role: ADMIN, INTEGRATOR

Turn backlight compensation on or off. Backlight compensation is useful when there is much light behind the persons in the room. Without compensation the persons may appear very dark to the far end.

This setting is not applicable for the integrated camera of Board Pro. If the Cameras Camera Brightness Algorithm is not set to Average, neither is it applicable to the Quad camera and the integrated camera of Room 55 Dual, Room 70, Room 70 G2, Room 70 Panorama, or Room Panorama. These cameras automatically adjust themselves based on the room lighting conditions.

Default value:

Off

Value space:

Off/On

Off: Turn off the camera backlight compensation.

On: Turn on the camera backlight compensation.

n: Unique ID that identifies the camera.

Range: 1..3 [[CodecEQ](#) [CodecPlus](#) [Room70/Room55D](#)]

Range: 1..7 [[CodecPro](#) [Room70G2](#) [RoomPanorama/Room70Panorama](#)]

Range: 2..7 [[BoardPro](#)]

Board

Cameras Camera [n] Brightness Algorithm

Applies to: CodecEQ CodecPlus CodecPro Room70/Room55D Room70G2 RoomPanorama/Room70Panorama BoardPro

Requires user role: ADMIN, INTEGRATOR

Specify the camera brightness algorithm.

Default value:

Auto

Value space:

Auto/Average/FaceOptimized

Auto: The camera brightness algorithm is automatically set by the device.

Average: The traditional brightness algorithm is applied. This uses the entire image area to calculate brightness.

FaceOptimized: Brightness is calculated by weighing the areas where people are detected. This includes automatic backlight compensation.

n: Unique ID that identifies the camera.

Range: 1..3 [*CodecEQ CodecPlus Room70/Room55D*]

Range: 1..7 [*CodecPro Room70G2 RoomPanorama/Room70Panorama*]

Range: 2..7 [*BoardPro*]

Cameras Camera [n] Brightness DefaultLevel

Applies to: RoomKit RoomKitMini RoomBar CodecEQ CodecPlus CodecPro Room55 Room70/Room55D Room70G2 RoomPanorama/Room70Panorama DeskMini Desk DeskPro BoardPro

Requires user role: ADMIN, INTEGRATOR

Set the brightness level. Requires the Cameras Camera Brightness Mode to be Manual.

Default value:

20

Value space:

Integer (1..31)

The brightness level. The higher the number, the brighter the image.

n: Unique ID that identifies the camera.

Range: 1..1 [*RoomKit RoomKitMini RoomBar Room55 DeskMini Desk DeskPro*]

Range: 1..3 [*CodecEQ CodecPlus Room70/Room55D*]

Range: 1..7 [*CodecPro Room70G2 RoomPanorama/Room70Panorama BoardPro*]

Cameras Camera [n] Brightness Mode

Applies to: RoomKit RoomKitMini RoomBar CodecEQ CodecPlus CodecPro Room55 Room70/Room55D Room70G2 RoomPanorama/Room70Panorama DeskMini Desk DeskPro BoardPro

Requires user role: ADMIN, INTEGRATOR

When the Brightness Mode is set to Auto the brightness is set and continuously adjusted by the device based on the current lighting conditions. There is no auto-adjustment in Manual mode, and the brightness level is manually set using the Cameras Camera Brightness DefaultLevel setting.

Default value:

Auto

Value space:

Auto/Manual

Auto: The camera brightness is automatically adjusted by the device. The Cameras Camera Brightness DefaultLevel setting has no effect.

Manual: Enable manual control of the camera brightness level. The brightness level is set using the Cameras Camera Brightness DefaultLevel setting.

n: Unique ID that identifies the camera.

Range: 1..1 [*RoomKit RoomKitMini RoomBar Room55 DeskMini Desk DeskPro*]

Range: 1..3 [*CodecEQ CodecPlus Room70/Room55D*]

Range: 1..7 [*CodecPro Room70G2 RoomPanorama/Room70Panorama BoardPro*]

Board

Cameras Camera [n] IrCutFilter Mode

Applies to: CodecEQ CodecPlus CodecPro Room70/Room55D Room70G2 RoomPanorama/Room70Panorama BoardPro

Requires user role: ADMIN, INTEGRATOR

This setting applies only to the PTZ 4K camera and will not have any effect on other cameras.

The IR cut filter (infrared cut-off filter) blocks near-infrared wavelengths while passing visible light. In regular lighting conditions, the filter should be on (Day mode) to avoid unwanted side-effects caused by infrared light. However, if you want the camera to capture images in the dark, the filter should be off (Night mode) so that infrared light can be utilized.

Default value:

Day

Value space:

Auto/Day/Night

Auto: The device switches between Day and Night mode automatically based on changes in brightness. Refer to the IrCutFilter Threshold setting how to control when to switch between the two modes.

Day: The IR cut filter is on.

Night: The IR cut filter is off.

n: Unique ID that identifies the camera.

Range: 1..3 [[CodecEQ](#) [CodecPlus](#) [Room70/Room55D](#)]

Range: 1..7 [[CodecPro](#) [Room70G2](#) [RoomPanorama/Room70Panorama](#)]

Range: 2..7 [[BoardPro](#)]

Board Pro

Codec EQ

Codec Plus

Codec Pro

Desk, Desk Pro, Desk Mini

Room Bar

Room Kit

Room Kit Mini

Room 55

Room 55 Dual, Room 70

Room 70 G2

Room 70 Panorama

Room Panorama

Cameras Camera [n] IrCutFilter Threshold

Applies to: CodecEQ CodecPlus CodecPro Room70/Room55D Room70G2 RoomPanorama/Room70Panorama BoardPro

Requires user role: ADMIN, INTEGRATOR

This setting has an effect only when Cameras Camera [n] IrCutFilter Mode is set to Auto, that is, when the camera is set to switch between Day and Night mode automatically. The higher the threshold value, the more light is required to trigger a switch to Day mode.

Default value:

14

Value space:

Integer (0..255)

The higher the number, the more ambient light is required to switch to Day mode.

n: Unique ID that identifies the camera.

Range: 1..3 [[CodecEQ](#) [CodecPlus](#) [Room70/Room55D](#)]

Range: 1..7 [[CodecPro](#) [Room70G2](#) [RoomPanorama/Room70Panorama](#)]

Range: 2..7 [[BoardPro](#)]

Cameras Camera ExposureCompensation Level

Applies to: DeskMini Desk DeskPro

Requires user role: ADMIN, INTEGRATOR

If you find the camera image always to be too dark (under-exposed) or too bright (over-exposed), you can use this setting to offset the target brightness. The brightness/exposure will continue to be adjusted automatically. This setting has an effect only when the Cameras Camera Brightness Mode is set to Auto.

Default value:

0

Value space:

Integer (-3..3)

A positive number increases brightness in the captured image; a negative number darkens it.

Board

Board
ProCodec
EQCodec
PlusCodec
ProDesk,
Desk Pro,
Desk MiniRoom
Bar

Room Kit

Room Kit
Mini

Room 55

Room 55
Dual,
Room 70Room 70
G2Room 70
PanoramaRoom
Panorama

Cameras Camera [n] Flip

Applies to: CodecEQ CodecPlus CodecPro Room70/Room55D Room70G2 RoomPanorama/Room70Panorama BoardPro

Requires user role: ADMIN, INTEGRATOR

With Flip mode (vertical flip), you can flip the image upside down. Flipping applies both to the self-view and the video that is transmitted to the far end.

This setting is not supported by the Quad Camera, the PTZ-12 camera, or the integrated camera of Board Pro, Room 55 Dual, Room 70, Room 70 G2, Room 70 Panorama, or Room Panorama.

Default value:

Auto

Value space:

Auto/Off/On

Auto: If the camera detects that it is mounted upside down, the image is automatically flipped. If the camera cannot auto-detect whether it is mounted upside down or not, the image is not changed. As an example, the Sony PTZ 4K camera cannot auto-detect that it's upside down. If you mount it upside down, you must set this parameter to On.

Off: Display the image on screen the normal way.

On: Display the image flipped upside down. This setting is used when a camera is mounted upside down, but cannot automatically detect which way it is mounted.

n: Unique ID that identifies the camera.

Range: 1..3 [[CodecEQ](#) [CodecPlus](#) [Room70/Room55D](#)]

Range: 1..7 [[CodecPro](#) [Room70G2](#) [RoomPanorama/Room70Panorama](#)]

Range: 2..7 [[BoardPro](#)]

Cameras Camera [n] Focus Mode

Applies to: CodecEQ CodecPlus CodecPro Room70/Room55D Room70G2 RoomPanorama/Room70Panorama BoardPro

Requires user role: ADMIN, INTEGRATOR

Define the camera focus mode.

Default value:

Auto

Value space:

Auto/AutoLimited/Manual [[CodecPlus](#) [CodecPro](#)]

Auto/Manual [[CodecEQ](#) [Room70/Room55D](#) [Room70G2](#) [RoomPanorama/Room70Panorama](#) [BoardPro](#)]

Auto: The auto focus works differently for different products. For Room 55 Dual, Room 70, Room 70 G2, Room 70 Panorama, Room Panorama, and when using the Quad Camera with a codec (Codec EQ, Codec Plus, or Codec Pro), the camera will do single shot auto focusing once a call is connected, and when the view has changed.

When using a Precision 60 or PTZ 4K camera, the camera will do continuous auto focusing. It will run auto focus once a call is connected, after pan, tilt, or zoom, and generally when the camera identifies a change in the scene.

AutoLimited: This mode only applies when using a Precision 60 camera with a Codec Plus or Codec Pro. In most cases this mode will operate the same way as auto focus. In some cases, auto-limited will reduce the focus hunting that may occur.

Problematic scenes have large areas with no or low contrast (for example, a painted wall with no details or a partly empty whiteboard). There's a slightly higher chance of background focus with this mode, compared to auto focus.

Manual: Turn the auto focus off and adjust the camera focus manually.

n: Unique ID that identifies the camera.

Range: 1..3 [[CodecEQ](#) [CodecPlus](#) [Room70/Room55D](#)]

Range: 1..7 [[CodecPro](#) [Room70G2](#) [RoomPanorama/Room70Panorama](#)]

Range: 2..7 [[BoardPro](#)]

Board

Board
ProCodec
EQCodec
PlusCodec
ProDesk,
Desk Pro,
Desk MiniRoom
Bar

Room Kit

Room Kit
Mini

Room 55

Room 55
Dual,
Room 70Room 70
G2Room 70
PanoramaRoom
Panorama

Cameras Camera [n] Gamma Level

Applies to: CodecEQ CodecPlus CodecPro Room70/Room55D Room70G2 RoomPanorama/Room70Panorama BoardPro

Requires user role: ADMIN, INTEGRATOR

By setting the Gamma Level you can select which gamma correction table to use. This setting may be useful in difficult lighting conditions, where changes to the brightness setting does not provide satisfactory results. Requires the Cameras Camera [n] Gamma Mode to be set to Manual.

This setting is not applicable for the Quad Camera or the integrated cameras of Board Pro, Room 55 Dual, Room 70, Room 70 G2, Room 70 Panorama, and Room Panorama. These cameras automatically adjust themselves based on the room lighting conditions. Also, this feature is not supported by the PTZ 4K camera or the PTZ-12 camera.

Default value:

0

Value space:

Integer (0..7) [[BoardPro](#)]

Integer (0..14) [[CodecEQ](#) [CodecPlus](#) [CodecPro](#) [Room70/Room55D](#) [Room70G2](#) [RoomPanorama/Room70Panorama](#)]

Define the gamma level.

n: Unique ID that identifies the camera.

Range: 1..3 [[CodecEQ](#) [CodecPlus](#) [Room70/Room55D](#)]

Range: 1..7 [[CodecPro](#) [Room70G2](#) [RoomPanorama/Room70Panorama](#)]

Range: 2..7 [[BoardPro](#)]

Cameras Camera [n] Gamma Mode

Applies to: CodecEQ CodecPlus CodecPro Room70/Room55D Room70G2 RoomPanorama/Room70Panorama BoardPro

Requires user role: ADMIN, INTEGRATOR

This setting enables gamma corrections. Gamma describes the nonlinear relationship between image pixels and monitor brightness.

This setting is not applicable for the Quad Camera or the integrated cameras of Board Pro, Room 55 Dual, Room 70, Room 70 G2, Room 70 Panorama, and Room Panorama. These cameras automatically adjust themselves based on the room lighting conditions. Also, this feature is not supported by the PTZ 4K camera or the PTZ-12 camera.

Default value:

Auto

Value space:

Auto/Manual

Auto: Auto is the default and the recommended setting.

Manual: In manual mode the gamma value is changed with the gamma level setting, ref. Cameras Camera [n] Gamma Level.

n: Unique ID that identifies the camera.

Range: 1..3 [[CodecEQ](#) [CodecPlus](#) [Room70/Room55D](#)]

Range: 1..7 [[CodecPro](#) [Room70G2](#) [RoomPanorama/Room70Panorama](#)]

Range: 2..7 [[BoardPro](#)]

Board

Board
ProCodec
EQCodec
PlusCodec
ProDesk,
Desk Pro,
Desk MiniRoom
Bar

Room Kit

Room Kit
Mini

Room 55

Room 55
Dual,
Room 70Room 70
G2Room 70
PanoramaRoom
Panorama

Cameras Camera [n] Mirror

Applies to: CodecEQ CodecPlus CodecPro Room70/Room55D Room70G2 RoomPanorama/Room70Panorama BoardPro

Requires user role: ADMIN, INTEGRATOR

With Mirror mode (horizontal flip) you can mirror the image on screen. Mirroring applies both to the self-view and the video that is transmitted to the far end. Mirroring is automatically disabled when speaker tracking is on.

This setting is only applicable when using a Precision 60 camera. However, the PTZ 4K camera automatically mirrors the image when the Cameras Camera [n] Flip setting is On.

Default value:

Auto

Value space:

Auto/Off/On

Auto: If the camera detects that it is mounted upside down, the image is automatically mirrored. If the camera cannot auto-detect whether it is mounted upside down or not, the image is not changed.

Off: Display the image as other people see you.

On: Display the image as you see yourself in a mirror.

n: Unique ID that identifies the camera.

Range: 1..3 [[CodecEQ](#) [CodecPlus](#) [Room70/Room55D](#)]

Range: 1..7 [[CodecPro](#) [Room70G2](#) [RoomPanorama/Room70Panorama](#)]

Range: 2..7 [[BoardPro](#)]

Cameras Camera [n] Whitebalance Mode

Applies to: CodecEQ CodecPlus CodecPro Room70/Room55D Room70G2 RoomPanorama/Room70Panorama BoardPro

Requires user role: ADMIN, INTEGRATOR

Define the camera white balance mode.

This setting is not applicable for the integrated camera of Board Pro, which automatically adjusts itself based on the room lighting conditions.

Default value:

Auto

Value space:

Auto/Manual

Auto: The camera will continuously adjust the white balance depending on the camera view.

Manual: Enables manual control of the camera white balance. The white balance level is set using the Cameras Camera Whitebalance Level setting.

n: Unique ID that identifies the camera.

Range: 1..3 [[CodecEQ](#) [CodecPlus](#) [Room70/Room55D](#)]

Range: 1..7 [[CodecPro](#) [Room70G2](#) [RoomPanorama/Room70Panorama](#)]

Range: 2..7 [[BoardPro](#)]

Cameras Camera [n] Whitebalance Level

Applies to: CodecEQ CodecPlus CodecPro Room70/Room55D Room70G2 RoomPanorama/Room70Panorama BoardPro

Requires user role: ADMIN, INTEGRATOR

Define the white balance level. Requires the Cameras Camera [n] Whitebalance Mode to be set to Manual.

This setting is not applicable for the integrated camera of Board Pro, which automatically adjusts itself based on the room lighting conditions. Also, this setting has no effect for the PTZ 4K and PTZ-12 cameras, which are using Sony's One Push mode when the Whitebalance Mode is set to manual.

Default value:

1

Value space:

Integer (1..16)

The white balance level.

n: Unique ID that identifies the camera.

Range: 1..3 [[CodecEQ](#) [CodecPlus](#) [Room70/Room55D](#)]

Range: 1..7 [[CodecPro](#) [Room70G2](#) [RoomPanorama/Room70Panorama](#)]

Range: 2..7 [[BoardPro](#)]

Board

Cameras Camera Framerate

Applies to: RoomKit RoomKitMini Room55

Requires user role: ADMIN

As default, the camera outputs 30 frames per second. This allows for good quality both in close-ups and overview pictures for normal bandwidths and lighting conditions. If the conditions are better, a 60 frames per second output from the camera may give a better overall quality.

Default value:

30

Value space:

30/60

30: The camera outputs 30 frames per second.

60: The camera outputs 60 frames per second.

Desk,
Desk Pro,
Desk MiniRoom
Bar

Cameras PowerLine Frequency

Applies to: RoomKit RoomKitMini RoomBar CodecEQ CodecPlus CodecPro Room55 Room70/Room55D Room70G2 RoomPanorama/Room70Panorama DeskMini Desk DeskPro BoardPro

Requires user role: ADMIN, INTEGRATOR

If your camera supports power line frequency anti-flickering, the camera is able to compensate for any flicker noise from the electrical power supply. You should set this camera configuration based on your power line frequency. If your camera supports auto detection of line frequency, you can select the Auto option in the configuration.

The Cisco cameras support both anti-flickering and auto detection of line frequency. Auto is the default value, so you should change this setting if you have a camera that does not support auto detection.

Default value:

Auto

Value space:

50Hz/60Hz/Auto

50Hz: Use this value when the power line frequency is 50 Hz.

60Hz: Use this value when the power line frequency is 60 Hz.

Auto: Allow the camera to detect the power frequency automatically.

Room Kit

Room Kit
Mini

Room 55

Room 55
Dual,
Room 70Room 70
G2Room 70
PanoramaRoom
Panorama

Cameras PresenterTrack CameraPosition Pan

Applies to: CodecEQ CodecPlus CodecPro Room70/Room55D Room70G2 BoardPro

Requires user role: ADMIN, INTEGRATOR

Define the pan position that the presenter tracking camera (PTZ 4K or Precision 60 camera) will move to when the feature is activated.

Default value:

0

Value space:

Integer (-65535..65535)

The pan position.

Cameras PresenterTrack CameraPosition Tilt

Applies to: CodecEQ CodecPlus CodecPro Room70/Room55D Room70G2 BoardPro

Requires user role: ADMIN, INTEGRATOR

Define the tilt position that the presenter tracking camera (PTZ 4K or Precision 60 camera) will move to when the feature is activated.

Default value:

0

Value space:

Integer (-65535..65535)

The tilt position.

Cameras PresenterTrack CameraPosition Zoom

Applies to: CodecEQ CodecPlus CodecPro Room70/Room55D Room70G2 BoardPro

Requires user role: ADMIN, INTEGRATOR

Define the zoom position that the presenter tracking camera (PTZ 4K or Precision 60 camera) will move to when the feature is activated.

Default value:

0

Value space:

Integer (-65535..65535)

The zoom position.

Board

Board
ProCodec
EQCodec
PlusCodec
ProDesk,
Desk Pro,
Desk MiniRoom
Bar

Room Kit

Room Kit
Mini

Room 55

Room 55
Dual,
Room 70Room 70
G2Room 70
PanoramaRoom
Panorama

Cameras PresenterTrack Connector

Applies to: CodecEQ CodecPlus CodecPro Room70/Room55D Room70G2 BoardPro

Requires user role: ADMIN, INTEGRATOR

Define which video input connector the presenter tracking camera (PTZ 4K or Precision 60 camera) is connected to.

Default value:

- 1 [[CodecEQ](#) [CodecPlus](#) [CodecPro](#) [Room70/Room55D](#) [Room70G2](#)]
- 3 [[BoardPro](#)]

Value space:

Integer (1..6) [[CodecEQ](#) [CodecPro](#) [Room70G2](#)]

Integer (1..3) [[CodecPlus](#) [Room70/Room55D](#)]

Integer (3..3) [[BoardPro](#)]

The video input connector.

Cameras PresenterTrack Enabled

Applies to: CodecEQ CodecPlus CodecPro Room70/Room55D Room70G2 BoardPro

Requires user role: ADMIN, INTEGRATOR

Define whether or not the PresenterTrack feature is available for use. The feature requires a PTZ 4K or Precision 60 camera as presenter tracking camera.

Default value:

False

Value space:

False/True

False: The PresenterTrack feature is disabled.

True: The PresenterTrack feature is available for use.

Cameras PresenterTrack PresenterDetectedStatus

Applies to: CodecEQ CodecPlus CodecPro Room70/Room55D Room70G2 BoardPro

Requires user role: ADMIN, INTEGRATOR

Define whether to enable or disable automatic switching between the Remote Presenter and Local Presenter modes in the Briefing room and Classroom scenarios (Room Type templates). Automatic switching implies that the device switches to Local Presenter mode when a person is detected in the PresenterTrack trigger zone, and that the device switches back to the Remote Presenter mode when the local presenter leaves the stage.

If this setting is enabled, the Cameras PresenterTrack PresenterDetected status will be updated when a new person enters the trigger zone.

Only the Precision 60 and PTZ 4K cameras support presenter tracking. Briefing room is not supported by Codec EQ, Codec Plus, Room 70, and Room 55 Dual. This setting is not applicable to Board Pro, since neither Briefing room nor Classroom is supported.

Default value:

Enabled

Value space:

Disabled/Enabled

Disabled: No automatic switching between modes.

Enabled: Automatic switching between the Local Presenter and Remote Presenter modes.

Cameras PresenterTrack TriggerZone

Applies to: CodecEQ CodecPlus CodecPro Room70/Room55D Room70G2 BoardPro

Requires user role: ADMIN, INTEGRATOR

Define the trigger zone, which corresponds to the area where a person's head must be detected for presenter tracking to start.

The format is a string of x and y coordinate pairs: "x1,y1,...xn,yn", where the range of x is (0,1920) and y is (0,1080). Two coordinate pairs define the upper left and lower right corner of a rectangular trigger zone. More than two coordinate pairs define the vertices of a polygonal trigger zone.

The feature requires a PTZ 4K or Precision 60 camera as presenter tracking camera.

Default value:

" "

Value space:

String (0, 255)

The coordinates for the trigger zone.

Board

Board
ProCodec
EQCodec
PlusCodec
ProDesk,
Desk Pro,
Desk MiniRoom
Bar

Room Kit

Room Kit
Mini

Room 55

Room 55
Dual,
Room 70Room 70
G2Room 70
PanoramaRoom
Panorama

Cameras SpeakerTrack DefaultBehavior

Applies to: All products

Requires user role: ADMIN, USER

The device's automatic framing capabilities depend on the camera. The major framing features are Best overview (the smallest frame that still covers all people in the room; Closeup (zoom in on the active speaker or a group of people close to the speaker); and Frames (composition of closeups of all individuals in the room, and with excess background removed).

Select the cameras default framing mode, which the camera will return to after a call. You can change to another mode from the user interface both in call and out of call.

Default value:

Auto

Value space:

Auto/BestOverview/Closeup/Current/Frames/Manual [[RoomKit](#) [RoomBar](#) [CodecEQ](#) [CodecPlus](#) [CodecPro](#) [Room55](#) [Room70/Room55D](#) [Room70G2](#) [RoomPanorama/Room70Panorama](#) [Board](#) [BoardPro](#)]

Auto/BestOverview/Current/Manual [[DeskMini](#) [Desk](#) [DeskPro](#)]

Auto/BestOverview/Current/Frames/Manual [[RoomKitMini](#)]

Auto: The same as BestOverview.

BestOverview: The default framing mode is Best overview.

Closeup: The default framing mode is Closeup (speaker tracking).

Current: The framing mode is kept unchanged when leaving a call.

Frames: The default framing mode is Frames.

Manual: The camera is controlled manually. The pan-tilt-zoom values are kept unchanged when leaving a call.

Cameras SpeakerTrack Frames Mode

Applies to: RoomKit RoomKitMini RoomBar CodecEQ CodecPlus CodecPro Room55 Room70/Room55D Room70G2 RoomPanorama/Room70Panorama Board BoardPro

Requires user role: ADMIN, USER

In Frames camera mode the camera will zoom and show people individually or in smaller groups. These individual and group frames are further composed into one outgoing video stream. In this stream excess background is removed, the people are shown closer to each other, uniform in size, and at the same eye level. The camera supports up to four frames. All the image processing is done on the sender side, so the receiving device doesn't have to support Frames.

Frames mode depends on the speaker tracking functionality; hence also the Cameras SpeakerTrack Mode must be set to Auto for Frames to work.

This feature is not available for Room 70 Panorama and Room Panorama in this software version.

Default value:

Auto

Value space:

Auto/Off

Auto: The user can switch Frames on and off using the camera controls on the device's user interface.

Off: Frames are not available.

Board

Board
ProCodec
EQCodec
PlusCodec
ProDesk,
Desk Pro,
Desk MiniRoom
Bar

Room Kit

Room Kit
Mini

Room 55

Room 55
Dual,
Room 70Room 70
G2Room 70
PanoramaRoom
Panorama

Cameras SpeakerTrack Mode

Applies to: All products

Requires user role: ADMIN, INTEGRATOR

This setting applies only when using a camera with support for speaker tracking or best overview.

Quad Camera: Speaker tracking uses automatic camera framing to select the best camera view based on where people are in the room. The Quad Camera uses an audio tracking technique that finds and captures a close-up of the active speaker.

SpeakerTrack 60 Camera: The dual camera assembly consists of two cameras and uses an audio tracking technique that finds and captures a close-up of the active speaker. When a change of speaker is detected, the video conferencing device can switch automatically between the two cameras to always show the best camera view. Refer to the Cameras SpeakerTrack TrackingMode setting for different switching modes.

Video conferencing devices with a built-in speakertrack camera (Room Kit, Room 55, Room 55 Dual, Room 70, Room 70 G2, Room 70 Panorama, Room Panorama, Board, Board Pro): Speaker tracking uses automatic camera framing to select the best camera view based on where people are in the room. The camera uses an audio tracking technique that finds and captures a close-up of the active speaker.

Video conferencing devices with a camera that supports Best overview, but not speaker tracking (Room Bar, Room Kit Mini, and Desk series products): Best overview uses automatic camera framing to select the best camera view based on where people are in the room.

Default value:

Auto

Value space:

Auto/Off

Auto: Speaker tracking (not supported on Room Bar, Room Kit Mini, or Desk series products) and best overview is switched on. The device will detect people in the room and automatically select the best camera framing. Users can switch the feature on or off instantly in the camera control panel on the touch controller, but the feature is switched back on after each call so that the device is ready for the next user.

Off: Speaker tracking (not supported on Room Bar, Room Kit Mini, or Desk series products) and best overview is switched off. If you have a SpeakerTrack 60 Camera assembly the two cameras will operate as individual cameras.

Cameras SpeakerTrack Closeup

Applies to: RoomKit CodecEQ CodecPlus CodecPro Room55 Room70/Room55D Room70G2 RoomPanorama/Room70Panorama Board BoardPro

Requires user role: ADMIN, INTEGRATOR, USER

Turn on/off the closeup and group framing feature.

This setting applies only when the Cameras SpeakerTrack Mode is set to Auto. When the closeup functionality is turned on, the device will detect that a person is speaking and select the best framing to cover that person. This is called a closeup and may not include all the persons in the room. If you want all the persons in the room to be in the picture at all times you can turn off the closeup functionality.

Default value:

Auto

Value space:

Auto/Off/On

Auto: The behavior depends on the device type. Board 55/55S/70/70S/85S and Board Pro strive to keep everyone in the room in the camera frame at all times, while other devices will zoom in either solely on the active speaker or the active speaker and the participants in close proximity to him/her (group frame).

Off: The device will keep all the persons in the room in the camera framing at all times.

On: The device will zoom in on the active speaker or the group frame.

Cameras SpeakerTrack TrackingMode

Applies to: CodecEQ CodecPlus CodecPro BoardPro

Requires user role: ADMIN, INTEGRATOR

This setting applies only when using a SpeakerTrack 60 camera, and when Cameras SpeakerTrack Mode is set to Auto.

The speaker tracking algorithm can react to changes in two modes, one faster than the other. The mode determines when the camera view will change to a new speaker.

Default value:

Auto

Value space:

Auto/Conservative

Auto: This is the normal tracking mode.

Conservative: The camera view will change to a new speaker later than in normal tracking mode.

Board

Cameras SpeakerTrack ConnectorDetection Mode

Applies to: CodecEQ CodecPlus CodecPro

Requires user role: ADMIN, INTEGRATOR

This setting applies only when a SpeakerTrack 60 camera is connected to the video conferencing device.

Define whether to automatically detect or manually configure which video input each individual camera is connected to. You should choose manual configuration in situations where the video conferencing device does not receive EDID information from the cameras. Typically, this will be when you use HDMI repeaters that do not pass on EDID information.

Default value:

Auto

Value space:

Auto/Manual

Auto: Automatically detect which video inputs the cameras are connected to.

Manual: Manually define which video inputs the cameras are connected to. Use the Cameras SpeakerTrack ConnectorDetection CameraLeft and Cameras SpeakerTrack ConnectorDetection CameraRight settings.

Board
ProCodec
EQCodec
PlusCodec
ProDesk,
Desk Pro,
Desk MiniRoom
Bar

Room Kit

Room Kit
Mini

Room 55

Room 55
Dual,
Room 70Room 70
G2Room 70
PanoramaRoom
Panorama

Cameras SpeakerTrack ConnectorDetection CameraRight

Applies to: CodecEQ CodecPlus CodecPro

Requires user role: ADMIN, INTEGRATOR

Define the number of the video input that SpeakerTrack 60's right camera is connected to. This setting applies only when a SpeakerTrack 60 camera is connected to the video conferencing device. Furthermore, Cameras SpeakerTrack ConnectorDetection Mode must be set to Manual.

Codec EQ doesn't support the SpeakerTrack 60 camera.

Default value:

2

Value space:

Integer (1..5) [*CodecPro*]

Integer (1..3) [*CodecPlus*]

Set a valid video input number. For example, set to 2 if the right camera is connected to video input 2.

Cameras SpeakerTrack Whiteboard Mode

Applies to: RoomKit CodecEQ CodecPlus CodecPro Room55 Room70/Room55D Room70G2 RoomPanorama/Room70Panorama

Requires user role: ADMIN, INTEGRATOR, USER

This setting belongs to the Snap to whiteboard feature, which is not supported in this software version.

Cameras SpeakerTrack ConnectorDetection CameraLeft

Applies to: CodecEQ CodecPlus CodecPro

Requires user role: ADMIN, INTEGRATOR

Define the number of the video input that SpeakerTrack 60's left camera is connected to.

This setting applies only when a SpeakerTrack 60 camera is connected to the video conferencing device. Furthermore, Cameras SpeakerTrack ConnectorDetection Mode must be set to Manual.

Codec EQ doesn't support the SpeakerTrack 60 camera.

Default value:

1

Value space:

Integer (1..5) [*CodecPro*]

Integer (1..3) [*CodecPlus*]

Set a valid video input number. For example, set to 1 if the left camera is connected to video input 1.

Board

Board
ProCodec
EQCodec
PlusCodec
ProDesk,
Desk Pro,
Desk MiniRoom
Bar

Room Kit

Room Kit
Mini

Room 55

Room 55
Dual,
Room 70Room 70
G2Room 70
PanoramaRoom
Panorama

Conference settings

Conference ActiveControl Mode

Applies to: All products

Requires user role: ADMIN

Active control is a feature that allows conference participants to administer a conference on Cisco TelePresence Server or Cisco Meeting Server using the video conferencing device's interfaces. Each user can see the participant list, change video layout, disconnect participants, etc. from the interface. The active control feature is enabled by default, provided that it is supported by the infrastructure (Cisco Unified Communications Manager (CUCM) version 9.1.2 or newer, Cisco TelePresence Video Communication Server (VCS) version X8.1 or newer, Cisco Media Server (CMS) version 2.1 or newer). Change this setting if you want to disable the active control features.

Default value:

Auto

Value space:

Auto/Off

Auto: Active control is enabled when supported by the infrastructure.

Off: Active control is disabled.

Conference AutoAnswer Mode

Applies to: All products

Requires user role: ADMIN

Define the auto answer mode. Use the Conference AutoAnswer Delay setting if you want the device to wait a number of seconds before answering the call, and use the Conference AutoAnswer Mute setting if you want your microphone to be muted when the call is answered.

Default value:

Off

Value space:

Off/On

Off: You can answer incoming calls manually by tapping Answer on the touch controller.

On: The device automatically answers incoming calls, except if you are already in a call. You can answer or decline incoming calls manually when you are already engaged in a call.

Conference AutoAnswer Mute

Applies to: All products

Requires user role: ADMIN

Define if the microphone shall be muted when an incoming call is automatically answered. Requires that AutoAnswer Mode is switched on.

Default value:

Off

Value space:

Off/On

Off: The incoming call will not be muted.

On: The incoming call will be muted when automatically answered.

Conference AutoAnswer Delay

Applies to: All products

Requires user role: ADMIN

Define how long (in seconds) an incoming call has to wait before it is answered automatically by the device. Requires that AutoAnswer Mode is switched on.

Default value:

0

Value space:

Integer (0..50)

The auto answer delay (seconds).

Conference CallProtocolIPStack

Applies to: All products

Requires user role: ADMIN

Select if the device should enable IPv4, IPv6, or dual IP stack on the call protocol (SIP, H323).

Default value:

Dual

Value space:

Dual/IPv4/IPv6

Dual: Enables both IPv4 and IPv6 for the call protocol.

IPv4: When set to IPv4, the call protocol will use IPv4.

IPv6: When set to IPv6, the call protocol will use IPv6.

Board

Conference CapsetFilter

Applies to: All products

Requires user role: ADMIN

This setting lets you specify what media codecs should be filtered in media negotiation in H.323 and SIP calls. It should only be used for debug purposes and in agreement with Cisco.

Default value:

""

Value space:

String (0, 200)

The filter definition.

Conference DefaultCall Protocol

Applies to: All products

Requires user role: ADMIN

Define the Default Call Protocol to be used when placing calls from the device.

Default value:

Auto

Value space:

Auto/H323/Sip/Spark

Auto: Enables auto-selection of the call protocol based on which protocols are available. If multiple protocols are available, the order of priority is: 1) SIP; 2) H323. If the device cannot register, the auto-selection chooses H323.

H323: All calls are set up as H.323 calls.

Sip: All calls are set up as SIP calls.

Spark: All calls are set up via the Webex infrastructure.

Conference DefaultCall Rate

Applies to: All products

Requires user role: ADMIN, INTEGRATOR

Define the default call rate to be used when placing a call. For Webex meetings, this default may be overridden by the Conference DefaultCall Webex Rate setting.

The call rate will always be limited by the Conference MaxReceiveCallRate and Conference MaxTransmitCallRate settings. If applicable, it is also limited by the Conference MaxMultisiteReceiveRate, and Conference MaxMultiSiteTransmitRate.

Default value:

6000 [RoomKit RoomKitMini RoomBar CodecEQ CodecPlus CodecPro Room55 Room70/Room55D Room70G2 DeskMini Desk DeskPro BoardPro]

10000 [Board]

16000 [RoomPanorama/Room70Panorama]

Value space:

Integer (64..6000) [RoomKit RoomKitMini RoomBar CodecEQ CodecPlus CodecPro Room55 Room70/Room55D Room70G2 DeskMini Desk DeskPro BoardPro]

Integer (64..10000) [Board]

Integer (64..20000) [RoomPanorama/Room70Panorama]

The default call rate (kbps).

Conference DefaultCall Webex Rate

Applies to: All products

Requires user role: ADMIN, INTEGRATOR

This setting is available in software version RoomOS 11.2 and later.

Define the default call rate to be used in Webex meetings. The setting applies only to devices that get software from the Webex cloud service.

The call rate will always be limited by the Conference MaxReceiveCallRate and Conference MaxTransmitCallRate settings.

Default value:

0 [RoomKit RoomKitMini RoomBar CodecEQ CodecPlus CodecPro Room55 Room70/Room55D Room70G2 RoomPanorama/Room70Panorama DeskMini Desk DeskPro BoardPro]

10000 [Board]

Value space:

Integer (0..20000) [RoomBar CodecEQ CodecPro Room70G2 RoomPanorama/Room70Panorama DeskMini Desk DeskPro BoardPro]

Integer (0..10000) [Board]

Integer (0..6000) [RoomKit RoomKitMini CodecPlus Room55 Room70/Room55D]

The default call rate (kbps). If set to 0, the default call rate is given by the Conference DefaultCall Rate setting.

Board Pro

Codec EQ

Codec Plus

Codec Pro

Desk, Desk Pro, Desk Mini

Room Bar

Room Kit

Room Kit Mini

Room 55

Room 55 Dual, Room 70

Room 70 G2

Room 70 Panorama

Room Panorama

Board

Conference DoNotDisturb DefaultTimeout

Applies to: All products

Requires user role: ADMIN, INTEGRATOR

This setting determines the default duration of a Do Not Disturb session, that is, the period when incoming calls are rejected and registered as missed calls. The session can be terminated earlier by using the user interface.

Default value:

60

Value space:

Integer (1..1440)

The number of minutes (maximum 1440 minutes = 24 hours) before the Do Not Disturb session times out automatically.

Board Pro

Codec EQ

Codec Plus

Codec Pro

Desk, Desk Pro, Desk Mini

Room Bar

Room Kit

Room Kit Mini

Room 55

Room 55 Dual, Room 70

Room 70 G2

Room 70 Panorama

Room Panorama

Conference EmbeddedApp NotificationsOnly

Applies to: DeskMini Desk DeskPro Board BoardPro

Requires user role: ADMIN, INTEGRATOR

With Embedded App support, you can use the device to see and interact with apps that have been initiated by a meeting participant that is using a Webex client.

As an administrator, you can set whether to show the actual app on the device or just a notification that an app is being shared. In the latter case, people must open their meeting client to see and interact with the app.

Embedded apps are using the device's web engine, so the WebEngine Mode setting must be On.

Default value:

False

Value space:

False/True

False: People can see and interact with embedded apps on the device.

True: People will see a notification when an embedded app is shared. They can't see or interact with the app on the device; they must use a meeting client.

Conference Encryption Mode

Applies to: All products

Requires user role: ADMIN

Define the conference encryption mode. A padlock with the text "Encryption On" or "Encryption Off" displays on screen for a few seconds when the conference starts.

NOTE: If the Encryption Option Key is not installed on the device, the encryption mode is always Off.

Default value:

BestEffort

Value space:

Off/On/BestEffort

Off: The device will not use encryption.

On: The device will only allow calls that are encrypted.

BestEffort: The device will use encryption whenever possible.

> In Point to point calls: If the far end device supports encryption (AES-128), the call will be encrypted. If not, the call will proceed without encryption.

> In MultiSite calls: In order to have encrypted MultiSite conferences, all sites must support encryption. If not, the conference will be unencrypted.

Conference EndToEndEncryption Identity PreferredDomain

Applies to: All products

Requires user role: ADMIN

This is only available on devices registered to the Webex cloud service or linked to Webex Edge for devices.

This configuration is made when the admin sets the device's preferred domain from Control Hub. It is only necessary if the organization has more than one domain.

The device uses this domain when it requests a certificate from the Webex CA. The domain then identifies the device.

This configuration is not applicable when the device has an active, externally-issued certificate to identify itself.

Default value:

""

Value space:

String (0, 255)

Board

Conference EndToEndEncryption Mode

Applies to: All products

Requires user role: ADMIN

This is only available on devices registered to the Webex cloud service or linked to Webex Edge for devices.

Enables the End-to-End Encryption (E2EE) meeting option for the device.

Default value:

Off

Value space:

Off/On

On: Enable the use of E2EE for the device.

Off: Disable the use of E2EE for the device.

Board Pro

Codec EQ

Codec Plus

Codec Pro

Desk, Desk Pro, Desk Mini

Room Bar

Room Kit

Room Kit Mini

Room 55

Room 55 Dual, Room 70

Room 70 G2

Room 70 Panorama

Room Panorama

Conference FarEndControl SignalCapability

Applies to: All products

Requires user role: ADMIN

Define the far end control (H.224) signal capability mode.

Default value:

On

Value space:

Off/On

Off: Disable the far end control signal capability.

On: Enable the far end control signal capability.

Conference FarendMessage Mode

Applies to: All products

Requires user role: ADMIN

Toggle whether it is allowed to send data between two devices in a point-to-point call, for use with control systems or macros. Works with SIP calls only. This setting will enable/disable the use of the xCommand Call FarEndMessage Send command.

Default value:

Off

Value space:

Off/On

Off: It is not possible to send messages between two devices.

On: It is possible to send messages between two devices in a point-to-point call.

Conference JoinLeaveNotifications

Applies to: All products

Requires user role: ADMIN

Specify when to show notifications of people entering or exiting meetings.

Default value:

Auto

Value space:

Always/Auto/Never

Always: Always show all notifications.

Auto: Show notifications only for the first 25 joining participants.

Never: Never show notifications.

Board

Conference MaxReceiveCallRate

Applies to: All products

Requires user role: ADMIN

Define the maximum receive bit rate to be used when placing or receiving calls. In general, this is the maximum receive bit rate for an individual call.

For on-premises registered devices, the maximum receive bit rate for an individual call is the lowest of the Conference MaxReceiveCallRate and Conference MaxMultisiteReceiveRate settings. In a MultiSite conference, Conference MaxMultisiteReceiveRate is the aggregated maximum for all simultaneous active calls.

Default value:

6000 [RoomKit RoomKitMini RoomBar CodecEQ CodecPlus CodecPro Room55 Room70/Room55D Room70G2 DeskMini Desk DeskPro BoardPro]

20000 [RoomPanorama/Room70Panorama]

10000 [Board]

Value space:

Integer (64..6000) [RoomKit RoomKitMini CodecPlus Room55 Room70/Room55D]

Integer (64..20000) [RoomBar CodecEQ CodecPro Room70G2 RoomPanorama/Room70Panorama DeskMini Desk DeskPro BoardPro]

Integer (64..10000) [Board]

The maximum receive call rate (kbps).

Conference MaxTransmitCallRate

Applies to: All products

Requires user role: ADMIN

Define the maximum transmit bit rate to be used when placing or receiving calls. In general, this is the maximum transmit bit rate for an individual call.

For on-premises registered devices, the maximum transmit bit rate for an individual call is the lowest of the Conference MaxTransmitCallRate and Conference MaxMultisiteTransmitRate settings. In a MultiSite conference, Conference MaxMultisiteTransmitRate is the aggregated maximum for all simultaneous active calls.

Default value:

6000 [RoomKit RoomKitMini RoomBar CodecEQ CodecPlus CodecPro Room55 Room70/Room55D Room70G2 DeskMini Desk DeskPro Board BoardPro]

20000 [RoomPanorama/Room70Panorama]

Value space:

Integer (64..6000) [RoomKit RoomKitMini CodecPlus Room55 Room70/Room55D]

Integer (64..20000) [RoomBar CodecEQ CodecPro Room70G2 RoomPanorama/Room70Panorama DeskMini Desk DeskPro Board BoardPro]

The maximum transmit call rate (kbps).

Conference MaxMultisiteReceiveRate

Applies to: All products

Requires user role: ADMIN

This configuration applies when using a device's built-in MultiSite feature (optional) to host a multipoint video conference.

Define the maximum aggregated receive bit rate allowed. The bit rate will be divided fairly among all active calls at any time. This means that the individual calls will be up-speeded or down-speeded as appropriate when someone leaves or enters a MultiSite conference, or when a call is put on hold (suspended) or resumed.

The maximum receive bit rate for each individual call is defined in the Conference MaxReceiveCallRate setting.

Default value:

6000 [RoomKit RoomKitMini CodecPlus Room55 Room70/Room55D Board]

15000 [RoomBar CodecEQ CodecPro Room70G2 RoomPanorama/Room70Panorama DeskMini Desk DeskPro BoardPro]

Value space:

Integer (64..6000) [RoomKit RoomKitMini CodecPlus Room55 Room70/Room55D Board]

Integer (64..15000) [RoomBar CodecEQ CodecPro Room70G2 RoomPanorama/Room70Panorama DeskMini Desk DeskPro BoardPro]

The maximum aggregated receive call rate (kbps) in a MultiSite conference.

Board

Conference MaxMultisiteTransmitRate

Applies to: All products

Requires user role: ADMIN

This configuration applies when using a device's built-in MultiSite feature (optional) to host a multipoint video conference.

Define the maximum aggregated transmit bit rate allowed. The bit rate will be divided fairly among all active calls at any time. This means that the individual calls will be up-speeded or down-speeded as appropriate when someone leaves or enters a MultiSite conference, or when a call is put on hold (suspended) or resumed.

The maximum transmit bit rate for each individual call is defined in the Conference MaxTransmitCallRate setting.

Default value:

6000 [RoomKit RoomKitMini CodecPlus Room55 Room70/Room55D Board]

15000 [RoomBar CodecEQ CodecPro Room70G2 RoomPanorama/Room70Panorama DeskMini Desk DeskPro BoardPro]

Value space:

Integer (64..6000) [RoomKit RoomKitMini CodecPlus Room55 Room70/Room55D Board]

Integer (64..15000) [RoomBar CodecEQ CodecPro Room70G2 RoomPanorama/Room70Panorama DeskMini Desk DeskPro BoardPro]

The maximum aggregated transmit call rate (kbps) in a MultiSite conference.

Board Pro

Codec EQ

Codec Plus

Codec Pro

Desk, Desk Pro, Desk Mini

Room Bar

Room Kit

Room Kit Mini

Room 55

Room 55 Dual, Room 70

Room 70 G2

Room 70 Panorama

Room Panorama

Conference Multipoint Mode

Applies to: All products

Requires user role: ADMIN

Define how to expand a point-to-point video call (a call involving only two parties) into a multipoint conference with more participants (ad hoc conferences). Both the built-in MultiSite feature, which relies only on local resources, and different solutions based on centralized infrastructure (multipoint control units – MCUs) are available.

The MultiSite feature is an upgrade option and may not be available on all devices. The MultiSite option key must be installed on the device.

If registered to a Cisco TelePresence Video Communication Server (VCS), the device can use MultiSite when calling other video devices. If registered to a Cisco Unified Communications Manager (CUCM) version 8.6.2 or newer, the device can use either a CUCM conference bridge, or the device's own built-in MultiSite feature. Which option to use, is set-up by CUCM.

In either case, multiparty conferences may be set up via an MCU if you call an MCU that allows devices to add participants to a conference (Direct Remote Add).

Default value:

Auto

Value space:

Auto/CUCMMediaResourceGroupList/MultiSite/Off

Auto: The multipoint method is selected automatically.

Multiparty conferences are set up using the built-in MultiSite feature, provided that the MultiSite option key is installed on the device, and that you are calling another video device (not an MCU). Only the MultiSite host can add participants. This prevents cascaded conferences. If the device doesn't have the MultiSite option key, you cannot call more than one video device on video. You may add one extra participant on audio-only.

Regardless of the MultiSite option key, multiparty conferences may be set up via an MCU if you call an MCU that allows devices to add participants to a conference (Direct Remote Add).

CUCMMediaResourceGroupList: Multiparty conferences are hosted by the CUCM configured conference bridge. This setting is provisioned by CUCM in a CUCM environment, and should never be set manually by the user.

MultiSite: Multiparty conferences are set up using the built-in MultiSite feature, provided that the MultiSite option key is installed on the device. If the device doesn't have the MultiSite option key, you cannot call more than one device on video. You may add one extra device on audio-only.

Off: You cannot call more than one device on video, but you may add one extra device on audio-only. Multiparty conferences may be set up via an MCU if you call an MCU that allows devices to add participants to a conference (Direct Remote Add).

Conference MicUnmuteOnDisconnect Mode

Applies to: All products

Requires user role: ADMIN

Define if the microphones shall be unmuted automatically when all calls are disconnected. In a meeting room or other shared resources this may be done to prepare the device for the next user.

Default value:

On

Value space:

Off/On

Off: If muted during a call, let the microphones remain muted after the call is disconnected.

On: Unmute the microphones after the call is disconnected.

Board

Board
ProCodec
EQCodec
PlusCodec
ProDesk,
Desk Pro,
Desk MiniRoom
Bar

Room Kit

Room Kit
Mini

Room 55

Room 55
Dual,
Room 70Room 70
G2Room 70
PanoramaRoom
Panorama

Conference MultiStream Mode

Applies to: RoomKit RoomKitMini RoomBar CodecEQ CodecPlus CodecPro Room55 Room70/Room55D Room70G2 RoomPanorama/Room70Panorama

Requires user role: ADMIN

In supported devices, Conference MultiStream Mode provides the option to turn on/off multistream.

Default value:

Auto

Value space:

Auto/Off

Auto: Multistream will be used when the conference infrastructure supports the feature. Minimum versions required: CMS 2.2, CUCM 11.5, VCS X8.7.

Off: Multistream is disabled. This does not have any effect for devices registered to the Webex cloud service, because these always use multistream. The same applies if your device is linked to Webex Edge for devices and the Webex optimized experience is enabled (that is, joining meetings through the Webex calling infrastructure).

Conference IncomingMultisiteCall Mode

Applies to: All products

Requires user role: ADMIN

Select whether or not to allow incoming calls when already in a call/conference.

Default value:

Allow

Value space:

Allow/Deny

Allow: You will be notified when someone calls you while you are already in a call. You can accept the incoming call or not. The ongoing call may be put on hold while answering the incoming call; or you may merge the calls (requires support for multiparty video conferences).

Deny: An incoming call will be rejected if you are already in a call. You will not be notified about the incoming call. However, the call will appear as a missed call in the call history list.

Conference PeopleFocus OnCall Mode

Applies to: All products

Requires user role: ADMIN

When you enable people focus, your local layout change dynamically to crop away empty background and optimize each participant's space on your screen.

This setting determines whether people focus is initially on or off when joining a meeting. Regardless, the user can toggle it on and off from the UI (Layout button) during the meeting.

Default value:

Previous

Value space:

Active/Inactive/Previous

Active: People focus is on when you join a meeting.

Inactive: People focus is off when you join a meeting.

Previous: When joining a new meeting, the initial people focus state (on or off) is the same as when you left the previous meeting.

Conference Presentation OnPlacedOnHold

Applies to: All products

Requires user role: ADMIN

Define whether or not to continue sharing a presentation after the remote site has put you on hold.

Default value:

NoAction

Value space:

NoAction/Stop

NoAction: The device will not stop the presentation sharing when put on hold. The presentation will not be shared while you are on hold, but it will continue automatically when the call is resumed.

Stop: The device stops the presentation sharing when the remote site puts you on hold. The presentation will not continue when the call is resumed.

Board

Board
ProCodec
EQCodec
PlusCodec
ProDesk,
Desk Pro,
Desk MiniRoom
Bar

Room Kit

Room Kit
Mini

Room 55

Room 55
Dual,
Room 70Room 70
G2Room 70
PanoramaRoom
Panorama

Conference Presentation RelayQuality

Applies to: All products

Requires user role: ADMIN

This configuration applies to devices that are using the built-in MultiSite feature (optional) to host a multipoint video conference. When a remote user shares a presentation, the device will transcode the presentation and send it to the other participants in the multipoint conference. The RelayQuality setting specifies whether to give priority to high frame rate or to high resolution for the presentation source.

Default value:

Sharpness

Value space:

Motion/Sharpness

Motion: Gives the highest possible frame rate. Used when there is a need for higher frame rates, typically when there is a lot of motion in the picture.

Sharpness: Gives the highest possible resolution. Used when you want the highest quality of detailed images and graphics.

FacilityService settings

The FacilityService configurations will soon be deprecated, as quick dial functionality can be created using UI Extensions and macros.

FacilityService Service [n] CallType

Applies to: RoomKit RoomKitMini RoomBar CodecEQ CodecPlus CodecPro Room55 Room70/Room55D Room70G2 RoomPanorama/Room70Panorama Desk DeskPro Board

Requires user role: ADMIN, INTEGRATOR

Define the call type for each facility service. Up to five different facility services are supported. A facility service is not available unless both the FacilityService Service [n] Name and the FacilityService Service [n] Number settings are properly set. Facility services are available from the user interface.

Default value:

Video

Value space:

Audio/Video

Audio: Select this option for audio calls.

Video: Select this option for video calls.

n: Unique ID that identifies the service.

Range: 1..5

FacilityService Service [n] Name

Applies to: RoomKit RoomKitMini RoomBar CodecEQ CodecPlus CodecPro Room55 Room70/Room55D Room70G2 RoomPanorama/Room70Panorama Desk DeskPro Board

Requires user role: ADMIN, INTEGRATOR

Define the name of the facility service. Up to five different facility services are supported. A facility service is not available unless both the FacilityService Service [n] Name and the FacilityService Service [n] Number settings are properly set. The name will show on the facility service call button, which appears when you tap the question mark icon in the top bar. Facility services are available from the user interface.

Default value:

Service 1: "Live Support" Other services: ""

Value space:

String (0, 1024)

The name of the facility service.

n: Unique ID that identifies the service.

Range: 1..5

Board

Board
ProCodec
EQCodec
PlusCodec
ProDesk,
Desk Pro,
Desk MiniRoom
Bar

Room Kit

Room Kit
Mini

Room 55

Room 55
Dual,
Room 70Room 70
G2Room 70
PanoramaRoom
Panorama

FacilityService Service [n] Number

Applies to: RoomKit RoomKitMini RoomBar CodecEQ CodecPlus CodecPro Room55 Room70/Room55D Room70G2 RoomPanorama/Room70Panorama Desk DeskPro Board

Requires user role: ADMIN, INTEGRATOR

Define the number (URI or phone number) of the facility service. Up to five different facility services are supported. A facility service is not available unless both the FacilityService Service [n] Name and the FacilityService Service [n] Number settings are properly set. Facility services are available from the user interface.

Default value:

""

Value space:

String (0, 1024)

The number (URI or phone number) of the facility service.

n: Unique ID that identifies the service.

Range: 1..5

FacilityService Service [n] Type

Applies to: RoomKit RoomKitMini RoomBar CodecEQ CodecPlus CodecPro Room55 Room70/Room55D Room70G2 RoomPanorama/Room70Panorama Desk DeskPro Board

Requires user role: ADMIN, INTEGRATOR

Up to five different facility services can be supported simultaneously. With this setting you can select what kind of services they are. A facility service is not available unless both the FacilityService Service [n] Name and the FacilityService Service [n] Number settings are properly set. Facility services are available from the user interface.

Default value:

Helpdesk

Value space:

Catering/Concierge/Emergency/Helpdesk/Security/Transportation/Other

Catering: Select this option for catering services.

Concierge: Select this option for concierge services.

Emergency: Select this option for emergency services.

Helpdesk: Select this option for helpdesk services.

Security: Select this option for security services.

Transportation: Select this option for transportation services.

Other: Select this option for services not covered by the other options.

n: Unique ID that identifies the service.

Range: 1..5

Files settings

Files Services OneDrive TemporaryPersonalSignIn

Applies to: All products

Requires user role: ADMIN, INTEGRATOR

When enabled, users can sign into their Microsoft OneDrive account and access their OneDrive files from the device. Also, whiteboards can be accessed, edited, and saved to OneDrive. The user is automatically signed out when the device goes to standby.

This feature is not available for Room 70 Panorama and Room Panorama in this software version.

Default value:

Disabled

Value space:

Disabled/Enabled

Disabled: Users don't have access to their OneDrive files and whiteboards from the device.

Enabled: Users can sign in and access their OneDrive files and store whiteboards.

Board

Board
ProCodec
EQCodec
PlusCodec
ProDesk,
Desk Pro,
Desk MiniRoom
Bar

Room Kit

Room Kit
Mini

Room 55

Room 55
Dual,
Room 70Room 70
G2Room 70
PanoramaRoom
Panorama

GPIO settings

GPIO Pin [n] Mode

Applies to: CodecPro Room70G2 RoomPanorama/Room70Panorama

Requires user role: ADMIN, INTEGRATOR

The four GPIO pins are configured individually. The actual measured pin state (Low/High) can be retrieved by the GPIO Pin [1..4] State status.

The default state for a pin in output mode is High (+12 V).

NOTE: A pin defined to output mode can be set to force line Low actively. If set to High, the line will be high only when it is not connected to an external device that pulls the line low.

Default value:

InputNoAction

Value space:

InputAcceptAllCalls/InputDisconnectAllCalls/InputMuteMicrophones/InputNoAction/
OutputAllCallsEncrypted/OutputInCall/OutputManualState/OutputMicrophonesMuted/
OutputPresentationOn/OutputStandbyActive

InputAcceptAllCalls: When the pin transitions from High to Low on an incoming call, the call will be accepted (the Call Accept command is issued automatically).

InputDisconnectAllCalls: When the pin transitions from High to Low during a call, call(s) will be disconnected (the Call Disconnect command is issued automatically).

InputMuteMicrophones: When the pin transitions from High to Low during a call, the microphones will be muted. When the pin transitions from Low to High during a call, the microphones will be unmuted (the Audio Mute and Audio Unmute commands are issued automatically).

InputNoAction: The pin state does not trigger any action. The pin state can be read with the GPIO Pin [1..4] State status.

OutputAllCallsEncrypted: The pin is set Low when all calls are encrypted, and High when one or more calls are not encrypted.

OutputInCall: The pin is set Low when in call, and High when not in call.

OutputManualState: The pin state can be set to High or Low by the GPIO ManualState Set PinX command. It is set to +12 V or 0 V, respectively.

OutputMicrophonesMuted: The pin is set Low when the microphones are muted, and High when they are not muted.

OutputPresentationOn: The pin is set Low when a presentation is active, and High when a presentation is not active.

OutputStandbyActive: The pin is set Low when the device is in standby mode, and High when the device is not in standby mode.

n: GPIO pin number.

Range: 1..4

H323 settings

H323 Authentication Mode

Applies to: All products

Requires user role: ADMIN

Define the authenticatin mode for the H.323 profile.

Default value:

Off

Value space:

Off/On

Off: The device will not try to authenticate itself to a H.323 Gatekeeper, but will still try a normal registration.

On: If an H.323 Gatekeeper indicates that it requires authentication, the device will try to authenticate itself to the gatekeeper. Requires the H323 Authentication LoginName and H323 Authentication Password settings to be defined on both the device and the Gatekeeper.

H323 Authentication LoginName

Applies to: All products

Requires user role: ADMIN

The device sends the H323 Authentication Login Name and the H323 Authentication Password to an H.323 Gatekeeper for authentication. The authentication is a one way authentication from the device to the H.323 Gatekeeper, that is, the device is authenticated to the gatekeeper. If the H.323 Gatekeeper indicates that no authentication is required, the device will still try to register. Requires the H.323 Authentication Mode to be enabled.

Default value:

""

Value space:

String (0, 50)

The authentication login name.

Board

Board
ProCodec
EQCodec
PlusCodec
ProDesk,
Desk Pro,
Desk MiniRoom
Bar

Room Kit

Room Kit
Mini

Room 55

Room 55
Dual,
Room 70Room 70
G2Room 70
PanoramaRoom
Panorama

H323 Authentication Password

Applies to: All products

Requires user role: ADMIN

The device sends the H323 Authentication Login Name and the H323 Authentication Password to an H.323 Gatekeeper for authentication. The authentication is a one way authentication from the device to the H.323 Gatekeeper, that is, the device is authenticated to the gatekeeper. If the H.323 Gatekeeper indicates that no authentication is required, the device will still try to register. Requires the H.323 Authentication Mode to be enabled.

Default value:

""

Value space:

String (0, 50)

The authentication password.

H323 CallSetup Mode

Applies to: All products

Requires user role: ADMIN

Defines whether to use a Gatekeeper or Direct calling when establishing H.323 calls. Direct H.323 calls can be made also when H323 CallSetup Mode is set to Gatekeeper.

Default value:

Gatekeeper

Value space:

Direct/Gatekeeper

Direct: You can only make an H.323 call by dialing an IP address directly.

Gatekeeper: The device uses a Gatekeeper to make an H.323 call. When choosing this option, the H323 Gatekeeper Address must also be configured.

H323 Encryption AES256Support

Applies to: All products

Requires user role: ADMIN

The device always supports 128-bit AES encryption keys for the media transport. You can configure the device to also support 256-bit keys. When using 256-bit keys the minimum key size for the Diffie-Hellman key exchange method should be 2048 bit (refer to the H323 Encryption KeySize setting).

Default value:

Off

Value space:

Off/On

Off: The device only supports 128-bit AES encryption keys.

On: The device supports both 128-bit and 256-bit AES encryption keys.

H323 Encryption KeySize

Applies to: All products

Requires user role: ADMIN

Define the minimum or maximum key size for the Diffie-Hellman key exchange method, which is used when establishing the Advanced Encryption Standard (AES) encryption key.

Default value:

Min1024bit

Value space:

Max1024bit/Min1024bit/Min2048bit

Max1024bit: The maximum size is 1024 bit.

Min1024bit: The minimum size is 1024 bit.

Min2048bit: The minimum size is 2048 bit.

H323 Gatekeeper Address

Applies to: All products

Requires user role: ADMIN

Define the IP address of the Gatekeeper. Requires H323 CallSetup Mode to be set to Gatekeeper.

Default value:

""

Value space:

String (0, 255)

A valid IPv4 address, IPv6 address or DNS name.

Board

H323 H323Alias E164

Applies to: All products

Requires user role: ADMIN

The H.323 Alias E.164 defines the address of the device, according to the numbering plan implemented in the H.323 Gatekeeper. The E.164 alias is equivalent to a telephone number, sometimes combined with access codes.

Default value:

""

Value space:

String (0, 30)

The H.323 Alias E.164 address. Valid characters are 0-9, * and #.

Board Pro

Codec EQ

Codec Plus

Codec Pro

Desk, Desk Pro, Desk Mini

Room Bar

Room Kit

Room Kit Mini

Room 55

Room 55 Dual, Room 70

Room 70 G2

Room 70 Panorama

Room Panorama

H323 NAT Mode

Applies to: All products

Requires user role: ADMIN

The H323 NAT Mode is intended to be used if your device is on a private network and is not registered to a gatekeeper. H323 NAT Mode can then be used to reach devices on a public network.

NAT is not supported for IPv6.

NOTE: The H323 NAT Mode and H323 NAT Address settings will be ignored if the video conferencing devices is registered to a gatekeeper. We recommend the use of a gatekeeper with firewall traversal capabilities, rather than using the H323 NAT Mode.

Default value:

Off

Value space:

Auto/Off/On

Auto: Auto mode works only if you have specified the NAT address in the H323 NAT Address setting.

NAT is turned On if the device is not registered to a gatekeeper, the local address of the device is private, the address you are calling (remote) is public, and both the local and remote addresses are IPv4. Otherwise, NAT is turned Off.

This means that you can place calls to devices on your private network as well as to external devices (outside your private network). For calls on your private network, the H323 NAT Address is not used (but must be present). For calls to the public network, the H323 NAT Address is used.

Off: NAT is turned off, and the H323 NAT Address setting will be ignored. In this case you will not be able to set up a call to a device that is outside of your private network unless you use a gatekeeper.

On: NAT is always turned on. You must specify the NAT address in the H323 NAT Address setting. The device will always signal the H323 NAT Address instead of its private IP address in Q.931 and H.245. If the H323 NAT Address is wrong or not set, H.323 calls cannot be set up.

Board

Board
ProCodec
EQCodec
PlusCodec
ProDesk,
Desk Pro,
Desk MiniRoom
Bar

Room Kit

Room Kit
Mini

Room 55

Room 55
Dual,
Room 70Room 70
G2Room 70
PanoramaRoom
Panorama

H323 NAT Address

Applies to: All products

Requires user role: ADMIN

Define the external/global IP address of the router with NAT support. This address will be exposed when setting up a call to devices outside your private network. Refer to the H323 NAT Mode setting for details when the NAT Address is used.

In the router, the following ports must be routed to the video conferencing device's IP address:

- * Port 1720
- * Port 5555-6555
- * Port 2326-2487

Default value:

""

Value space:

String (0, 64)

An IPv4 address. It's most often a public IP address, refer to RFC 1918, but it could also be another private address (for example in a larger company network).

H323 PortAllocation

Applies to: All products

Requires user role: ADMIN

This setting affects the H.245 port numbers used for H.323 call signaling.

Default value:

Dynamic

Value space:

Dynamic/Static

Dynamic: The system will allocate which ports to use when opening a TCP connection. The reason for doing this is to avoid using the same ports for subsequent calls, as some firewalls consider this as a sign of attack. When Dynamic is selected, the H.323 ports used are from 11000 to 20999. Once 20999 is reached they restart again at 11000. The ports are automatically selected by the system within the given range. Firewall administrators should not try to deduce which ports are used when, as the allocation schema within the mentioned range may change without any further notice.

Static: When set to Static the ports are given within a static predefined range [5555-6555].

HttpClient settings

HttpClient Mode

Applies to: All products

Requires user role: ADMIN

Allow or prohibit communication with an external HTTP(S) server using HTTP(S) requests and responses.

Default value:

Off

Value space:

Off/On

Off: The video conferencing device cannot communicate with an external HTTP(S) server.

On: The video conferencing device is allowed to communicate with an external HTTP(S) server.

HttpClient AllowHTTP

Applies to: All products

Requires user role: ADMIN

The HttpClient Mode setting is used to allow or prohibit communication with an external HTTP(S) server. The Mode setting does not distinguish between HTTP and HTTPS. You must use the HttpClient AllowHTTP setting to further allow or prohibit the use of HTTP.

Default value:

True

Value space:

False/True

False: The video conferencing device can communicate only over HTTPS.

True: The video conferencing device can communicate over both HTTPS and HTTP.

Board

HttpClient AllowInsecureHTTPS

Applies to: All products

Requires user role: ADMIN

You can choose whether or not to allow the video conferencing device to communicate with a server over HTTPS without checking the server's certificate first.

Even if the device is allowed to skip the certificate validation process, it doesn't automatically do it. You must specifically set the AllowInsecureHTTPS parameter in each xCommand HttpClient command for data to be exchanged with the server without certificate validation.

Default value:

False

Value space:

False/True

False: The device always checks that the HTTPS server has a valid certificate. No communication with the server takes place if the certificate validation fails.

True: The device is allowed to skip the certificate validation process before communicating with the server.

HttpClient UseHttpProxy

Applies to: All products

Requires user role: ADMIN

There are several UseHttpProxy settings that specify if a service shall communicate via an HTTP proxy or not. The HttpClient UseHttpProxy setting applies to macros and arbitrary HTTP(S) requests using the HttpClient commands.

For this setting to have any effect, a proxy server for HTTP, HTTPS, and WebSocket traffic must be set up using the NetworkServices HTTP Proxy settings.

Default value:

On

Value space:

Off/On

Off: Set up communication directly with the server (not using a proxy).

On: Set up communication via proxy.

HttpFeedback settings

HttpFeedback TlsVerify

Applies to: All products

Requires user role: ADMIN

This setting applies when a video conferencing device connects to an HTTPS server for arbitrary HTTPS communication (refer to the HttpClient Post/Put/Patch/Get/Delete commands). For phone book, provisioning, and external logging servers, see the Phonebook Server 1 TlsVerify, Provisioning TlsVerify, and Logging External TlsVerify settings.

Before establishing a connection between the device and the HTTPS server, the device checks if the certificate of the server is signed by a trusted Certificate Authority (CA). The CA certificate must be included in the CA list on the device, either pre-installed or manually uploaded using the web interface or API.

In general, the minimum TLS (Transport Layer Security) version for the HTTPS connection is 1.1. There are two exceptions to this rule: 1) For compatibility reasons, the minimum TLS version is 1.0 for devices that are registered to CUCM. 2) Devices registered to the Webex cloud service always use version 1.2.

Note: The value is set to Off for a device that has been upgraded to CE9.9 (or later) from CE9.8 or earlier software versions, provided that the device has not been factory reset after the upgrade, and that the old NetworkServices HTTPS VerifyServerCertificate setting was not explicitly set to On.

Default value:

On

Value space:

Off/On

Off: The device doesn't check the certificate of the HTTPS server.

On: The device checks if the certificate of the HTTPS server can be trusted. If not, the connection between the device and the server is not established.

Board

Board
ProCodec
EQCodec
PlusCodec
ProDesk,
Desk Pro,
Desk MiniRoom
Bar

Room Kit

Room Kit
Mini

Room 55

Room 55
Dual,
Room 70Room 70
G2Room 70
PanoramaRoom
Panorama

HttpFeedback UseHttpProxy

Applies to: All products

Requires user role: ADMIN

There are several UseHttpProxy settings that specify if a service shall communicate via an HTTP proxy or not. The HttpFeedback UseHttpProxy setting applies to feedback sent from the video device.

For this setting to have any effect, a proxy server for HTTP, HTTPS, and WebSocket traffic must be set up using the NetworkServices HTTP Proxy settings.

Default value:

On

Value space:

Off/On

Off: Set up communication directly with the server (not using a proxy).

On: Set up communication via proxy.

Logging settings

Logging CloudUpload Mode

Applies to: All products

Requires user role: ADMIN

Specify whether or not logs from the device can be uploaded to the Webex cloud service. The device logs will be filtered for personally-identifiable information before they are sent to the cloud.

When enabled, the log upload can be initiated from the device itself or from Control Hub. The device will display a "Send logs" button on the user interface, and there will be a "Manage Logs" section on the Devices page in Control Hub.

The device must either be registered to the Webex cloud service or registered to an on-premises service and linked to Webex Edge for Devices.

Default value:

Off

Value space:

Off/On

Off: Logs from the device can not be uploaded to the Webex cloud.

On: Logs from the device can be uploaded to the Webex cloud.

Logging Debug Bluetooth

Applies to: All products

Requires user role: ADMIN

When this option is enabled, the video conferencing device logs more information about the set-up and maintenance of a Bluetooth connection. This may be useful when you are troubleshooting Bluetooth connection issues.

Default value:

On

Value space:

Off/On

Off: Logging only basic Bluetooth information.

On: Logging a large amount of information about the Bluetooth connection.

Board

Board
ProCodec
EQCodec
PlusCodec
ProDesk,
Desk Pro,
Desk MiniRoom
Bar

Room Kit

Room Kit
Mini

Room 55

Room 55
Dual,
Room 70Room 70
G2Room 70
PanoramaRoom
Panorama

Logging Debug Wifi

Applies to: All products

Requires user role: ADMIN

When this option is enabled, the device logs more information about the set-up and maintenance of the Wi-Fi connection between the device and the access point. This may be useful when you are troubleshooting Wi-Fi connection issues.

Default value:

On

Value space:

Off/On

Off: Logging only basic Wi-Fi information.

On: Logging a large amount of information about the Wi-Fi connection.

Logging External Mode

Applies to: All products

Requires user role: ADMIN

Specify whether or not to store the device logs on a remote syslog server. This setting has no effect if the Logging Mode setting is set to Off.

You must enter the address of the remote server in the Logging External Server Address setting. Unless otherwise specified in the Logging External Server Port setting, the standard syslog port is used.

Default value:

Off

Value space:

Off/On

Off: Device logs will not be stored on the remote syslog server.

On: Device logs will be stored on the remote syslog server.

Logging External Protocol

Applies to: All products

Requires user role: ADMIN

Specify which protocol to use toward the remote logging server. You can use either the syslog protocol over TLS (Transport Layer Security), or the syslog protocol in plaintext. For details about the syslog protocol, see RFC 5424.

Default value:

SyslogTLS

Value space:

Syslog/SyslogTLS

Syslog: Syslog protocol in plain text.

SyslogTLS: Syslog protocol over TLS.

Logging External Server Address

Applies to: All products

Requires user role: ADMIN

Specify the address of the remote syslog server.

Default value:

""

Value space:

String (0, 255)

A valid IPv4 address, IPv6 address or DNS name.

Logging External Server Port

Applies to: All products

Requires user role: ADMIN

The port that the remote syslog server listens for messages on. If set to 0, the device will use the standard syslog port. The standard syslog port is 514 for syslog, and 6514 for syslog over TLS.

Default value:

514

Value space:

Integer (0..65535)

The number of the port that the remote syslog server is using. 0 means that the device uses the standard syslog port.

Board

Board
ProCodec
EQCodec
PlusCodec
ProDesk,
Desk Pro,
Desk MiniRoom
Bar

Room Kit

Room Kit
Mini

Room 55

Room 55
Dual,
Room 70Room 70
G2Room 70
PanoramaRoom
Panorama

Logging External TlsVerify

Applies to: All products

Requires user role: ADMIN

This setting applies when a video conferencing device connects to a remote syslog server. It applies to both regular logging (refer to the Logging External Mode setting) and audit logging (refer to the Security Audit Logging Mode setting).

Before establishing a connection between the device and the syslog server, the device checks if the certificate of the server is signed by a trusted Certificate Authority (CA). The CA certificate must be included in the CA list on the device, either pre-installed or manually uploaded using the web interface or API.

The minimum TLS (Transport Layer Security) version for the syslog connection is 1.1.

Default value:

On

Value space:

Off/On

Off: The device doesn't check the certificate of the syslog server.

On: The device checks if the certificate of the syslog server can be trusted. If not, the connection between the device and the server is not established.

Logging Internal Mode

Applies to: All products

Requires user role: ADMIN

Specify whether or not to store the system logs on the device (local files). These are the files that you get when you download the log bundles from the device. This setting has no effect if the Logging Mode setting is set to Off.

Default value:

On

Value space:

Off/On

Off: System logs will not be stored on the device.

On: System logs will be stored on the device.

Logging Mode

Applies to: All products

Requires user role: ADMIN

Define the logging mode for the device (syslog service). When disabled, the syslog service does not start, and most of the system and audit logs are not generated. The Historical Logs and Call Logs are not affected.

Default value:

On

Value space:

Off/On

Off: Disable the system logging service.

On: Enable the system logging service.

Board

Board
ProCodec
EQCodec
PlusCodec
ProDesk,
Desk Pro,
Desk MiniRoom
Bar

Room Kit

Room Kit
Mini

Room 55

Room 55
Dual,
Room 70Room 70
G2Room 70
PanoramaRoom
Panorama

Macros settings

Macros Mode

Applies to: All products

Requires user role: ADMIN

Macros allow you to write snippets of JavaScript code that can automate parts of your video conferencing device, thus creating custom behavior. Use of macros is disabled by default, but the first time you open the Macro Editor you will be asked whether to enable use of macros on the device. Use this setting when you want to manually enable, or to permanently disable the use of macros on the device. You can disable the use of macros within the Macro Editor. But this will not permanently disable macros from running, because every time the device is reset the macros will be re-enabled automatically.

Default value:

Off

Value space:

Off/On

Off: Permanently disable the use of macros on this device.

On: Enable the use of macros on this device.

Macros AutoStart

Applies to: All products

Requires user role: ADMIN

All the macros run in a single process on the video conferencing device, called the macro runtime. It should be running by default, but you can choose to stop and start it manually. If you restart the device, the runtime will automatically start again if auto start is enabled.

Default value:

On

Value space:

Off/On

Off: The macro runtime will not start automatically after a restart of the device.

On: The macro runtime will start automatically after a restart of the device.

Macros Diagnostics JavascriptErrors

Applies to: All products

Requires user role: ADMIN

Choose whether to issue diagnostics messages for errors in, or related to, macros.

Default value:

On

Value space:

Off/On

Off: Don't expose macro logged errors as diagnostics.

On: Expose macro logged errors as diagnostics.

Macros QuickJSEngine

Applies to: All products

Requires user role: ADMIN

Changes which javascript engine type to use for running macro code. It is not recommended to change this configuration.

Default value:

Off

Value space:

Off/On

On: Use QuickJS as the macro javascript engine.

Off: Use Duktape as the macro javascript engine.

Macros UnresponsiveTimeout

Applies to: All products

Requires user role: ADMIN

Macros are continuously monitored to detect unresponsive code. Unresponsive macros are typically a sign of a programming error, but occasionally it might be due to limited system resources. Increasing the value allows macros to run for longer without being terminated, while decreasing the value ensures that faulty macros do not consume system resources.

Default value:

5

Value space:

Integer (0..65535)

Set the number of seconds before terminating an unresponsive macro. The value 0 disables the check altogether.

Board

Board
ProCodec
EQCodec
PlusCodec
ProDesk,
Desk Pro,
Desk MiniRoom
Bar

Room Kit

Room Kit
Mini

Room 55

Room 55
Dual,
Room 70Room 70
G2Room 70
PanoramaRoom
Panorama

Macros XAPI Transport

Applies to: All products

Requires user role: ADMIN

Set the xAPI transport method used in the macro system.

Default value:

WebSocket

Value space:

TSH/WebSocket

TSH: The xAPI transport method for macros is t-shell.

WebSocket: The xAPI transport method for macros is WebSockets.

Network settings

Network [n] DNS DNSSEC Mode

Applies to: All products

Requires user role: ADMIN

Domain Name System Security extensions (DNSSEC) is a set of extensions to DNS. It is used to authenticate DNS replies for zones that are signed. It will still allow unsigned zones.

Default value:

Off

Value space:

Off/On

Off: Disable Domain Name System Security Extensions.

On: Enable Domain Name System Security Extensions.

n: Index that identifies the network.

Range: 1..1

Network [n] DNS Domain Name

Applies to: All products

Requires user role: ADMIN

The DNS Domain Name is the default domain name suffix which is added to unqualified names.

Example: If the DNS Domain Name is "company.com" and the name to lookup is "MyVideoSystem", this will result in the DNS lookup "MyVideoSystem.company.com".

Default value:

" "

Value space:

String (0, 64)

The DNS domain name.

n: Index that identifies the network.

Range: 1..1

Board

Board
ProCodec
EQCodec
PlusCodec
ProDesk,
Desk Pro,
Desk MiniRoom
Bar

Room Kit

Room Kit
Mini

Room 55

Room 55
Dual,
Room 70Room 70
G2Room 70
PanoramaRoom
Panorama

Network [n] DNS Server [m] Address

Applies to: All products

Requires user role: ADMIN

Define the network addresses for DNS servers. Up to three addresses may be specified. If the network addresses are unknown, contact your administrator or Internet Service Provider.

Default value:

""

Value space:

String (0, 64)

A valid IPv4 address or IPv6 address.

n: Index that identifies the network.

Range: 1..1

m: Index that identifies the DNS server. **Maximum three DNS servers are allowed.**

Range: 1..3

Network [n] IEEE8021X Mode

Applies to: All products

Requires user role: ADMIN

The device can be connected to an IEEE 802.1X LAN network, with a port-based network access control that is used to provide authenticated network access for Ethernet networks.

Default value:

Off

Value space:

Off/On

Off: The 802.1X authentication is disabled.

On: The 802.1X authentication is enabled.

n: Index that identifies the network.

Range: 1..1

Network [n] IEEE8021X TlsVerify

Applies to: All products

Requires user role: ADMIN

Verification of the server-side certificate of an IEEE802.1x connection against the certificates in the local CA-list when TLS is used. The CA-list must be uploaded to the video conferencing device. This can be done from the web interface.

This setting takes effect only when Network [1] IEEE8021X Eap Tls is enabled (On).

Default value:

Off

Value space:

Off/On

Off: When set to Off, TLS connections are allowed without verifying the server-side X.509 certificate against the local CA-list. This should typically be selected if no CA-list has been uploaded to the device.

On: When set to On, the server-side X.509 certificate will be validated against the local CA-list for all TLS connections. Only servers with a valid certificate will be allowed.

n: Index that identifies the network.

Range: 1..1

Network [n] IEEE8021X UseClientCertificate

Applies to: All products

Requires user role: ADMIN

Authentication using a private key/certificate pair during an IEEE802.1x connection. The authentication X.509 certificate must be uploaded to the video conferencing device. This can be done from the web interface.

Default value:

Off

Value space:

Off/On

Off: When set to Off client-side authentication is not used (only server-side).

On: When set to On the client (video conferencing device) will perform a mutual authentication TLS handshake with the server.

n: Index that identifies the network.

Range: 1..1

Board

Network [n] IEEE8021X Identity

Applies to: All products

Requires user role: ADMIN

Define the username for 802.1X authentication.

Default value:

""

Value space:

String (0, 64)

The username for 802.1X authentication.

n: Index that identifies the network.

Range: 1..1

Board
ProCodec
EQCodec
PlusCodec
ProDesk,
Desk Pro,
Desk MiniRoom
Bar

Room Kit

Room Kit
Mini

Room 55

Room 55
Dual,
Room 70Room 70
G2Room 70
PanoramaRoom
Panorama

Network [n] IEEE8021X AnonymousIdentity

Applies to: All products

Requires user role: ADMIN

The 802.1X Anonymous ID string is to be used as unencrypted identity with EAP (Extensible Authentication Protocol) types that support different tunneled identity, like EAP-PEAP and EAP-TTLS. If set, the anonymous ID will be used for the initial (unencrypted) EAP Identity Request.

Default value:

""

Value space:

String (0, 64)

The 802.1X Anonymous ID string.

n: Index that identifies the network.

Range: 1..1

Network [n] IEEE8021X Eap Md5

Applies to: All products

Requires user role: ADMIN

Define the Md5 (Message-Digest Algorithm 5) mode. This is a Challenge Handshake Authentication Protocol that relies on a shared secret. Md5 is a Weak security.

Default value:

On

Value space:

Off/On

Off: The EAP-MD5 protocol is disabled.

On: The EAP-MD5 protocol is enabled.

n: Index that identifies the network.

Range: 1..1

Board

Network [n] IEEE8021X Eap Ttls

Applies to: All products

Requires user role: ADMIN

Define the TTLS (Tunneled Transport Layer Security) mode. Authenticates LAN clients without the need for client certificates. Developed by Funk Software and Certicom. Usually supported by Agere Systems, Proxim and Avaya.

Default value:

On

Value space:

Off/On

Off: The EAP-TTLS protocol is disabled.

On: The EAP-TTLS protocol is enabled.

n: Index that identifies the network.

Range: 1..1

Board Pro

Codec EQ

Codec Plus

Codec Pro

Desk, Desk Pro, Desk Mini

Room Bar

Room Kit

Room Kit Mini

Room 55

Room 55 Dual, Room 70

Room 70 G2

Room 70 Panorama

Room Panorama

Network [n] IEEE8021X Eap Peap

Applies to: All products

Requires user role: ADMIN

Define the Peap (Protected Extensible Authentication Protocol) mode. Authenticates LAN clients without the need for client certificates. Developed by Microsoft, Cisco and RSA Security.

Default value:

On

Value space:

Off/On

Off: The EAP-PEAP protocol is disabled.

On: The EAP-PEAP protocol is enabled.

n: Index that identifies the network.

Range: 1..1

Network [n] IPStack

Applies to: All products

Requires user role: ADMIN

Select if the device should use IPv4, IPv6, or dual IP stack, on the network interface. NOTE: After changing this setting you may have to wait up to 30 seconds before it takes effect.

Default value:

Dual

Value space:

Dual/IPv4/IPv6

Dual: When set to Dual, the network interface can operate on both IP versions at the same time, and can have both an IPv4 and an IPv6 address at the same time.

IPv4: When set to IPv4, the device will use IPv4 on the network interface.

IPv6: When set to IPv6, the device will use IPv6 on the network interface.

n: Index that identifies the network.

Range: 1..1

Board

Board
ProCodec
EQCodec
PlusCodec
ProDesk,
Desk Pro,
Desk MiniRoom
Bar

Room Kit

Room Kit
Mini

Room 55

Room 55
Dual,
Room 70Room 70
G2Room 70
PanoramaRoom
Panorama

Network [n] IPv4 Assignment

Applies to: All products

Requires user role: ADMIN

Define how the device will obtain its IPv4 address, subnet mask and gateway address. The client identifier, which is used in the DHCP requests, is different for different products: MAC address (Touch 10), "01" followed by the MAC address (Room Kit, Room Kit Mini, Room 55, Room 70, Room 70 G2, Room 70 Panorama, Room Panorama, Board, Codec Plus, and Codec Pro), and DHCP Unique Identifier (DUID) as specified in RFC 4361 (other products, including Room Navigator).

Default value:

DHCP

Value space:

Static/DHCP

Static: The addresses must be configured manually using the Network IPv4 Address, Network IPv4 Gateway and Network IPv4 SubnetMask settings (static addresses).

DHCP: The device addresses are automatically assigned by the DHCP server.

n: Index that identifies the network.

Range: 1..1

Network [n] IPv4 Address

Applies to: All products

Requires user role: ADMIN

Define the static IPv4 network address for the device. Applicable only when Network IPv4 Assignment is set to Static.

Default value:

" "

Value space:

String (0, 64)

A valid IPv4 address.

n: Index that identifies the network.

Range: 1..1

Network [n] IPv4 Gateway

Applies to: All products

Requires user role: ADMIN

Define the IPv4 network gateway address. Applicable only when the Network IPv4 Assignment is set to Static.

Default value:

" "

Value space:

String (0, 64)

A valid IPv4 address.

n: Index that identifies the network.

Range: 1..1

Network [n] IPv4 InterfacelIdentifier

Applies to: All products

Requires user role: ADMIN

Select which identifier to use for IPv4 DHCP.

Default value:

Auto

Value space:

Auto/MAC/Opaque

MAC: The device will send "01" followed by the MAC address of the device as identifier.

Opaque: The device will use an RFC4361-based DHCP Unique Identifier (DUID); DUID-LL, based on the link-layer address with no timestamp.

Auto: The use of MAC or Opaque as identifier depends on the product. MAC address (Touch 10), "01" followed by the MAC address (Room Kit, Room Kit Mini, Room 55, Room 70, Room 70 G2, Room 70 Panorama, Room Panorama, Board, Codec Plus, and Codec Pro), and DHCP Unique Identifier (DUID) as specified in RFC 4361 (other products, including Room Navigator).

n: Index that identifies the network.

Range: 1..1

Board

Network [n] IPv4 SubnetMask

Applies to: All products

Requires user role: ADMIN

Define the IPv4 network subnet mask. Applicable only when the Network IPv4 Assignment is set to Static.

Default value:

" "

Value space:

String (0, 64)

A valid IPv4 address.

n: Index that identifies the network.

Range: 1..1

Board
ProCodec
EQCodec
PlusCodec
ProDesk,
Desk Pro,
Desk MiniRoom
Bar

Network [n] IPv6 Assignment

Applies to: All products

Requires user role: ADMIN

Define how the device will obtain its IPv6 address, subnet mask and gateway address.

The client identifier, which is used in the DHCP requests, is different for different products: MAC address (Touch 10), "01" followed by the MAC address (Room Kit, Room Kit Mini, Room 55, Room 70, Room 70 G2, Room 70 Panorama, Room Panorama, Board, Codec Plus, and Codec Pro), and DHCP Unique Identifier (DUID) as specified in RFC 4361 (other products, including Room Navigator).

Default value:

Autoconf

Value space:

Static/DHCPv6/Autoconf

Static: The device and gateway IP addresses must be configured manually using the Network IPv6 Address and Network IPv6 Gateway settings. The options, for example NTP and DNS server addresses, must either be set manually or obtained from a DHCPv6 server. The Network IPv6 DHCPOptions setting determines which method to use.

DHCPv6: All IPv6 addresses, including options, will be obtained from a DHCPv6 server. See RFC 3315 for a detailed description. The Network IPv6 DHCPOptions setting will be ignored.

Autoconf: Enable IPv6 stateless autoconfiguration of the IPv6 network interface. See RFC 4862 for a detailed description. The options, for example NTP and DNS server addresses, must either be set manually or obtained from a DHCPv6 server. The Network IPv6 DHCPOptions setting determines which method to use.

n: Index that identifies the network.

Range: 1..1

Room Kit

Room Kit
Mini

Room 55

Room 55
Dual,
Room 70Room 70
G2Room 70
PanoramaRoom
Panorama

Network [n] IPv6 Address

Applies to: All products

Requires user role: ADMIN

Define the static IPv6 network address for the device. Applicable only when the Network IPv6 Assignment is set to Static.

Default value:

" "

Value space:

String (0, 64)

A valid IPv6 address including a network mask. Example: 2001:DB8::/48

n: Index that identifies the network.

Range: 1..1

Network [n] IPv6 Gateway

Applies to: All products

Requires user role: ADMIN

Define the IPv6 network gateway address. This setting is only applicable when the Network IPv6 Assignment is set to Static.

Default value:

" "

Value space:

String (0, 64)

A valid IPv6 address.

n: Index that identifies the network.

Range: 1..1

Board

Network [n] IPv6 DHCPOptions

Applies to: All products

Requires user role: ADMIN

Retrieve a set of DHCP options, for example NTP and DNS server addresses, from a DHCPv6 server.

Default value:

On

Value space:

Off/On

Off: Disable the retrieval of DHCP options from a DHCPv6 server.

On: Enable the retrieval of a selected set of DHCP options from a DHCPv6 server.

n: Index that identifies the network.

Range: 1..1

Board Pro

Codec EQ

Codec Plus

Codec Pro

Desk, Desk Pro, Desk Mini

Room Bar

Network [n] IPv6 InterfacelIdentifier

Applies to: All products

Requires user role: ADMIN

Define the IPv6 interface identifier for the device. The interface identifier you choose, either MAC or Opaque, will determine the method that is used for generating part of the the IPv6 address. This is applicable to both link-local IPv6 addresses and Stateless Address Autoconfiguration (SLAAC) addresses.

The address contains a 64-bit prefix and a 64-bit interface identifier generated by the device. With MAC, an EUI-64 based interface identifier is generated, as described in RFC-2373.

With Opaque, a random 64-bit interface identifier is generated as described in RFC-7217 on the first boot of the device, and this is used forever, or until factory reset.

Default value:

MAC

Value space:

MAC/Opaque

MAC: Select MAC as the Interface Identifier method.

Opaque: Select Opaque as the Interface Identifier method.

n: Index that identifies the network.

Range: 1..1

Room Kit

Room Kit Mini

Room 55

Room 55 Dual, Room 70

Room 70 G2

Room 70 Panorama

Room Panorama

Network [n] MTU

Applies to: All products

Requires user role: ADMIN

Define the Ethernet MTU (Maximum Transmission Unit) size. The MTU size must be supported by your network infrastructure. The minimum size is 576 for IPv4 and 1280 for IPv6.

Default value:

1500

Value space:

Integer (576..1500)

Set a value for the MTU (bytes).

n: Index that identifies the network.

Range: 1..1

Network [n] QoS Mode

Applies to: All products

Requires user role: ADMIN

The QoS (Quality of Service) is a method which handles the priority of audio, video and other data in the network. The QoS settings must be supported by the infrastructure. Diffserv (Differentiated Services) is a networking architecture that specifies a simple, scalable and coarse-grained mechanism for classifying and managing network traffic. It provides QoS priorities on IP networks.

Default value:

Diffserv

Value space:

Off/Diffserv

Off: No QoS method is used.

Diffserv: The Network QoS Diffserv Audio, Network QoS Diffserv Video, Network QoS Diffserv Data, Network QoS Diffserv Signalling, Network QoS Diffserv ICMPv6 and Network QoS Diffserv NTP settings are used to prioritize packets.

n: Index that identifies the network.

Range: 1..1

Board

Board
ProCodec
EQCodec
PlusCodec
ProDesk,
Desk Pro,
Desk MiniRoom
Bar

Room Kit

Room Kit
Mini

Room 55

Room 55
Dual,
Room 70Room 70
G2Room 70
PanoramaRoom
Panorama

Network [n] QoS Diffserv Audio

Applies to: All products

Requires user role: ADMIN

This setting takes effect only if Network QoS Mode is set to Diffserv.

Define which priority Audio packets should have in the IP network. The traffic classes recommended in the DiffServ RFCs map to a decimal value between 0 and 63. We recommend you use EF for Audio. EF equals the decimal value 46.

The priority set here might be overridden when packets are leaving the network controlled by the local network administrator.

Default value:

46

Value space:

Integer (0..63)

Set the priority of the audio packets in the IP network. 0 means "best-effort".

n: Index that identifies the network.

Range: 1..1

Network [n] QoS Diffserv Video

Applies to: All products

Requires user role: ADMIN

This setting takes effect only if Network QoS Mode is set to Diffserv.

Define which priority Video packets should have in the IP network. The packets of the presentation channel (shared content) are also in the Video packet category. The traffic classes recommended in the DiffServ RFCs map to a decimal value between 0 and 63. We recommend you use AF41 for Video. AF41 equals the decimal value 34.

The priority set here might be overridden when packets are leaving the network controlled by the local network administrator.

Default value:

34

Value space:

Integer (0..63)

Set the priority of the video packets in the IP network. 0 means "best-effort".

n: Index that identifies the network.

Range: 1..1

Network [n] QoS Diffserv Data

Applies to: All products

Requires user role: ADMIN

This setting takes effect only if Network QoS Mode is set to Diffserv.

Define which priority Data packets should have in the IP network. The traffic classes recommended in the DiffServ RFCs map to a decimal value between 0 and 63. We recommend you use AF41 for Data. AF41 equals the decimal value 34.

The priority set here might be overridden when packets are leaving the network controlled by the local network administrator.

Default value:

34

Value space:

Integer (0..63)

Set the priority of the data packets in the IP network. 0 means "best-effort".

n: Index that identifies the network.

Range: 1..1

Network [n] QoS Diffserv Signalling

Applies to: All products

Requires user role: ADMIN

This setting takes effect only if Network QoS Mode is set to Diffserv.

Define which priority Signalling packets that are deemed critical (time-sensitive) for the real-time operation should have in the IP network. The traffic classes recommended in the DiffServ RFCs map to a decimal value between 0 and 63. We recommend you use CS3 for Signalling. CS3 equals the decimal value 24.

The priority set here might be overridden when packets are leaving the network controlled by the local network administrator.

Default value:

24

Value space:

Integer (0..63)

Set the priority of the signalling packets in the IP network. 0 means "best-effort".

n: Index that identifies the network.

Range: 1..1

Board

Network [n] QoS Diffserv ICMPv6

Applies to: All products

Requires user role: ADMIN

This setting takes effect only if Network QoS Mode is set to Diffserv.

Define which priority ICMPv6 packets should have in the IP network. The traffic classes recommended in the DiffServ RFCs map to a decimal value between 0 and 63. We recommend you use 0 for ICMPv6.

The priority set here might be overridden when packets are leaving the network controlled by the local network administrator.

Default value:

0

Value space:

Integer (0..63)

Set the priority of the ICMPv6 packets in the IP network. 0 means "best effort".

n: Index that identifies the network.

Range: 1..1

Board Pro

Codec EQ

Codec Plus

Codec Pro

Desk, Desk Pro, Desk Mini

Room Bar

Room Kit

Room Kit Mini

Room 55

Room 55 Dual, Room 70

Room 70 G2

Room 70 Panorama

Room Panorama

Network [n] RemoteAccess Allow

Applies to: All products

Requires user role: ADMIN

Define which IP addresses (IPv4/IPv6) are allowed for remote access to the device from SSH/HTTP/HTTPS. Multiple IP addresses are separated by a white space.

A network mask (IP range) is specified by <ip address>/N, where N is 1-32 for IPv4, and N is 1-128 for IPv6. The /N is a common indication of a network mask where the first N bits are set. Thus 192.168.0.0/24 would match any address starting with 192.168.0, since these are the first 24 bits in the address.

Default value:

" "

Value space:

String (0, 255)

A valid IPv4 address or IPv6 address.

n: Index that identifies the network.

Range: 1..1

Network [n] Speed

Applies to: All products

Requires user role: ADMIN, INTEGRATOR

Define the Ethernet link speed. We recommend not to change from the default value, which negotiates with the network to set the speed automatically. If you do not use auto-negotiation, make sure that the speed you choose is supported by the closest switch in your network infrastructure.

Default value:

Auto

Value space:

Auto/10half/10full/100half/100full/1000full

Auto: Auto-negotiate link speed.

10half: Force link to 10 Mbps half-duplex.

10full: Force link to 10 Mbps full-duplex.

100half: Force link to 100 Mbps half-duplex.

100full: Force link to 100 Mbps full-duplex.

1000full: Force link to 1 Gbps full-duplex.

n: Index that identifies the network.

Range: 1..1

Board

Network [n] TrafficControl Mode

Applies to: All products

Requires user role: ADMIN

Define the network traffic control mode to decide how to control the video packets transmission speed.

Default value:

On

Value space:

Off/On

Off: Transmit video packets at link speed.

On: Transmit video packets at maximum 20 Mbps. Can be used to smooth out bursts in the outgoing network traffic.

n: Index that identifies the network.

Range: 1..1

Board Pro

Codec EQ

Codec Plus

Codec Pro

Desk, Desk Pro, Desk Mini

Room Bar

Room Kit

Room Kit Mini

Room 55

Room 55 Dual, Room 70

Room 70 G2

Room 70 Panorama

Room Panorama

Network [n] VLAN Voice VlanId

Applies to: All products

Requires user role: ADMIN

Define the VLAN voice ID. This setting will only take effect if Network VLAN Voice Mode is set to Manual.

Default value:

1

Value space:

Integer (1..4094)

Set the VLAN voice ID.

n: Index that identifies the network.

Range: 1..1

Network [n] VLAN Voice Mode

Applies to: All products

Requires user role: ADMIN

Define the VLAN voice mode. The VLAN Voice Mode will be set to Auto automatically if you have Cisco UCM (Cisco Unified Communications Manager) as provisioning infrastructure. Note that Auto mode will NOT work if the NetworkServices CDP Mode setting is Off.

Default value:

Auto

Value space:

Auto/Manual/Off

Auto: The Cisco Discovery Protocol (CDP), if available, assigns an id to the voice VLAN. If CDP is not available, VLAN is not enabled.

Manual: The VLAN ID is set manually using the Network VLAN Voice VlanId setting. If CDP is available, the manually set value will be overruled by the value assigned by CDP.

Off: VLAN is not enabled.

n: Index that identifies the network.

Range: 1..1

Board

Board
ProCodec
EQCodec
PlusCodec
ProDesk,
Desk Pro,
Desk MiniRoom
Bar

Room Kit

Room Kit
Mini

Room 55

Room 55
Dual,
Room 70Room 70
G2Room 70
PanoramaRoom
Panorama

NetworkServices settings

NetworkServices CDP Mode

Applies to: All products

Requires user role: ADMIN

Enable or disable the CDP (Cisco Discovery Protocol) daemon. Enabling CDP will make the device report certain statistics and device identifiers to a CDP-enabled switch. If CDP is disabled, the Network VLAN Voice Mode: Auto setting will not work.

Default value:

On

Value space:

Off/On

Off: The CDP daemon is disabled.

On: The CDP daemon is enabled.

NetworkServices H323 Mode

Applies to: All products

Requires user role: ADMIN

Define whether the device should be able to place and receive H.323 calls or not.

Default value:

Off

Value space:

Off/On

Off: Disable the possibility to place and receive H.323 calls.

On: Enable the possibility to place and receive H.323 calls.

NetworkServices HTTP Mode

Applies to: All products

Requires user role: ADMIN

Define whether or not to allow access to the device using the HTTP or HTTPS (HTTP Secure) protocols. Note that the device's web interface use HTTP or HTTPS. If this setting is switched Off, you cannot use the web interface.

For additional security (encryption and decryption of requests and pages that are returned by the web server), allow only HTTPS.

Note: The default value is HTTP+HTTPS for devices that have been upgraded to CE9.4 (or later) from an earlier software version, provided that the device has not been factory reset after the upgrade.

Default value:

HTTPS (changed from HTTP+HTTPS to HTTPS in CE9.4)

Value space:

Off/HTTP+HTTPS/HTTPS

Off: Access to the device not allowed via HTTP or HTTPS.

HTTP+HTTPS: Access to the device allowed via both HTTP and HTTPS.

HTTPS: Access to the device allowed via HTTPS, but not via HTTP.

NetworkServices HTTP Proxy LoginName

Applies to: All products

Requires user role: ADMIN

This is the username part of the credentials for authentication towards the HTTP proxy. Requires that the NetworkServices HTTP Proxy Mode is set to Manual. We support the following HTTP authentication schemes: Digest using the MD5 algorithm, and the Basic HTTP authentication scheme.

Default value:

""

Value space:

String (0, 80)

The authentication login name.

Board

Board
ProCodec
EQCodec
PlusCodec
ProDesk,
Desk Pro,
Desk MiniRoom
Bar

Room Kit

Room Kit
Mini

Room 55

Room 55
Dual,
Room 70Room 70
G2Room 70
PanoramaRoom
Panorama

NetworkServices HTTP Proxy Mode

Applies to: All products

Requires user role: ADMIN

You can configure a proxy server for HTTP, HTTPS, and WebSocket traffic. The HTTP proxy can be set up manually, it can be auto-configured (PACUrl), fully automated (WPAD), or it can be turned off.

If NetworkServices HTTP Proxy Mode is not turned Off, you can further specify which services shall use the proxy in the HttpClient UseHttpProxy, HttpFeedback UseHttpProxy, and WebEngine UseHttpProxy settings.

Communication with the Webex cloud will always go via the proxy if NetworkServices HTTP Proxy Mode is not turned Off.

Regardless of the Proxy Mode, the device will never communicate with CUCM, MRA (CUCM via Expressway), or TMS via proxy.

Default value:

Off

Value space:

Manual/Off/PACUrl/WPAD

Manual: Enter the address of the proxy server in the NetworkServices HTTP Proxy URL setting. Optionally, also add the HTTP proxy login name and password in the NetworkServices HTTP Proxy LoginName/Password settings.

Off: The HTTP proxy mode is turned off.

PACUrl: The HTTP proxy is auto-configured. You must enter the URL for the PAC (Proxy Auto Configuration) script in the NetworkServices HTTP Proxy PACUrl setting.

WPAD: With WPAD (Web Proxy Auto Discovery) the HTTP proxy is fully automated and auto-configured.

NetworkServices HTTP Proxy PACUrl

Applies to: All products

Requires user role: ADMIN

Set the URL of the PAC (Proxy Auto Configuration) script. Requires that the NetworkServices HTTP Proxy Mode is set to PACUrl.

Default value:

""

Value space:

String (0, 255)

The URL of the PAC (Proxy Auto Configuration) script.

NetworkServices HTTP Proxy Password

Applies to: All products

Requires user role: ADMIN

This is the password part of the credentials for authentication towards the HTTP proxy. Requires that the NetworkServices HTTP Proxy Mode is set to Manual. We support the following HTTP authentication schemes: Digest using the MD5 algorithm, and the Basic HTTP authentication scheme.

Default value:

""

Value space:

String (0, 64)

The authentication password.

NetworkServices HTTP Proxy Url

Applies to: All products

Requires user role: ADMIN

Set the URL of the HTTP proxy server. Requires that the NetworkServices HTTP Proxy Mode is set to Manual.

Default value:

""

Value space:

String (0, 255)

The URL of the HTTP proxy server.

NetworkServices HTTPS OCSP Mode

Applies to: All products

Requires user role: ADMIN

When a client certificate is used as login credentials to the web user interface and xConfiguration NetworkServices HTTPS VerifyClientCertificate is enabled, an Online Certificate Status Protocol (OCSP) responder service can be used to verify the client certificate's revocation status.

If Mode is set to On, the web UI examines the client certificate for an OCSP URL and contacts the host to check the client's certificate validity status.

Default value:

Off

Value space:

Off/On

Off/On: Disable/enable OCSP client certificate verification.

Board

NetworkServices HTTPS OCSP URL

Applies to: All products

Requires user role: ADMIN

Specify the URL of the OCSP server that will be used to check the client's certificate validity status.

Default value:

""

Value space:

String (0, 255)

A valid URL.

Board
ProCodec
EQCodec
PlusCodec
ProDesk,
Desk Pro,
Desk MiniRoom
Bar

Room Kit

Room Kit
Mini

Room 55

Room 55
Dual,
Room 70Room 70
G2Room 70
PanoramaRoom
Panorama

NetworkServices HTTPS VerifyClientCertificate

Applies to: All products

Requires user role: ADMIN

When the video conferencing device connects to an HTTPS client (like a web browser), the client can be asked to present a certificate to the video conferencing device to identify itself.

Default value:

Off

Value space:

Off/On

Off: Do not verify client certificates.

On: Requires the client to present a certificate that is signed by a trusted Certificate Authority (CA). This requires that a list of trusted CAs are uploaded to the device in advance.

NetworkServices NTP Mode

Applies to: All products

Requires user role: ADMIN

The Network Time Protocol (NTP) is used to synchronize the device's time and date to a reference time server. The time server will be queried regularly for time updates.

Default value:

Auto

Value space:

Auto/Manual/Off

Auto: The device will use an NTP server for time reference. As default, the server address will be obtained from the network's DHCP server. If a DHCP server is not used, or if the DHCP server does not provide an NTP server address, the NTP server address that is specified in the NetworkServices NTP Server [n] Address setting will be used.

Manual: The device will use the NTP server that is specified in the NetworkServices NTP Server [n] Address setting for time reference.

Off: The device will not use an NTP server. The NetworkServices NTP Server [n] Address setting will be ignored.

NetworkServices HTTPS StrictTransportSecurity

Applies to: All products

Requires user role: ADMIN

The HTTP Strict Transport Security header lets a web site inform the browser that it should never load the site using HTTP and should automatically convert all attempts to access the site using HTTP to HTTPS requests instead.

Default value:

Off

Value space:

Off/On

Off: The HTTP strict transport security feature is disabled.

On: The HTTP strict transport security feature is enabled.

Board

NetworkServices NTP Server [n] Address

Applies to: All products

Requires user role: ADMIN

The address of the NTP server that will be used when NetworkServices NTP Mode is set to Manual, and when NetworkServices NTP Mode is set to Auto and no address is supplied by a DHCP server.

Default value:

"0.tandberg.pool.ntp.org"

Value space:

String (0, 255)

A valid IPv4 address, IPv6 address or DNS name.

n: Unique ID for the NTP server.

Range: 1..3

Board Pro

Codec EQ

Codec Plus

Codec Pro

Desk, Desk Pro, Desk Mini

Room Bar

Room Kit

Room Kit Mini

Room 55

Room 55 Dual, Room 70

Room 70 G2

Room 70 Panorama

Room Panorama

NetworkServices NTP Server [n] KeyId

Applies to: All products

Requires user role: ADMIN

To make sure that the NTP information comes from a trusted source, the video conferencing device must know the ID/key pair that the NTP source uses. Use the NetworkServices NTP Server [n] KeyId settings for the ID.

Default value:

" "

Value space:

String (0, 10)

The ID, which is part of the ID/key pair that the NTP source uses.

n: Unique ID for the NTP server.

Range: 1..3

NetworkServices NTP Server [n] KeyAlgorithm

Applies to: All products

Requires user role: ADMIN

Choose the authentication hash function that the NTP server uses, and that the video conferencing device must use to authenticate the time messages.

Default value:

" "

Value space:

None/SHA1/SHA256

None: The NTP server doesn't use a hash function.

SHA1: The NTP server uses the SHA-1 hash function.

SHA256: The NTP server uses the SHA-256 hash function (from the SHA-2 family of hash functions).

n: Unique ID for the NTP server.

Range: 1..3

Board

NetworkServices SIP Mode

Applies to: All products

Requires user role: ADMIN

Define whether the device should be able to place and receive SIP calls or not.

Default value:

On

Value space:

Off/On

Off: Disable the possibility to place and receive SIP calls.

On: Enable the possibility to place and receive SIP calls.

Board
ProCodec
EQCodec
PlusCodec
ProDesk,
Desk Pro,
Desk MiniRoom
Bar

Room Kit

Room Kit
Mini

Room 55

Room 55
Dual,
Room 70Room 70
G2Room 70
PanoramaRoom
Panorama

NetworkServices SMTP Server

Applies to: RoomKitMini RoomBar DeskMini Desk DeskPro Board BoardPro

Requires user role: ADMIN

This is the address of the SMTP server.

This setting is not available for Room Kit Mini in general, only when Room Kit Mini is used with Samsung Flip (Webex on Flip).

Default value:

""

Value space:

String (0, 255)

A valid IPv4 address, IPv6 address or DNS name.

NetworkServices SMTP Port

Applies to: RoomKitMini RoomBar DeskMini Desk DeskPro Board BoardPro

Requires user role: ADMIN

This port is used for outgoing emails from the device to the SMTP server.

Set a port number based on the encryption setting (NetworkServices SMTP Security) and the requirements of the SMTP server. Do not use the default value.

This setting is not available for Room Kit Mini in general, only when Room Kit Mini is used with Samsung Flip (Webex on Flip).

Default value:

0

Value space:

Integer (0..65535)

The port used for outgoing emails from the device.

Board

NetworkServices SMTP Username

Applies to: RoomKitMini RoomBar DeskMini Desk DeskPro Board BoardPro

Requires user role: ADMIN

This is the username part of the credentials that are used to authenticate the device with the SMTP server. This setting may be required by the SMTP server.

This setting is not available for Room Kit Mini in general, only when Room Kit Mini is used with Samsung Flip (Webex on Flip).

Default value:

""

Value space:

String (0, 80)

A valid username.

Board Pro

Codec EQ

Codec Plus

Codec Pro

Desk, Desk Pro, Desk Mini

Room Bar

NetworkServices SMTP Password

Applies to: RoomKitMini RoomBar DeskMini Desk DeskPro Board BoardPro

Requires user role: ADMIN

This is the password part of the credentials that are used to authenticate the device with the SMTP server. This setting may be required by the SMTP server.

This setting is not available for Room Kit Mini in general, only when Room Kit Mini is used with Samsung Flip (Webex on Flip).

Default value:

""

Value space:

String (0, 64)

A valid password.

Room Kit

Room Kit Mini

Room 55

Room 55 Dual, Room 70

Room 70 G2

Room 70 Panorama

Room Panorama

NetworkServices SMTP From

Applies to: RoomKitMini RoomBar DeskMini Desk DeskPro Board BoardPro

Requires user role: ADMIN

When sending an email message from this device, this is the name of the mailbox that the message is sent from.

This setting is not available for Room Kit Mini in general, only when Room Kit Mini is used with Samsung Flip (Webex on Flip).

Default value:

""

Value space:

String (0, 255)

An email address that meets the requirements of the SMTP server.

NetworkServices SMTP Security

Applies to: RoomKitMini RoomBar DeskMini Desk DeskPro Board BoardPro

Requires user role: ADMIN

Choose if and how to secure the communication between the device and the SMTP server.

This setting is not available for Room Kit Mini in general, only when Room Kit Mini is used with Samsung Flip (Webex on Flip).

Default value:

StartTls

Value space:

None/StartTls/Tls

None: Connect to the SMTP server without encryption.

StartTls: Initially connect to the SMTP server without encryption, and then send a STARTTLS command to upgrade to an encrypted connection (TLS).

Tls: Connect to the SMTP server over TLS (Transport Layer Security).

NetworkServices SNMP CommunityName

Applies to: All products

Requires user role: ADMIN, INTEGRATOR

Define the name of the SNMP community. The SNMP community name is used to authenticate SNMP requests when using SNMP v2c. If an SNMP request from a management system does not include a matching community name (case sensitive), the message is dropped and the SNMP agent in the video device will not send a response.

If you have the Cisco TelePresence Management Suite (TMS) you must make sure the same SNMP community is configured there.

This setting has no effect if using SNMP v3; users and authentication for SNMP v3 is managed using the Network SNMP USM User commands.

Default value:

""

Value space:

String (0, 50)

The SNMP community name. An empty string means that SNMP v2c is not supported.

Board

Board
ProCodec
EQCodec
PlusCodec
ProDesk,
Desk Pro,
Desk MiniRoom
Bar

Room Kit

Room Kit
Mini

Room 55

Room 55
Dual,
Room 70Room 70
G2Room 70
PanoramaRoom
Panorama

NetworkServices SNMP Mode

Applies to: All products

Requires user role: ADMIN, INTEGRATOR

SNMP (Simple Network Management Protocol) is used by network management systems to monitor and manage network devices. The video conferencing device supports both SNMP v2c and v3. In both cases the device exposes the following object identifiers (OIDs), so that management systems can read and write basic parameters: SNMPv2-MIB::sysDescr (read), SNMPv2 -MIB::sysObjectID (read), DISMAN-EVENT-MIB::sysUpTimeInstance (read), SNMPv2 -MIB::sysContact (read/write), SNMPv2 -MIB::sysName (read/write), SNMPv2 -MIB::sysLocation (read/write), and SNMPv2 -MIB::sysServices (read).

You can limit the SNMP support to v3 only, by setting the NetworkServices SNMP CommunityName to an empty string ("").

Default value:

Off

Value space:

Off/ReadOnly/ReadWrite

Off: Disable the SNMP network service.

ReadOnly: Enable the SNMP network service for queries only.

ReadWrite: Enable the SNMP network service for both queries and commands.

NetworkServices SNMP SystemContact

Applies to: All products

Requires user role: ADMIN, INTEGRATOR

Define contact information that SNMP servers can use.

Default value:

""

Value space:

String (0, 50)

String that describes the contact information for the video device.

NetworkServices SNMP SystemLocation

Applies to: All products

Requires user role: ADMIN, INTEGRATOR

Define location information that SNMP servers can use.

Default value:

""

Value space:

String (0, 50)

String that describes the location of the video device.

NetworkServices SSH Mode

Applies to: All products

Requires user role: ADMIN

The SSH (or Secure Shell) protocol can provide secure encrypted communication between the video conferencing device and your local computer.

Default value:

On

Value space:

Off/On

Off: The SSH protocol is disabled.

On: The SSH protocol is enabled.

NetworkServices SSH HostKeyAlgorithm

Applies to: All products

Requires user role: ADMIN

Choose the cryptographic algorithm that shall be used for the SSH host key. Choices are RSA (Rivest-Shamir-Adleman) with 2048 bits keysize, ECDSA (Elliptic Curve Digital Signature Algorithm) with NIST curve P-384, and EdDSA (Edwards-curve Digital Signature Algorithm) with ed25519 signature schema.

Default value:

RSA

Value space:

ECDSA/RSA/ed25519

ECDSA: Use the ECDSA algorithm (nist-384p).

RSA: Use the RSA algorithm (2048 bits).

ed25519: Use the ed25519 algorithm.

Board

NetworkServices SSH AllowPublicKey

Applies to: All products

Requires user role: ADMIN

Secure Shell (SSH) public key authentication can be used to access the device.

Default value:

On

Value space:

Off/On

Off: The SSH public key is not allowed.

On: The SSH public key is allowed.

Board Pro

Codec EQ

Codec Plus

Codec Pro

Desk, Desk Pro, Desk Mini

Room Bar

Room Kit

Room Kit Mini

Room 55

Room 55 Dual, Room 70

Room 70 G2

Room 70 Panorama

Room Panorama

NetworkServices UPnP Mode

Applies to: All products

Requires user role: ADMIN

Fully disable UPnP (Universal Plug and Play), or enable UPnP for a short time period after the video conferencing device has been switched on or restarted.

The default operation is that UPnP is enabled when you switch on or restart the video conferencing device. Then UPnP is automatically disabled after the timeout period that is defined in the NetworkServices UPnP Timeout setting.

When UPnP is enabled, the device advertises its presence on the network. The advertisement permits a touch controller to discover video conferencing devices automatically, and you do not need to manually enter the device's IP address in order to pair the touch controller.

Default value:

On

Value space:

Off/On

Off: UPnP is disabled. The video conferencing device does not advertise its presence, and you have to enter the device's IP address manually in order to pair a touch controller to the device.

On: UPnP is enabled. The video conferencing device advertises its presence until the timeout period expires.

NetworkServices UPnP Timeout

Applies to: All products

Requires user role: ADMIN

Define for how many seconds UPnP shall stay enabled after the device is switched on or restarted. The NetworkServices UPnP Mode setting must be On for this setting to take any effect.

Default value:

600

Value space:

Integer (0..3600)

Range: Select a value between 0 and 3600 seconds.

NetworkServices WebSocket

Applies to: All products

Requires user role: ADMIN

It is possible to interact with the API of the device over the WebSocket protocol, both the insecure and secure versions (ws and wss). A WebSocket is tied to HTTP, so that also HTTP or HTTPS must be enabled before you can use WebSockets (see the NetworkServices HTTP Mode setting).

Default value:

FollowHTTPService

Value space:

FollowHTTPService/Off

FollowHTTPService: Communication over the WebSocket protocol is allowed when HTTP or HTTPS is enabled.

Off: Communication over the WebSocket protocol is not allowed.

NetworkServices WelcomeText

Applies to: All products

Requires user role: ADMIN

Choose which information the user should see when logging on to the device through SSH.

Default value:

On

Value space:

Off/On

Off: The welcome text is: Login successful

On: The welcome text is: Welcome to <system name>; Software version; Software release date; Login successful.

Board

Board
ProCodec
EQCodec
PlusCodec
ProDesk,
Desk Pro,
Desk MiniRoom
Bar

Room Kit

Room Kit
Mini

Room 55

Room 55
Dual,
Room 70Room 70
G2Room 70
PanoramaRoom
Panorama

NetworkServices Wifi Allowed

Applies to: All products

Requires user role: ADMIN, USER

Devices that have a built-in Wi-Fi adapter, can connect to the network either via Ethernet or Wi-Fi. Both Ethernet and Wi-Fi are allowed by default, and the user can choose which one to use from the user interface. With this setting, the administrator can disable Wi-Fi configuration, so that it cannot be set up from the user interface.

The devices support the following standards: IEEE 802.11a, IEEE 802.11b, IEEE 802.11g, IEEE 802.11n, and IEEE 802.11ac. The device supports the following security protocols: WPA2 Personal mode (AES), WPA2 with EAP-TLS, WPA2 with EAP-TTLS, WPA2 with EAP-FAST, WPA2 with PEAP (with EAP-MSCHAPv2 or EAP-GTC), and open networks (not secured).

If the PID (Product ID), found on the rating label at the rear of the device, contains the letters NR (No Radio) the device does not support Wi-Fi.

Default value:

True

Value space:

False/True

False: Wi-Fi cannot be used. You must connect to the network via Ethernet.

True: Both Ethernet and Wi-Fi are allowed.

NetworkServices Wifi Settings A_MPDU

Applies to: All products

Requires user role: ADMIN

This config is to improve real-time media performance. When Aggregate MAC Protocol Data Unit (A-MPDU) is On, MAC Protocol Data frames are grouped and sent together. The receiver acknowledges reception of the group, rather than acknowledging every individual frame. This optimizes bandwidth but can lead to delays in data delivery. This is bad for data which requires a real-time delivery priority, such as video call data.

Default value:

Off

Value space:

Off/On

Off: Disable A-MPDU so that data is not grouped and sent together but is sent immediately to preserve real-time delivery priority.

On: Enable A-MPDU so that MAC Protocol Data frames are grouped and sent together.

NetworkServices Wifi Settings FrequencyBand

Applies to: All products

Requires user role: ADMIN

Set which frequency band to use when connecting the device to the network via Wi-Fi.

Default value:

Auto

Value space:

2_4Ghz/5Ghz/Auto

2_4Ghz: Use the 2.4 GHz band.

5Ghz: Use the 5 GHz band.

Auto: Use the frequency band that gives the strongest signal. Or, if the access point is set up with band steering, follow the decision made by the access point.

NetworkServices Wifi Enabled

Applies to: All products

Requires user role: ADMIN, USER

Provided that the device is allowed to connect to the network via Wi-Fi (see the NetworkServices WIFI Allowed setting), you can use this setting to enable and disable Wi-Fi.

You cannot use Ethernet and Wi-Fi at the same time. If you try to configure Wi-Fi while an Ethernet cable is connected, you must unplug the Ethernet cable to proceed. If you connect an Ethernet cable while connected to Wi-Fi, Ethernet will take precedence. If you unplug the Ethernet cable, the device will automatically connect to the last connected Wi-Fi network, if available.

Default value:

True

Value space:

False/True

False: Wi-Fi is disabled.

True: Wi-Fi is enabled.

Board

Board
ProCodec
EQCodec
PlusCodec
ProDesk,
Desk Pro,
Desk MiniRoom
Bar

Room Kit

Room Kit
Mini

Room 55

Room 55
Dual,
Room 70Room 70
G2Room 70
PanoramaRoom
Panorama

NetworkServices XMLAPI Mode

Applies to: All products

Requires user role: ADMIN

Enable or disable the device's XML API. For security reasons this may be disabled. Disabling the XML API will limit the remote manageability with for example TMS, which no longer will be able to connect to the device.

Default value:

On

Value space:

Off/On

Off: The XML API is disabled.

On: The XML API is enabled.

Peripherals settings

Peripherals ActivePen Enabled

Applies to: BoardPro

Requires user role: ADMIN

Enable or disable the use of active pens.

Default value:

True

Value space:

True/False

True: Active pens are enabled.

False: Active pens are not enabled and using the pen will have no effect.

Peripherals InputDevice Mode

Applies to: RoomKit RoomKitMini RoomBar CodecEQ CodecPlus CodecPro Room55 Room70/Room55D Room70G2 RoomPanorama/Room70Panorama DeskMini Desk DeskPro BoardPro

Requires user role: ADMIN

Define whether or not to allow the use of a third-party input device, such as a USB keyboard or a wireless remote control with a USB dongle. The input device must advertise itself as a USB keyboard. You must define and implement the actions to be taken as response to key clicks yourself.

Default value:

Off

Value space:

Off/On

Off: A third-party USB input device is not allowed.

On: A third-party USB input device can be used to control certain functions on the video conferencing device.

Board

Peripherals Pairing CiscoTouchPanels EmcResilience

Applies to: RoomKit RoomKitMini RoomBar CodecEQ CodecPlus CodecPro Room55 Room70/Room55D Room70G2 RoomPanorama/Room70Panorama Board BoardPro

Requires user role: ADMIN

If the Touch 10 touch controller is used in environments with considerable amounts of electromagnetic noise present, you may experience an appearance of false signals—for example as if someone tapped the touch controller when nobody did so. To prevent this you may enable the EMC Resilience Mode. This applies only to Touch 10, not to Room Navigator.

Default value:

Off

Value space:

Off/On

Off: The EMC resilience is disabled.

On: The EMC resilience is enabled.

Board Pro

Codec EQ

Codec Plus

Codec Pro

Desk, Desk Pro, Desk Mini

Room Bar

Room Kit

Room Kit Mini

Room 55

Room 55 Dual, Room 70

Room 70 G2

Room 70 Panorama

Room Panorama

Peripherals Pairing CiscoTouchPanels HttpProxy

Applies to: RoomKit RoomKitMini RoomBar CodecEQ CodecPlus CodecPro Room55 Room70/Room55D Room70G2 RoomPanorama/Room70Panorama Board BoardPro

Requires user role: ADMIN

This allows a Room Navigator that is directly connected to the video conferencing device (that is, locally paired), to access external HTTP(S) servers. To prevent such access, switch this setting Off.

Default value:

Auto

Value space:

Auto/Off

Auto: The Room Navigator is allowed to access content on external HTTP(S) servers. The video conferencing device will act as an HTTP proxy.

Off: The Room Navigator cannot access content on external HTTP(S) servers.

Peripherals Pairing CiscoTouchPanels RemotePairing

Applies to: All products

Requires user role: ADMIN

In order to use a touch controller (Room Navigator or Touch 10) as user interface for the video conferencing device, the touch controller must be paired to the device. When the touch controller is paired via the network (LAN), this is referred to as remote pairing. Remote pairing is allowed by default; you must switch this setting Off if you want to prevent remote pairing.

Board 55/70 only support Touch 10, not Room Navigator. Board 55S/75S/85S, Codec Plus, Codec Pro, Room Kit, Room Kit Mini, Room 55, Room 55 Dual, Room 70, Room 70 G2, Room 70 Panorama, and Room Panorama support both Room Navigator and Touch 10. The other products support only Room Navigator.

Default value:

On

Value space:

Off/On

Off: Remote pairing of the touch controller is not allowed.

On: Remote pairing of the touch controller is allowed.

Peripherals Profile Cameras

Applies to: RoomKit RoomKitMini RoomBar CodecEQ CodecPlus CodecPro Room55 Room70/Room55D Room70G2 RoomPanorama/Room70Panorama DeskMini Desk DeskPro BoardPro

Requires user role: ADMIN, INTEGRATOR

Define the number of external cameras that are expected to be connected to the video conferencing device. This information is used by the device's diagnostics service. If the number of connected cameras does not match this setting, the diagnostics service will report it as an inconsistency.

Default value:

Minimum1 [[RoomKit](#) [RoomKitMini](#) [RoomBar](#) [CodecEQ](#) [CodecPlus](#) [CodecPro](#) [Room55](#) [Room70/Room55D](#) [Room70G2](#) [RoomPanorama/Room70Panorama](#) [BoardPro](#)]

0 [[DeskMini](#) [Desk](#) [DeskPro](#)]

Value space:

NotSet/Minimum1/0/1/2/3/4/5/6/7 [[RoomKit](#) [RoomKitMini](#) [RoomBar](#) [CodecEQ](#) [CodecPlus](#) [CodecPro](#) [Room55](#) [Room70/Room55D](#) [Room70G2](#) [RoomPanorama/Room70Panorama](#) [BoardPro](#)]

0 [[DeskMini](#) [Desk](#) [DeskPro](#)]

NotSet: No camera check is performed.

Minimum1: At least one camera should be connected to the device.

0-7: Select the number of cameras that are expected to be connected to the device.

Board

Peripherals Profile Cameras

Applies to: Board

Requires user role: ADMIN, INTEGRATOR

Define the number of external cameras that are expected to be connected to the device. This information is used by the device's diagnostics service. If the number of connected cameras does not match this setting, the diagnostics service will report it as an inconsistency.

Default value:

0

Value space:

0

0: The number of cameras that are expected to be connected to the device.

Room
Bar

Peripherals Profile ControlSystems

Applies to: All products

Requires user role: ADMIN, INTEGRATOR

Define if a third-party control system, for example Crestron or AMX, is expected to be connected to the video conferencing device. This information is used by the video conferencing device's diagnostics service. If the number of connected control systems does not match this setting, the diagnostics service will report it as an inconsistency. Note that only one third-party control system is supported.

If set to 1, the control system must send heart beats to the video conferencing device using xCommand Peripherals Pair and HeartBeat commands. Failing to do so will cause the video conferencing device to show a warning that it has lost connectivity to the control system.

Default value:

NotSet

Value space:

1/NotSet

1: One third-party control system should be connected to the device.

NotSet: No check for a third-party control system is performed.

Room 55
Dual,
Room 70Room
Panorama

Peripherals Profile NetworkSwitches

Applies to: RoomPanorama/Room70Panorama

Requires user role: ADMIN, INTEGRATOR

Define the number of network switches that are expected to be connected to the device. This information is used by the device's diagnostics service. If the number of connected network switches does not match this setting, the diagnostics service will report it as an inconsistency.

Default value:

Room Panorama: 2; Room 70 Panorama: NotSet

Value space:

1/2/Minimum1/NotSet

NotSet: No network switch is connected.

Minimum1: At least one network switch should be connected to the device.

1-2: Specify the number of network switches that are expected to be connected to the device.

Peripherals Profile TouchPanels

Applies to: RoomKit RoomKitMini RoomBar CodecEQ CodecPlus CodecPro Room55 Room70/Room55D Room70G2 RoomPanorama/Room70Panorama DeskMini Desk DeskPro BoardPro

Requires user role: ADMIN, INTEGRATOR

Define the number of Cisco touch controllers that are expected to be connected to the device. This information is used by the device's diagnostics service. If the number of connected touch controllers does not match this setting, the diagnostics service will report it as an inconsistency.

Default value:

Minimum1 [RoomKit RoomKitMini RoomBar CodecEQ CodecPlus CodecPro Room55 Room70/Room55D Room70G2 RoomPanorama/Room70Panorama]

0 [DeskMini Desk DeskPro BoardPro]

Value space:

NotSet/Minimum1/0/1/2/3/4/5 [RoomKit RoomKitMini RoomBar CodecEQ CodecPlus CodecPro Room55 Room70/Room55D Room70G2 RoomPanorama/Room70Panorama BoardPro]

0 [DeskMini Desk DeskPro]

NotSet: No touch controller check is performed.

Minimum1: At least one Cisco touch controller should be connected to the device.

0-5: Select the number of Cisco touch controllers that are expected to be connected to the device. The number of Cisco touch controllers that are officially supported are: 0 for Desk series devices, 2 for Room Panorama and Room 70 Panorama, and 1 for the other products.

Board

Board
ProCodec
EQCodec
PlusCodec
ProDesk,
Desk Pro,
Desk MiniRoom
Bar

Room Kit

Room Kit
Mini

Room 55

Room 55
Dual,
Room 70Room 70
G2Room 70
PanoramaRoom
Panorama

Phonebook settings

Phonebook Server [n] ID

Applies to: All products

Requires user role: ADMIN

Define a name for the external phone book.

Default value:

""

Value space:

String (0, 64)

The name for the external phone book.

n: Unique ID that identifies the phonebook server.

Range: 1..1

Phonebook Server [n] Pagination

Applies to: All products

Requires user role: ADMIN

Configure if the phonebook server supports pagination (paging) or not. Pagination means that the server supports consecutive searches, and these searches can be relative to an offset. This allows the user interface to perform as many consecutive searches as required to get the complete search result.

If Pagination is Disabled the device does a single search and returns a maximum of 100 entries in the search result. It is not possible to scroll to any further search results beyond that.

Default value:

Enabled

Value space:

Disabled/Enabled

Disabled: The phonebook server does not support pagination. The device does a single search, and the maximum number of entries in the search result is 100.

Enabled: The phonebook server supports pagination.

n: Unique ID that identifies the phonebook server.

Range: 1..1

Phonebook Server [n] TlsVerify

Applies to: All products

Requires user role: ADMIN

This setting applies when a video conferencing device connects to an external phone book server via HTTPS.

Before establishing a connection between the device and the HTTPS server, the device checks if the certificate of the server is signed by a trusted Certificate Authority (CA). The CA certificate must be included in the CA list on the device, either pre-installed or manually uploaded using the web interface or API.

In general, the minimum TLS (Transport Layer Security) version for the HTTPS connection is 1.1. There are two exceptions to this rule: 1) For compatibility reasons, the minimum TLS version is 1.0 for devices that are registered to CUCM. 2) Devices registered to the Webex cloud service always use version 1.2.

Note: The value is set to Off for a device that has been upgraded to CE9.9 (or later) from CE9.8 or earlier software versions, provided that the device has not been factory reset after the upgrade, and that the old NetworkServices HTTPS VerifyServerCertificate setting was not explicitly set to On.

Default value:

On

Value space:

Off/On

Off: The device doesn't check the certificate of the HTTPS server.

On: The device checks if the certificate of the HTTPS server can be trusted. If not, the connection between the device and the server is not established.

Board

Board
ProCodec
EQCodec
PlusCodec
ProDesk,
Desk Pro,
Desk MiniRoom
Bar

Room Kit

Room Kit
Mini

Room 55

Room 55
Dual,
Room 70Room 70
G2Room 70
PanoramaRoom
Panorama

Phonebook Server [n] Type

Applies to: All products

Requires user role: ADMIN

Select the phonebook server type.

Default value:

Off

Value space:

Off/CUCM/Spark/TMS/VCS

Off: Do not use a phonebook.

CUCM: The phonebook is located on the Cisco Unified Communications Manager.

Spark: The phonebook is located in the Webex cloud service.

TMS: The phonebook is located on the Cisco TelePresence Management Suite server.

VCS: The phonebook is located on the Cisco TelePresence Video Communication Server.

n: Unique ID that identifies the phonebook server.

Range: 1..1

Phonebook Server [n] URL

Applies to: All products

Requires user role: ADMIN

Define the address (URL) to the external phone book server.

Default value:

""

Value space:

String (0, 255)

A valid address (URL) to the phone book server.

n: Unique ID that identifies the phonebook server.

Range: 1..1

Provisioning settings

Provisioning Connectivity

Applies to: All products

Requires user role: ADMIN, USER

This setting controls how the device discovers whether it should request an internal or external configuration from the provisioning server.

Default value:

Auto

Value space:

Internal/External/Auto

Internal: Request internal configuration.

External: Request external configuration.

Auto: Automatically discover using NAPTR queries whether internal or external configurations should be requested. If the NAPTR responses have the "e" flag, external configurations will be requested. Otherwise internal configurations will be requested.

Provisioning CUCM CallManagementRecords CallDiagnostics

Applies to: All products

Requires user role: ADMIN, USER

Enable devices to send call statistics to CUCM which will then be populated in CUCM's Call Management Records The call statistics are sent to CUCM upon termination of a call.

Default value:

Enabled

Value space:

Disabled/Enabled

Enabled: Enables support for CUCM Call Management Records.

Disabled: Disables support for CUCM Call Management Records.

Board

Provisioning ExternalManager Address

Applies to: All products

Requires user role: ADMIN, USER

Define the IP Address or DNS name of the external manager / provisioning system. If an External Manager Address (and Path) is configured, the device will send a message to this address when starting up. When receiving this message the external manager / provisioning system can return configurations/commands to the unit as a result.

When using CUCM or TMS provisioning, the DHCP server can be set up to provide the external manager address automatically (DHCP Option 242 for TMS, and DHCP Option 150 for CUCM). An address set in the Provisioning ExternalManager Address setting will override the address provided by DHCP.

Default value:

""

Value space:

String (0, 64)

A valid IPv4 address, IPv6 address or DNS name.

Board Pro

Codec EQ

Codec Plus

Codec Pro

Desk, Desk Pro, Desk Mini

Room Bar

Room Kit

Room Kit Mini

Room 55

Room 55 Dual, Room 70

Room 70 G2

Room 70 Panorama

Room Panorama

Provisioning ExternalManager Protocol

Applies to: All products

Requires user role: ADMIN, USER

Define whether to use the HTTP (unsecure communication) or HTTPS (secure communication) protocol when sending requests to the external manager / provisioning system.

The selected protocol must be enabled in the NetworkServices HTTP Mode setting.

Default value:

HTTP

Value space:

HTTPS/HTTP

HTTPS: Send requests via HTTPS.

HTTP: Send requests via HTTP.

Provisioning ExternalManager Path

Applies to: All products

Requires user role: ADMIN, USER

Define the Path to the external manager / provisioning system. This setting is required when several management services reside on the same server, that is, when they share the same External Manager address.

Default value:

""

Value space:

String (0, 255)

A valid path to the external manager or provisioning system.

Provisioning ExternalManager Domain

Applies to: All products

Requires user role: ADMIN, USER

Define the SIP domain for the VCS provisioning server.

Default value:

""

Value space:

String (0, 64)

A valid domain name.

Board

Board
ProCodec
EQCodec
PlusCodec
ProDesk,
Desk Pro,
Desk MiniRoom
Bar

Room Kit

Room Kit
Mini

Room 55

Room 55
Dual,
Room 70Room 70
G2Room 70
PanoramaRoom
Panorama

Provisioning Mode

Applies to: All products

Requires user role: ADMIN, USER

It is possible to configure a device using a provisioning system (external manager). This allows video conferencing network administrators to manage many devices simultaneously. With this setting you choose which type of provisioning system to use. Provisioning can also be switched off. Contact your provisioning system provider/representative for more information.

Default value:

Auto

Value space:

Off/Auto/CUCM/Edge/Webex/TMS/VCS

Off: The device is not configured by a provisioning system.

Auto: The provisioning server is automatically selected as set up in the DHCP server.

CUCM: Push configurations to the device from CUCM (Cisco Unified Communications Manager).

Edge: Push configurations to the device from CUCM (Cisco Unified Communications Manager). The device connects to CUCM via the Expressway infrastructure. In order to register over Expressway the encryption option key must be installed on the device.

Webex: Push configurations to the device from the Webex cloud service. In order to register to the Webex cloud service, the encryption option key must be installed on the device.

TMS: Push configurations to the device from TMS (Cisco TelePresence Management System).

VCS: Push configurations to the device from VCS (Cisco TelePresence Video Communication Server).

Provisioning LoginName

Applies to: All products

Requires user role: ADMIN, USER

This is the username part of the credentials used to authenticate the device with the provisioning server. This setting must be used when required by the provisioning server.

Default value:

""

Value space:

String (0, 80)

A valid username.

Provisioning Password

Applies to: All products

Requires user role: ADMIN, USER

This is the password part of the credentials used to authenticate the device with the provisioning server. This setting must be used when required by the provisioning server.

Default value:

""

Value space:

String (0, 64)

A valid password.

Provisioning TlsVerify

Applies to: All products

Requires user role: ADMIN, USER

This setting applies when a video conferencing device connects to a provisioning server via HTTPS.

Before establishing a connection between the device and the HTTPS server, the device checks if the certificate of the server is signed by a trusted Certificate Authority (CA). The CA certificate must be included in the CA list on the device, either pre-installed or manually uploaded using the web interface or API.

In general, the minimum TLS (Transport Layer Security) version for the HTTPS connection is 1.1. There are two exceptions to this rule: 1) For compatibility reasons, the minimum TLS version is 1.0 for devices that are registered to CUCM. 2) Devices registered to the Webex cloud service always use version 1.2.

Note: The value is set to Off for a device that has been upgraded to CE9.9 (or later) from CE9.8 or earlier software versions, provided that the device has not been factory reset after the upgrade, and that the old NetworkServices HTTPS VerifyServerCertificate setting was not explicitly set to On.

The certificate check is always performed, regardless of this setting, if the device is provisioned from the Webex cloud service or from CUCM via Expressway (also known as MRA or Edge).

Default value:

On

Value space:

Off/On

Off: The device doesn't check the certificate of the HTTPS server.

On: The device checks if the certificate of the HTTPS server can be trusted. If not, the connection between the device and the server is not established.

Board

Board
ProCodec
EQCodec
PlusCodec
ProDesk,
Desk Pro,
Desk MiniRoom
Bar

Room Kit

Room Kit
Mini

Room 55

Room 55
Dual,
Room 70Room 70
G2Room 70
PanoramaRoom
Panorama

Provisioning WebexEdge

Applies to: All products

Requires user role: ADMIN, USER

Define if the device is linked to Webex Edge for Devices, which gives access to select Webex cloud services.

The setting applies only to devices that are registered to an on-premises service.

Default value:

Off

Value space:

Off/On

Off: The device is not linked to Webex Edge for Devices.

On: The device is linked to Webex Edge for Devices.

Proximity settings

Proximity AlternatePort Enabled

Applies to: All products

Requires user role: ADMIN

This setting applies only when NetworkServices HTTP Mode is set to HTTP+HTTPS or HTTPS.

By default, Proximity connections use TCP port 443. Use this setting to allow Proximity connections also on port 65533.

Default value:

False

Value space:

False/True

False: Proximity connections always use TCP port 443.

True: Proximity connections can use either TCP port 443 or 65533. The port used depends on the client.

Board

Board
ProCodec
EQCodec
PlusCodec
ProDesk,
Desk Pro,
Desk MiniRoom
Bar

Room Kit

Room Kit
Mini

Room 55

Room 55
Dual,
Room 70Room 70
G2Room 70
PanoramaRoom
Panorama

Proximity Mode

Applies to: All products

Requires user role: ADMIN, USER

The Proximity Mode setting has no effect for devices that are registered to the Webex cloud service. To prevent a cloud registered device from sending ultrasound pairing messages, you must set Audio Ultrasound MaxVolume to 0.

For devices registered on-premises, the Proximity Mode setting determines whether the device will emit ultrasound pairing messages or not. When the device emits ultrasound pairing messages, Cisco collaboration clients can detect that they are close to the device.

In order to use a client, at least one of the Proximity services must be enabled (refer to the Proximity Services settings) as well. In general, Cisco recommends enabling all the Proximity services.

The Proximity Mode and Audio Ultrasound MaxVolume settings only affect ultrasound pairing messages. To stop all ultrasound emissions, the RoomAnalytics PeoplePresenceDetector and Standby WakeupOnMotionDetection settings must also be switched Off.

Default value:

On [[RoomKit](#) [RoomKitMini](#) [RoomBar](#) [Room55](#) [Room70/Room55D](#) [Room70G2](#) [RoomPanorama/Room70Panorama](#) [Board](#) [BoardPro](#)]

Off [[CodecEQ](#) [CodecPlus](#) [CodecPro](#) [DeskMini](#) [Desk](#) [DeskPro](#)]

Value space:

Off/On

Off: Cisco collaboration clients cannot detect that they are close to the device, thus Proximity services cannot be used.

On: Cisco collaboration clients can detect that they are close to the device, and enabled Proximity services can be used.

Proximity Services CallControl

Applies to: All products

Requires user role: ADMIN, USER

Enable or disable basic call control features on Cisco collaboration clients. When this setting is enabled, you are able to control a call using a Cisco collaboration client (for example dial, mute, adjust volume and hang up). This service is supported by mobile devices (iOS and Android). Proximity Mode must be On for this setting to take any effect.

Default value:

Disabled

Value space:

Enabled/Disabled

Enabled: Call control from a Cisco collaboration client is enabled.

Disabled: Call control from a Cisco collaboration client is disabled.

Proximity Services ContentShare FromClients

Applies to: All products

Requires user role: ADMIN, USER

Enable or disable content sharing from Cisco collaboration clients. When this setting is enabled, you can share content from a Cisco collaboration client wirelessly on the device, for example, share your laptop screen. This service is supported by laptops (OS X and Windows). Proximity Mode must be On for this setting to take any effect.

Default value:

Enabled

Value space:

Enabled/Disabled

Enabled: Content sharing from a Cisco collaboration client is enabled.

Disabled: Content sharing from a Cisco collaboration client is disabled.

Proximity Services ContentShare ToClients

Applies to: All products

Requires user role: ADMIN, USER

This is no longer applicable.

Default value:

Disabled

Value space:

Disabled

Board

Board
ProCodec
EQCodec
PlusCodec
ProDesk,
Desk Pro,
Desk MiniRoom
Bar

Room Kit

Room Kit
Mini

Room 55

Room 55
Dual,
Room 70Room 70
G2Room 70
PanoramaRoom
Panorama

RoomAnalytics settings

RoomAnalytics AmbientNoiseEstimation Interval

Applies to: All products

Requires user role: ADMIN, INTEGRATOR, USER

Set the interval at which the ambient noise estimation is run, if enabled. The xConfiguration RoomAnalytics AmbientNoiseEstimation Mode can be used to enable or disable ambient noise estimations.

Default value:

10

Value space:

Integer (10..60)

Set the interval, in seconds, for how often the ambient noise estimation is run.

RoomAnalytics AmbientNoiseEstimation Mode

Applies to: All products

Requires user role: ADMIN, INTEGRATOR, USER

The device can estimate the stationary ambient noise level (background noise level) in the room. The result is reported in the RoomAnalytics AmbientNoise Level dBA status. The status is updated when a new ambient noise level is detected.

Default value:

Off

Value space:

Off/On

On: The device regularly estimates the stationary ambient noise level.

Off: The device doesn't estimate the stationary ambient noise level.

RoomAnalytics PeopleCountOutOfCall

Applies to: All products

Requires user role: ADMIN, INTEGRATOR, USER

By using a technique called "head detection", the device has the capability to find how many people are in the room. By default, the device only counts people when in a call or when displaying the self-view picture.

Codec Plus, Codec Pro: Applies only when the device has a Quad Camera connected.

Default value:

Off

Value space:

Off/On

Off: The device counts people only when the device is in a call or when self-view is on.

On: The device counts people whenever the device is not in standby mode. This includes outside of call, even if self-view is off.

RoomAnalytics PeoplePresenceDetector

Applies to: All products

Requires user role: ADMIN, INTEGRATOR, USER

The device has the capability to find whether or not people are present in the room and report the result in the RoomAnalytics PeoplePresence status. The feature is based on ultrasound. The device will not keep record of who was in the room, only whether or not there are people present in the room.

Ultrasound signals for presence detection are not emitted when both this setting AND the Standby WakeupOnMotionDetection setting are switched Off. The Audio Ultrasound MaxVolume and Proximity Mode settings has no effect on presence detection.

Default value:

Off

Value space:

Off/On

Off: The presence of people in the room is not reported in the device's status.

On: The presence of people in the room is reported in the device's status.

Board

RoomAnalytics ReverberationTime Interval

Applies to: All products

Requires user role: ADMIN, INTEGRATOR, USER

Defines how often the RT60 will be measured and reported to the RoomAnalytics status. The interval is in seconds.

The RoomAnalytics ReverberationTime Mode configuration must be enabled to set the interval.

Default value:

1800

Value space:

Integer (60..3600)
Interval in seconds.

Board Pro

Codec EQ

Codec Plus

Codec Pro

Desk, Desk Pro, Desk Mini

Room Bar

RoomAnalytics ReverberationTime Mode

Applies to: All products

Requires user role: ADMIN, INTEGRATOR, USER

Reverberation time is a measure of how fast a sound will "fade away" or decay in a room. This is highly related to the perception of the acoustic quality of a room.

The Cisco devices are capable of measuring the reverberation time, RT60, directly from the acoustic echo canceller.

As opposed to traditional reverberation time measurement where it is required to emit a noise or impulse signal in the room, the Cisco device will measure RT60 as a "silent measurement".

Due to the silent measurement behavior, the RT60 values will be indicative and not strictly correct according to the ISO 3382-2 standard.

The measurements will measure the RT60 values for each octave band from 125 Hz to 4 kHz.

Default value:

Off

Value space:

Off/On
On: activate the silent RT60 measurements.
Off: deactivate the silent RT60 measurements.

Room Kit

Room Kit Mini

Room 55

Room 55 Dual, Room 70

Room 70 G2

Room 70 Panorama

Room Panorama

RoomAnalytics T3AlarmDetection Mode

Applies to: All products

Requires user role: ADMIN, INTEGRATOR

T3 alarm detection allows the device to recognize the audio signal of a T3 fire alarm (T3 is the industry-standard alarm pattern in the United States). If an alarm is detected, the RoomAnalytics T3AlarmDetected status changes from False to True.

Important: It is not guaranteed that the device will detect an alarm. For example, low microphone levels will block detection. Therefore, you should not rely on this feature to raise awareness of an alarm and it does not replace any other safety and security measures and documentation.

Default value:

Off

Value space:

Off/On
Off: T3 alarm detection is disabled.
On: T3 alarm detection is enabled.

RoomAnalytics T3AlarmDetection Timeout

Applies to: All products

Requires user role: ADMIN, INTEGRATOR

When T3 alarm detection is enabled, if the system detects an alarm the RoomAnalytics T3AlarmDetected status will switch from False to True. The status switches back to False when no alarm has been detected for the number of seconds defined as the timeout.

Default value:

10

Value space:

Integer (5..60)
The timeout period in seconds.

Board

Board
ProCodec
EQCodec
PlusCodec
ProDesk,
Desk Pro,
Desk MiniRoom
Bar

Room Kit

Room Kit
Mini

Room 55

Room 55
Dual,
Room 70Room 70
G2Room 70
PanoramaRoom
Panorama

RoomCleanup settings

RoomCleanup AutoRun ContentType TemporaryAccounts

Applies to: All products

Requires user role: ADMIN

Delete any temporary accounts that may be logged-in on the device (for example, a OneDrive account accessed through an Enterprise Content Management (ECM) service).

Default value:

Daily

Value space:

Daily/Off

Daily: Enable the daily clearing of temporary accounts.

Off: Disable the daily clearing of temporary accounts.

RoomCleanup AutoRun ContentType WebData

Applies to: All products

Requires user role: ADMIN

Enable or disable the daily room cleanup of web data. Use RoomCleanup AutoRun HourOfDay to set the time of day.

Default value:

Daily

Value space:

Daily/Off

Daily: Enable the daily clearing of web data.

Off: Disable the daily clearing of web data.

RoomCleanup AutoRun ContentType Whiteboards

Applies to: All products

Requires user role: ADMIN

Enable or disable the daily room cleanup of whiteboards. Use RoomCleanup AutoRun HourOfDay to set the time of day.

Default value:

Daily

Value space:

Daily/Off

Daily: Enable the daily clearing of whiteboards.

Off: Disable the daily clearing of whiteboards.

RoomCleanup AutoRun HourOfDay

Applies to: All products

Requires user role: ADMIN

Set the hour of the day when room cleanup will be performed each day.

Default value:

0

Value space:

Integer (0..23)

The hour of the day at which the room cleanup will occur.

Board

Board
ProCodec
EQCodec
PlusCodec
ProDesk,
Desk Pro,
Desk MiniRoom
Bar

Room Kit

Room Kit
Mini

Room 55

Room 55
Dual,
Room 70Room 70
G2Room 70
PanoramaRoom
Panorama

RoomReset settings

RoomReset Control

Applies to: All products

Requires user role: ADMIN

This setting is for use with control systems or macros. Macros allow you to write snippets of JavaScript code that can automate parts of your video conferencing device, thus creating custom behavior.

When a room has been idle for some time the video conferencing device can send an event to indicate that the room is ready to be reset.

The events that are sent when this setting is enabled are:

```
*e RoomReset SecondsToReset: 30
```

```
** end
```

```
*e RoomReset Reset
```

```
** end
```

Default value:

On

Value space:

Off/On

Off: No RoomReset events will be sent.

On: The room reset control is enabled and RoomReset events will be sent.

RoomScheduler settings

RoomScheduler BookingTimeout

Applies to: All products

Requires user role: ADMIN

The scheduler will provide immediate feedback to a user when they book a room or a device; however, the calendar service can take some time to confirm the booking. If it takes too long to get the confirmation and this time exceeds the value set here, the booking will be cleared, and the device or room will be shown as available.

This is applicable to devices registered to the Webex cloud service or linked to Webex Edge for devices.

Default value:

60

Value space:

Integer (60..300)

The number of seconds to wait for a confirmation.

RoomScheduler Enabled

Applies to: All products

Requires user role: ADMIN

The room scheduling feature allows you to book a room directly from the touch controller that is in the meeting room. You can also extend an ongoing meeting if the room is still available. You can also use the Webex Assistant (voice-driven virtual assistant) to book or extend a meeting.

The room scheduling feature requires that the device is registered to the Webex cloud service or linked to Webex Edge for devices. In addition, the room must be set up with a calendar service that allows booking. The room scheduling feature is not supported on personal mode devices.

Default value:

False

Value space:

False/True

False: The room scheduling feature is not available.

True: The room scheduling feature is available if the prerequisites listed above are met.

Board

Board
ProCodec
EQCodec
PlusCodec
ProDesk,
Desk Pro,
Desk MiniRoom
Bar

Room Kit

Room Kit
Mini

Room 55

Room 55
Dual,
Room 70Room 70
G2Room 70
PanoramaRoom
Panorama

RTP settings

RTP Ports Range Start

Applies to: All products

Requires user role: ADMIN

Define the first port in the range of RTP ports.

The device is using the ports in the range defined by the RTP Ports Range Start and Stop settings for RTP and RTCP media data. The minimum range is 100 when RTP Video Ports Range is disabled, and 20 when RTP Video Ports Range is enabled.

If the RTP Video Ports Range is enabled, audio will use the range defined by the RTP Ports Range settings, and other media data will use the range defined by the RTP Video Ports Range settings. The two ranges must not overlap.

A change in the setting will take effect on new calls.

Note that the device uses another default RTP Port Range when registered to the Webex cloud, namely from 52050 (Start) to 52099 (Stop).

Default value:

2326

Value space:

Integer (1024..65438)

Set the first port in the range of RTP ports. The value must be an even number.

RTP Ports Range Stop

Applies to: All products

Requires user role: ADMIN

Define the last port in the range of RTP ports.

The device is using the ports in the range defined by the RTP Ports Range Start and Stop settings for RTP and RTCP media data. If the RTP Video Ports Range is enabled the device is using the ports in the range 1024 to 65436. The minimum range is 100 when RTP Video Ports Range is disabled, and 20 when RTP Video Ports Range is enabled.

If the RTP Video Ports Range is enabled, audio will use the range defined by the RTP Ports Range settings, and other media data will use the range defined by the RTP Video Ports Range settings. The two ranges must not overlap.

A change in the setting will take effect on new calls.

Note that the device uses another default RTP Port Range when registered to the Webex cloud, namely from 52050 (Start) to 52099 (Stop).

Default value:

2487

Value space:

Integer (1121..65535)

Set the last port in the range of RTP ports. The value must be an odd number. If you enter an even value, +1 will be automatically applied.

RTP Video Ports Range Start

Applies to: All products

Requires user role: ADMIN

Define the first port in the range of RTP video ports.

If both the start and stop values are set to 0, the RTP Video Ports Range is disabled. To enable it, set the first port to a value between 1024 and 65454 and the last port between 1024 and 65535. The minimum range is 80.

If the RTP Video Ports Range is enabled, audio will use the range defined by the RTP Ports Range settings, and other media data will use the range defined by the RTP Video Ports Range settings. The two ranges must not overlap.

A change in the setting will take effect on new calls.

Note that the device uses another default RTP Video Port Range when registered to the Webex cloud, namely from 52200 (Start) to 52299 (Stop).

Default value:

0

Value space:

Integer (0, 1024..65454)

Set the first port in the range of RTP video ports.

Board

Board
ProCodec
EQCodec
PlusCodec
ProDesk,
Desk Pro,
Desk MiniRoom
Bar

Room Kit

Room Kit
Mini

Room 55

Room 55
Dual,
Room 70Room 70
G2Room 70
PanoramaRoom
Panorama

RTP Video Ports Range Stop

Applies to: All products

Requires user role: ADMIN

Define the last port in the range of RTP video ports.

If both the start and stop values are set to 0, the RTP Video Ports Range is disabled. To enable it, set the first port to a value between 1024 and 65454 and the last port between 1024 and 65535. The minimum range is 80.

If the RTP Video Ports Range is enabled, audio will use the range defined by the RTP Ports Range settings, and other media data will use the range defined by the RTP Video Ports Range settings. The two ranges must not overlap.

A change in the setting will take effect on new calls.

Note that the device uses another default RTP Video Port Range when registered to the Webex cloud, namely from 52200 (Start) to 52299 (Stop).

Default value:

0

Value space:

Integer (0, 1024..65535)

Set the last port in the range of RTP video ports.

Security settings

Security Audit Logging Mode

Applies to: All products

Requires user role: AUDIT

Define where to record or transmit the audit logs. The audit logs are sent to a syslog server. This setting has no effect if the Logging Mode setting is set to Off.

When using the External or ExternalSecure mode you must enter the address of the audit server in the Security Audit Server Address setting.

Default value:

Internal

Value space:

External/ExternalSecure/Internal/Off

External: The device sends the audit logs to an external syslog server. The syslog server must support UDP.

ExternalSecure: The device sends encrypted audit logs to an external syslog server that is verified by a certificate in the Audit CA list. The Audit CA list file must be uploaded to the device using the web interface. The common_name parameter of a certificate in the CA list must match the IP address or DNS name of the syslog server, and the secure TCP server must be set up to listen for secure (TLS) TCP Syslog messages.

Internal: The device records the audit logs to internal logs, and rotates logs when they are full.

Off: No audit logging is performed.

Board

Security Audit OnError Action

Applies to: All products

Requires user role: AUDIT

Define what happens when the connection to the syslog server is lost. This setting is only relevant when Security Audit Logging Mode is set to ExternalSecure.

Default value:

Ignore

Value space:

Halt/Ignore

Halt: If a halt condition is detected the device is rebooted and only the auditor is allowed to operate the unit until the halt condition has passed. When the halt condition has passed the audit logs are re-spooled to the syslog server. Halt conditions are: A network breach (no physical link), no syslog server running (or incorrect address or port to the syslog server), TLS authentication failed (if in use), local backup (re-spooling) log full.

Ignore: The device will continue its normal operation, and rotate internal logs when full. When the connection is restored it will again send its audit logs to the syslog server.

Security Audit Server Address

Applies to: All products

Requires user role: AUDIT

Set the IP address or DNS name of the syslog server that the audit logs are sent to. This setting is only relevant when Security Audit Logging Mode is set to External or ExternalSecure.

Default value:

""

Value space:

String (0, 255)

A valid IPv4 address, IPv6 address, or DNS name.

Board Pro

Codec EQ

Codec Plus

Codec Pro

Desk, Desk Pro, Desk Mini

Room Bar

Room Kit

Room Kit Mini

Room 55

Room 55 Dual, Room 70

Room 70 G2

Room 70 Panorama

Room Panorama

Security Audit Server Port

Applies to: All products

Requires user role: AUDIT

The audit logs are sent to a syslog server. Define the port of the syslog server that the device shall send its audit logs to. This setting is only relevant when Security Audit Server PortAssignment is set to Manual.

Default value:

514

Value space:

Integer (0..65535)

Set the audit server port.

Security Audit Server PortAssignment

Applies to: All products

Requires user role: AUDIT

The audit logs are sent to a syslog server. You can define how the port number of the external syslog server will be assigned. This setting is only relevant when Security Audit Logging Mode is set to External or ExternalSecure. To see which port number is used you can check the Security Audit Server Port status. Navigate to Setup > Status on the web interface or; if on a command line interface, run the command xStatus Security Audit Server Port.

Default value:

Auto

Value space:

Auto/Manual

Auto: Will use UDP port number 514 when the Security Audit Logging Mode is set to External. Will use TCP port number 6514 when the Security Audit Logging Mode is set to ExternalSecure.

Manual: Will use the port value defined in the Security Audit Server Port setting.

Board

Security Fips Mode

Applies to: All products

Requires user role: ADMIN

If required, you can set the device in FIPS mode (Federal Information Processing Standard (FIPS) Publication 140-3, Security Requirements for Cryptographic Modules). While in FIPS mode Digest access authentication is not supported between the device and an HTTP Proxy because Digest access authentication is using MD5 cryptographic hashing, which is not allowed in FIPS.

You should allow only HTTPS, and don't switch on SNMP or IEEE8021X in FIPS mode (keep the default values).

For changes to this setting to take full effect, you must restart the device.

Default value:

Off

Value space:

Off/On

Off: The device is not in FIPS mode.

On: The device is in FIPS mode.

Board Pro

Codec EQ

Codec Plus

Codec Pro

Desk, Desk Pro, Desk Mini

Room Bar

Room Kit

Room Kit Mini

Room 55

Room 55 Dual, Room 70

Room 70 G2

Room 70 Panorama

Room Panorama

Security Session InactivityTimeout

Applies to: All products

Requires user role: ADMIN

Define how long the device will accept inactivity from the user before automatically logging out from a web or SSH session.

Restart the device for any change to this setting to take effect.

Default value:

0

Value space:

Integer (0..10000)

Set the inactivity timeout (minutes). Specifying 0 will result in a time out of 1 hour. The maximum timeout length is 12 hours.

Security Session MaxFailedLogins

Applies to: All products

Requires user role: ADMIN

Define the maximum number of failed login attempts per user for a web or SSH session. If the user exceeded the maximum number of attempts the user will be locked out. 0 means that there is no limit for failed logins.

Restart the device for any change to this setting to take effect.

Default value:

0

Value space:

Integer (0..10)

Set the maximum number of failed login attempts per user.

Security Session MaxSessionsPerUser

Applies to: All products

Requires user role: ADMIN

The maximum number of simultaneous sessions per user is 20 sessions.

Default value:

20

Value space:

Integer (1..20)

Set the maximum number of simultaneous sessions per user.

Board

Security Session MaxTotalSessions

Applies to: All products

Requires user role: ADMIN

The maximum number of simultaneous sessions in total is 20 sessions.

Default value:

20

Value space:

Integer (1..20)

Set the maximum number of simultaneous sessions in total.

Board
ProCodec
EQCodec
PlusCodec
ProDesk,
Desk Pro,
Desk MiniRoom
Bar

Room Kit

Room Kit
Mini

Room 55

Room 55
Dual,
Room 70Room 70
G2Room 70
PanoramaRoom
Panorama

Security Xapi WebSocket ApiKey Allowed

Applies to: All products

Requires user role: ADMIN

Enable or disable access to the API over web sockets from a remotely paired Room Navigator. A typical use case that requires API access is a persistent web app, for example a custom booking app, that want to control the color of the LEDs on the Room Navigator. If API access is disabled, apps that don't require any communication with the device's API can still run on the Room Navigator.

Note: Persistent web apps are only available on Room Navigators that are paired to the device over the network.

Default value:

False

Value space:

False/True

True: A Room Navigator can interact with the device's API over web sockets, provided that the device is set up to allow interaction with the API over WebSockets in general (NetworkServices HTTP Mode: HTTPS or HTTP+HTTPS and NetworkServices WebSocket: FollowHTTPService). Also, the domain of the server hosting the app must be listed in the WebEngine Features Xapi Peripherals AllowedHosts Hosts setting.

False: The Room Navigator is not allowed to interact with the device's API over web sockets.

Security Session ShowLastLogin

Applies to: All products

Requires user role: ADMIN

When logging in to the device using SSH you will see the UserId, time and date of the last session that did a successful login.

Default value:

Off

Value space:

Off/On

On: Show information about the last session.

Off: Do not show information about the last session.

Board

Board
ProCodec
EQCodec
PlusCodec
ProDesk,
Desk Pro,
Desk MiniRoom
Bar

Room Kit

Room Kit
Mini

Room 55

Room 55
Dual,
Room 70Room 70
G2Room 70
PanoramaRoom
Panorama

SerialPort settings

SerialPort Mode

Applies to: All products

Requires user role: ADMIN, INTEGRATOR

Enable/disable the serial port. If the device has more than one serial port, this setting applies to all of them.

This setting is not available for the first generation of boards (Board 55 and Board 70).

Default value:

On

Value space:

Off/On

Off: Serial communication is disabled.

On: Serial communication is enabled.

SerialPort BaudRate

Applies to: All products

Requires user role: ADMIN, INTEGRATOR

Set the baud rate (data transmission rate) for the serial port. A new baud rate takes effect after a device reboot.

Other connection parameters for the serial port are: Data bits: 8; Parity: None; Stop bits: 1; Flow control: None.

This setting does not have any effect on a dedicated maintenance port (micro USB). The maintenance port always uses the default baud rate.

This setting is not available for the first generation of boards (Board 55 and Board 70).

Default value:

115200

Value space:

115200 [[RoomKit](#) [RoomKitMini](#) [RoomBar](#) [CodecEQ](#) [CodecPlus](#) [Room55](#) [Room70/Room55D](#) [DeskMini](#) [Desk](#) [DeskPro](#) [Board](#) [BoardPro](#)]

9600/19200/38400/57600/115200 [[CodecPro](#) [Room70G2](#) [RoomPanorama/Room70Panorama](#)]

Choose a baud rate from the list (bits per second).

SerialPort LoginRequired

Applies to: All products

Requires user role: ADMIN

Define if login shall be required when connecting to a serial port. If the device has more than one serial port, this setting applies to all of them.

This setting is not available for the first generation of boards (Board 55 and Board 70).

Default value:

On

Value space:

Off/On

Off: The user can access the device via the serial port without any login.

On: Login is required when connecting to the device via the serial port.

Board

Board
ProCodec
EQCodec
PlusCodec
ProDesk,
Desk Pro,
Desk MiniRoom
Bar

Room Kit

Room Kit
Mini

Room 55

Room 55
Dual,
Room 70Room 70
G2Room 70
PanoramaRoom
Panorama

SIP settings

SIP ANAT

Applies to: All products

Requires user role: ADMIN

ANAT (Alternative Network Address Types) enables media negotiation for multiple addresses and address types, as specified in RFC 4091.

Default value:

Off

Value space:

Off/On

Off: Disable ANAT.

On: Enable ANAT.

SIP Authentication UserName

Applies to: All products

Requires user role: ADMIN

This is the username part of the credentials used to authenticate towards the SIP proxy.

Default value:

""

Value space:

String (0, 128)

A valid username.

SIP Authentication Password

Applies to: All products

Requires user role: ADMIN

This is the password part of the credentials used to authenticate towards the SIP proxy.

Default value:

""

Value space:

String (0, 128)

A valid password.

SIP DefaultTransport

Applies to: All products

Requires user role: ADMIN

Select the transport protocol to be used over the LAN.

Default value:

Auto

Value space:

Auto/TCP/Tls/UDP

TCP: The device will always use TCP as the default transport method.

UDP: The device will always use UDP as the default transport method.

Tls: The device will always use TLS as the default transport method. For TLS connections a SIP CA-list can be uploaded to the device. If no such CA-list is available on the device then anonymous Diffie Hellman will be used.

Auto: The device will try to connect using transport protocols in the following order: TLS, TCP, UDP.

SIP DisplayName

Applies to: All products

Requires user role: ADMIN

When configured the incoming call will report the display name instead of the SIP URI.

Default value:

""

Value space:

String (0, 550)

The name to be displayed instead of the SIP URI.

Board

SIP Ice DefaultCandidate

Applies to: All products

Requires user role: ADMIN

The ICE protocol needs some time to reach a conclusion about which media route to use (up to the first 5 seconds of a call). During this period media for the device will be sent to the Default Candidate as defined in this setting.

Default value:

Host

Value space:

Host/Rflx/Relay

Host: Send media to the device's private IP address.

Rflx: Send media to the device's public IP address, as seen by the TURN server.

Relay: Send media to the IP address and port allocated on the TURN server.

Board
ProCodec
EQCodec
PlusCodec
ProDesk,
Desk Pro,
Desk MiniRoom
Bar

Room Kit

Room Kit
Mini

Room 55

Room 55
Dual,
Room 70Room 70
G2Room 70
PanoramaRoom
Panorama

SIP Ice Mode

Applies to: All products

Requires user role: ADMIN

ICE (Interactive Connectivity Establishment, RFC 5245) is a NAT traversal solution that the devices can use to discover the optimized media path. Thus the shortest route for audio and video is always secured between the devices. Initially STUN (Session Traversal Utilities for NAT) messages are exchanged when setting up the media path.

Note that STUN also, regardless of the SIP Ice Mode, is used as a keep-alive mechanism to refresh NAT bindings.

Default value:

Auto

Value space:

Auto/Off/On

Auto: ICE is enabled if a TURN server is provided, otherwise ICE is disabled.

Off: ICE is disabled.

On: ICE is enabled.

SIP Line

Applies to: All products

Requires user role: ADMIN

When registered to a Cisco Unified Communications Manager (CUCM) the device may be part of a shared line. This means that several devices share the same directory number. The different devices sharing the same number receive status from the other appearances on the line as defined in RFC 4235.

Note that shared lines are set up by CUCM, not by the device. Therefore do not change this setting manually; CUCM pushes this information to the device when required.

Default value:

Private

Value space:

Private/Shared

Shared: The device is part of a shared line and is therefore sharing its directory number with other devices.

Private: This device is not part of a shared line.

SIP ListenPort

Applies to: All products

Requires user role: ADMIN

Turn on or off the listening for incoming connections on the SIP TCP/UDP ports. If turned off, the device will only be reachable through a SIP Proxy (CUCM or VCS). As a security measure, SIP ListenPort should be Off when the device is registered to a SIP Proxy.

Default value:

On [[RoomKit](#) [RoomKitMini](#) [RoomBar](#) [CodecEQ](#) [CodecPlus](#) [CodecPro](#) [Room55](#) [Room70/Room55D](#) [Room70G2](#) [RoomPanorama/Room70Panorama](#) [DeskMini](#) [Desk](#) [BoardPro](#)]

Auto [[DeskPro](#) [Board](#)]

Value space:

Auto/Off/On

Auto: Listening for incoming connections on the SIP TCP/UDP ports is automatically turned off if the device is registered to a SIP Proxy; otherwise it is turned on.

Off: Listening for incoming connections on the SIP TCP/UDP ports is turned off.

On: Listening for incoming connections on the SIP TCP/UDP ports is turned on.

Board

Board
ProCodec
EQCodec
PlusCodec
ProDesk,
Desk Pro,
Desk MiniRoom
Bar

Room Kit

Room Kit
Mini

Room 55

Room 55
Dual,
Room 70Room 70
G2Room 70
PanoramaRoom
Panorama

SIP Mailbox

Applies to: All products

Requires user role: ADMIN

When registered to a Cisco Unified Communications Manager (CUCM) you may be offered the option of having a private voice mailbox.

Default value:

""

Value space:

String (0, 255)

A valid number or address. Leave the string empty if you do not have a voice mailbox.

SIP MinimumTLSVersion

Applies to: All products

Requires user role: ADMIN

Set the lowest version of the TLS (Transport Layer Security) protocol that is allowed for SIP.

Default value:

TLSv1.0

Value space:

TLSv1.0/TLSv1.1/TLSv1.2

TLSv1.0: Support TLS version 1.0 or higher.

TLSv1.1: Support TLS version 1.1 or higher.

TLSv1.2: Support TLS version 1.2 or higher.

SIP PreferredIPSignaling

Applies to: All products

Requires user role: ADMIN

Define the preferred IP version for signaling (audio, video, data). Only applicable when both Network IPStack and Conference CallProtocolIPStack are set to Dual, and the network does not have a mechanism for choosing the preferred IP version. It also determines the priority of the A/AAAA lookups in DNS, so that the preferred IP version is used for registration.

Default value:

IPv4

Value space:

IPv4/IPv6

IPv4: The preferred IP version for signaling is IPv4.

IPv6: The preferred IP version for signaling is IPv6.

SIP Proxy [n] Address

Applies to: All products

Requires user role: ADMIN

The Proxy Address is the manually configured address for the outbound proxy. It is possible to use a fully qualified domain name, or an IP address. The default port is 5060 for TCP and UDP but another one can be provided.

Default value:

""

Value space:

String (0, 255)

A valid IPv4 address, IPv6 address or DNS name.

n: Index that identifies the proxy (maximum 4 proxies can be defined).

Range: 1..4

SIP TlsVerify

Applies to: All products

Requires user role: ADMIN

Before establishing a connection over SIP TLS, the device checks if the certificate of the peer is signed by a trusted Certificate Authority (CA). The CA must be included in the CA list that is manually uploaded to the device using the web interface or API. The list of pre-installed certificates is not used to validate certificates for SIP TLS connections.

Note: The value is set to Off for a device that has been upgraded to CE9.9 (or later) from CE9.8 or earlier software versions, provided that the device has not been factory reset after the upgrade, and that the setting was not explicitly set to On.

Use the SIP MinimumTLSVersion setting to specify which TLS versions are allowed.

Default value:

On

Value space:

Off/On

Off: The device doesn't check the certificate of the peer. The SIP TLS connection is established anyway.

On: The device checks if the certificate of the peer can be trusted. If not, the SIP TLS connection is not established.

Board

SIP Turn Server

Applies to: All products

Requires user role: ADMIN

Define the address of the TURN (Traversal Using Relay NAT) server. It is used as a media relay fallback and it is also used to discover the device's own public IP address.

Default value:

""

Value space:

String (0, 255)

The preferred format is DNS SRV record (for example, _turn._udp.<domain>), or it can be a valid IPv4 or IPv6 address.

Board Pro

Codec EQ

Codec Plus

Codec Pro

Desk, Desk Pro, Desk Mini

Room Bar

Room Kit

Room Kit Mini

Room 55

Room 55 Dual, Room 70

Room 70 G2

Room 70 Panorama

Room Panorama

SIP Type

Applies to: All products

Requires user role: ADMIN

Enables SIP extensions and special behavior for a vendor or provider.

Default value:

Standard

Value space:

Standard/Cisco

Standard: Use this when registering to standard SIP Proxy (tested with Cisco TelePresence VCS).

Cisco: Use this when registering to Cisco Unified Communication Manager.

SIP URI

Applies to: All products

Requires user role: ADMIN

The SIP URI (Uniform Resource Identifier) is the address that is used to identify the device. The URI is registered and used by the SIP services to route inbound calls to the device. The SIP URI syntax is defined in RFC 3261.

Default value:

""

Value space:

String (0, 255)

An address (URI) that is compliant with the SIP URI syntax.

Board

Board
ProCodec
EQCodec
PlusCodec
ProDesk,
Desk Pro,
Desk MiniRoom
Bar

Room Kit

Room Kit
Mini

Room 55

Room 55
Dual,
Room 70Room 70
G2Room 70
PanoramaRoom
Panorama

Standby settings

Standby BootAction

Applies to: All products

Requires user role: ADMIN, INTEGRATOR, USER

Define the camera position after a restart of the video conferencing device.

Default value:

DefaultCameraPosition [RoomKit RoomKitMini RoomBar CodecEQ CodecPlus CodecPro Room55 Room70/Room55D Room70G2 RoomPanorama/Room70Panorama DeskMini Desk BoardPro]

RestoreCameraPosition [DeskPro Board]

Value space:

None/DefaultCameraPosition/RestoreCameraPosition

None: No action.

RestoreCameraPosition: When the video conferencing device restarts, the camera returns to the position that it had before the restart.

DefaultCameraPosition: When the video conferencing device restarts, the camera moves to the factory default position.

Standby Control

Applies to: All products

Requires user role: ADMIN, INTEGRATOR

Define whether the device should go into standby mode or not.

Default value:

On

Value space:

Off/On [RoomKit RoomKitMini RoomBar CodecEQ CodecPlus CodecPro Room55 Room70/Room55D Room70G2 DeskMini Desk DeskPro Board BoardPro]

On [RoomPanorama/Room70Panorama]

Off: The device will not enter standby mode.

On: The device will enter standby mode when the Standby Delay has timed out.

Standby Delay

Applies to: All products

Requires user role: ADMIN, INTEGRATOR

Define how long (in minutes) the device shall be in idle mode before it goes into standby mode.

Requires the Standby Control to be enabled.

Default value:

10 [RoomKit RoomKitMini RoomBar CodecEQ CodecPlus CodecPro Room55 Room70/Room55D Room70G2 RoomPanorama/Room70Panorama DeskMini Desk DeskPro]

4 [Board BoardPro]

Value space:

Integer (1..480)

Set the standby delay (minutes).

Standby Level Networked Delay

Applies to: RoomBar DeskMini Desk

Requires user role: ADMIN, INTEGRATOR

Define how long (in minutes) the device shall be in the "Display Off" level of standby mode before it goes into the "Networked" level of standby mode.

If the delay is set to 0, the device will go directly to Networked Standby, skipping the "Display Off" level.

Default value:

2

Value space:

Integer (0..1440)

Set the standby level networked delay (minutes).

Board

Standby Level Networked Mode

Applies to: RoomBar DeskMini Desk

Requires user role: ADMIN, INTEGRATOR

Disable/enable the automatic transition to networked standby mode.

Networked standby mode is a deeper level of standby which reduces power consumption further than the regular standby mode.

The device will enter the "Networked" level of standby mode after it has been in the "DisplayOff" level, for x minutes, as defined in the Standby Level Networked Delay setting.

The Standby Control setting must be set to On for standby mode to be automatically initiated; however, you can trigger it manually with the Standby Activate command.

Default value:

On

Value space:

Off/On

On: The device will enter networked standby mode when the Standby Level Networked Delay has timed out.

Off: The device will not enter networked standby mode.

Standby Halfwake Mode

Applies to: All products

Requires user role: ADMIN

Disable/Enable the automatic halfwake mode.

By default, the device goes into halfwake mode after 2 minutes of inactivity.

It remains in halfwake mode until activity is detected or until it goes into standby mode.

If enabled in the Standby Control setting and regardless of Standby Halfwake Mode setting, the device will go into standby after x minutes of inactivity, where x is defined by the Standby Delay setting.

Default value:

Auto

Value space:

Auto/Manual

Auto: By default, the device will go into halfwake mode after 2 minutes of inactivity. It will remain in halfwake mode until it enters Active mode or Standby mode, if enabled.

Manual: The automatic halfwake mode is disabled. It can only be triggered manually with xCommand Standby Halfwake.

Standby Signage Audio

Applies to: All products

Requires user role: ADMIN, INTEGRATOR

By default, a device does not play out audio in digital signage mode even if the web page has audio. You can use this setting to override the default behavior.

Default value:

Off

Value space:

Off/On

Off: The device does not play out audio with the web page.

On: If the web page has audio, the device plays it out. The volume follows the volume setting of the device.

Standby Signage InteractionMode

Applies to: RoomKitMini RoomBar DeskMini Desk DeskPro Board BoardPro

Requires user role: ADMIN, INTEGRATOR

By default, a user cannot interact with a digital signage web page. You can use this setting to enable the ability to interact with the web page.

The Interactive mode is not available for Room Kit Mini in general, only when Room Kit Mini is used with Samsung Flip (Webex on Flip).

Default value:

NonInteractive

Value space:

Interactive/NonInteractive

Interactive: It's possible to interact with the web page.

NonInteractive: It's not possible to interact with the web page.

Board

Standby Signage Mode

Applies to: All products

Requires user role: ADMIN, INTEGRATOR

Content from a URL (a web page) can replace the traditional halfwake background image and information.

This feature is called digital signage. Users can interact with the web page if the device has an interactive screen, for example click on a link or enter text in a form.

The use of digital signage does not prevent the device from entering standby the normal way. Therefore, the Standby Delay setting determines for how long the digital signage is shown before the device goes into standby.

Default value:

Off

Value space:

Off/On

Off: Digital signage is not enabled on the device.

On: Digital signage is enabled and replaces the device's halfwake mode, provided that also the WebEngine Mode setting is On.

Board Pro

Codec EQ

Codec Plus

Codec Pro

Desk, Desk Pro, Desk Mini

Room Bar

Room Kit

Room Kit Mini

Room 55

Room 55 Dual, Room 70

Room 70 G2

Room 70 Panorama

Room Panorama

Standby Signage Url

Applies to: All products

Requires user role: ADMIN, INTEGRATOR

Set the URL of the web page you want to display on the screen (digital signage).

If the length of the URL is 0, the device retains normal halfwake mode.

If the URL fails, the device retains normal halfwake mode and a diagnostics message is issued.

Default value:

""

Value space:

String (0, 2048)

The URL of the web page.

Standby StandbyAction

Applies to: RoomKit RoomKitMini RoomBar CodecEQ CodecPlus CodecPro Room55 Room70/Room55D Room70G2 RoomPanorama/Room70Panorama DeskMini Desk DeskPro BoardPro

Requires user role: ADMIN, INTEGRATOR

Define the camera position when going into standby mode.

Default value:

PrivacyPosition

Value space:

None/PrivacyPosition

None: No action.

PrivacyPosition: When the video conferencing device enters standby, the camera turns to a sideways position for privacy.

Standby Signage RefreshInterval

Applies to: All products

Requires user role: ADMIN, INTEGRATOR

Trigger a web page to refresh at regular intervals (in seconds).

This is useful for web pages that are not able to refresh themselves.

It is not recommended to set a refresh interval with the interactive mode.

Default value:

0

Value space:

Integer (0..1440)

The number of seconds between each web page refresh. The value of 0 means that the web page is never forced to refresh.

Board

Standby WakeupAction

Applies to: All products

Requires user role: ADMIN, INTEGRATOR, USER

Define the camera position when leaving standby mode.

Default value:

RestoreCameraPosition

Value space:

None/RestoreCameraPosition/DefaultCameraPosition

None: No action.

RestoreCameraPosition: When the video conferencing device leaves standby, the camera returns to the position that it had before entering standby.

DefaultCameraPosition: When the video conferencing device leaves standby, the camera moves to the factory default position.

Standby WakeupAtMeetingStart

Applies to: All products

Requires user role: ADMIN, INTEGRATOR

Choose whether the device shall wake up automatically when a meeting is scheduled to start. If no one joins the meeting or otherwise interacts with the device, it goes to halfwake and then standby a few minutes after the scheduled start.

Default value:

Auto

Value space:

Auto/Off

Auto: The device wakes up before a scheduled meeting is about to start.

Off: The device remains in standby, even if a meeting is scheduled to start.

Standby WakeupOnMotionDetection

Applies to: All products

Requires user role: ADMIN, INTEGRATOR

Automatic wake up on motion detection is a feature that allows the device to detect when people enter the room. The feature is based on ultrasound detection.

Ultrasound signals for motion detection are not emitted when both this setting AND the RoomAnalytics PeoplePresenceDetector setting are switched Off. The Audio Ultrasound MaxVolume and Proximity Mode settings has no effect on motion detection.

Default value:

On [[RoomKit](#) [RoomKitMini](#) [RoomBar](#) [CodecEQ](#) [Room55](#) [Room70/Room55D](#) [Room70G2](#) [RoomPanorama/Room70Panorama](#) [DeskMini](#) [Desk](#) [DeskPro](#) [Board](#) [BoardPro](#)]

Off [[CodecPlus](#) [CodecPro](#)]

Value space:

Off/On

Off: Wake up on motion detection is disabled.

On: When people walk into the room the device will automatically wake up from standby.

Board Pro

Codec EQ

Codec Plus

Codec Pro

Desk, Desk Pro, Desk Mini

Room Bar

Room Kit

Room Kit Mini

Room 55

Room 55 Dual, Room 70

Room 70 G2

Room 70 Panorama

Room Panorama

Board

Board
ProCodec
EQCodec
PlusCodec
ProDesk,
Desk Pro,
Desk MiniRoom
Bar

Room Kit

Room Kit
Mini

Room 55

Room 55
Dual,
Room 70Room 70
G2Room 70
PanoramaRoom
Panorama

SystemUnit settings

SystemUnit Name

Applies to: All products

Requires user role: ADMIN

Define the device name. The device name will be sent as the hostname in a DHCP request and when the device is acting as an SNMP Agent.

Default value:

" "

Value space:

String (0, 50)

Define the device name.

SystemUnit BroadcastName

Applies to: All products

Requires user role: ADMIN

A broadcast name is the name that other devices, such as laptops and mobile phones, will see in their scan lists for services such as Airplay, Miracast, and Bluetooth. You can specify a specific broadcast name with this setting. If you don't specifically set a broadcast name here, the scan lists will include the Webex DisplayName if the device is registered to the Webex cloud service, and the SystemUnit Name if registered to an on-premises service. If neither of these names are set, the product type (id) will be displayed.

We recommend you not include PII (personally identifiable information) in a broadcast name.

Default value:

" "

Value space:

String (0, 256)

The broadcast name that will be shown in other devices' scan lists.

SystemUnit CrashReporting Advanced

Applies to: All products

Requires user role: ADMIN

If the device crashes, the device can automatically send logs to the Cisco Automatic Crash Report tool (ACR) for analyses. The ACR tool is for Cisco internal use only and not available to customers.

Default value:

On

Value space:

Off/On

Off: The ACR tool will perform standard log analyses.

On: The ACR tool will perform advanced log analyses.

SystemUnit CrashReporting Mode

Applies to: All products

Requires user role: ADMIN

If the device crashes, the device can automatically send logs to the Cisco Automatic Crash Report tool (ACR) for analyses. The ACR tool is for Cisco internal use only and not available to customers.

Default value:

On

Value space:

Off/On

Off: No logs will be sent to ACR tool.

On: The logs will automatically be sent to ACR tool.

SystemUnit CrashReporting URL

Applies to: All products

Requires user role: ADMIN

If the device crashes, the device can automatically send logs to the Cisco Automatic Crash Report tool (ACR) for analyses. The ACR tool is for Cisco internal use only and not available to customers.

Default value:

"acr.cisco.com"

Value space:

String (0, 255)

The URL to the Cisco Automatic Crash Report tool (ACR).

Board

Board
ProCodec
EQCodec
PlusCodec
ProDesk,
Desk Pro,
Desk MiniRoom
Bar

Room Kit

Room Kit
Mini

Room 55

Room 55
Dual,
Room 70Room 70
G2Room 70
PanoramaRoom
Panorama

SystemUnit CustomDeviceld

Applies to: All products

Requires user role: ADMIN, INTEGRATOR

The SystemUnit CustomDeviceld provides a place for you to store custom information about a unit. This can be useful, for example, in aiding to track devices in a provisioning setup).

Default value:

""

Value space:

String (0, 255)

Time settings

Time DateFormat

Applies to: All products

Requires user role: ADMIN, USER

Define the date format.

Default value:

DD_MM_YY

Value space:

DD_MM_YY/MM_DD_YY/YY_MM_DD

DD_MM_YY: The date January 30th 2010 will be displayed: 30.01.10

MM_DD_YY: The date January 30th 2010 will be displayed: 01.30.10

YY_MM_DD: The date January 30th 2010 will be displayed: 10.01.30

Time TimeFormat

Applies to: All products

Requires user role: ADMIN, USER

Define the time format.

Default value:

24H

Value space:

24H/12H

24H: Set the time format to 24 hours.

12H: Set the time format to 12 hours (AM/PM).

Board

Board
ProCodec
EQCodec
PlusCodec
ProDesk,
Desk Pro,
Desk MiniRoom
Bar

Room Kit

Room Kit
Mini

Room 55

Room 55
Dual,
Room 70Room 70
G2Room 70
PanoramaRoom
Panorama

Time Zone

Applies to: All products

Requires user role: ADMIN, INTEGRATOR, USER

Define the time zone for the geographical location of the device. The information in the value space is from the tz database, also called the IANA Time Zone Database.

Default value:

Etc/UTC

Value space:

Africa/Abidjan, Africa/Accra, Africa/Addis_Ababa, Africa/Algiers, Africa/Asmara, Africa/Asmera, Africa/Bamako, Africa/Bangui, Africa/Banjul, Africa/Bissau, Africa/Blantyre, Africa/Brazzaville, Africa/Bujumbura, Africa/Cairo, Africa/Casablanca, Africa/Ceuta, Africa/Conakry, Africa/Dakar, Africa/Dar_es_Salaam, Africa/Djibouti, Africa/Douala, Africa/El_Aaiun, Africa/Freetown, Africa/Gaborone, Africa/Harare, Africa/Johannesburg, Africa/Juba, Africa/Kampala, Africa/Khartoum, Africa/Kigali, Africa/Kinshasa, Africa/Lagos, Africa/Libreville, Africa/Lome, Africa/Luanda, Africa/Lubumbashi, Africa/Lusaka, Africa/Malabo, Africa/Maputo, Africa/Maseru, Africa/Mbabane, Africa/Mogadishu, Africa/Monrovia, Africa/Nairobi, Africa/Ndjamena, Africa/Niamey, Africa/Nouakchott, Africa/Ouagadougou, Africa/Porto-Novo, Africa/Sao_Tome, Africa/Timbuktu, Africa/Tripoli, Africa/Tunis, Africa/Windhoek, America/Adak, America/Anchorage, America/Anguilla, America/Antigua, America/Araguaina, America/Argentina/Buenos_Aires, America/Argentina/Catamarca, America/Argentina/ComodRivadavia, America/Argentina/Cordoba, America/Argentina/Jujuy, America/Argentina/La_Rioja, America/Argentina/Mendoza, America/Argentina/Rio_Gallegos, America/Argentina/Salta, America/Argentina/San_Juan, America/Argentina/San_Luis, America/Argentina/Tucuman, America/Argentina/Ushuaia, America/Aruba, America/Asuncion, America/Atikokan, America/Atka, America/Bahia, America/Bahia_Banderas, America/Barbados, America/Belem, America/Belize, America/Blanc-Sablon, America/Boa_Vista, America/Bogota, America/Boise, America/Buenos_Aires, America/Cambridge_Bay, America/Campo_Grande, America/Cancun, America/Caracas, America/Catamarca, America/Cayenne, America/Cayman, America/Chicago, America/Chihuahua, America/Ciudad_Juarez, America/Coral_Harbour, America/Cordoba, America/Costa_Rica, America/Creston, America/Cuiaba, America/Curacao, America/Danmarkshavn, America/Dawson, America/Dawson_Creek, America/Denver, America/Detroit, America/Dominica, America/Edmonton, America/Eirunepe, America/El_Salvador, America/Ensenada, America/Fort_Nelson, America/Fort_Wayne, America/Fortaleza, America/Glace_Bay, America/Godthab, America/Goose_Bay, America/Grand_Turk, America/Grenada, America/Guadeloupe, America/Guatemala, America/Guayaquil, America/Guyana, America/Halifax, America/Havana, America/Hermosillo, America/Indiana/Indianapolis, America/Indiana/Knox, America/Indiana/Marengo, America/Indiana/Petersburg, America/Indiana/Tell_City, America/Indiana/Vevay, America/Indiana/Vincennes, America/Indiana/Winamac, America/Indianapolis, America/Inuvik, America/Iqaluit, America/Jamaica, America/Jujuy, America/Juneau, America/Kentucky/Louisville, America/Kentucky/Monticello, America/Knox_IN, America/Kralendijk, America/La_Paz, America/Lima, America/Los_Angeles, America/Louisville, America/Lower_Princes, America/Maceio, America/Managua, America/Manaus, America/Marigot, America/Martinique, America/Matamoros, America/Mazatlan, America/Mendoza, America/Menominee, America/Merida, America/Metlakatla, America/Mexico_City, America/

Miquelon, America/Moncton, America/Monterrey, America/Montevideo, America/Montreal, America/Montserrat, America/Nassau, America/New_York, America/Nipigon, America/Nome, America/Noronha, America/North_Dakota/Beulah, America/North_Dakota/Center, America/North_Dakota/New_Salem, America/Nuuk, America/Ojinaga, America/Panama, America/Pangnirtung, America/Paramaribo, America/Phoenix, America/Port-au-Prince, America/Port_of_Spain, America/Porto_Acre, America/Porto_Velho, America/Puerto_Rico, America/Punta_Arenas, America/Rainy_River, America/Rankin_Inlet, America/Recife, America/Regina, America/Resolute, America/Rio_Branco, America/Rosario, America/Santa_Isabel, America/Santarem, America/Santiago, America/Santo_Domingo, America/Sao_Paulo, America/Scoresbysund, America/Shiprock, America/Sitka, America/St_Barthlemy, America/St_Johns, America/St_Kitts, America/St_Lucia, America/St_Thomas, America/St_Vincent, America/Swift_Current, America/Tegucigalpa, America/Thule, America/Thunder_Bay, America/Tijuana, America/Toronto, America/Tortola, America/Vancouver, America/Virgin, America/Whitehorse, America/Winnipeg, America/Yakutat, America/Yellowknife, Antarctica/Casey, Antarctica/Davis, Antarctica/DumontDURville, Antarctica/Macquarie, Antarctica/Mawson, Antarctica/McMurdo, Antarctica/Palmer, Antarctica/Rothera, Antarctica/South_Pole, Antarctica/Syowa, Antarctica/Troll, Antarctica/Vostok, Arctic/Longyearbyen, Asia/Aden, Asia/Almaty, Asia/Amman, Asia/Anadyr, Asia/Aqtai, Asia/Aqtobe, Asia/Ashgabat, Asia/Ashkhabad, Asia/Atyrau, Asia/Baghdad, Asia/Bahrain, Asia/Baku, Asia/Bangkok, Asia/Barnaul, Asia/Beirut, Asia/Bishkek, Asia/Brunei, Asia/Calcutta, Asia/Chita, Asia/Chobalsan, Asia/Chongqing, Asia/Chongking, Asia/Columbo, Asia/Dacca, Asia/Damascus, Asia/Dhaka, Asia/Dili, Asia/Dubai, Asia/Dushanbe, Asia/Famagusta, Asia/Gaza, Asia/Harbin, Asia/Hebron, Asia/Ho_Chi_Min, Asia/Hong_Kong, Asia/Hovd, Asia/Irkutsk, Asia/Istanbul, Asia/Jakarta, Asia/Jayapura, Asia/Jerusalem, Asia/Kabul, Asia/Kamchatka, Asia/Karachi, Asia/Kashgar, Asia/Kathmandu, Asia/Katmandu, Asia/Khandyga, Asia/Kolkata, Asia/Krasnoyarsk, Asia/Kuala_Lumpur, Asia/Kuching, Asia/Kuwait, Asia/Macao, Asia/Macau, Asia/Magadan, Asia/Makassar, Asia/Manila, Asia/Muscat, Asia/Nicosia, Asia/Novokuznetsk, Asia/Novosibirsk, Asia/Omsk, Asia/Oral, Asia/Phnom_Penh, Asia/Pontianak, Asia/Pyongyang, Asia/Qatar, Asia/Qostanay, Asia/Qyzylorda, Asia/Rangoon, Asia/Riyadh, Asia/Saigon, Asia/Sakhalin, Asia/Samarkand, Asia/Seoul, Asia/Shanghai, Asia/Singapore, Asia/Srednekolymysk, Asia/Taipei, Asia/Tashkent, Asia/Tbilisi, Asia/Tehran, Asia/Tel_Aviv, Asia/Thimbu, Asia/Thimphu, Asia/Tokyo, Asia/Tomsk, Asia/Ujung_Pandang, Asia/Ulaanbaatar, Asia/Ulan_Bator, Asia/Urumqi, Asia/Ust-Nera, Asia/Vientiane, Asia/Vladivostok, Asia/Yakutsk, Asia/Yangon, Asia/Yekaterinburg, Asia/Yerevan, Atlantic/Azores, Atlantic/Bermuda, Atlantic/Canary, Atlantic/Cape_Verde, Atlantic/Faeroe, Atlantic/Faroe, Atlantic/Jan_Mayen, Atlantic/Madeira, Atlantic/Reykjavik, Atlantic/South_Georgia, Atlantic/St_Helena, Atlantic/Stanley, Australia/ACT, Australia/Adelaide, Australia/Brisbane, Australia/Broken_Hill, Australia/Canberra, Australia/Currie, Australia/Darwin, Australia/Eucla, Australia/Hobart, Australia/LHI, Australia/Lindeman, Australia/Lord_Howe, Australia/Melbourne, Australia/NSW, Australia/North, Australia/Perth, Australia/Queensland, Australia/South, Australia/Sydney, Australia/Tasmania, Australia/Victoria, Australia/West, Australia/Yancowinna, Brazil/Acre, Brazil/DeNoronha, Brazil/East, Brazil/West, CET, CST6CDT, Canada/Atlantic, Canada/Central, Canada/Eastern, Canada/Mountain, Canada/Newfoundland, Canada/Pacific, Canada/Saskatchewan, Canada/Yukon, Chile/Continental, Chile/EasterIsland, Cuba, EET, EST, EST5EDT, Egypt, Eire, Etc/GMT, Etc/GMT+0, Etc/GMT+1, Etc/GMT+10, Etc/GMT+11, Etc/GMT+12, Etc/GMT+2, Etc/GMT+3, Etc/GMT+4, Etc/GMT+5, Etc/GMT+6, Etc/GMT+7, Etc/GMT+8, Etc/GMT+9, Etc/GMT-0, Etc/GMT-1, Etc/GMT-10, Etc/GMT-11, Etc/GMT-12, Etc/GMT-13, Etc/GMT-14, Etc/GMT-2, Etc/GMT-3, Etc/GMT-4, Etc/GMT-5, Etc/GMT-6, Etc/GMT-7, Etc/GMT-8, Etc/GMT-9, Etc/GMT0, Etc/

D15503.01

RoomOS
11.1

02-2023



Board

Board
ProCodec
EQCodec
PlusCodec
ProDesk,
Desk Pro,
Desk MiniRoom
Bar

Room Kit

Room Kit
Mini

Room 55

Room 55
Dual,
Room 70Room 70
G2Room 70
PanoramaRoom
Panorama

Greenwich, Etc/UCT, Etc/UTC, Etc/Universal, Etc/Zulu, Europe/Amsterdam, Europe/Andorra, Europe/Astrakhan, Europe/Athens, Europe/Belfast, Europe/Belgrade, Europe/Berlin, Europe/Bratislava, Europe/Brussels, Europe/Bucharest, Europe/Budapest, Europe/Busingen, Europe/Chisinau, Europe/Copenhagen, Europe/Dublin, Europe/Gibraltar, Europe/Guernsey, Europe/Helsinki, Europe/Isle_of_Man, Europe/Istanbul, Europe/Jersey, Europe/Kaliningrad, Europe/Kiev, Europe/Kirov, Europe/Kyiv, Europe/Lisbon, Europe/Ljubljana, Europe/London, Europe/Luxembourg, Europe/Madrid, Europe/Malta, Europe/Mariehamn, Europe/Minsk, Europe/Monaco, Europe/Moscow, Europe/Nicosia, Europe/Oslo, Europe/Paris, Europe/Podgorica, Europe/Prague, Europe/Riga, Europe/Rome, Europe/Samara, Europe/San_Marino, Europe/Sarajevo, Europe/Saratov, Europe/Simferopol, Europe/Skopje, Europe/Sofia, Europe/Stockholm, Europe/Tallinn, Europe/Tirane, Europe/Tiraspol, Europe/Ulyanovsk, Europe/Uzhgorod, Europe/Vaduz, Europe/Vatican, Europe/Vienna, Europe/Vilnius, Europe/Volgograd, Europe/Warsaw, Europe/Zagreb, Europe/Zaporozhye, Europe/Zurich, GB, GB-Eire, GMT, GMT+0, GMT-0, GMT0, Greenwich, HST, Hongkong, Iceland, Indian/Antananarivo, Indian/Chagos, Indian/Christmas, Indian/Cocos, Indian/Comoro, Indian/Kerguelen, Indian/Mahe, Indian/Maldives, Indian/Mauritius, Indian/Mayotte, Indian/Reunion, Iran, Israel, Jamaica, Japan, Kwajalein, Libya, MET, MST, MST7MDT, Mexico/BajaNorte, Mexico/BajaSur, Mexico/General, NZ, NZ-CHAT, Navajo, PRC, PST8PDT, Pacific/Apia, Pacific/Auckland, Pacific/Bougainville, Pacific/Chatham, Pacific/Chuuk, Pacific/Easter, Pacific/Efate, Pacific/Enderbury, Pacific/Fakaofu, Pacific/Fiji, Pacific/Funafuti, Pacific/Galapagos, Pacific/Gambier, Pacific/Guadalcanal, Pacific/Guam, Pacific/Honolulu, Pacific/Johnston, Pacific/Kanton, Pacific/Kiritimati, Pacific/Kosrae, Pacific/Kwajalein, Pacific/Majuro, Pacific/Marquesas, Pacific/Midway, Pacific/Nauru, Pacific/Niue, Pacific/Norfolk, Pacific/Noumea, Pacific/Pago_Pago, Pacific/Palau, Pacific/Pitcairn, Pacific/Pohnpei, Pacific/Ponape, Pacific/Port_Moresby, Pacific/Rarotonga, Pacific/Saipan, Pacific/Samoa, Pacific/Tahiti, Pacific/Tarawa, Pacific/Tongatapu, Pacific/Truk, Pacific/Wake, Pacific/Wallis, Pacific/Yap, Poland, Portugal, ROC, ROK, Singapore, Turkey, UCT, US/Alaska, US/Aleutian, US/Arizona, US/Central, US/East-Indiana, US/Eastern, US/Hawaii, US/Indiana-Starke, US/Michigan, US/Mountain, US/Pacific, US/Samoa, UTC, Universal, W-SU, WET, Zulu

Select a time zone from the list.

Time OfficeHours Enabled

Applies to: All products

Requires user role: ADMIN

Setting the office hours on a device will allow you to switch off always-on features like signage, outside of ordinary office hours. This prevents screens from being active all the time, and thereby increases their lifetime. Most screens are not certified for all day use, seven days a week.

Default value:

True

Value space:

False/True

False: The device isn't set up to support Office hours. Therefore, the other OfficeHours settings have no effect.

True: The device supports Office hours. The other OfficeHours settings define when office hours are, and device standby behavior outside of office hours.

Time OfficeHours OutsideOfficeHours Standby AutoWakeup

Applies to: All products

Requires user role: ADMIN

Set how the device responds when it detects motion in the room outside of office hours. Regardless of this setting, the device always wakes up when someone starts using it.

Default value:

Disabled

Value space:

Disabled/Enabled

Disabled: The device will stay in standby even if it detects motion.

Enabled: The device will wake up as usual when it detects motion.

Time OfficeHours OutsideOfficeHours Standby Delay

Applies to: All products

Requires user role: ADMIN

Specify how long the device stays in idle mode before entering display off mode, outside office hours.

Default value:

5

Value space:

Integer (1..30)

The number of minutes the device stays in idle mode before entering display off mode.

Board

Time OfficeHours WorkDay End

Applies to: All products

Requires user role: ADMIN, USER

Set the time when the ordinary office hours end.

Default value:

"19:00"

Value space:

String (5, 5)

The time of day in "hh:mm" format, where hh = two-digit hour, 00 through 23 (am/pm is not supported) and mm = two-digit minute, 00 through 59.

Board Pro

Codec EQ

Codec Plus

Codec Pro

Desk, Desk Pro, Desk Mini

Room Bar

Time OfficeHours WorkDay Start

Applies to: All products

Requires user role: ADMIN, USER

Set the time when the ordinary office hours start.

Default value:

"07:00"

Value space:

String (5, 5)

The time of day in "hh:mm" format, where hh = two-digit hour, 00 through 23 (am/pm is not supported) and mm = two-digit minute, 00 through 59.

Room Kit

Room Kit Mini

Room 55

Room 55 Dual, Room 70

Room 70 G2

Room 70 Panorama

Room Panorama

Time OfficeHours WorkWeek Monday

Applies to: All products

Requires user role: ADMIN

Set whether Monday is included in the working week.

Default value:

True

Value space:

False/True

False: Monday is not included in the working week.

True: Monday is included in the working week.

Time OfficeHours WorkWeek Tuesday

Applies to: All products

Requires user role: ADMIN

Set whether Tuesday is included in the working week.

Default value:

True

Value space:

False/True

False: Tuesday is not included in the working week.

True: Tuesday is included in the working week.

Time OfficeHours WorkWeek Wednesday

Applies to: All products

Requires user role: ADMIN

Set whether Wednesday is included in the working week.

Default value:

True

Value space:

False/True

False: Wednesday is not included in the working week.

True: Wednesday is included in the working week.

Time OfficeHours WorkWeek Thursday

Applies to: All products

Requires user role: ADMIN

Set whether Thursday is included in the working week.

Default value:

True

Value space:

False/True

False: Thursday is not included in the working week.

True: Thursday is included in the working week.

Board

Board
ProCodec
EQCodec
PlusCodec
ProDesk,
Desk Pro,
Desk MiniRoom
Bar

Room Kit

Room Kit
Mini

Room 55

Room 55
Dual,
Room 70Room 70
G2Room 70
PanoramaRoom
Panorama

Time OfficeHours WorkWeek Friday

Applies to: All products

Requires user role: ADMIN

Set whether Friday is included in the working week.

Default value:

True

Value space:

False/True

False: Friday is not included in the working week.

True: Friday is included in the working week.

Time OfficeHours WorkWeek Saturday

Applies to: All products

Requires user role: ADMIN

Set whether Saturday is included in the working week.

Default value:

False

Value space:

False/True

False: Saturday is not included in the working week.

True: Saturday is included in the working week.

Time OfficeHours WorkWeek Sunday

Applies to: All products

Requires user role: ADMIN

Set whether Sunday is included in the working week.

Default value:

False

Value space:

False/True

False: Sunday is not included in the working week.

True: Sunday is included in the working week.

UserInteraction settings

UserInteraction RaiseHand CMS

Applies to: All products

Requires user role: ADMIN, USER

This setting controls the availability of the raise hand feature for CMS meetings. If CMS supports the raise hand feature and this setting is set to True, then the raise hand button will be present on the user interface of the device.

Default value:

True

Value space:

False/True

False: The raise hand button will not be present.

True: The raise hand button will be present if CMS supports the feature.

Board

Board
ProCodec
EQCodec
PlusCodec
ProDesk,
Desk Pro,
Desk MiniRoom
Bar

Room Kit

Room Kit
Mini

Room 55

Room 55
Dual,
Room 70Room 70
G2Room 70
PanoramaRoom
Panorama

UserInterface settings

UserInterface Accessibility IncomingCallNotification

Applies to: All products

Requires user role: ADMIN, INTEGRATOR, USER

You can enable an incoming call notification with amplified visuals. The screen and touch controller will flash red/white approximately once every second (1.75 Hz) to make it easier for hearing impaired users to notice an incoming call. If the device is already in a call the screen will not flash as this will disturb the on-going call, instead you will get a normal notification on screen and touch panel.

The feature is not available for Board Pro and Desk Mini in this release.

Default value:

Default

Value space:

AmplifiedVisuals/Default

AmplifiedVisuals: Enable the amplified visuals on screen and touch panel when the device receives a call.

Default: Enable the default behavior with a notification on screen and touch panel.

UserInterface Assistant Mode

Applies to: All products

Requires user role: ADMIN

Webex Assistant allows you to control the device by using voice commands. Webex Assistant is a cloud service, so the device must either be registered to the Webex cloud service or registered to an on-premises service and linked to Webex Edge for Devices.

Use this setting to enable or disable the Webex Assistant on the device.

Default value:

On

Value space:

Off/On

Off: Webex Assistant is switched off.

On: Webex Assistant can be used if it is supported by the infrastructure.

UserInterface Assistant ProactiveMeetingJoin

Applies to: All products

Requires user role: ADMIN

Proactive Join is a feature that is offered by Webex Assistant. When Proactive Join is enabled and someone is discovered in the meeting room just before the start of an OBTP-meeting, the device will ask if they want to join the meeting that is about to start.

Use this setting to enable or disable the Proactive Join feature on the device.

Default value:

True

Value space:

False/True

False: The Proactive Join feature is switched off.

True: The Proactive Join feature can be used if Webex Assistant is active.

UserInterface Bookings Visibility TentativeMeetings

Applies to: All products

Requires user role: ADMIN, INTEGRATOR, USER

In general, the list of upcoming meetings is shown on the screen and touch controller. Set whether to include tentative meetings in the list.

Default value:

Auto

Value space:

Auto/Hidden

Auto: Tentative meetings are included in the list.

Hidden: Tentative meetings are not in the list.

Board

UserInterface Bookings Visibility Title

Applies to: All products

Requires user role: ADMIN, INTEGRATOR, USER

Sets the meeting details to private. "Scheduled meeting" will be displayed as the title of the meeting.

Default value:

Auto

Value space:

Auto/Hidden

Auto: The title of the meeting is public and will be displayed on the user interface.

Hidden: The title of the meeting will be hidden and "Scheduled meeting" will be displayed on the user interface.

Board Pro

Codec EQ

Codec Plus

Codec Pro

Desk, Desk Pro, Desk Mini

Room Bar

Room Kit

Room Kit Mini

Room 55

Room 55 Dual, Room 70

Room 70 G2

Room 70 Panorama

Room Panorama

UserInterface ContactInfo Type

Applies to: All products

Requires user role: ADMIN

Choose which type of contact information to show on the user interface.

Default value:

Auto

Value space:

Auto/DisplayName/E164Alias/H323Id/IPv4/IPv6/None/SipUri/SystemName

Auto: Show the address which another device should dial to reach this video conferencing device. The address depends on the default call protocol and device registration.

None: Do not show any contact information.

IPv4: Show the device's IPv4 address.

IPv6: Show the device's IPv6 address.

H323Id: Show the device's H.323 ID (refer to the H323 H323Alias ID setting).

E164Alias: Show the device's H.323 E164 Alias as contact information (refer to the H323 H323Alias E164 setting).

SipUri: Show the device's SIP URI (refer to the SIP URI setting).

SystemName: Show the device's name (refer to the SystemUnit Name setting).

DisplayName: Show the device's display name (refer to the SIP DisplayName setting).

UserInterface CustomMessage

Applies to: All products

Requires user role: ADMIN, INTEGRATOR

A custom message can be displayed, in the lower left side of the screen, in awake mode.

Default value:

""

Value space:

String (0, 256)

Add a custom message. Add an empty string to remove a custom message.

Board

UserInterface CustomWallpaperOverlay

Applies to: All products

Requires user role: ADMIN

When using a custom wallpaper you can choose to apply a transparent black overlay to soften the background image and give more focus to the UI elements.

Default value:

On

Value space:

Off/On

Off: Don't apply a transparent black overlay.

On: Apply a transparent black overlay.

Board
ProCodec
EQCodec
PlusCodec
ProDesk,
Desk Pro,
Desk MiniRoom
Bar

UserInterface Diagnostics Notifications

Applies to: All products

Requires user role: ADMIN

Hide or show diagnostics notifications on the user interface.

Default value:

Auto

Value space:

Auto/Hidden

Auto: The diagnostics notifications will be displayed on the user interface.

Hidden: The diagnostics notifications will not be displayed on the user interface.

Room Kit

Room Kit
Mini

Room 55

Room 55
Dual,
Room 70Room 70
G2Room 70
PanoramaRoom
Panorama

UserInterface Features Call End

Applies to: All products

Requires user role: ADMIN, INTEGRATOR

Choose whether or not to remove the default End Call button from the user interface. The setting removes only the button, not its functionality as such.

Default value:

Auto

Value space:

Auto/Hidden

Auto: Shows the button on the user interface.

Hidden: Removes the button from the user interface.

UserInterface Features Call HdmiPassthrough

Applies to: RoomKit CodecPlus CodecPro Room55 Room70/Room55D Room70G2

Requires user role: ADMIN, INTEGRATOR

Choose whether to show the Call from laptop button on the touch controller.

Refer to the Video Output HDMI Passthrough Allowed setting for more information about HDMI passthrough and the Call from laptop feature. Call from laptop is not supported on Room 55 Dual and Room 70 Dual.

Default value:

Auto

Value space:

Auto/Hidden

Auto: Show the button on the touch controller.

Hidden: Don't show the button on the touch controller.

UserInterface Features Call JoinGoogleMeet

Applies to: All products

Requires user role: ADMIN, INTEGRATOR

Choose to show or hide the Google Meet button on the user interface.

The button allows users to dial into Google Meet meetings using the meeting code generated by the Google invite.

This is only available on devices registered to the Webex cloud service or linked to Webex Edge for devices.

Default value:

Auto

Value space:

Auto/Hidden

Auto: Shows the button on the user interface.

Hidden: Removes the button from the user interface.

Board

UserInterface Features Call JoinZoom

Applies to: All products

Requires user role: ADMIN, INTEGRATOR

Choose to show or hide the Zoom button on the user interface.

The button allows users to dial into Zoom meetings using the meeting code generated by the Zoom invite.

Default value:

Hidden

Value space:

Auto/Hidden

Auto: Shows the button on the user interface.

Hidden: Removes the button from the user interface.

Board Pro

Codec EQ

Codec Plus

Codec Pro

Desk, Desk Pro, Desk Mini

Room Bar

Room Kit

Room Kit Mini

Room 55

Room 55 Dual, Room 70

Room 70 G2

Room 70 Panorama

Room Panorama

UserInterface Features Call Keypad

Applies to: All products

Requires user role: ADMIN, INTEGRATOR

Choose whether or not to remove the default in-call Keypad button from the user interface. This button opens a keypad, which for example can be used for DTMF input.

Default value:

Auto

Value space:

Auto/Hidden

Auto: Shows the button on the user interface.

Hidden: Removes the button from the user interface.

UserInterface Features Call LayoutControls

Applies to: All products

Requires user role: ADMIN, INTEGRATOR

Choose whether to show the Layout button, which by default is available in call, on the user interface.

Default value:

Auto

Value space:

Auto/Hidden

Auto: Show the button on the user interface.

Hidden: Don't show the button on the user interface.

UserInterface Features Call MidCallControls

Applies to: All products

Requires user role: ADMIN, INTEGRATOR

Choose to show or hide the default Hold, Transfer, and Resume in-call buttons on the user interface.

The setting removes only the buttons, not their functionality as such.

Default value:

Auto

Value space:

Auto/Hidden

Auto: Shows the buttons on the user interface.

Hidden: Removes the buttons from the user interface.

Board

UserInterface Features Call MusicMode

Applies to: All products

Requires user role: ADMIN, INTEGRATOR

Choose to show or hide the toggle button for Music Mode on the user interface.

Default value:

Hidden

Value space:

Auto/Hidden

Auto: Shows the toggle button for Music Mode on the user interface if this feature is supported in the ongoing call.

Hidden: The toggle button for Music Mode is never shown on the user interface.

Board Pro

Codec EQ

Codec Plus

Codec Pro

Desk, Desk Pro, Desk Mini

Room Bar

UserInterface Features Call ParticipantList

Applies to: All products

Requires user role: ADMIN, INTEGRATOR

Choose whether to show the Participants button, which by default is available in call, on the user interface.

Default value:

Auto

Value space:

Auto/Hidden

Auto: Show the button on the user interface.

Hidden: Don't show the button on the user interface.

Room Kit

Room Kit Mini

Room 55

Room 55 Dual, Room 70

Room 70 G2

Room 70 Panorama

Room Panorama

UserInterface Features Call SelfviewControls

Applies to: All products

Requires user role: ADMIN, INTEGRATOR

Choose whether to show the self-view controls on the user interface. This feature is not available for Room 70 Panorama and Room Panorama in this software version.

Default value:

Auto

Value space:

Auto/Hidden

Auto: Show the self-view controls on the user interface.

Hidden: Don't show the self-view controls on the user interface.

UserInterface Features Call Start

Applies to: All products

Requires user role: ADMIN, INTEGRATOR

Choose to show or hide the default Call button (including the directory, favorites, and recent calls lists) and the default in-call Add participant button on the user interface. The setting removes only the buttons, not their functionality as such.

Default value:

Auto

Value space:

Auto/Hidden

Auto: Shows the buttons on the user interface.

Hidden: Removes the buttons from the user interface.

UserInterface Features Call VideoMute

Applies to: All products

Requires user role: ADMIN, INTEGRATOR

Choose to show or hide the default "Turn video off" button on the user interface.

Default value:

Auto

Value space:

Auto/Hidden

Auto: Shows the "Turn video off" button on the user interface if this feature is supported in the ongoing call.

Hidden: The "Turn video off" button is never shown on the user interface.

UserInterface Features Call Webcam

Applies to: RoomKitMini RoomBar BoardPro

Requires user role: ADMIN, INTEGRATOR

Choose whether to show the Call from laptop button on the touch controller.

Default value:

Auto

Value space:

Auto/Hidden

Auto: Show the button on the touch controller.

Hidden: Don't show the button on the touch controller.

Board

UserInterface Features Files Start

Applies to: DeskMini Desk DeskPro Board BoardPro

Requires user role: ADMIN, INTEGRATOR

Choose whether or not to remove the default Files button from the user interface. The setting removes only the button, not its functionality as such. This setting applies only to devices that are registered to the Webex cloud service or linked to Webex Edge for Devices.

Default value:

Auto

Value space:

Auto/Hidden

Auto: Shows the button on the user interface.

Hidden: Removes the button from the user interface.

Codec
EQCodec
PlusCodec
ProDesk,
Desk Pro,
Desk MiniRoom
Bar

UserInterface Features HideAll

Applies to: All products

Requires user role: ADMIN, INTEGRATOR

Choose to hide all the buttons on the user interface. The setting removes only the buttons, not their functionality.

Default value:

False

Value space:

False/True

False: Shows all default buttons on the user interface.

True: Removes all default buttons from the user interface.

Room Kit

Room Kit
Mini

Room 55

Room 55
Dual,
Room 70Room 70
G2Room 70
PanoramaRoom
Panorama

UserInterface Features Share Start

Applies to: All products

Requires user role: ADMIN, INTEGRATOR

Choose whether or not to remove the default UI elements for sharing and previewing content, both in call and out of call, from the user interface. The setting removes only the buttons and UI elements, not their functionality as such. You can still share content using Cisco Proximity or Cisco Webex apps.

Default value:

Auto

Value space:

Auto/Hidden

Auto: Shows the buttons and UI elements on the user interface.

Hidden: Removes the buttons and UI elements from the user interface.

UserInterface Features Whiteboard Start

Applies to: DeskMini Desk DeskPro Board BoardPro

Requires user role: ADMIN, INTEGRATOR

Choose whether or not to remove the default Whiteboard button from the user interface. The setting removes only the button, not its functionality as such. This setting applies only to devices that are registered to the Webex cloud service or linked to Webex Edge for Devices.

Default value:

Auto

Value space:

Auto/Hidden

Auto: Shows the button on the user interface.

Hidden: Removes the button from the user interface.

Board

UserInterface Help Tips

Applies to: All products

Requires user role: ADMIN

Help tips can be accessed through the user interface. When enabled, a Tips button is present on the home screen.

This feature is not available for Room 70 Panorama and Room Panorama in this software version.

Default value:

Auto

Value space:

Auto/Hidden

Auto: Show the help tips button.

Hidden: Hide the help tips button.

Board Pro

Codec EQ

Codec Plus

Codec Pro

Desk, Desk Pro, Desk Mini

Room Bar

Room Kit

Room Kit Mini

Room 55

Room 55 Dual, Room 70

Room 70 G2

Room 70 Panorama

Room Panorama

UserInterface HomeScreen Peripherals WebApp URL

Applies to: All products

Requires user role: ADMIN

Set the URL of the web application you want to run on the Room Navigator (that is, a persistent web app). The application displays on the entire screen, and it can't be dismissed by the user.

If the app is going to interact with the device's API, remember to set Security Xapi WebSocket ApiKey Allowed: True, and add the domain name of the server hosting the app to the allow list in the WebEngine Features Xapi Peripherals AllowedHosts Hosts setting.

Note: Persistent web apps are only available on Room Navigators that are paired to the device over the network.

Default value:

""

Value space:

String (0, 2048)

The URL of the web application.

UserInterface KeyTones Mode

Applies to: All products

Requires user role: ADMIN, USER

You can configure the device to make a keyboard click sound effect (key tone) when typing text or numbers.

Default value:

Off [DeskMini Desk DeskPro Board BoardPro]

On [RoomKit RoomKitMini RoomBar CodecEQ CodecPlus CodecPro Room55 Room70/Room55D Room70G2 RoomPanorama/Room70Panorama]

Value space:

Off/On

Off: There is no key tone sound effect.

On: The key tone sound effect is turned on.

Board

UserInterface Kiosk Mode

Applies to: DeskMini Desk DeskPro Board BoardPro

Requires user role: ADMIN, INTEGRATOR

Kiosk mode lets you replace the home screen of the device with your own custom web application that you host and maintain yourself. The URL to the custom web application must be added in the UserInterface Kiosk URL setting. As an example, Kiosk mode can be used in reception areas where you want the device set up for visitor registration, providing the facility overview, or allow direct calls to expert services.

Kiosk mode is using the device's web engine, so the WebEngine Mode setting must be On for kiosk mode to work. To allow for making calls, the WebEngine Features SipUrlHandler setting must be On as well.

Default value:

Off

Value space:

Off/On

Off: The device operates in standard mode.

On: The device is set up in kiosk mode.

Board
ProCodec
EQCodec
PlusCodec
ProDesk,
Desk Pro,
Desk MiniRoom
Bar

Room Kit

Room Kit
Mini

Room 55

Room 55
Dual,
Room 70Room 70
G2Room 70
PanoramaRoom
Panorama

UserInterface Language

Applies to: All products

Requires user role: ADMIN, USER

Select the language to be used on the user interface. If the language is not supported, the default language (English) will be used.

Default value:

English

Value space:

Arabic/Catalan/ChineseSimplified/ChineseTraditional/Czech/Danish/Dutch/English/EnglishUK/Finnish/French/FrenchCanadian/German/Hebrew/Hungarian/Italian/Japanese/Korean/Norwegian/Polish/Portuguese/PortugueseBrazilian/Russian/Spanish/SpanishLatin/Swedish/Turkish/Ukrainian

Select a language from the list.

UserInterface LedControl Mode

Applies to: All products

Requires user role: ADMIN

The wall mount version of the Room Navigator has LED lights. You can configure how they should be controlled.

Default value:

Auto

Value space:

Auto/Manual/Off

Auto: The video conferencing device controls the LED lights automatically, typically based on the room booking status (for example, green: room available, red: room in use). The UserInterface LedControl Color Set Color command will have no effect.

Manual: You can control the LED lights and set the color using the UserInterface LedControl Color Set Color command.

Off: The LED lights are turned off permanently.

Board

UserInterface MuteWarning

Applies to: All products

Requires user role: ADMIN

Choose whether to show a warning on screen if you start talking while your microphone is muted.

Default value:

Enabled

Value space:

Disabled/Enabled

Disabled: Don't show the mute warning.

Enabled: Show the mute warning.

Board Pro

Codec EQ

Codec Plus

Codec Pro

Desk, Desk Pro, Desk Mini

Room Bar

UserInterface NameAndSiteLabels Mode

Applies to: All products

Requires user role: ADMIN

You can configure a device to hide all name and site labels for remote participants in a meeting.

Default value:

Auto

Value space:

Auto/Hidden

Auto: Show name and site labels.

Hidden: Hide name and site labels.

Room Kit

Room Kit Mini

Room 55

Room 55 Dual, Room 70

Room 70 G2

Room 70 Panorama

Room Panorama

UserInterface OSD EncryptionIndicator

Applies to: All products

Requires user role: ADMIN

Define for how long the encryption indicator is shown on screen. The icon for encrypted calls is a locked padlock.

Default value:

Auto

Value space:

Auto/AlwaysOn/AlwaysOff

Auto: If the call is encrypted, a "Call is encrypted" notification is shown for 5 seconds. Then, an encryption indicator icon is shown for the rest of the call.

If the call is not encrypted, a "Call is not encrypted" notification is shown for 5 seconds. No encryption indicator icon is shown.

AlwaysOn: The "Call is encrypted" notification is shown for 5 seconds. Then, an encryption indicator icon is shown for the rest of the call.

AlwaysOff: The encryption indicator is never displayed on screen.

UserInterface OSD HalfwakeMessage

Applies to: RoomKit RoomKitMini RoomBar CodecEQ CodecPlus CodecPro Room55 Room70/Room55D Room70G2 RoomPanorama/Room70Panorama DeskMini Desk DeskPro BoardPro

Requires user role: ADMIN, INTEGRATOR

A custom message can be displayed in the middle of the main screen when the device is in the halfwake state. The custom message will replace the default message, which gives instructions how to start using the device. You can also delete the default message, without adding a custom message.

Default value:

""

Value space:

String (0, 128)

The custom message. An empty string: Restore the default message. A space only: There will be no message at all.

Board

Board
ProCodec
EQCodec
PlusCodec
ProDesk,
Desk Pro,
Desk MiniRoom
Bar

Room Kit

Room Kit
Mini

Room 55

Room 55
Dual,
Room 70Room 70
G2Room 70
PanoramaRoom
Panorama

UserInterface OSD Mode

Applies to: All products

Requires user role: ADMIN

You can configure a device to output a clean video stream. This is referred to as broadcast mode. In this mode the indicators, notifications, and controls are removed. This mode is primarily for broadcasting and recording services where you only want to pass on the video to your viewers.

Default value:

Auto

Value space:

Auto/Unobstructed

Auto: Indicators, notifications, and controls are included in the video stream (normal mode).

Unobstructed: Indicators, notifications, and controls are removed from the video stream (broadcast mode). Name labels are not removed.

UserInterface OSD Output

Applies to: All products

Requires user role: ADMIN, INTEGRATOR

Specify the monitor to use for displaying on-screen information and indicators. This is the On-Screen Display (OSD).

Default value:

1 [Room55 DeskMini Desk DeskPro Board]

Auto [RoomKit RoomKitMini RoomBar CodecEQ CodecPlus CodecPro Room70/Room55D Room70G2 RoomPanorama/Room70Panorama BoardPro]

Value space:

1 [Room55 DeskMini Desk DeskPro Board]

Auto/1/2 [RoomKit RoomBar CodecPlus Room70/Room55D]

Auto/1/2/3 [CodecEQ CodecPro Room70G2 RoomPanorama/Room70Panorama BoardPro]

Auto [RoomKitMini]

Auto: For devices with integrated screen, the on-screen information and indicators are sent to the integrated screen. If the device has two integrated screens, the left screen is used.

For devices without integrated screens, the device detects when a screen is connected to a video output, and sends the on-screen information and indicators to the first screen you connect. If you have a multi-screen setup, and all screens are connected before switching on the device, the on-screen information and indicators are sent to the video output with the lowest number, starting with Output Connector 1 (HDMI 1).

1..n: The device sends the on-screen information and indicators to the specified output. Choose n to send the on-screen information and indicators to the device's Output Connector n.

For devices with integrated screens, the lowest numbers refer to the integrated screens.

Board

UserInterface Phonebook DefaultSearchFilter

Applies to: All products

Requires user role: ADMIN, INTEGRATOR

When searching for a name in the directory, you can search through everything or filter to include only people or only rooms. This is only available on devices registered to the Webex cloud service or linked to Webex Edge for devices.

Default value:

All

Value space:

All/People/Rooms

All: Search results include both people and rooms.

People: Search results include only people.

Rooms: Search results include only rooms.

Board Pro

Codec EQ

Codec Plus

Codec Pro

Desk, Desk Pro, Desk Mini

Room Bar

Room Kit

Room Kit Mini

Room 55

Room 55 Dual, Room 70

Room 70 G2

Room 70 Panorama

Room Panorama

UserInterface Proximity Notifications

Applies to: All products

Requires user role: ADMIN, INTEGRATOR

Configure the display of proximity notifications on the user interface.

Default value:

Auto

Value space:

Auto/Off/On

Auto: Allow the system to automatically determine when to display proximity notifications.

Off: Proximity notifications will not be shown on the user interface.

On: All proximity notifications will be shown on the user interface.

UserInterface RoomScheduler AmbientTemperature Show

Applies to: All products

Requires user role: ADMIN

This setting applies when a Room Navigator is set up as a room booking device (also referred to as scheduler mode). The Room Navigator may show the room temperature, if that is available from the device it's connected to. Use this setting to decide whether to display it.

Default value:

Auto

Value space:

Auto/Hidden/ShowCelsius/ShowFahrenheit

Auto: Show the temperature in both degrees Celsius and Fahrenheit.

Hidden: Don't show the temperature.

ShowCelsius: Show the temperature in degrees Celsius

ShowFahrenheit: Show the temperature in degrees Fahrenheit.

Board

UserInterface RoomScheduler PeopleCount Current

Applies to: All products

Requires user role: ADMIN

This setting applies when a Room Navigator is set up as a room booking device (also referred to as scheduler mode). The Room Navigator may show the number of people currently in the meeting room, if that information is available from the device it's connected to. Use this setting to decide whether to display this information.

Default value:

Auto

Value space:

Auto/Hidden

Auto: Show the number of people.

Hidden: Don't show the number of people.

Board
ProCodec
EQCodec
PlusCodec
ProDesk,
Desk Pro,
Desk MiniRoom
Bar

Room Kit

Room Kit
Mini

Room 55

Room 55
Dual,
Room 70Room 70
G2Room 70
PanoramaRoom
Panorama

UserInterface Security Mode

Applies to: All products

Requires user role: ADMIN

This setting allows you to hide the device information (for example, contact information, IP addresses, MAC address, serial number, and software version) from the top left dropdown on the touch screen. However, this does not hide the details from the Settings menu, but that can be achieved by additionally setting the UserInterface SettingsMenu Mode to Locked. You must also ensure that all user accounts with administrator rights have a passphrase.

To hide the entire Settings panel, set the UserInterface SettingsMenu Visibility to Hidden.

Default value:

Normal

Value space:

Normal/Strong

Normal: IP addresses and other device information are shown on the dropdown menu.

Strong: Contact information and IP addresses are not displayed on the dropdown menu.

UserInterface SettingsMenu Mode

Applies to: All products

Requires user role: ADMIN

The Settings panel on the user interface (touch controller or on-screen) can be protected by the device's admin password. If this password is blank, anyone can access the settings in the Settings panel and have access to the Factory Reset option. If authentication is enabled, all settings that require authentication have a padlock icon.

You can further lock down the Settings panel by setting the UserInterface Security Mode to Strong in addition. This will lock the "About this device" menu.

Default value:

Unlocked

Value space:

Locked/Unlocked

Locked: Authentication with administrator's username and passphrase is required.

Unlocked: No authentication is required.

Board

UserInterface SettingsMenu Visibility

Applies to: All products

Requires user role: ADMIN

This setting allows you to hide the drop down menu and Settings panel on the user interface.

Default value:

Auto

Value space:

Auto/Hidden

Auto: Allow users to view the Settings panel.

Hidden: Do not allow users to view the Settings panel.

Board
ProCodec
EQCodec
PlusCodec
ProDesk,
Desk Pro,
Desk MiniRoom
Bar

Room Kit

Room Kit
Mini

Room 55

Room 55
Dual,
Room 70Room 70
G2Room 70
PanoramaRoom
Panorama

UserInterface SoundEffects Mode

Applies to: All products

Requires user role: ADMIN, USER

You can configure the device to make a sound effect, for example, when someone connects a laptop or mobile through Proximity.

The keyboard click sound effect when typing text is not affected by this setting (refer to the UserInterface Keytones Mode setting).

Default value:

On

Value space:

Off/On

Off: There are no sound effects.

On: The sound effects are switched on.

UserInterface Theme Name

Applies to: All products

Requires user role: ADMIN, USER

Change the theme on the user interface.

Note, this config may change or be replaced in the future.

Default value:

Auto

Value space:

Auto/Light/Night

Auto: Use the default settings, letting the system decide what is best.

Light: Use the "Light" background theme.

Night: Use the "Night" background theme.

UserInterface Wallpaper

Applies to: All products

Requires user role: ADMIN, INTEGRATOR, USER

Select a background image (wallpaper) for the video screen when idle.

You may upload a custom wallpaper to the device using the web interface.

The following file formats are supported: JPEG, PNG.

The maximum file size is 4 MByte.

Default value:

Auto

Value space:

Auto/Custom/None

Auto: Use the default wallpaper.

None: There is no background image on the screen.

Custom: Use the custom wallpaper as background image on the screen.

If no custom wallpaper is uploaded to the device, the setting will revert to the default value.

UserInterface UsbPromotion

Applies to: RoomKitMini RoomBar

Requires user role: ADMIN

Choose whether or not to show on the halfwake screen, a text that informs you that you can use the device as a USB camera.

Default value:

Off

Value space:

Off/On

Off: The USB camera information text is not shown.

On: The USB camera information text is shown.

UserInterface WebcamOnlyMode

Applies to: RoomKitMini

Requires user role: ADMIN

Not applicable in this software version.

Board

UserInterface Whiteboard ActivityIndicators

Applies to: All products

Requires user role: ADMIN

Activity indicators let you see who is drawing and annotating in a call.

The avatars of the participants or the initials of the device are displayed when someone is interacting with the whiteboard, so you can follow who is drawing or annotating.

Applies only to cloud-registered devices.

Default value:

On

Value space:

Off/On

On: Enables activity indicators.

Off: Disables activity indicators.

Codec
EQCodec
PlusCodec
ProDesk,
Desk Pro,
Desk MiniRoom
Bar

Room Kit

Room Kit
Mini

Room 55

Room 55
Dual,
Room 70Room 70
G2Room 70
PanoramaRoom
Panorama

UserInterface Whiteboard DefaultTheme

Applies to: RoomKit RoomKitMini RoomBar CodecEQ CodecPlus CodecPro Room55 Room70/Room55D Room70G2 RoomPanorama/Room70Panorama DeskMini Desk DeskPro Board BoardPro

Requires user role: ADMIN

Change the whiteboard default theme to be black or white.

Default value:

Light

Value space:

Dark/Light

Dark: The default appearance of the whiteboard is black. It is also black when someone shares a whiteboard with you.

Light: The default appearance of the whiteboard is white. It is also white when someone shares a whiteboard with you.

UserManagement settings

UserManagement LDAP Admin Filter

Applies to: All products

Requires user role: ADMIN

The LDAP filter is used to determine which users should be granted administrator privileges.

You always have to set either an LDAP Admin Group or an LDAP Admin Filter. An LDAP Admin Filter takes precedence, so if the UserManagement LDAP Admin Filter is set, the UserManagement LDAP Admin Group setting is ignored.

Default value:

""

Value space:

String (0, 1024)

Refer to the LDAP specification for the syntax of this string. Example:

```
"(|(memberof=CN=admin group, OU=company groups, DC=company, DC=com)(sAMAccountName=username))"
```

UserManagement LDAP Admin Group

Applies to: All products

Requires user role: ADMIN

Members of this AD (Active Directory) group will be given administrator access. This setting is a shorthand for saying (memberOf:1.2.840.113556.1.4.1941:=<group name>).

You always have to set either an LDAP Admin Group or an LDAP Admin Filter. An LDAP Admin Filter takes precedence, so if the UserManagement LDAP Admin Filter is set, the UserManagement LDAP Admin Group setting is ignored.

Default value:

""

Value space:

String (0, 255)

The distinguished name of the AD group. Example: "CN=admin group, OU=company groups, DC=company, DC=com"

Board

UserManagement LDAP Attribute

Applies to: All products

Requires user role: ADMIN

The attribute used to map to the provided username. If not set, sAMAccountName is used.

Default value:

""

Value space:

String (0, 255)

The attribute name.

Board
ProCodec
EQCodec
PlusCodec
ProDesk,
Desk Pro,
Desk MiniRoom
Bar

Room Kit

Room Kit
Mini

Room 55

Room 55
Dual,
Room 70Room 70
G2Room 70
PanoramaRoom
Panorama

UserManagement LDAP MinimumTLSVersion

Applies to: All products

Requires user role: ADMIN

Set the lowest version of the TLS (Transport Layer Security) protocol that is allowed for LDAP.

Default value:

TLSv1.2

Value space:

TLSv1.0/TLSv1.1/TLSv1.2

TLSv1.0: Support TLS version 1.0 or higher.

TLSv1.1: Support TLS version 1.1 or higher.

TLSv1.2: Support TLS version 1.2 or higher.

UserManagement LDAP BaseDN

Applies to: All products

Requires user role: ADMIN

The distinguishing name of the entry at which to start a search (base).

Default value:

""

Value space:

String (0, 255)

The distinguishing name of the base. Example: "DC=company, DC=com"

UserManagement LDAP Encryption

Applies to: All products

Requires user role: ADMIN

Define how to secure the communication between the device and the LDAP server. You can override the port number by using the UserManagement LDAP Server Port setting.

Default value:

LDAPS

Value space:

LDAPS/None/STARTTLS

LDAPS: Connect to the LDAP server on port 636 over TLS (Transport Layer Security).

None: Connect to the LDAP server on port 389 with no encryption.

STARTTLS: Connect to the LDAP server on port 389, then send a STARTTLS command to upgrade to an encrypted connection (TLS).

Board

Board
ProCodec
EQCodec
PlusCodec
ProDesk,
Desk Pro,
Desk MiniRoom
Bar

Room Kit

Room Kit
Mini

Room 55

Room 55
Dual,
Room 70Room 70
G2Room 70
PanoramaRoom
Panorama

UserManagement LDAP Mode

Applies to: All products

Requires user role: ADMIN

The device supports the use of an LDAP (Lightweight Directory Access Protocol) server as a central place to store and validate usernames and passwords. Use this setting to configure whether or not to use LDAP authentication. Our implementation is tested for the Microsoft Active Directory (AD) service.

If you switch on LDAP Mode, make sure to configure the other UserManagement LDAP settings to suit your setup. Here is a few examples.

Example 1:

- UserManagement LDAP Mode: On
- UserManagement LDAP Address: "192.0.2.20"
- UserManagement LDAP BaseDN: "DC=company, DC=com"
- UserManagement LDAP Admin Group: "CN=admin group, OU=company groups, DC=company, DC=com"

Example 2:

- UserManagement LDAP Mode: On
- UserManagement LDAP Address: "192.0.2.20"
- UserManagement LDAP BaseDN: "DC=company, DC=com"
- UserManagement LDAP Admin Filter: "((memberof=CN=admin group, OU=company groups, DC=company, DC=com)(sAMAccountName=username))"

Default value:

Off

Value space:

Off/On

Off: LDAP authentication is not allowed.

On: LDAP authentication is allowed.

UserManagement LDAP Server Address

Applies to: All products

Requires user role: ADMIN

Set the IP address or hostname of the LDAP server.

Default value:

""

Value space:

String (0, 255)

A valid IPv4 address, IPv6 address or hostname.

UserManagement LDAP Server Port

Applies to: All products

Requires user role: ADMIN

Set the port to connect to the LDAP server on. If set to 0, use the default for the selected protocol (see the UserManagement LDAP Encryption setting).

Default value:

0

Value space:

Integer (0..65535)

The LDAP server port number.

UserManagement LDAP VerifyServerCertificate

Applies to: All products

Requires user role: ADMIN

When the device connects to an LDAP server, the server will identify itself to the device by presenting its certificate. Use this setting to determine whether or not the device will verify the server certificate.

Default value:

On

Value space:

Off/On

Off: The device will not verify the LDAP server's certificate.

On: The device must verify that the LDAP server's certificate is signed by a trusted Certificate Authority (CA). The CA must be on the list of trusted CAs that are uploaded to the device in advance. Use the device's web interface to manage the list of trusted CAs (see more details in the administrator guide).

Board

UserManagement PasswordPolicy Complexity MinimumDigits

Applies to: All products

Requires user role: ADMIN

When signing in to the device as a local user, the password must follow the rules set by the UserManagement PasswordPolicy settings. These settings replace the “systemtools securitysetting” command that was available in software versions older than CE9.10.

A new password rule will not apply to existing passwords but will take effect on the next password change.

This setting specifies the minimum number of numerical characters (0..9) in the password.

Default value:

0

Value space:

Integer (0..4)

The minimum number of numerical characters. 0 means no restrictions.

Board Pro

Codec EQ

Codec Plus

Codec Pro

Desk, Desk Pro, Desk Mini

Room Bar

Room Kit

Room Kit Mini

Room 55

Room 55 Dual, Room 70

Room 70 G2

Room 70 Panorama

Room Panorama

UserManagement PasswordPolicy Complexity MinimumLowercase

Applies to: All products

Requires user role: ADMIN

When signing in to the device as a local user, the password must follow the rules set by the UserManagement PasswordPolicy settings. These settings replace the “systemtools securitysetting” command that was available in software versions older than CE9.10.

A new password rule will not apply to existing passwords but will take effect on the next password change.

This setting specifies the minimum number of lower-case letters in the password.

Default value:

0

Value space:

Integer (0..4)

The minimum number of lower-case characters. 0 means no restrictions.

UserManagement PasswordPolicy Complexity MinimumSpecial

Applies to: All products

Requires user role: ADMIN

When signing in to the device as a local user, the password must follow the rules set by the UserManagement PasswordPolicy settings. These settings replace the “systemtools securitysetting” command that was available in software versions older than CE9.10.

A new password rule will not apply to existing passwords but will take effect on the next password change.

This setting specifies the minimum number of special characters in the password.

Default value:

0

Value space:

Integer (0..4)

The minimum number of special characters. 0 means no restrictions.

Board

UserManagement PasswordPolicy Complexity MinimumUppercase

Applies to: All products

Requires user role: ADMIN

When signing in to the device as a local user, the password must follow the rules set by the UserManagement PasswordPolicy settings. These settings replace the “systemtools securitysetting” command that was available in software versions older than CE9.10.

A new password rule will not apply to existing passwords but will take effect on the next password change.

This setting specifies the minimum number of upper-case letters in the password.

Default value:

0

Value space:

Integer (0..4)

The minimum number of upper-case characters. 0 means no restrictions.

Board Pro

Codec EQ

Codec Plus

Codec Pro

Desk, Desk Pro, Desk Mini

Room Bar

Room Kit

Room Kit Mini

Room 55

Room 55 Dual, Room 70

Room 70 G2

Room 70 Panorama

Room Panorama

UserManagement PasswordPolicy ReuseLimit

Applies to: All products

Requires user role: ADMIN

When signing in to the device as a local user, the password must follow the rules set by the UserManagement PasswordPolicy settings. These settings replace the “systemtools securitysetting” command that was available in software versions older than CE9.10.

A new password rule will not apply to existing passwords but will take effect on the next password change.

This setting specifies the reuse limit (n), which means that a user cannot change to either of their previous n passwords.

Default value:

12

Value space:

Integer (0..24)

The minimum number of passwords. 0 means no restrictions.

UserManagement PasswordPolicy MaxLifetime

Applies to: All products

Requires user role: ADMIN

When signing in to the device as a local user, the password must follow the rules set by the UserManagement PasswordPolicy settings. These settings replace the “systemtools securitysetting” command that was available in software versions older than CE9.10.

A new password rule will not apply to existing passwords but will take effect on the next password change.

This setting specifies the maximum number of days before a password becomes invalid.

Default value:

0

Value space:

Integer (0..7300)

The minimum number of days. 0 means no restrictions.

Board

Board
ProCodec
EQCodec
PlusCodec
ProDesk,
Desk Pro,
Desk MiniRoom
Bar

Room Kit

Room Kit
Mini

Room 55

Room 55
Dual,
Room 70Room 70
G2Room 70
PanoramaRoom
Panorama

Video settings

Video ActiveSpeaker DefaultPIPPosition

Applies to: All products

Requires user role: ADMIN, INTEGRATOR

Define the position on screen of the active speaker picture-in-picture (PiP). The setting only takes effect when using a video layout where the active speaker is a PiP, that is, the Overlay layout or possibly a Custom layout (refer to the Video DefaultLayoutFamily Local setting). The setting takes effect from the next call onwards; if changed during a call, it will have no effect on the current call.

Default value:

Current

Value space:

Current/UpperLeft/UpperCenter/UpperRight/CenterLeft/CenterRight/LowerLeft/
LowerRight

Current: The position of the active speaker PiP will be kept unchanged when leaving a call.

UpperLeft: The active speaker PiP will appear in the upper left corner of the screen.

UpperCenter: The active speaker PiP will appear in the upper center position.

UpperRight: The active speaker PiP will appear in the upper right corner of the screen.

CenterLeft: The active speaker PiP will appear in the center left position.

CentreRight: The active speaker PiP will appear in the center right position.

LowerLeft: The active speaker PiP will appear in the lower left corner of the screen.

LowerRight: The active speaker PiP will appear in the lower right corner of the screen.

Video DefaultLayoutFamily Local

Applies to: All products

Requires user role: ADMIN

Select which video layout family to use locally.

Default value:

Auto

Value space:

Auto/Equal/Overlay/Prominent/Prominent_L/Single

Auto: The default layout family, as given in the layout database provided by the device, will be used as the local layout.

Equal: The Grid layout family will be used as the local layout. Participants are shown in a grid of equal sized videos. If there is shared content it will appear beside the grid.

Overlay: The Overlay layout family will be used as the local layout. The active speaker will be shown in full screen, with the other participants in thumbnails overlaid across the bottom. If there is content it will appear in full screen with the active speaker in a thumbnail overlaid at the top. Transitions between active speakers are voice switched.

Prominent: The Stack layout family will be used as the local layout. The active speaker, or shared content, will be a large picture, while the other participants will be small pictures across the top. Transitions between active speakers are voice switched.

Prominent_L: The Prominent layout family will be used as the local layout. The active speaker is shown in the upper left part of the screen, and other participants are ranged across the bottom and beside on the right.

Single: The Focus layout family will be used as the local layout. The active speaker, or the presentation if present, will be shown in full screen. The other participants are not shown. Transitions between active speakers are voice switched.

Board

Video DefaultLayoutFamily LocalContent

Applies to: All products

Requires user role: ADMIN

Select which video layout family to switch to by default locally, when content sharing starts.

Default value:

Auto

Value space:

Auto/Equal/Overlay/Prominent/Prominent_L/Single

Auto: The default layout family, as given in the layout database provided by the device, will be used as the local layout.

Equal: The Grid layout family will be used as the local layout. Participants are shown in a grid of equal sized videos. Shared content will appear beside the grid.

Overlay: The Overlay layout family will be used as the local layout. Shared content will appear in full screen with the active speaker in a thumbnail overlaid at the top.

Prominent: The Stack layout family will be used as the local layout. The shared content will be a large picture, and participants will be small pictures across the top.

Prominent_L: The Prominent layout family will be used as the local layout. Content is shown in the upper left part of the screen, and participants are ranged across the bottom and beside on the right.

Single: The Focus layout family will be used as the local layout. The shared content will be shown in full screen. Participants are not shown.

Board Pro

Codec EQ

Codec Plus

Codec Pro

Desk, Desk Pro, Desk Mini

Room Bar

Room Kit

Room Kit Mini

Room 55

Room 55 Dual, Room 70

Room 70 G2

Room 70 Panorama

Room Panorama

Video DefaultLayoutFamily Remote

Applies to: All products

Requires user role: ADMIN

Select which video layout family to be used in the stream that is sent to the remote participants (far end). This setting applies only when using a device's built-in MultiSite feature (optional) to host a multipoint video conference.

Default value:

Auto

Value space:

Auto/Equal/Prominent/Prominent_L/Overlay/Single

Auto: The default layout family, as given in the layout database provided by the device, will be used as the local layout.

Equal: The Grid layout family will be used as the local layout. Participants are shown in a grid of equal sized videos. If there is shared content it will appear beside the grid.

Overlay: The Overlay layout family will be used as the local layout. The active speaker will be shown in full screen, with the other participants in thumbnails overlaid across the bottom. If there is content it will appear in full screen with the active speaker in a thumbnail overlaid at the top. Transitions between active speakers are voice switched.

Prominent: The Stack layout family will be used as the local layout. The active speaker, or shared content, will be a large picture, while the other participants will be small pictures across the top. Transitions between active speakers are voice switched.

Prominent_L: The Prominent layout family will be used as the local layout. The active speaker is shown in the upper left part of the screen, and other participants are ranged across the bottom and beside on the right.

Single: The Focus layout family will be used as the local layout. The active speaker, or the presentation if present, will be shown in full screen. The other participants are not shown. Transitions between active speakers are voice switched.

Board

Video DefaultMainSource

Applies to: All products

Requires user role: ADMIN, USER

Define the default input source for main video in calls. The main video is played on this source when you switch on or restart the video conferencing device. Use the Video Input SetMainVideoSource command to change to another source while the device is running.

Default value:

1

Value space:

1/2/3/4/5/6 [*CodecPro Room70G2 RoomPanorama/Room70Panorama*]

1/2/3/4 [*CodecEQ*]

1/2/3 [*RoomKit RoomBar CodecPlus Room55 Room70/Room55D DeskMini Desk DeskPro BoardPro*]

1/2 [*RoomKit RoomKitMini DeskMini Board*]

The default source for main video.

Board Pro

Codec EQ

Codec Plus

Codec Pro

Desk, Desk Pro, Desk Mini

Room Bar

Room Kit

Room Kit Mini

Room 55

Room 55 Dual, Room 70

Room 70 G2

Room 70 Panorama

Room Panorama

Video Input AirPlay DiscoveryInstructions NetworkName

Applies to: All products

Requires user role: ADMIN

Insert the name of the network that the Apple device must connect to. If not set, the Video Input AirPlay DiscoveryInstructions ShowNetworkInfo setting will display the name defined in the network itself.

Default value:

""

Value space:

String (0, 32)

The name of the network.

Video Input AirPlay DiscoveryInstructions ShowNetworkInfo

Applies to: All products

Requires user role: ADMIN

Decide whether to show the name of the network that the Apple device must connect to on the AirPlay information screen (Curtain) on the video device. The network name is either defined in the network itself, or explicitly set in the Video Input AirPlay DiscoveryInstructions NetworkName setting. The latter take precedence.

Default value:

False

Value space:

False/True

False: Don't display the network name on the AirPlay information screen.

True: Display the network name on the AirPlay information screen.

Board

Video Input AirPlay Mode

Applies to: All products

Requires user role: ADMIN

All devices, except the first generation of Board (non S-series), support AirPlay. With AirPlay users can wirelessly connect their iPhone, iPad, or Mac to share their screen, collaborate, and playback audio and video content.

Use this setting to activate AirPlay on a device.

Once activated, users can disable and re-enable AirPlay themselves from the device's Settings menu if using a personal mode device. This is not possible for shared devices.

Default value:

Off

Value space:

Board, non S-series: Off Other devices: Off/On

On: AirPlay is activated on the device.

Off: AirPlay is deactivated on the device.

Board Pro

Codec EQ

Codec Plus

Codec Pro

Desk, Desk Pro, Desk Mini

Room Bar

Room Kit

Room Kit Mini

Room 55

Room 55 Dual, Room 70

Room 70 G2

Room 70 Panorama

Room Panorama

Video Input AirPlay Password

Applies to: All products

Requires user role: ADMIN

Define the password that must be used for AirPlay pairing when the Video Input AirPlay Security setting is set to Password.

Default value:

""

Value space:

String (0, 63)

The AirPlay pairing password.

Video Input AirPlay SecurityMode

Applies to: All products

Requires user role: ADMIN

Define the type of authentication to use when pairing an iPhone, iPad, or Mac to the device (AirPlay pairing).

Default value:

Shared mode devices: PinAlways Personal mode devices: PinFirstTime

Value space:

Password/PinAlways/PinFirstTime

Password: The device will require a password for AirPlay pairing. You must define the password in the Video Input AirPlay Password setting. If you don't define a password, the device will revert to default and request a PIN.

PinAlways: The device will request a PIN at every AirPlay pairing (except if reconnecting within 30 seconds after disconnecting).

PinFirstTime: The device will request a PIN at the first AirPlay pairing. After the first time, the successfully paired device will be remembered.

Video Input Connector [n] CameraControl Camerald

Applies to: All products

Requires user role: ADMIN, INTEGRATOR

The camera ID is a unique identifier of the camera that is connected to this video input.

For devices with more than one camera, you can see the currently assigned IDs in the Cameras Camera status.

Default value:

Connector n: n [*CodecEQ CodecPlus CodecPro Room70/Room55D Room70G2 RoomPanorama/Room70Panorama*]

Connector 1: 1 Connector 2: 3 Connector 3: 2 [*BoardPro*]

1 [*RoomKit RoomKitMini RoomBar Room55 DeskMini Desk DeskPro Board*]

Value space:

1/2/3/4/5/6/7 [*CodecEQ CodecPlus CodecPro Room70/Room55D Room70G2 RoomPanorama/Room70Panorama BoardPro*]

1 [*RoomKit RoomKitMini RoomBar Room55 DeskMini Desk DeskPro Board*]

For devices with more than one camera, set an ID of the camera. For devices with one camera the value is fixed and cannot be changed.

n: Unique ID that identifies the video input connector.

Range: 1..2 [*RoomKit RoomKitMini DeskMini Board*]

Range: 1..3 [*RoomBar CodecPlus Room55 Room70/Room55D Desk DeskPro BoardPro*]

Range: 1..4 [*CodecEQ*]

Range: 1..6 [*CodecPro Room70G2 RoomPanorama/Room70Panorama*]

Board

Board
ProCodec
EQCodec
PlusCodec
ProDesk,
Desk Pro,
Desk MiniRoom
Bar

Room Kit

Room Kit
Mini

Room 55

Room 55
Dual,
Room 70Room 70
G2Room 70
PanoramaRoom
Panorama

Video Input Connector [n] CameraControl Mode

Applies to: All products

Requires user role: ADMIN, INTEGRATOR

Define whether the camera on this video input connector can be controlled or not. Some connectors cannot be controlled (Off is the only available value).

Default value:

On [*CodecPlus Room70/Room55D*]

Connector 1,2,3,4,5: On Connector 6: Off [*CodecPro Room70G2 RoomPanorama/Room70Panorama*]

Connector 1: On Other connectors: Off [*RoomKit RoomKitMini RoomBar CodecEQ Room55 DeskMini Desk DeskPro Board BoardPro*]

Value space:

Off/On [*CodecEQ CodecPlus CodecPro Room70/Room55D Room70G2 RoomPanorama/Room70Panorama*]

Connector 1: Off/On Connector 2: Off Connector 3: Off/On [*BoardPro*]

Connector 1: Off/On Connector 2,3: Off [*RoomBar Room55 Desk DeskPro*]

Connector 1: Off/On Connector 2: Off [*DeskMini*]

Connector 1: Off/On Connector 2: Off [*RoomKit RoomKitMini Board*]

Off: Disable camera control.

On: Enable camera control.

n: Unique ID that identifies the video input connector.

Range: 1..2 [*RoomKit RoomKitMini DeskMini Board*]

Range: 1..3 [*RoomBar CodecPlus Room55 Room70/Room55D Desk DeskPro BoardPro*]

Range: 1..4 [*CodecEQ*]

Range: 1..6 [*CodecPro Room70G2 RoomPanorama/Room70Panorama*]

Video Input Connector [n] CEC Mode

Applies to: All products

Requires user role: ADMIN, INTEGRATOR

The video input (HDMI) supports Consumer Electronics Control (CEC). When this setting is enabled, information about the connected device (for example device type and device name) is available in the video conferencing device status (Video Input Connector[n] ConnectedDevice CEC [n]), provided that the connected device also supports CEC.

If you have Quad Camera, do not switch off CEC on that connector because then there will be no sound on the speakers on the camera. CEC is required for HDMI ARC (Audio Return Channel), which is the channel used for sending audio from the video conferencing device to the camera.

Default value:

On

Value space:

Off/On [*RoomKit RoomKitMini RoomBar CodecEQ CodecPlus CodecPro Room55 Room70G2 RoomPanorama/Room70Panorama DeskMini Desk DeskPro Board BoardPro*]

Connector 1: On Other connectors: Off/On [*Room70/Room55D*]

Off: CEC is disabled.

On: CEC is enabled.

n: Unique ID that identifies the video input connector.

Range: 1..3 [*CodecPlus Room70/Room55D*]

Range: 1..4 [*CodecEQ*]

Range: 1..5 [*CodecPro Room70G2 RoomPanorama/Room70Panorama*]

Range: 2..2 [*RoomKit RoomKitMini DeskMini Board*]

Range: 2..3 [*RoomBar Room55 Desk DeskPro BoardPro*]

Board

Board
ProCodec
EQCodec
PlusCodec
ProDesk,
Desk Pro,
Desk MiniRoom
Bar

Room Kit

Room Kit
Mini

Room 55

Room 55
Dual,
Room 70Room 70
G2Room 70
PanoramaRoom
Panorama

Video Input Connector [n] HDCP Mode

Applies to: [CodecEQ](#) [CodecPlus](#) [CodecPro](#) [Room55](#) [Room70/Room55D](#) [Room70G2](#) [RoomPanorama/Room70Panorama](#) [BoardPro](#)

Requires user role: ADMIN, INTEGRATOR

One of the video conferencing device's HDMI inputs can be configured to support HDCP protected content (High-bandwidth Digital Content Protection, version 1.4). This allows customers to re-purpose a video conferencing device's screen by connecting devices such as a DVD player, Google ChromeCast, AppleTV, or an HDTV decoder. This type of content cannot be shared while in a call.

When the input connector is set up to support HDCP, the following restrictions apply: You can't share any content from this input while in a call. However, you can share both HDCP protected content and non-protected content locally. You can't take web snapshots of this source.

To be able to show HDCP protected content on the device's screen, also ensure that the Video Output Connector [n] HDCPPolicy configuration is set correctly and that the screen itself supports HDCP.

Default value:

Off

Value space:

Connector 1,3: Off, Connector 2: Off/On [\[CodecPlus Room70/Room55D\]](#)

Connector 1, 2, 4: Off, Connector 3: Off/On [\[CodecEQ\]](#)

Connector 1,2,3,4: Off, Connector 5: Off/On [\[CodecPro Room70G2 RoomPanorama/Room70Panorama\]](#)

Connector 2: Off, Connector 3: Off/On [\[Room55 BoardPro\]](#)

Off: The video input doesn't support HDCP protected content; it supports only non-protected content.

On: The video input supports both HDCP protected content and non-protected content.

n: Unique ID that identifies the video input connector.

Range: 1..3 [\[CodecPlus Room70/Room55D\]](#)

Range: 1..4 [\[CodecEQ\]](#)

Range: 1..5 [\[CodecPro Room70G2 RoomPanorama/Room70Panorama\]](#)

Range: 2..3 [\[Room55 BoardPro\]](#)

Video Input Connector [n] InputSourceType

Applies to: [All products](#)

Requires user role: ADMIN, INTEGRATOR

Select which type of input source is connected to the video input.

If the device has an integrated camera, Connector 1 refers to the integrated camera.

Default value:

Connector 1,2,6: camera Connector 3,4,5: PC [\[CodecPro Room70G2 RoomPanorama/Room70Panorama\]](#)

Connector 1: camera Other connectors: PC [\[RoomKit RoomKitMini RoomBar CodecEQ CodecPlus Room55 Room70/Room55D DeskMini Desk DeskPro Board BoardPro\]](#)

Value space:

PC/camera/document_camera/mediaplayer/whiteboard/other [\[CodecEQ CodecPlus CodecPro Room70/Room55D Room70G2 RoomPanorama/Room70Panorama\]](#)

Connector 1: camera Other connectors: PC/camera/document_camera/mediaplayer/whiteboard/other [\[RoomKit RoomKitMini RoomBar Room55 DeskMini Desk DeskPro Board BoardPro\]](#)

PC: Use this when a computer is connected to the video input.

camera: Use this when a camera is connected to the video input.

document_camera: Use this when a document camera is connected to the video input.

mediaplayer: Use this when a media player is connected to the video input.

whiteboard: Use this when a whiteboard camera is connected to the video input.

other: Use this when the other options do not match.

n: Unique ID that identifies the video input connector.

Range: 1..2 [\[RoomKit RoomKitMini DeskMini Board\]](#)

Range: 1..3 [\[RoomBar CodecPlus Room55 Room70/Room55D Desk DeskPro BoardPro\]](#)

Range: 1..4 [\[CodecEQ\]](#)

Range: 1..6 [\[CodecPro Room70G2 RoomPanorama/Room70Panorama\]](#)

Board

Board
ProCodec
EQCodec
PlusCodec
ProDesk,
Desk Pro,
Desk MiniRoom
Bar

Room Kit

Room Kit
Mini

Room 55

Room 55
Dual,
Room 70Room 70
G2Room 70
PanoramaRoom
Panorama

Video Input Connector [n] Name

Applies to: All products

Requires user role: ADMIN, INTEGRATOR

Define a name for the video input connector.

Default value:

Connector 1: "Camera 1" Connector 2: "Camera 2" Connector 3: "PC 1 (HDMI)"
Connector 4: "PC 2 (HDMI)" Connector 5: "PC 3 (HDMI)" Connector 6: "Camera 3 (SDI)"
[\[CodecPro Room70G2 RoomPanorama/Room70Panorama \]](#)

Connector 1: "Camera" Connector 2: "PC (USB-C)" Connector 3: "PC (HDMI)"
[\[RoomBar BoardPro \]](#)

Connector 1: "Camera" Connector 2: "PC 1 (HDMI)" Connector 3: "PC 2 (HDMI)"
[\[CodecPlus Room70/Room55D \]](#)

Connector 1: "Camera" Connector 2: "PC 1 (HDMI)" Connector 3: "PC 2 (HDMI)"
Connector 4: "PC (USB-C)"
[\[CodecEQ \]](#)

Connector 1: "Camera" Connector 2: "PC 1 (HDMI)" Connector 3: "PC 2 (HDMI)"
[\[Room55 \]](#)

Connector 1: "Camera" Connector 2: "PC"
[\[RoomKit RoomKitMini Board \]](#)

Connector 1: "Camera" Connector 2: "PC (USB-C)"
[\[DeskMini \]](#)

Connector 1: "Camera" Connector 2: "PC (USB-C)" Connector 3: "PC (HDMI)"
[\[Desk DeskPro \]](#)

Value space:

String (0, 50)

Name for the video input connector.

n: Unique ID that identifies the video input connector.

Range: 1..2 [\[RoomKit RoomKitMini DeskMini Board \]](#)

Range: 1..3 [\[RoomBar CodecPlus Room55 Room70/Room55D Desk DeskPro BoardPro \]](#)

Range: 1..4 [\[CodecEQ \]](#)

Range: 1..6 [\[CodecPro Room70G2 RoomPanorama/Room70Panorama \]](#)

Video Input Connector [n] OptimalDefinition Profile

Applies to: All products

Requires user role: ADMIN, INTEGRATOR

This setting will not take effect if the corresponding Video Input Connector [n] Quality setting is set to Sharpness.

The optimal definition profile reflects the lighting conditions in the video conferencing room and the quality of the camera. The better lighting conditions and the better quality of the camera, the higher the profile. Generally, the Normal or Medium profiles are recommended. However, when the lighting conditions are very good, the High profile can be set in order to increase the resolution for a given call rate. The resolution must be supported by both the calling and called devices.

Use the Video Input Connector [n] OptimalDefinition Threshold60fps setting to set the lowest resolution where 60 fps is allowed. Below this threshold, 30 fps is the maximum frame rate.

Default value:

Medium [\[RoomKit RoomKitMini RoomBar CodecEQ CodecPlus CodecPro Room55 Room70/Room55D Room70G2 RoomPanorama/Room70Panorama DeskMini Desk Board BoardPro \]](#)

Connector 1: Medium Connector 2, 3: High [\[DeskPro \]](#)

Value space:

Normal/Medium/High

Normal: Use this profile for a typically to poorly lit environment. Resolutions will be set rather conservative.

Medium: Requires good and stable lighting conditions and a good quality video input. For some call rates this leads to higher resolution.

High: Requires nearly optimal video conferencing lighting conditions and a good quality video input in order to achieve a good overall experience. Rather high resolutions will be used.

n: Unique ID that identifies the video input connector.

Range: 1..2 [\[RoomKit RoomKitMini DeskMini Board \]](#)

Range: 1..3 [\[RoomBar CodecPlus Room55 Room70/Room55D Desk DeskPro BoardPro \]](#)

Range: 1..4 [\[CodecEQ \]](#)

Range: 1..6 [\[CodecPro Room70G2 RoomPanorama/Room70Panorama \]](#)

Board

Board
ProCodec
EQCodec
PlusCodec
ProDesk,
Desk Pro,
Desk MiniRoom
Bar

Room Kit

Room Kit
Mini

Room 55

Room 55
Dual,
Room 70Room 70
G2Room 70
PanoramaRoom
Panorama

Video Input Connector [n] OptimalDefinition Threshold60fps

Applies to: All products

Requires user role: ADMIN

For each video input, this setting tells the device the lowest resolution where it can transmit 60 fps. For all resolutions lower than this value, the maximum transmitted frame rate would be 30 fps. Above this resolution 60fps is possible, if the available bandwidth is adequate.

Default value:

1920_1080 [[RoomKitMini](#) [RoomBar](#) [CodecEQ](#) [CodecPlus](#) [CodecPro](#) [Room70/Room55D](#) [Room70G2](#) [RoomPanorama/Room70Panorama](#) [DeskMini](#) [Desk](#) [DeskPro](#) [Board](#) [BoardPro](#)]

Never [[RoomKit](#) [Room55](#)]

Value space:

512_288/768_432/1024_576/1280_720/1920_1080/Never

512_288: Set the threshold to 512x288.

768_432: Set the threshold to 768x432.

1024_576: Set the threshold to 1024x576.

1280_720: Set the threshold to 1280x720.

1920_1080: Set the threshold to 1920x1080.

Never: Do not set a threshold for transmitting 60fps.

n: Unique ID that identifies the video input connector.

Range: 1..2 [[RoomKit](#) [RoomKitMini](#) [DeskMini](#) [Board](#)]

Range: 1..3 [[RoomBar](#) [CodecPlus](#) [Room55](#) [Room70/Room55D](#) [Desk](#) [DeskPro](#) [BoardPro](#)]

Range: 1..4 [[CodecEQ](#)]

Range: 1..6 [[CodecPro](#) [Room70G2](#) [RoomPanorama/Room70Panorama](#)]

Video Input Connector [n] PreferredResolution

Applies to: All products

Requires user role: ADMIN, INTEGRATOR

Define the preferred screen resolution and refresh rate that the video conferencing device advertises to the connected input sources (for example a laptop). The logic for selection of the resolution on the source side will choose this resolution and refresh rate automatically, unless it is overridden manually by the source device (for example the laptop's display configuration software).

Note that larger formats than 1920_1080_60 use much more data, and requires a presentation cable (or adapter) that is qualified for at least HDMI 1.4b data rates.

Default value:

1920_1080_60 [[CodecPro](#) [Room70G2](#) [RoomPanorama/Room70Panorama](#) [DeskMini](#) [Desk](#)]

Connector 2: 3840_2160_60 Connector 3: 3840_2160_30 [[BoardPro](#)]

Connector 1: 1920_1080_60 Other connectors: 3840_2160_30 [[CodecEQ](#)]

3840_2160_30 [[RoomBar](#)]

3840_2160_60 [[DeskPro](#)]

1920_1080_60 [[RoomKit](#) [RoomKitMini](#) [CodecPlus](#) [Room55](#) [Room70/Room55D](#) [Board](#)]

Value space:

Connector 1,2: 1920_1080_60 Connector 3,4,5: 1920_1080_60/2560_1440_60/3840_2160_30 [[CodecPro](#) [Room70G2](#) [RoomPanorama/Room70Panorama](#)]

Connector 1: 1920_1080_60 Other connectors: 1920_1080_60/2560_1440_60/3840_2160_30 [[CodecEQ](#) [CodecPlus](#) [Room70/Room55D](#)]

1920_1080_60/2560_1440_60/3840_2160_30 [[RoomKit](#) [RoomKitMini](#) [RoomBar](#) [Room55](#) [Board](#)]

1920_1080_60/2560_1440_60/3840_2160_30/3840_2160_60 [[DeskPro](#)]

1920_1080_60 [[DeskMini](#) [Desk](#)]

Connector 2: 1920_1080_60/2560_1440_60/3840_2160_30/3840_2160_60

Connector 3: 1920_1080_60/2560_1440_60/3840_2160_30 [[BoardPro](#)]

1920_1080_60: The resolution is 1920 x 1080, and the refresh rate is 60 Hz.

2560_1440_60: The resolution is 2560 x 1440, and the refresh rate is 60 Hz.

3840_2160_30: The resolution is 3840 x 2160, and the refresh rate is 30 Hz.

3840_2160_60: The resolution is 3840 x 2160, and the refresh rate is 60 Hz.

n: Unique ID that identifies the video input connector.

Range: 1..3 [[CodecPlus](#) [Room70/Room55D](#)]

Range: 1..4 [[CodecEQ](#)]

Range: 1..5 [[CodecPro](#) [Room70G2](#) [RoomPanorama/Room70Panorama](#)]

Range: 2..2 [[RoomKit](#) [RoomKitMini](#) [DeskMini](#) [Board](#)]

Range: 2..3 [[RoomBar](#) [Room55](#) [Desk](#) [DeskPro](#) [BoardPro](#)]

Board

Board
ProCodec
EQCodec
PlusCodec
ProDesk,
Desk Pro,
Desk MiniRoom
Bar

Room Kit

Room Kit
Mini

Room 55

Room 55
Dual,
Room 70Room 70
G2Room 70
PanoramaRoom
Panorama

Video Input Connector [n] PresentationSelection

Applies to: All products

Requires user role: ADMIN, INTEGRATOR

Define how the video conferencing device will behave when you connect a presentation source to the video input. If the device is in standby mode, it will wake up when you connect a presentation source. Sharing the presentation with the far end requires additional action (select Share on the user interface) except when this setting is set to AutoShare.

For devices with more than one camera: Any input source can be used as a presentation source; usually, the main camera will not be used as a presentation source.

For devices with an integrated camera: The integrated camera is not available as a presentation source.

Default value:

Connector 1,2,6: Manual Connector 3,4,5: OnConnect [\[CodecPro Room70G2 RoomPanorama/Room70Panorama \]](#)

Connector 1: Manual Other connectors: OnConnect [\[CodecPlus Room70/Room55D \]](#)

Connector 1,2: Manual Other connectors: OnConnect [\[CodecEQ \]](#)

Desktop [\[RoomBar DeskMini Desk DeskPro \]](#)

OnConnect [\[RoomKit RoomKitMini Room55 BoardPro \]](#)

AutoShare [\[Board \]](#)

Value space:

AutoShare/Desktop/Manual/OnConnect

AutoShare: While in a call, the content on the video input will automatically be presented to the far end as well as on the local screen when you connect the cable, or when the source is activated otherwise (for example when a connected computer wakes up from sleep mode). You do not have to select Share on the user interface. If a presentation source is already connected when you make or answer a call, you have to manually select Share on the user interface.

Desktop: The content on the video input will be presented on the screen when you connect the cable, or when the source is activated otherwise (for example when a connected computer wakes up from sleep mode). This applies both when idle and in a call. Also, the content on the video input will stay on the screen when you leave the call, provided that it was the active input at the time of leaving.

Manual: The content on the video input will not be presented on the screen until you select Share from the user interface.

OnConnect: The content on the video input will be presented on screen when you connect the cable, or when the source is activated otherwise (for example when a connected computer wakes up from sleep mode). Otherwise, the behavior is the same as in manual mode.

n: Unique ID that identifies the video input connector.

Range: 1..3 [\[CodecPlus Room70/Room55D \]](#)

Range: 1..4 [\[CodecEQ \]](#)

Range: 1..6 [\[CodecPro Room70G2 RoomPanorama/Room70Panorama \]](#)

Range: 2..2 [\[RoomKit RoomKitMini DeskMini Board \]](#)

Range: 2..3 [\[RoomBar Room55 Desk DeskPro BoardPro \]](#)

Video Input Connector [n] Quality

Applies to: All products

Requires user role: ADMIN, INTEGRATOR

When encoding and transmitting video there is a trade-off between high resolution and high frame rate. For some video sources it is more important to transmit high frame rate than high resolution and vice versa. This setting specifies whether to give priority to high frame rate or to high resolution.

If a Quad Camera, SpeakerTrack 60 camera, or Precision 60 camera is detected by the device this setting is automatically set to Motion. If a user changes this setting manually, it will be set back to Motion after a restart or a camera reconnect.

Default value:

Connector 1,2,6: Motion Connector 3,4,5: Auto [\[CodecPro Room70G2 RoomPanorama/Room70Panorama \]](#)

Connector 1: Motion Other connectors: Auto [\[CodecPlus Room70/Room55D \]](#)

Connector 1,2: Motion Other connectors: Auto [\[CodecEQ \]](#)

Auto [\[RoomKit RoomKitMini RoomBar Room55 DeskMini Desk DeskPro Board BoardPro \]](#)

Value space:

Auto/Motion/Sharpness

Auto: As a starting point Auto resolves to Sharpness and the video stream will be encoded accordingly. The device will continuously analyze the incoming video stream, and if motion is detected it will automatically change to encoding for Motion.

Motion: Gives the highest possible frame rate. Used when there is a need for higher frame rates, typically when there is motion in the picture.

Sharpness: Gives the highest possible resolution. Used when you want the highest quality of detailed images and graphics.

n: Unique ID that identifies the video input connector.

Range: 1..3 [\[CodecPlus Room70/Room55D \]](#)

Range: 1..4 [\[CodecEQ \]](#)

Range: 1..6 [\[CodecPro Room70G2 RoomPanorama/Room70Panorama \]](#)

Range: 2..2 [\[RoomKit RoomKitMini DeskMini Board \]](#)

Range: 2..3 [\[RoomBar Room55 Desk DeskPro BoardPro \]](#)

Board

Video Input Connector [n] RGBQuantizationRange

Applies to: All products

Requires user role: ADMIN, INTEGRATOR

The devices connected to the video input should follow the rules for RGB video quantization range defined in CTA-861. Unfortunately some devices do not follow the standard and this configuration may be used to override the settings to get a perfect image with any source.

Default value:

Auto

Value space:

Auto/Full/Limited

Auto: RGB quantization range is automatically selected based on video format according to CTA-861-F. CE video formats will use limited quantization range levels. IT video formats will use full quantization range levels.

Full: Full quantization range. The R, G, B quantization range includes all code values (0 - 255). This is defined in CTA-861-F.

Limited: Limited Quantization Range. R, G, B quantization range that excludes some code values at the extremes (16 - 235). This is defined in CTA-861-F.

n: Unique ID that identifies the video input connector.

Range: 1..3 [[CodecPlus](#) [Room70/Room55D](#)]

Range: 1..4 [[CodecEQ](#)]

Range: 1..5 [[CodecPro](#) [Room70G2](#) [RoomPanorama/Room70Panorama](#)]

Range: 2..2 [[RoomKit](#) [RoomKitMini](#) [DeskMini](#) [Board](#)]

Range: 2..3 [[RoomBar](#) [Room55](#) [Desk](#) [DeskPro](#) [BoardPro](#)]

Board Pro

Codec EQ

Codec Plus

Codec Pro

Desk, Desk Pro, Desk Mini

Room Bar

Room Kit

Room Kit Mini

Room 55

Room 55 Dual, Room 70

Room 70 G2

Room 70 Panorama

Room Panorama

Video Input Connector [n] Visibility

Applies to: All products

Requires user role: ADMIN, INTEGRATOR

Define the visibility of the video input connector in the menus and buttons on the user interface.

For devices with an integrated camera: Connector 1 is the device's integrated camera and is not available as a presentation source.

Default value:

Connector 1: Never Other connectors: IfSignal [[CodecEQ](#) [CodecPro](#) [Room70G2](#) [DeskMini](#) [Desk](#) [DeskPro](#) [Board](#) [BoardPro](#)]

Connector 1: Never Connector 2: Never Other connectors: IfSignal [[RoomPanorama/Room70Panorama](#)]

Connector 1: Never Other connectors: Always [[RoomKit](#) [RoomKitMini](#) [RoomBar](#) [CodecPlus](#) [Room55](#) [Room70/Room55D](#)]

Value space:

Always/IfSignal/Never [[CodecEQ](#) [CodecPlus](#) [CodecPro](#) [Room55](#) [Room70/Room55D](#) [Room70G2](#) [RoomPanorama/Room70Panorama](#)]

Connector 1: Never Other connectors: Always/IfSignal/Never [[RoomKit](#) [RoomKitMini](#) [RoomBar](#) [DeskMini](#) [Desk](#) [DeskPro](#) [Board](#) [BoardPro](#)]

Always: The menu selection for the video input connector will always be visible on the user interface.

IfSignal: The menu selection for the video input connector will only be visible when something is connected to the video input.

Never: The input source is not expected to be used as a presentation source, and will not show up on the user interface.

n: Unique ID that identifies the video input connector.

Range: 1..2 [[RoomKit](#) [RoomKitMini](#) [DeskMini](#) [Board](#)]

Range: 1..3 [[RoomBar](#) [CodecPlus](#) [Room55](#) [Room70/Room55D](#) [Desk](#) [DeskPro](#) [BoardPro](#)]

Range: 1..4 [[CodecEQ](#)]

Range: 1..6 [[CodecPro](#) [Room70G2](#) [RoomPanorama/Room70Panorama](#)]

Board

Board
ProCodec
EQCodec
PlusCodec
ProDesk,
Desk Pro,
Desk MiniRoom
Bar

Room Kit

Room Kit
Mini

Room 55

Room 55
Dual,
Room 70Room 70
G2Room 70
PanoramaRoom
Panorama

Video Input Miracast Mode

Applies to: All products

Requires user role: ADMIN

Miracast allows meeting participants to share content wirelessly from their laptop (Windows or Android) to a video conferencing device, without the need for a client. Miracast uses Wi-Fi Direct to establish a direct network connection from a sending device (typically a meeting participant's laptop) to the video conferencing device. Only the 2.4 GHz band is supported. The devices use TCP port 7236 for signaling when establishing the connection.

When Miracast is turned on, the device emits a beacon that near-by devices can pick up (range in the order of 100 meter). The broadcast name that appears in the near-by devices' scan lists depends on the configuration. To be sure not to include any PII (personal identifiable information), you can specifically set a broadcast name with the SystemUnit BroadcastName setting. Otherwise, the scan lists will include the Webex DisplayName if the device is registered to the Webex cloud service, and the SystemUnit Name if registered to an on-premises service. If neither of these names are set, the product type (id) will be displayed.

Because Miracast is using Wi-Fi, it is not supported by non-radio devices. Also, you must remember to connect the Wi-Fi antennas on those products where they are optional. Further, the device must be connected to the network with cable (and have an IP address on the wired network interface).

This feature is not available for Room 70 Panorama and Room Panorama in this software version.

Default value:

Off

Value space:

Manual/Off/On

On: Miracast is activated, and users can't deactivate it.

Off: Miracast is deactivated, and users can't activate it.

Manual: Miracast is deactivated by default, but users can toggle it on and off themselves from the settings panel on the device's user interface.

Video Input Miracast Pin Length

Applies to: All products

Requires user role: ADMIN

Set the number of digits in the Miracast pin code. Meeting participants must enter this code on their laptop (sending device) when establishing the required Wi-Fi Direct network connection to the video conferencing device. The meeting participant must enter the pin code within 30 seconds.

Default value:

4

Value space:

4/8

The number of digits in the pin code.

Board

Board
ProCodec
EQCodec
PlusCodec
ProDesk,
Desk Pro,
Desk MiniRoom
Bar

Room Kit

Room Kit
Mini

Room 55

Room 55
Dual,
Room 70Room 70
G2Room 70
PanoramaRoom
Panorama

Video Monitors

Applies to: RoomKit RoomBar CodecEQ CodecPlus CodecPro Room55 Room70/Room55D Room70G2 RoomPanorama/Room70Panorama DeskMini Desk DeskPro BoardPro

Requires user role: ADMIN, INTEGRATOR

A monitor role is assigned to each screen using the Video Output Connector [n] MonitorRole setting. The monitor role decides which layout (call participants and presentation) will appear on the screen that is connected to this output. Screens with the same monitor role will get the same layout; screens with different monitor roles will have different layouts.

The monitor layout mode that is set in the Video Monitors setting should reflect the number of different layouts you want in your room setup. Note that some screens can be reserved for presentations.

Default value:

Auto

Value space:

Auto/Single/Dual/DualPresentationOnly [*RoomKit RoomBar CodecPlus Room55 Room70/Room55D DeskMini Desk DeskPro BoardPro*]

Auto/Single/Dual/DualPresentationOnly/Triple/TriplePresentationOnly [*CodecEQ CodecPro Room70G2*]

Auto/TriplePresentationOnly [*RoomPanorama/Room70Panorama*]

Auto: The number of screens connected to the device is automatically detected, and the layout is distributed on the screens according to the monitor role.

Single: The layout is shown on the device's screen. If the device has more than one screen, the same layout is shown on all screens.

Dual: The layout is distributed on screens with monitor role First and Second. If a presentation is part of the layout, all participants in the call are shown on screens with monitor role First, and the presentation is shown on screens with monitor role Second.

DualPresentationOnly: All participants in the call are shown on screens with monitor role First. If a presentation is part of the layout, the presentation is shown on screens with monitor role Second.

Triple: The layout is distributed on screens with monitor role First, Second and Third. Screens with monitor role Second are used first, then First, and finally Third. If a presentation is part of the layout, all participants in the call are shown on screens with monitor role First and Second, and the presentation is shown on the screen with monitor role Third.

TriplePresentationOnly: All participants in the call are distributed on screens with monitor role First and Second. Screens with monitor role Second are used first, then First. If a presentation is part of the layout, the presentation is shown on the screen with monitor role Third.

Video Output Connector [n] Brightness

Applies to: Room55 DeskMini Desk DeskPro BoardPro

Requires user role: ADMIN, USER

Define the brightness level for the device's integrated screen.

Default value:

80

Value space:

Integer (0..100)

Range: The value must be between 0 and 100.

n: Unique ID that identifies the video output connector.

Range: 1..1

Video Output Connector [n] BrightnessMode

Applies to: DeskPro

Requires user role: ADMIN, USER

Configure to allow for automatic or manual control of the brightness level on the screen. Connector [1] is the device's integrated screen.

Default value:

Auto

Value space:

Auto/Manual

Auto: Allow for the brightness level of the screen to be set automatically by the device.

Manual: Allow for the brightness level of the screen to be set manually by the user.

n: Unique ID that identifies the video output connector.

Range: 1..1

Board

Board
ProCodec
EQCodec
PlusCodec
ProDesk,
Desk Pro,
Desk MiniRoom
Bar

Room Kit

Room Kit
Mini

Room 55

Room 55
Dual,
Room 70Room 70
G2Room 70
PanoramaRoom
Panorama

Video Output Connector [n] CEC Mode

Applies to: RoomKit RoomKitMini RoomBar CodecEQ CodecPlus CodecPro Room55 Room70/Room55D Room70G2 RoomPanorama/Room70Panorama DeskPro BoardPro

Requires user role: ADMIN, INTEGRATOR

This video output (HDMI) supports Consumer Electronics Control (CEC).

When this setting is On, the video conferencing device will use CEC to set the screen in standby when the device itself enters standby. Likewise the device will wake up the screen when the device itself wakes up from standby.

The active video input on a screen is sometimes changed by a user. When a call is started the device detects if the active video input has been switched to another input on the screen. The device then switches the input back so the device is the active video input source. If the device is not the active input source when the device goes into standby the screen will not be set to standby.

It's a prerequisite that the screen that is connected to the output is CEC compatible and that CEC is enabled on the screen.

Note that the different manufacturers uses different marketing names for CEC, for example Anynet+ (Samsung); Aquos Link (Sharp); BRAVIA Sync (Sony); HDMI-CEC (Hitachi); Kuro Link (Pioneer); CE-Link and Regza Link (Toshiba); RIHD (Onkyo); HDAVI Control, EZ-Sync, VIERA Link (Panasonic); EasyLink (Philips); and NetCommand for HDMI (Mitsubishi).

Desk Pro and Board Pro do not support an external screen in this software version.

Default value:

On [RoomKit RoomKitMini RoomBar CodecEQ CodecPlus CodecPro Room55 DeskPro BoardPro]

Off [Room70/Room55D Room70G2]

Room Panorama: On ; Room 70 Panorama: Connector 1: Off, Connector 2: Off, Connector 3: On [RoomPanorama/Room70Panorama]

Value space:

Off/On [RoomKit RoomKitMini RoomBar CodecEQ CodecPlus CodecPro Room55 Room70/Room55D Room70G2 DeskPro BoardPro]

Room Panorama: On;

Room 70 Panorama: Off/On [RoomPanorama/Room70Panorama]

Off: CEC is disabled.

On: CEC is enabled.

n: Unique ID that identifies the video output connector.

Range: 1..1 [RoomKitMini]

Range: 1..2 [RoomKit RoomBar CodecPlus]

Range: 1..3 [CodecEQ CodecPro Room70G2 RoomPanorama/Room70Panorama]

Range: 2..2 [Room55 DeskPro BoardPro]

Range: 2..2 for Room 70 Single; not available for Room 70 Dual [Room70/Room55D]

Video Output Connector [n] HDCPPolicy

Applies to: RoomKit RoomKitMini RoomBar CodecEQ CodecPlus CodecPro Room55 Room70/Room55D Room70G2 RoomPanorama/Room70Panorama DeskPro BoardPro

Requires user role: ADMIN, INTEGRATOR, USER

Some of the video conferencing device's HDMI outputs can be set up to allow transmission of HDCP protected content. For HDCP protected content to be displayed on a screen, of course the screen itself must support HDCP as well.

Default value:

Off [RoomKit RoomKitMini BoardPro]

On [RoomBar CodecEQ Room55 DeskPro]

Connector 1,2: On Connector 3: Off [CodecPro Room70G2 RoomPanorama/Room70Panorama]

Connector 1: On Connector 2: Off [CodecPlus Room70/Room55D]

Value space:

Off [RoomKit RoomKitMini BoardPro]

Off/On [RoomBar CodecEQ]

On [Room55 DeskPro]

Connector 1,2: Off/On Connector 3: Off [CodecPro Room70G2 RoomPanorama/Room70Panorama]

Connector 1: Off/On Connector 2: Off [CodecPlus Room70/Room55D]

Off: HDCP is disabled on the output link. Therefore, the video output allows only non-protected content.

On: The video output allows both HDCP protected content and non-protected content.

n: Unique ID that identifies the video output connector.

Range: 1..2 [RoomKit RoomBar CodecPlus Room70/Room55D]

Range: 1..3 [CodecEQ CodecPro Room70G2 RoomPanorama/Room70Panorama]

Range: 2..2 [Room55 DeskPro BoardPro]

Range: 1..1 [RoomKitMini]

Board

Board
ProCodec
EQCodec
PlusCodec
ProDesk,
Desk Pro,
Desk MiniRoom
Bar

Room Kit

Room Kit
Mini

Room 55

Room 55
Dual,
Room 70Room 70
G2Room 70
PanoramaRoom
Panorama

Video Output Connector [n] Location HorizontalOffset

Applies to: RoomKit RoomBar CodecEQ CodecPlus CodecPro Room55 Room70/Room55D Room70G2 RoomPanorama/Room70Panorama DeskPro BoardPro

Requires user role: ADMIN, INTEGRATOR

HorizontalOffset and VerticalOffset settings are associated with each video output. These settings are used to signal the relative position of the displays that are connected to these outputs.

HorizontalOffset = "0" and VerticalOffset = "0" indicates that the display is positioned in center, both horizontally and vertically. A negative horizontal offset indicates that the monitor is left of center, and a positive horizontal offset indicates that the monitor is right of center. A negative vertical offset indicates that the monitor is below center, and a positive vertical offset indicates that the monitor is above center. The magnitude of the offset indicates how far the display is from center (relative to other displays).

Example: You have two screens side by side. The left screen is on Connector 1 and the right screen on Connector 2. Then the following settings will apply:

Video Output Connector 1 Location: HorizontalOffset = "0", VerticalOffset = "0"

Video Output Connector 2 Location: HorizontalOffset = "1", VerticalOffset = "0"

Example: You have two screens, one below the other. The upper screen is on Connector 1 and the lower screen on Connector 2. Then the following settings will apply:

Video Output Connector 1 Location: HorizontalOffset = "0", VerticalOffset = "0"

Video Output Connector 2 Location: HorizontalOffset = "0", VerticalOffset = "-1"

For Room 55 and Desk Pro, the integrated screen (Connector 1) has HorizontalOffset = "0" and VerticalOffset = "0" (implicit, not configurable). Desk Pro and Board Pro do not support an external screen in this software version.

Default value:

Connector 1: "-1" Connector 2: "0" Connector 3: "1" *[CodecEQ CodecPro Room70G2]*

Connector 1: "0" Connector 2: "1" Connector 3: "0.5" *[RoomPanorama/Room70Panorama]*

Connector 1: "0" Connector 2: "1" *[RoomKit RoomBar CodecPlus Room70/Room55D]*

Connector 2: "0" *[BoardPro]*

Connector 2: "1" *[Room55 DeskPro]*

Value space:

String (1, 12)

The string represents a decimal number between -100.0 and 100.0 (these numbers included). Input strings that complies with the std::stof function in the C++ <string> library are accepted. This means that you can use either decimal notation or E-notation, for example "12", "12.0", "1.2e1", "1.2E1", "-0.12", "-12e-2". Leading whitespace characters are discarded, and the decimal point is ".".

n: Unique ID that identifies the video output connector.

Range: 1..2 *[RoomKit RoomBar CodecPlus Room70/Room55D]*

Range: 1..3 *[CodecEQ CodecPro Room70G2 RoomPanorama/Room70Panorama]*

Range: 2..2 *[Room55 DeskPro BoardPro]*

Video Output Connector [n] Location VerticalOffset

Applies to: RoomKit RoomBar CodecEQ CodecPlus CodecPro Room55 Room70/Room55D Room70G2 RoomPanorama/Room70Panorama DeskPro BoardPro

Requires user role: ADMIN, INTEGRATOR

HorizontalOffset and VerticalOffset settings are associated with each video output. These settings are used to signal the relative position of the displays that are connected to these outputs.

HorizontalOffset = "0" and VerticalOffset = "0" indicates that the display is positioned in center, both horizontally and vertically. A negative horizontal offset indicates that the monitor is left of center, and a positive horizontal offset indicates that the monitor is right of center. A negative vertical offset indicates that the monitor is below center, and a positive vertical offset indicates that the monitor is above center. The magnitude of the offset indicates how far the display is from center (relative to other displays).

For Room 55 and Desk Pro the integrated screen (Connector 1) has HorizontalOffset = "0" and VerticalOffset = "0" (implicit, not configurable).

Example: You have two screens side by side. The left screen is on Connector 1 and the right screen on Connector 2. Then the following settings will apply:

Video Output Connector 1 Location: HorizontalOffset = "0", VerticalOffset = "0"

Video Output Connector 2 Location: HorizontalOffset = "1", VerticalOffset = "0"

Example: You have two screens with one below the other. The upper screen is on Connector 1 and the lower screen on Connector 2. Then the following settings will apply:

Video Output Connector 1 Location: HorizontalOffset = "0", VerticalOffset = "0"

Video Output Connector 2 Location: HorizontalOffset = "0", VerticalOffset = "-1"

Desk Pro and Board Pro do not support an external screen in this software version.

Default value:

Connector n: "0" *[RoomKit RoomBar CodecEQ CodecPlus CodecPro Room55 Room70/Room55D Room70G2 DeskPro BoardPro]*

Connector 1, 2: "0" Connector 3: "-1" *[RoomPanorama/Room70Panorama]*

Value space:

String (1, 12)

The string represents a decimal number between -100.0 and 100.0 (these numbers included). Input strings that complies with the std::stof function in the C++ <string> library are accepted. This means that you can use either decimal notation or E-notation, for example "12", "12.0", "1.2e1", "1.2E1", "-0.12", "-12e-2". Leading whitespace characters are discarded, and the decimal point is ".".

n: Unique ID that identifies the video output connector.

Range: 1..2 *[RoomKit RoomBar CodecPlus Room70/Room55D]*

Range: 1..3 *[CodecEQ CodecPro Room70G2 RoomPanorama/Room70Panorama]*

Range: 2..2 *[Room55 DeskPro BoardPro]*

Board

Board
ProCodec
EQCodec
PlusCodec
ProDesk,
Desk Pro,
Desk MiniRoom
Bar

Room Kit

Room Kit
Mini

Room 55

Room 55
Dual,
Room 70Room 70
G2Room 70
PanoramaRoom
Panorama

Video Output Connector [n] MonitorRole

Applies to: RoomKit RoomKitMini RoomBar CodecEQ CodecPlus CodecPro Room55 Room70/Room55D Room70G2 RoomPanorama/Room70Panorama DeskPro BoardPro

Requires user role: ADMIN, INTEGRATOR

The monitor role describes which video streams will be shown on the screen connected to this video output. Together the Video Monitors setting and the MonitorRole settings for all outputs define which layout (video streams) will be shown on each screen.

This setting is not applicable for Room Kit Mini, since it supports only one screen. Desk Pro and Board Pro do not support an external screen in this software version.

Default value:

Auto [RoomKit RoomBar CodecEQ CodecPlus CodecPro Room55 Room70G2 RoomPanorama/Room70Panorama DeskPro BoardPro]

Dual: Connector 1,2: Auto; Single: Connector 1: Auto Connector 2: PresentationOnly [Room70/Room55D]

Value space:

Auto/First/Second/PresentationOnly [RoomKit RoomBar CodecEQ CodecPlus Room55 Room70/Room55D DeskPro BoardPro]

Auto/First/Second/Third/PresentationOnly/Recorder [CodecPro Room70G2 RoomPanorama/Room70Panorama]

Auto: The device will detect when a screen is connected, and a monitor role (First, Second, Third) that corresponds with the Video Monitors setting will be assigned automatically.

First/Second/Third: Define the role of the screen in a multi-screen setup. In a single-screen setup, there is no difference between First, Second and Third.

PresentationOnly: Show presentation video stream if active, and nothing else. Screens/outputs with this monitor role are ignored by the Video Monitors setting.

Recorder: Show all participants, including the local main video (self-view). If active, also show the presentation. Screens/outputs with this monitor role are ignored by the Video Monitors setting.

n: Unique ID that identifies the video output connector.

Range: 1..2 [RoomKit RoomBar CodecPlus Room70/Room55D]

Range: 1..3 [CodecEQ CodecPro Room70G2 RoomPanorama/Room70Panorama]

Range: 2..2 [Room55 DeskPro BoardPro]

Range: 1..1 [RoomKitMini]

Video Output Connector [n] Resolution

Applies to: All products

Requires user role: ADMIN, INTEGRATOR, USER

Define the resolution and refresh rate for the screen. If the device has an integrated screen, Connector [1] refers to this screen.

The formats larger than 1920_1200_60 requires use of high quality display cables when connecting an external screen.

Some UHD TVs/displays only enable 3840_2160_30 (30 Hz) and not 3840_2160_60 (60 Hz) as their default configuration. In such cases the corresponding setting on the TV/display must be reconfigured to allow 3840_2160_60 for the HDMI input where the device is connected.

Desk Pro and Board Pro do not support an external screen (Connector [2]) in this software version.

Default value:

3840_2160_60 [Board]

1920_1080_60 [DeskMini Desk]

Connector 1: 3840_2160_60 Connector 2: Auto [Room55 DeskPro BoardPro]

Auto [RoomKit RoomKitMini RoomBar CodecEQ CodecPlus CodecPro Room70/Room55D Room70G2]

Connector 1, 2: Auto; Connector 3: 3840_2160_30 [RoomPanorama/Room70Panorama]

Value space:

Connector 1,2: Auto/1920_1080_50/1920_1080_60/1920_1200_50/1920_1200_60/2560_1440_60/3840_2160_30/3840_2160_60 Connector 3: Auto/1920_1080_50/1920_1080_60/1920_1200_50/1920_1200_60/2560_1440_60/3840_2160_30 [CodecPro Room70G2]

Connector 1,2: Auto/1920_1080_50/1920_1080_60/1920_1200_50/1920_1200_60/2560_1440_60/3840_2160_30/3840_2160_60 Connector 3: 3840_2160_30 [RoomPanorama/Room70Panorama]

3840_2160_60 [Board]

Connector 1: 3840_2160_60 Connector 2: Auto/1920_1080_50/1920_1080_60/1920_1200_50/1920_1200_60/2560_1440_60/3840_2160_30/3840_2160_60 [Room55 DeskPro BoardPro]

1920_1080_50 [DeskMini Desk]

Auto/1920_1080_50/1920_1080_60/1920_1200_50/1920_1200_60/2560_1440_60/3840_2160_30/3840_2160_60 [RoomKit RoomKitMini RoomBar CodecEQ CodecPlus Room70/Room55D]

Auto: The device will automatically try to set the optimal resolution based on negotiation with the connected monitor.

1920_1080_50: The resolution is 1920 x 1080, and the refresh rate is 50 Hz.

1920_1080_60: The resolution is 1920 x 1080, and the refresh rate is 60 Hz.

1920_1200_50: The resolution is 1920 x 1200, and the refresh rate is 50 Hz.

1920_1200_60: The resolution is 1920 x 1200, and the refresh rate is 60 Hz.

Board

2560_1440_60: The resolution is 2560 x 1440, and the refresh rate is 60 Hz.

3840_2160_30: The resolution is 3840 x 2160, and the refresh rate is 30 Hz.

3840_2160_60: The resolution is 3840 x 2160, and the refresh rate is 60 Hz.

Board Pro

Codec EQ

Codec Plus

Codec Pro

Desk, Desk Pro, Desk Mini

Room Bar

Room Kit

Room Kit Mini

Room 55

Room 55 Dual, Room 70

Room 70 G2

Room 70 Panorama

Room Panorama

n: Unique ID that identifies the video output connector.

Range: 1..1 [[RoomKitMini](#) [DeskMini](#) [Desk](#) [Board](#)]

Range: 1..2 [[RoomKit](#) [RoomBar](#) [CodecPlus](#) [Room55](#) [Room70/Room55D](#) [DeskPro](#) [BoardPro](#)]

Range: 1..3 [[CodecEQ](#) [CodecPro](#) [Room70G2](#) [RoomPanorama/Room70Panorama](#)]

Video Output Connector [n] RGBQuantizationRange

Applies to: [RoomKit](#) [RoomKitMini](#) [RoomBar](#) [CodecEQ](#) [CodecPlus](#) [CodecPro](#) [Room55](#) [Room70/Room55D](#) [Room70G2](#) [RoomPanorama/Room70Panorama](#) [DeskPro](#) [BoardPro](#)

Requires user role: ADMIN, INTEGRATOR

Connected HDMI displays should follow the rules for RGB video quantization range defined in CTA-861. Unfortunately some displays do not follow the standard and this configuration may be used to override the settings to get a perfect image with any display.

Desk Pro and Board Pro do not support an external screen in this software version.

Default value:

Full

Value space:

Auto/Full/Limited

Auto: If the display signals support for "Selectable RGB Quantization Range" in the EDID, then the AVI InfoFrame will signal Full Range in the RGB Quantization Range bits (Q0, Q1). Otherwise Limited Range will be signaled in the AVI InfoFrame for CE video formats and Full Range for IT video formats.

Full: Full quantization range. The R, G, B quantization range includes all code values (0 - 255). This is defined in CTA-861-H.

Limited: Limited Quantization Range. R, G, B quantization range that excludes some code values at the extremes (16 - 235). This is defined in CTA-861-H.

n: Unique ID that identifies the video output connector.

Range: 1..1 [[RoomKitMini](#)]

Range: 1..2 [[RoomKit](#) [RoomBar](#) [CodecPlus](#) [Room70/Room55D](#)]

Range: 1..3 [[CodecEQ](#) [CodecPro](#) [Room70G2](#) [RoomPanorama/Room70Panorama](#)]

Range: 2..2 [[Room55](#) [DeskPro](#) [BoardPro](#)]

Video Output HDMI Passthrough Allowed

Applies to: [RoomKit](#) [CodecPlus](#) [CodecPro](#) [Room55](#) [Room70/Room55D](#) [Room70G2](#)

Requires user role: ADMIN

If people connect their laptop to the USB socket of an HDMI-to-USB converter (capturing device) that is connected to one of the device's HDMI outputs, they can use the device's camera and microphone when making calls from their laptop meeting apps. They also need a presentation cable (HDMI) between the laptop and an HDMI input to make use of the device's screen and loudspeakers. This feature is referred to as Call from laptop, Webcam mode, or HDMI passthrough.

Which HDMI output the HDMI-to-USB converter is connected to is set with the Video Output HDMI Passthrough OutputConnector setting. You may also want to check that the Video Monitors and Video Output Connector [n] MonitorRole settings are correct.

Call from laptop is not supported on Room 55 Dual and Room 70 Dual because they don't have an HDMI output available for the converter.

Default value:

False

Value space:

False/True

False: Disable the feature. Calling from a laptop meeting app is not supported.

True: Enable the feature. Calling from a laptop meeting app is supported, and there is a Call from laptop button on the user interface.

Video Output HDMI Passthrough HdmiUsbConverter Mode

Applies to: [RoomKit](#) [CodecPlus](#) [CodecPro](#) [Room55](#) [Room70G2](#)

Requires user role: ADMIN, INTEGRATOR

When using the Call from laptop (HDMI passthrough) feature, users must choose (on their laptops) to use the HDMI-to-USB converter (capturing device) as microphone and camera. With this setting you can customize which name will be displayed in the list of devices to choose from.

Refer to the Video Output HDMI Passthrough Allowed setting for more details about Call from laptop.

Default value:

General

Value space:

Custom/General/Inogeni

General: Display a generic term as the name of the HDMI-to-USB converter.

Custom: Display the name defined in the Video Output Hdmi Passthrough HdmiUsbConverter Name setting as the name of the HDMI-to-USB converter.

Inogeni: Not applicable. Will be removed in future release.

Board

Video Output HDMI Passthrough HdmiUsbConverter Name

Applies to: RoomKit CodecPlus CodecPro Room55 Room70G2

Requires user role: ADMIN, INTEGRATOR

If Video Output Hdmi Passthrough HdmiUsbConverter Mode is set to Custom, you must set a name for the HDMI-to-USB converter (capture device) here. This is the name that will show up in the list of devices to choose from when choosing a camera and microphone from the laptop.

Default value:

""

Value space:

String (0, 25)

The name of the HDMI-to-USB converter.

Board Pro

Codec EQ

Codec Plus

Codec Pro

Desk, Desk Pro, Desk Mini

Room Bar

Room Kit

Room Kit Mini

Room 55

Room 55 Dual, Room 70

Room 70 G2

Room 70 Panorama

Room Panorama

Video Output HDMI Passthrough OutputConnector

Applies to: RoomKit CodecPlus CodecPro Room55 Room70/Room55D Room70G2

Requires user role: ADMIN, INTEGRATOR

Set the HDMI output connector you have connected the HDMI-to-USB converter (capture device) to. By default, the device is set up to use the HDMI output with the highest number.

This setting only applies when Call from laptop is enabled, that is, Video Output HDMI Passthrough Allowed is set to True.

This setting is not available for Room 55 Dual and Room 70 Dual because they don't have an HDMI output available for the converter.

Default value:

3 [CodecPro Room70G2]

2 [RoomKit CodecPlus Room70/Room55D]

1 [Room55]

Value space:

Integer (1..3) [CodecPro]

Room 70 Dual G2: Integer (3..3) Room 70 Single G2: Integer (2..3) [Room70G2]

Integer (1..2) [RoomKit CodecPlus]

Integer (1..1) [Room55]

Room 70 Single: Integer (2..2) [Room70/Room55D]

Range: The unique identifier of the selected video output connector.

Video Output HDMI Passthrough AutoDisconnect Enabled

Applies to: RoomKit CodecPlus CodecPro Room55 Room70/Room55D Room70G2

Requires user role: ADMIN, INTEGRATOR

Decide whether the device shall automatically disconnect the HDMI Passthrough after a given delay, for example if the user forgets to disconnect from the touch controller. The delay is set with the Video Output HDMI Passthrough AutoDisconnect Delay.

Refer to the Video Output HDMI Passthrough Allowed setting for more information about HDMI passthrough and the Call from laptop feature. Call from laptop is not supported on Room 55 Dual and Room 70 Dual.

Default value:

True

Value space:

False/True

False: HDMI Passthrough will not be disconnected automatically; the user must always disconnect from the touch controller.

True: HDMI Passthrough will disconnect when the Video Output HDMI Passthrough AutoDisconnect Delay times out.

Video Output HDMI Passthrough AutoDisconnect Delay

Applies to: RoomKit CodecPlus CodecPro Room55 Room70/Room55D Room70G2

Requires user role: ADMIN, INTEGRATOR

Set how long (minutes) the device shall be in HDMI Passthrough mode before it disconnects automatically. This setting only has an effect when Video Output HDMI Passthrough AutoDisconnect Enabled is set to True.

Refer to the Video Output HDMI Passthrough Allowed setting for more information about HDMI passthrough and the Call from laptop feature. Call from laptop is not supported on Room 55 Dual and Room 70 Dual.

Default value:

120

Value space:

Integer (1..1440)

The delay measured in minutes.

Board

Video Output Webcam USBMode

Applies to: RoomKitMini RoomBar BoardPro

Requires user role: ADMIN, INTEGRATOR

Specify whether to enter USB mode (and also do-not-disturb mode) when you connect video or when you start streaming video.

Default value:

OnStreaming

Value space:

OnConnect/OnStreaming

OnConnect: Go into USB mode when you connect video.

OnStreaming: Go into USB mode when you start streaming video.

Board
ProCodec
EQCodec
PlusCodec
ProDesk,
Desk Pro,
Desk MiniRoom
Bar

Room Kit

Room Kit
Mini

Room 55

Room 55
Dual,
Room 70Room 70
G2Room 70
PanoramaRoom
Panorama

Video Output Connector [n] Whitebalance Level

Applies to: Room55 DeskMini Desk DeskPro BoardPro

Requires user role: ADMIN, USER

The integrated screen's color temperature (white balance) is adjustable from 4000 K (warm) to 9000 K (cool).

Default value:

6500

Value space:

Integer (4000..9000)

The color temperature in Kelvin.

n: Unique ID that identifies the video output connector.

Range: 1..1

Video Presentation DefaultPIPPosition

Applies to: All products

Requires user role: ADMIN, INTEGRATOR

Define the position on screen of the presentation picture-in-picture (PiP). The setting only takes effect when the presentation is explicitly minimized to a PiP, for example using the user interface. The setting takes effect from the next call onwards; if changed during a call, it will have no effect on the current call.

Default value:

Current

Value space:

Current/UpperLeft/UpperCenter/UpperRight/CenterLeft/CenterRight/LowerLeft/
LowerRight

Current: The position of the presentation PiP will be kept unchanged when leaving a call.

UpperLeft: The presentation PiP will appear in the upper left corner of the screen.

UpperCenter: The presentation PiP will appear in the upper center position.

UpperRight: The presentation PiP will appear in the upper right corner of the screen.

CenterLeft: The presentation PiP will appear in the center left position.

CenterRight: The presentation PiP will appear in the center right position.

LowerLeft: The presentation PiP will appear in the lower left corner of the screen.

LowerRight: The presentation PiP will appear in the lower right corner of the screen.

Video Presentation DefaultSource

Applies to: All products

Requires user role: ADMIN, USER

Define which video input source to use as a default presentation source. This setting may be used by the API and third-party user interfaces. It is not relevant when using the user interfaces provided by Cisco.

Default value:

2 [RoomKit RoomKitMini RoomBar CodecEQ CodecPlus Room55 Room70/Room55D DeskMini Desk
DeskPro Board BoardPro]

3 [CodecPro Room70G2 RoomPanorama/Room70Panorama]

Value space:

1/2 [RoomKit RoomKitMini DeskMini Board]

1/2/3 [RoomBar CodecPlus Room55 Room70/Room55D Desk DeskPro BoardPro]

1/2/3/4 [CodecEQ]

1/2/3/4/5/6 [CodecPro Room70G2 RoomPanorama/Room70Panorama]

The video input source to use as default presentation source.

Board

Board
ProCodec
EQCodec
PlusCodec
ProDesk,
Desk Pro,
Desk MiniRoom
Bar

Room Kit

Room Kit
Mini

Room 55

Room 55
Dual,
Room 70Room 70
G2Room 70
PanoramaRoom
Panorama

Video Presentation Priority

Applies to: All products

Requires user role: ADMIN

Specify how to distribute the bandwidth between the presentation channel and the main video channel.

Default value:

Equal

Value space:

Equal/High/Low [[RoomKit](#) [RoomKitMini](#) [RoomBar](#) [CodecEQ](#) [CodecPlus](#) [CodecPro](#) [Room55](#) [Room70/Room55D](#) [Room70G2](#) [DeskMini](#) [Desk](#) [DeskPro](#) [Board](#) [BoardPro](#)]

Equal [[RoomPanorama/Room70Panorama](#)]

Equal: The available bandwidth is shared equally between the presentation channel and the main video channel.

High: The presentation channel is assigned a larger portion of the available bandwidth at the expense of the main video channel.

Low: The main video channel is assigned a larger portion of the available bandwidth at the expense of the presentation channel.

Video Selfview Default FullscreenMode

Applies to: All products

Requires user role: ADMIN, INTEGRATOR

Define if the main video source (self-view) shall be shown in full screen or as a small picture-in-picture (PiP) after a call. The setting only takes effect when self-view is switched on (see the Video Selfview Default Mode setting).

For Desk and Desk Pro, if you use the user interface to turn full screen self-view off, it will come back as a PiP the next time that you use the user interface to turn it on.

Default value:

Current

Value space:

Off/Current/On

Off: Self-view will be shown as a PiP.

Current: The size of the self-view picture will be kept unchanged when leaving a call. That is, if it was a PiP during the call, it remains a PiP after the call; if it was fullscreen during the call, it remains fullscreen after the call.

On: The self-view picture will be shown in fullscreen.

Video Selfview Default Mode

Applies to: All products

Requires user role: ADMIN, INTEGRATOR

Define if the main video source (self-view) shall be displayed on screen after a call, and also after video has been turned off and on again during a call. The position and size of the self-view window is determined by the Video Selfview Default PIPPosition and the Video Selfview Default FullscreenMode settings respectively.

Default value:

Current

Value space:

Off/Current/On

Off: Self-view is switched off when leaving a call, and also after video is turned on during a call.

Current: Self-view is left as is. That is, if it was on during the call, it remains on after the call; if it was off during the call, it remains off after the call. Similar after turning on video during a call.

On: Self-view is switched on when leaving a call, and also after video is turned on during a call.

Video Selfview Default OnMonitorRole

Applies to: All products

Requires user role: ADMIN, INTEGRATOR

Define which screen/output to display the main video source (self-view) after a call. The value reflects the monitor roles set for the different outputs in the Video Output Connector [n] MonitorRole setting.

The setting applies both when self-view is displayed in full screen, and when it is displayed as picture-in-picture (PiP).

Default value:

Current

Value space:

Current/First/Second [[RoomKit](#) [RoomKitMini](#) [RoomBar](#) [CodecEQ](#) [CodecPlus](#) [Room55](#) [Room70/Room55D](#) [DeskMini](#) [Desk](#) [DeskPro](#) [Board](#) [BoardPro](#)]

Current/First/Second/Third [[CodecPro](#) [Room70G2](#) [RoomPanorama/Room70Panorama](#)]

Current: When leaving a call, the self-view picture will be retained on the same output as it was during the call.

First: The self-view picture will be shown on outputs with monitor role First.

Second: The self-view picture will be shown on outputs with monitor role Second.

Third: The self-view picture will be shown on outputs with monitor role Third.

Board

Board
ProCodec
EQCodec
PlusCodec
ProDesk,
Desk Pro,
Desk MiniRoom
Bar

Room Kit

Room Kit
Mini

Room 55

Room 55
Dual,
Room 70Room 70
G2Room 70
PanoramaRoom
Panorama

Video Selfview Default PIPPosition

Applies to: All products

Requires user role: ADMIN, INTEGRATOR

Define the position on screen of the small self-view picture-in-picture (PiP) after a call. The setting only takes effect when self-view is switched on (see the Video Selfview Default Mode setting) and fullscreen view is switched off (see the Video Selfview Default FullscreenMode setting).

Default value:

Current [[RoomKit](#) [RoomKitMini](#) [RoomBar](#) [CodecEQ](#) [CodecPlus](#) [CodecPro](#) [Room55](#) [Room70/Room55D](#) [Room70G2](#) [DeskMini](#) [Desk](#) [DeskPro](#) [BoardPro](#)]

LowerRight [[RoomPanorama/Room70Panorama](#)]

Current [[Board](#)]

Value space:

Current/UpperLeft/UpperCenter/UpperRight/CenterLeft/CenterRight/LowerLeft/
LowerRight

Current: The position of the self-view PiP will be kept unchanged when leaving a call.

UpperLeft: The self-view PiP will appear in the upper left corner of the screen.

UpperCenter: The self-view PiP will appear in the upper center position.

UpperRight: The self-view PiP will appear in the upper right corner of the screen.

CenterLeft: The self-view PiP will appear in the center left position.

CentreRight: The self-view PiP will appear in the center right position.

LowerLeft: The self-view PiP will appear in the lower left corner of the screen.

LowerRight: The self-view PiP will appear in the lower right corner of the screen.

Video Selfview OnCall Mode

Applies to: All products

Requires user role: ADMIN, INTEGRATOR

This setting is used to switch on self-view for a short while when setting up a call. The Video Selfview OnCall Duration setting determines for how long it remains on. This applies when self-view in general is switched off.

Default value:

On [[RoomKit](#) [RoomKitMini](#) [CodecEQ](#) [CodecPlus](#) [CodecPro](#) [Room55](#) [Room70/Room55D](#) [Room70G2](#) [RoomPanorama/Room70Panorama](#) [DeskPro](#)]

Off [[RoomBar](#) [DeskMini](#) [Desk](#) [Board](#) [BoardPro](#)]

Value space:

Off/On

Off: Self-view is not shown automatically during call setup.

On: Self-view is shown automatically during call setup.

Video Selfview OnCall Duration

Applies to: All products

Requires user role: ADMIN, INTEGRATOR

This setting only has an effect when the Video Selfview OnCall Mode setting is switched On. In this case, the number of seconds set here determines for how long self-view is shown before it is automatically switched off.

Default value:

5

Value space:

Integer (1..60)

Range: Choose for how long self-view remains on. The valid range is between 1 and 60 seconds.

Board

Board
ProCodec
EQCodec
PlusCodec
ProDesk,
Desk Pro,
Desk MiniRoom
Bar

Room Kit

Room Kit
Mini

Room 55

Room 55
Dual,
Room 70Room 70
G2Room 70
PanoramaRoom
Panorama

VoiceControl settings

VoiceControl Wakeword Mode

Applies to: All products

Requires user role: ADMIN, INTEGRATOR

Use this setting to enable or disable the wakeword (for example, "Ok Webex") that is used by the Webex Assistant. The Webex Assistant allows you to use the device hands free, and by using the wakeword you can initiate tasks, such as placing a call and starting a presentation.

Use the UserInterface Assistant Mode setting to switch on the Webex Assistant.

Default value:

On

Value space:

Off/On

Off: Disable the use of a wakeword.

On: Enable the use of a wakeword.

Board

Board
ProCodec
EQCodec
PlusCodec
ProDesk,
Desk Pro,
Desk MiniRoom
Bar

Room Kit

Room Kit
Mini

Room 55

Room 55
Dual,
Room 70Room 70
G2Room 70
PanoramaRoom
Panorama

WebEngine settings

WebEngine Features LocalWebAppManagement

Applies to: DeskMini Desk DeskPro Board BoardPro

Requires user role: ADMIN

Determines whether to show a list of installed web apps in the Settings menu on the user interface of the device, and whether the user can manage the web apps (add, edit, or delete) from this menu.

Only web apps that are set up directly on the device, from the device's local web interface, or by using the API can be managed from the Settings menu (locally managed). Web apps that are set up from Control Hub (externally managed) are shown in the list, but the user can never manage them.

Default value:

Off

Value space:

Allowed/NotAllowed/Off

Allowed: A user can add, edit, and delete locally managed web apps from the Settings menu on the user interface of the device.

NotAllowed: The list of installed web apps is shown in the Settings menu, but the user cannot manage them.

Off: There is no entry for listing or managing web apps in the Settings menu.

WebEngine Features WebGL

Applies to: All products

Requires user role: ADMIN

WebGL™ is a web standard for a low-level 3D graphics. WebGL support in RoomOS is an experimental feature and might change in the future.

Default value:

Off

Value space:

Off/On

On: WebGL is enabled.

Off: WebGL is disabled.

WebEngine Features SipUrlHandler

Applies to: RoomKitMini DeskMini Desk DeskPro Board BoardPro

Requires user role: ADMIN

This configuration allows you to start SIP calls directly from web view based features (for example, a web app or digital signage). The user selects a button labeled with SIP:yourSipUrl to initiate a call, and the call is then placed by the device.

Default value:

Off

Value space:

Off/On

Off: Starting SIP calls from a web view is disabled.

On: Starting SIP calls from a web view is enabled.

WebEngine Features Xapi Peripherals AllowedHosts Hosts

Applies to: All products

Requires user role: ADMIN

If the domain name of the server hosting a persistent web app is listed here, the app is allowed to run API commands on the device. Otherwise, only apps that don't require any communication with the device can run on the Room Navigator.

The URL, specified with UserInterface HomeScreen Peripherals WebApp URL setting, will be checked, and matched against this list of allowed hosts before it's allowed to run API commands on the device.

Note: Persistent web apps are only available on Room Navigators that are paired to the device over the network.

Default value:

""

Value space:

String (0, 1024)

Specify one or more domain names. If more than one, separate them by comma. You can use the "*" as a wildcard. For example, "*.cisco.com" allows any host ending in cisco.com. To allow any domain, specify "*".

Board

WebEngine FpsCounter

Applies to: All products

Requires user role: ADMIN

Not applicable in this release.

Default value:

Off

Value space:

Off/On

Board Pro

Codec EQ

Codec Plus

Codec Pro

Desk, Desk Pro, Desk Mini

Room Bar

WebEngine MinimumTLSVersion

Applies to: All products

Requires user role: ADMIN

Set the lowest version of the TLS (Transport Layer Security) protocol that is allowed for WebEngine.

Default value:

TLSv1.1

Value space:

TLSv1.0/TLSv1.1/TLSv1.2

TLSv1.0: Support of TLS version 1.0 or higher.

TLSv1.1: Support of TLS version 1.1 or higher.

TLSv1.2: Support of TLS version 1.2 or higher.

Room Kit

Room Kit Mini

Room 55

Room 55 Dual, Room 70

Room 70 G2

Room 70 Panorama

Room Panorama

WebEngine Mode

Applies to: All products

Requires user role: ADMIN

The web engine is a prerequisite for features that use the device's web view, for example digital signage and web apps.

Default value:

Off

Value space:

Off/On

Off: The web engine is disabled.

On: The web engine is enabled.

WebEngine RemoteDebugging

Applies to: All products

Requires user role: ADMIN

If you encounter a problem with a web page, it can be a good idea to turn on remote debugging. Remote debugging lets you access the Chrome developer console and identify potential issues with a web page. When enabled, a banner is displayed at the bottom of the screen, warning the users that they may be monitored. The banner also shows the URL that you can enter in your local Chrome browser to open the developer console.

Make sure to turn off remote debugging after use.

Default value:

Off

Value space:

Off/On

Off: Remote debugging is switched off.

On: Remote debugging is switched on.

WebEngine UseHttpProxy

Applies to: All products

Requires user role: ADMIN

There are several UseHttpProxy settings that specify if a service shall communicate via an HTTP proxy or not. The WebEngine UseHttpProxy setting applies all web view based features, such as digital signage, API-driven web views, and web apps.

For this setting to have any effect, a proxy server for HTTP, HTTPS, and WebSocket traffic must be set up using the NetworkServices HTTP Proxy settings.

Default value:

On

Value space:

Off/On

Off: Set up communication directly with the server (not using a proxy).

On: Set up communication via proxy.

Board

Board
ProCodec
EQCodec
PlusCodec
ProDesk,
Desk Pro,
Desk MiniRoom
Bar

Room Kit

Room Kit
Mini

Room 55

Room 55
Dual,
Room 70Room 70
G2Room 70
PanoramaRoom
Panorama

Webex settings

Webex CloudProximity GuestShare

Applies to: All products

Requires user role: ADMIN

This setting allows you to turn off the guest share feature via devices.webex.com.

Default value:

Auto

Value space:

Auto/Off

Auto: Allow the system to automatically determine whether or not to allow guest sharing. This is enabled by default currently.

Off: Turn off the guest share feature.

Webex CloudProximity Mode

Applies to: All products

Requires user role: ADMIN

Devices registered to an on-premises call manager and linked to Webex Edge for Devices support both on-premises and cloud proximity mode for handling pairing mechanisms like ultrasound, Wi-Fi discovery, and guest sharing. This setting allows you to define which of the two proximity modes to use.

Default value:

Off

Value space:

Off/On

Off: The linked device uses on-premises proximity mode.

On: The linked device uses cloud proximity mode.

Webex CloudUpgrades Mode

Applies to: All products

Requires user role: ADMIN

On devices that are registered to an on-premises service and linked to Webex Edge for Devices, you can choose whether to upgrade the software from the on-premises provisioning service or from the Webex cloud service (cloud-managed software upgrade).

With cloud-managed software upgrade the device is upgraded automatically when a new RoomOS software version is available, that is at the same time as cloud registered devices are upgraded. You get the latest updates and bug fixes faster without having to upgrade the device manually.

Default value:

Off

Value space:

Off/On

Off: The device software is not upgraded from the cloud. You must use an on-premises provisioning service, such as CUCM, or rely on manual upgrades.

On: The device software is automatically upgraded when a new software version is available in the cloud.

Webex Hotdesking DefaultBookingEndTime

Applies to: DeskMini Desk DeskPro

Requires user role: ADMIN

This setting applies only to a device that is set up with hot desking capabilities, which implies that it must be in shared mode and registered to the Webex cloud service or linked to Webex Edge for Devices.

Since companies and organizations have different normal working hours, you can configure the time when a booking, by default, should expire. This is just the default time, so the user can specify a different end time when booking the device.

Default value:

17

Value space:

Integer (0..24)

The default booking end time in 24-hour clock notation. Some examples: 0 is 00:00 / 12:00 a.m. – midnight; 12 is 12:00 / 12:00 p.m. – noon; and 17 is 17:00 / 5:00 p.m.

Board

Board
ProCodec
EQCodec
PlusCodec
ProDesk,
Desk Pro,
Desk MiniRoom
Bar

Room Kit

Room Kit
Mini

Room 55

Room 55
Dual,
Room 70Room 70
G2Room 70
PanoramaRoom
Panorama

Webex Meetings JoinProtocol

Applies to: All products

Requires user role: ADMIN

Devices that are registered to an on-premises service and linked to Webex Edge for Devices may use the Webex cloud service for calling into Webex meetings. Calling via Webex gives you the full set of native Webex Meetings in-call features, such as advanced mute, cohost, transfer host, and face recognition.

These are the cases when Webex Meetings call routing may be used: When using the Join Webex button, when using the Webex Assistant to join a Personal Room meeting (PMR), and when using the Call button or the Dial API command with a URI with one of the following domains: @webex.com, @*.webex.com, and @meet.ciscospark.com. Other calls will use to the default protocol.

Also, native Webex Meetings call routing requires that the device is enabled for cloud-managed software upgrade, configuration from Control Hub is enabled, and the Conference Multipoint Mode is set to Auto.

Room Panorama and Room 70 Panorama are not supported in CE 9.15.0.

Default value:

SIP

Value space:

SIP/Webex

SIP: The call protocol is SIP.

Webex: The call protocol is Webex, provided that the requirements above are met. Otherwise, it is SIP.

Board

Board
ProCodec
EQCodec
PlusCodec
ProDesk,
Desk Pro,
Desk MiniRoom
Bar

Room Kit

Room Kit
Mini

Room 55

Room 55
Dual,
Room 70Room 70
G2Room 70
PanoramaRoom
Panorama

WebRTC settings

WebRTC EndCallTimeout

Applies to: RoomKit RoomKitMini RoomBar CodecEQ CodecPlus CodecPro Room55 Room70/Room55D Room70G2 RoomPanorama/Room70Panorama DeskMini Desk DeskPro Board BoardPro

Requires user role: ADMIN

You can extend the period between pressing End call in a WebRTC meeting and the closing of the web view.

In normal operation, you do not need to change this setting, but it can be useful for troubleshooting.

WebRTC is only available for devices that are registered to an on-premises service and linked to Webex Edge for Devices, and for devices that are registered to the Webex cloud service.

Default value:

2

Value space:

Integer (0..600)

The period in seconds.

WebRTC InteractionMode

Applies to: RoomKitMini DeskMini Desk DeskPro Board BoardPro

Requires user role: ADMIN

When in a WebRTC meeting, you can use the device's call controls or the WebRTC app's built-in controls.

WebRTC is only available for devices that are registered to an on-premises service and linked to Webex Edge for Devices, and for devices that are registered to the Webex cloud service.

Default value:

NonInteractive

Value space:

Interactive/NonInteractive

Interactive: You can use the WebRTC app's built-in controls directly from the device's touch screen. This will give you access to the built-in WebRTC features.

NonInteractive: The WebRTC app's built-in controls are not available; you can only use the regular call controls of the device.

WebRTC Provider MicrosoftTeams CompatibilityMode

Applies to: RoomKit RoomKitMini CodecEQ CodecPlus CodecPro Room55 Room70/Room55D Room70G2 RoomPanorama/Room70Panorama DeskPro Board

Requires user role: ADMIN

An option that can be applied temporarily for intermittent troubleshooting of Microsoft Teams calls using WebRTC. Cisco TAC can advise when to set this configuration. The recommendation is otherwise to leave it off.

Default value:

Off

Value space:

Off/On

Off: Compatibility mode is turned off.

On: Compatibility mode is turned on.

Board

Board
ProCodec
EQCodec
PlusCodec
ProDesk,
Desk Pro,
Desk MiniRoom
Bar

Room Kit

Room Kit
Mini

Room 55

Room 55
Dual,
Room 70Room 70
G2Room 70
PanoramaRoom
Panorama

Zoom settings

Zoom DefaultDomain

Applies to: All products

Requires user role: ADMIN

The domain that you enter here is used by the Zoom Join command; hence it's also used when you tap the Zoom button on the device UI. If the Zoom Join command fetches join information from a booking (BookingID), the domain entered here is ignored.

Default value:

zoomcrc.com

Value space:

String (1, 256)

The domain to use for Zoom calls.

Zoom DialStringOptions

Applies to: All products

Requires user role: ADMIN

The dial string options that you enter here are used by the Zoom Join command; hence they're also used when you tap the Zoom button on the device UI. Amongst other, options for dual-screen and other visual features are available. Read more about Zoom's dial string options at "<https://support.zoom.us/hc/en-us/articles/202405539-SIP-H-323-Room-Connector-Dial-Strings>".

If the Zoom Join command fetches join information from a booking (BookingID), and the fetched uri has a format other than <meetingid>@<domain>, the dial string options entered here are ignored.

Default value:

" "

Value space:

String (0, 200)

The options for the Zoom dial string.

Board

Board
Pro

Codec
EQ

Codec
Plus

Codec
Pro

Desk,
Desk Pro,
Desk Mini

Room
Bar

Room Kit

Room Kit
Mini

Room 55

Room 55
Dual,
Room 70

Room 70
G2

Room 70
Panorama

Room
Panorama

Experimental settings

The Experimental settings are for testing only and should not be used unless agreed with Cisco. These settings are not documented and WILL change in later releases.

Board

Board
Pro

Codec
EQ

Codec
Plus

Codec
Pro

Desk,
Desk Pro,
Desk Mini

Room
Bar

Room Kit

Room Kit
Mini

Room 55

Room 55
Dual,
Room 70

Room 70
G2

Room 70
Panorama

Room
Panorama

Chapter 6

Physical interfaces

Board

Board Pro

Codec EQ

Codec Plus

Codec Pro

Desk, Desk Pro, Desk Mini

Room Bar

Room Kit

Room Kit Mini

Room 55

Room 55 Dual, Room 70

Room 70 G2

Room 70 Panorama

Room Panorama

Power On/Off and LED behavior (page 1 of 9)

Codec EQ, Codec Plus, and Codec Pro

The power switch on the codec's rear side is its main On/Off switch.

It may take a few minutes for the codec to start up. The LED lights steadily when the codec is ready for use.

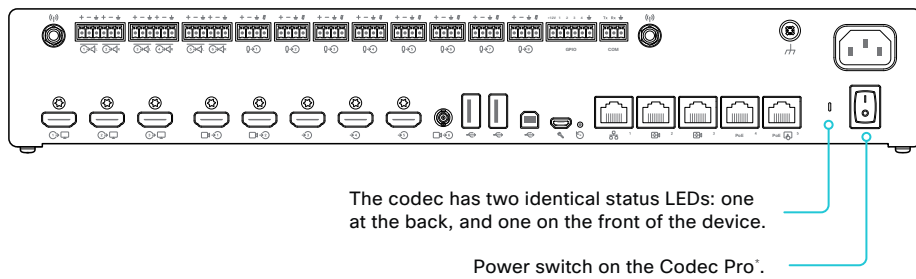
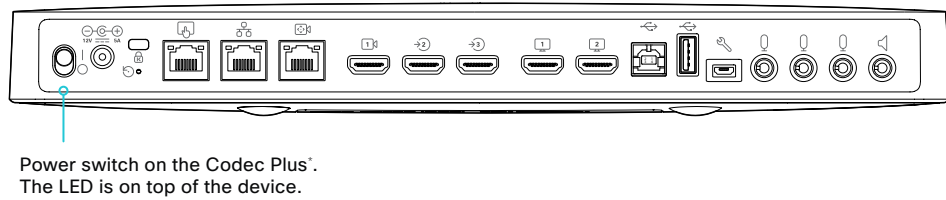
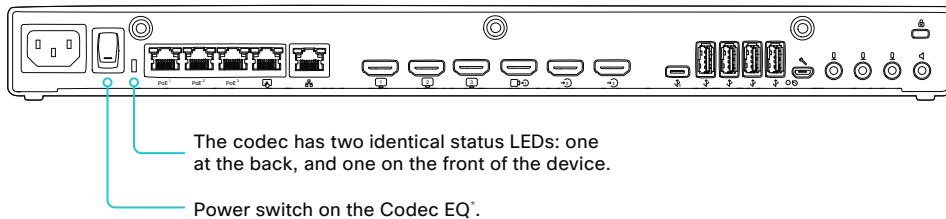

LED behavior

In idle mode (screens are awake):

Steady light.

In standby mode (screens are off):

Steady light.

The device needs attention (e.g. missed call or no network connection):

The LED repeatedly flashes twice.

During startup (boot):

The LED flashes. It turns steady when the device is ready for use.

* Configuration changes might be lost if you shut down the device using the power switch just a few seconds after saving the changes.

Board

Board Pro

Codec EQ

Codec Plus

Codec Pro

Desk, Desk Pro, DeskMini

Room Bar

Room Kit

Room Kit Mini

Room 55

Room 55 Dual, Room 70

Room 70 G2

Room 70 Panorama

Room Panorama

Power On/Off and LED behavior (page 2 of 9)

Room Bar, Room Kit, and Room Kit Mini

The main On/Off switch is located on the back of the Room Bar, Room Kit, and Room Kit Mini. Switch it to the On position. It may take a few minutes to start up. The system LED lights steadily when the device is ready for use.

Keep in mind that once the device is mounted on top of a screen, the power switch may be difficult to access.



Power switch on the Room Bar*. The LEDs are on the front of the device.

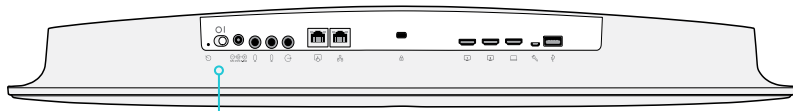

Power switch on the Room Kit*. The LEDs are on the front of the device.

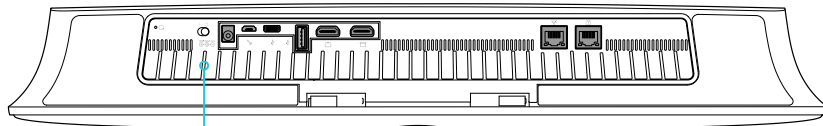

Power switch on the Room Kit Mini*. The LEDs are on the front of the device.

LED behavior

System LED

In idle mode (screens are awake):

Steady light.

In standby mode (screens are off):

Steady light.

The device needs attention (e.g. missed call or no network connection):

The LED repeatedly flashes twice.

During startup (boot):

The LED flashes. It turns steady when the device is ready for use.

Camera LED

Incoming call:

The LED flashes.

In call:

Steady light.

Selfview on:

Steady light.

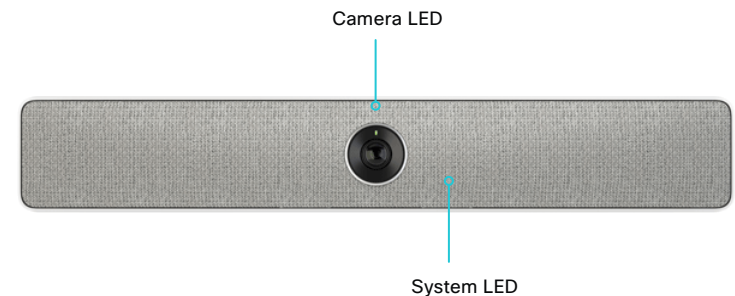

* Configuration changes might be lost if you shut down the device using the power switch just a few seconds after saving the changes.

Board

Board Pro

Codec EQ

Codec Plus

Codec Pro

Desk, Desk Pro, DeskMini

Room Bar

Room Kit

Room Kit Mini

Room 55

Room 55 Dual, Room 70

Room 70 G2

Room 70 Panorama

Room Panorama

Power On/Off and LED behavior (page 3 of 9)

Room 55

When Room 55 is mounted to a wall, you cannot access the power switch. Ensure that Room 55 is mounted with the power switch in the *On* position so that once it's plugged in, it will automatically power-on.

Before unplugging the device, shut it down via the device web interface: *Backup and Recovery > Restart and Shutdown > Shutdown*.

You may experience problems if you unplug the device before shutting it down properly. If this happens, try restarting the video system using the device web interface to restore normal behavior.

On a floor stand or wheel base mounted Room 55, remove the cover on the back to get access to the connectors. The power switch is next to the power connector.

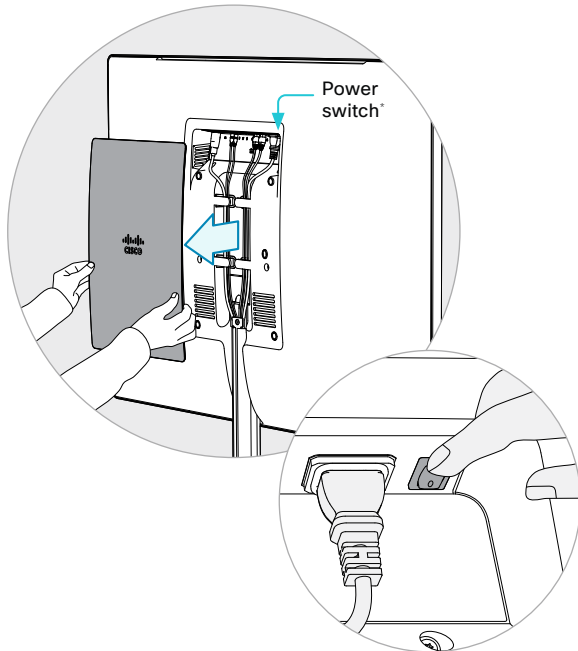

LED behavior

System LED

The system LED is to the right of the camera. The normal LED color is white. A red light indicates hardware failure.

In idle mode (screens are awake):

LED is off.

In standby mode (screens are off):

Steady light.

The device needs attention

(e.g. missed call or no network connection):

The LED repeatedly flashes twice.

During startup (boot):

The LED flashes. It turns steady when the device is ready for use.

Camera LED

The camera LED is just above the camera lens.

Incoming call:

The LED flashes.

In call:

Steady light.

Selfview on:

Steady light.

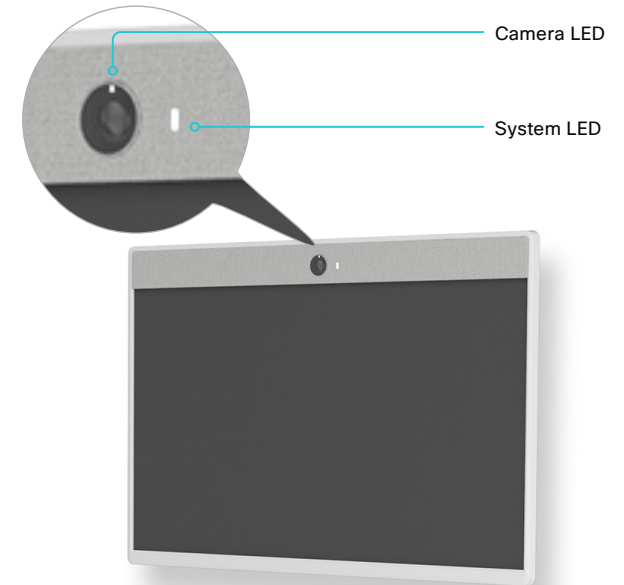

* Configuration changes might be lost if you shut down the device using the power switch or by unplugging it just a few seconds after saving the changes.

Board

Board Pro

Codec EQ

Codec Plus

Codec Pro

Desk, Desk Pro, DeskMini

Room Bar

Room Kit

Room Kit Mini

Room 55

Room 55 Dual, Room 70

Room 70 G2

Room 70 Panorama

Room Panorama

Power On/Off and LED behavior (page 4 of 9)

Room 70, Room 55 Dual, Room 70 G2, Room 70 Panorama

The power switch is behind the left side cover, in the same place for all mounting options.

To access the switch, remove the left side cover. It snaps in/out of place with magnets. The power switch is next to the main power connector below the codec.

(Room 70 G2, Room 70 Panorama) Also make sure that the codec power switch is on.

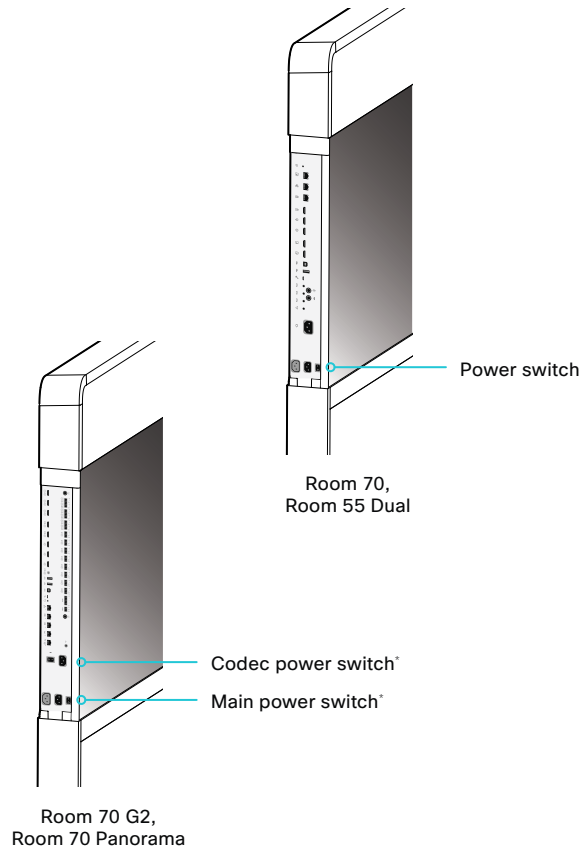

LED behavior

System LED

The system LED is behind the fabric to the right of the camera. The normal LED color is white. A red light indicates hardware failure.

In idle mode (screens are awake):
LED is off.

In standby mode (screens are off):
Steady light.

The device needs attention (e.g. missed call or no network connection):

The LED repeatedly flashes twice.

During startup (boot):

The LED flashes. It turns steady when the device is ready for use.

Camera LED

The camera LED is just above the camera lenses.

Incoming call:
The LED flashes.

In call:
Steady light.

Selfview on:
Steady light.

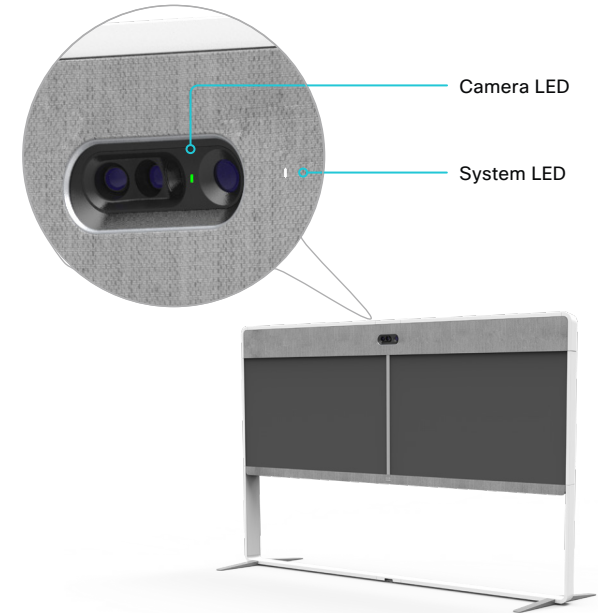

* Configuration changes might be lost if you shut down the device using the power switch just a few seconds after saving the changes.

- Board
- Board Pro
- Codec EQ
- Codec Plus
- Codec Pro
- Desk, Desk Pro, DeskMini
- Room Bar
- Room Kit
- Room Kit Mini
- Room 55
- Room 55 Dual, Room 70
- Room 70 G2
- Room 70 Panorama
- Room Panorama

Power On/Off and LED behavior (page 5 of 9)

Room Panorama (page 1 of 2)

Multiple components connected to wall sockets

Room Panorama consists of many components. Each component has a power cord that is connected directly to a wall socket.*

There are socket outlets on both sides of the system. Use the handles at the bottom of the deco grilles, and pull down the left and right screens to get access to all the outlets.

Only a few components have a power switch. To fully turn off power for the complete system, pull out the plugs from the wall socket outlets.

The codec power switch

The codec is behind the left screen. Using the handle at the bottom of the deco grille, pull down the left screen to get access to the codec.

- The power switch is set to On as part of the installation.

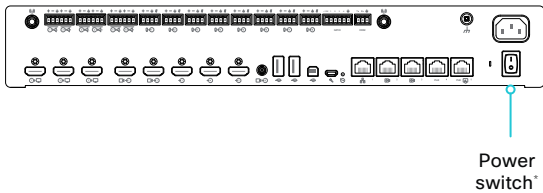

The camera power switch

The camera has a power switch that is set to On as part of the installation.

You don't have easy access to this switch when the system is assembled.

The 24V PSU power switch

This PSU is in the left cavity behind the left screen.

- Using the handle at the bottom of the deco grille, pull down the left screen to get access to the PSU.
- The power switch is set to On as part of the installation.

The screen power buttons

The screens should automatically power up when connected to power. If they don't, use the remote control or the power button to switch them on.

- Main screens: power button below the logo (lower right)
- Content screen: power button (lower center)

* Configuration changes might be lost if you shut down the device using the power switch just a few seconds after saving the changes.

- Board
- Board Pro
- Codec EQ
- Codec Plus
- Codec Pro
- Desk, Desk Pro, DeskMini
- Room Bar
- Room Kit
- Room Kit Mini
- Room 55
- Room 55 Dual, Room 70
- Room 70 G2
- Room 70 Panorama
- Room Panorama

Power On/Off and LED behavior (page 6 of 9)

Room Panorama (page 2 of 2)

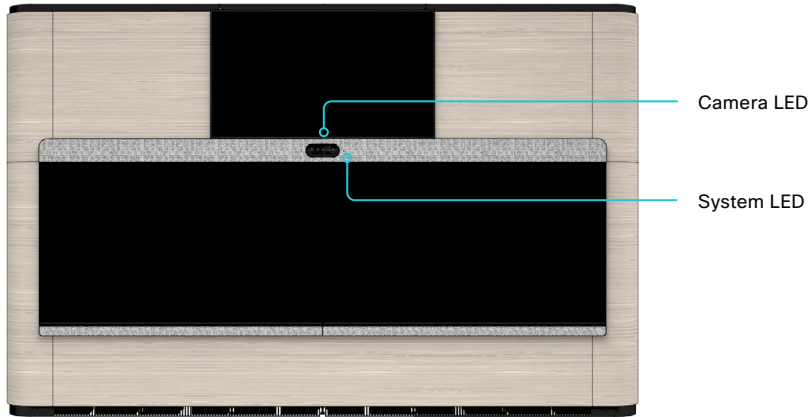

Pull down the left screen to see the amplifier and codec. Both units are mounted with the connector panel facing upward.

Amplifier: Cisco Natural Audio Module IV

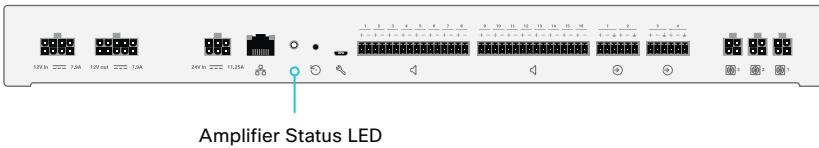

Codec: Cisco Webex Codec Pro

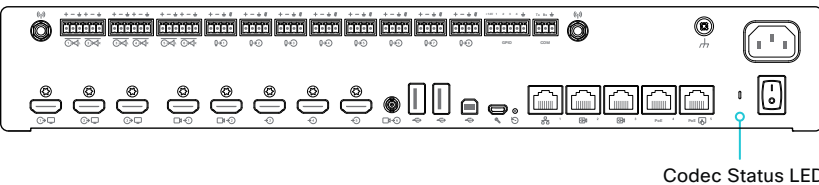

System LED

In idle mode (screens are awake):

LED is off.

In standby mode (screens are off):

Steady light.

During startup (boot):

The LED flashes. It turns steady when the codec is ready for use.

The LED goes off before the whole system (all peripherals) is ready for use.

Camera LED

Incoming call:

The LED flashes.

In call:

Steady light.

Selfview on:

Steady light.

Amplifier status LED

During startup (boot):

Steady light.

The device is not connected to a codec (un-paired):

Blinking fast.

The device is connected to a codec:

Steady light.

The codec is in standby mode:

Blinking slowly.

Codec Status LED

In idle mode (screens are awake):

Steady light.

In standby mode (screens are off):

Steady light.

The device needs attention (e.g. missed call or no network connection):

The LED repeatedly flashes twice.

During startup (boot):

The LED flashes. It turns steady when the device is ready for use.

Board

Board Pro

Codec EQ

Codec Plus

Codec Pro

Desk, Desk Pro, Desk Mini

Room Bar

Room Kit

Room Kit Mini

Room 55

Room 55 Dual, Room 70

Room 70 G2

Room 70 Panorama

Room Panorama

Power On/Off and LED behavior (page 7 of 9)

Desk, Desk Mini, and Desk Pro

The power button with LED indicator is on the back, as shown below.

To switch the device on, press the power button once. To switch it off, press the power button once. It takes at least 10 seconds before the device turns off.



LED behavior

System LED

In idle mode (screen is active):

The LED is off.

In standby mode (screen is off):

Steady light.

Missed call:

The LED is off in idle mode, but repeatedly flashes twice when in standby mode.

No network connection:

The LED repeatedly flashes twice.

During startup (boot):

The LED flashes.

Camera LED

The camera LED is on the top of the screen, just above the camera lens.

Incoming call:

The LED flashes.

In call:

Steady light.

Selfview on:

Steady light.

During startup (boot):

The LED is lit for a short while.

Microphone LED

In call, the microphone is on:

Steady green.

In call, the microphone is off:

Steady red.

* Configuration changes might be lost if you shut down the device using the power button just a few seconds after saving the changes.

Board

Board Pro

Codec EQ

Codec Plus

Codec Pro

Desk, Desk Pro, Desk Mini

Room Bar

Room Kit

Room Kit Mini

Room 55

Room 55 Dual, Room 70

Room 70 G2

Room 70 Panorama

Room Panorama

Power On/Off and LED behavior (page 8 of 9)

Webex Board Pro

There is no power button on the Webex Board Pro. Pull the plug to switch it off completely.



LED behavior

Camera LED

The camera LED is on the top of the screen, just above the camera lens.

Incoming call:

The LED flashes.

In call:

Steady light.

Selfview on:

Steady light.

During startup (boot):

The LED is lit for a short while.

Soft power button LED

In idle mode (screen is active):

The LED is off.

In standby mode (screen is off):

Steady light.

Board

Board
ProCodec
EQCodec
PlusCodec
ProDesk,
Desk Pro,
Desk MiniRoom
Bar

Room Kit

Room Kit
Mini

Room 55

Room 55
Dual,
Room 70Room 70
G2Room 70
PanoramaRoom
Panorama

Power On/Off and LED behavior (page 9 of 9)

Restart and standby using the user interface

Restart the device

1. Swipe in from the right or tap the controls icon  in the upper, right corner to open the control panel. Then select *Device settings*.*
2. Select *Restart*.
3. Select *Restart* again to confirm.

Enter standby mode

1. Swipe in from the right or tap the controls icon  in the upper, right corner to open the control panel.
2. Select *Standby*.

Exit standby mode

To exit standby mode, tap the touch screen of the device, or a connected touch controller.

Power Off or restart the device remotely

Sign in to the device web interface and navigate to *Backup and Recovery > Restart and Shutdown*.

Restart the device

Click *Restart* and confirm your choice.

It takes a few minutes before the device is ready for use.

Power Off the device

Click *Shutdown* and confirm your choice.



Shutting down the device will require physical presence to turn it on again.

To turn on the device after a remote shutdown:

- Disconnect the power plug and connect it again. (*Board and Board Pro*)
- Tilt the unit and turn the power switch Off and then On. You may have to readjust the unit/camera to get the best overview of the room after tilting it back. Alternatively, disconnect the power plug and connect it again. (*Room Bar, Room Kit, and Room Kit Mini*)
- Turn the power switch Off and then On. (*Codec EQ, Codec Plus, Codec Pro, Room 70 G2, Room 70, Room 55 Dual, Room Panorama, Room 70 Panorama, Desk, Desk Mini, and Desk Pro*)
- Turn the power switch Off and then On, or disconnect the power plug and plug it in again. (*Room 55*)

* For Room 70 Panorama and Room Panorama: Select the device name or address at the top of the user interface. Then select *Settings*.

Connector panel: Codec EQ

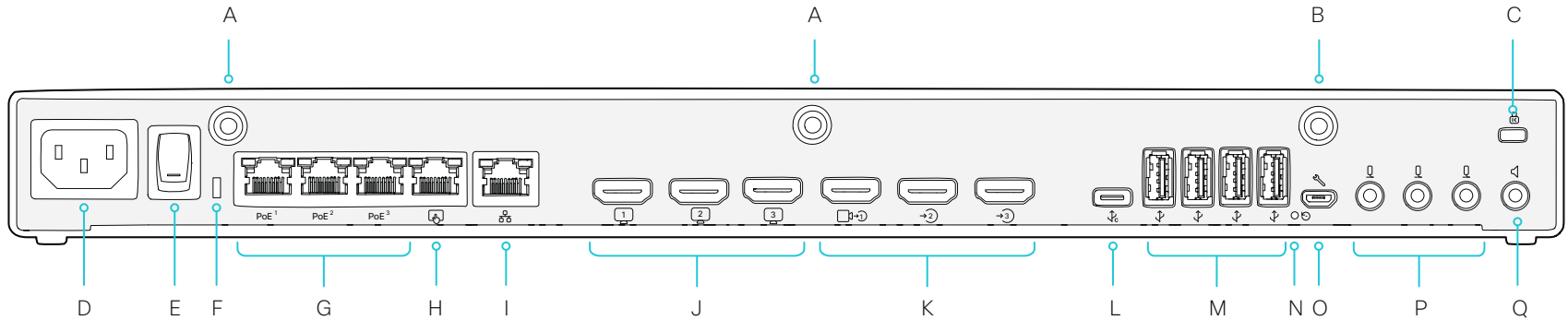

A. Wi-Fi antenna (RP-SMA connector)

- The codec is delivered with whip antennas. For best performance ensure free line of sight.

B. Bluetooth® antenna (RP-SMA connector)

- The codec is delivered with a whip antenna. For best performance ensure free line of sight.

C. Kensington lock

- To prevent the device from being moved and to prevent theft.

D. Power (100-240V_{AC}, 50-60Hz, 2.0-1.2A)

E. Power On/Off

F. Status LED

- Mirrors the front status LED.

G. Ethernet ports for internal network (RJ45)

- For camera control, digital microphones, and more.
- PoE++ (IEEE 802.3bt): Maximum 90W per port; and maximum 90W in total for these 3 ports (F) and the dedicated touch controller port (G).

H. Touch controller (RJ45)

- Dedicated PoE port for the touch controller.
- PoE++ (IEEE 802.3bt): Maximum 90W for this port; and maximum 90W in total for this port (G) and the three other PoE ports (F).

I. Network

- Ethernet interface, 10Mb / 100Mb / 1Gb Ethernet LAN interface (RJ45).

J. HDMI outputs, typically used for screens

- HDMI 2.0, resolutions up to 3840 × 2160 at 60 fps.
- Audio and video (audio is disabled if a Quad camera, which has loudspeakers, is connected to the HDMI 1 input).

K. HDMI inputs, typically used for cameras and other content sources

- In general, we recommend using HDMI 1 for the main camera. You must use HDMI 1 for Quad camera.
- HDMI 2.0. Resolutions up to 1920 × 1080 at 60 fps on HDMI 1, and up to 3840 × 2160 at 30 fps on HDMI 2 and 3.
- Content sharing.
- Supports HDCP (High-bandwidth Digital Content Protection) encrypted content on HDMI 3.

L. USB-C

- Supports formats up to 3840 × 2160 at 30 fps, using DisplayPort Alternate Mode.
- Content sharing.
- Use the camera, microphone and speakers with any software client (USB-camera mode).
- 3A charging capability.

M. USB 3.0 type A

- 1.5A charging capability per port.
- For loudspeakers, microphones, headset, DSPs, and future integrations.

N. Factory reset pinhole

- Use the pinhole as last resort. If possible, we recommend that you reset the device from the user interface or the device web interface.

O. Maintenance (micro USB)

- For serial communication with the device.

P. Analog microphones (3.5mm mini-jack, 4-pin connectors)

Q. Audio line output (3.5mm mini-jack, 3-pin connector)

- Analog line out (stereo).
- To be used with active loudspeakers (built-in amplifier).

Connector panel: Codec Plus

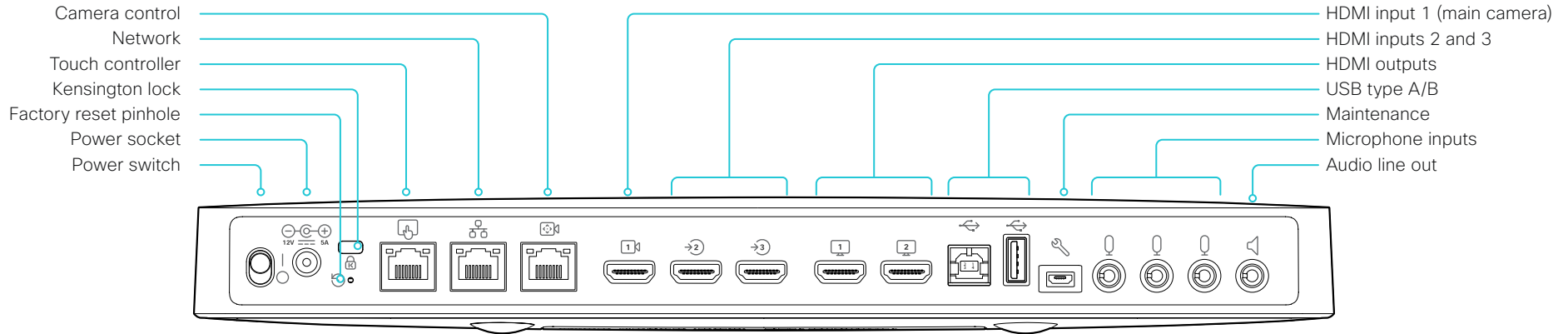

Power

Always use the provided power supply:

- DC output: 5A, 12 V
- AC input: 100-240V, 50-60Hz, max 1.2A

The device powers up automatically, as long as the power switch is in its On position.

Factory reset pinhole

Use the pinhole as last resort. If possible, we recommend that you reset the device from the user interface or the device web interface.

Kensington lock

The Kensington lock may be used to prevent the device from being moved and to prevent theft.

Touch controller

The touch controller is powered over Ethernet (PoE), which is provided through this socket.

Network

Ethernet interface, 10Mb/100Mb/1 Gb Ethernet LAN interface (RJ45).

HDMI inputs

HDMI 1: HDMI version 1.4b, resolutions up to 1920 × 1080 at 60fps. Most often used for the main camera. You must always use the HDMI 1 for a Quad camera.

HDMI 2 and 3: HDMI version 1.4b, resolutions up to 3840 × 2160 at 30fps / 1920 × 1080 at 60fps. Used for different types of input sources, like computers, cameras, or external playback devices (audio and video). You need a High Speed HDMI 1.4b cable to support the high resolutions and frame rates. We recommend a Cisco qualified presentation cable. The second HDMI input connector allows display of HDCP (High-bandwidth Digital Content Protection) encrypted content.

HDMI outputs

HDMI version 2.0, resolutions up to 3840 × 2160 at 60fps. Use output 1 for the main monitor and output 2 for the optional second monitor. You need Premium HDMI cables to support the high resolutions and frame rates. We recommend Cisco qualified display cables.

There is no audio on the HDMI outputs if the connected camera has loudspeakers (Quad Camera). Otherwise there is audio on Connector 1.

Camera control

Camera control (pan, tilt, zoom) for the camera. If you connect an extra camera you need an Ethernet switch to allow for camera control on both cameras.

USB

USB 2.0 type A/B.

Maintenance

Micro USB connector for serial communication with the device.

Microphones

Three 3.5 mm mini-jack, 4-pin connectors for external microphones: Cisco Table Microphone 20 or Cisco TelePresence Ceiling Microphone.

Audio line out

3.5 mm mini-jack, 3-pin connector. To be used with active loudspeakers (built-in amplifier).

Board

Board Pro

Codec EQ

Codec Plus

Codec Pro

Desk, Desk Pro, Desk Mini

Room Bar

Room Kit

Room Kit Mini

Room 55

Room 55 Dual, Room 70

Room 70 G2

Room 70 Panorama

Room Panorama

D15503.01

RoomOS 11.1

02-2023



Connector panel: Codec Pro and Room Panorama

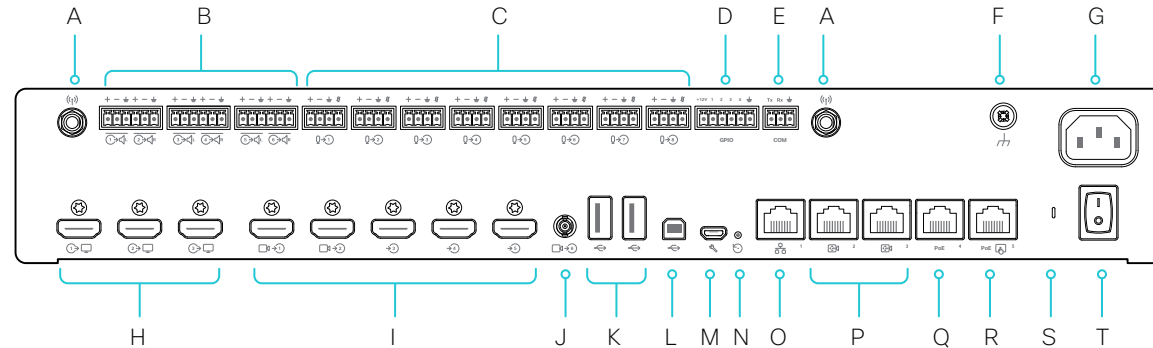

- A. Antenna connector (2)
2.4GHz and 5GHz antennas for use with wireless networks or Bluetooth® connections.
- B. Line outputs (6)
Balanced line level outputs. 3 or 6 pin Euroblock connectors.
- C. Microphone/line inputs (8)
8 microphones, 48V phantom powered, each with separate echo cancellers and noise reduction; all microphones can be set for balanced line level. 4 pin Euroblock connectors.
- D. Programmable GPIO port. 6 pin Euroblock connector.
- E. COM port. 3 pin Euroblock connector.
- F. Ground. Protective earth.
- G. Power (100-240V_{AC}, 50-60Hz, max 1.3 - 0.6 A)
- H. HDMI outputs (3)
Audio and video. HDMI version 2.0, resolutions up to 3840 × 2160 at 60 fps. Use Premium HDMI cables to support the high resolutions and frame rates. We recommend Cisco qualified display cables. There is no audio on the HDMI outputs if the connected camera has loudspeakers (Quad Camera). Otherwise, there is audio out from this connector.
- I. HDMI inputs (5)
Audio and video. HDMI version 1.4b, resolutions up to 3840 × 2160 at 30 fps / 1920 × 1080 at 60 fps. Use a High-Speed HDMI 1.4b cable to support the high resolutions and frame rates. We recommend a Cisco qualified presentation cable.
HDMI 1 and HDMI 2: Use as main camera inputs. Quad camera always connects to HDMI 1.
HDMI 3 to HDMI 5: Use for different types of input sources, like computers, cameras, or external playback devices (audio and video). HDMI 5 input connector allows display of HDCP (High-bandwidth Digital Content Protection) encrypted content.
- J. 3G-SDI/HD-SDI input
Video. Resolutions up to 1920 × 1080 at 60 fps.
HD-BNC: 1080p60, Level A 10-bit data native color encoding 4:2:2 YCbCr, 75 Ω.
- K. USB connectors (2), 2.0 type A
- L. USB connector, 2.0 type B
- M. Maintenance
Micro USB connector for serial communication with device.
- N. Factory reset pinhole
Use the pinhole as last resort. If possible, we recommend that you reset the device from the user interface or the device web interface.
- O. Network
RJ45: Ethernet interface, 1Gb Ethernet interface.
- P. Camera control (2)
RJ45: Camera control (pan, tilt, zoom). Connecting an extra camera requires an Ethernet switch for control on both cameras.
- Q. Ethernet PoE
RJ45: Internal network port for PoE devices.
- R. Touch controller
RJ45: Dedicated PoE port for the touch controller.
- S. Status LED
Mirrors the front status LED.
- T. Power On/Off
The device powers up automatically, as long as the power switch is in its On position.

HDMI 1: Main display
HDMI 2 and HDMI 3: Optional second and third display

Connector panel: Room Kit

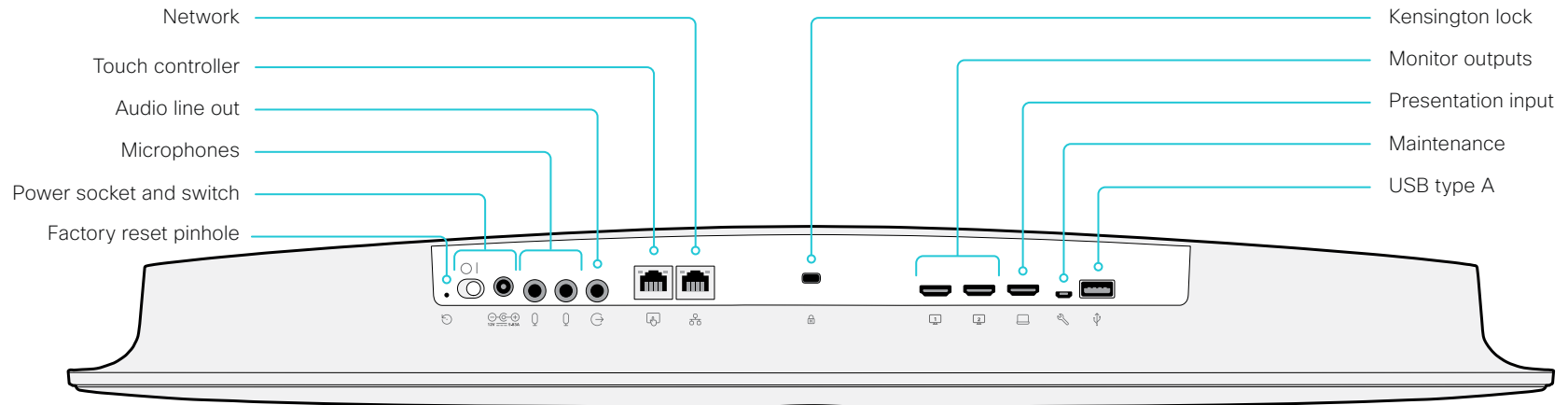

Network

Ethernet interface, 10Mb / 100Mb / 1Gb Ethernet LAN interface (RJ45).

Touch controller

The touch controller is powered over Ethernet, which is not provided through this socket. Therefore, you need a mid-span power injector between the touch controller and the video conferencing device, see the [Connect the touch controller](#) chapter for more details

Audio line out

3.5 mm mini-jack, 3-pin connector. To be used with active loudspeakers (built-in amplifier) or with a self-powered subwoofer (refer to the *Audio Output Line OutputType* setting).

Microphones

Two 3.5 mm mini-jack, 4-pin connectors for external microphones: Cisco Table Microphone 20 or Cisco TelePresence Ceiling Microphone.

Power

Always use the provided power supply:

- DC output: 5.83A, 12 V
- AC input: 100-240V, 50-60Hz, max 1.2 A

The device powers up automatically, as long as the power switch is in its On position.

Factory reset pinhole

Use the pinhole as a last resort. We recommend to perform a factory reset from the touch controller or the device web interface.

Monitor outputs

HDMI version 2.0, resolutions up to 3840 × 2160 at 60 fps. Use output 1 for the main monitor and output 2 for the optional second monitor. There is no audio on these outputs. You need Premium HDMI cables to support the high resolutions and frame rates. We recommend Cisco qualified display cables.

Presentation input

HDMI version 1.4b, resolutions up to 3840 × 2160 at 30 fps. Used for different types of input sources, like computers or external playback devices (audio and video). You need a High Speed HDMI 1.4b cable to support the high resolutions and frame rates. We recommend a Cisco qualified presentation cable.

Maintenance

Micro USB connector for serial communication with the device.

USB

USB 2.0 type A.

Kensington lock

The Kensington lock may be used to prevent the device from being moved and to prevent theft.

Board

Board Pro

Codec EQ

Codec Plus

Codec Pro

Desk, Desk Pro, DeskMini

Room Bar

Room Kit

Room Kit Mini

Room 55

Room 55 Dual, Room 70

Room 70 G2

Room 70 Panorama

Room Panorama

D15503.01
RoomOS 11.1
02-2023



Board

Board Pro

Codec EQ

Codec Plus

Codec Pro

Desk, Desk Pro, DeskMini

Room Bar

Room Kit

Room Kit Mini

Room 55

Room 55 Dual, Room 70

Room 70 G2

Room 70 Panorama

Room Panorama

Connector panel: Room Kit Mini

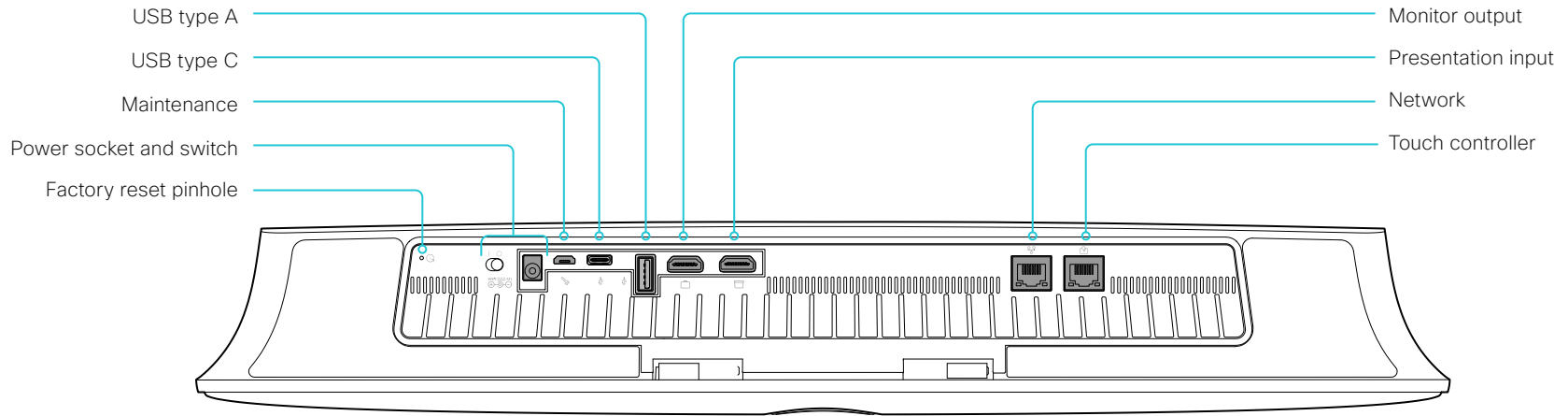

Factory reset pinhole

Use the pinhole as a last resort. We recommend to perform a factory reset from the touch user interface or the device web interface.

Power

Always use the provided power supply. The device powers up automatically, as long as the power switch is in its On position.

Maintenance

Micro USB connector for serial communication with the device.

USB

- USB 2.0 type A
- USB 2.0 type C

Monitor output

HDMI version 2.0, resolutions up to 3840 × 2160 at 60fps. There is no audio on the output. You need Premium HDMI cables to support the high resolutions and frame rates. We recommend Cisco qualified display cables.

Presentation input

HDMI version 1.4b, resolutions up to 3840 × 2160 at 30fps for computer. You need a High Speed HDMI 1.4b cable to support the high resolutions and frame rates. We recommend a Cisco qualified presentation cable.

Network

Ethernet interface, 10Mb / 100Mb / 1Gb Ethernet LAN interface (RJ45).

Touch controller

The touch controller is powered over Ethernet, which is provided through this socket.

Connector panel: Room Bar

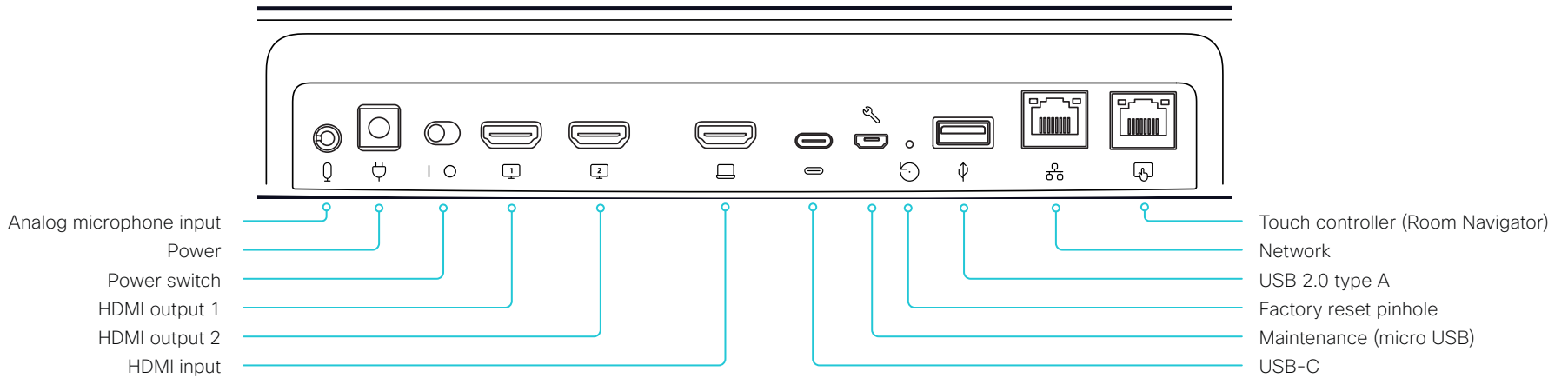

Analog microphone input

- 3.5 mm mini-jack, 4-pin connector for external microphone; for example Cisco Table Microphone or Cisco TelePresence Ceiling Microphone

Power

- Always use the provided power supply. The device powers up automatically, as long as the power switch is in its On position
- 100 to 240VAC, 50/60Hz, 12V DC input
- Power consumption:
 - Average: 20W
 - Peak: 86W

HDMI outputs

- Two HDMI 2.0 outputs supporting formats up to 3840 × 2160 at 60fps
- There is no audio on the outputs
- You need Premium HDMI cables to support the high resolutions and frame rates. We recommend Cisco qualified display cables

HDMI input

- HDMI 1.4 type A input
- Supports formats up to 3840 × 2160 at 30fps, including 1920 × 1080 at 60fps
- Content sharing and screen extension (external screen for computer)
- You need a High Speed HDMI 1.4b cable to support the high resolutions and frame rates. We recommend a Cisco qualified presentation cable

USB-C

- Supports formats up to 3840 × 2160 at 30fps, including 1920 × 1080 at 60fps, using DisplayPort Alternate Mode
- Content sharing and screen extension (external screen for computer)
- Ability to provide camera, microphone, and speakers over one USB-C cable to a connected computer (USB-C passthrough)

Maintenance - micro USB

- For serial communication with the device

Factory reset pinhole

- Use the pinhole as a last resort. If possible, we recommend that you reset the device from the user interface or the device web interface

Network

- Ethernet (RJ45) 100/1000Mbps for LAN (external network)

Touch controller - Room Navigator

- Ethernet (RJ45) 100/1000Mbps with PoE enabled for direct connection of a touch controller (Room Navigator)
- Room Navigator is powered over Ethernet

Board

Board Pro

Codec EQ

Codec Plus

Codec Pro

Desk, Desk Pro, DeskMini

Room Bar

Room Kit

Room Kit Mini

Room 55

Room 55 Dual, Room 70

Room 70 G2

Room 70 Panorama

Room Panorama

Connector panel: Room 55

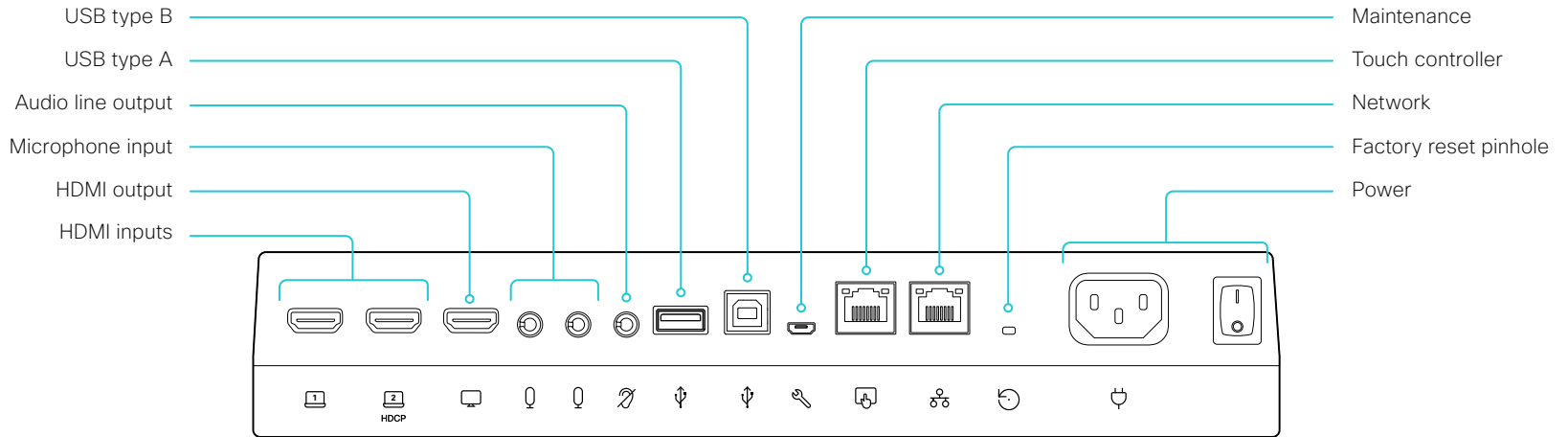

HDMI inputs

HDMI version 1.4b, resolutions up to 3840 × 2160 at 30fps. Used for different types of input sources, like computers, or external playback devices (audio and video). You need a High Speed HDMI 1.4b cable to support the high resolutions and frame rates. We recommend a Cisco qualified presentation cable.

The second HDMI input allows display of HDCP (High-bandwidth Digital Content Protection) encrypted content.

HDMI output

HDMI version 2.0, resolutions up to 3840 × 2160 at 60fps. Used for an optional second display (only video). You need Premium HDMI cables to support the high resolutions and frame rates. We recommend Cisco qualified display cables.

Microphones

Two 3.5 mm mini-jack, 4-pin connectors for external microphones: Cisco Table Microphone 20 or Cisco TelePresence Ceiling Microphone.

Audio line out

3.5 mm mini-jack, 3-pin connector. For example to be used with an audio induction loop system.

USB

- USB 2.0 type A
- USB 2.0 type B

Maintenance

Micro USB connector for serial communication with the device.

Touch controller

The touch controller is powered over Ethernet, which is provided through this socket. See the ► [Connect the touch controller](#) chapter for more details.

Network

Ethernet interface, 10Mb / 100Mb / 1Gb Ethernet LAN interface (RJ45).

Factory reset pinhole

Use the pinhole as a last resort. We recommend to perform a factory reset from the touch controller or the device web interface.

Power

100-240VAC, 1.8-0.8A, 50/60Hz
The device powers up automatically, as long as the power switch is in its On position.

Connector panel: Room 55 Dual and Room 70

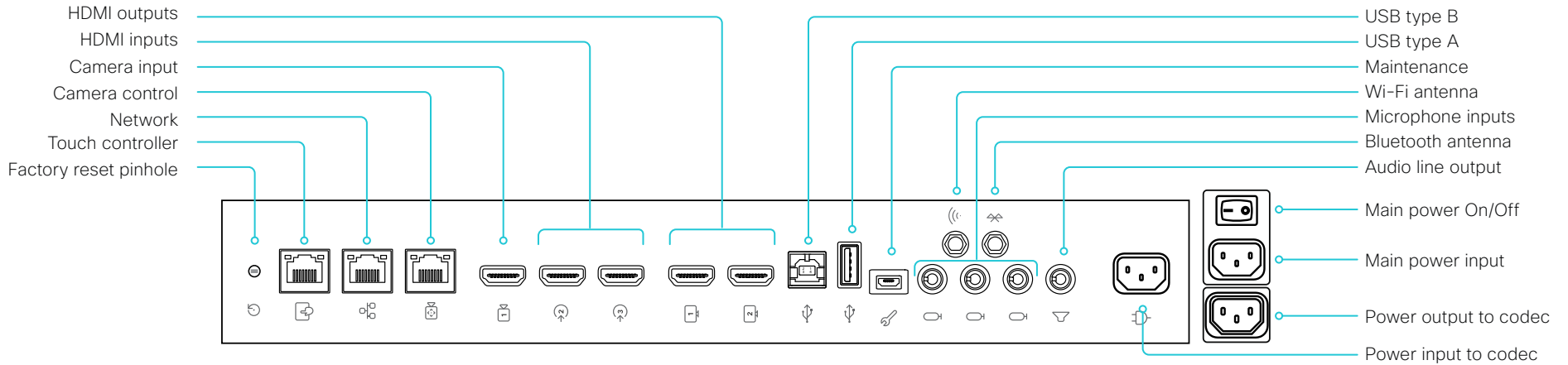

Factory reset pinhole

Use the pinhole as last resort. If possible, we recommend that you reset the device from the user interface or the device web interface.

Touch controller

The touch controller is powered over Ethernet (PoE), which is provided through this socket.

Network

Ethernet interface, 10 Mb / 100 Mb / 1 Gb Ethernet LAN interface (RJ45).

Camera control

Camera control (pan, tilt, zoom) for the integrated camera.

Camera input

This HDMI input is reserved for the integrated camera.

HDMI inputs with audio

HDMI version 1.4b, resolutions up to 3840 × 2160 at 30 fps. For computer, extra camera, or external playback devices. You need a High Speed HDMI 1.4b cable to support the high resolutions and frame rates. We recommend a Cisco qualified presentation cable. The second HDMI input connector allows display of HDCP (High-bandwidth Digital Content Protection) encrypted content.

HDMI outputs with 4K resolution

HDMI version 2.0, resolutions up to 3840 × 2160 at 60 fps. Output 1 is reserved for the internal screen for single screen devices. Both outputs are reserved for the internal screens for dual screen devices. You need Premium HDMI cables to support the high resolutions and frame rates. We recommend Cisco qualified display cables. There is no audio on HDMI output connector 2 on a single screen device.

Audio line output

3.5 mm mini-jack, 3-pin connector.

Microphones

Three 3.5 mm mini-jack, 4-pin connectors for external microphones: Cisco Table Microphone 20 or Cisco TelePresence Ceiling Microphone.

USB connectors

- USB 2.0 type B
- USB 2.0 type A, reserved for internal use
- Micro USB socket for maintenance

Antenna connectors

- Wi-Fi antenna for wireless network connection
- Bluetooth antenna (for future use)

Power

- Reserved for power input to codec
- Reserved for power output to codec
- Main power input (100-240 VAC, 3.5-2.0 A, 50/60 Hz)
- Main power On/Off

Board

Board Pro

Codec EQ

Codec Plus

Codec Pro

Desk, Desk Pro, DeskMini

Room Bar

Room Kit

Room Kit Mini

Room 55

Room 55 Dual, Room 70

Room 70 G2

Room 70 Panorama

Room Panorama

D15503.01

RoomOS 11.1

02-2023

CISCO

- Board
- Board Pro
- Codec EQ
- Codec Plus
- Codec Pro
- Desk, Desk Pro, DeskMini
- Room Bar
- Room Kit
- Room Kit Mini
- Room 55
- Room 55 Dual, Room 70
- Room 70 G2
- Room 70 Panorama
- Room Panorama

Connector panel: Room 70 G2 and Room 70 Panorama

- | | |
|---|---|
| <p>A. Antenna connector (2)
2.4GHz and 5GHz antennas for use with wireless networks or Bluetooth connections.</p> <p>B. Line outputs (6)
Balanced line level outputs. Euroblock, 3.5 mm.</p> <p>C. Microphone/line inputs (8)
8 microphones, 48V phantom powered, each with separate echo cancellers and noise reduction; all microphones can be set for balanced line level. Euroblock, 3.5 mm..</p> <p>D. Programmable GPIO port. 3.5 mm Euroblock connector.</p> <p>E. COM port. 3.5 mm Euroblock connector.</p> <p>F. Antenna connector, see A</p> <p>G. Ground. Protective earth.</p> <p>H. Power input
Power input to codec and power on/off switch.</p> <p>I. Main power input
Main power input (100-240 VAC, 5.5-2.5 A, 50/60 Hz) and power on/off switch.</p> <p>J. HDMI outputs (2).
Audio and video. Connectors 1 and 2, 4Kp60.</p> <p>K. HDMI output (1)
Audio and video. Connector 3, 4Kp30.</p> <p>L. Camera inputs (2)
HDMI, connector 1-2, 1080p60.</p> <p>M. HDMI inputs (3)
Audio and video. Connector 3-5, 4Kp30. Connector 5 supports HDCP.</p> | <p>N. Camera input
3G-SDI/HD-SDI. Connector 6, 1080p60, Level A only, HD-BNC, 75Ω.</p> <p>O. USB connectors (2), 2.0 type A.</p> <p>P. USB connector, 2.0 type B.</p> <p>Q. Maintenance
Micro USB connector for serial communication with device.</p> <p>R. Factory reset pinhole
Use the pinhole as last resort. If possible, we recommend that you reset the device from the user interface or the device web interface.</p> <p>S. Network
RJ45: Ethernet interface, 1Gb Ethernet interface.</p> <p>T. Camera control (2)
RJ45: Camera control (pan, tilt, zoom). Connecting an extra camera requires an Ethernet switch for control on both cameras.</p> <p>U. Ethernet PoE
RJ45: Internal network port for PoE devices.</p> <p>V. Touch controller
RJ45: Dedicated PoE port for the touch controller.</p> <p>W. Status LED
Mirrors the front status LED.</p> <p>X. Power output
Codec power output.</p> |
|---|---|

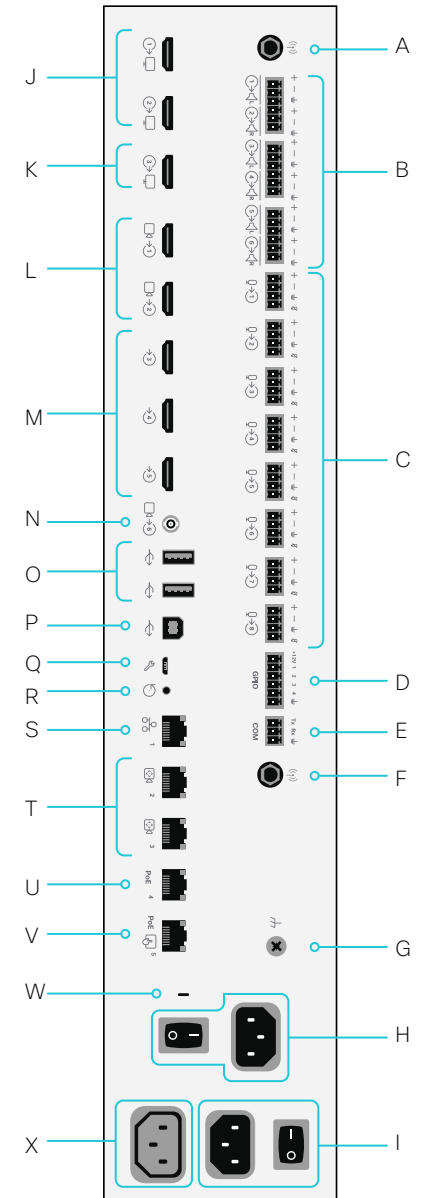

- Board
- Board Pro
- Codec EQ
- Codec Plus
- Codec Pro
- Desk, Desk Pro, Desk Mini
- Room Bar
- Room Kit
- Room Kit Mini
- Room 55
- Room 55 Dual, Room 70
- Room 70 G2
- Room 70 Panorama
- Room Panorama

Connector panel: Desk Mini

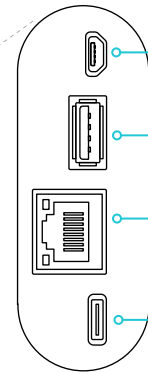
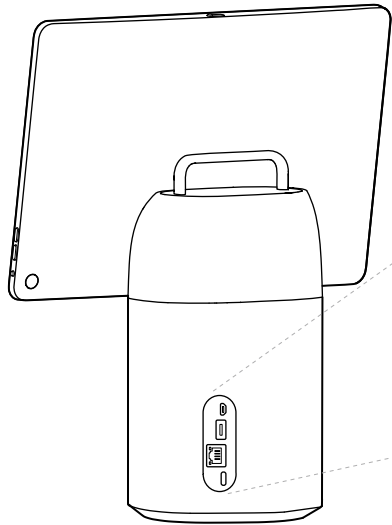

- Maintenance (micro USB)
 - For serial communication with the device
- USB 2.0 type A
- Network
 - Ethernet interface, 10 Mb / 100 Mb / 1 Gb Ethernet LAN interface (RJ45)
- USB-C
 - Supports formats up to 1920 × 1080 at 60 fps (1080p60), using DisplayPort Alternate Mode
 - Content sharing and screen extension (external screen for computer)
 - Touch forwarding capabilities on supported operating systems
 - Use the camera, microphone and speakers with any software client (USB-camera mode)

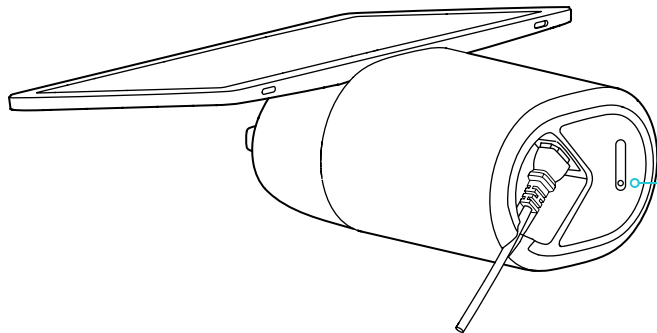

- Factory reset pinhole
 - Use the pinhole as last resort. If possible, we recommend that you reset the device from the user interface or the device web interface.

Board

Board Pro

Codec EQ

Codec Plus

Codec Pro

Desk, Desk Pro, Desk Mini

Room Bar

Room Kit

Room Kit Mini

Room 55

Room 55 Dual, Room 70

Room 70 G2

Room 70 Panorama

Room Panorama

D15503.01

RoomOS 11.1

02-2023



Connector panel: Desk and Desk Pro

1. USB

- USB 2.0 type A

2. Maintenance (micro USB)

- For serial communication with the device

3. HDMI out: for future use *(Only Desk Pro)*

4. Network for PC *(Only Desk Pro)*

- Ethernet interface, 10Mb / 100Mb / 1 Gb Ethernet LAN interface (RJ45)

5. Network

- Ethernet interface, 10Mb / 100Mb / 1 Gb Ethernet LAN interface (RJ45)

6. HDMI input

- HDMI 2.0 type A input. Supports formats up to:
 - 3840 × 2160 at 60fps (4kp60) *(Desk Pro)*
 - 1920 × 1080 at 60fps (1080p60) *(Desk)*
- Content sharing and screen extension (external screen for computer)

7. USB-C

- Supports formats up to the following, using DisplayPort Alternate Mode:
 - 3840 × 2160 at 60fps (4kp60) *(Desk Pro)*
 - 1920 × 1080 at 60fps (1080p60) *(Desk)*
- Content sharing and screen extension (external screen for computer)
- Touch forwarding capabilities on supported operating systems
- Use the camera, microphone and speakers with any software client (USB-camera mode)
- Laptop charging (60W maximum) *(Only Desk Pro)*

8. Power

- Rated:
 - 200W maximum *(Desk Pro)*
 - 70W maximum *(Desk)*
- Standby power consumption:
 - 15W; display off mode *(Desk Pro)*
 - 7.5 W; networked standby *(Desk)*

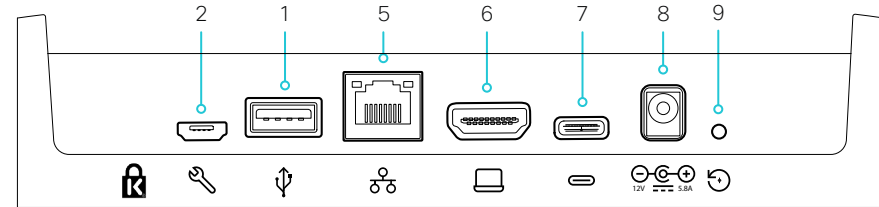

Main connector panel at the back
(Desk)

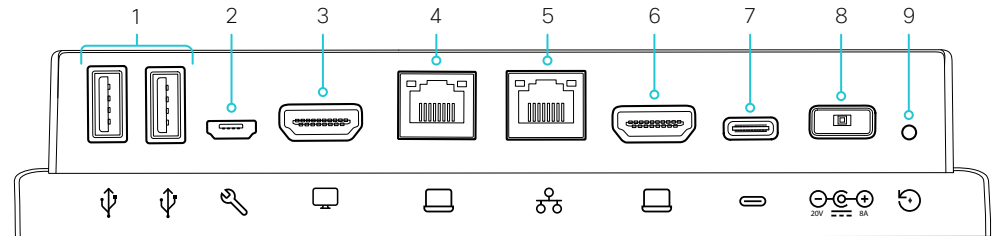

Main connector panel at the back
(Desk Pro)

9. Factory reset pinhole

- Use the pinhole as last resort. If possible, we recommend that you reset the device from the user interface or the device web interface.

A. Analog audio output *(Only Desk Pro)*

- 3.5 mm stereo mini-jack (3-pin)
- For headphones

B. USB, audio input and output *(Only Desk Pro)*

- USB 2.0 type A
- For USB headset

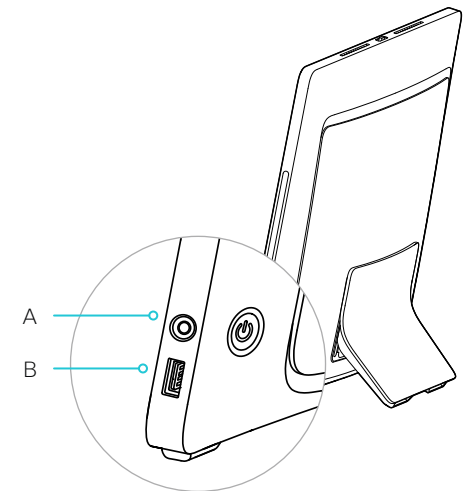

Audio connectors on the right side
(Desk Pro)

Connector panel: Board

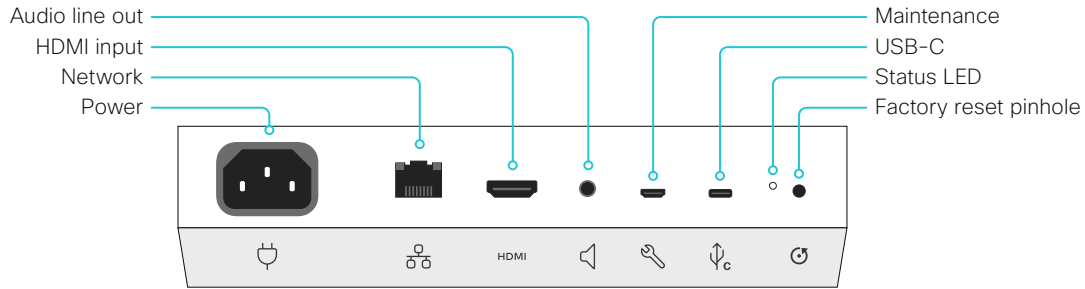

Board 55S, 70S, and 85S ¹

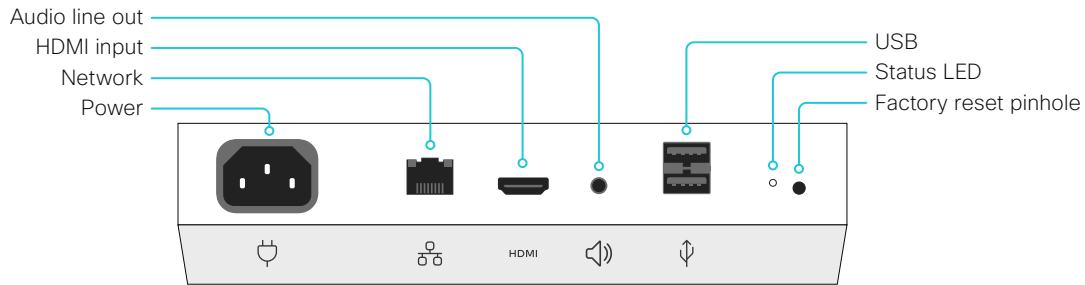

Board 55

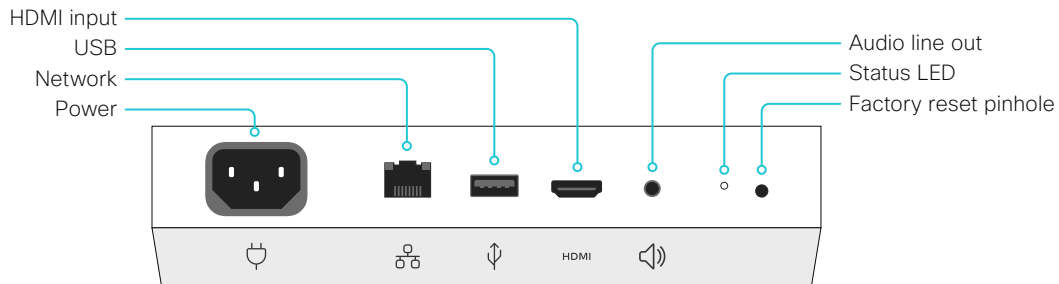

Board 70

Power

- Board 55S: 100-240 VAC, 3.0-1.5A, 50/60Hz
- Board 70S: 100-240 VAC, 3.5-2.0A, 50/60Hz
- Board 85S: 100-240 VAC, 4.6-2.0A, 50/60Hz
- Board 55, 70: 100-240 VAC, 3.5A max, 50/60Hz

Network

- Ethernet interface, 10 Mb/ 100 Mb/ 1 Gb Ethernet LAN interface (RJ45). ²

HDMI input

- HDMI version 1.4b, resolutions up to 3840 × 2160 at 30 fps. For computer or external playback devices. You need a High Speed HDMI 1.4b cable to support the high resolutions and frame rates. We recommend a Cisco qualified presentation cable.

Audio line output

- 3.5 mm mini-jack, 3-pin connector.

USB

- Board 55: Two USB 2.0 type A for maintenance
- Board 70: One USB 2.0 type A for maintenance
- Board 55S, 70S, and 85S: Micro USB for maintenance
- Board 55S, 70S, and 85S: USB-C

Factory reset pinhole

- Use the pinhole as last resort. If possible, we recommend that you reset the device from the user interface or the device web interface.

¹ The second generation Webex Board family (S Series) has some minor hardware platform optimizations.

² All models also support Wi-Fi.

Board

Board Pro

Codec EQ

Codec Plus

Codec Pro

Desk, Desk Pro, DeskMini

Room Bar

Room Kit

Room Kit Mini

Room 55

Room 55 Dual, Room 70

Room 70 G2

Room 70 Panorama

Room Panorama

Connector panel: Board Pro

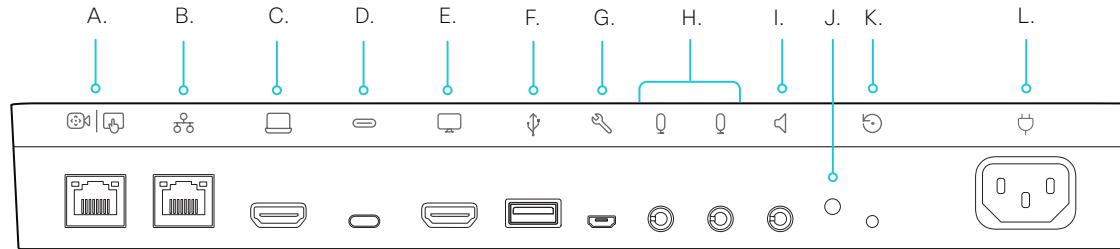

A. Touch controller

- RJ45: Dedicated PoE port for the touch controller.

B. Network

- Ethernet interface, 10Mb / 100Mb / 1Gb Ethernet LAN interface (RJ45)

C. HDMI input

- HDMI 2.0 type A input. Supports formats up to:
 - 3840 × 2160 at 30fps (4kp30)
- Content sharing and screen extension (external screen for computer)
- Supports HDCP (High-bandwidth Digital Content Protection) encrypted content.

D. USB-C

- Supports formats up to the following, using DisplayPort Alternate Mode:
 - 3840 × 2160 at 60fps (4kp60)
- Content sharing and screen extension (external screen for computer)
- Touch forwarding capabilities on supported operating systems
- Use the camera, microphone and speakers with any software client (USB-camera mode)
- Laptop charging (60W maximum)

E. HDMI out: for future use

F. USB

- USB 2.0 type A

G. Maintenance (micro USB)

- For serial communication with the device

H. Microphone inputs (3.5mm mini-jack)

- 2 analog microphone inputs

I. Audio line output (3.5mm mini-jack)

- Analog line out (stereo)

J. Status LED

K. Factory reset pinhole

- Use the pinhole as last resort. If possible, we recommend that you reset the device from the user interface or the device web interface.

L. Power

- Rated: 200W maximum
- Standby power consumption: 15W in display off mode

Connector panel: Room Panorama amplifier

The Cisco Natural Audio Module IV is an essential component of Room Panorama. It is a 16 channel audio power amplifier with Ethernet and analog inputs.

12V Power input and output

This is a passthrough current limited power connection for the Cisco Quad Camera in a Cisco Room Panorama system.

Factory reset

- Pinhole

Maintenance

- Micro USB

Fan outputs

There are three fan output ports to control the fans in a Cisco Room Panorama system.

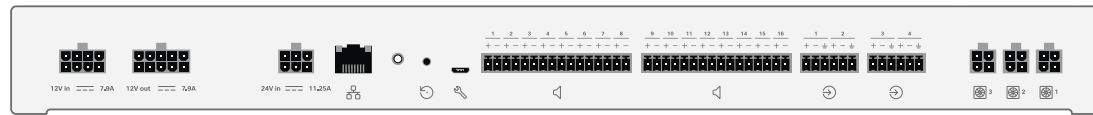

Amplifier power input

This is the DC power supply input for the amplifier.

- 24VDC, 11.25A

Ethernet

The Ethernet port is used for audio streaming from a Cisco Codec Pro and for control and software upgrades.

- 1000BASE-T

Speaker outputs

Each speaker output channel is a bridged/differential amplifier output. The + and - connections should be connected to a single speaker only, and not connected to another speaker output or to ground.

Bridged differential output on 3.5 mm Euroblock connectors.

- Max 25W / 8ohm at 0.1% THD per channel.
- < 0.1% THD at all levels below clipping.
- 106 dB SNR.
- Max 200W total output power.

Analog inputs / Line inputs

Each analog input is a differential analog line input. For best performance it should be connected to balanced analog line output signals. However it can be used with unbalanced sources, in that case the - terminal should be connected to ground.

Differential input on 3.5 mm Euroblock connectors.

- Max 24dBu input level.
- 106 dB SNR.

Board

Board Pro

Codec EQ

Codec Plus

Codec Pro

Desk, Desk Pro, Desk Mini

Room Bar

Room Kit

Room Kit Mini

Room 55

Room 55 Dual, Room 70

Room 70 G2

Room 70 Panorama

Room Panorama

Board

Board Pro

Codec EQ

Codec Plus

Codec Pro

Desk, Desk Pro, DeskMini

Room Bar

Room Kit

Room Kit Mini

Room 55

Room 55 Dual, Room 70

Room 70 G2

Room 70 Panorama

Room Panorama

Room Navigator physical interface

This touch controller was launched early 2021. It has the same functionality as the Touch 10, but also offers environmental sensors for monitoring things like air quality and temperature.

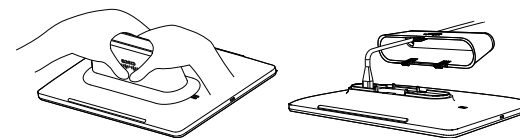
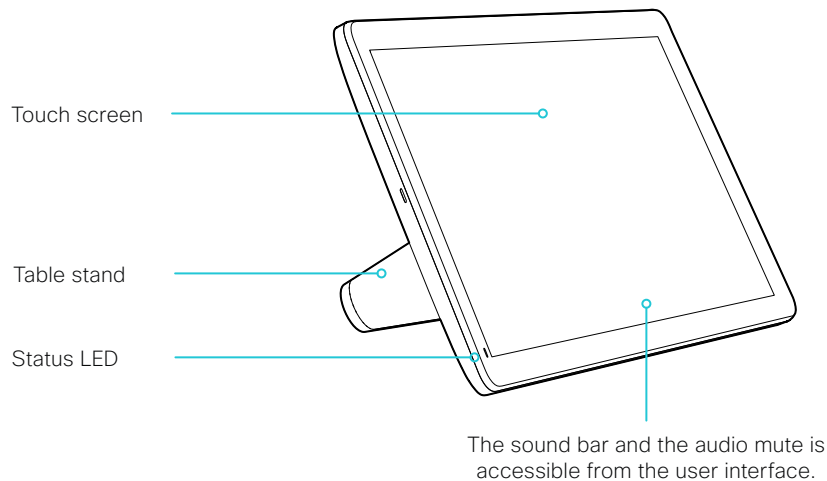

Remove the table stand to access the connector panel.
Press firmly and pivot.

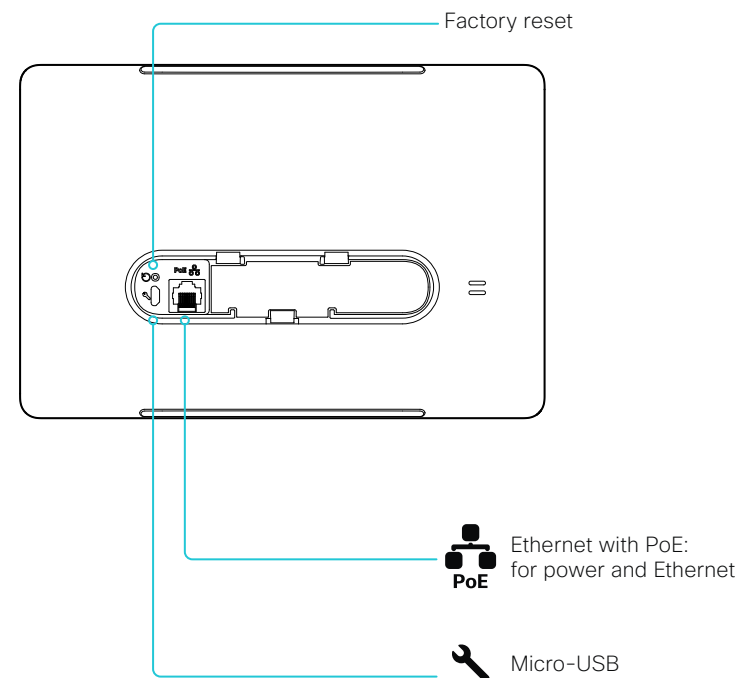

Board

Board Pro

Codec EQ

Codec Plus

Codec Pro

Desk, Desk Pro, Desk Mini

Room Bar

Room Kit

Room Kit Mini

Room 55

Room 55 Dual, Room 70

Room 70 G2

Room 70 Panorama

Room Panorama

Touch 10 physical interface

Cisco Touch 10

This is the second version of the Touch 10 controller (launched late 2017). It has the same functionality as the first version, but has a slightly different physical interface. The new device is identified by the logo on front, and fewer connectors at the back.

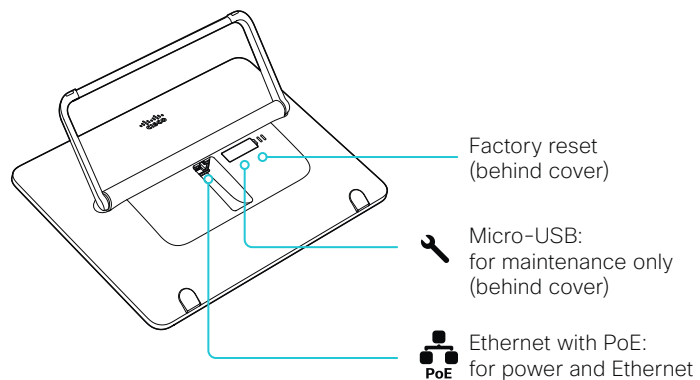
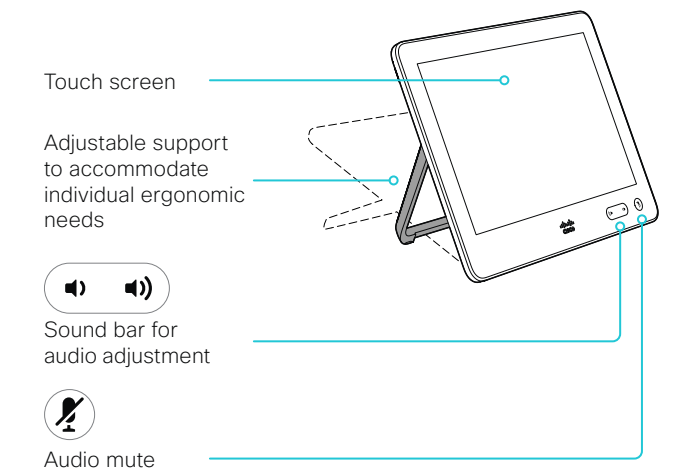

Cisco TelePresence Touch 10

This is the first version of the Touch 10 controller.

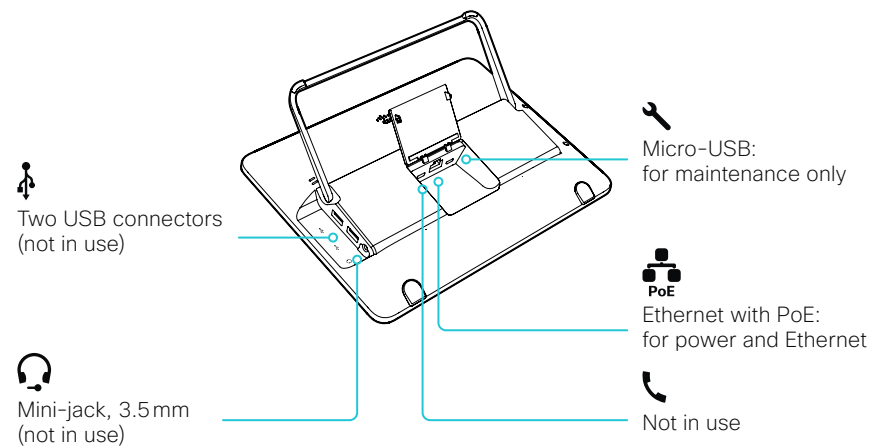
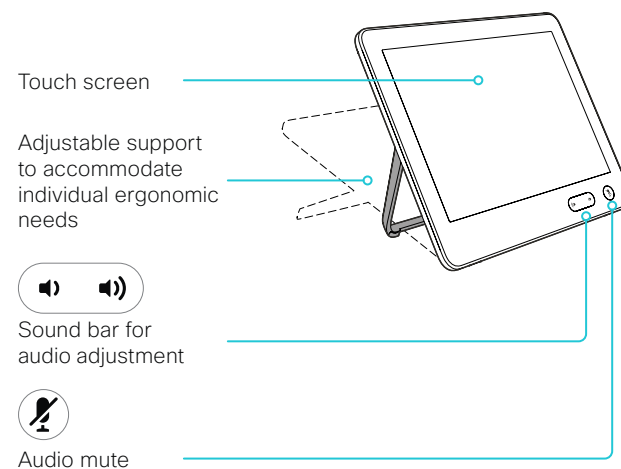

Board

Board
Pro

Codec
EQ

Codec
Plus

Codec
Pro

Desk,
Desk Pro,
Desk Mini

Room
Bar

Room Kit

Room Kit
Mini

Room 55

Room 55
Dual,
Room 70

Room 70
G2

Room 70
Panorama

Room
Panorama

Chapter 7

Appendices

Board

Board
ProCodec
EQCodec
PlusCodec
ProDesk,
Desk Pro,
Desk MiniRoom
Bar

Room Kit

Room Kit
Mini

Room 55

Room 55
Dual,
Room 70Room 70
G2Room 70
PanoramaRoom
Panorama

Call from laptop using the device as a web camera (page 1 of 4)

If you connect a laptop to the video conferencing device, you can use the device as an advanced web camera when making calls from laptop meeting apps¹.

In this mode you will make use of the following device resources:

- Camera, microphones, loudspeakers
- Screen - built-in or external, depending on product

From the laptop meeting app: You must select the video conferencing device as camera, microphone and loudspeaker source!

The setup and use of this feature varies because the different devices have different capabilities:

- *Devices with full USB-C support:*
 - Board Pro
 - Desk Pro, Desk, Desk Mini
 - Codec EQ
 - Room Bar
- *Devices with limited USB-C support:*
 - Room Kit Mini
- *Devices without USB-C support:*
 - Codec Plus, Codec Pro
 - Room Kit, Room 55
 - Room 70 Single, Room 70 G2 Single and Dual

Minimum requirements

Minimum USB version:

- USB 2.0

Minimum computer operating system:

- Windows 7
- OS X 10.6

In-call behavior

Muting audio

People can always mute their microphones from the laptop meeting app.

As an administrator, you can use these settings to decide whether people should be allowed to mute from the device (or a touch controller or external microphones that are connected to the device) as well.

- [Audio > Microphones > USBPassthrough > MuteButton](#)
- [Audio > Microphones > HDMIPassthrough > MuteButton](#)

Inactive: People can't mute from the device (default behavior for Desk series)

Active: People can mute from the device (default behavior for other products)

The device and meeting app mute indicators are not synchronized. This has some side effects:

- If people mute themselves from the laptop meeting app, the microphone LEDs of the device, touch controller, and external microphones don't change to the mute color.
- If people mute themselves from the device, touch controller, or external microphones, the other participants in the call will not be notified that they are muted.
- If people forget to select the device as microphone source for the app, the app will use the laptop microphones. In such a case the microphone LEDs of the device, touch controller, and external microphones may be red (mute color), while the audio is **not** muted.

Other things to do from the device

You can do the following from the device UI:

- Control the camera. Note that the camera LED is on when the camera is in use.
- Adjust the volume.
- Remove background noise and optimize the audio quality.

Other things to do from the laptop meeting app

The laptop app must use the video conferencing device as camera, microphone and loudspeaker source.

The laptop meeting app controls all the in-call features that are not controlled by the device UI. This includes disconnecting the call.

Devices without USB-C support:

- You also have to stop the *Call from laptop* app on the device itself.

Do not disturb mode

In general, the device itself is put in *Do not disturb* mode when you are in a meeting from a laptop. Hence, you won't receive any incoming calls to the device during the meeting.

Devices with full USB-C support:

- The device will not be in *Do not disturb* mode when in audio-only meetings.

Devices without USB-C support:

- The device will stay in *Do not disturb* mode as long as the *Call from laptop* app is active on the device, even if minimized.

¹ For example Microsoft Teams, Skype for business, Slack, or Zoom. Cisco successfully tested these clients before product launch. Compatibility between different software versions will not be tested regularly.

Board

Board
ProCodec
EQCodec
PlusCodec
ProDesk,
Desk Pro,
Desk MiniRoom
Bar

Room Kit

Room Kit
Mini

Room 55

Room
55 Dual,
Room 70Room 70
G2Room 70
PanoramaRoom
Panorama

Call from laptop using the device as a web camera (page 2 of 4)

Devices with full USB-C support

Applies to: Board Pro, Desk Pro, Desk, Desk Mini, Codec EQ, and Room Bar

Devices in this category have a USB-C connector, and you can share content from a laptop to the device on the USB-C connection.

The device supports up to 1080p video in this mode.

As an administrator, you don't have to do any special configuration to set up and use the device as a web camera. As described in the [In-call behavior](#) section, you can do some customizations regarding mute.

You don't have to register the device to a call service (cloud or on-premises) if you are going to use it only for laptop calling. If you skip registration at first-time setup, you can go back and register the device with Cisco later. Open the control panel, go to [Device settings](#), and select [Device activation](#).

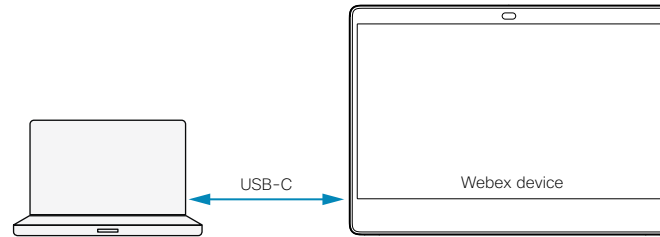

USB-C:

- Video and audio from the camera and microphone of the video device to the computer client.
- Video and audio from the computer client (far end) to the speakers and screen of the video device.

Board

Board
ProCodec
EQCodec
PlusCodec
ProDesk,
Desk Pro,
Desk MiniRoom
Bar

Room Kit

Room Kit
Mini

Room 55

Room
55 Dual,
Room 70Room 70
G2Room 70
PanoramaRoom
Panorama

Call from laptop using the device as a web camera (page 3 of 4)

Devices with limited USB-C support

Applies to: Room Kit Mini

This device has a USB-C connector, but you cannot share content from a laptop to the device on the USB-C connection. To support content sharing, you must also connect an HDMI cable.

The device supports up to 1080p video when used as a web camera.

As an administrator, you don't have to do any special configuration to set up and use the device as a web camera. As described in the [In-call behavior](#) section, you can do some customizations regarding mute.

You don't have to register the device to a call service (cloud or on-premises) if you are going to use it only for laptop calling. If you skip registration at first-time setup, you can go back and register the device with Cisco later. Open the control panel, go to [Device settings](#), and select [Device activation](#).

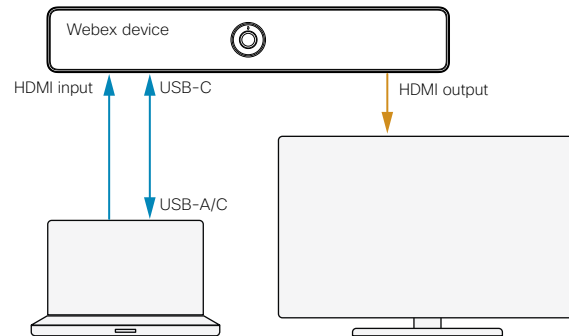

USB-C:

- Video and audio from the camera and microphone of the video conferencing device to the computer client.
- Audio from computer client to the loudspeakers of the video conferencing device.

HDMI-in and HDMI-out:

- Video from the computer client (far end), via the video conferencing device, to the screen.

Board

Board Pro

Codec EQ

Codec Plus

Codec Pro

Desk, Desk Pro, DeskMini

Room Bar

Room Kit

Room Kit Mini

Room 55

Room 55 Dual, Room 70

Room 70 G2

Room 70 Panorama

Room Panorama

D15503.01
RoomOS 11.1
02-2023



Call from laptop using the device as a web camera (page 4 of 4)

Devices without USB-C support

Applies to: Codec Plus, Codec Pro, Room Kit, Room 55, Room 70 Single, Room 70 G2 Single, and Room 70 G2 Dual

The devices in this category don't have a USB-C connector, so you need an HDMI-to-USB converter (also known as capturing device) between the laptop and the device, see illustration. Apart from that, connect device peripherals as usual.

Set up the feature, also known as HDMI Passthrough, as follows:

1. Connect the HDMI-to-USB converter to one of the device's HDMI outputs as shown in the illustration.^{1,2}
2. Set *Video > Output > HDMI > Passthrough > Allowed* to **True** to enable the feature.
3. By default, the device is set up to use the HDMI output with the highest number for the HDMI-to-USB converter. Use the *Video > Output > HDMI > Passthrough > OutputConnector* setting if you want to change to another HDMI output. If so, also check that the monitor roles are set correctly on the output connectors, *Video > Output > Connector [n] > MonitorRole*.
4. If you have an HDMI-to-USB converter with external power supply, and with no screen connected to it, you must manually set how many screens the device has. Use the *Video > Monitors* setting. A mismatch gives layout issues when joining meetings from the device itself.
5. Set *Audio > Microphones > HDMIPassthrough > MuteButton* to **Inactive** if you don't want to allow people to mute audio from the device's touch controller or external microphones. Read about mute in the *In-call behavior* section.
6. Decide whether the device shall automatically disconnect the *Call from laptop* app after 120 minutes. Read more details in the side bar.

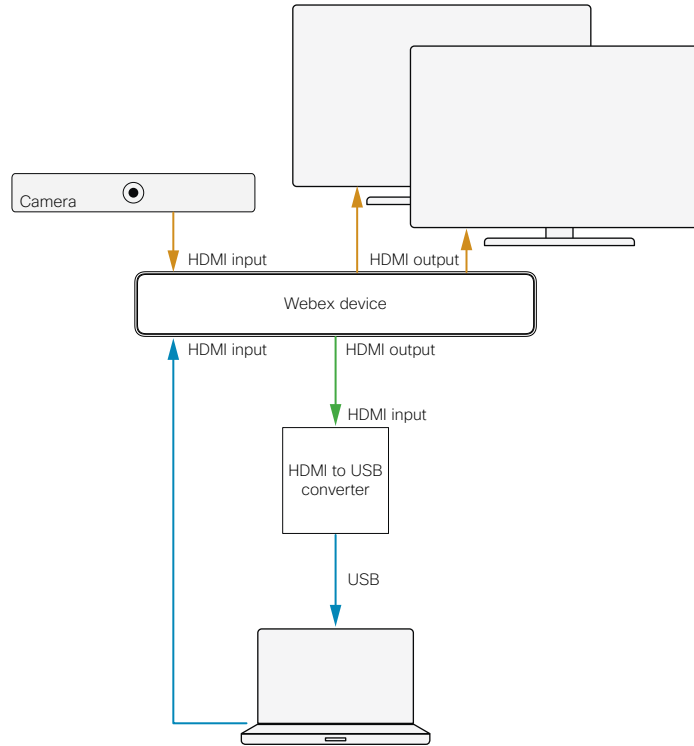

HDMI/USB (to client):

- Video and audio from the device's camera and microphones to the computer client via the HDMI-to-USB converter.

HDMI (from client):

- Video from the computer client (far end), to the device's screen.
- Audio from the computer client (far end) to the device's loudspeakers.

¹ Room 55 Dual, Room 70 Dual, Room 70 Panorama, and Room Panorama don't have a spare HDMI output for the HDMI-to-USB converter, hence these devices don't support the *Call from laptop* feature.

² We have tested and recommend the Inogeni 4KX-PLUS converter; you may use others.

Close the *Call from laptop* app

You always disconnect the call from the laptop meeting app. But, on these devices, you also have to close the *Call from laptop* app on the device itself. Until it's closed, the device will stay in *Do not disturb* mode.

If not closed manually, the default behavior is that the app closes automatically after 120 minutes.

Use these settings to change from the default behavior:

- *Video > Output > HDMI > Passthrough > AutoDisconnect > Enabled*: **True/False**
- *Video > Output > HDMI > Passthrough > AutoDisconnect > Delay*: number of minutes before disconnecting

Advanced audio setups for Codec Pro and Room 70 G2

We recommend you keep the *Audio > Output > ConnectorSetup* configuration at **Auto**.

If your room setup requires it to be **Manual**, use the Audio Console (recommended) or API commands to set up microphone passthrough manually.

- Board
- Board Pro
- Codec EQ
- Codec Plus
- Codec Pro
- Desk, Desk Pro, DeskMini
- Room Bar
- Room Kit
- Room Kit Mini
- Room 55
- Room 55 Dual, Room 70
- Room 70 G2
- Room 70 Panorama
- Room Panorama

Panoramic video

In Panoramic video we are using two of the camera's telelenses simultaneously to create a wide camera view.

Panoramic video is *always* used in the supported scenarios. It's not a feature that you can switch off, neither permanently nor temporarily.

Supported scenarios

Panoramic video is used in the following scenarios:

- Point-to-point calls between two devices that support Panoramic video
- CMS meeting between two devices that support Panoramic video

More scenarios will be available in later software releases.

Devices that support Panoramic video

- Room Panorama
- Room 70 Panorama



Video captured by the right telelense



Video captured by the left telelense

Video from the camera's right and left telelenses are stitched together to create the wide panorama view.

Board

Board
ProCodec
EQCodec
PlusCodec
ProDesk,
Desk Pro,
Desk MiniRoom
Bar

Room Kit

Room Kit
Mini

Room 55

Room 55
Dual,
Room 70Room 70
G2Room 70
PanoramaRoom
Panorama

Set up remote monitoring

Requirement:

- *RemoteMonitoring* option

Remote monitoring is useful when you want to control the device from another location.

Snapshots from input sources appear in the device web interface, so you can check the camera view and control the camera without being in the room.

If enabled, snapshots are refreshed automatically approximately every 5 seconds.

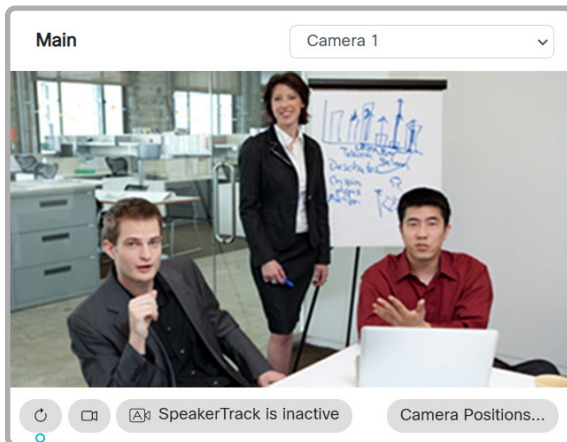

Automatically refresh snapshots

Check whether or not the device has the *RemoteMonitoring* option

1. Sign in to the device web interface, go to [Software](#), and select [Option Keys](#).
2. Check if *RemoteMonitoring* is marked as **Active** on the list of *Installed Option Keys*.
If not, remote monitoring is not available.

Enable remote monitoring

Install the *RemoteMonitoring* option key. How to install option keys is described in the [Add option keys](#) chapter.

PLEASE BE AWARE THAT IF YOU ENABLE THE REMOTE MONITORING OPTION YOU MUST MAKE SURE THAT YOU COMPLY WITH LOCAL LAWS AND REGULATIONS WITH REGARD TO PRIVACY AND PROVIDE ADEQUATE NOTICE TO USERS OF THE DEVICE THAT THE SYSTEM ADMINISTRATOR MAY MONITOR AND CONTROL THE CAMERA AND SCREEN. IT IS YOUR RESPONSIBILITY TO COMPLY WITH PRIVACY REGULATIONS WHEN USING THE DEVICE AND CISCO DISCLAIMS ALL LIABILITY FOR ANY UNLAWFUL USE OF THIS FEATURE.

About snapshots

Local input sources

Snapshots of the local input sources of the device appear on the Call Control page.

Snapshots appear both when the device is idle, and when in a call.

Far end snapshots

When in call, you may also see snapshots from the far end camera. It does not matter whether or not the far end device has the *RemoteMonitoring* option.

Far end snapshots are not displayed if the call is encrypted.

Board

Board Pro

Codec EQ

Codec Plus

Codec Pro

Desk, Desk Pro, Desk Mini

Room Bar

Room Kit

Room Kit Mini

Room 55

Room 55 Dual, Room 70

Room 70 G2

Room 70 Panorama

Room Panorama

Access call information and answer a call while using the device web interface

A green banner at the top of the web page is present to notify you about an incoming call, and to show when the device is in a call.

If the device is idle, there is no green banner.

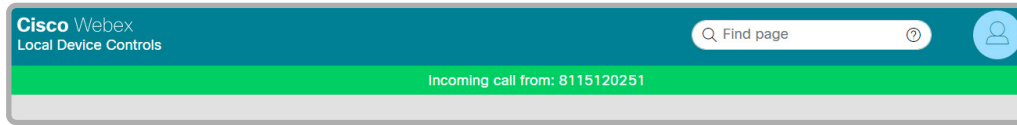





Notification of an incoming call

Click the *green banner* to open the *Call* page, where you can accept or decline the call.

Control the call

Relevant control buttons are present on the *Call* page. Use the buttons to:

-  Show call details
-  Put the call on hold
-  Answer the call
-  Disconnect the call

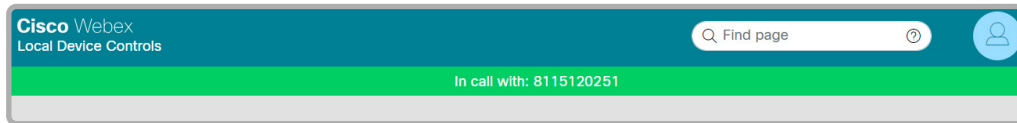

The device is in a call

The *green banner* shows if the device is in a call. It will also show if the device has multiple active calls.

Board

Board Pro

Codec EQ

Codec Plus

Codec Pro

Desk, Desk Pro, Desk Mini

Room Bar

Room Kit

Room Kit Mini

Room 55

Room 55 Dual, Room 70

Room 70 G2

Room 70 Panorama

Room Panorama

Place a call using the device web interface (page 1 of 2)

Sign in to the device web interface and go to [Call](#).

Place a call

i Even if the device web interface is used to initiate the call, it is the video conferencing device (display, microphones and loudspeakers) that is used for the call; it is not the PC running the web interface.

1. Navigate the *Favorites*, *Directory* or *Recents* lists to find the correct entry; or enter one or more characters in the *Search* or *Dial* field*. Click the correct contact name.
2. Click [Call](#) in the contact card.

Alternatively, enter the complete URI or number in the *Search* and *Dial* field. Then click the [Call](#) button that appears next to the URI or number.

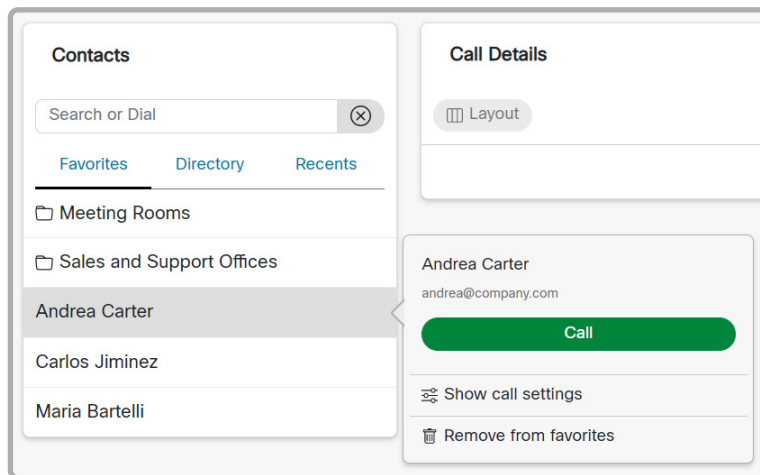

Send DTMF tones

Click to open a key pad that you can use if your application requires DTMF (dual-tone multi-frequency) signaling.

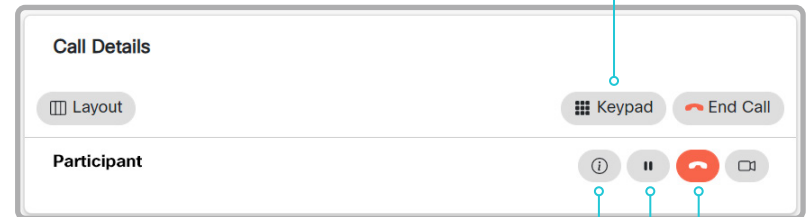

Show/hide call details

Click the information button to show details about the call.
Click the button again to hide the information.

Hold and resume a call

Use the **||** button next to a participant's name to put that participant on hold.
To resume the call, use the **▶** button that is present when a participant is on hold.

End a call

If you want to terminate a call or conference, click [End Call](#). Confirm your choice in the dialog that appears.

To disconnect just one participant in a conference, click the **⏏** button for that participant.

* When searching, matching entries from the *Favorites*, *Directory* and *Recents* lists will be shown as you type.

Board

Board Pro

Codec EQ

Codec Plus

Codec Pro

Desk, Desk Pro, Desk Mini

Room Bar

Room Kit

Room Kit Mini

Room 55

Room 55 Dual, Room 70

Room 70 G2

Room 70 Panorama

Room Panorama

Place a call using the device web interface (page 2 of 2)

Sign in to the device web interface and go to [Call](#).

Calling more than one

A point-to-point video call (a call involving two parties only) can be expanded to include one more participant on audio-only*.

If your device is using the optional built-in MultiSite feature, up to four or five participants, yourself included, can join the video call (conference), see the table.

Video conferencing device	Maximum number of participants in a MultiSite call
Board, Codec Plus, Room Kit, Room Kit Mini, Room 55, Room 55 Dual, Room 70	4
Board Pro, Codec EQ, Codec Pro, Desk, Desk Mini, Desk Pro, Room Bar, Room 70 G2, Room 70 Panorama, Room Panorama	5

Follow the same procedure to call the next conference participant as you did when calling the first participant.

Adjust the volume

Mute the microphone

Click [Microphone: On](#) to mute the microphone. Then the text changes to [Microphone: Off](#).

Click [Microphone: Off](#) to unmute.



Volume down

Volume up

* An extra audio-only participant is supported only by the following products: Board, Codec Plus, Codec Pro, Desk Pro, Room Kit, Room Kit Mini, Room 55, Room 55 Dual, Room 70, and Room 70 G2.

Board

Board Pro

Codec EQ

Codec Plus

Codec Pro

Desk, Desk Pro, Desk Mini

Room Bar

Room Kit

Room Kit Mini

Room 55

Room 55 Dual, Room 70

Room 70 G2

Room 70 Panorama

Room Panorama

Share content using the device web interface

Sign in to the device web interface and go to *Call*.

Share content

1. Choose which content source to share in the *Presentation* source drop down list.
Products that support only one input source, have only one entry in the drop down list.
2. Click *Start Presentation*. Then the text changes to *Stop Presentation*.

Stop content sharing:

Click the *Stop Presentation* button that is present while sharing.

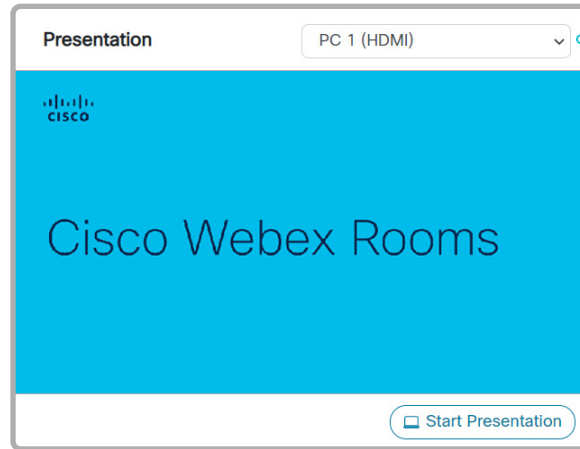

Presentation source drop down list

Choose which input source to share, from the drop down list.

Snapshot area

Shows snapshots of the selected presentation source.

Only available on devices that have the *Remote Monitoring* option.

About content sharing

You can connect a presentation source to a video input on your device. Most often a PC is used as presentation source, but other options may be available depending on your device setup.

While in a call you can share content with the other participants in the call (far end).

If you are not in a call, the content is shown locally.

- Board
- Board Pro
- Codec EQ
- Codec Plus
- Codec Pro
- Desk, Desk Pro, Desk Mini
- Room Bar
- Room Kit
- Room Kit Mini
- Room 55
- Room 55 Dual, Room 70
- Room 70 G2
- Room 70 Panorama
- Room Panorama

Local layout control

Sign in to the device web interface and go to [Call](#).

Note: Local layout control is not available in Panoramic video scenarios.

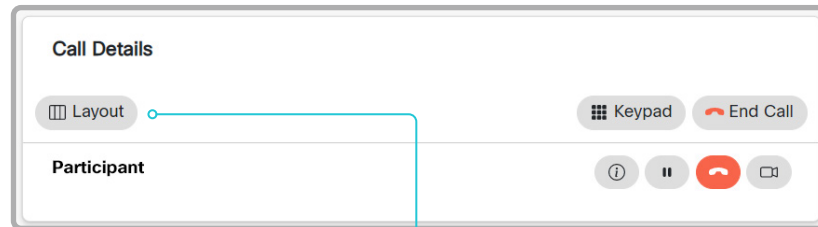

Change the layout

Click [Layout](#), and choose your preferred layout in the window that opens. *

The set of layouts to choose from depends on the device configuration.

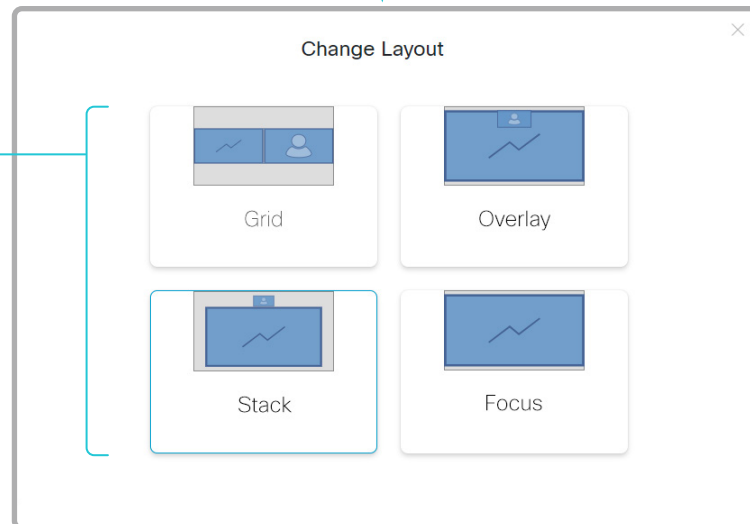

About layouts

The term layout is used to describe the various ways presentations and videos can appear on the screens. Different types of meetings may require different layouts.

The number of call or conference participants are reflected in the available choices.

Note: The set of layouts are currently being renamed. For a short period, you might see a mix of both the old and new names in use.

Old name	New name
Equal	Grid
Overlay	Overlay
Prominent	Stack
Single	Focus

* Changing the participant layout from the device web interface is not supported when calling a conference bridge, even if it is supported on the video conferencing device itself.

Board

Board Pro

Codec EQ

Codec Plus

Codec Pro

Desk, Desk Pro, Desk Mini

Room Bar

Room Kit

Room Kit Mini

Room 55

Room 55 Dual, Room 70

Room 70 G2

Room 70 Panorama

Room Panorama

Control a local camera

Sign in to the device web interface and go to *Call*.

Prerequisites for manual camera control

- The *Video > Input > Connector n > CameraControl > Mode* setting is switched **On**.
- The camera has pan, tilt or zoom functionality.
- Best overview / Speaker tracking is switched off.
- Panoramic video is not in use.

Snapshot area

Shows snapshots of the selected camera (main input source).

Only available on devices that have the *Remote Monitoring* option.

Automatically refresh snapshots

Move the camera using the pan/tilt/zoom controls

Camera control is not available when speaker tracking / best overview is active.

1. If applicable, choose which camera to control in the *Main* source drop down list.
2. Click the camera icon to open the camera control window.
Video snapshots from the room are only displayed for devices that have the *Remote Monitoring* option.
3. Use the left and right arrows to pan the camera; the up and down arrows to tilt it; and + and - to zoom in and out.
Only relevant controls appear in the window.
4. Click *Close* to close the window.

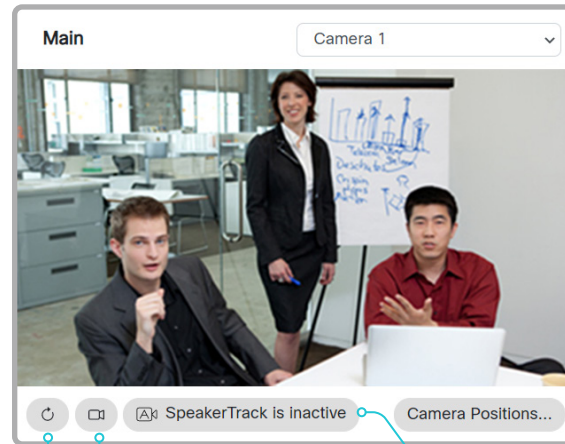

Main source drop down list

Choose which camera to control from the drop down list.

Products that support only one camera don't have a drop down list.

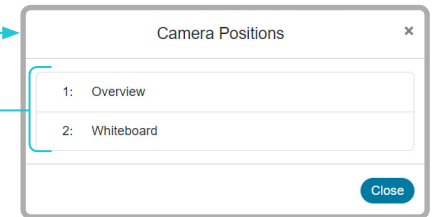

Move the camera to a preset position

1. If applicable, choose which camera to control in the *Main* source drop down list.
2. Click *Camera Positions...* to open a list of available presets.
If no presets are defined, the button is disabled and named *No Camera Positions*.
3. Click a preset's name to move the camera to the preset position.
4. Click *Close* to close the window.

Best overview / Speaker tracking

Click to toggle the feature on and off.

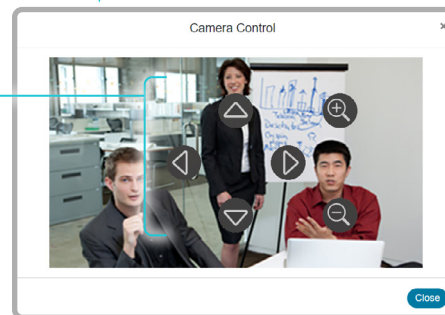

i You cannot use the device web interface to define a preset; you should use the user interface of the device.

When you select a preset camera position, speaker tracking / best overview will be switched off automatically.

Board

Board
ProCodec
EQCodec
PlusCodec
ProDesk,
Desk Pro,
Desk MiniRoom
Bar

Room Kit

Room Kit
Mini

Room 55

Room 55
Dual,
Room 70Room 70
G2Room 70
PanoramaRoom
Panorama

Control a far end camera

Sign in to the device web interface and go to [Call](#).

Prerequisites

While in a call, you can control the remote participant's camera (far end) provided that:

- Panoramic video is *not* in use.
- The [Conference > FarEndControl > Mode](#) setting is either switched **On** or set to **Auto** on the far end device.
 - If set to **Auto**, speaker tracking must be switched Off.
 - If set to **On**, speaker tracking will be disabled automatically when the device receives the first move command, and then re-enabled when the call ends.
- The far end camera has pan, tilt or zoom functionality. Only the relevant controls will appear.
- The local device has the *Remote Monitoring* option.

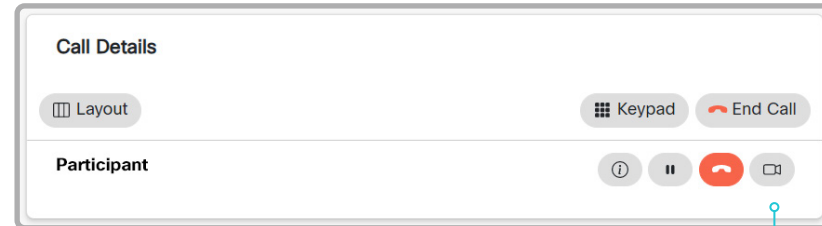

Control the remote participant's camera

1. Click the camera icon to open the remote camera control window.
2. Use the left and right arrows to pan the camera; the up and down arrows to tilt it; and + and - to zoom in and out.

If you are not allowed to control the far end camera, the controls will not appear in the image.

If the call is encrypted, the far end snapshot behind the controls are not displayed.

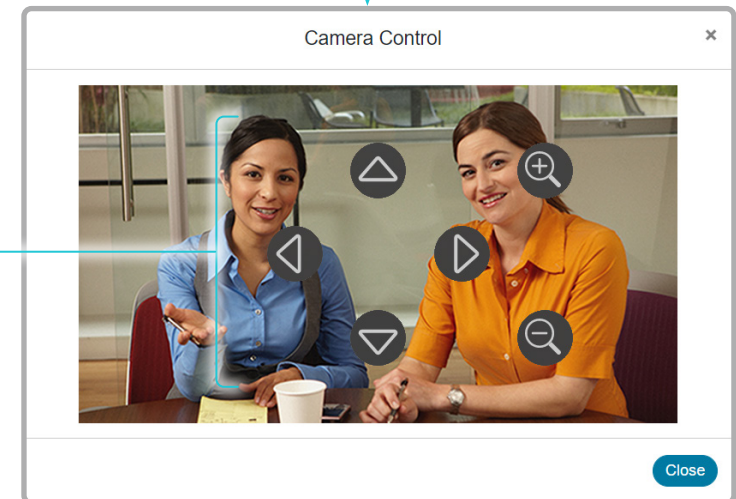

Board

Board
ProCodec
EQCodec
PlusCodec
ProDesk,
Desk Pro,
Desk MiniRoom
Bar

Room Kit

Room Kit
Mini

Room 55

Room 55
Dual,
Room 70Room 70
G2Room 70
PanoramaRoom
Panorama

Room analytics (page 1 of 2)

The room analytics feature use several variables from the conference room and re-uses them to analyze the room utilization over time or per call.

To find the settings referred below, sign in to the device web interface, go to [Settings](#), and select [Configurations](#).

To find a status, sign in to the device web interface, go to [Settings](#), and select [Statuses](#).

Ambient noise reporting

The devices can report the stationary ambient noise level in the room. The reported value is an A-weighted decibel value (dBA), which reflects the response of the human ear. All signal processing related to this feature is local, the only data transmitted is the calculated noise level.

This value can be used to detect abnormal changes to the noise level. Such changes may be caused by noise that can be an annoyance for people working in the room. Facility management can then quickly intervene to troubleshoot the issue.

You can turn the ambient noise detection on or off from the device web interface. Use the [RoomAnalytics > AmbientNoiseEstimation > Mode](#) setting.

People presence detection

The device has the capability to find whether or not people are present in the room. It takes a minimum of two minutes to detect whether people are present or not in the room. After the room becomes vacant, it may take up to two minutes for the status to change.

This feature is based on ultrasound. It will not keep record of who was in the room, only whether or not there are people present in the room.

You can turn the people presence detection on or off from the device web interface. Use the [RoomAnalytics > PeoplePresenceDetector](#) setting.

People count

By using head detection*, the device can find how many people are in the room. It will not keep record of who was in the room, only the average number of people that were detected. If there are objects or pictures in the room that can be detected as heads these might be counted.

The call must have a duration of minimum two minutes in order to get a reliable average. Calls that last less than two minutes, and calls which are made with people count disabled, will display "N/A" when you retrieve call history.

By default, the device only counts people when in a call, or when it displays the selfview picture.

You can choose to count people outside of call. When enabled, the device counts people as long as the device is not in standby mode. This includes outside of call, even if selfview is off.

Use the [RoomAnalytics > PeopleCountOutOfCall](#) setting.

For Codec EQ, Codec Pro and Codec Plus

- People count in call requires the use of a Quad Camera ([Codec EQ](#), [Codec Pro](#) and [Codec Plus](#)) or SpeakerTrack 60 camera ([Codec Pro](#) and [Codec Plus](#)).
- People count outside of call requires a Quad Camera.

Status

You may see the status at a given moment of people's presence and people count. Look at the [RoomAnalytics](#) status.

* Exception: The SpeakerTrack 60 camera is using a face detection algorithm instead of a head detection algorithm.

Board

Board
ProCodec
EQCodec
PlusCodec
ProDesk,
Desk Pro,
Desk MiniRoom
Bar

Room Kit

Room Kit
Mini

Room 55

Room 55
Dual,
Room 70Room 70
G2Room 70
PanoramaRoom
Panorama

Room analytics (page 2 of 2)

Diagnostics

You can see the live people counter and other speaker track diagnostics information on-screen by enabling the SpeakerTrack Diagnostics mode from the user interface.

1. Swipe in from the right or tap the controls icon  in the upper, right corner to open the control panel. Then select *Device settings*.*
2. Select *Issues and diagnostics* and toggle on *SpeakerTrack diagnostics*.

Now, the live people counter and other speaker track diagnostics information are both shown in selfview (outside of call and in a call) and **sent to the far end** (when in call).

Call history command

After a call the average people count value can be extracted from the Call History command.

- `xCommand CallHistory Get DetailLevel: Full`

The Call History command is available from the API (Application Programming Interface). Refer to the RoomOS API Reference Guide, for details. Go to:

- ▶ <https://www.cisco.com/go/room-docs>
- ▶ <https://www.cisco.com/go/board-docs>
- ▶ <https://www.cisco.com/go/desk-docs>

* For Room 70 Panorama and Room Panorama: Select the device name or address at the top of the user interface. Then select *Settings*.

- Board
- Board Pro
- Codec EQ
- Codec Plus
- Codec Pro
- Desk, Desk Pro, Desk Mini
- Room Bar
- Room Kit
- Room Kit Mini
- Room 55
- Room 55 Dual, Room 70
- Room 70 G2
- Room 70 Panorama
- Room Panorama

Customization

Customize the video conferencing device's user interface (page 1 of 2)

You can customize the user interface to allow control of peripherals in a meeting room, for example lights and blinds, or to modify the video conferencing device's behavior by triggering macros.

This allows for the powerful combination of a control system's functionality and the video conferencing device's user-friendly touch user interface.

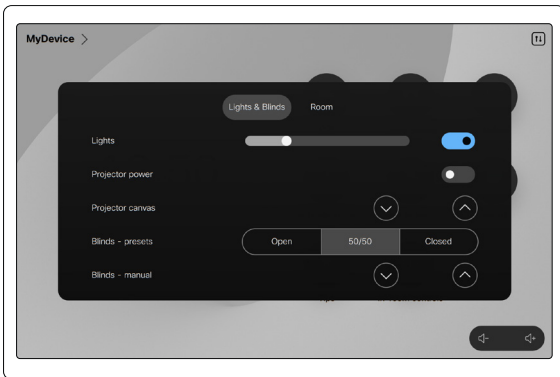

Example in-room control panel

Read the *Customization guide* for full details about how to design custom user interface panels, action buttons, and web apps using the UI Extensions editor, and how to use the video conferencing device's API to program the controls and actions. Go to:

► <https://www.cisco.com/go/in-room-control-docs>

Also check out the Cisco RoomOS web site to find more information, examples, and other resources for customizations and macros. Go to:

► <https://roomos.cisco.com>

UI extensions control architecture

You need a Cisco video conferencing device with a touch interface (touch controller or integrated touch screen), and a macro or control system.

- The macro can use the device's API (events and commands) to trigger all sorts of functionality: Speed dial, language selection, customized system reset, and much more.
- The control system may be a third-party system, such as Crestron or AMX, with hardware drivers for peripherals. It is the control system, not the video conferencing device, that controls the peripherals.

When you program the control system you must use the video conferencing device's API (events and commands) in order to connect with the controls on the video conferencing device's user interface.

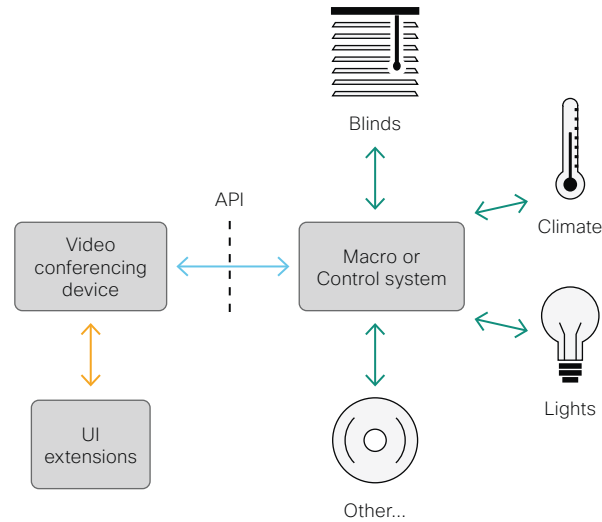

UI extensions control schematics

Board

Board
ProCodec
EQCodec
PlusCodec
ProDesk,
Desk Pro,
Desk MiniRoom
Bar

Room Kit

Room Kit
Mini

Room 55

Room 55
Dual,
Room 70Room 70
G2Room 70
PanoramaRoom
Panorama

Customization

Customize the video conferencing device's user interface (page 2 of 2)

The UI Extensions editor

Free of charge editor

An easy to use drag-and-drop editor, which you should use to compose the custom user interface extensions (action buttons, web apps, and custom panels such as in-room controls), comes free of charge with the video conferencing device's software.

Sign in* to the device web interface and go to [UI Extensions Editor](#).

- The editor opens directly in the device web interface.

You can create and push a new panel, action button, or web app to the device, and see the result immediately on its user interface.

Preview function

The editor also provides a preview function, which allows you to see how the custom interfaces will appear on the user interface.

- Click  to start the preview.

The preview function is also a complete software version of your custom panels, so clicking the controls will result in the same actions as selecting them on the real user interface.

Therefore, you can use the preview function to test your integrations without having a real user interface available. You can also use the device's custom panels from a remote location.

* You need a user that holds the ROOMCONTROL, INTEGRATOR, or ADMIN user roles in order to access the UI Extensions editor and the API commands that you need when programming.

Board

Board
ProCodec
EQCodec
PlusCodec
ProDesk,
Desk Pro,
Desk MiniRoom
Bar

Room Kit

Room Kit
Mini

Room 55

Room 55
Dual,
Room 70Room 70
G2Room 70
PanoramaRoom
Panorama

Customization

Customize the video conferencing device's behavior using macros

With macros, you can create your own snippets of code that run on the device. The language is JavaScript / ECMAScript 6 with support for features such as arrow functions, promises and classes.

The macro framework allows an integrator to write scripts that tailor a device's behavior to suite an individual customer's requirements. The integrators can, for example, implement their own features or variations of features, automate specific configurations or re-configurations, and create custom tests and monitoring functions.

By combining the use of macros and creation of a custom user interface panel (UI extension), you can amend the user interface to trigger customized local functionality. For examples:

- Add speed dial buttons
- Add a button for room reset, which set all configurations back to your preferred default setup

Consult the *Customization guide* for details about macros and how to use the device's built in Macro editor. Go to:

▶ <https://www.cisco.com/go/in-room-control-docs>

Also check out the Cisco RoomOS web site to find more information, examples, and other resources for customizations and macros. Go to:

▶ <https://roomos.cisco.com>

Allow using macros on the device

Sign in to the device web interface, go to *Settings*, and select *Configurations*.

- Set *Macros > Mode* to **On**.

If you try to launch the Macro editor while this setting is **Off**, a pop-up message appears. If you respond by tapping *Enable Macros*, the *Macros > Mode* setting will automatically change to **On**, and the editor will launch.

Launch the macro editor

Sign in* to the device web interface and go to *Macro Editor*.

This opens the Macro Editor, **which is embedded in the device web interface**. We don't offer a stand-alone editor.

The Macro editor

The Macro editor is a powerful tool where you can:

- Load our code examples, which you can modify, use as is, or use as inspiration when writing your own macros.
- Read our detailed macro scripting tutorial, which also explains the code examples in more detailed.
- Write your own macros, and upload them to the device.
- Enable/Disable individual macros.
- Check in an embedded Log Console what happens when you run a macro.

* You need a user that holds the ADMIN user role in order to access the Macro editor.

Board

Board
ProCodec
EQCodec
PlusCodec
ProDesk,
Desk Pro,
Desk MiniRoom
Bar

Room Kit

Room Kit
Mini

Room 55

Room 55
Dual,
Room 70Room 70
G2Room 70
PanoramaRoom
Panorama

Customization

Show or hide buttons on the user interface

In some use cases, you may never use a button, like *Call* or *Share*. Such unused buttons may cause confusion. In these cases, you can remove the unused buttons from the user interface. Custom UI buttons can be exposed still. Removing standard buttons while adding custom buttons makes it possible fully to customize the user interface.

For example, you can remove the *Call* and *Share* buttons if nobody is going to share content or call from this device. Instead, add custom buttons and panels for the tasks that are going to be performed.

Further Information

Find more details about how to remove buttons and customize the user interface in the *Customization guide*. Go to:

► <https://www.cisco.com/go/in-room-control-docs>

Configurations

Use the following configurations to show or hide buttons on the user interface. The configurations are available both from the device web interface, and in the API.

- *UserInterface > Features > Call > Start*: Show or hide the default *Call* button (including the directory, favorites, and recent calls lists). Also affects the *Add participant* button while in a call.
- *UserInterface > Features > Call > JoinWebex*: Show or hide the default button for joining a Webex meeting.
- *UserInterface > Features > Call > JoinGoogleMeet*: Show or hide the button that allows users to dial into Google Meet meetings using just the meeting code, generated by the Google invite. *(Only for devices that are registered to the Webex cloud service or linked to Webex Edge for Devices)*
- *UserInterface > Features > Call > JoinZoom*: Show or hide the button for joining a Zoom meeting.
- *UserInterface > Features > Share > Start*: Removes the default user interface for sharing and previewing content, both in call and out of call.
- *UserInterface > Features > Whiteboard > Start*: Removes the default button for starting a whiteboard. *(Only Board, Board Pro, Desk, Desk Mini, and Desk Pro)*
- *UserInterface > Features > Call > VideoMute*: Removes the default *Turn video off* button.
- *UserInterface > Features > Call > End*: Removes the *End Call* button.
- *UserInterface > Features > Call > MidCallControls*: Removes the *Hold*, *Resume*, and *Transfer* in-call buttons.
- *UserInterface > Features > Call > LayoutControls*: Show or hide the *Layout* button, which by default is available in call.
- *UserInterface > Features > Call > ParticipantList*: Show or hide the *Participants* button, which by default is available in call.
- *UserInterface > Features > Call > MusicMode*: Removes the toggle button that enables Music mode on the device. Music mode is useful when the microphones should capture music.
- *UserInterface > Features > Call > Keypad*: Removes the in-call *Keypad* button, which opens a keypad that can be used for DTMF input.
- *UserInterface > Features > Call > SelfviewControls*: Show or hide the self-view controls on the user interface. *(Not supported on Room 70 Panorama and Room Panorama in this software version)*
- *UserInterface > Features > Call > HdmiPassthrough*: Show or hide the *Call from laptop* button. *(Only Codec Plus, Codec Pro, Room Kit, Room 55, Room 70 Single, Room 70 G2)*
- *UserInterface > Features > Call > Webcam*: Show or hide the *Call from laptop* button. *(Only Room Bar, Room Kit Mini, Board Pro)*
- *UserInterface > Features > Files > Start*: Show or hide the *Files* button. *(Only Board, Board Pro, Desk, Desk Mini, and Desk Pro; applies only to devices that are registered to the Webex cloud service or linked to Webex Edge for Devices)*
- *UserInterface > Help > Tips*: Show or hide the *Tips* button, which gives access to information how to use the device. *(Not supported on Room 70 Panorama and Room Panorama in this software version)*
- *UserInterface > Features > HideAll*: Removes all the default buttons. Custom buttons are not removed.



The configurations remove only the buttons and UI elements, not the functionality as such. For example, you can share content using Proximity, even if you have removed the *Share* button from the user interface.

Board

Board
ProCodec
EQCodec
PlusCodec
ProDesk,
Desk Pro,
Desk MiniRoom
Bar

Room Kit

Room Kit
Mini

Room 55

Room 55
Dual,
Room 70Room 70
G2Room 70
PanoramaRoom
Panorama

Customization

Use of a third-party USB input device

You can use a third-party USB input device to control certain functions on the video conferencing device. A Bluetooth remote control (with a USB dongle) and a USB keyboard are examples of such input devices.

This feature is meant to complement the functionality of the video conferencing device's user interface, wherever convenient. It is not meant to replace the user interface.

Examples of applications:

- In classrooms and during lectures, a small remote control can be used to wake up a video conferencing device from standby mode. Also, it may be convenient to use a remote control to select which input source to present.
- Controlling the camera view (pan, tilt, and zoom) in situations where you are not allowed to use the touch interface. For example, in operating rooms in a hospital.

Functional Overview

Pressing a button on the USB input device, generates an event in the API. Macros or third-party control devices can listen for such events, and respond to them. This behavior is similar to the behavior of custom UI buttons (UI extensions). It is also possible to listen for the events using webhooks, directly in an SSH session.

There isn't a library of actions readily available to select actions from. You must define and implement the actions to be taken as response to the events yourself. For example:

- Increase the volume of the video conferencing device when the Volume Up key is pressed.
- Put the video conferencing device in standby mode when the Sleep key is pressed.

Configurations, Events, and Status

The support for third-party USB input devices is disabled by default. Enable it explicitly by setting the *Peripherals > InputDevice > Mode* to **On**.

Pressing and releasing a button generates a Pressed and a Released event:

```
*e UserInterface InputDevice Key Action Key: <name of the key>
*e UserInterface InputDevice Key Action Code: <id of the key>
*e UserInterface InputDevice Key Action Type: Pressed
** end
*e UserInterface InputDevice Key Action Key: <name of the key>
*e UserInterface InputDevice Key Action Code: <id of the key>
*e UserInterface InputDevice Key Action Type: Released
** end
```

To listen for events, you must register feedback from the InputDevice events:

```
xFeedback Register /event/UserInterface/InputDevice
** end
```

When the video conferencing device detects the third-party input device, the input device is listed in the video conferencing device's *UserInterface > Peripherals > ConnectedDevice* status. The input device may be reported as multiple devices.

Required Equipment

- A device from the Cisco Webex Room, Board, or Desk Series.
- A third-party input device that advertises itself as a USB keyboard, for example a Bluetooth remote control with a USB dongle.

Further Information

Find more information about the use of a third-party input device in the *Customization guide*. Go to:

► <https://www.cisco.com/go/in-room-control-docs>

Cisco support (TAC) doesn't support debugging of third-party code, including macros. Please check the ► [Cisco Collaboration Developer community](#) if you need help with macros and third-party code.

Customization

Sending HTTP(S) requests

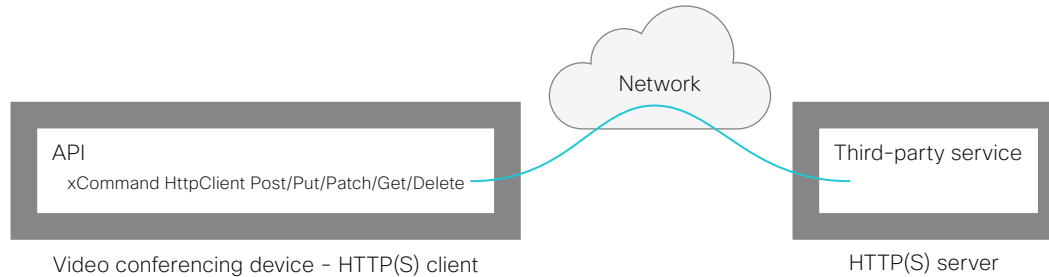

The HTTP(S) request feature makes it possible to send arbitrary HTTP(S) requests from a video conferencing device to an HTTP(S) server. Furthermore, the device receives the response that the server sends back. The device supports the **Post**, **Put**, **Patch**, **Get**, and **Delete** methods.

By using macros, you can send data to an HTTP(S) server whenever you want. You can choose what data to send, and structure them as you like. By doing it this way, you can adapt the data to an already established service.

Security measures:

- The HTTP(S) request feature is disabled by default. A system administrator must explicitly enable the feature by setting `HttpClient > Mode` to **On**.
- The system administrator can prevent the use of HTTP by setting `HttpClient > AllowHTTP` to **False**.
- The system administrator can specify a list of HTTP(S) servers that the device is allowed to send data to.
- The number of concurrent HTTP(S) requests is limited.

List of Allowed HTTP(S) servers

The system administrator can use these commands to set up and maintain a list of up to ten allowed HTTP(S) servers (hosts):

- `xCommand HttpClient Allow Hostname Add`
Expression: <Regular expression that matches the host name or IP address of the HTTP(S) server>
- `xCommand HttpClient Allow Hostname Clear`
- `xCommand HttpClient Allow Hostname List`
- `xCommand HttpClient Allow Hostname Remove Id:`
<id of an entry in the list>

If the list is not empty, you can send HTTP(S) requests only to the servers in the list. If the list is empty, you can send the requests to any HTTP(S) server.

The check against the list of allowed servers is performed both when using insecure (HTTP) and secure (HTTPS) transfer of data.

HTTPS without certificate validation

When sending requests over HTTPS, the video conferencing device checks the certificate of the HTTPS server by default. If the HTTPS server certificate is not found to be valid, you get an error message. The device doesn't send any data to that server.

We recommend using HTTPS with certificate validation. If certificate validation is not possible, the system administrator can set `HttpClient > AllowInsecureHTTPS` to **On**. This allows the use of HTTPS without validating the certificate of the server.

Sending HTTP(S) requests

Once the HTTP(S) request feature is enabled, you can use the following commands to send requests to an HTTP(S) server:

```

xCommand HttpClient <Method>
  [AllowInsecureHTTPS: <True/False>]
  [Header: <Header text>]
  [ResponseSizeLimit: <Maximum response size>]
  [ResponseBody: <None/PlainText/Base64>]
  [Timeout: <Timeout period>]
  Url: <URL to send the request to>
  
```

where <Method> is either Post, Put, Patch, Get, or Delete.

The Post, Put, and Patch commands are multiline commands. Read the API guide to find out how to use multiline commands, and also to find a detailed description of the command parameters

Further information

Find more information about HTTP(S) Post requests in the *Customization guide*. Go to:

► <https://www.cisco.com/go/in-room-control-docs>

Board

Board Pro

Codec EQ

Codec Plus

Codec Pro

Desk, Desk Pro, Desk Mini

Room Bar

Room Kit

Room Kit Mini

Room 55

Room 55 Dual, Room 70

Room 70 G2

Room 70 Panorama

Room Panorama

Board

Board
ProCodec
EQCodec
PlusCodec
ProDesk,
Desk Pro,
Desk MiniRoom
Bar

Room Kit

Room Kit
Mini

Room 55

Room 55
Dual,
Room 70Room 70
G2Room 70
PanoramaRoom
Panorama

Web view based features

Digital signage

Digital signage allows you to show custom content (a web page) on a device when it's in half-wake state. Digital signage is a way to display advertising content and promote your brand, but also to show visitor and internal employee information, dashboards, or calendars.

The content replaces the traditional half-wake background image and information, and is always shown on full screen. Only one web window or tab is supported. If a web page tries to open a page in a new window or tab, it replaces the current page.

Data, such as cache, cookies, and local storage, is NOT automatically cleared when the device restarts. You must use the delete storage command to delete the data.

- `xCommand WebEngine DeleteStorage [Type: WebApps]`

If a web page is not supported, the device goes directly to normal half-wake mode.

Interactive mode

Applies to: Board, Board Pro, Desk, Desk Mini, and Desk Pro

Users can interact with the content on the screen, for example click on a link or enter text in a form.

Set up digital signage

1. Sign in to the device web interface, go to [Settings](#), and select [Configurations](#).
2. Set [WebEngine > Mode](#) to **On** to enable the web engine.
3. Set [Standby > Signage > Mode](#) to **On** to enable digital signage.
4. Enter the URL of the web page that you want to show in [Standby > Signage > Url](#).
5. The web page is shown *before* the device enters standby mode. Use the following settings to determine for how long the web page is shown.

[Standby > Mode](#): If set to **Off**, the device never enters standby mode (not recommended). If set to **On**, the device enters standby mode when the [Standby > Delay](#) has timed out.

[Standby > Delay](#): Define how long (in minutes) the device shows the web page before going into standby mode.

[Standby > WakeUpOnMotionDetection](#): If set to **On**, the device wakes up automatically from standby, and starts showing the web page when people enter the room. If set to **Off**, the device is not affected by people entering the room.

Other digital signage settings:

- Decide whether to play out the audio for web pages that have audio.
[Standby > Signage > Audio](#)
- If supported, decide whether to allow interaction with the web page.
[Standby > Signage > InteractionMode](#)
- Force a web page to refresh at regular intervals. This is useful for web pages that don't refresh themselves.
[Standby > Signage > RefreshInterval](#)

The web engine

All web view based features are using the web engine. Therefore the web engine must be enabled before you can use a web view based feature.

The web engine is based on Chromium / Qt WebEngine with V8 JavaScript. The Chromium version is updated regularly, but it might be older than your Chrome laptop version.

These features are not supported: PDF, WebGL WebRTC, password manager, plug-ins, downloading and uploading files, and notifications.

Remote debugging

If you encounter a problem with a web page, you can turn on remote debugging.

[WebEngine > RemoteDebugging](#)

Remote debugging lets you access the Chrome developer console and identify potential issues with a web page. When enabled, a banner is displayed at the bottom of the screen, warning the users that they may be monitored. The banner also shows the URL that you can enter in your local Chrome browser to open the developer console.

Using a proxy

You can set up the device to use an HTTP proxy for web view based features.

[NetworkServices > HTTP Proxy](#)

Additionally, this setting must be **On**:

[WebEngine > UseHttpProxy](#)

Board

Board
ProCodec
EQCodec
PlusCodec
ProDesk,
Desk Pro,
Desk MiniRoom
Bar

Room Kit

Room Kit
Mini

Room 55

Room
55 Dual,
Room 70Room 70
G2Room 70
PanoramaRoom
Panorama

Web view based features

Web apps

A web app is a web page or application that a user can access from the home screen of the device. The web app is available only when not in a call.

A web app launches in full screen, and times out after 15 minutes if not being used. The web app may be interactive.

Data, such as cache, cookies, and local storage, is automatically cleared when the session ends.

You must use the *UI Extensions editor*, which is available from the device web interface, to create web apps. The editor also lets you configure the label and icon to be used on the Home screen. By default, the web page's icon is used, but you can choose another icon instead.

Icon details:

- Formats: .ico, .png, .jpg, .svg, or .gif
- Icon size: Minimum 60×60 pixels, maximum 1200×1200 pixels

Typical apps may be Office 365, Trello, Wikipedia, YouTube or company internal web pages and tools.

Further information

Find more information about how to create web apps in the *Customization guide*. Go to:

► <https://www.cisco.com/go/in-room-control-docs>

Create a web app

1. Sign in* to the device web interface, go to *Settings*, and select *Configurations*.
2. Set *WebEngine > Mode* to **On** to enable the web engine.
3. Go to *UI Extensions Editor*, and the editor opens directly in the device web interface.
4. Click *New* and select the Web App *Add* button.
5. Fill in the web app properties in the right side bar:
 - Id: Unique identifier of the app.
 - Name: The label of the button.
 - Web app URL: The web app URL.
 - Web app icon URL (optional): The icon for the button.
 - Web app location: On the Home screen, in the call controls, both places, or nowhere.
6. Click the export button  in the top bar to upload the configuration to the device.

Now you can see the button for the new web app on the Home screen.



Web app button with label and icon on the Home screen

The web engine

All web view based features are using the web engine. Therefore the web engine must be enabled before you can use a web view based feature.

The web engine is based on Chromium / Qt WebEngine with V8 JavaScript. The Chromium version is updated regularly, but it might be older than your Chrome laptop version.

These features are not supported: PDF, WebGL WebRTC, password manager, plug-ins, downloading and uploading files, and notifications.

Remote debugging

If you encounter a problem with a web page, you can turn on remote debugging.

[WebEngine > RemoteDebugging](#)

Remote debugging lets you access the Chrome developer console and identify potential issues with a web page. When enabled, a banner is displayed at the bottom of the screen, warning the users that they may be monitored. The banner also shows the URL that you can enter in your local Chrome browser to open the developer console.

Using a proxy

You can set up the device to use an HTTP proxy for web view based features.

[NetworkServices > HTTP Proxy](#)

Additionally, this setting must be **On**:

[WebEngine > UseHttpProxy](#)

* You need a user that holds the ROOMCONTROL, INTEGRATOR, or ADMIN user roles in order to access the UI Extensions editor and the API commands that you need when programming.

Board

Board
ProCodec
EQCodec
PlusCodec
ProDesk,
Desk Pro,
Desk MiniRoom
Bar

Room Kit

Room Kit
Mini

Room 55

Room 55
Dual,
Room 70Room 70
G2Room 70
PanoramaRoom
Panorama

Web view based features

API-driven web views

Web views can be opened and closed using API commands. Integrators can use these commands when making third-party integrations or macros. The integrator decides which URL to load based on external events. An example is to show important company alerts.

The web view is fullscreen and will time out after 15 minutes, or by calling the API command to close the view.

Open the web view:

- `xCommand UserInterface WebView Display Url: <url>`

Close the web view:

- `xCommand UserInterface WebView Clear`

Data, such as cache, cookies, and local storage, is automatically cleared when the session ends.

By combining API-driven web views, macros, and custom buttons on the touch controller, an integrator can make interactive solutions also for devices without touch screens. Tapping different buttons on the touch controller shows different web views on the main screen. For example to open and browse basic help pages or show instructional videos.

The web engine

All web view based features are using the web engine. Therefore the web engine must be enabled before you can use a web view based feature.

The web engine is based on Chromium / Qt WebEngine with V8 JavaScript. The Chromium version is updated regularly, but it might be older than your Chrome laptop version.

These features are not supported: PDF, WebGL WebRTC, password manager, plug-ins, downloading and uploading files, and notifications.

Remote debugging

If you encounter a problem with a web page, you can turn on remote debugging.

[WebEngine > RemoteDebugging](#)

Remote debugging lets you access the Chrome developer console and identify potential issues with a web page. When enabled, a banner is displayed at the bottom of the screen, warning the users that they may be monitored. The banner also shows the URL that you can enter in your local Chrome browser to open the developer console.

Using a proxy

You can set up the device to use an HTTP proxy for web view based features.

[NetworkServices > HTTP Proxy](#)

Additionally, this setting must be **On**:

[WebEngine > UseHttpProxy](#)

Board

Board Pro

Codec EQ

Codec Plus

Codec Pro

Desk, Desk Pro, Desk Mini

Room Bar

Room Kit

Room Kit Mini

Room 55

Room 55 Dual, Room 70

Room 70 G2

Room 70 Panorama

Room Panorama

Input source composition (page 1 of 2)

You can use the device's API to combine up to four input sources in a single main video stream.

The maximum number of *different* input sources depends on the device:

Video conferencing device	Maximum number of different input sources
Desk Mini, Room Kit, Room Kit Mini	2
Codec Plus, Room Bar, Room 55, Room 55 Dual, Room 70, Desk, Desk Pro, Board Pro	3
Codec EQ, Codec Pro, Room 70 G2, Room Panorama*, Room 70 Panorama*	4

Source composition

Composition layout

You can choose between three layouts:

- Grid
- Stack
- PIP (only available when composing two input sources)

You can modify the PIP position to one of the corners. The size of the PIP can be normal or large.

The composition and layout can be modified at any time, both in call and outside of call.

Selfview

Selfview shows the same composed image that is being sent to the far end.

Individual camera control

You can control individual cameras using API commands (`xCommand Camera *`), but you cannot use the controls on the user interface.

When you select a camera in the user interface, the main video stream will automatically switch from the composed video stream to the single stream from the chosen camera.

Change compositions and layouts on demand

Input source composition is only available using API commands; we don't provide a dedicated user interface for it.

To be able to easily change compositions and layouts on demand, we recommend that you use macros and create a custom user interface panel (UI extension) for it.

Layouts

Grid

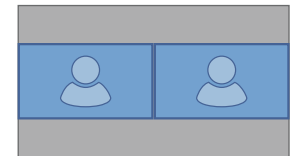

Number of sources: 2

Stack

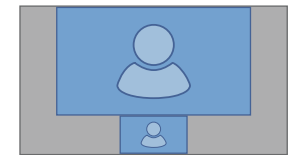

Number of sources: 2

Picture-in-Picture (PIP)

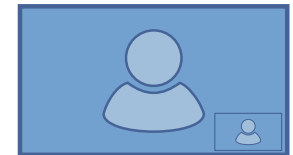

Lower right corner

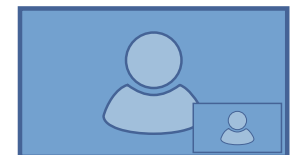

Lower right corner, large PIP

* *Room 70 Panorama and Room Panorama*: These devices use two input sources for the main camera.

Board

Board Pro

Codec EQ

Codec Plus

Codec Pro

Desk, Desk Pro, Desk Mini

Room Bar

Room Kit

Room Kit Mini

Room 55

Room 55 Dual, Room 70

Room 70 G2

Room 70 Panorama

Room Panorama

Input source composition (page 2 of 2)

API command

```
xCommand Video Input SetMainVideoSource
ConnectorId: <1..n> SourceId: <1..m>
Layout: <Equal, PIP, Prominent>
PIPPosition <LowerLeft, LowerRight,
UpperLeft, UpperRight>
PIPSize <Auto, Large>
```

where

The input source can be identified by either the physical connector that it is connected to (ConnectorId), or by the logical source identifier (SourceId). There cannot be a mix of different types of identifiers in the same command; use either ConnectorId or SourceId. You can find these identifiers in the *Video Input Connector* and *Video Input Source* statuses.

You see the difference between the Grid (Layout: Equal), PIP (Layout: PIP), and Stack (Layout: Prominent) layouts in the examples.

You can modify the PIP position to one of the corners. The size of the PIP can be normal (auto) or large.

Refer to the API-guide for more details.

Examples

```
xCommand Video Input SetMainVideoSource ConnectorId: 1 ConnectorId: 2 ConnectorId: 3 ConnectorId: 4 Layout: Equal
```

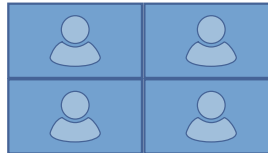

```
xCommand Video Input SetMainVideoSource ConnectorId: 1 ConnectorId: 2 Layout: Equal
```

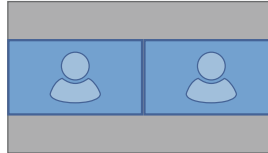

```
xCommand Video Input SetMainVideoSource SourceId: 1 SourceId: 2 Layout: PIP PIPPosition: LowerRight PIPSize: Large
```

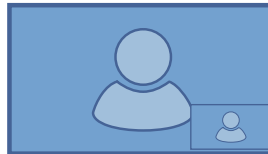

```
xCommand Video Input SetMainVideoSource SourceId: 1 SourceId: 2 SourceId: 3 SourceId: 4 Layout: Prominent
```

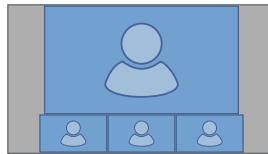

```
xCommand Video Input SetMainVideoSource SourceId: 1 SourceId: 2 Layout: Prominent
```

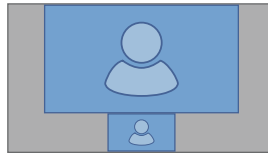

Board

Board Pro

Codec EQ

Codec Plus

Codec Pro

Desk, Desk Pro, Desk Mini

Room Bar

Room Kit

Room Kit Mini

Room 55

Room 55 Dual, Room 70

Room 70 G2

Room 70 Panorama

Room Panorama

Presentation source composition (page 1 of 2)

You can use the device's API to combine up to four presentation sources in a single video stream.*

The maximum number of *different* presentation sources depends on the device:

Video conferencing device	Maximum number of different presentation sources
Desk Mini, Room Kit, Room Kit Mini, Board	2
Codec Plus, Room Bar, Room 55, Room 55 Dual, Room 70, Desk, Desk Pro, Board Pro	3
Codec EQ, Codec Pro, Room 70 G2, Room Panorama*, Room 70 Panorama*	4

You can only share sources that has been shared through a cable (HDMI or USB-C - depending on the device).

Source composition

Composition layout

You can choose between two layouts:

- Grid
- Stack

You can change the number of sources at any time, both in call and outside of call. The image sizes cannot be modified.

The order in which the sources appear on the screen depends on the order they have in the command; starting from upper left, ending at bottom right.

Change compositions and layouts on demand

Presentation source composition is only available using API commands; we don't provide a dedicated user interface for it.

To be able to easily change compositions and layouts on demand, we recommend that you use macros and create a custom user interface panel (UI extension) for it.

Layouts

Grid

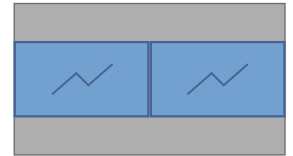

Number of sources: 2

Stack



Number of sources: 2

* *Room 70 Panorama and Room Panorama*: These devices use two input sources for the main camera.

Board

Board Pro

Codec EQ

Codec Plus

Codec Pro

Desk, Desk Pro, Desk Mini

Room Bar

Room Kit

Room Kit Mini

Room 55

Room 55 Dual, Room 70

Room 70 G2

Room 70 Panorama

Room Panorama

Presentation source composition (page 2 of 2)

API command

```
xCommand Presentation Start
ConnectorId: <1..n>
PresentationSource: <None, 1..n>
Instance: <New, 1..n>
Layout: <Equal, Prominent>
SendingMode: <LocalRemote, LocalOnly>
```

where

The input source can be identified by either the physical connector that it is connected to (ConnectorId), or by the logical source identifier (PresentationSource). There cannot be a mix of different types of identifiers in the same command; use either ConnectorId or PresentationSource.

You can find these identifiers in the *Video Input Connector* and *Video Input Source* statuses.

If you select PresentationSource: None, a black frame is inserted. *

You see the difference between the Grid (Layout: Equal) and Stack (Layout: Prominent) layouts in the examples.

Refer to the API-guide for more details.

Examples

```
xCommand Presentation Start PresentationSource: 1 PresentationSource: 2 Layout: Equal
```

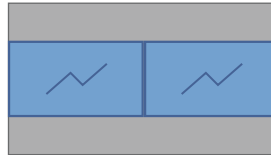

```
xCommand Presentation Start ConnectorId: 1 ConnectorId: 2 Layout: Prominent
```

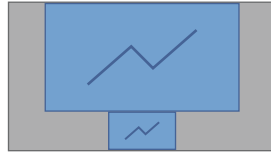

```
xCommand Presentation Start ConnectorId: 1 ConnectorId: 2 ConnectorId: 3 Layout: Equal
```



```
xCommand Presentation Start PresentationSource: 1 PresentationSource: 2 PresentationSource: 3 Layout: Prominent
```



* Board: None is not available.

Board

Board
ProCodec
EQCodec
PlusCodec
ProDesk,
Desk Pro,
Desk MiniRoom
Bar

Room Kit

Room Kit
Mini

Room 55

Room 55
Dual,
Room 70Room 70
G2Room 70
PanoramaRoom
Panorama

Access the device's XML files

Sign in to the device web interface and go to [Developer API](#).

The XML files are part of the device's API. They structure information about the device in a hierarchy.

- *Configuration.xml* contains the current device settings (configuration). These settings are controlled from the device web interface or from the API (Application Programmer Interface).
- The information in *status.xml* is constantly updated by the device to reflect system and process changes. The status information is monitored from the device web interface or from the API.
- *Command.xml* contains an overview of the commands available to instruct the device to perform an action. The commands are issued from the API.
- *Valuespace.xml* contains an overview of all the value spaces of device settings, status information, and commands.

Open an XML file

Click the file name to open the XML file.

About the API

The application programming interface (API) is a tool for integration professionals and developers working with the device. The API is described in detail in the API guide for the device.

Also, find information for integrators and developers on:

► <https://roomos.cisco.com>

Board

Board Pro

Codec EQ

Codec Plus

Codec Pro

Desk, Desk Pro, Desk Mini

Room Bar

Room Kit

Room Kit Mini

Room 55

Room 55 Dual, Room 70

Room 70 G2

Room 70 Panorama

Room Panorama

Execute API commands and configurations from the device web interface

Sign in to the device web interface and go to [Developer API](#).

Commands (xCommand) and configurations (xConfiguration) can be executed from the device web interface. Syntax and semantics are explained in the API guide for the device.

Execute API commands and configurations

1. Enter a command (xCommand or xConfiguration), or a sequence of commands, in the text area.
2. Click *Execute* to issue the command(s).

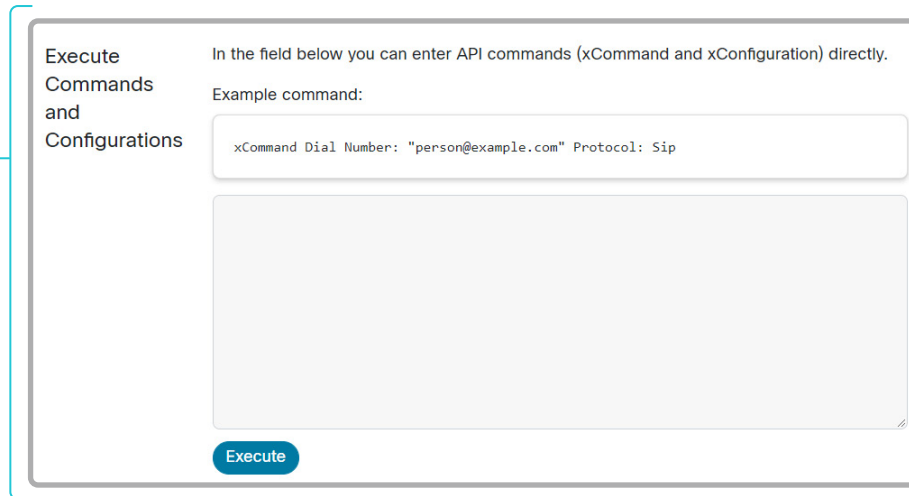

About the API

The application programming interface (API) is a tool for integration professionals and developers working with the device. The API is described in detail in the API guide for the device.

Also, find information for integrators and developers on:

[▶ https://roomos.cisco.com](https://roomos.cisco.com)

Board

Board
ProCodec
EQCodec
PlusCodec
ProDesk,
Desk Pro,
Desk MiniRoom
Bar

Room Kit

Room Kit
Mini

Room 55

Room
55 Dual,
Room 70Room 70
G2Room 70
PanoramaRoom
Panorama

Advanced customization of audio (page 1 of 5)

Introducing Audio Console

The Audio Console application provides a graphical interface to advanced customizable audio features. It lets you define how to connect audio inputs to outputs, using simple drag and drop techniques.

The main features of the Audio Console are:

- Configure the audio system of the codec
- Change the default mixing, routing and equalizers
- Set various input and output connector properties
- Configure advanced features such as local reinforcement

These products support Audio Console:

- Codec Pro / Room Kit Pro
- Room 70 G2
- Room 70 Panorama and Room Panorama
- Codec EQ with AVIntegrator option. See the [▶ Add option keys](#) chapter how to install an option key.

Open the Audio Console

Sign in to the device web interface and go to [Audio Console](#).

This opens the Audio Console application, which is embedded in the device web interface.

Using the Audio Console

Start by defining logical input and output groups. These can be given names as defined by you. Then assign physical, and in some cases logical, inputs and outputs to the logical input and output groups.

New logical groups may be added or removed at any time.

Changes applied to the settings are immediately saved and put into effect.

A physical output cannot be assigned to more than a single logical output group; however, a physical input, such as a microphone, can be assigned to more than one input. This comes in handy when working with local sound reinforcement and extra loudspeakers, for example when using a video device in a lecture hall where the local audience also must hear what is being said through the microphone.

Through Audio Console you can set up *Echo Control* on the part of the microphone signal that is sent to the far end. At the same time, it omit *Echo Control* for the part used locally. This is done by assigning that microphone to more than one logical group by using *Direct: On*.

You may also apply noise reduction and equalizer settings to the microphone signal.

Line level on microphone inputs

Neither Codec EQ nor Codec Pro based devices* have dedicated line inputs, but you may use the microphone inputs for line level. Which actions to take depend on the device type.

Codec Pro based devices:

Deactivate phantom power ([Audio > Input > Microphone \[n\] > PhantomPower](#)) and lower the input gain ([Audio > Input > Microphone \[n\] > Level](#)). The maximum input level when configured for minimum gain is +24 dBu.

If you don't want the regular mute buttons to mute and unmute an input that is set up for line level, set [Audio > Input > Microphone \[n\] > MuteOverride](#) to **On**.

Codec EQ:

The maximum input level when configured for minimum gain is -18 dBu. If the source delivers a higher maximum level external attenuation is needed to avoid clipping the input signal.

The regular mute buttons will mute and unmute an input that is set up for line level just like the other microphone inputs.

Audio from the device's local web browser

To receive audio from WebRTC calls or other WebEngine related sources, the Audio Console needs an input group containing the WebView 1 connector that is routed to the output group with the loudspeakers.

If WebEngine mode is enabled when you first set up the Audio Console, this input group is already in place. However, if WebEngine mode is enabled after that first setup, you will need to create the group manually.

Local sound reinforcement

See the [Using Extra Loudspeakers and Sound Reinforcement](#) guide for a comprehensive description and best practices for such a solution.

Go to: [▶ https://www.cisco.com/go/in-room-control-docs](https://www.cisco.com/go/in-room-control-docs)

* Room 70 G2, Room 70 Panorama, and Room Panorama are based on Codec Pro.

Board

Board Pro

Codec EQ

Codec Plus

Codec Pro

Desk, Desk Pro, DeskMini

Room Bar

Room Kit

Room Kit Mini

Room 55

Room 55 Dual, Room 70

Room 70 G2

Room 70 Panorama

Room Panorama

Advanced customization of audio (page 2 of 5)

Audio Return Channels (ARC)

HDMI offers the ability to transmit audio in either direction. When audio is sent in reverse, this is referred to as an Audio Return Channel (ARC).

Consider the illustrated configuration, showing a Quad Camera, a screen, and a Codec Pro connected via HDMI. The Quad Camera will act as both camera and soundbar in this setting. Codec Pro is just an example; it can be replaced by any of the products that support Audio Console.

Using the loudspeakers of the Quad Camera

Typically, the HDMI 1 Input is used to provide video from the camera to the codec, and the audio return channel of the same HDMI Input is used to route the audio from the codec to the loudspeakers of the camera.

Using the Quad Camera as soundbar for a TV

Codec Pro, Room 70G2, Room 70 Panorama, Room Panorama

If you want to use the setup as just a TV with a soundbar, the system will send audio from the screen to the codec through the ARC of the codec's HDMI 1 Output, and the codec will send that audio further to the Quad Camera through the ARC of the codec's HDMI 1 Input.

In order to be able to do this, the screen must be CEC+ARC enabled. If your setup makes use of 4K video, the screen must support CEC+ARC in 4K format.

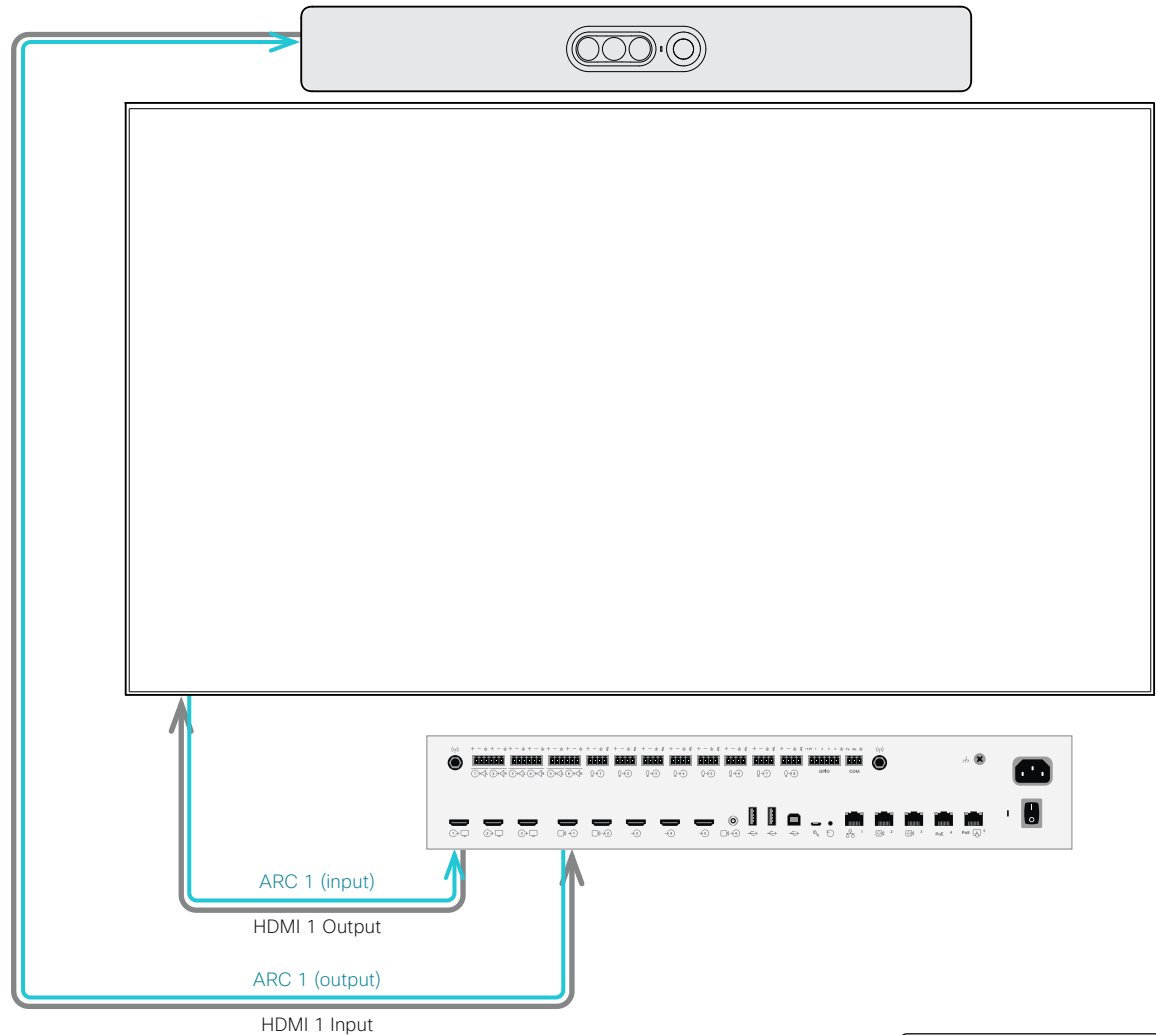

Advanced customization of audio (page 3 of 5)

The Audio Console panel

The **Audio Console** can be found under *Customization* in the Web interface of your device.

The pool of Input connectors (physical or logical) available.

The Input connectors are assigned to logical Input groups. These logical Input groups are created by you.

The name of a logical group is specified by you when clicking on *New input group*.

A given *Input* connector may be assigned to more than one logical group. Use drag-and-drop.

To remove a group or a member of a group, hover the mouse over the group or member. An X will appear. Click on this to remove the item.

Expand the logical group rather than the individual members when using it for local reinforcement.

In local reinforcement scenarios, set the microphones to *Direct* to bypass extra processing, such as echo control.

This will minimize latency and also serve to avoid that the main volume control also affects the volume of the local presenter.

To delete a connection or adjust its gain, right-click on the cable illustration.



Reset to default will create a preset of connections based on connected devices detected.

The screenshot shows the 'Audio Console' interface with several panels:

- Input connectors:** A list of physical connectors including HDMI 1-3, Line 1-4, and Microphone 1-8.
- Input groups:** Logical groups such as 'Microphone' (containing Microphone 1-8), 'HDMI input 1-3' (all marked 'Muted'), and 'Local reinforcement' (containing Microphone 1).
- Output groups:** Logical groups like 'Loudspeaker' (containing Line 1-2), 'Recorder' (containing Line 5-6), and 'Local reinforcement' (containing Line 3 and Line 4).
- Output connectors:** A list of physical output connectors, currently showing 'None available'.
- Local reinforcement settings:** A detailed view for 'Line 3' and 'Line 4' showing settings for Mode (On), Level (dB/dB), Channel (Left/Right), Delay (ms), Delay Mode (Fixed), and Equalizer (Off).

Annotations and callouts:

- A callout points to the 'Input connectors' list: "The pool of Input connectors (physical or logical) available."
- A callout points to the 'Input groups' list: "The Input connectors are assigned to logical Input groups. These logical Input groups are created by you."
- A callout points to the 'Local reinforcement' group: "The name of a logical group is specified by you when clicking on *New input group*."
- A callout points to the 'Local reinforcement' group: "A given *Input* connector may be assigned to more than one logical group. Use drag-and-drop."
- A callout points to the 'Local reinforcement' group: "To remove a group or a member of a group, hover the mouse over the group or member. An X will appear. Click on this to remove the item."
- A callout points to the 'Local reinforcement' group: "Expand the logical group rather than the individual members when using it for local reinforcement."
- A callout points to the 'Local reinforcement' group: "In local reinforcement scenarios, set the microphones to *Direct* to bypass extra processing, such as echo control. This will minimize latency and also serve to avoid that the main volume control also affects the volume of the local presenter."
- A callout points to the 'Edit Gain' dialog: "To delete a connection or adjust its gain, right-click on the cable illustration."
- A callout points to the 'Reset to default' button: "*Reset to default* will create a preset of connections based on connected devices detected."
- A callout points to the 'Output connectors' list: "This is the pool of physical output connectors. Those that are not used are considered to be inactive."
- A callout points to the 'Local reinforcement' settings: "The logical output groups are similar to the logical Input groups, but a physical output cannot be assigned to more than one logical output group."
- A callout points to the 'Local reinforcement' settings: "We recommend that you set *Delay Mode* to *Fixed* to avoid potential delay caused by external screens."
- A callout points to the connection lines: "Click and drag between an Input group and Output group to establish a connection between them."
- A callout points to the 'Local reinforcement' group: "Click a connector and drag it into a group."

- Board
- Board Pro
- Codec EQ
- Codec Plus
- Codec Pro
- Desk, Desk Pro, DeskMini
- Room Bar
- Room Kit
- Room Kit Mini
- Room 55
- Room 55 Dual, Room 70
- Room 70 G2
- Room 70 Panorama
- Room Panorama

Advanced customization of audio (page 4 of 5)

Setting up analog microphones

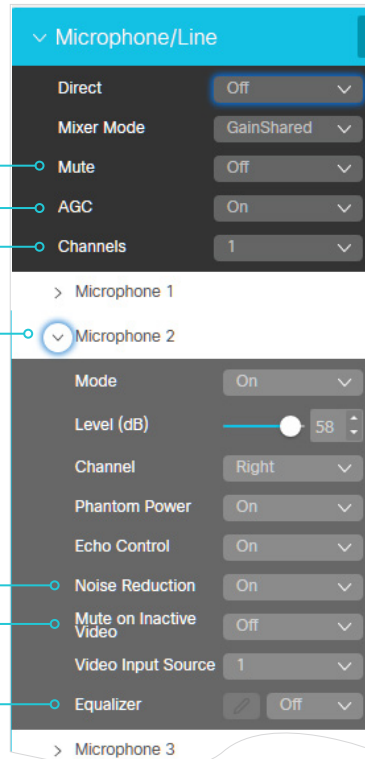

Mute: Mute the entire logical group.

AGC: Enable/Disable Automatic Gain Control applying to the entire logical group.

Channels: 1 (mono) or 2 (stereo).

You may expand a logical group to get access to settings on a group level.

Noise Reduction: Setting this to **On** will reduce any continuous noise present in the room (for example, fan noise). Impulsive noise will not be reduced.

Mute on Inactive Video: Use this feature in scenarios with, for example, a presenter's microphone. This microphone will be muted unless the associated camera (the one filming the presenter) actually sends video, provided that you have set up a camera/microphone combination this way.

Equalizer: The equalizer lets you choose among up to 8 predefined equalizer presets (or none, to indicate *Off*).

The graphical tool to set up the equalizer is described in the ► [Setting up equalizers](#) section.

In local reinforcement scenarios, make sure you set the Microphone(s) **Direct** to **On** to bypass extra processing like *Echo Control*. This will minimize latency and serve to avoid that the master volume control also affects the volume of the local presenter. For other use cases, leave it **Off**.

Mixer Mode can be **GainShared** or **Fixed**. If **GainShared** is selected, the summed level of the microphone signals will never exceed a certain value, but their individual offsets will be retained. In **Fixed** mode, the levels are just summed together.

Mode: A microphone can be set to **On** or **Off**.

Level (dB) / Gain (dB): Adjust the gain to suit the output level of the connected audio source.*

If **Channels** has been set to 2 (at the Group level), you may use the **Channel** setting at the lower level to specify whether this particular microphone belongs to the group of left or right channel microphones.

If the entire logical group has been set to **Direct** on group level, **Echo Control** will be set to N/A.

Phantom power: This setting provides power submitted through the microphone cable. This can be switched off when microphones are used with a preamplifier providing line level signals.

Make sure you reduce the gain (typically by 40 dB or more) if you decide to use a Microphone input as a Line input.

* This is the gain on the input connector. Depending on device, this field is called:
Level (dB) (Codec Pro, Room 70 G2, Room 70 Panorama, Room Panorama)
Gain (dB) (Codec EQ)

- Board
- Board Pro
- Codec EQ
- Codec Plus
- Codec Pro
- Desk, Desk Pro, DeskMini
- Room Bar
- Room Kit
- Room Kit Mini
- Room 55
- Room 55 Dual, Room 70
- Room 70 G2
- Room 70 Panorama
- Room Panorama

Advanced customization of audio (page 5 of 5)

Setting up equalizers

There are 8 user-definable parametric equalizer presets available.

A preset consists of up to 6 sections, each of which has its own filter type, gain, center/crossover frequency, and Q value.

Each section is shown with its own color. A white line shows the combined frequency response of the equalizer.

The effect of altering any of the parameters will become visible in the graph when you press Enter or select a different field.

Your settings are saved automatically.

Go to the next preset (if applicable).

Gain access to the equalizer from the top bar or the input group.

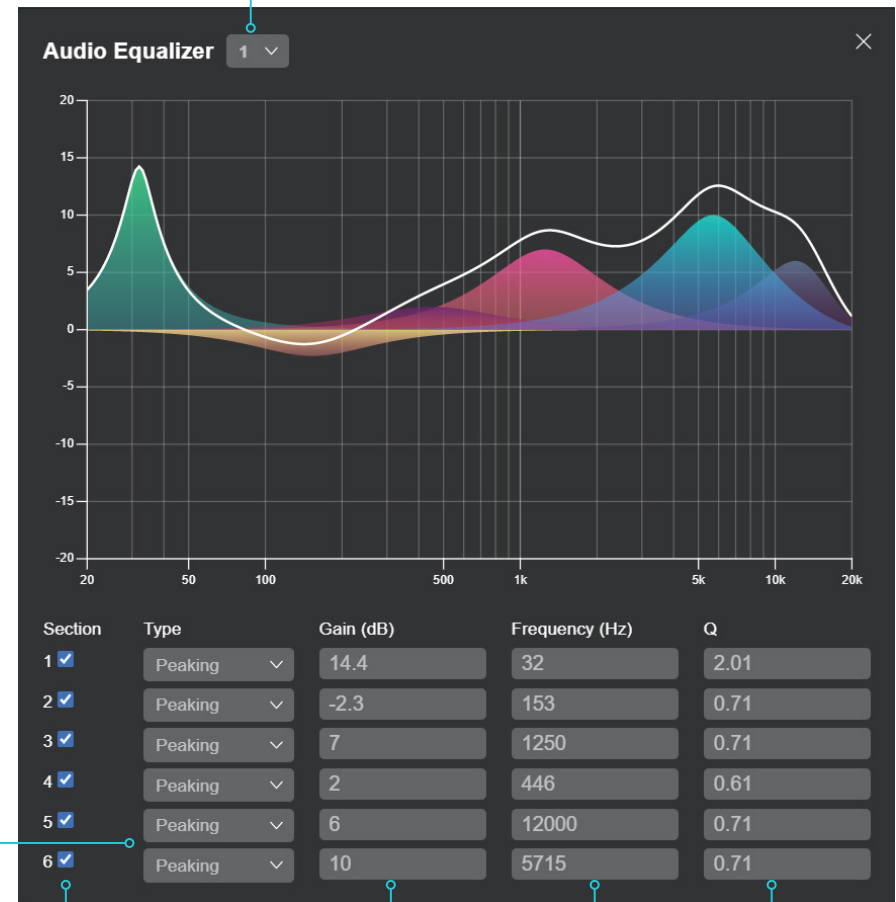
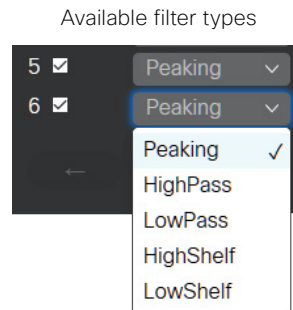
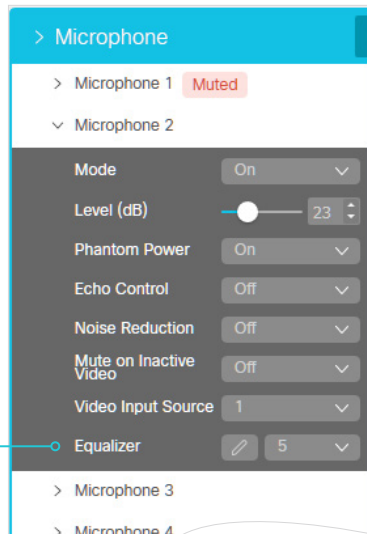
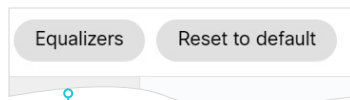

To activate or deactivate a filter section, click the corresponding checkbox.

Valuespace for the Gain is 0dB ± 20dB

Valuespace for Frequency is 20-20000Hz.

Valuespace for the Q value is 0.1-10.0.

- Board
- Board Pro
- Codec EQ
- Codec Plus
- Codec Pro
- Desk, Desk Pro, Desk Mini
- Room Bar
- Room Kit
- Room Kit Mini
- Room 55
- Room 55 Dual, Room 70
- Room 70 G2
- Room 70 Panorama
- Room Panorama

Board

Board
ProCodec
EQCodec
PlusCodec
ProDesk,
Desk Pro,
Desk MiniRoom
Bar

Room Kit

Room Kit
Mini

Room 55

Room 55
Dual,
Room 70Room 70
G2Room 70
PanoramaRoom
Panorama

About Ethernet ports

The main network port

The main network port - Network port 1 - is always reserved for the connection to LAN. This applies to all video conferencing devices.

Depending on the device, Network port 1 is marked with the number 1, the network symbol (🌐), or both.

Auxiliary network ports

Some video conferencing devices have more than one network port. The additional ports can be used for peripheral devices like cameras, touch controllers, third-party control systems, and more.

A device that is connected to such a network port gets a local IP address from the codec, and therefore is not part of the corporate network. It is not possible for packets to traverse the codec between the main network port (LAN) and the auxiliary network ports (link-local).

- A Cisco peripheral device is assigned a dynamic IP address in the range (DHCP): 169.254.1.41 to 169.254.1.240
 - A non-Cisco device is assigned the dynamic IP address (DHCP): 169.254.1.30
- NOTE:** Only one non-Cisco device can get a dynamic IP address at a time.
- A non-Cisco device can be assigned a static IP address in the range: 169.254.1.241 to 169.254.1.254

This method can also be used to connect to the codec with SSH. In this case you can use the IP address 169.254.1.1.

Power over Ethernet (PoE)

Some of the auxiliary network ports provide Power over Ethernet (PoE). These ports can power peripherals, such as the touch controller.

Product	Number of auxiliary network ports	Number of auxiliary network ports with PoE
Room Bar	1	1
Room Kit	1	0
Room Kit Mini	1	1 (🌐)
Room 55	1	1 (🌐)
Room 70 ¹ / Room 55 Dual ¹	2	1 (🌐)
Room 70 G2 ¹	4	2 (🌐, PoE)
Room 70 Panorama ¹ / Room Panorama ¹	4	2 (🌐, PoE)
Codec EQ	4	4 (🌐, PoE)
Codec Plus	2	1 (🌐)
Codec Pro	4	2 (🌐, PoE)
Board	0	0
Board Pro	1	1 (🌐)
Desk	0	0
Desk Mini	0	0
Desk Pro ²	1	0

¹ One or more of the auxiliary ports on this product is reserved for internal use.

² The auxiliary port on this product is a network expansion port. You can connect a computer or other device to this port and get access to the same network/LAN as the video conferencing device itself. This port is not used for peripheral devices, and you don't get a local IP address from the codec.

Mini-jack connector pin-out schemes

3.5 mm mini-jack, 3-pin (*line-out*)

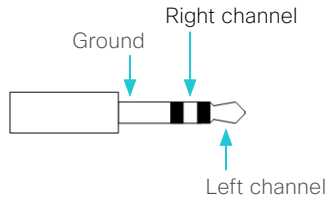

3.5 mm mini-jack, 4-pin (*microphone*)

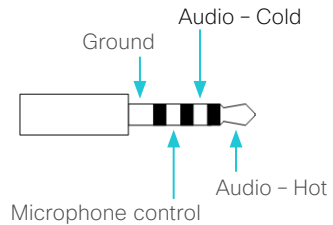

Audio connectors (mini-jack) *

	Microphone	Line-out
Connector pin out	Tip = Hot Ring 1 = Cold Ring 2 = Mic. control Shield = GND	Tip = Left channel Ring = Right channel Shield = GND
Signal type	Balanced	Unbalanced
Connector (codec)	Mini-jack 3.5 mm, 4-conductor	Mini-jack 3.5 mm, 3-conductor
Input impedance	900 Ohm/leg	N/A
Output impedance	N/A	470 Ohm
Maximum input level	-18.3 dBu ±2 dB	N/A
Maximum output level	N/A	8.2 dBu ±2 dB
Phantom power	10V ± 0.5V	N/A
Phantom power resistor pin "tip"	1.0kOhm	N/A
Phantom power resistor pin "ring 1"	1.0kOhm	N/A
Frequency response	20Hz-20kHz ±1 dB	20Hz-20kHz ±1 dB
Signal to Noise Ratio	-95 dB	-100 dB

* *Board and Desk Pro*: These devices have a mini-jack socket only for line-out.
Desk and Desk Mini don't have any mini-jack sockets.
Room Bar has a mini-jack socket only for microphone.

Board

Board Pro

Codec EQ

Codec Plus

Codec Pro

Desk, Desk Pro, DeskMini

Room Bar

Room Kit

Room Kit Mini

Room 55

Room 55 Dual, Room 70

Room 70 G2

Room 70 Panorama

Room Panorama

Audio inputs and outputs (page 1 of 2)

Audio inputs

The audio inputs can be used as both microphone and line inputs, because you can adjust the gain and switch on or off phantom power on each input individually. Use the following settings:

- **Audio > Input > Microphone [n] > Level:** Adjust the gain on the input connector to suit the connected audio source. The gain can be tuned from 0 to 70 dB in steps of 1 dB. The maximum input level with 0 dB gain is 24 dBu.
- **Audio > Input > Microphone [n] > PhantomPower:** In the default configuration, there is phantom power on the input (48V ± 1V). This required for some microphones, such as the Cisco table and ceiling microphones. You can switch off the phantom power when connecting to equipment that don't need it, such as external mixers.



The audio inputs are configured for the use of Euroblock connectors with up to 4 ports.



If you use a Euroblock with 3 ports make sure it is inserted in the leftmost position possible. That is, port 4 (microphone mute) is not used.

Audio outputs



The audio outputs are configured for the use of Euroblock connectors with 3 ports.

Connecting to unbalanced connectors

These illustrations show best practice when connecting the video conferencing device to unbalanced connectors.

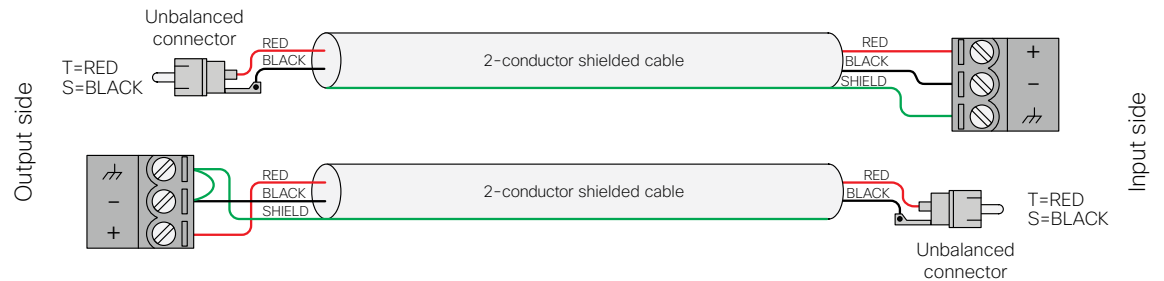

Audio inputs and outputs (page 2 of 2)

Audio input/output specification		
	Microphone/Line Input	Line Output
Connector type	<ul style="list-style-type: none"> Balanced input 3.5 mm pitch Phoenix/Euroblock type male header 	<ul style="list-style-type: none"> Impedance-balanced output 3.5 mm pitch Phoenix/Euroblock type male header
Phantom Power	<ul style="list-style-type: none"> 48V, 6.8 kohm impedance / 7 mA max current per leg. Independently switchable. 	N/A
Input Impedance	<ul style="list-style-type: none"> 2.5 kohm per leg 	N/A
Output Impedance	N/A	<ul style="list-style-type: none"> 200 ohm per leg
Recommended Load Impedance	N/A	<ul style="list-style-type: none"> > 600 ohm
Signal Level	<ul style="list-style-type: none"> 0 dB input gain: 24 dBu max. (1 kHz, +/-1 dB) Input gain independently adjustable from 0 dB to +70 dB in 1 dB steps 	<ul style="list-style-type: none"> 0 dB output gain: 18 dBu max. (1 kHz, +/-1 dB) Output gain independently adjustable from 0 to -24 dB in 1 dB steps
Frequency Response	<ul style="list-style-type: none"> 20 Hz-20 kHz: +0/-1 dB 	<ul style="list-style-type: none"> 20 Hz-20 kHz: +0/-0.5 dB
Total Harmonic Distortion + Noise (THD+N)	<ul style="list-style-type: none"> 0 dB input gain, 22 dBu signal level: < 0.005% (20 Hz-20 kHz, 22 kHz BW) 46 dB input gain, -24 dBu signal level: < 0.01% (20 Hz-20 kHz, 22 kHz BW) 	<ul style="list-style-type: none"> 0 dB output gain, 17 dBu signal level: < 0.005% (20 Hz-20 kHz, 22 kHz BW)
Equivalent Input Noise (EIN)	<ul style="list-style-type: none"> 46 dB input gain, Rs=150 ohm: < -124 dBu (20 Hz-20 kHz A-weighted) 	N/A
Dynamic Range	<ul style="list-style-type: none"> 0 dB input gain, Rs=150 ohm: > 107 dB (20 Hz-20 kHz, 22 kHz BW) 46 dB input gain, Rs=150 ohm: > 102 dB (20 Hz-20 kHz, 22 kHz BW) 	<ul style="list-style-type: none"> 0 dB output gain: > 109 dB (20 Hz-20 kHz un-weighted)
Crosstalk	<ul style="list-style-type: none"> 0 dB input gain, 23 dBu signal level, 10 kHz: < -110 dB 46 dB input gain, -23 dBu signal level, 10 kHz: < -110 dB 	<ul style="list-style-type: none"> 0 dB output gain, 17 dBu signal level 10 kHz: < -100 dB

Board

Board Pro

Codec EQ

Codec Plus

Codec Pro

Desk, Desk Pro, Desk Mini

Room Bar

Room Kit

Room Kit Mini

Room 55

Room 55 Dual, Room 70

Room 70 G2

Room 70 Panorama

Room Panorama

D15503.01

RoomOS 11.1

02-2023



Board

Board
ProCodec
EQCodec
PlusCodec
ProDesk,
Desk Pro,
DeskMiniRoom
Bar

Room Kit

Room Kit
Mini

Room 55

Room
55 Dual,
Room 70Room 70
G2Room 70
PanoramaRoom
Panorama

The GPIO and 3G-SDI connectors

GPIO connector

The device has one 6-pin Euroblock GPIO (General Purpose Input/Output) port with GND, +12V, and 4 GPIO pins.



You can configure the mode for the four GPIO pins individually. A pin can be configured to trigger an action (input) or to report some status of the device (output). For example:

- Mute the microphones (input), or report whether the microphones are muted (output).
- Accept or disconnect a call (input), or report whether the device is in a call (output).

Operating principles

The +12V pin provides +12V_{DC}, and it is capable of sourcing up to 500mA.

The GND pin is a common ground for all pins in the GPIO connector.

When used as input, a GPIO pin detects state as follows:

- Low state for voltages 0-1V_{DC}
- High state for voltages 2-12V_{DC}

When used as output, a GPIO pin is set as follows:

- Low state will drive a pin low, i.e. to GND
- High state will set a pin to open-drain with internal pull-up, i.e. it will set the pin to 12V unless an external connection drives it low

Commands and configurations

To set the mode of a pin:

Read the description of the setting for more details about the pre-defined input and output modes:

- `GPIO > Pin [n] > Mode`
(xConfiguration GPIO Pin [n] Mode)

To retrieve the state of a pin:

- `GPIO > Pin [n] > State`
(xStatus GPIO Pin [n] State)

To set the state of a pin that is in manual mode:

- `xCommand GPIO ManualState Set`

For more information about the API commands, see the API guide for RoomOS software. Go to ► <https://www.cisco.com/go/room-docs>

3G-SDI connector

The Codec Pro has one 3G-SDI input connector.

The connector is HD-BNC, supporting resolutions up to 1080p60. The 3G-SDI signal is Level A, 75 Ω, 10-bit data native color encoding 4:2:2 YCbCr.

Use the 3G-SDI connector if you want to place a camera far away from the codec - for example, in bigger rooms where you want to have a camera in the back.

Since the total coaxial cable length can be up to 100m, it allows extra flexibility when building or setting up a video conferencing room.

Board

Board
ProCodec
EQCodec
PlusCodec
ProDesk,
Desk Pro,
DeskMiniRoom
Bar

Room Kit

Room Kit
Mini

Room 55

Room
55 Dual,
Room 70Room 70
G2Room 70
PanoramaRoom
Panorama

API access using the COM port

The device has a COM port that you can use to access the device's API over a serial connection.*

It is a 3 pin Euroblock, with Tx (transmit), Rx (receive), and GND pins.

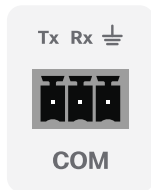

Serial communication is enabled by default. Use the following configuration if you want to disable it:

[SerialPort > Mode](#)

For security reasons, you are asked to sign in before using the serial interface. Use the following setting if you want to switch off the sign in prompt:

[SerialPort > LoginRequired](#)

The device can give very much feedback, so we recommend keeping the connection at the highest baud rate possible. In some situations, such as when using long cables, a lower rate may be used to avoid bit errors. Use the following setting if you want to adjust the baud rate.

[SerialPort > BaudRate](#)

If your device is provisioned by CUCM, the serial port settings should be configured from CUCM.

The parameters for the serial connection are:

- Baud rate: 9600, 19200, 38400, 57600, or 115200 bps
- Data bits: 8
- Parity: None
- Stop bits: 1
- Flow control: None

The same set of configurations and parameters are used for the micro-USB maintenance port, except for the baud rate. The baud rate for the maintenance port is always 115200 bps.

* Don't use the COM port for maintenance; use the micro-USB port instead.

Board

Board
ProCodec
EQCodec
PlusCodec
ProDesk,
Desk Pro,
Desk MiniRoom
Bar

Room Kit

Room Kit
Mini

Room 55

Room 55
Dual,
Room 70Room 70
G2Room 70
PanoramaRoom
Panorama

Serial interface for maintenance (page 1 of 5)

Use the micro USB connector for direct communication with the device¹. You need a micro USB to USB cable. If the computer doesn't auto-install a serial port driver, you need to install a serial port driver on the computer manually².

Use a terminal emulator to connect to the serial interface. For the most common computer types (PC, MAC) and operating systems, PuTTY or Tera Term will work.

Parameters:

- Baud rate: 115200 bps
- Data bits: 8
- Parity: None
- Stop bit: 1
- Hardware flow control: Off

Device settings

Serial communication is enabled by default. Use the following configuration to change the behavior:

[SerialPort > Mode](#)

For security reasons, you are asked to sign in before using the serial interface. Use the following setting to change the behavior:

[SerialPort > LoginRequired](#)

If your device is provisioned by CUCM, the serial port settings should be configured from CUCM.

[Codec Pro](#), [Room 70 G2](#), [Room 70 Panorama](#), and [Room Panorama](#)

- The [SerialPort > BaudRate](#) setting has no effect on the maintenance port. The maintenance port always uses the default baud rate.

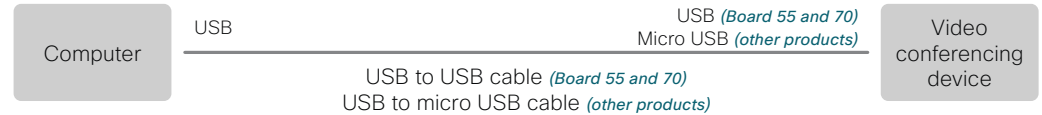

See the illustrations on the following pages to find the micro USB maintenance port the different products.

[Webex Board 55S, 70S, and 85S:](#)

1. Connect a USB cable from a computer to the micro-USB port on the board.
You will see two USB to Serial Port devices on your computer. The names depend on the operating system of the computer. On Linux, you typically see `/dev/ttyUSB0` for the camera and `/dev/ttyUSB1` for main.
These ports are connected to the native serial interface (UART) on the two CPUs. They show everything printed by the system to this port, including logs from bootloaders.
2. Sign in with admin credentials when you get the sign-in prompt after bootup is completed. You can only sign in to the main CPU, not to the camera CPU.
After signing in, you have access to the API of the board.

If your board has been factory reset, the sign-in is *admin* with an empty password.

[Webex Board 55 and 70:](#)

1. Connect a USB cable from your computer to the USB-A port on the board. On Webex Board 55, use the USB port closest to the panel.
2. Power up the board. You will see the virtual serial port on the computer. Its name depends on the operating system of the computer. On Linux, you typically see `/dev/ttyACM0`.
3. Sign in with admin credentials when you get the sign-in prompt. After signing in, you have access to the API of the board.

NOTE: If you power up the board before you connect the computer, the computer can't see the board.
If your board has been factory reset, the sign-in is *admin* with an empty password.

¹ The micro-USB port is for maintenance. If you want to access the device's API over a serial connection, refer to the API guide for details.

² You need a CP210x USB to UART Bridge Virtual COM Port (VCP) driver, see ► <http://www.silabs.com/products/development-tools/software/usb-to-uart-bridge-vcp-drivers>

Board

Board Pro

Codec EQ

Codec Plus

Codec Pro

Desk, Desk Pro, Desk Mini

Room Bar

Room Kit

Room Kit Mini

Room 55

Room 55 Dual, Room 70

Room 70 G2

Room 70 Panorama

Room Panorama

Serial interface for maintenance (page 2 of 5)

Room 55 Dual and Room 70

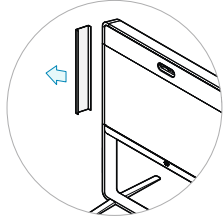

Remove the left side cover of the device to get access to the codec connector panel. The cover snaps to magnets.

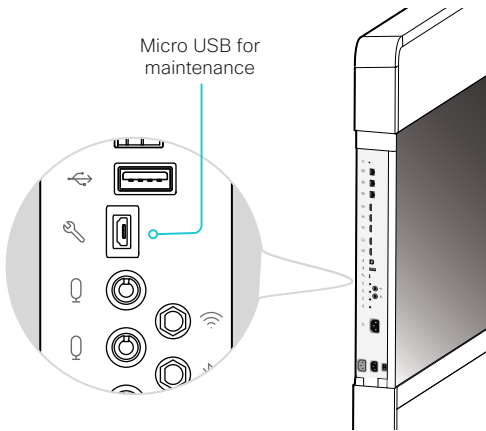

Room 70 G2 and Room 70 Panorama

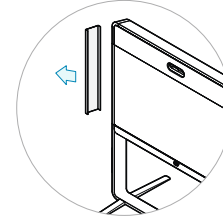

Remove the left side cover of the device to get access to the codec connector panel. The cover snaps to magnets.

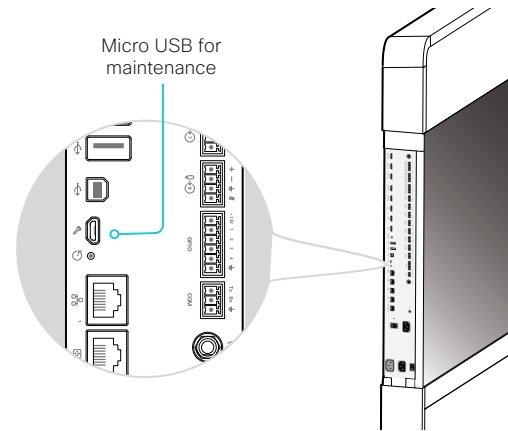

Board

Board Pro

Codec EQ

Codec Plus

Codec Pro

Desk, Desk Pro, Desk Mini

Room Bar

Room Kit

Room Kit Mini

Room 55

Room 55 Dual, Room 70

Room 70 G2

Room 70 Panorama

Room Panorama

Serial interface for maintenance (page 3 of 5)

Codec EQ

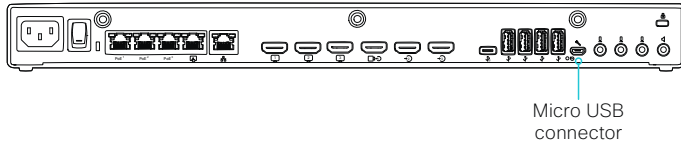

Micro USB connector

Codec Plus



Micro USB connector

Codec Pro and Room Panorama

For Room Panorama:

- Use the handle at the bottom of the deco grille, and pull down the left monitor to get access to the codec.

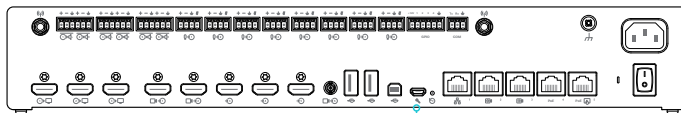

Micro USB connector

Room 55

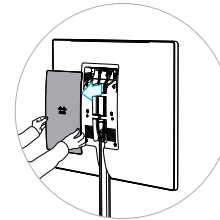

Remove the rear cover to get access to the connector panel.

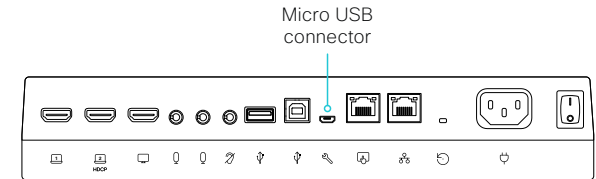

Micro USB connector

Board

Board Pro

Codec EQ

Codec Plus

Codec Pro

Desk, Desk Pro, DeskMini

Room Bar

Room Kit

Room Kit Mini

Room 55

Room 55 Dual, Room 70

Room 70 G2

Room 70 Panorama

Room Panorama

Serial interface for maintenance (page 4 of 5)

Room Bar

Tilt the unit forward to get access to the connector panel.

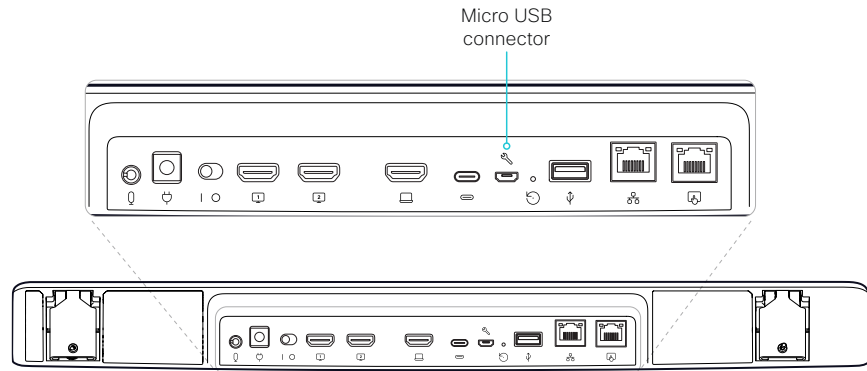

Room Kit

Tilt the unit forward to get access to the connector panel.

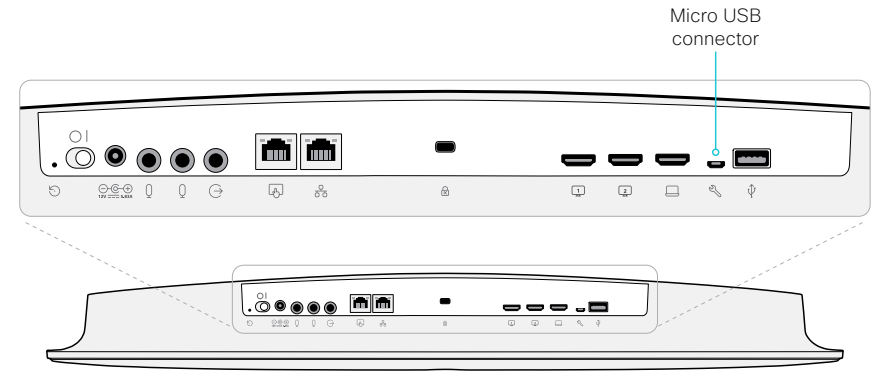

Room Kit Mini

Tilt the unit forward to get access to the connector panel.

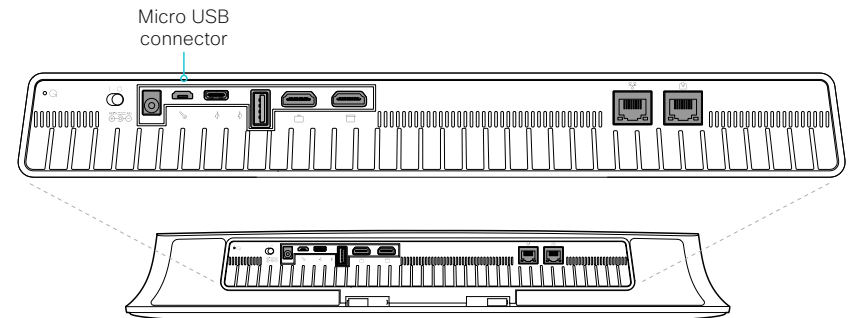

Board

Board Pro

Codec EQ

Codec Plus

Codec Pro

Desk, Desk Pro, Desk Mini

Room Bar

Room Kit

Room Kit Mini

Room 55

Room 55 Dual, Room 70

Room 70 G2

Room 70 Panorama

Room Panorama

Serial interface for maintenance (page 5 of 5)

Desk and Desk Pro

Flip the cover on the back of the device to get access to the connector panel.

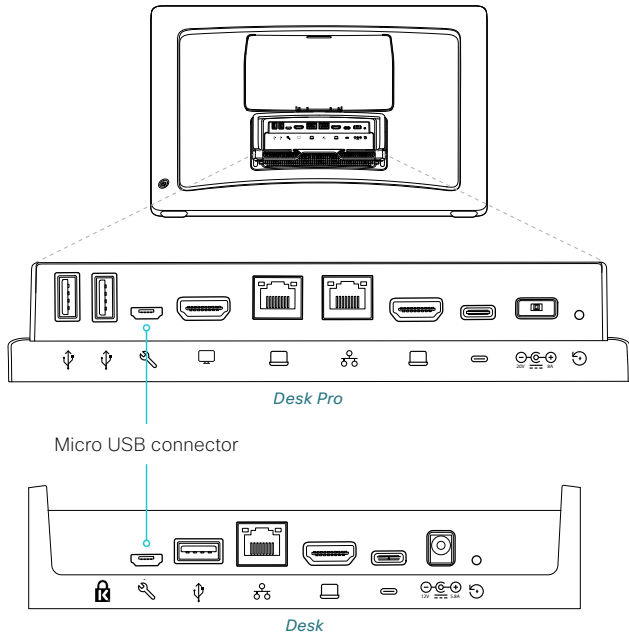

Desk Mini

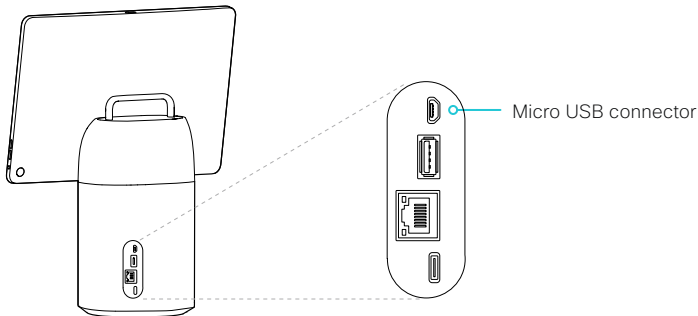

Board

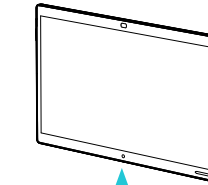

The connector panel is at the bottom

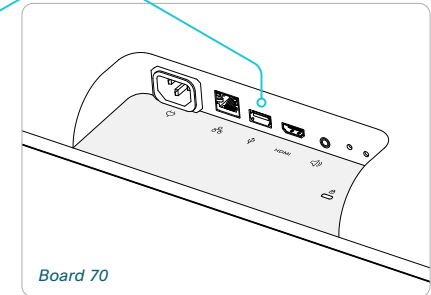
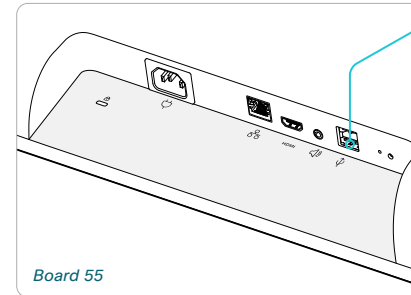
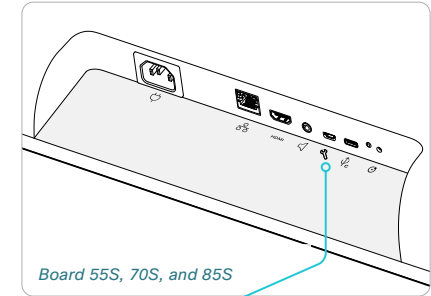

Board Pro

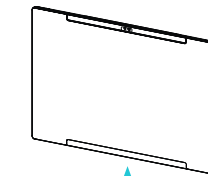

The connector panel is at the bottom

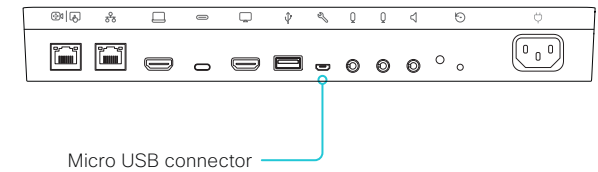

Board

Board
ProCodec
EQCodec
PlusCodec
ProDesk,
Desk Pro,
Desk MiniRoom
Bar

Room Kit

Room Kit
Mini

Room 55

Room 55
Dual,
Room 70Room 70
G2Room 70
PanoramaRoom
Panorama

The systemtools commands

The systemtools commands are used for administrative control of the device and are only available from a command line interface. Systemtools should not be used to program the device.

To get an overview of the supported commands type “systemtools ?”.

Example:

```
systemtools ?
selectsw
whoami
license
network
ntp
ps
securitystatus
bootlogo
idefixversion
touch
```

To see the usage of the commands add a question mark after the command.

Example:

```
systemtools network ?
usage: network ping <hostname> | traceroute
<hostname> | netstat | addr | ifconfig |
ifstats <ifname>
```

systemtools bootlogo

Shows the current bootlogo setting.

systemtools bootlogo off

Disables display of the Cisco boot screen when the video device is booting. The command is persistent over a factory reset.

systemtools bootlogo on

Reverts back to showing the Cisco boot screen when the video device is rebooting. The command is persistent over a factory reset.

systemtools idefixversion (*Board, Codec Plus, Codec Pro, Room Kit, Room Kit Mini, Room 55, Room 55 Dual, Room 70, Room 70 G2, Room 70 Panorama, and Room Panorama*)

Returns the software version a connected Touch 10 should have.

systemtools license list

Lists all the licenses for the device.

systemtools license show <name>

Shows the content of a license file, defined by the name.

<name>: The name of the license file.

systemtools network ping <hostname>

Network debug command.

<hostname>: The IP-address or URL of the host.

systemtools network traceroute <hostname>

Network debug command.

<hostname>: The IP-address or URL of the host.

systemtools network netstat

Network debug command.

systemtools network addr

Shows the device's IP-addresses.

systemtools network ifconfig

Network debug command.

systemtools network ifstats <ifname>

Network debug command. Prints out network interface statistics.

<ifname>: The name of the interface.

systemtools ntp

Shows the NTP status.

systemtools ps

Lists all running processes.

systemtools securitystatus

Shows the security status for the device.

systemtools selectsw [image name]

Select which of the available software images to use. Changing the software image will restart the device.

No argument given: Lists the version of the available software images, and shows which one is active.

image name: Swap to the software with this name.

systemtools touch start (*only for Board, Board Pro, Desk, Desk Mini, and Desk Pro*)

Debug command for testing the touch screen.

systemtools touch stop (*only for Board, Board Pro, Desk, Desk Mini, and Desk Pro*)

Debug command for testing the touch screen.

systemtools touch forever (*only for Board, Board Pro, Desk, Desk Mini, and Desk Pro*)

Debug command for testing the touch screen.

systemtools whoami

Lists the name and id of the signed in user, and the user roles held by this user.

Board

Board
ProCodec
EQCodec
PlusCodec
ProDesk,
Desk Pro,
Desk MiniRoom
Bar

Room Kit

Room Kit
Mini

Room 55

Room 55
Dual,
Room 70Room 70
G2Room 70
PanoramaRoom
Panorama

Open TCP ports

The web server within the codec prohibit or restrict the use of nonsecure or unnecessary ports, protocols, modules, and/or services. Some ports are open by default.

You can configure the device settings from the device web interface. Open a web browser, enter the IP address of the device, and sign in. Go to [Settings](#), and select [Configurations](#).

TCP 22: SSH

You can close the port by setting SSH mode to **Off**.

```
NetworkServices SSH Mode: Off/On
```

TCP 80: HTTP

You can close the port by setting HTTP mode to **Off** or **HTTPS**.

```
NetworkServices HTTP Mode: HTTP+HTTPS/HTTPS/Off
```

TCP 443: HTTPS

You can close the port by setting HTTP mode to **Off**.

```
NetworkServices HTTP Mode: HTTP+HTTPS/HTTPS/Off
```

TCP 4043: Remote pairing software download (*legacy upgrade*)

Applies to all products that support Touch 10

This port is open for backwards compatibility reasons. The port is used for downloading software to the Touch 10 if Touch 10 was paired to the codec on older software that didn't support secure upgrade (TCP 4060) for Touch 10.

You can close the port by setting remote pairing for the touch controller to **Off**.

```
Peripherals Pairing CiscoTouchPanels RemotePairing: Off/On
```

TCP 4045: Remote pairing version information

You can close the port by setting remote pairing for the touch controller to **Off**.

```
Peripherals Pairing CiscoTouchPanels RemotePairing: Off/On
```

TCP 4047: Remote pairing session connection

The port is only available (and open) when a touch controller is remote paired with the video conferencing device. You can close the port by setting remote pairing for the touch controller to **Off**.

```
Peripherals Pairing CiscoTouchPanels RemotePairing: Off/On
```

TCP 4051: Remote pairing port (*Deprecated*)

You can close the port by setting remote pairing for the touch controller to **Off**.

```
Peripherals Pairing CiscoTouchPanels RemotePairing: Off/On
```

TCP 4060: Remote pairing software download (*secure upgrade*)

Applies to all products that support Room Navigator or Touch 10

This port is used when downloading software to a touch controller. You can close the port by setting remote pairing for the touch controller to **Off**.

```
Peripherals Pairing CiscoTouchPanels RemotePairing: Off/On
```

TCP 4062: Remote pairing port

You can close the port by setting remote pairing for the touch controller to **Off**.

```
Peripherals Pairing CiscoTouchPanels RemotePairing: Off/On
```

TCP 4190: UPnP port

You can close the ports by setting the SIP listen ports to **Off**.

```
NetworkServices UPnP Mode: Off
```

TCP 5060/5061: SIP listen ports

The SIP listen ports are open by default. The SIP listen ports are disabled by the Cisco UCM (Unified Communication Manager). You can close the ports by setting the SIP listen ports to **Off**.

```
SIP ListenPort: Off/On
```

TCP 65533: Alternate port for Proximity connections

The port is closed by default. The port is open for Proximity connections when the setting to enable an alternate port for Proximity is set to **True**.

```
Proximity AlternatePort Enabled: False/True
```

Board

Board
Pro

Codec
EQ

Codec
Plus

Codec
Pro

Desk,
Desk Pro,
Desk Mini

Room
Bar

Room Kit

Room Kit
Mini

Room 55

Room 55
Dual,
Room 70

Room 70
G2

Room 70
Panorama

Room
Panorama

Ephemeral IP ports

Ephemeral IP port range: 32768 - 60999

Board

Board
ProCodec
EQCodec
PlusCodec
ProDesk,
Desk Pro,
Desk MiniRoom
Bar

Room Kit

Room Kit
Mini

Room 55

Room 55
Dual,
Room 70Room 70
G2Room 70
PanoramaRoom
Panorama

HTTPFeedback address from TMS

When a device is added to Cisco TelePresence Management Suite (TMS), it is automatically configured to send information (events) back to TMS. The device receives the address, that these events should be sent to, from TMS (HTTPFeedback address). If this address is absent or misconfigured, the device cannot send events to TMS.

Missing response to events

If the device does not receive a response to an event, it will retry sending it to the HTTPFeedback address up to 6 times at increasing intervals.

If the device does not receive a response to any of the retries, the endpoint tries to send a message to the HTTPFeedback address every ten minutes. The HTTPFeedback status will indicate that it has failed, and there is a diagnostic message indicating the type of failure.

While retrying to send messages, there will be a loss of Call Detail Records (CDR) on TMS.

Get a new HTTPFeedback address from TMS

In order to get a new address to send events to, you must restart the device and wait for the next management address push from TMS (scheduled or triggered by the TMS administrator).

Board

Board Pro

Codec EQ

Codec Plus

Codec Pro

Desk, Desk Pro, Desk Mini

Room Bar

Room Kit

Room Kit Mini

Room 55

Room 55 Dual, Room 70

Room 70 G2

Room 70 Panorama

Room Panorama

Link an on-premises registered device to Cisco Webex Edge for Devices

You can use *Webex Edge for Devices* to link your on-premises registered devices to the Webex cloud service. This gives you access to select cloud features, while your registration, device configuration management, calling¹, and media services remain on-premises. You can manage the cloud services and get device diagnostics in Webex Control Hub.

More detailed information

To find more details about how to link a device to Webex Edge for Devices, supported features, prerequisites, and limitations, read the ► [Webex Edge for Devices \(https://help.webex.com/cy2l2z/\)](https://help.webex.com/cy2l2z/) article on Webex Help Center.

Setup

We recommend that you register the device to the on-premises service first; then you link it to the Webex Edge.

Find details in the *Webex Edge for Devices* article referenced to the left.

Features

Find a comprehensive list of features and functionality in the *Webex Edge for Devices* article referenced to the left. Some of them are:

- Online/Offline connection status in Control Hub
- Device diagnostics with the ability to set administrator alerts
- Device historical analytics available directly in Control Hub
- Access to device settings from Control Hub
- Cloud xAPI access
- Real time media metrics when joining Webex calls
- Manage logs from Control Hub
- Hybrid calendar through Control Hub ²
- Webex Assistant (voice-driven virtual assistant)

The *Webex Edge for Devices* article referenced above has an updated list of all available features and limitations.

Prerequisites

Find a comprehensive list of prerequisites and limitations in the *Webex Edge for Devices* article referenced to the left. Some of them are:

- Encrypted version of RoomOS or CE software
- If registered to CUCM: CUCM version 12.5su1, or 11.5.x with the latest device pack
- Control Hub administrator access
- Cisco Webex Device Connector (to set up the link to Webex Edge)
- A cloud services license (Cisco Collaboration Flex Plan)

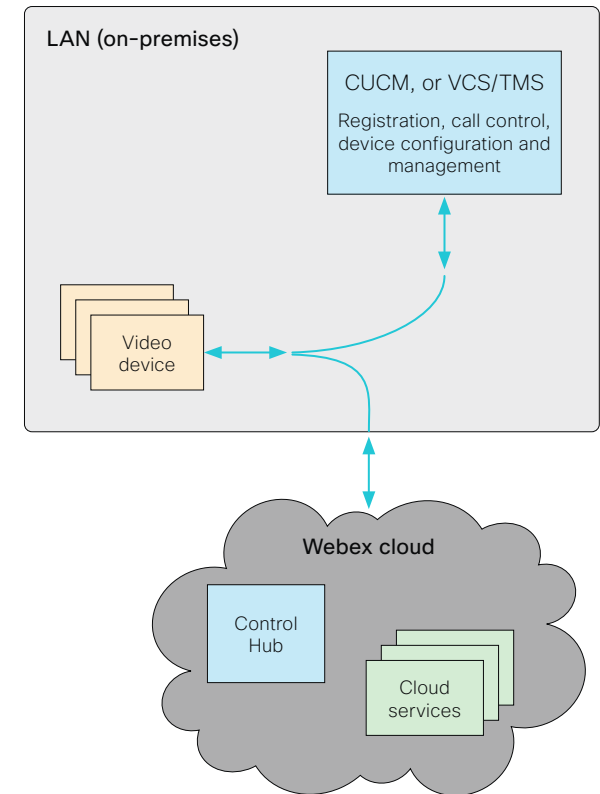

¹ You can configure the device to use the Webex cloud service for calling into Webex meetings. For details, read about *Webex optimized experience for Webex Edge for Devices* in the ► [Webex Edge for Devices \(https://help.webex.com/cy2l2z/\)](https://help.webex.com/cy2l2z/) article on Webex Help Center.

² TMS based bookings will be ignored.

Board

Board
ProCodec
EQCodec
PlusCodec
ProDesk,
Desk Pro,
Desk MiniRoom
Bar

Room Kit

Room Kit
Mini

Room 55

Room 55
Dual,
Room 70Room 70
G2Room 70
PanoramaRoom
Panorama

Register a device to the Cisco Webex cloud service

You can register a device to Cisco Webex remotely from the device web interface instead of using the on-screen setup assistant.

From the web interface, you can only register a device that is not currently registered to a service.

NOTE: All local users and any customizations that have been created for this device will be deactivated.

Create an activation code

To register a device to Cisco Webex, you need an activation code.

Devices in shared mode:

An administrator has to create an activation code on Control Hub.

To learn how to create an activation code for devices in shared mod, see ► [Create a Workspace and Add Services for a Cisco Webex Room Device or a Cisco Webex Board \(https://help.webex.com/1mqb9cb/\)](#).

Devices in personal mode:

From *Cisco Webex Settings* (<https://settings.webex.com>), you can get your activation code without having to be an administrator.

To learn how to create an activation code for devices in personal mode, see ► [Set Up a Webex Board, Room or Desk Device as a Personal Device \(https://help.webex.com/n3alqtv/\)](#).

1. Sign in to the device web interface and go to [Home](#). Find the *Register System* card.

This card is only available if the device is not registered to a service already.

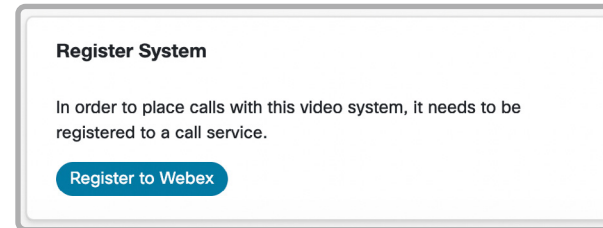

2. Click [Register to Webex](#).
3. A pop-up appears and you can enter the activation code.
Format:
 - xxxx-xxxx-xxxx-xxxx, or
 - xxxxxxxxxxxxxxxxx
4. After registration, you must setup the time zone and language settings from the on-screen setup assistant. If the setup assistant times out, default settings will be applied.

Limitations

Some of the available configurations only apply to on-premises registered devices. They don't apply to Webex registered devices. In the API guide's *Supported Commands Matrix*, these items are marked with "On-prem only".

Among the non-applicable configurations, are those related to H.323, SIP, NTP, CUCM, LDAP, Proximity, and Far End Camera Control.

Board

Board
ProCodec
EQCodec
PlusCodec
ProDesk,
Desk Pro,
Desk MiniRoom
Bar

Room Kit

Room Kit
Mini

Room 55

Room 55
Dual,
Room 70Room 70
G2Room 70
PanoramaRoom
Panorama

Supported RFCs

The RFC (Request for Comments) series contains technical and organizational documents about the Internet, including the technical specifications and policy documents produced by the Internet Engineering Task Force (IETF).

RoomOS software supports a range of RFCs, including the following:

- RFC 2782 - DNS RR for specifying the location of services (DNS SRV)
- RFC 3261 - SIP: Session Initiation Protocol
- RFC 3263 - Locating SIP Servers
- RFC 3361 - DHCP Option for SIP Servers
- RFC 3550 - RTP: A Transport Protocol for Real-Time Applications
- RFC 3711 - The Secure Real-time Transport Protocol (SRTP)
- RFC 4091 - The Alternative Network Address Types (ANAT) Semantics for the Session Description Protocol (SDP) Grouping Framework
- RFC 4092 - Usage of the Session Description Protocol (SDP) Alternative Network Address Types (ANAT) Semantics in the Session Initiation Protocol (SIP)
- RFC 4582 - The Binary Floor Control Protocol
draft-ietf-bfcpbis-rfc4582bis-00 Revision of the Binary Floor Control Protocol (BFCP) for use over an unreliable transport
- RFC 4733 - RTP Payload for DTMF Digits, Telephony Tones and Telephony Signals
- RFC 5245 - Interactive Connectivity Establishment (ICE): A Protocol for Network Address Translator (NAT) Traversal for Offer/Answer Protocols
- RFC 5321 - Simple Mail Transfer Protocol (*Board, Board Pro, Desk, Desk Mini, Desk Pro, and Room Kit Mini*)
- RFC 5589 - SIP Call Control Transfer
- RFC 5766 - Traversal Using Relays around NAT (TURN): Relay Extensions to Session Traversal Utilities for NAT (STUN)
- RFC 5905 - Network Time Protocol Version 4: Protocol and Algorithms Specification

Board

Board
ProCodec
EQCodec
PlusCodec
ProDesk,
Desk Pro,
Desk MiniRoom
Bar

Room Kit

Room Kit
Mini

Room 55

Room 55
Dual,
Room 70Room 70
G2Room 70
PanoramaRoom
Panorama

Calculating minimum bandwidth

The minimum bandwidth requirements are specified in the technical specifications. When dual-stream is used, the available bandwidth is split into two streams.

To calculate the minimum bandwidth for a desired resolution in dual-stream, double the minimum bit rate (bps) for that resolution (e.g., 720p30).

For example, if there is a minimum bandwidth of 768 kbps for the resolution 720p30. Then, the dual-stream minimum bandwidth will be 768×2 , or 1536 kbps.

Board

Board
ProCodec
EQCodec
PlusCodec
ProDesk,
Desk Pro,
Desk MiniRoom
Bar

Room Kit

Room Kit
Mini

Room 55

Room 55
Dual,
Room 70Room 70
G2Room 70
PanoramaRoom
Panorama

User documentation on the Cisco web site

In general, you can find user documentation for all Cisco collaboration devices at ► <https://www.cisco.com/c/en/us/support/collaboration-endpoints>

We recommend you use the following short-links to find documentation for devices running RoomOS software.

Room series:

► <https://www.cisco.com/go/room-docs>

Desk series:

► <https://www.cisco.com/go/desk-docs>

Board series:

► <https://www.cisco.com/go/board-docs>

To find a specific document, click [Documentation](#) and look for the category that the document belongs to.

For example, to find an Administration guide click [Documentation](#) and look for [Maintain and Operate > Maintain and Operate Guides](#).

Categories and document types

These lists show which category a document type belongs to. All types of documents are not available for all types of devices.

Install and Upgrade > Install and Upgrade Guides

- *Installation guides:*
How to assemble and install the device
- *Getting started guide:*
Initial configurations required to get the device up and running for the first time
- *RCSI guide:* Regulatory compliance and safety information

Maintain and Operate > Maintain and Operate Guides

- *Getting started guide:*
Initial configurations required to get the device up and running for the first time
- *Administration guide:*
Information required to configure and administer the device
- *Spare parts overview, Spare parts replacement guides, Cable schemas:* Useful information when connecting cables and replacing spare parts

Maintain and Operate > End-User Guides

- *User guides:*
How to use the device
- *Quick reference guides:*
How to use the device's main features

Reference > Command references

- *API reference guide:*
Reference guide for the device's public API

Reference > Technical References

- *CAD drawings:*
2D CAD drawings of the device, with dimensions

Configuration > Configuration Guides

- *Customization guide:*
How to customize the user interface, how to use the device's API to program in-room controls, making macros, configure advanced audio setups using the Audio Console, and other customizations.

Release and Compatibility > Release Notes

- *Software release notes*

Board

Board
ProCodec
EQCodec
PlusCodec
ProDesk,
Desk Pro,
Desk MiniRoom
Bar

Room Kit

Room Kit
Mini

Room 55

Room 55
Dual,
Room 70Room 70
G2Room 70
PanoramaRoom
Panorama

Cisco contacts

On our web site you will find an overview of the worldwide Cisco contacts.

Go to: ► <https://www.cisco.com/go/offices>

Corporate Headquarters
Cisco Systems, Inc.
170 West Tasman Dr.
San Jose, CA 95134 USA

Intellectual property rights

THE SPECIFICATIONS AND INFORMATION REGARDING THE PRODUCTS IN THIS MANUAL ARE SUBJECT TO CHANGE WITHOUT NOTICE. ALL STATEMENTS, INFORMATION, AND RECOMMENDATIONS IN THIS MANUAL ARE BELIEVED TO BE ACCURATE BUT ARE PRESENTED WITHOUT WARRANTY OF ANY KIND, EXPRESS OR IMPLIED. USERS MUST TAKE FULL RESPONSIBILITY FOR THEIR APPLICATION OF ANY PRODUCTS.

THE SOFTWARE LICENSE AND LIMITED WARRANTY FOR THE ACCOMPANYING PRODUCT ARE SET FORTH IN THE INFORMATION PACKET THAT SHIPPED WITH THE PRODUCT AND ARE INCORPORATED HEREIN BY THIS REFERENCE. IF YOU ARE UNABLE TO LOCATE THE SOFTWARE LICENSE OR LIMITED WARRANTY, CONTACT YOUR CISCO REPRESENTATIVE FOR A COPY.

The Cisco implementation of TCP header compression is an adaptation of a program developed by the University of California, Berkeley (UCB) as part of UCB's public domain version of the UNIX operating system. All rights reserved. Copyright © 1981, Regents of the University of California.

NOTWITHSTANDING ANY OTHER WARRANTY HEREIN, ALL DOCUMENT FILES AND SOFTWARE OF THESE SUPPLIERS ARE PROVIDED "AS IS" WITH ALL FAULTS. CISCO AND THE ABOVE-NAMED SUPPLIERS DISCLAIM ALL WARRANTIES, EXPRESSED OR IMPLIED, INCLUDING, WITHOUT LIMITATION, THOSE OF MERCHANTABILITY, FITNESS FOR A PARTICULAR PURPOSE AND NONINFRINGEMENT OR ARISING FROM A COURSE OF DEALING, USAGE, OR TRADE PRACTICE.

IN NO EVENT SHALL CISCO OR ITS SUPPLIERS BE LIABLE FOR ANY INDIRECT, SPECIAL, CONSEQUENTIAL, OR INCIDENTAL DAMAGES, INCLUDING, WITHOUT LIMITATION, LOST PROFITS OR LOSS OR DAMAGE TO DATA ARISING OUT OF THE USE OR INABILITY TO USE THIS MANUAL, EVEN IF CISCO OR ITS SUPPLIERS HAVE BEEN ADVISED OF THE POSSIBILITY OF SUCH DAMAGES.

Any Internet Protocol (IP) addresses and phone numbers used in this document are not intended to be actual addresses and phone numbers. Any examples, command display output, network topology diagrams, and other figures included in the document are shown for illustrative purposes only. Any use of actual IP addresses or phone numbers in illustrative content is unintentional and coincidental.

All printed copies and duplicate soft copies are considered un-Controlled copies and the original on-line version should be referred to for latest version.

Cisco has more than 200 offices worldwide. Addresses, phone numbers, and fax numbers are listed on the Cisco website at www.cisco.com/go/offices.

Cisco and the Cisco logo are trademarks or registered trademarks of Cisco and/or its affiliates in the U.S. and other countries. To view a list of Cisco trademarks, go to this URL: www.cisco.com/go/trademarks. Third-party trademarks mentioned are the property of their respective owners. The use of the word partner does not imply a partnership relationship between Cisco and any other company. (1110R)

Cisco product security overview

This product contains cryptographic features and is subject to United States and local country laws governing import, export, transfer, and use. Delivery of Cisco cryptographic products does not imply third-party authority to import, export, distribute, or use encryption. Importers, exporters, distributors, and users are responsible for compliance with U.S. and local country laws. By using this product you agree to comply with applicable laws and regulations. If you are unable to comply with U.S. and local laws, return this product immediately.

Further information regarding U.S. export regulations may be found at <http://www.bis.doc.gov/policiesandregulations/ear/index.htm>.